



# EMC Test Report

**Product Name: Smart Phone**

**Model Number: ANE-LX2J, HWV32**

**Report No: SYBH(Z-EMC) 20180206036002-2**

**FCC ID: QISANE-LX2J**

**Reliability Laboratory of Huawei Technologies Co., Ltd.**

**(Global Compliance and Testing Center of Huawei Technologies Co., Ltd)**

Administration Building, Headquarters of Chang Lina Technologies Co., Ltd., Bantian, Longgang District, Shenzhen, 518129, P.R.C

Tel: +86 755 28780808 Fax: +86 755 89652518

## Notice

1. The laboratory has obtained the accreditation of China National Accreditation Service for Conformity Assessment (CNAS), and accreditation number: L0310.
2. The laboratory has passed the accreditation by The American Association for Laboratory Accreditation (A2LA). The accreditation number is 2174.01
3. The laboratory has been listed by Industry Canada to perform electromagnetic emission measurements. The recognition numbers of test site are 6369A-1.
4. The laboratory (Reliability Lab of Huawei Technologies Co., Ltd) is also named as “Global Compliance and Testing Center of Huawei Technologies Co., Ltd”, the both names have coexisted since 2009.
5. The laboratory has been recognized by the US Federal Communications Commission (FCC) to perform compliance testing subject to the Commission's Declaration Of Conformity (DOC) and Certification rules. The Designation Number is CN1173, and the Test Firm Registration Number is 294140.”
6. The test report is invalid if not marked with the stamps or the signatures of the persons responsible for performing, revising and approving the test report.
7. The test report is invalid if there is any evidence of erasure and/or falsification.
8. If there is any dissidence for the test report, please file objection to the test centre within 15 days from the date of receiving the test report.
9. Normally, the test report is only responsible for the samples that have undergone the test.
10. Context of the test report cannot be used partially or in full for publicity and/or promotional purposes without previous written approval of the laboratory.



**Applicant:** Huawei Technologies Co., Ltd.  
**Address:** Administration Building, Headquarters of Huawei Technologies Co., Ltd., Bantian, Longgang District, Shenzhen, 518129, P.R.C

**Date of Receipt Test Item:** 2018-03-01  
**Start Date of Test:** 2018-03-02  
**End Date of Test:** 2018-03-14

**Test Result:** Pass

**Approved By  
(Lab Manager)**

2018-03-18  
Date

Roger Zhang  
Name

*Roger Zhang*

Signature

**Prepared by  
(Test Engineer)**

2018-03-16  
Date

HuaMei  
Name

*Hua Mei*

Signature



---

---

**Modification Record**

No.	Last Report No.	Modification Description
1	NA	First Report.















## TABLE OF CONTENT

1	General Information.....	6
1.1	EUT Description .....	6
1.2	Test Site Information.....	8
1.3	Applied Standards.....	8
2	Summary of Results .....	9
3	System Configuration during EMC Test .....	10
3.1	Test Mode .....	10
3.2	Test System Configuration .....	11
3.3	Cables Used during Test.....	13
3.4	Associated Equipment Used during Test .....	13
4	Electromagnetic Interference (EMI) .....	14
4.1	Radiated Disturbance 30MHz to 18GHz.....	14
4.2	Conducted Disturbance 0.15 MHz to 30MHz.....	16
5	Main Test Instruments .....	17
6	System Measurement Uncertainty .....	17
7	Test Data and Graph.....	18
7.1	Radiated Disturbance.....	18
7.2	Conducted Disturbance.....	21

## 1 General Information

### 1.1 EUT Description

EUT Description	
Product Name	Smart Phone
Model Number	ANE-LX2J, HWV32
Input voltage	3.8V
TX Frequency	GSM 850:824MHz to 849MHz PCS 1900:1850MHz to 1910MHz WCDMA Band II: 1850MHz to 1910MHz WCDMA Band V: 824MHz to 849MHz LTE BAND 5: 824MHz to 849MHz LTE BAND 7:2500MHz to 2570MHz LTE BAND 26:814MHz to 849MHz LTE BAND 41:2496MHz to 2690MHz WIFI/Bluetooth: 2400MHz to 2483.5MHz 5GWIFI: 5150MHz to 5250MHz 5250MHz to 5350MHz 5470MHz to 5725MHz
RX Frequency	GSM 850:869MHz to 894MHz PCS 1900:1930MHz to 1990MHz WCDMA Band II: 1930MHz to 1990MHz WCDMA Band V: 869MHz to 894MHz LTE BAND 5: 869MHz to 894MHz LTE BAND 7:2500MHz to 2570MHz LTE BAND 26:859MHz to 894MHz LTE BAND 41:2496MHz to 2690MHz WIFI/Bluetooth: 2400MHz to 2483.5MHz 5GWIFI:5150MHz to 5250MHz 5250MHz to 5350MHz 5470MHz to 5725MHz FM: 87.5 MHz to 108MHz GPS: 1575.42MHz
S/N	SCV7N18109000009
HW Version	HL3ANNEM
SW Version	ANE-LX2J 8.0.0.46(C900)
EUT Accessory	
Data cable(04071528)	Data Cable USB A Male to Type C ,Shield Manufacturer: Ningbo Broad Telecommunication Co., Ltd LUXSHARE Precision Industry Co., Ltd HUIZHOU DEHONG TECHNOLOGY CO.,LTD.
Data cable(04071121)	Data Cable USB A Male to Type C,Shield Manufacturer: HONGFUJIN PRECISION INDUSTRIAL(SHENZHEN).LTD LUXSHARE Precision Industry Co., Ltd HUIZHOU DEHONG TECHNOLOGY CO.,LTD. Dongguan Fuqiang Electronics Co.,Ltd

Adapter	<p>Manufacturer:Huawei Technologies Co.,Ltd.          Model: HW-059200UHQ          Input voltage: 100-240V 50/60Hz ,0.5A          Output Voltage: 5V  2A OR 9V  2A          Rated Power: 10W OR 18W          SN: B76596HB502880; K76547HB107086</p>
Adapter	<p>Manufacturer:Huawei Technologies Co.,Ltd.          Model: HW-059200AHQ          Input voltage: 100-240V 50/60Hz ,0.5A          Output Voltage: 5V  2A OR 9V  2A          Rated Power: 10W OR 18W          SN: B68579GIA20748; K68547G2D01247</p>
Adapter	<p>Manufacturer:Huawei Technologies Co.,Ltd.          Model: HW-059200JHQ          Input voltage: 100-240V 50/60Hz ,0.5A          Output Voltage: 5V  2A OR 9V  2A          Rated Power: 10W OR 18W          SN: B73098H9S21161; K73045H9J02473</p>
Adapter	<p>Manufacturer:Huawei Technologies Co.,Ltd.          Model: HW-090200JH0          Input voltage: 100-240V 50/60Hz ,0.5A          Output Voltage: 5V  2A OR 9V  2A          Rated Power: 10W OR 18W          SN: H9911RJ3300017;K99101J3100025</p>
Adapter	<p>Manufacturer:Huawei Technologies Co.,Ltd.          Model: HW-090200AH0          Input voltage: 100-240V 50/60Hz ,0.5A          Output Voltage: 5V  2A OR 9V  2A          Rated Power: 10W OR 18W          SN: K99214J1A00018</p>
Adapter	<p>Manufacturer:Huawei Technologies Co.,Ltd.          Model: HW-090200UH0          Input voltage: 100-240V 50/60Hz ,0.5A          Output Voltage: 5V  2A OR 9V  2A          Rated Power: 10W OR 18W          SN: H9921RJ1N00049;K99214J1A00018</p>
Rechargeable Li-ion	<p>Manufacturer:Huawei Technologies Co.,Ltd.          Battery Model: HB366481ECW          Rated capacity: 2900mAh          Nominal Voltage:  +3.82V          Charging Voltage:  +4.40V          SN: 2157LYHB05X02AE1; 2157ACH924G3BBEF;          2157AIH920X03DD8</p>
Earphone(22040300)	<p>Manufacturer:          Jiangxi Lianchuang Hongsheng Electronic Co. ,LTD          GoerTek Inc.          FOXCONN INTERCONNECT TECHNOLOGY LIMITED          Boluo County Quancheng Electronic Co.,Ltd</p>

Remark: The above EUT's information is declared by manufacturer. Please refer to the specifications or user's manual for more detailed information.



## 1.2 Test Site Information

Test Site 1:	RELIABILITY LABORATORY OF HUAWEI TECHNOLOGIES CO., LTD.
Test Site Location:	Administration Building, Headquarters of Huawei Technologies Co., Ltd., Bantian, Longgang District, Shenzhen, 518129, P.R.C

## 1.3 Applied Standards

### APPLIED STANDARD

47 CFR FCC Part 15:2017, Subpart B



## 2 Summary of Results

Summary of Results				
Test Items	Test Mode	Performance Class & Required Performance Criteria	Result	Site
<u>Radiated Emissions</u> Enclosure Port	Mode 2~ Mode 5	CLASS B	Pass	Site1
<u>Conducted Emissions</u> <input type="checkbox"/> DC Power Port <input checked="" type="checkbox"/> AC Power Port <input type="checkbox"/> Telecommunication Ports	Mode 1~ Mode 5	CLASS B	Pass	Site1
Note: 1, Measurement taken is within the uncertainty of test system. 2, <input checked="" type="checkbox"/> The item has been tested; <input type="checkbox"/> The item has not been tested.				

During the measurement, the environmental conditions complied with the range listed as below.

Item	Required
Ambient temperature	15°C ~ 35°C
Relative humidity	25% ~ 75%
Atmospheric pressure	86kPa ~ 106kPa

### 3 System Configuration during EMC Test

#### 3.1 Test Mode

The EUT was configured, installed, arranged and operated in a manner consistent with typical application. The following mode(s) were applied during the compliance test.

Test Mode	
Mode 1:	Charging +traffic +WIFI+BT+GPS On +Earphone
Mode 2:	Charging +Camera On +Earphone +idle
Mode 3:	Charging +Video Playing +Earphone +idle
Mode 4:	Charging +FM +Earphone +idle
Mode 5:	USB Copy(EUT with PC) +Earphone

Remark:

- 1) If there is one kind of accessories with different models, each one should be applied throughout the compliance test respectively, however, only the worst case will be recorded in this report.
- 2) If EUT has more than one typical operation, only the worst test mode will be recorded in this report.

Traffic Mode:

When the EUT state is switched on and with Radio Resource Control (RRC) connection established.

Idle Mode:

When the EUT state is switched on but without Radio Resource Control (RRC) connection.

Worst Case:

- 1) Radiated Emission

Adapter (Mode 3: HW-090200UH0, SN: K99214J1A00018) +Charging +Vedio Playing +Earphone +idle the result is the worst (30MHz~1GHz).

Adapter (Mode 2: HW-059200JHQ, SN: B73098H9S21161) +Charging +Camera On +Earphone +idle the result is the worst (1GHz~40GHz).

- 2) Conducted Emission

Adapter (Mode 1: HW-059200AHQ, SN: K68547G2D01247) + Charging +traffic +WIFI+BT+GPS On +Earphone the result is the worst.

### 3.2 Test System Configuration

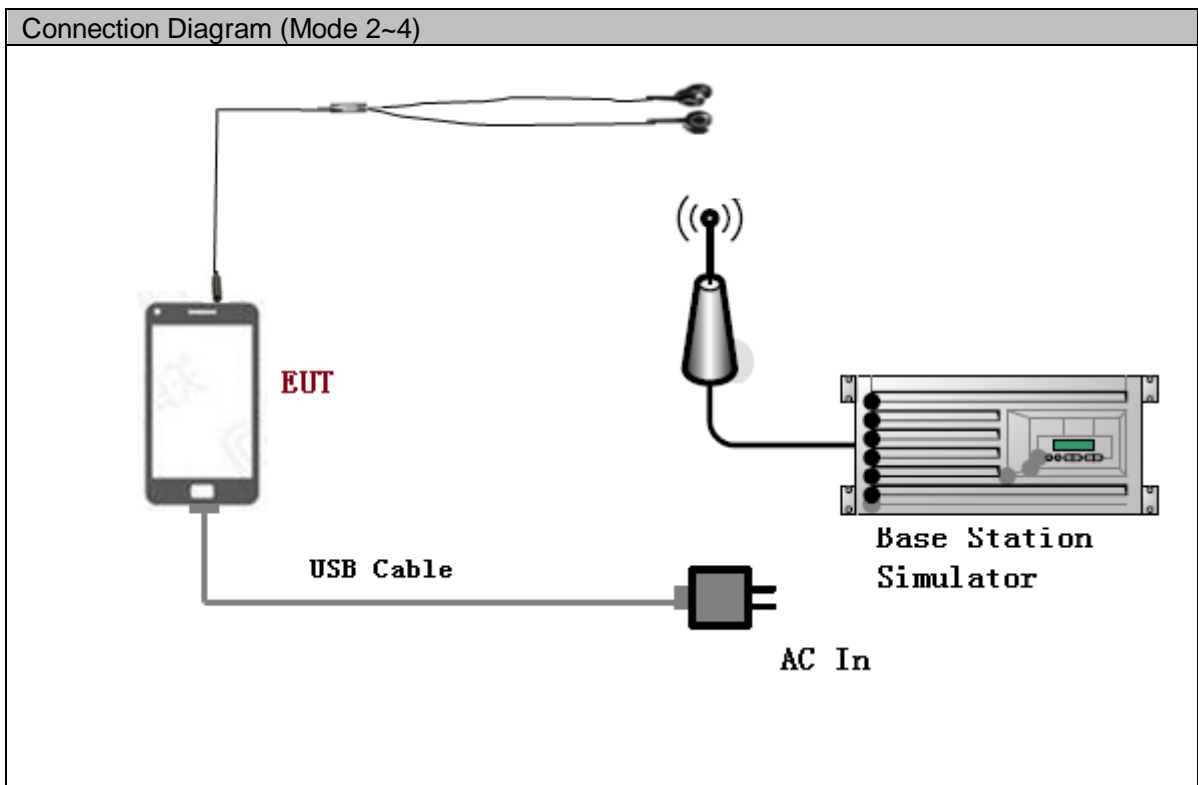
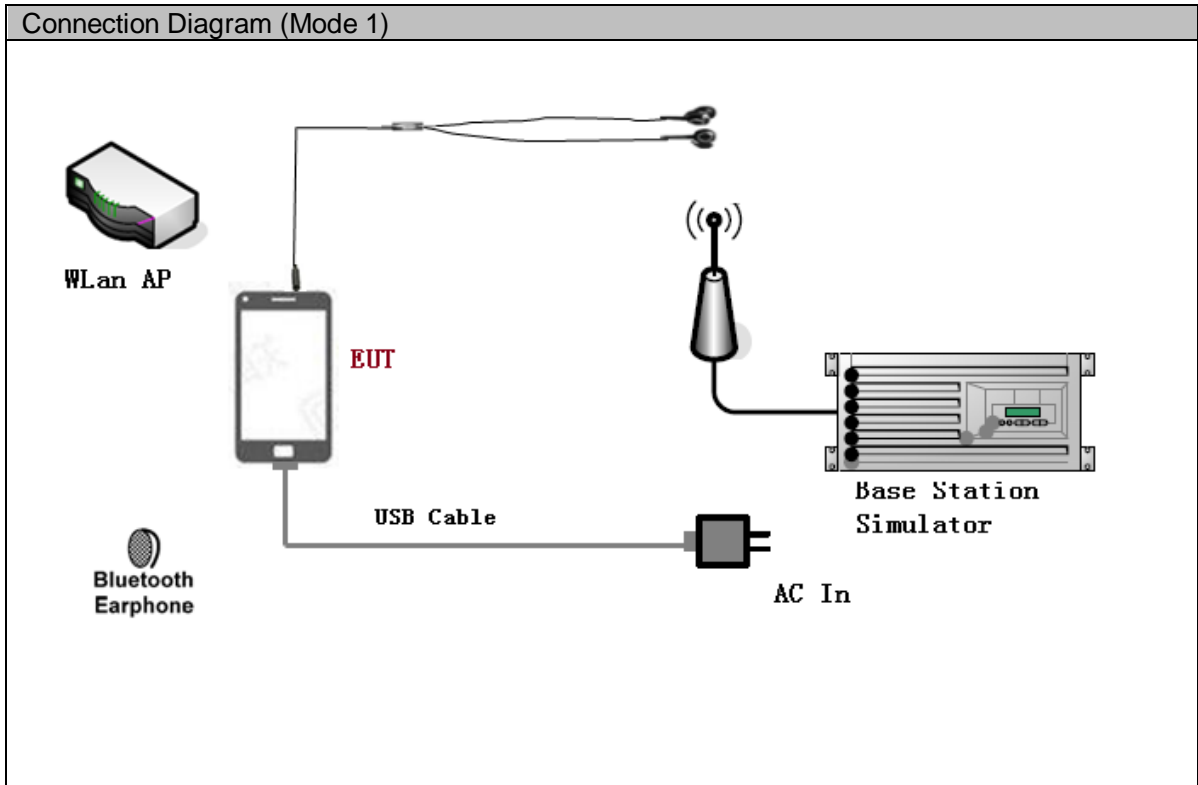

Connection Diagram (Mode 5)

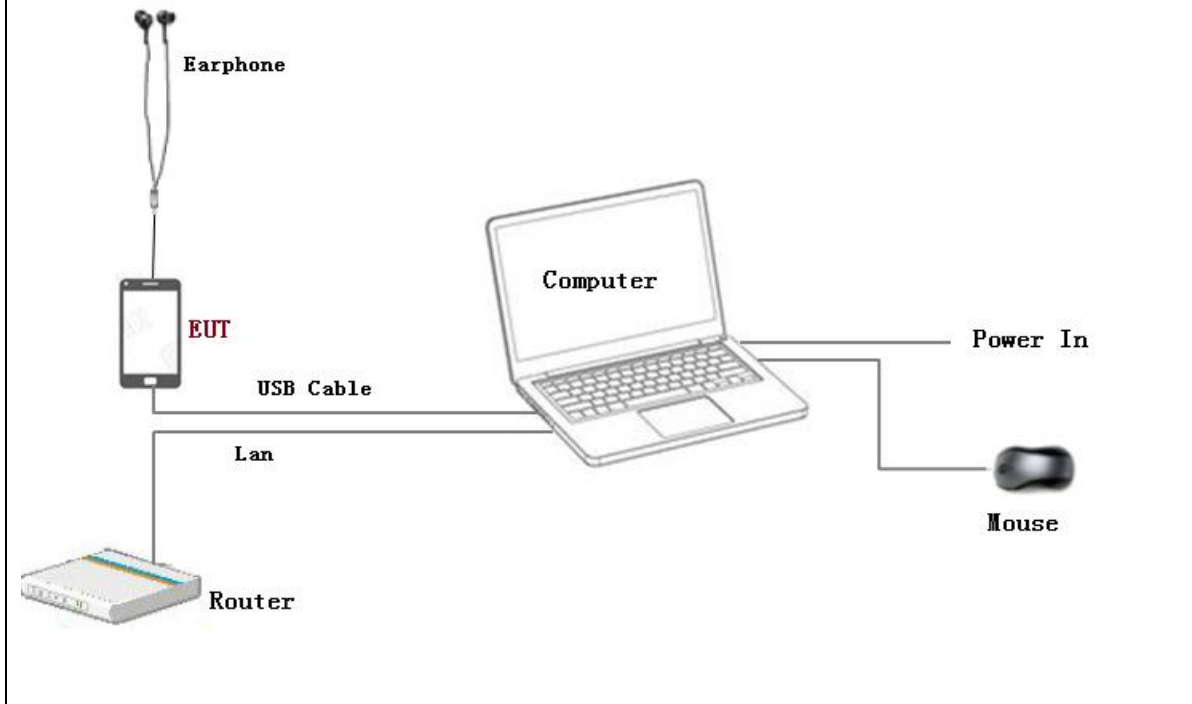

### 3.3 Cables Used during Test

Cable	Quantity	Length	Type of Cable
USB	1	<3m	Shielded
Earphone	1	<3m	Unshielded

### 3.4 Associated Equipment Used during Test

Name	Model	Manufacturer	S/N	Calibrated Deadline	Cal interval
Radio Communication Tester	CMU200	R&S	3608082535	2018-04-01	12
Radio Communication Tester	MT8820C	Anritsu	A110518805	2018-05-15	12
Notebook	S3	ThinkPad	A140714638	/	/
Mouse	M-U0025-O	Lenovo	HS423HB22TB	/	/

## 4 Electromagnetic Interference (EMI)

### 4.1 Radiated Disturbance 30MHz to 18GHz

#### 4.1.1 Test Procedure

The test site semi-anechoic chamber has met the requirement of NSA tolerance 4dB according to the standards: ANCI C63.4: 2014. The test distance was 3m. The set-up and test methods were according to ANCI C63.4: 2014.

A preliminary scan and a final scan of the emissions were made from 30 MHz to 40 GHz by using test script of software; The emissions were measured using Quasi-Peak Detector (30MHz~1GHz) and AV/PK detector (above 1GHz). The maximal emission value was acquired by adjusting the antenna height, polarisation and turntable azimuth in accordance with the software setup. Normally, the height range of antenna was 1m to 4m. The azimuth range of turntable was 0° to 360°. The receiving antenna has two polarizations V and H.

Measurement bandwidth (RBW) for 30MHz to 1000 MHz: 120 kHz;

Measurement bandwidth (RBW) for 1000MHz to 40000 MHz: 1MHz;

EUT was configured in idle mode and the test performed at worst emission state.

#### 4.1.2 Test setup

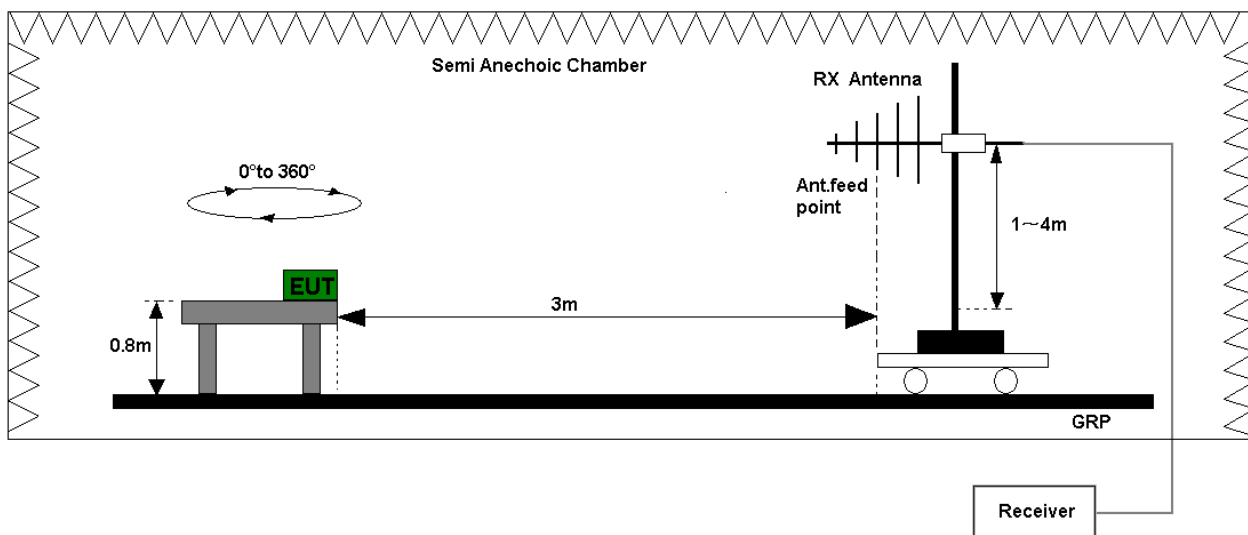

Figure 1. Test set-up of radiated disturbance(30MHz-1GHz)

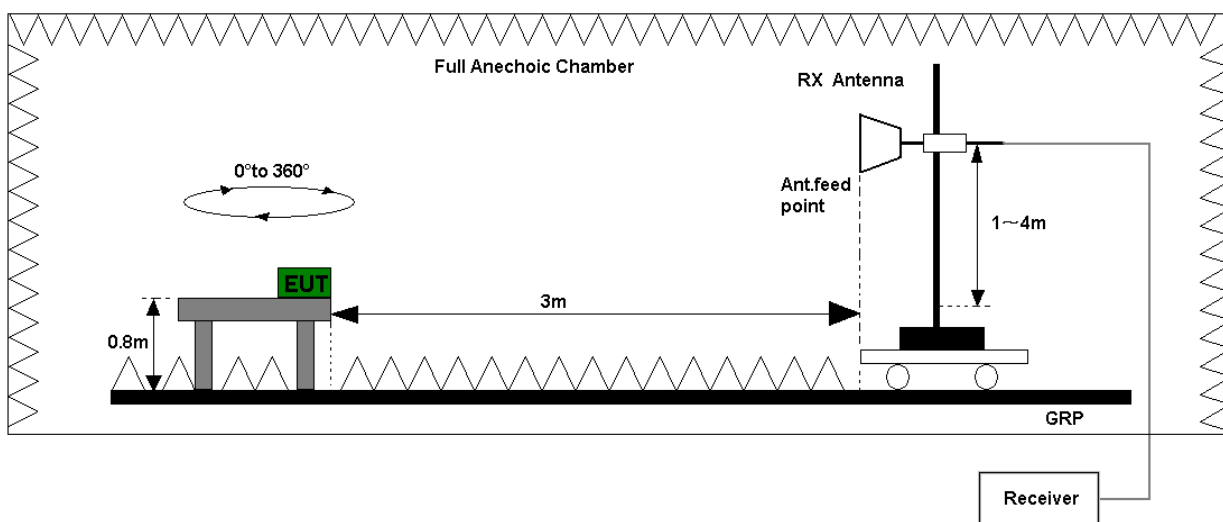

Figure 2. Test set-up of radiated disturbance(above 1GHz)

### 4.1.3 Test Results

The EUT has met the requirements for Radiated Emission of enclosure port.  
Refer to the section 7.1.1 of this report for test data.

Test Limits (Class B)				
Frequency of Emission (MHz)	Radiated Limit			
	Unit( $\mu$ V/m)		Unit(dB $\mu$ V/m)	
30-88	100		40	
88-216	150		43.5	
216-960	200		46	
Above 960	500		54	
Above 1000	AV	PK	AV	PK
	500	5000	54	74

## 4.2 Conducted Disturbance 0.15 MHz to 30MHz

### 4.2.1 Test Procedure

The Table-top EUT was placed upon a non-metallic table 0.8 m above the horizontal metal reference ground plane. EUT was connected to LISN and LISN was connected to reference Ground Plane. EUT was 80cm away from LISN. The set-up and test methods were according to ANCI C63.4: 2014 Conducted Disturbance at AC Port measurements were undertaken on the L and N Lines. The emissions were measured using a Quasi-Peak Detector and Average Detector.

EUT was communicated with the simulator through Air interface, the simulator controls the EUT to transmitter the maximum power which defined in specification of product. The EUT operated on the typical channel.

Measurement bandwidth (RBW) for 150 kHz to 30 MHz: 9 kHz;

The EUT was set in the shielded chamber and operated under nominal conditions.

### 4.2.2 Test Setup

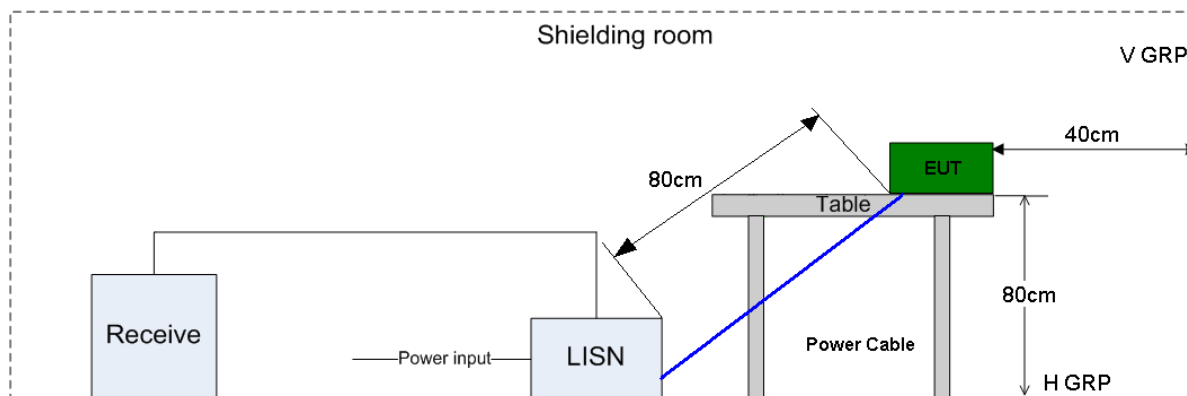

Figure 3. Test Set-up of conducted disturbance

### 4.2.3 Test Results

The EUT has met requirements for Conducted disturbance of power lines. Refer to the section 7.2.1 of this report for test data.

Test Limit of AC Power Port		
Frequency range	150kHz ~ 30MHz	
Frequency	Voltage limits	
	QP (dBμV)	AV (dBμV)
0.15MHz~0.5MHz	66-56	56-46
0.5MHz-5MHz	56	46
5MHz~30MHz	60	50



## 5 Main Test Instruments

Main Test Equipments						
Test item	Test Instrument	Model	S/N	Manufacturer	Calibrated Deadline	Cal interval
RE	EMI Test receiver	ESU26	100150	R&S	Jun. 28, 2019	12
	Spectrum Analyzer	FSU43	100048	R&S	Jun. 29, 2019	12
	Broadband Antenna	VULB 9163	9163-491	SCHWARZBECK	Mar. 28, 2019	24
	Horn Antenna	HF906	100683	R&S	Mar. 28, 2019	24
	Horn antenna (18 to 26.5G)	3160-09	5140299	ETS	Jul. 20, 2019	24
	Horn antenna (26.5 to 40G)	3160-10	00205695	ETS	Jul. 20, 2019	24
	Amplifier	SCU26	10021	R&S	May. 16, 2018	12
CE	EMI Test receiver	ESU26	100150	R&S	May. 15, 2018	12
	Artificial Mains Network	ENV4200	100134	R&S	May. 15, 2018	12
	Artificial Mains Network	ENV216	100382	R&S	May. 15, 2018	12
Software Information						
Test Item	Software Name	Manufacturer		Version		
RE	EMC32	R&S		V9.25.0		
CE	EMC32	R&S		V9.25.0		

## 6 System Measurement Uncertainty

For a 95% confidence level, the measurement expanded uncertainties for defined systems, in accordance with the recommendations of ISO 17025 were:

System Measurement Uncertainty		
Items	Extended Uncertainty	
RE(30MHz-1GHz)	Field strength (dB $\mu$ V/m)	U=4.1dB; k=2
RE(1GHz-18GHz)	Field strength (dB $\mu$ V/m)	U=5.1dB; k=2
RE(18 GHz-26.5GHz)	Field strength (dB $\mu$ V/m)	U=4.82dB; k=2
RE (26.5 GHz- 40GHz)	Field strength (dB $\mu$ V/m)	U=5.22dB; k=2
CE	Disturbance Voltage (dB $\mu$ V)	U=2.5dB; k=2

## 7 Test Data and Graph

Only the worst test results were shown

### 7.1 Radiated Disturbance

#### 7.1.1 30MHz~1GHz

Test Mode 3: Charging + Vedio Playing +Earphone +idle

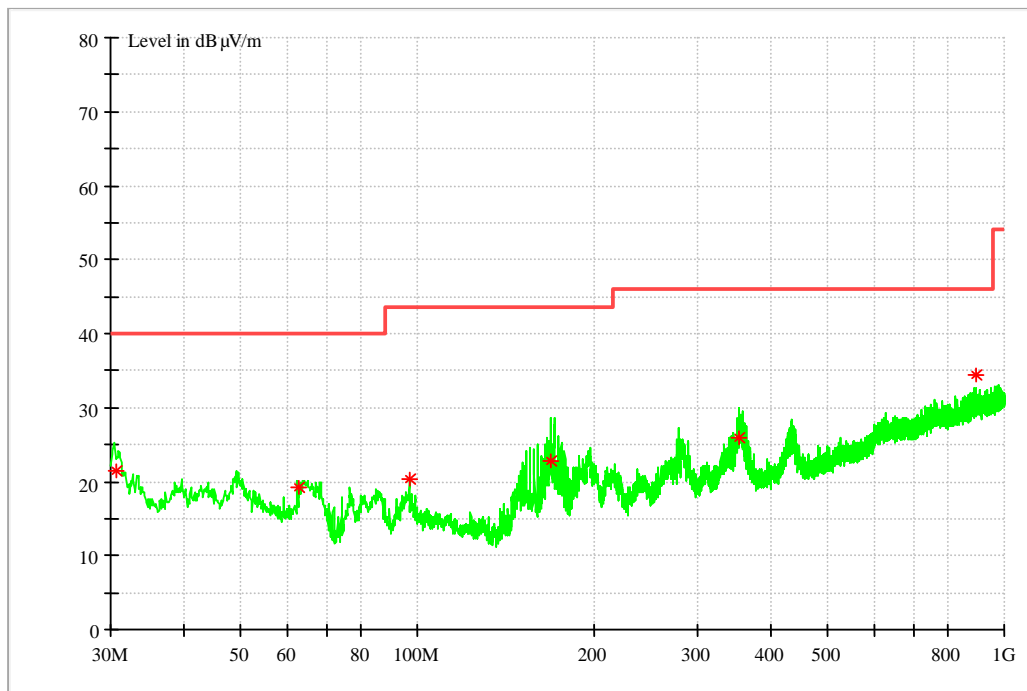

#### MEASUREMENT RESULT: QP Detector

Frequency MHz	Level dBµV/m	Transd dB	Limit dBµV/m	Margin dB	Height cm	Azimuth deg	Polarisation
30.661253	21.38	13.9	40	18.62	129	280	V
62.9388	19.17	12.4	40	20.83	130	152	V
96.86025	20.39	13.3	43.5	23.11	137	54	V
168.82035	22.73	11.1	43.5	20.77	132	268	V
352.94285	25.92	17.4	46	20.08	100	290	H
897.114	34.47	26.3	46	11.53	154	241	V

Note:

Level =Reading level by receiver + Transd (Antenna factor + cable loss – preamplifier gain)  
 The reading level is calculated by software which is not shown in the sheet.

### 7.1.2 1GHz~18GHz

Test Mode 2: Charging +Camera On +Earphone +idle

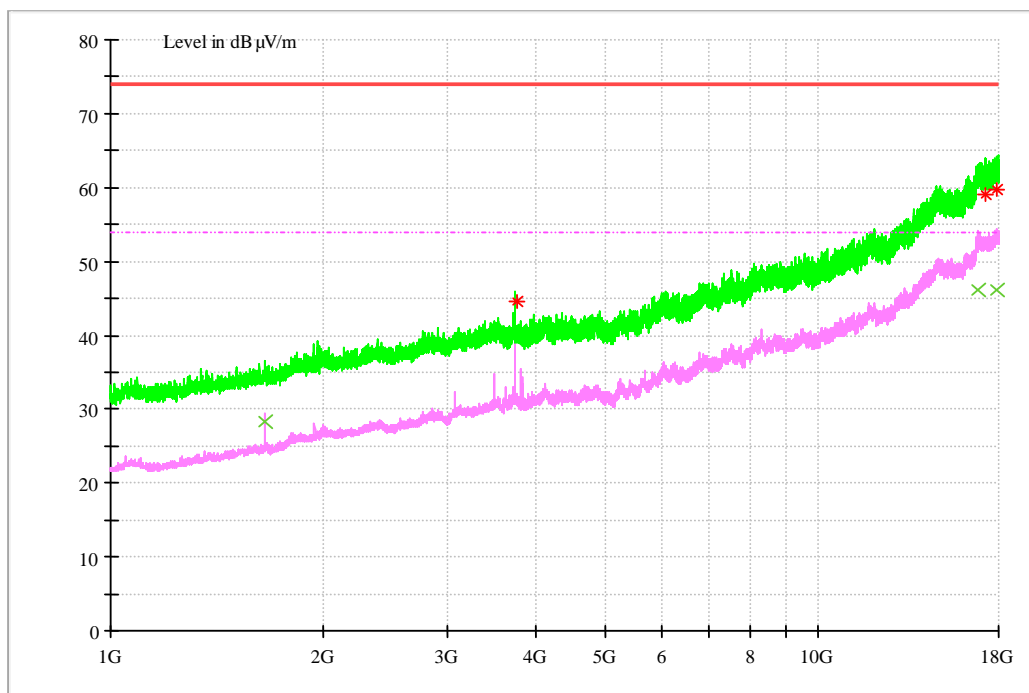

MEASUREMENT RESULT: PK Detector

Frequency MHz	Level dBµV/m	Transd dB	Limit dBµV/m	Margin dB	Height cm	Azimuth deg	Polarisation
3742.903333	44.53	-3.3	74	29.47	100	293	H
17290.75267	59.16	20.3	74	14.84	145	13	H
17929.05333	59.66	21.6	74	14.34	142	249	H

MEASUREMENT RESULT: AV Detector

Frequency MHz	Level dBµV/m	Transd dB	Limit dBµV/m	Margin dB	Height cm	Azimuth deg	Polarisation
1655.92000	28.39	-11.5	54	25.61	101	1	H
16830.58067	46.02	20.6	54	7.98	200	242	H
17883.95667	46.12	21.6	54	7.88	200	26	H

Note:

Level =Reading level by receiver + Transd (Antenna factor + cable loss – preamplifier gain)  
 The reading level is calculated by software which is not shown in the sheet.

### 7.1.3 18GHz~26.5GHz

Test Mode 2:Charging +Camera On +Earphone +idle

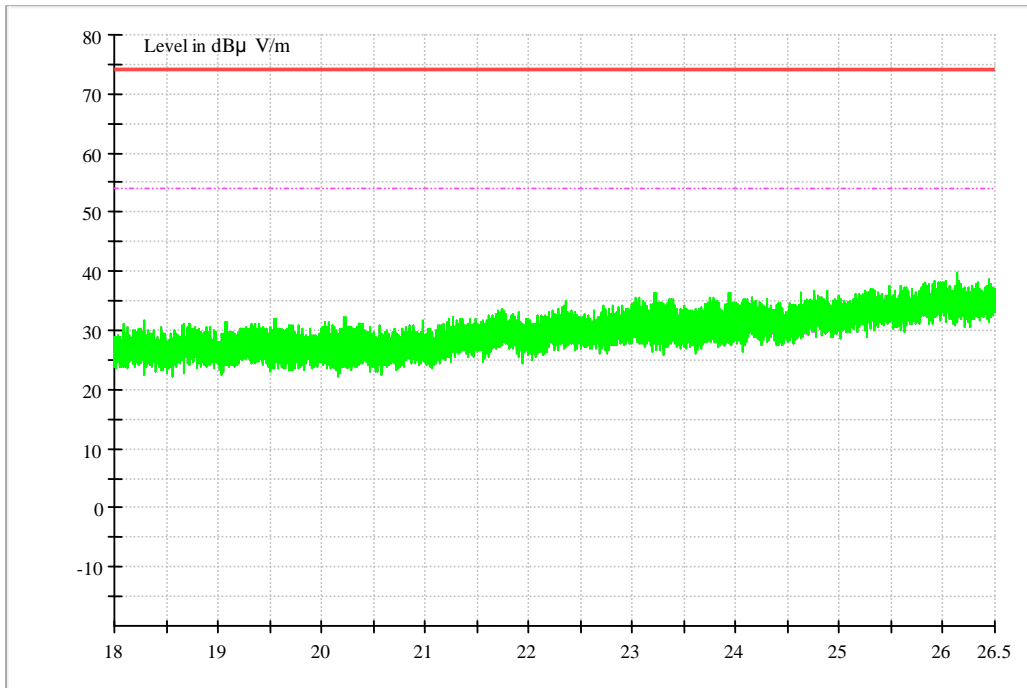

NOTE 1: The data was measured by Peak detector.

NOTE 2: No peak found in the Test Range of "18 GHz to 26.5GHz"

### 7.1.4 26.5GHz~40GHz

Test Mode 2:Charging +Camera On +Earphone +idle

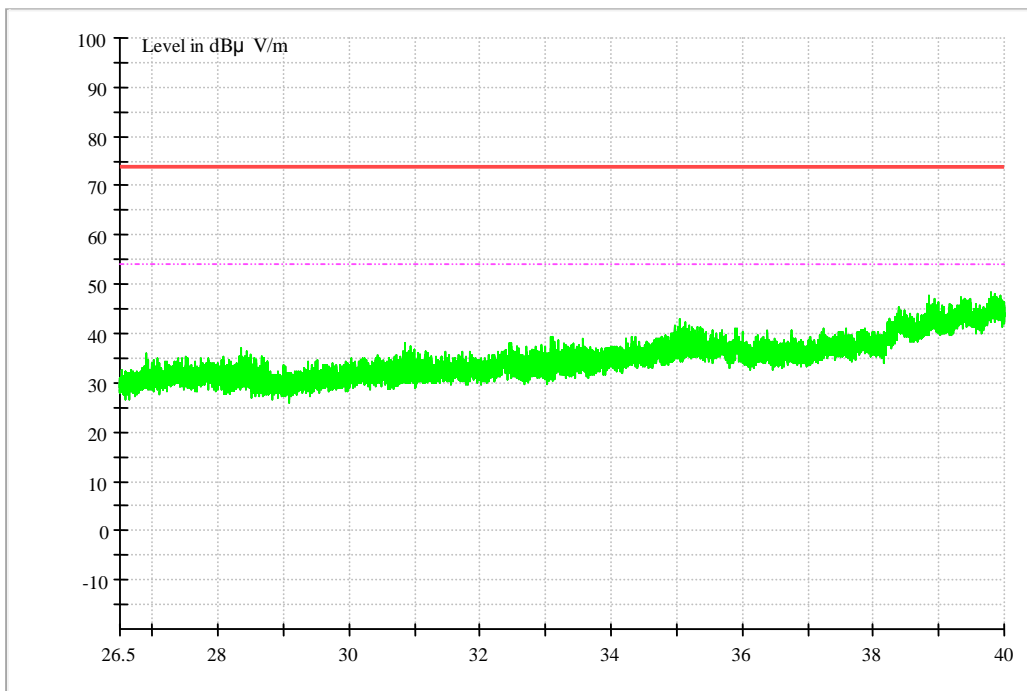

NOTE 1: The data was measured by Peak detector.

NOTE 2: No peak found in the Test Range of "26.5 GHz to 40GHz"

## 7.2 Conducted Disturbance

### 7.2.1 AC Port Test Data

Test Mode 1: Charging +traffic +WIFI+BT+GPS On +Earphone

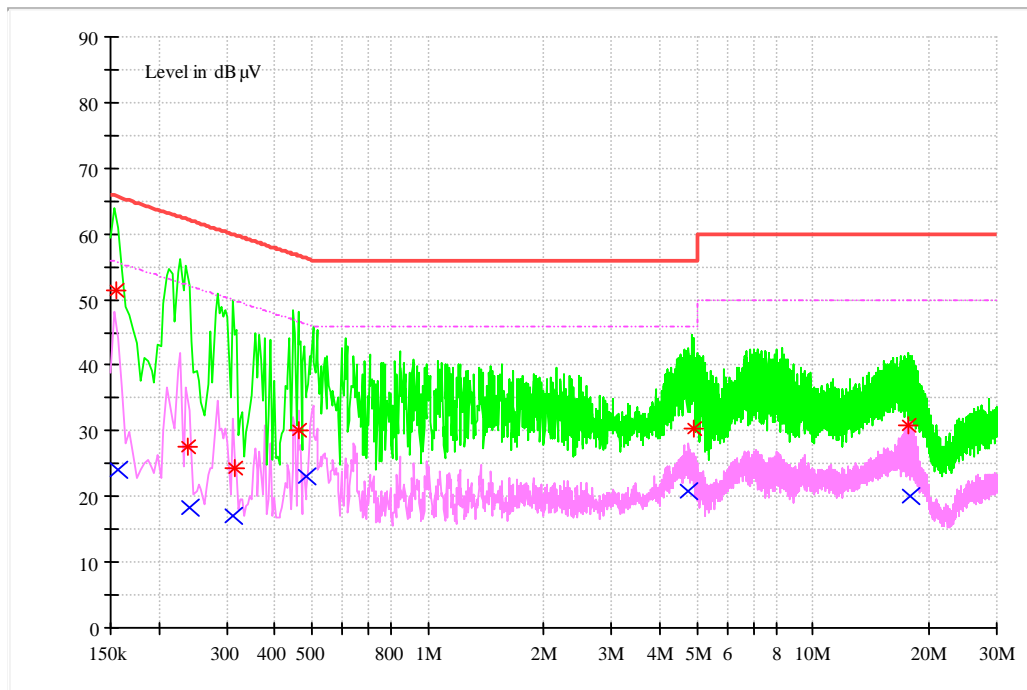

#### MEASUREMENT RESULT: QP Detector

Frequency MHz	Level dBµV	Line	Transd dB	Margin dB	Limit dBµV	PE
0.15461	51.48	L1	9.7	14.27	65.75	FLO
0.238231	27.53	L1	9.7	34.63	62.16	FLO
0.314433	24.28	L1	9.7	35.57	59.85	FLO
0.460927	29.96	L1	9.7	26.71	56.67	FLO
4.910314	30.45	L1	9.8	25.55	56	FLO
17.689982	30.73	N	10.1	29.27	60	FLO

#### MEASUREMENT RESULT: AV Detector

Frequency MHz	Level dBµV	Line	Transd dB	Margin dB	Limit dBµV	PE
0.157291	24.02	L1	9.7	31.59	55.61	FLO
0.239487	18.35	L1	9.7	33.77	52.12	FLO
0.311318	17.16	N	9.7	32.77	49.93	FLO
0.482914	23	L1	9.7	23.29	46.29	FLO
4.757933	20.84	L1	9.8	25.16	46	FLO
17.92939	20.05	N	10.1	29.95	50	FLO

-----END-----