



# RF TEST REPORT

**Applicant** Huawei Technologies Co., Ltd.  
**FCC ID** QISAMN-LX9B  
**Product** Smart Phone  
**Model** AMN-LX9X  
**Report No.** R1904H0060-R4  
**Issue Date** April 23, 2019

TA Technology (Shanghai) Co., Ltd. tested the above equipment in accordance with the requirements in **FCC CFR47 Part 15C (2018)**. The test results show that the equipment tested is capable of demonstrating compliance with the requirements as documented in this report.

*Performed by: Peng Tao*

*Approved by: Kai Xu*

---

## TA Technology (Shanghai) Co., Ltd.

*No.145, Jintang Rd, Tangzhen Industry Park, Pudong Shanghai, China*

*TEL: +86-021-50791141/2/3*

*FAX: +86-021-50791141/2/3-8000*



## TABLE OF CONTENT

1. Test Laboratory .....	4
1.1. Notes of the test report.....	4
1.2. Test facility .....	4
1.3. Testing Location.....	5
2. General Description of Equipment under Test.....	6
3. Applied Standards .....	8
4. Test Configuration .....	9
5. Test Case Results .....	10
5.1. Maximum output power .....	10
5.2. 6dB Bandwidth .....	12
5.3. Band Edge .....	16
5.4. Power Spectral Density .....	18
5.5. Spurious RF Conducted Emissions.....	22
5.6. Unwanted Emission .....	26
5.7. Conducted Emission .....	62
6. Main Test Instruments.....	65



## Summary of measurement results

Number	Summary of measurements of results	Clause in FCC rules	Verdict
1	Maximum conducted output power	15.247(b)(3)	PASS
2	6 dB bandwidth	15.247(a)(2)	PASS
3	Power spectral density	15.247(e)	PASS
4	Band Edge	15.247(d)	PASS
5	Spurious RF Conducted Emissions	15.247(d)	PASS
6	Unwanted Emissions	15.247(d),15.205,15.209	PASS
7	Conducted Emissions	15.207	PASS

Date of Testing: March 18, 2019~ April 22, 2019

## 1. Test Laboratory

### 1.1. Notes of the test report

This report shall not be reproduced in full or partial, without the written approval of **TA technology (shanghai) co., Ltd.** The results documented in this report apply only to the tested sample, under the conditions and modes of operation as described herein .Measurement Uncertainties were not taken into account and are published for informational purposes only. This report is written to support regulatory compliance of the applicable standards stated above.

### 1.2. Test facility

#### **CNAS (accreditation number: L2264)**

TA Technology (Shanghai) Co., Ltd. has obtained the accreditation of China National Accreditation Service for Conformity Assessment (CNAS).

#### **FCC (Designation number: CN1179, Test Firm Registration Number: 446626)**

TA Technology (Shanghai) Co., Ltd. has been listed on the US Federal Communications Commission list of test facilities recognized to perform electromagnetic emissions measurements.

#### **IC (recognition number is 8510A)**

TA Technology (Shanghai) Co., Ltd. has been listed by industry Canada to perform electromagnetic emission measurement.

#### **VCCI (recognition number is C-4595, T-2154, R-4113, G-10766)**

TA Technology (Shanghai) Co., Ltd. has been listed by industry Japan to perform electromagnetic emission measurement.

#### **A2LA (Certificate Number: 3857.01)**

TA Technology (Shanghai) Co., Ltd. has been listed by American Association for Laboratory Accreditation to perform electromagnetic emission measurement.



### 1.3. Testing Location

Company: TA Technology (Shanghai) Co., Ltd.  
Address: No.145, Jintang Rd, Tangzhen Industry Park, Pudong  
City: Shanghai  
Post code: 201201  
Country: P. R. China  
Contact: Xu Kai  
Telephone: +86-021-50791141/2/3  
Fax: +86-021-50791141/2/3-8000  
Website: <http://www.ta-shanghai.com>  
E-mail: [xukai@ta-shanghai.com](mailto:xukai@ta-shanghai.com)

## 2. General Description of Equipment under Test

### Client Information

Applicant	Huawei Technologies Co., Ltd.
Applicant address	Administration Building, Headquarters of Huawei Technologies Co., Ltd., Bantian, Longgang District, Shenzhen, 518129, P.R.China.
Manufacturer	Huawei Technologies Co., Ltd.
Manufacturer address	Administration Building, Headquarters of Huawei Technologies Co., Ltd., Bantian, Longgang District, Shenzhen, 518129, P.R.China.

### General information

EUT Description	
Model	AMN-LX9X
SN	QXPNU19330100102
Hardware Version	HL1AMNMY
Software Version	9.0.1.75(C900E31R1P2)
Power Supply	Battery/AC adapter
Antenna Type	Internal Antenna
Antenna Connector	A permanently attached antenna (meet with the standard FCC Part 15.203 requirement)
Antenna Gain	-1.00 dBi
additional beamforming gain	NA
Test Mode	802.11b 802.11g, 802.11n(HT20/HT40);
Modulation Type	802.11b: DSSS; 802.11g/n(HT20/HT40): OFDM
Max. Conducted Power	Wi-Fi 2.4G: 17.14dBm
Operating Frequency Range(s)	802.11b/g/n(HT20): 2412 ~ 2462 MHz 802.11n(HT40): 2422 ~ 2452 MHz
EUT Accessory	
Adapter 1	Manufacturer: Huawei Technologies Co., Ltd. (SHENZHEN HUNTKEY ELECTRIC CO., LTD.) Model: HW-050100U01
Adapter 2	Manufacturer: Huawei Technologies Co., Ltd. (HUIZHOU BYD ELECTRONIC CO., LTD.) Model: HW-050100U01
Adapter 3	Manufacturer: Huawei Technologies Co., Ltd. (Dongguan Phitek Electronics Co., Ltd.)



	Model: HW-050100U01
Battery 1	Manufacturer: HuaweiTechnologies Co., Ltd. (Sunwoda Electronic Co.,LTD) Model: HB405979ECW
Battery 2	Manufacturer: HuaweiTechnologies Co., Ltd. (SCUD (Fujian) Electronics Co., LTD.) Model: HB405979ECW
Battery 3	Manufacturer: HuaweiTechnologies Co., Ltd. (Desay Battery Electronic Co.,LTD) Model: HB405979ECW
Earphone 1	Manufacturer: Jiangxi Lianchuang Hongsheng Electronic Co. ,LTD. Model: MEND1532B528A02
Earphone 2	Manufacturer: Boluo County Quancheng Electronic Co.,ltd. Model: 1293-3283-3.5MM-322
Earphone 3	Manufacturer: FOXCONN INTERCONNECT TECHNOLOGY LIMITED Model: EPAB542-2WH05-DH
USB Cable 1	Manufacturer: HONGLIN TECHNOLOGY CO.,LTD. Model: 130-26654
USB Cable 2	Manufacturer: Dongguan Ming Ji Electronics Co.,Ltd. Model: 203-0786-0
USB Cable 3	Manufacturer: Luxshare Precision industry Co., Ltd. Model: L99U2013-CS-H
USB Cable 4	Manufacturer: NingBo Broad Telecommunication Co., Ltd. Model: WA0007
USB Cable 5	Manufacturer: HONGLIN TECHNOLOGY CO., LTD. Model: 130-26669
USB Cable 6	Manufacturer: FOXCONN INTERCONNECT TECHNOLOGY LIMITED Model: CUBB01M-HC304-DH
USB Cable 7	Manufacturer: Luxshare Precision industry Co.,Ltd Model: L99U2017-CS-H
USB Cable 8	Manufacturer: Dongguan Ming Ji Electronics Co.,Ltd Model: 203-1583-0
USB Cable 9	Manufacturer: NingBo Broad Telecommunication Co., Ltd. Model: WA0001
<p>Note: The information of the EUT is declared by the manufacturer.</p> <p>2. There is more than one Adapter/one USB cable/one Battery and Earphone, each one should be applied throughout the compliance test respectively, and however, only the worst case (Adapter 1/USB cable 2/ Battery 3/ Earphone 3) will be recorded in this report.</p>	



### 3. Applied Standards

According to the specifications of the manufacturer, it must comply with the requirements of the following standards:

#### Test standards

- **FCC CFR47 Part 15C (2018) Radio Frequency Devices**
- **ANSI C63.10 (2013)**
- **KDB 558074 D01 15.247 Meas Guidance v05r01**



## 4. Test Configuration

### Test Mode

The EUT has been associated with peripherals and configuration operated in a manner tended to maximize its emission characteristics in a typical application.

The radiated emission was measured in the following position: EUT stand-up position (Z axis), lie-down position (X, Y axis). The worst emission was found in lie-down position (X axis) and the loop antenna is vertical, the others are vertical and horizontal. and the worst case was recorded.

In order to find the worst case condition, Pre-tests are needed at the presence of different data rate. Preliminary tests have been done on all the configuration for confirming worst case. Data rate below means worst-case rate of each test item.

Worst-case data rates are shown as following table.

Band	Data Rate
802.11b	1 Mbps
802.11g	6 Mbps
802.11n HT20	MCS0
802.11n HT40	MCS0

## 5. Test Case Results

### 5.1. Maximum output power

#### Ambient condition

Temperature	Relative humidity	Pressure
23°C ~25°C	45%~50%	101.5kPa

#### Methods of Measurement

During the process of the testing, The EUT was connected to Average Power meter with a known loss. The EUT is max power transmission with proper modulation. The signal transmission is continuous.

#### Test Setup

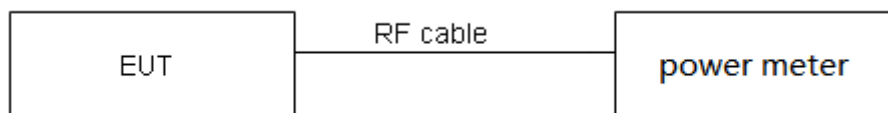

#### Limits

Rule Part 15.247 (b) (3) specifies that " For systems using digital modulation in the 902–928 MHz, 2400–2483.5 MHz: 1 Watt."

Average Output Power	$\leq 1W$ (30dBm)
----------------------	-------------------

#### Measurement Uncertainty

The assessed measurement uncertainty to ensure 95% confidence level for the normal distribution is with the coverage factor  $k = 2$ ,  $U = 0.44$  dB.

**Test Results**

Power Index			
Packet Type	CH1	CH6	CH11
802.11b	18	18	18
802.11g	13	17	13
802.11n HT20	13	16.5	13
Packet Type	CH3	CH6	CH9
802.11n HT40	14	14	11

Band	T <sub>on</sub> (ms)	T <sub>(on+off)</sub> (ms)	Duty cycle	Duty cycle correction Factor(dB)
802.11b	8.38	8.42	0.99	NA
802.11g	1.39	1.43	0.97	0.13
802.11n HT20	1.30	1.34	0.97	0.14
802.11n HT40	2.44	4.14	0.59	2.30

Note: when Duty cycle>0.98, Duty cycle correction Factor not required.

Network Standards	Carrier frequency (MHz)	Average Power Measured (dBm)	Average Power with duty factor (dBm)	Limit (dBm)	Conclusion
802.11b	2412	17.14	17.14	30	PASS
	2437	17.01	17.01	30	PASS
	2462	17.03	17.03	30	PASS
802.11g	2412	11.98	12.11	30	PASS
	2437	15.67	15.80	30	PASS
	2462	11.91	12.04	30	PASS
802.11n HT20	2412	11.98	12.12	30	PASS
	2437	15.39	15.53	30	PASS
	2462	11.82	11.96	30	PASS
802.11n HT40	2422	10.68	12.98	30	PASS
	2437	10.71	13.01	30	PASS
	2452	7.49	9.79	30	PASS

Note: Average Power with duty factor = Average Power Measured +Duty cycle correction factor

## 5.2. 6dB Bandwidth

### Ambient condition

Temperature	Relative humidity	Pressure
23°C ~25°C	45%~50%	101.5kPa

### Method of Measurement

The EUT was connected to the spectrum analyzer through an external attenuator (20dB) and a known loss cable. RBW is set to 100 kHz; VBW is set to 300 kHz on spectrum analyzer. Dector=Peak, Trace mode=max hold.

### Test Setup

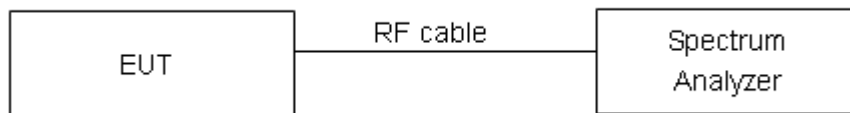

### Limits

Rule Part 15.247 (a) (2) specifies that “Systems using digital modulation techniques may operate in the 902–928 MHz, 2400–2483.5 MHz bands. The minimum 6 dB bandwidth shall be at least 500 kHz.”

minimum 6 dB bandwidth	≥ 500 kHz
------------------------	-----------

### Measurement Uncertainty

The assessed measurement uncertainty to ensure 95% confidence level for the normal distribution is with the coverage factor  $k = 2$ ,  $U = 936$  Hz.

**Test Results:**

Network Standards	Carrier frequency (MHz)	99% bandwidth (MHz)	Minimum 6 dB bandwidth (MHz)	Limit (kHz)	Conclusion
802.11b	2412	12.661	7.619	500	PASS
	2437	12.946	8.557	500	PASS
	2462	12.669	8.090	500	PASS
802.11g	2412	16.435	15.77	500	PASS
	2437	16.513	16.37	500	PASS
	2462	16.396	16.04	500	PASS
802.11n HT20	2412	17.608	16.38	500	PASS
	2437	17.940	17.63	500	PASS
	2462	17.595	16.00	500	PASS
802.11n HT40	2422	35.875	35.19	500	PASS
	2437	36.214	36.02	500	PASS
	2452	36.142	35.82	500	PASS

802.11b, Carrier frequency (MHz): 2412



802.11g, Carrier frequency (MHz): 2412



802.11b, Carrier frequency (MHz): 2437



802.11g, Carrier frequency (MHz): 2437



802.11b, Carrier frequency (MHz): 2462



802.11g, Carrier frequency (MHz): 2462

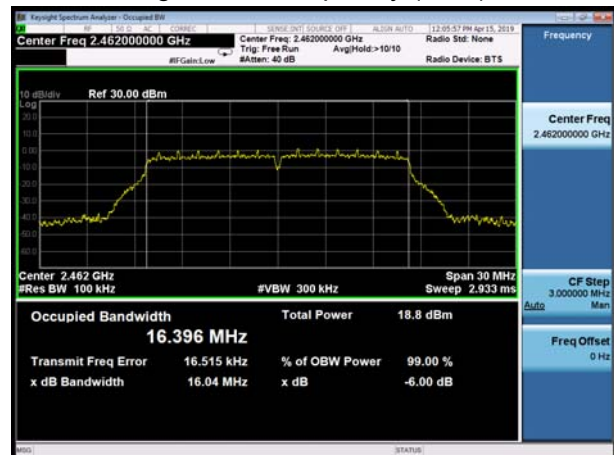



802.11n(HT20), Carrier frequency (MHz): 2412

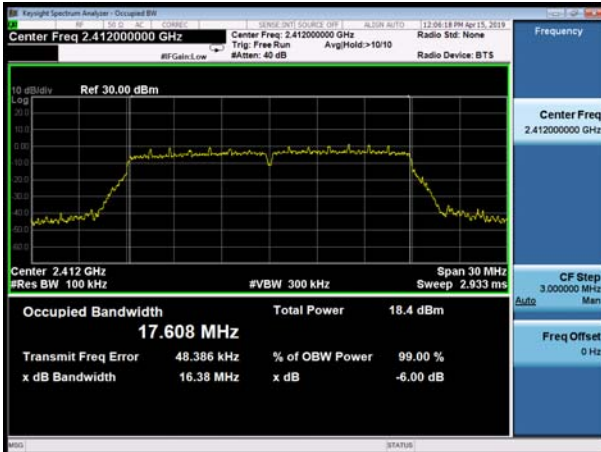

802.11n(HT40), Carrier frequency (MHz): 2422



802.11n(HT20), Carrier frequency (MHz): 2437



802.11n(HT40), Carrier frequency (MHz): 2437

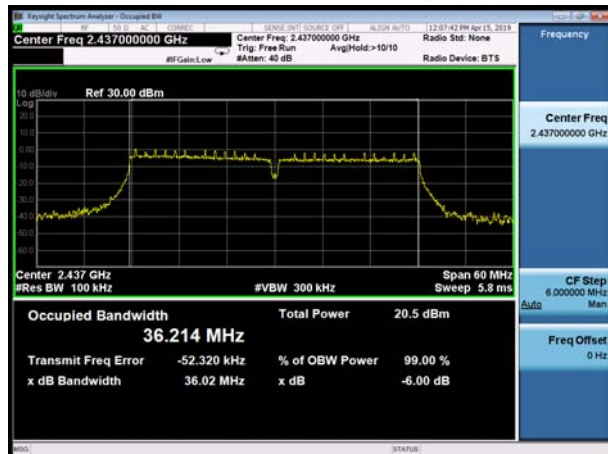

802.11n(HT20), Carrier frequency (MHz):2462

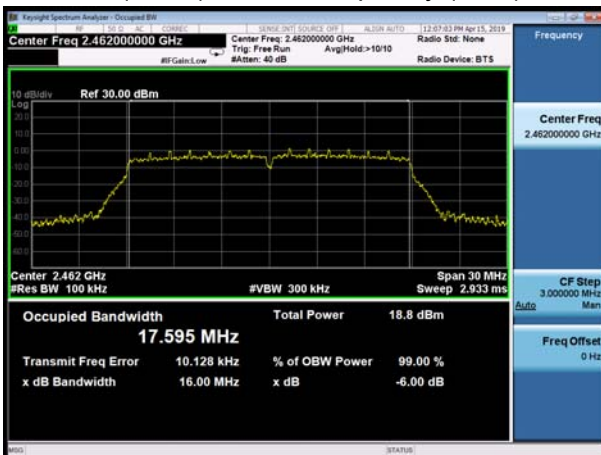

802.11n(HT40), Carrier frequency (MHz):2452

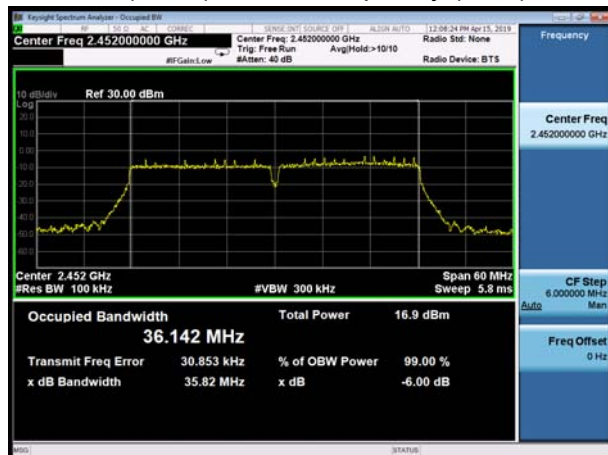

### 5.3. Band Edge

#### Ambient condition

Temperature	Relative humidity	Pressure
23°C ~25°C	45%~50%	101.5kPa

#### Method of Measurement

The EUT was connected to the spectrum analyzer through an external attenuator (20dB) and a known loss cable the band edge of the lowest and highest channels were measured. The peak detector is used and RBW is set to 100 kHz and VBW is set to 300 kHz on spectrum analyzer. Spectrum analyzer plots are included on the following pages.

#### Test Setup

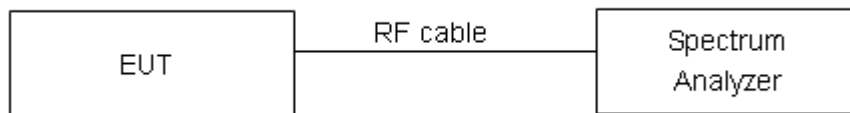

#### Limits

Rule Part 15.247(d) specifies that “In any 100 kHz bandwidth outside the frequency band in which the spread spectrum or digitally modulated intentional radiator is operating, the radio frequency power that is produced by the intentional radiator shall be at least 20 dB below that in the 100 kHz bandwidth within the band that contains the highest level of the desired power, based on either an RF conducted or a radiated measurement, provided the transmitter demonstrates compliance with the peak conducted power limits.” If the transmitter complies with the conducted power limits based on the use of RMS averaging over a time interval, as permitted under paragraph (b)(3) of this section, the attenuation required under this paragraph shall be 30 dB instead of 20 dB.”

#### Measurement Uncertainty

The assessed measurement uncertainty to ensure 95% confidence level for the normal distribution is with the coverage factor  $k = 1.96$ .

Frequency	Uncertainty
2GHz-3GHz	1.407 dB





Test Results: PASS

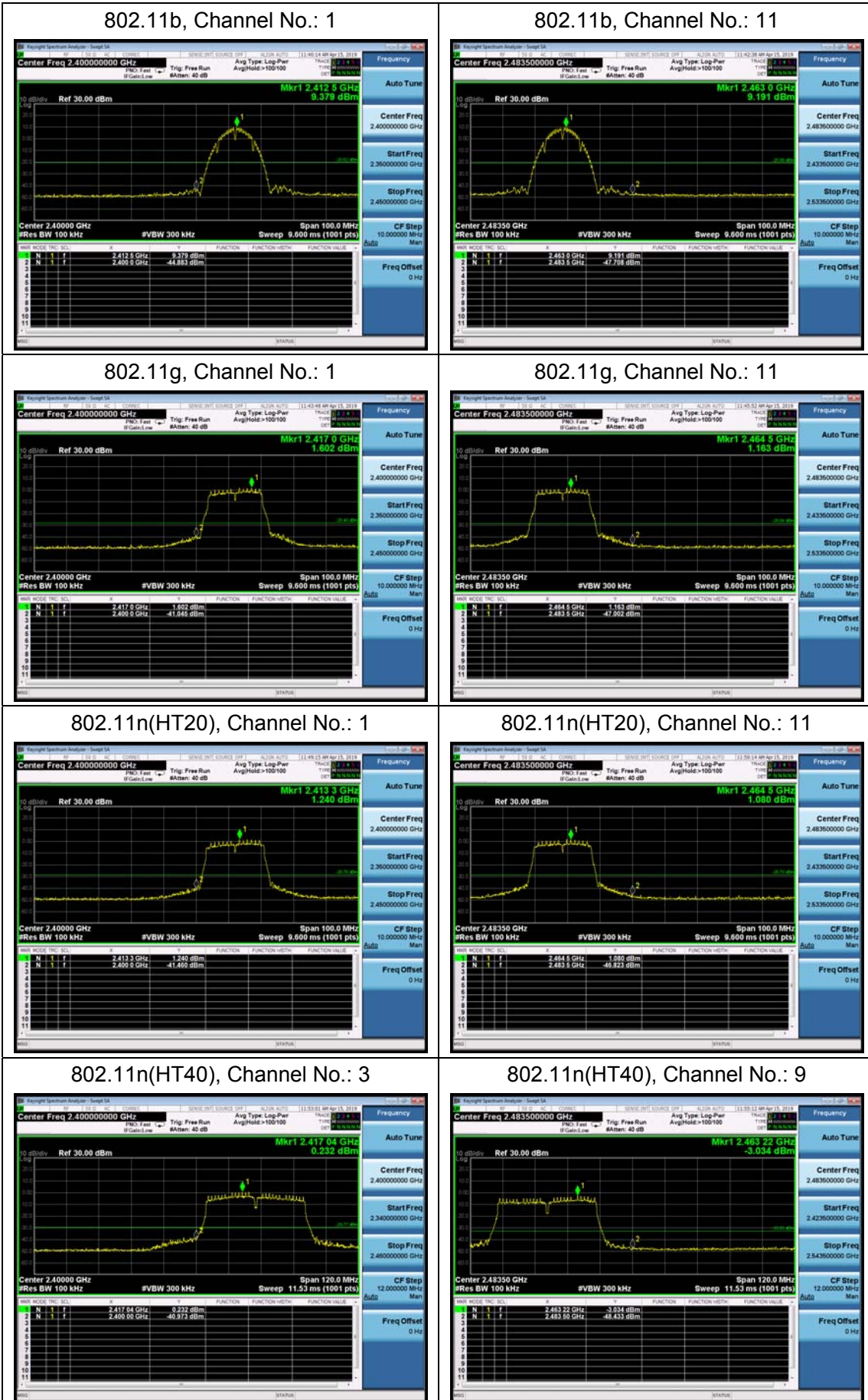

### 5.4. Power Spectral Density

#### Ambient condition

Temperature	Relative humidity	Pressure
23°C ~25°C	45%~50%	101.5kPa

#### Method of Measurement

During the process of the testing, The EUT was connected to Spectrum Analyzer with a known loss. The EUT is max power transmission with proper modulation. Method AVGPSD-2 in KDB558074 D01 was used for this test.

#### Test setup

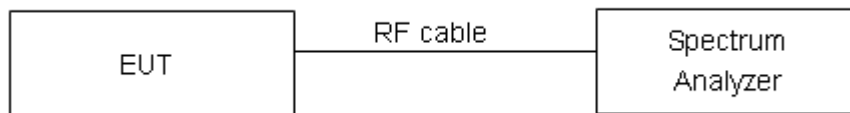

#### Limits

Rule Part 15.247(e) specifies that” For digitally modulated systems, the power spectral density conducted from the intentional radiator to the antenna shall not be greater than 8 dBm in any 3 kHz band during any time interval of continuous transmission. ”

Limits	≤ 8 dBm / 3kHz
--------	----------------

#### Measurement Uncertainty

The assessed measurement uncertainty to ensure 95% confidence level for the normal distribution is with the coverage factor  $k = 2$ ,  $U = 0.75\text{dB}$ .

**Test Results:**

Network Standards	Channel Number	Read Value (dBm / 3kHz)	Power Spectral Density (dBm / 3kHz)	Limit (dBm / 3kHz)	Conclusion
802.11b	1	-14.73	-14.73	8	PASS
	6	-14.83	-14.83	8	PASS
	11	-15.14	-15.14	8	PASS
802.11g	1	-22.70	-22.57	8	PASS
	6	-19.01	-18.88	8	PASS
	11	-22.90	-22.77	8	PASS
802.11n HT20	1	-22.82	-22.68	8	PASS
	6	-19.52	-19.39	8	PASS
	11	-23.29	-23.15	8	PASS
802.11n HT40	3	-26.65	-24.35	8	PASS
	6	-27.17	-24.87	8	PASS
	9	-30.33	-28.03	8	PASS

Note: Power Spectral Density =Read Value+Duty cycle correction factor



802.11b, Channel No.: 1



802.11g, Channel No.: 1



802.11b, Channel No.: 6



802.11g, Channel No.: 6

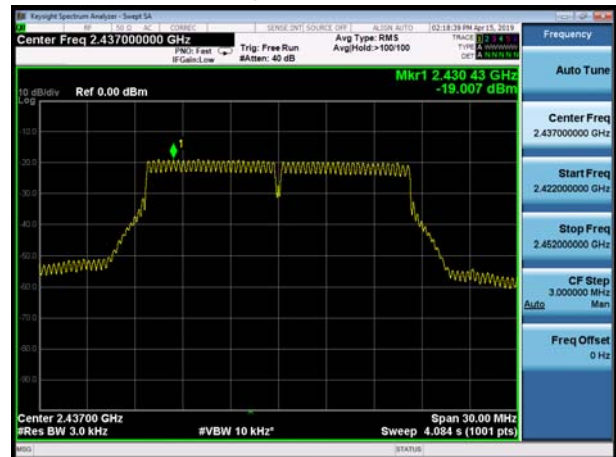

802.11b, Channel No.: 11



802.11g, Channel No.: 11

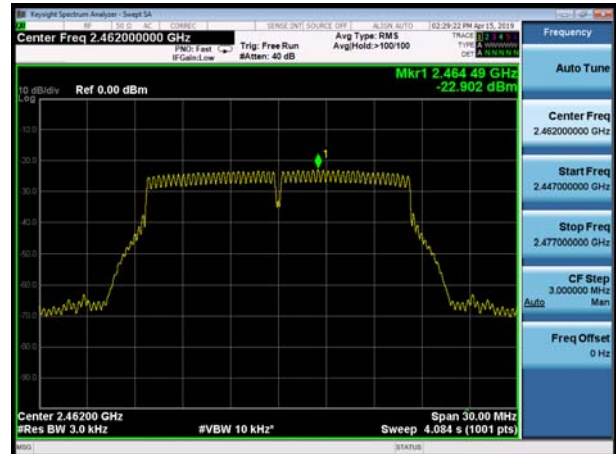



802.11n(HT20), Channel No. 1

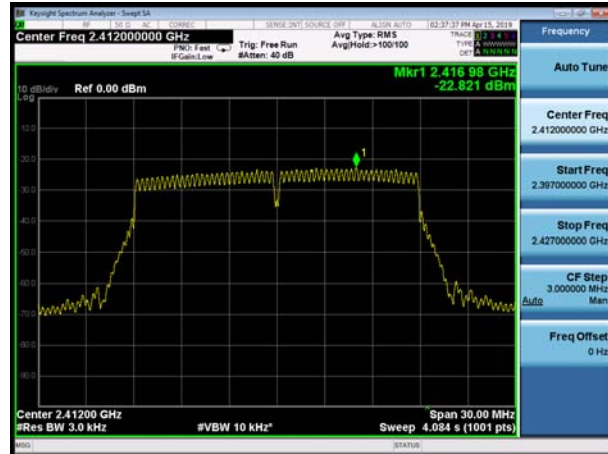

802.11n(HT40), Channel No. 3



802.11n(HT20), Channel No. 6

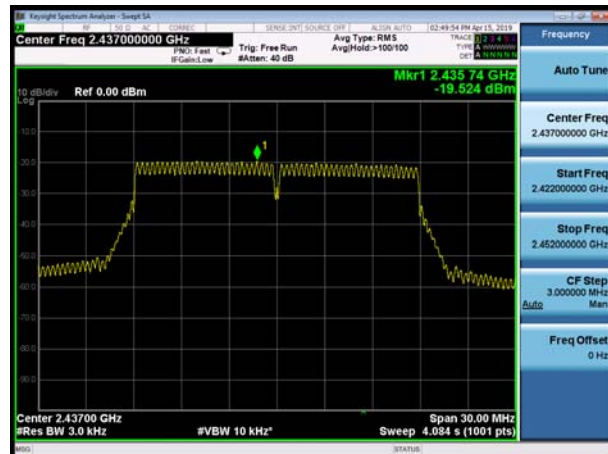

802.11n(HT40), Channel No. 6

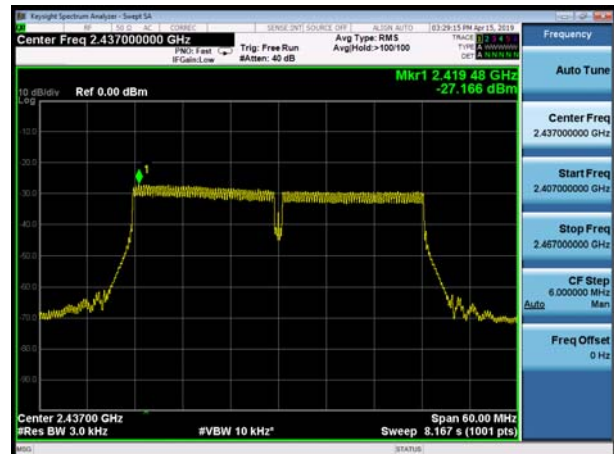

802.11n(HT20), Channel No. 11

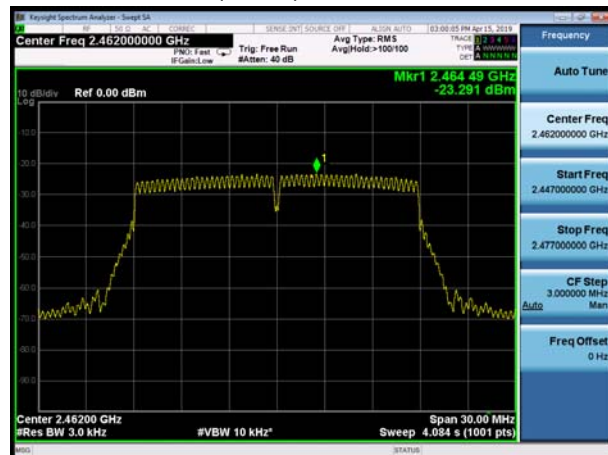

802.11n(HT40), Channel No. 9

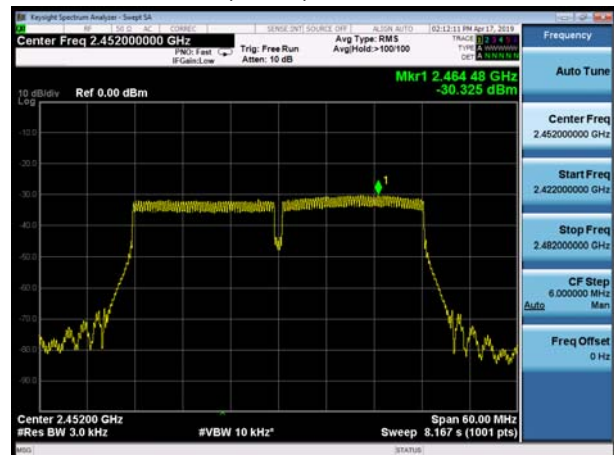

### 5.5. Spurious RF Conducted Emissions

**Ambient condition**

Temperature	Relative humidity	Pressure
23°C ~25°C	45%~50%	101.5kPa

**Method of Measurement**

The EUT was connected to the spectrum analyzer with a known loss. The spectrum analyzer scans from 30MHz to the 10th harmonic of the carrier. The peak detector is used. Set RBW to 100 kHz and VBW to 300 kHz, Sweep is set to ATUO.

The test is in transmitting mode.

**Test setup**



**Limits**

Rule Part 15.247(d) pacifies that “In any 100 kHz bandwidth outside the frequency band in which the spread spectrum or digitally modulated intentional radiator is operating, the radio frequency power that is produced by the intentional radiator shall be at least 20 dB below that in the 100 kHz bandwidth within the band that contains the highest level of the desired power, based on either an RF conducted or a radiated measurement, provided the transmitter demonstrates compliance with the peak conducted power limits. If the transmitter complies with the conducted power limits based on the use of RMS averaging over a time interval, as permitted under paragraph (b)(3) of this section, the attenuation required under this paragraph shall be 30 dB instead of 20 dB.”

Network Standards	Carrier frequency (MHz)	Reference value (dBm)	Limit
802.11b	2412	8.48	-21.52
	2437	8.71	-21.29
	2462	8.77	-21.23
802.11g	2412	0.93	-29.07
	2437	5.23	-24.77
	2462	0.92	-29.09
802.11n HT20	2412	0.91	-29.09
	2437	4.01	-25.99
	2462	1.04	-28.96
802.11n HT40	2422	-0.60	-30.60
	2437	-0.15	-30.15
	2452	-3.87	-33.87



### Measurement Uncertainty

The assessed measurement uncertainty to ensure 95% confidence level for the normal distribution is with the coverage factor  $k = 1.96$ .

Frequency	Uncertainty
100kHz-2GHz	0.684 dB
2GHz-26GHz	1.407 dB



Test Results:

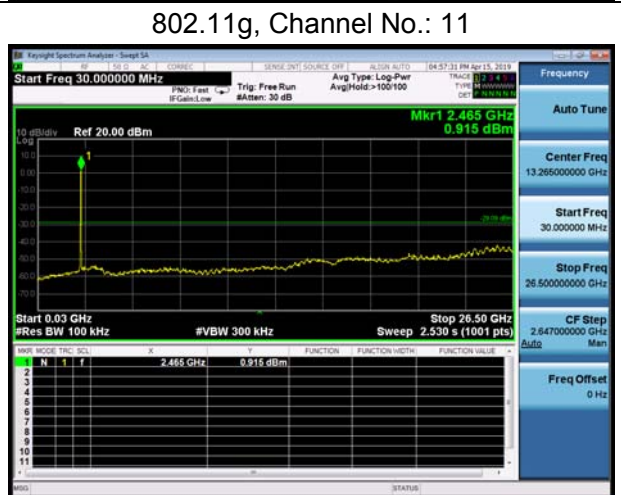
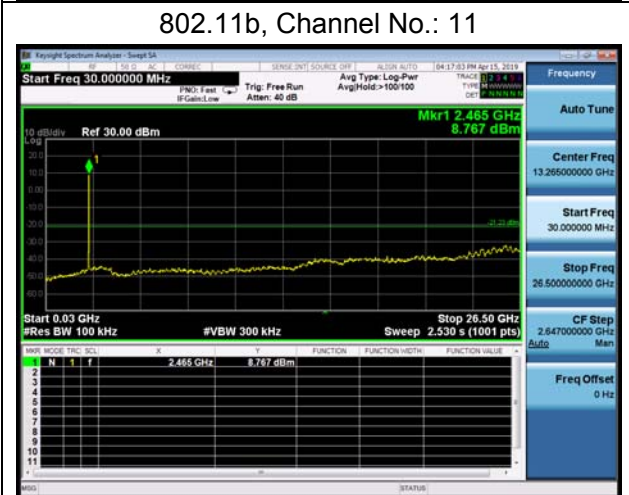
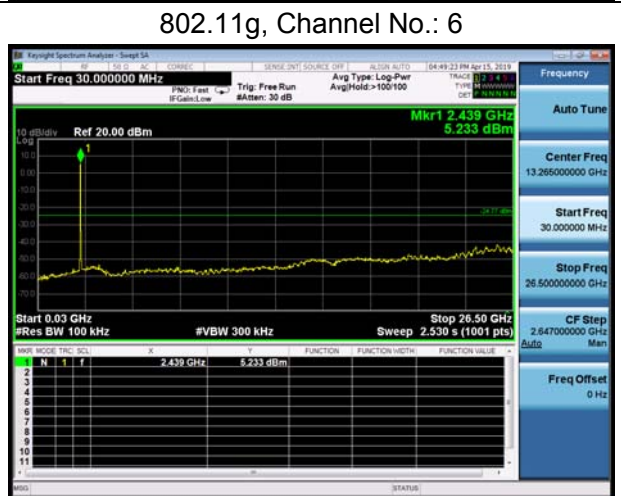
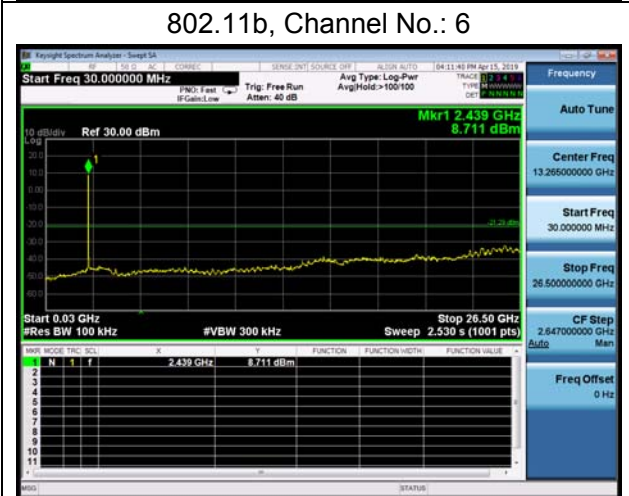
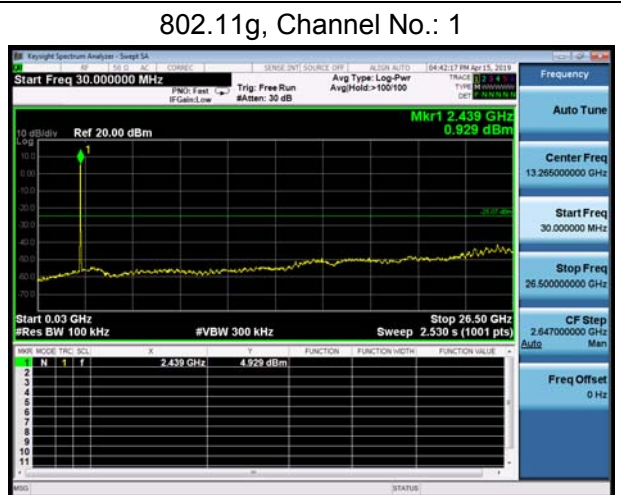
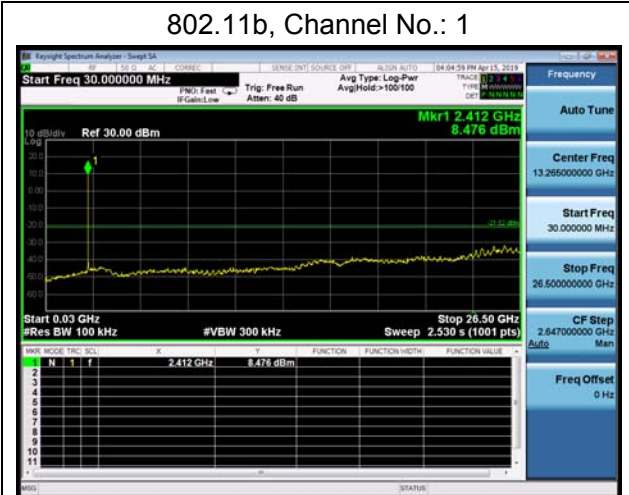





802.11n(HT20), Channel No. 1

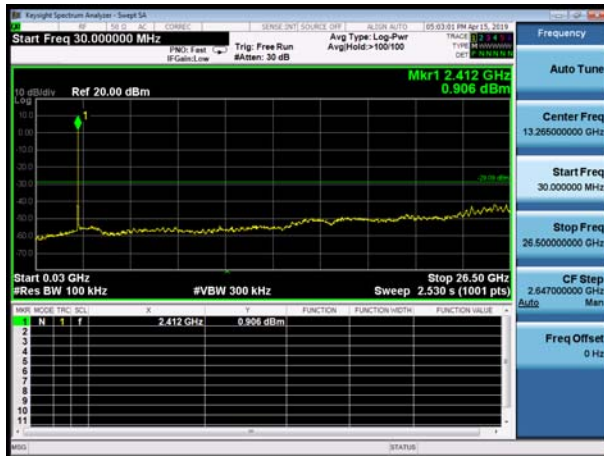

802.11n(HT40), Channel No. 3

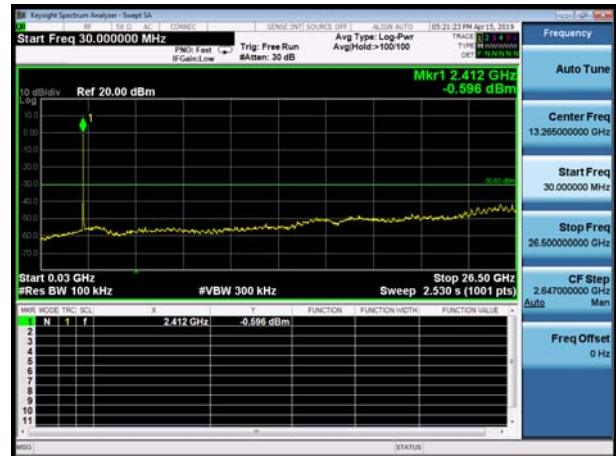

802.11n(HT20), Channel No. 6

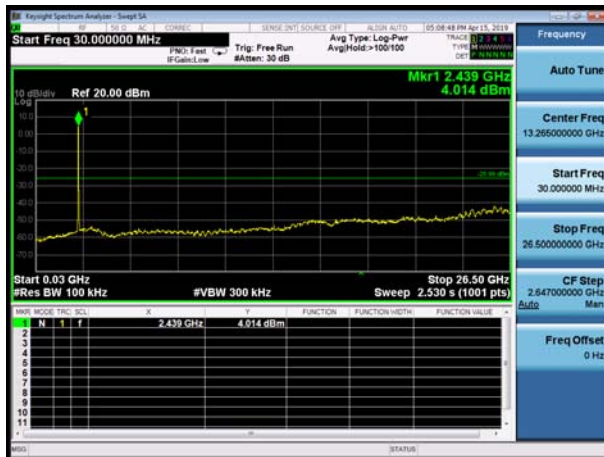

802.11n(HT40), Channel No. 6

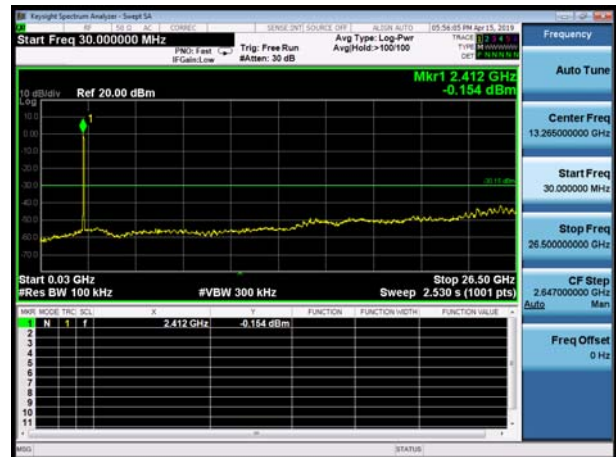

802.11n(HT20), Channel No. 11

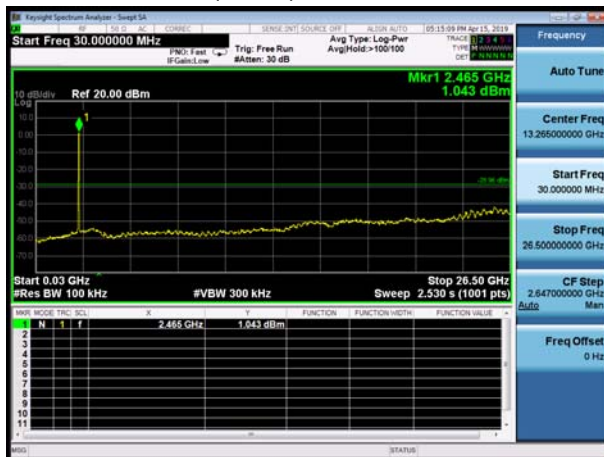

802.11n(HT40), Channel No. 9

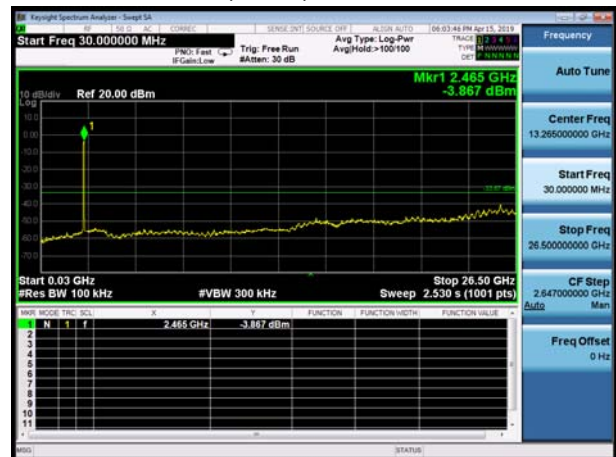

## 5.6. Unwanted Emission

### Ambient condition

Temperature	Relative humidity	Pressure
23°C ~25°C	45%~50%	102.5kPa

### Method of Measurement

The test set-up was made in accordance to the general provisions of ANSI C63.10-2013.

The Equipment Under Test (EUT) was set up on a non-conductive table in the semi-anechoic chamber. The test was performed at the distance of 3 m between the EUT and the receiving antenna.

The turntable shall be rotated from 0 to 360 degrees for detecting the maximum of radiated spurious signal level. The measurements shall be repeated with orthogonal polarization of the test antenna. The data of cable loss and antenna factor has been calibrated in full testing frequency range before the testing. Sweep the Restricted Band and the emissions less than 20 dB below the permissible value are reported.

The radiated emissions measurements were made in a typical installation configuration.

Sweep the whole frequency band through the range from 9 kHz to the 10th harmonic of the carrier, and the emissions less than 20 dB below the permissible value are reported.

This method refer to ANSI C63.10-2013.

The procedure for peak unwanted emissions measurements above 1000 MHz is as follows:

I) Peak emission levels are measured by setting the instrument as follows:

- 1) RBW = 1 MHz.
- 2) VBW  $\geq$  [3  $\times$  RBW]
- 3) Detector = peak.
- 4) Sweep time = auto.
- 5) Trace mode = max hold.
- 6) Allow sweeps to continue until the trace stabilizes. Note that if the transmission is not continuous, then the time required for the trace to stabilize will increase by a factor of approximately 1 / D, where D is the duty cycle.

II) Average emission levels are measured by setting the instrument as follows:

- a) RBW = 1 MHz.
- b) VBW  $\geq$  [3  $\times$  RBW].
- c) Detector = RMS (power averaging), if [span / (# of points in sweep)]  $\leq$  RBW / 2. Satisfying this condition can require increasing the number of points in the sweep or reducing the span. If the condition is not satisfied, then the detector mode shall be set to peak.
- d) Averaging type = power (i.e., rms) (As an alternative, the detector and averaging type may be set for linear voltage averaging. Some instruments require linear display mode to use linear voltage



averaging. Log or dB averaging shall not be used.)

e) Sweep time = auto.

f) Perform a trace average of at least 100 traces if the transmission is continuous. If the transmission is not continuous, then the number of traces shall be increased by a factor of  $1 / D$ , where  $D$  is the duty cycle. For example, with 50% duty cycle, at least 200 traces shall be averaged. (If a specific emission is demonstrated to be continuous—i.e., 100% duty cycle—then rather than turning ON and OFF with the transmit cycle, at least 100 traces shall be averaged.)

g) If tests are performed with the EUT transmitting at a duty cycle less than 98%, then a correction factor shall be added to the measurement results prior to comparing with the emission limit, to compute the emission level that would have been measured had the test been performed at 100% duty cycle. The correction factor is computed as follows:

1) If power averaging (rms) mode was used in the preceding step e), then the correction factor is  $[10 \log (1 / D)]$ , where  $D$  is the duty cycle. For example, if the transmit duty cycle was 50%, then 3 dB shall be added to the measured emission levels.

2) If linear voltage averaging mode was used in the preceding step e), then the correction factor is  $[20 \log (1 / D)]$ , where  $D$  is the duty cycle. For example, if the transmit duty cycle was 50%, then 6 dB shall be added to the measured emission levels.

3) If a specific emission is demonstrated to be continuous (100% duty cycle) rather than turning ON and OFF with the transmit cycle, then no duty cycle correction is required for that emission.

The test is in transmitting mode.

**Test setup**

**9KHz ~ 30MHz**

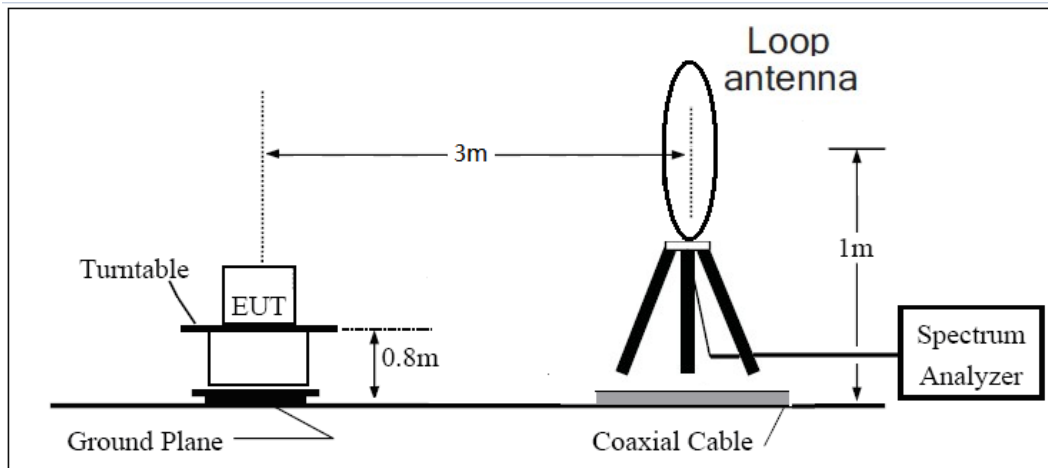

**30MHz ~ 1GHz**

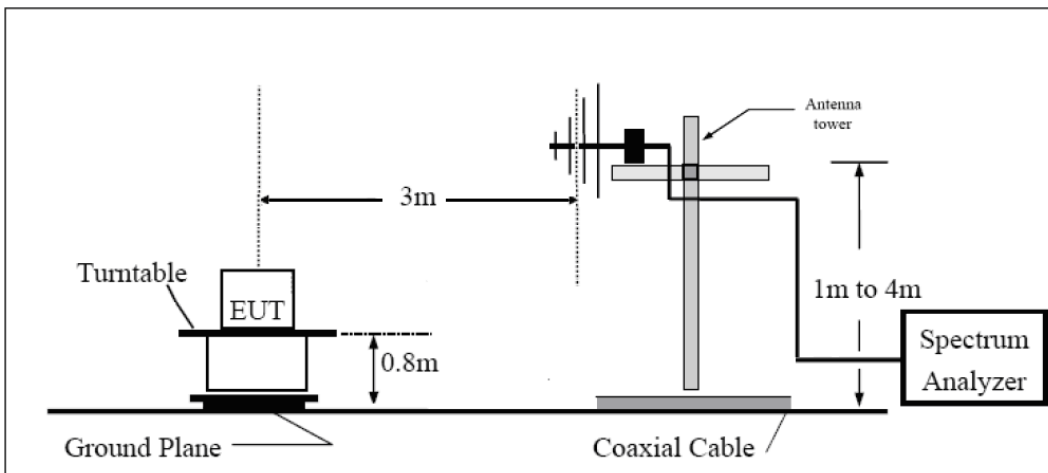

**Above 1GHz**

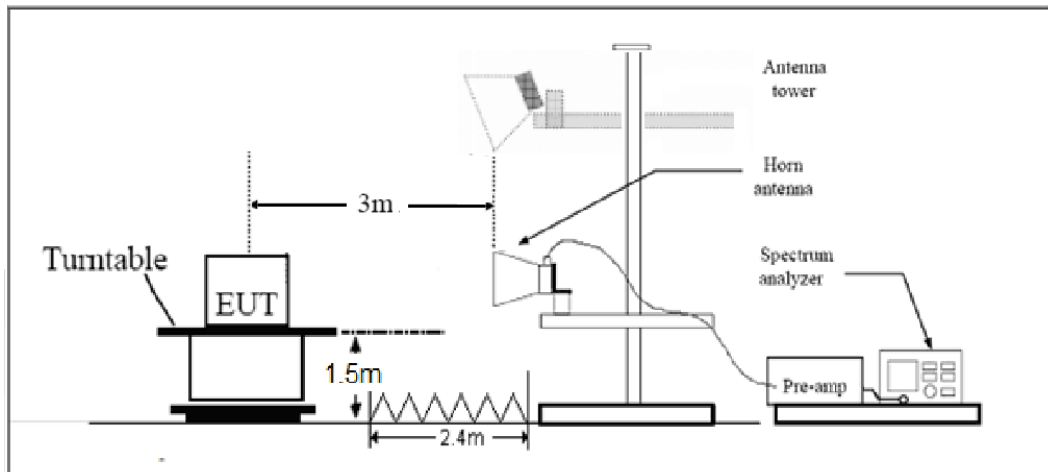

Note: Area side:2.4mX3.6m

**Limits**

Rule Part 15.247(d) specifies that "In addition, radiated emissions which fall in the restricted bands, as defined in § 15.205(a), must also comply with the radiated emission limits specified in § 15.209(a) (see § 15.205(c))."

Limit in restricted band

Frequency of emission (MHz)	Field strength(uV/m)	Field strength(dBuV/m)
0.009–0.490	2400/F(kHz)	/
0.490–1.705	24000/F(kHz)	/
1.705–30.0	30	/
30-88	100	40
88-216	150	43.5
216-960	200	46
Above960	500	54

## §15.35(b)

There is also a limit on the radio frequency emissions, as measured using instrumentation with a peak detector function, corresponding to 20 dB above the maximum permitted average limit.

Peak Limit=74 dBuV/m

Average Limit=54 dBuV/m

Spurious Radiated Emissions are permitted in any of the frequency bands listed below:

MHz	MHz	MHz	GHz
0.090 - 0.110	16.42 - 16.423	399.9 - 410	4.5 - 5.15
<sup>1</sup> 0.495 - 0.505	16.69475 - 16.69525	608 - 614	5.35 - 5.46
2.1735 - 2.1905	16.80425 - 16.80475	960 - 1240	7.25 - 7.75
4.125 - 4.128	25.5 - 25.67	1300 - 1427	8.025 - 8.5
4.17725 - 4.17775	37.5 - 38.25	1435 - 1626.5	9.0 - 9.2
4.20725 - 4.20775	73 - 74.6	1645.5 - 1646.5	9.3 - 9.5
6.215 - 6.218	74.8 - 75.2	1660 - 1710	10.6 - 12.7
6.26775 - 6.26825	108 - 121.94	1718.8 - 1722.2	13.25 - 13.4
6.31175 - 6.31225	123 - 138	2200 - 2300	14.47 - 14.5
8.291 - 8.294	149.9 - 150.05	2310 - 2390	15.35 - 16.2
8.362 - 8.366	156.52475 - 156.52525	2483.5 - 2500	17.7 - 21.4
8.37625 - 8.38675	156.7 - 156.9	2690 - 2900	22.01 - 23.12
8.41425 - 8.41475	162.0125 - 167.17	3260 - 3267	23.6 - 24.0
12.29 - 12.293	167.72 - 173.2	3332 - 3339	31.2 - 31.8
12.51975 - 12.52025	240 - 285	3345.8 - 3358	36.43 - 36.5
12.57675 - 12.57725	322 - 335.4	3600 - 4400	( <sup>2</sup> )
13.36 - 13.41			

**Measurement Uncertainty**

The assessed measurement uncertainty to ensure 95% confidence level for the normal distribution is with the coverage factor  $k = 1.96$ .

Frequency	Uncertainty
9KHz-30MHz	3.55 dB
30MHz-200MHz	4.02 dB
200MHz-1GHz	3.28 dB
1-18GHz	3.70 dB
18-26.5GHz	5.78 dB



Test Results:

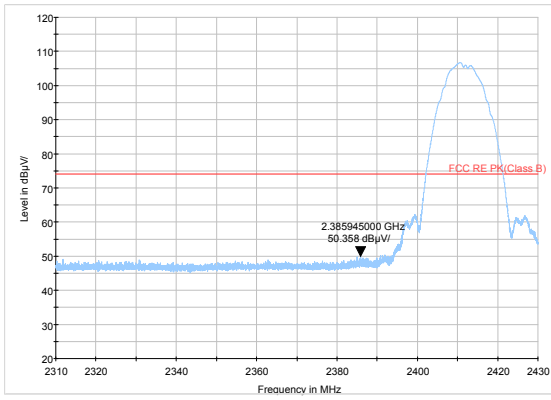

802.11b-Channel 1 Peak

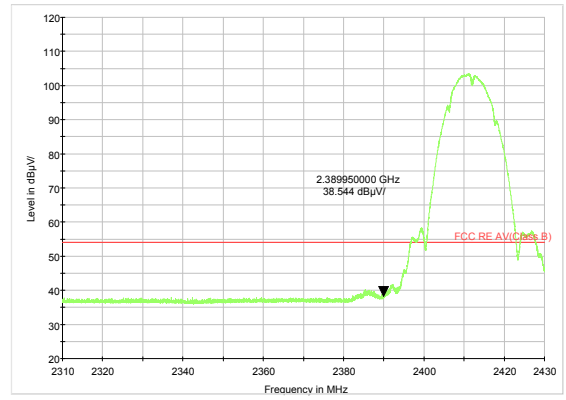

802.11b-Channel 1 Average

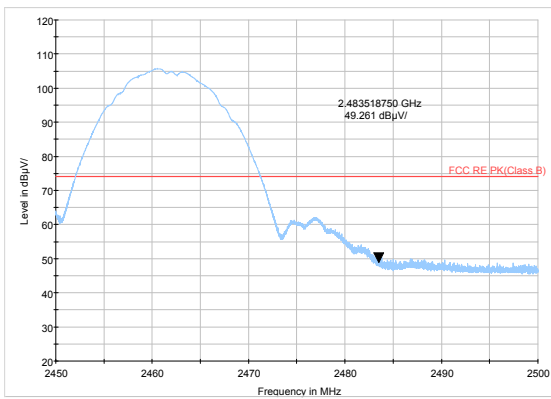

802.11b-Channel 11 Peak

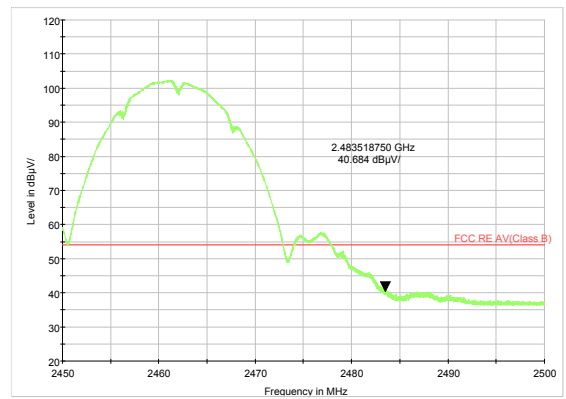

802.11b-Channel 11 Average

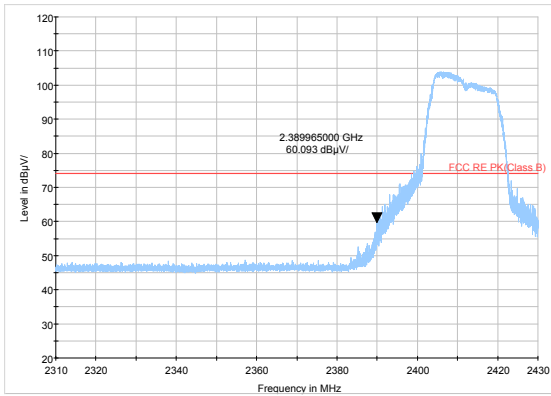

802.11g-Channel 1 Peak

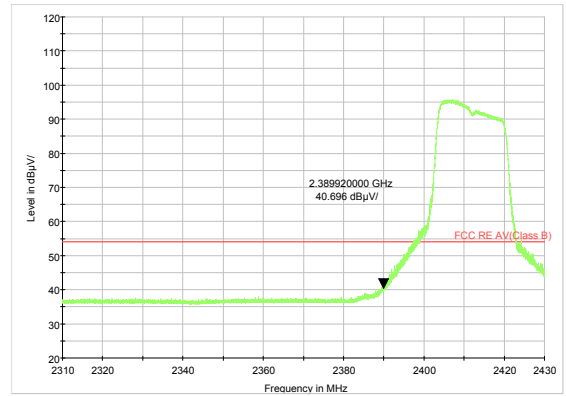

802.11g-Channel 1 Average

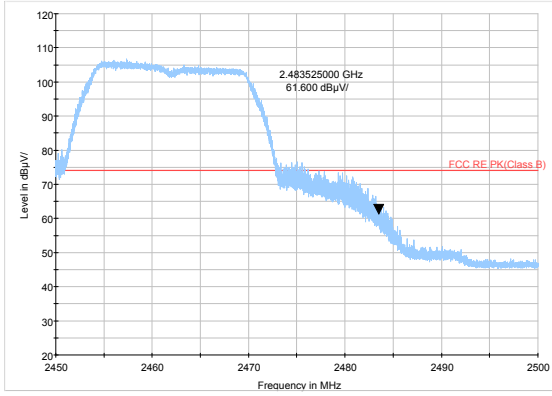

802.11g-Channel 11 Peak

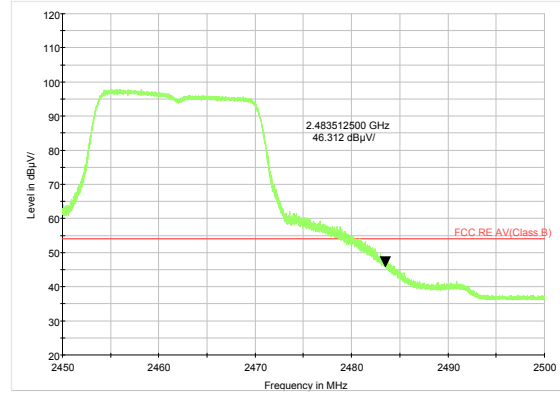

802.11g-Channel 11 Average

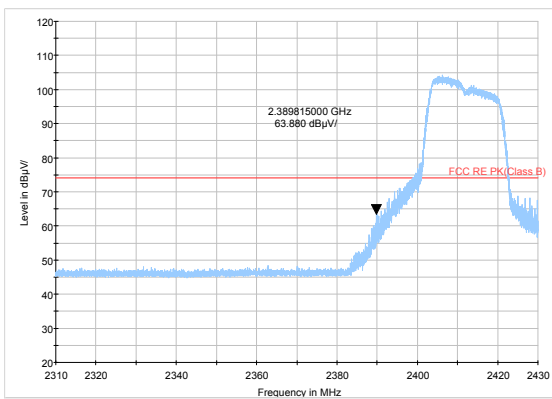

802.11n HT20 -Channel 1 Peak

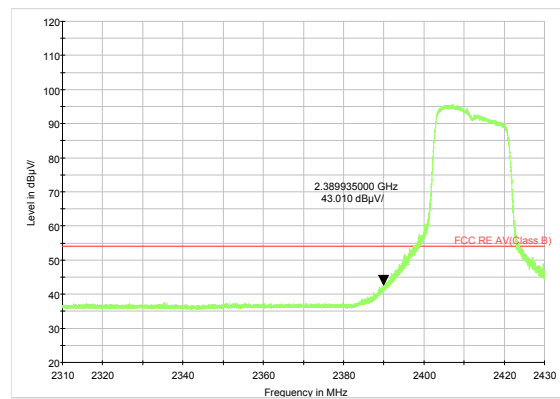

802.11n HT20 -Channel 1 Average

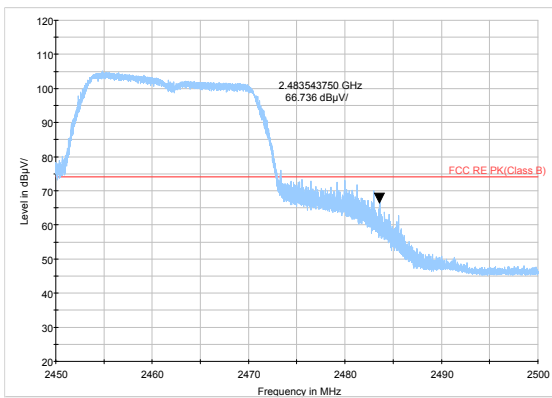

802.11n HT20 -Channel 11 Peak

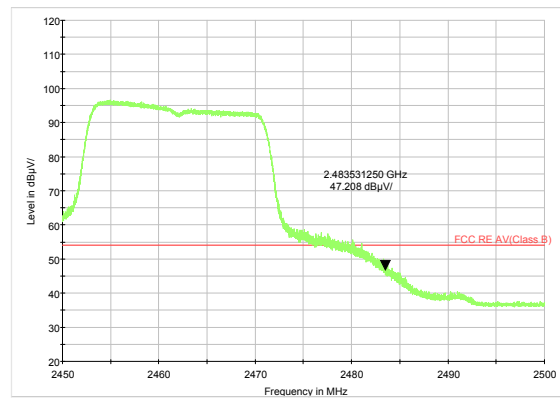

802.11n HT20 -Channel 11 Average



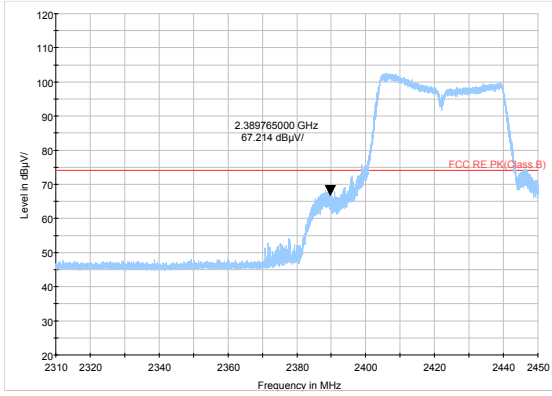

802.11n HT40 -Channel 3 Peak

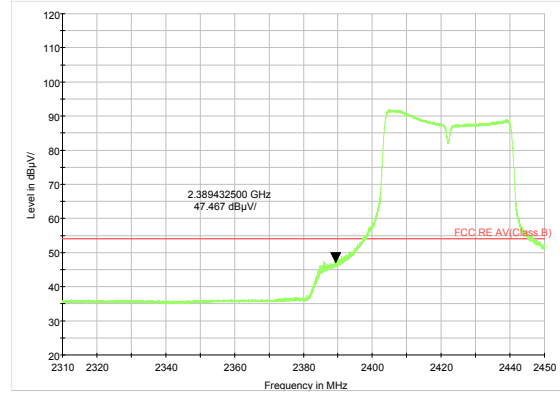

802.11n HT40 -Channel 3 Average

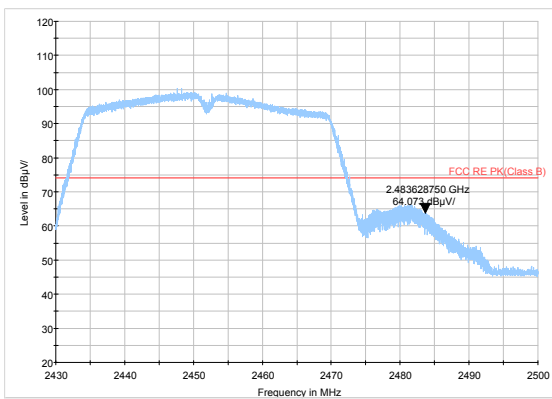

802.11n HT40 -Channel 9 Peak

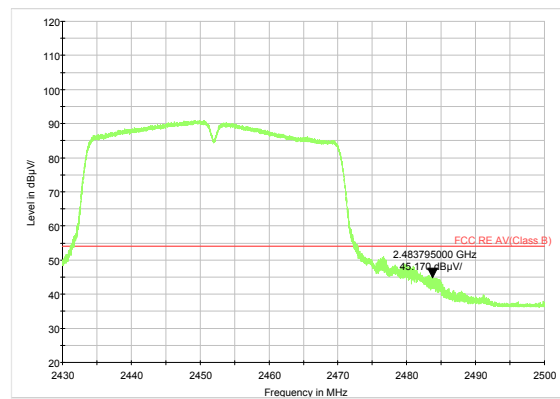

802.11n HT40 -Channel 9 Average

## Result of RE

### Test result

Sweep the whole frequency band through the range from 9kHz to the 10th harmonic of the carrier, the Emissions in the frequency band 9kHz-30MHz and 18GHz-26.5GHz are more than 20dB below the limit are not reported.

The following graphs display the maximum values of horizontal and vertical by software. For above 1GHz, Blue trace uses the peak detection, Green trace uses the average detection.

During the test, the Radiates Emission from 30MHz to 1GHz was performed in all modes with all channels, 802.11b, Channel 1 are selected as the worst condition. The test data of the worst-case condition was recorded in this report.

### Continuous TX mode:

FCC RE 9K-90KHz AV

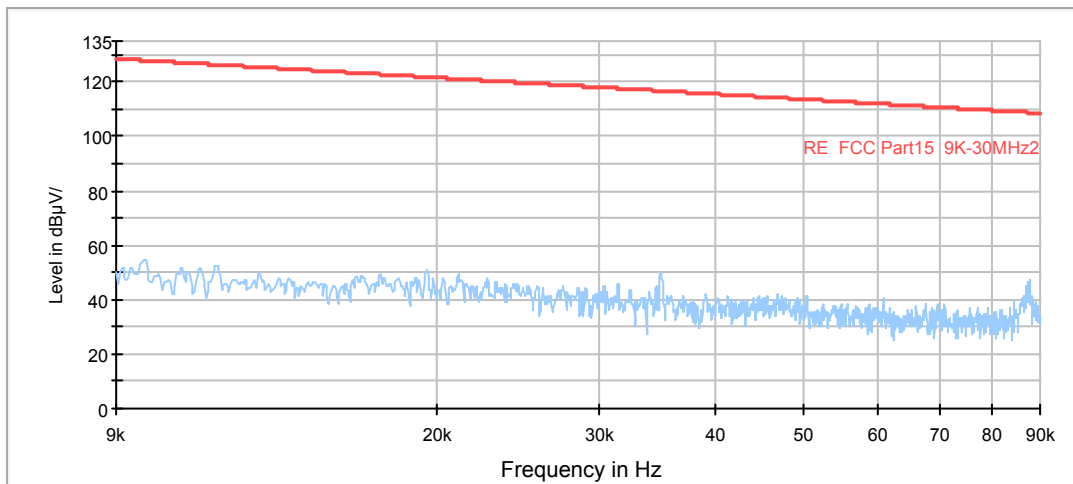

Radiates Emission from 9KHz to 90KHz

FCC RE 90K-110KHz QP

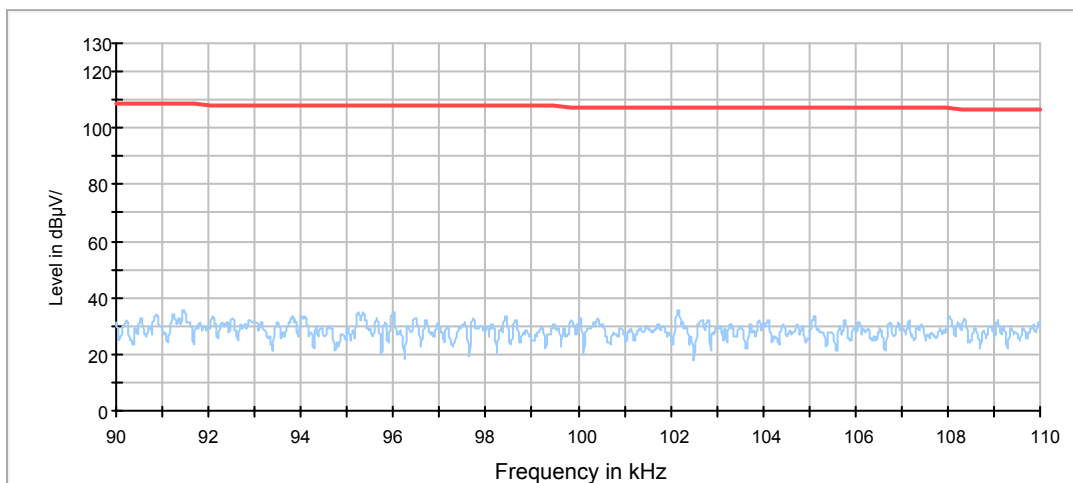

Radiates Emission from 90KHz to 110KHz

FCC RE 110K-490KHz AV

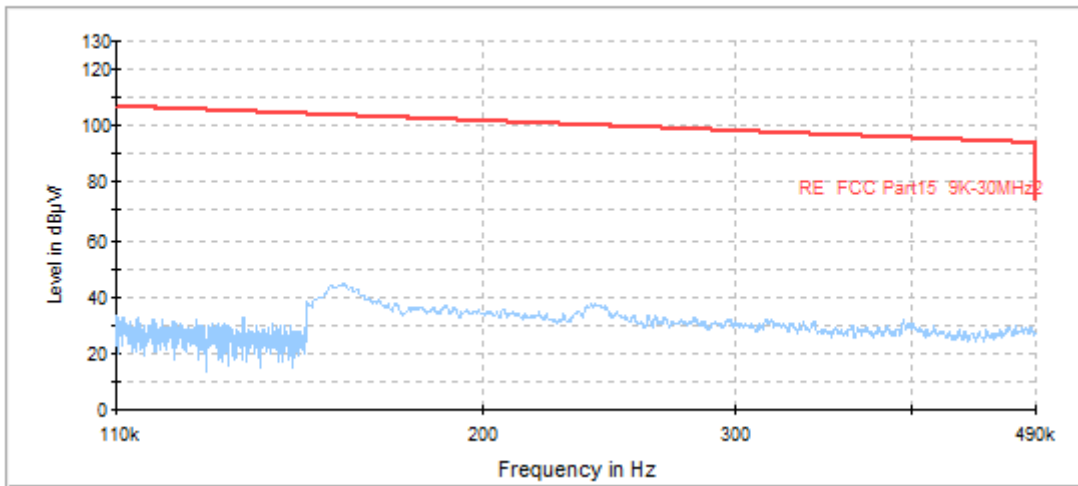

Radiates Emission from 110KHz to 490KHz

FCC RE 490K-30MHz QP

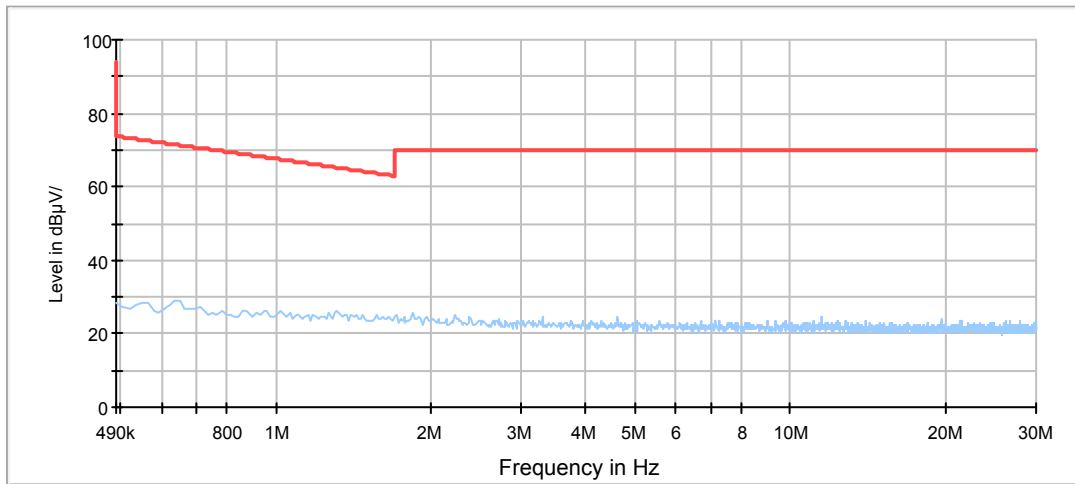

Radiates Emission from 490KHz to 30MHz

RE 30M-1GHz QP

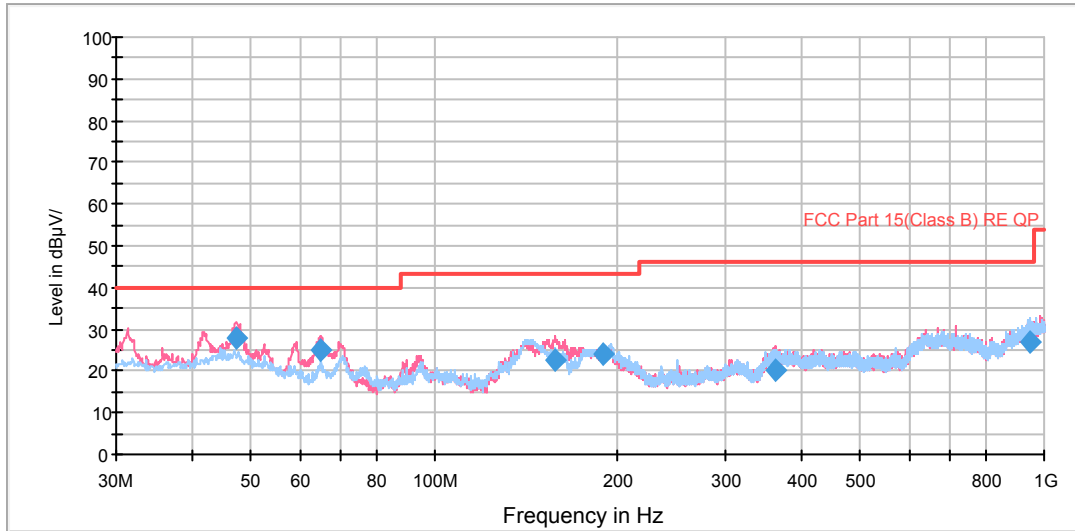

Radiates Emission from 30MHz to 1GHz

Frequency (MHz)	Quasi-Peak (dBuV/m)	Height (cm)	Polarization	Azimuth (deg)	Correct Factor (dB)	Margin (dB)	Limit (dBuV/m)
47.307835	27.9	100.0	V	235.0	-4.6	12.1	40.0
64.860942	25.2	100.0	V	315.0	-11.4	14.8	40.0
157.824355	22.7	100.0	V	9.0	-14.4	20.8	43.5
188.969245	23.8	100.0	H	272.0	-11.9	19.7	43.5
361.305500	20.0	175.0	V	324.0	-5.5	26.0	46.0
948.764500	26.9	175.0	H	138.0	1.9	19.1	46.0

- Remark: 1. Correction Factor = Antenna factor+ Insertion loss(cable loss+amplifier gain)**  
**2. Margin = Limit – Quasi-Peak**

802.11b CH1

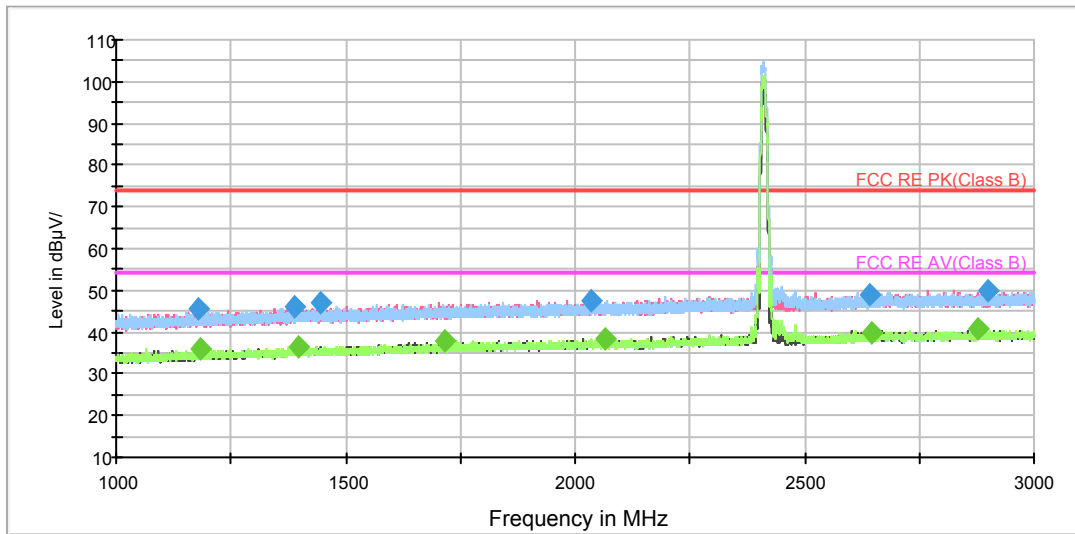

Note: The signal beyond the limit is carrier.  
Radiates Emission from 1GHz to 3GHz

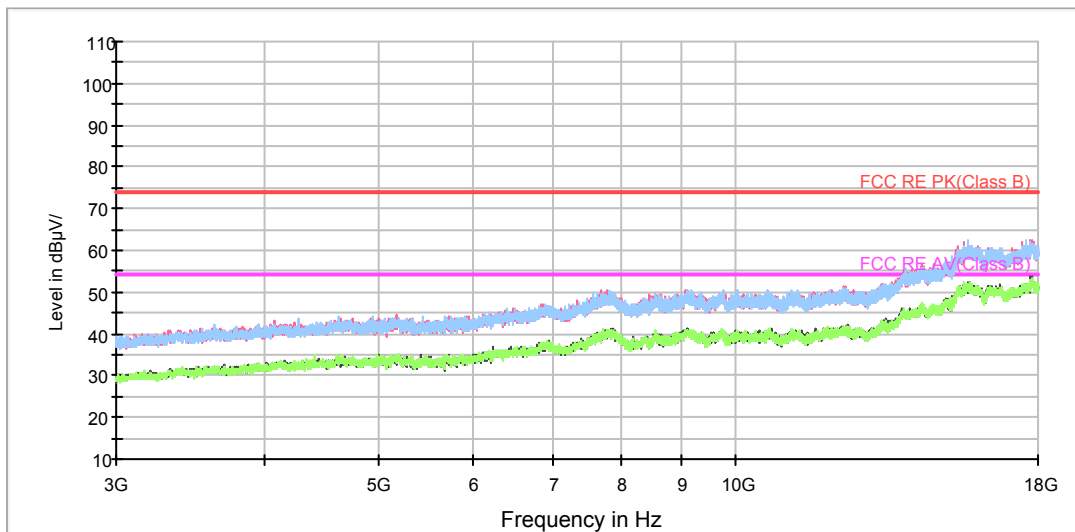

Radiates Emission from 3GHz to 18GHz



Frequency (MHz)	Peak (dBuV/m)	Height (cm)	Polarization	Azimuth (deg)	Correct Factor (dB)	Margin (dB)	Limit (dBuV/m)
1178.875000	45.5	100.0	H	56.0	0.1	28.5	74.0
1389.375000	46.0	100.0	V	216.0	1.2	28.0	74.0
1444.500000	47.1	200.0	V	306.0	1.4	26.9	74.0
2036.500000	47.7	200.0	H	327.0	3.7	26.3	74.0
2643.500000	48.9	100.0	V	297.0	6.2	25.1	74.0
2899.375000	49.9	100.0	V	311.0	7.0	24.1	74.0

**Remark: 1. Correction Factor = Antenna factor+ Insertion loss (cable loss + amplifier gain)**

Frequency (MHz)	Average (dBuV/m)	Height (cm)	Polarization	Azimuth (deg)	Correct Factor (dB)	Margin (dB)	Limit (dBuV/m)
1181.375000	36.1	200.0	V	149.0	0.1	17.9	54.0
1395.625000	36.6	200.0	H	58.0	1.2	17.4	54.0
1714.500000	37.7	200.0	V	211.0	2.3	16.3	54.0
2066.750000	38.4	200.0	H	9.0	3.7	15.6	54.0
2648.250000	39.8	200.0	V	61.0	6.3	14.2	54.0
2879.875000	40.7	200.0	V	20.0	7.0	13.3	54.0

**Remark: 1. Correction Factor = Antenna factor+ Insertion loss (cable loss + amplifier gain)**

802.11b CH6

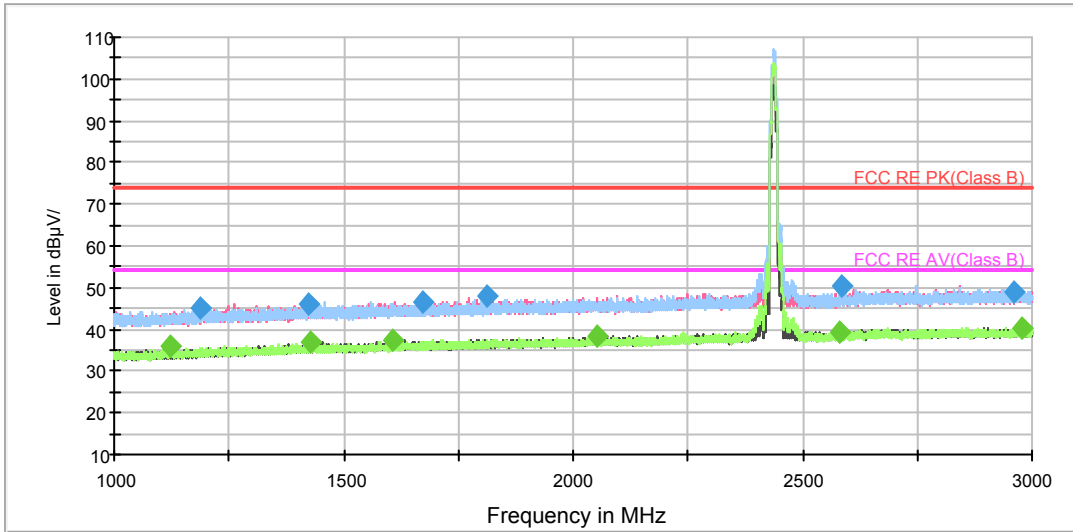

Note: The signal beyond the limit is carrier.  
Radiates Emission from 1GHz to 3GHz

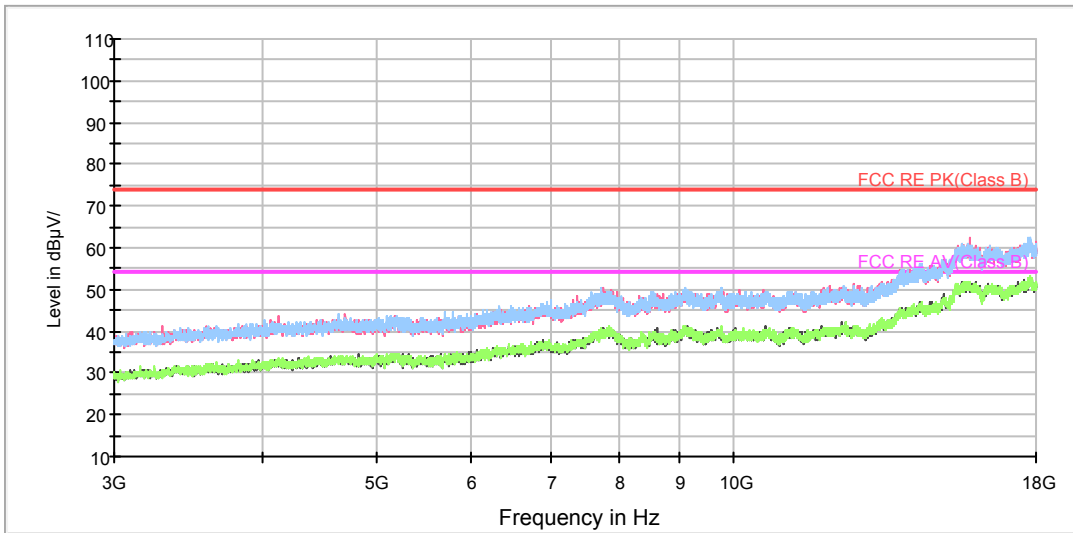

Radiates Emission from 3GHz to 18GHz



Frequency (MHz)	Peak (dBuV/m)	Height (cm)	Polarization	Azimuth (deg)	Correct Factor (dB)	Margin (dB)	Limit (dBuV/m)
1188.875000	45.1	100.0	H	352.0	0.2	28.9	74.0
1423.625000	46.2	100.0	V	275.0	1.4	27.8	74.0
1672.125000	46.7	100.0	H	48.0	2.2	27.3	74.0
1812.375000	47.8	100.0	H	311.0	2.8	26.2	74.0
2584.250000	50.2	100.0	H	183.0	5.9	23.8	74.0
2962.375000	48.8	100.0	H	254.0	7.3	25.2	74.0

Remark: 1. Correction Factor = Antenna factor+ Insertion loss (cable loss + amplifier gain)

Frequency (MHz)	Average (dBuV/m)	Height (cm)	Polarization	Azimuth (deg)	Correct Factor (dB)	Margin (dB)	Limit (dBuV/m)
1123.125000	35.8	100.0	H	54.0	-0.3	18.2	54.0
1426.625000	36.7	100.0	V	344.0	1.4	17.3	54.0
1608.000000	37.5	200.0	H	212.0	1.9	16.5	54.0
2051.250000	38.2	200.0	H	335.0	3.7	15.8	54.0
2580.500000	39.4	100.0	H	142.0	5.9	14.6	54.0
2977.125000	40.5	100.0	H	41.0	7.4	13.5	54.0

Remark: 1. Correction Factor = Antenna factor+ Insertion loss (cable loss + amplifier gain)



802.11b CH11

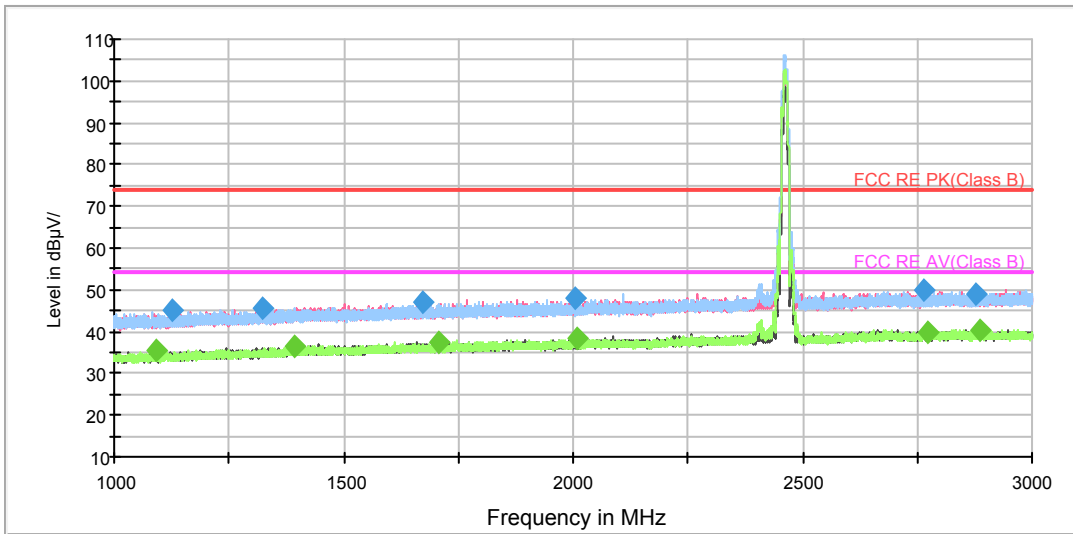

Note: The signal beyond the limit is carrier.  
Radiates Emission from 1GHz to 3GHz

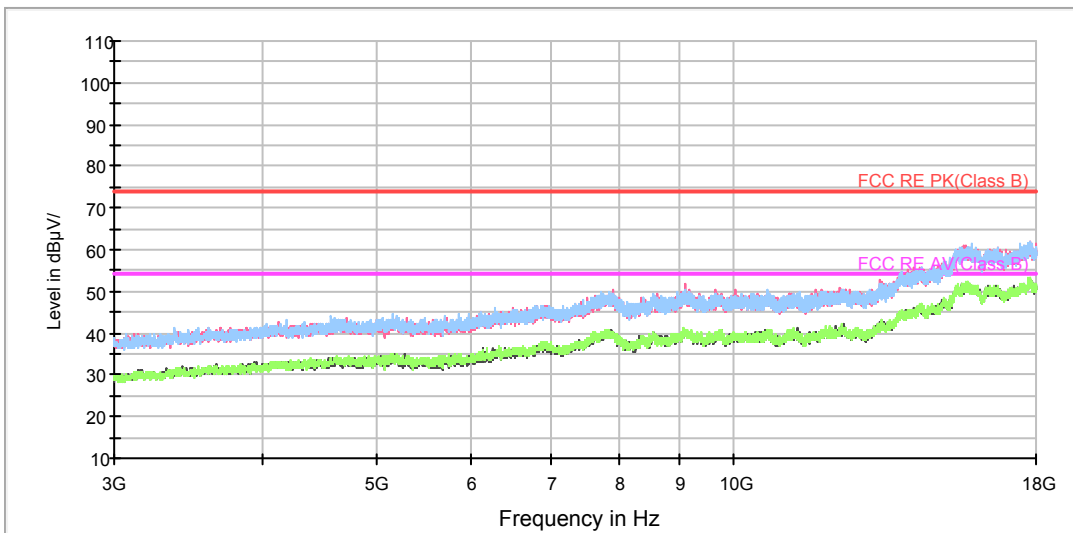

Radiates Emission from 3GHz to 18GHz



Frequency (MHz)	Peak (dBuV/m)	Height (cm)	Polarization	Azimuth (deg)	Correct Factor (dB)	Margin (dB)	Limit (dBuV/m)
1128.750000	44.9	200.0	V	176.0	-0.3	29.1	74.0
1322.375000	45.7	100.0	H	93.0	0.7	28.3	74.0
1671.000000	46.8	200.0	V	51.0	2.2	27.2	74.0
2002.500000	47.8	200.0	V	182.0	3.5	26.2	74.0
2763.125000	50.0	100.0	V	0.0	6.6	24.0	74.0
2878.750000	48.8	100.0	V	225.0	7.0	25.2	74.0

Remark: 1. Correction Factor = Antenna factor+ Insertion loss (cable loss + amplifier gain)

Frequency (MHz)	Average (dBuV/m)	Height (cm)	Polarization	Azimuth (deg)	Correct Factor (dB)	Margin (dB)	Limit (dBuV/m)
1092.625000	35.7	200.0	V	343.0	-0.6	18.3	54.0
1391.250000	36.6	100.0	V	135.0	1.2	17.4	54.0
1706.375000	37.4	100.0	V	99.0	2.3	16.6	54.0
2008.750000	38.3	100.0	V	341.0	3.6	15.7	54.0
2772.375000	39.8	100.0	V	128.0	6.7	14.2	54.0
2886.000000	40.5	200.0	V	25.0	7.0	13.5	54.0

Remark: 1. Correction Factor = Antenna factor+ Insertion loss (cable loss + amplifier gain)

802.11g CH1

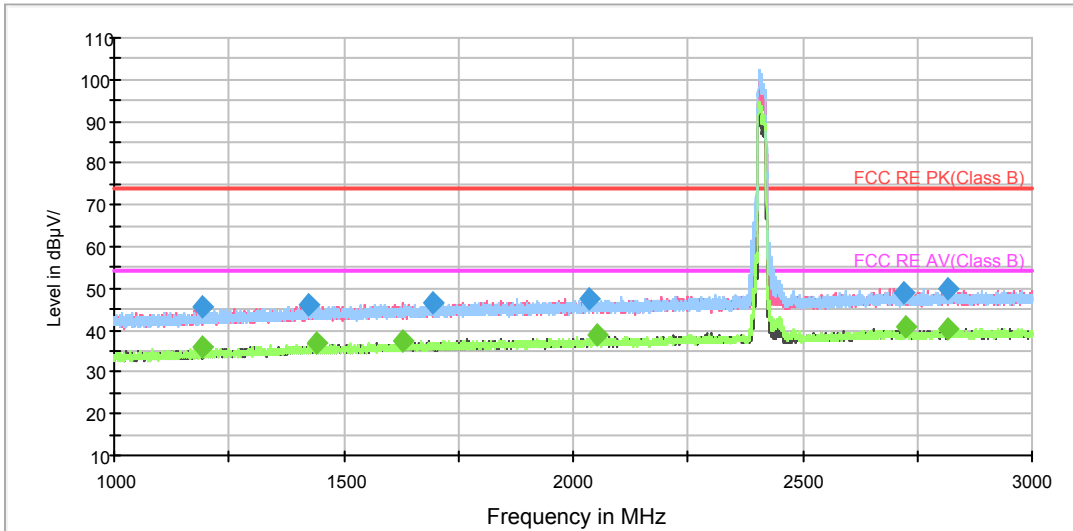

Note: The signal beyond the limit is carrier.  
Radiates Emission from 1GHz to 3GHz

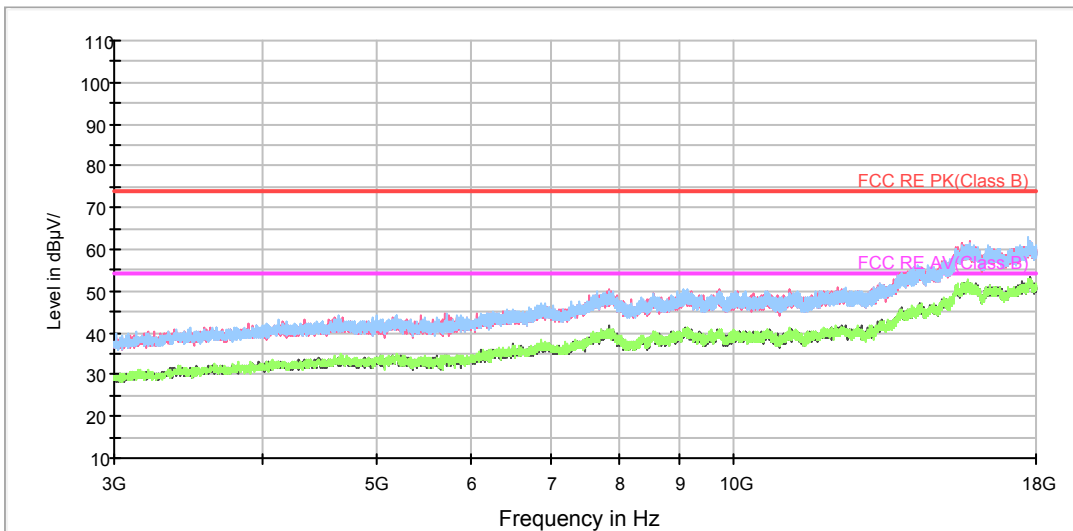

Radiates Emission from 3GHz to 18GHz



Frequency (MHz)	Peak (dBuV/m)	Height (cm)	Polarization	Azimuth (deg)	Correct Factor (dB)	Margin (dB)	Limit (dBuV/m)
1192.250000	45.4	200.0	H	0.0	0.2	28.6	74.0
1422.625000	45.8	200.0	H	247.0	1.4	28.2	74.0
1693.250000	46.5	200.0	V	22.0	2.3	27.5	74.0
2035.375000	47.4	100.0	V	4.0	3.7	26.6	74.0
2720.375000	48.8	100.0	V	338.0	6.5	25.2	74.0
2816.875000	49.9	200.0	H	171.0	6.9	24.1	74.0

**Remark: 1. Correction Factor = Antenna factor+ Insertion loss (cable loss + amplifier gain)**

Frequency (MHz)	Average (dBuV/m)	Height (cm)	Polarization	Azimuth (deg)	Correct Factor (dB)	Margin (dB)	Limit (dBuV/m)
1192.125000	35.8	100.0	V	331.0	0.2	18.2	54.0
1441.000000	36.7	200.0	V	52.0	1.4	17.3	54.0
1628.125000	37.4	200.0	V	52.0	2.1	16.6	54.0
2051.625000	39.1	100.0	H	16.0	3.7	14.9	54.0
2727.000000	40.5	100.0	H	137.0	6.4	13.5	54.0
2818.500000	40.5	100.0	V	87.0	6.9	13.5	54.0

**Remark: 1. Correction Factor = Antenna factor+ Insertion loss (cable loss + amplifier gain)**

802.11g CH6

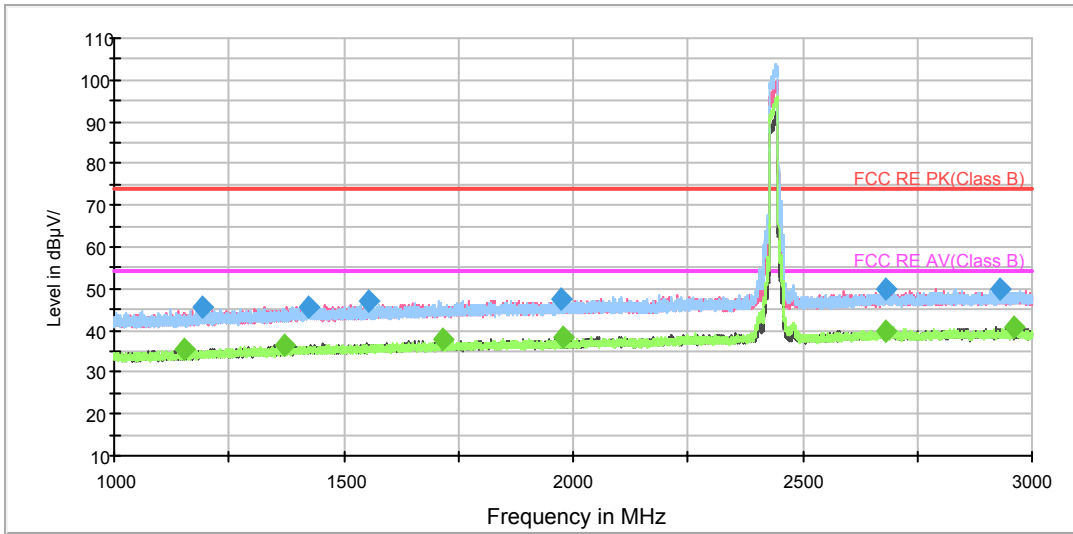

Note: The signal beyond the limit is carrier.  
Radiates Emission from 1GHz to 3GHz

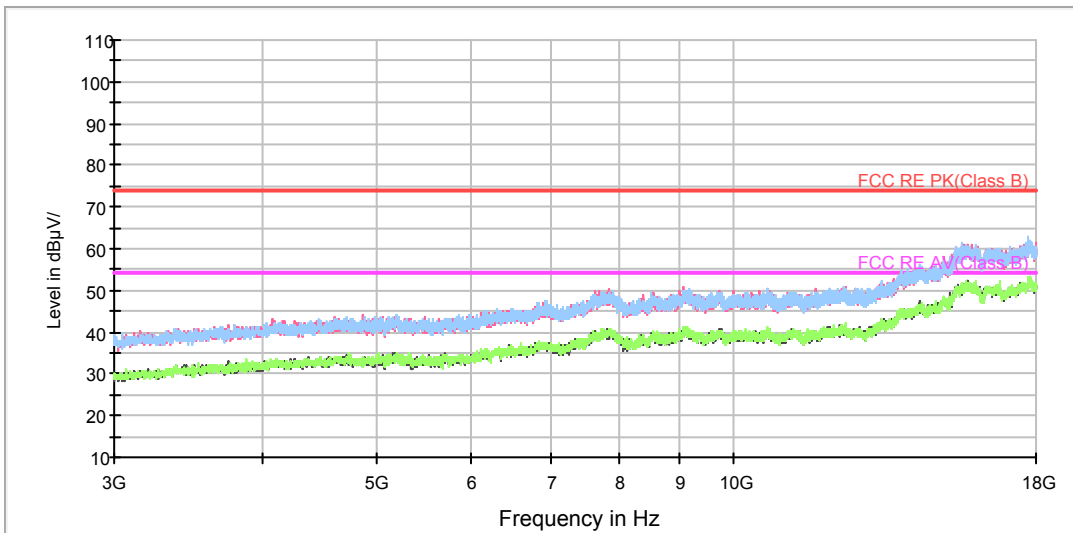

Radiates Emission from 3GHz to 18GHz



Frequency (MHz)	Peak (dBuV/m)	Height (cm)	Polarization	Azimuth (deg)	Correct Factor (dB)	Margin (dB)	Limit (dBuV/m)
1192.250000	45.5	100.0	V	0.0	0.2	28.5	74.0
1424.500000	45.7	200.0	V	46.0	1.4	28.3	74.0
1554.625000	47.2	200.0	V	261.0	1.8	26.8	74.0
1972.375000	47.6	100.0	H	251.0	3.4	26.4	74.0
2680.125000	49.7	200.0	V	12.0	6.4	24.3	74.0
2932.125000	50.1	100.0	V	269.0	7.1	23.9	74.0

Remark: 1. Correction Factor = Antenna factor+ Insertion loss (cable loss + amplifier gain)

Frequency (MHz)	Average (dBuV/m)	Height (cm)	Polarization	Azimuth (deg)	Correct Factor (dB)	Margin (dB)	Limit (dBuV/m)
1154.750000	35.5	200.0	V	116.0	-0.1	18.5	54.0
1370.375000	36.6	200.0	V	46.0	1.0	17.4	54.0
1714.375000	37.7	100.0	H	63.0	2.3	16.3	54.0
1976.000000	38.5	200.0	H	191.0	3.5	15.5	54.0
2680.000000	39.9	100.0	V	332.0	6.4	14.1	54.0
2959.875000	40.9	200.0	H	301.0	7.3	13.1	54.0

Remark: 1. Correction Factor = Antenna factor+ Insertion loss (cable loss + amplifier gain)

802.11g CH11

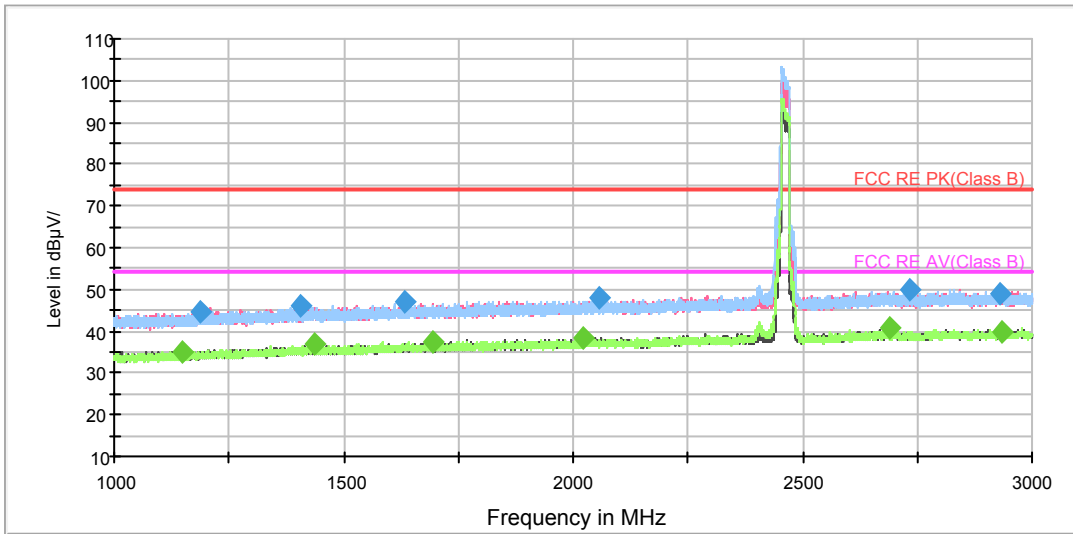

Note: The signal beyond the limit is carrier.  
Radiates Emission from 1GHz to 3GHz

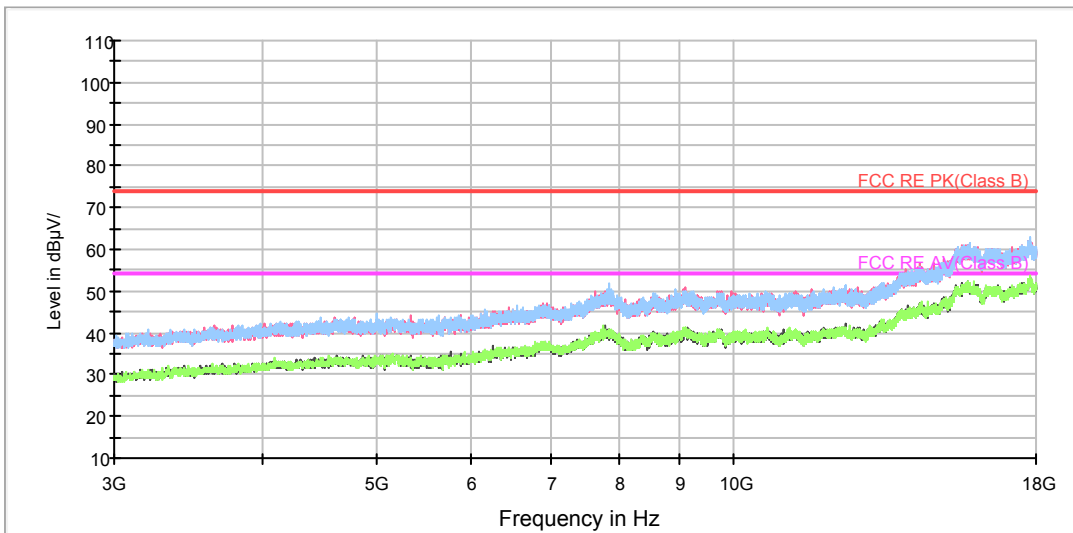

Radiates Emission from 3GHz to 18GHz



Frequency (MHz)	Peak (dBuV/m)	Height (cm)	Polarization	Azimuth (deg)	Correct Factor (dB)	Margin (dB)	Limit (dBuV/m)
1189.750000	44.7	200.0	V	224.0	0.2	29.3	74.0
1405.000000	46.2	200.0	V	168.0	1.3	27.8	74.0
1632.875000	47.2	200.0	V	114.0	2.1	26.8	74.0
2054.875000	47.8	100.0	V	39.0	3.7	26.2	74.0
2734.875000	49.9	200.0	H	161.0	6.4	24.1	74.0
2930.000000	49.1	200.0	V	114.0	7.1	24.9	74.0

Remark: 1. Correction Factor = Antenna factor+ Insertion loss (cable loss + amplifier gain)

Frequency (MHz)	Average (dBuV/m)	Height (cm)	Polarization	Azimuth (deg)	Correct Factor (dB)	Margin (dB)	Limit (dBuV/m)
1146.375000	35.1	200.0	H	345.0	-0.1	18.9	54.0
1434.625000	36.9	100.0	V	338.0	1.5	17.1	54.0
1693.375000	37.3	200.0	V	280.0	2.3	16.7	54.0
2020.500000	38.2	200.0	V	53.0	3.6	15.8	54.0
2689.625000	40.9	100.0	H	325.0	6.5	13.1	54.0
2932.375000	39.8	100.0	V	0.0	7.1	14.2	54.0

Remark: 1. Correction Factor = Antenna factor+ Insertion loss (cable loss + amplifier gain)



802.11n (HT20) CH1

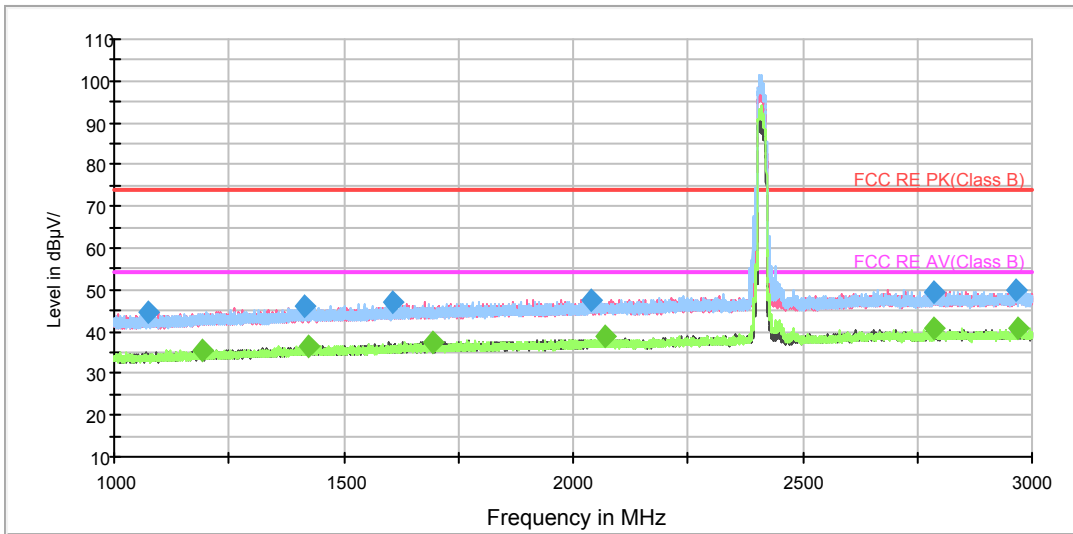

Note: The signal beyond the limit is carrier.  
Radiates Emission from 1GHz to 3GHz

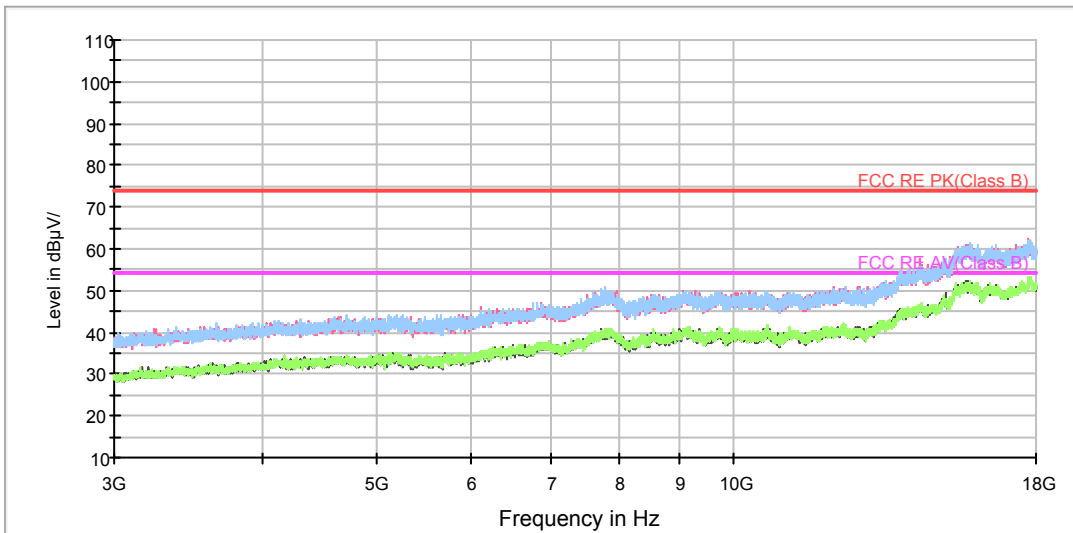

Radiates Emission from 3GHz to 18GHz



Frequency (MHz)	Peak (dBuV/m)	Height (cm)	Polarization	Azimuth (deg)	Correct Factor (dB)	Margin (dB)	Limit (dBuV/m)
1073.750000	44.8	200.0	V	86.0	-0.7	29.2	74.0
1415.250000	46.0	200.0	V	113.0	1.4	28.0	74.0
1606.875000	47.2	200.0	V	216.0	1.9	26.8	74.0
2041.250000	47.5	100.0	V	23.0	3.7	26.5	74.0
2785.750000	49.4	100.0	V	119.0	6.8	24.6	74.0
2964.750000	50.1	100.0	H	114.0	7.3	23.9	74.0

**Remark: 1. Correction Factor = Antenna factor+ Insertion loss (cable loss + amplifier gain)**

Frequency (MHz)	Average (dBuV/m)	Height (cm)	Polarization	Azimuth (deg)	Correct Factor (dB)	Margin (dB)	Limit (dBuV/m)
1194.250000	35.6	200.0	H	187.0	0.1	18.4	54.0
1423.125000	36.6	200.0	V	189.0	1.4	17.4	54.0
1695.875000	37.5	200.0	H	82.0	2.3	16.5	54.0
2069.375000	38.7	200.0	V	140.0	3.7	15.3	54.0
2786.875000	40.7	100.0	H	127.0	6.8	13.3	54.0
2971.250000	40.6	200.0	V	286.0	7.4	13.4	54.0

**Remark: 1. Correction Factor = Antenna factor+ Insertion loss (cable loss + amplifier gain)**

802.11n (HT20) CH6

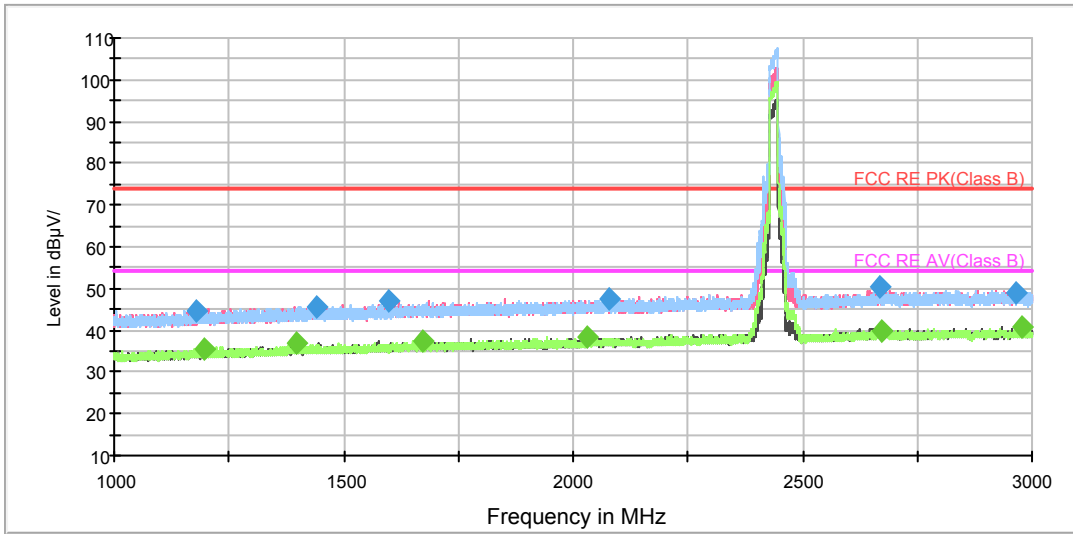

Note: The signal beyond the limit is carrier.  
Radiates Emission from 1GHz to 3GHz

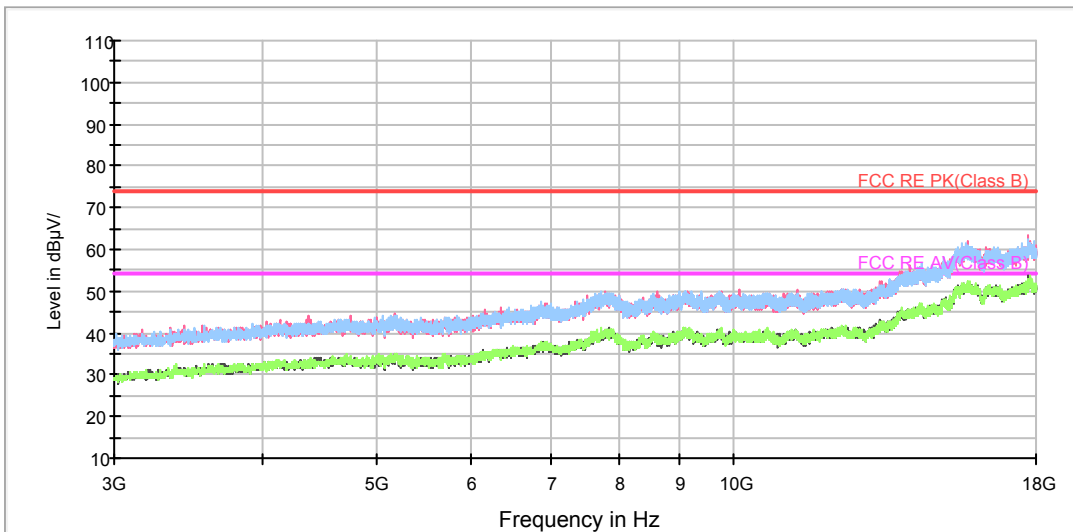

Radiates Emission from 3GHz to 18GHz



Frequency (MHz)	Peak (dBuV/m)	Height (cm)	Polarization	Azimuth (deg)	Correct Factor (dB)	Margin (dB)	Limit (dBuV/m)
1177.375000	44.7	200.0	H	246.0	0.1	29.3	74.0
1439.875000	45.8	100.0	H	170.0	1.4	28.2	74.0
1597.875000	47.1	200.0	V	167.0	1.9	26.9	74.0
2076.625000	47.4	100.0	V	163.0	3.7	26.6	74.0
2666.250000	50.1	100.0	V	316.0	6.4	23.9	74.0
2966.125000	48.7	200.0	V	38.0	7.3	25.3	74.0

Remark: 1. Correction Factor = Antenna factor+ Insertion loss (cable loss + amplifier gain)

Frequency (MHz)	Average (dBuV/m)	Height (cm)	Polarization	Azimuth (deg)	Correct Factor (dB)	Margin (dB)	Limit (dBuV/m)
1197.375000	35.6	200.0	V	215.0	0.1	18.4	54.0
1395.625000	37.1	200.0	V	215.0	1.2	16.9	54.0
1671.750000	37.4	100.0	V	135.0	2.2	16.6	54.0
2031.875000	38.3	100.0	V	282.0	3.6	15.7	54.0
2670.875000	39.8	200.0	V	18.0	6.4	14.2	54.0
2979.625000	40.7	100.0	H	111.0	7.4	13.3	54.0

Remark: 1. Correction Factor = Antenna factor+ Insertion loss (cable loss + amplifier gain)

802.11n (HT20) CH11

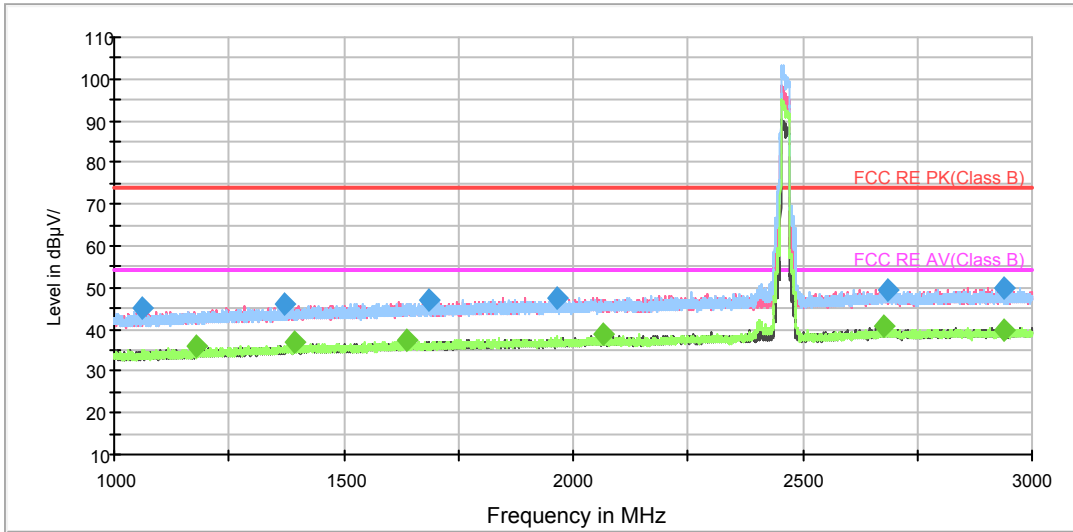

Note: The signal beyond the limit is carrier.  
Radiates Emission from 1GHz to 3GHz

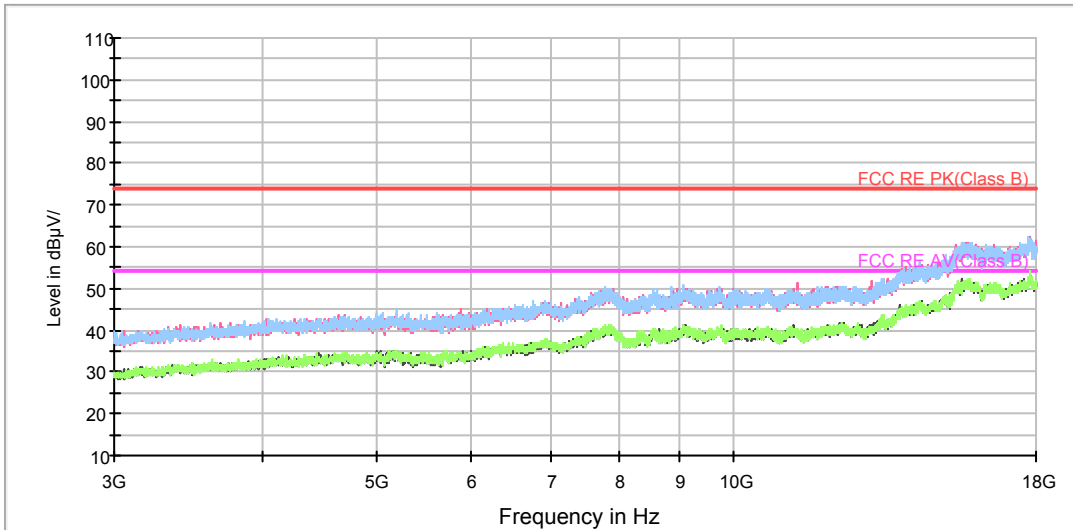

Radiates Emission from 3GHz to 18GHz



Frequency (MHz)	Peak (dBuV/m)	Height (cm)	Polarization	Azimuth (deg)	Correct Factor (dB)	Margin (dB)	Limit (dBuV/m)
1061.375000	45.2	200.0	V	20.0	-0.8	28.8	74.0
1373.000000	46.3	200.0	V	27.0	1.0	27.7	74.0
1686.000000	47.1	100.0	V	96.0	2.3	26.9	74.0
1963.250000	47.7	100.0	V	72.0	3.4	26.3	74.0
2686.000000	49.4	100.0	H	62.0	6.4	24.6	74.0
2940.500000	50.1	200.0	V	198.0	7.2	23.9	74.0

Remark: 1. Correction Factor = Antenna factor+ Insertion loss (cable loss + amplifier gain)

Frequency (MHz)	Average (dBuV/m)	Height (cm)	Polarization	Azimuth (deg)	Correct Factor (dB)	Margin (dB)	Limit (dBuV/m)
1180.375000	36.0	100.0	V	0.0	0.1	18.0	54.0
1393.875000	36.7	200.0	V	100.0	1.2	17.3	54.0
1637.625000	37.2	200.0	H	354.0	2.1	16.8	54.0
2064.250000	38.6	100.0	V	331.0	3.7	15.4	54.0
2676.625000	40.5	200.0	H	334.0	6.4	13.5	54.0
2937.250000	39.9	100.0	V	268.0	7.2	14.1	54.0

Remark: 1. Correction Factor = Antenna factor+ Insertion loss (cable loss + amplifier gain)

802.11n (HT40) CH3

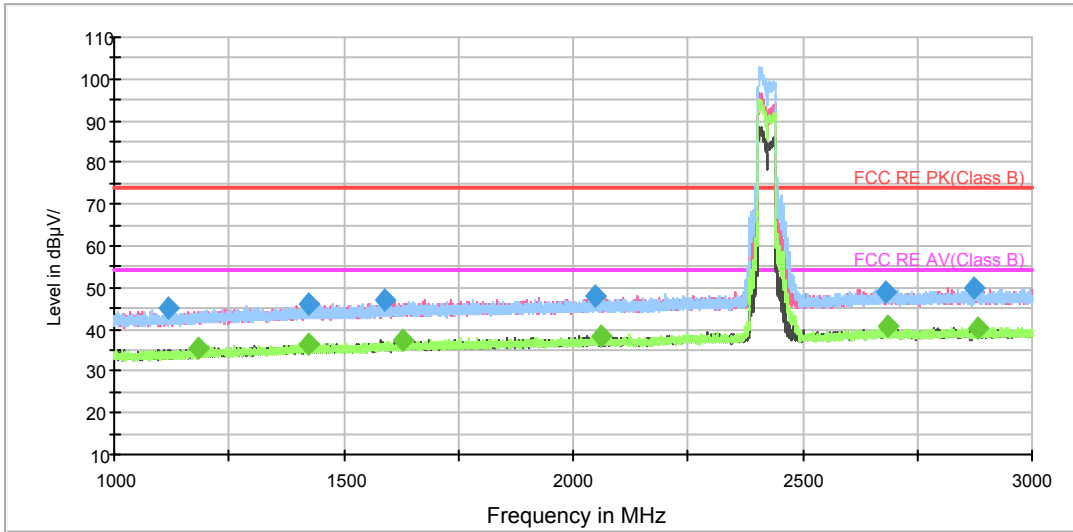

Note: The signal beyond the limit is carrier.  
Radiates Emission from 1GHz to 3GHz

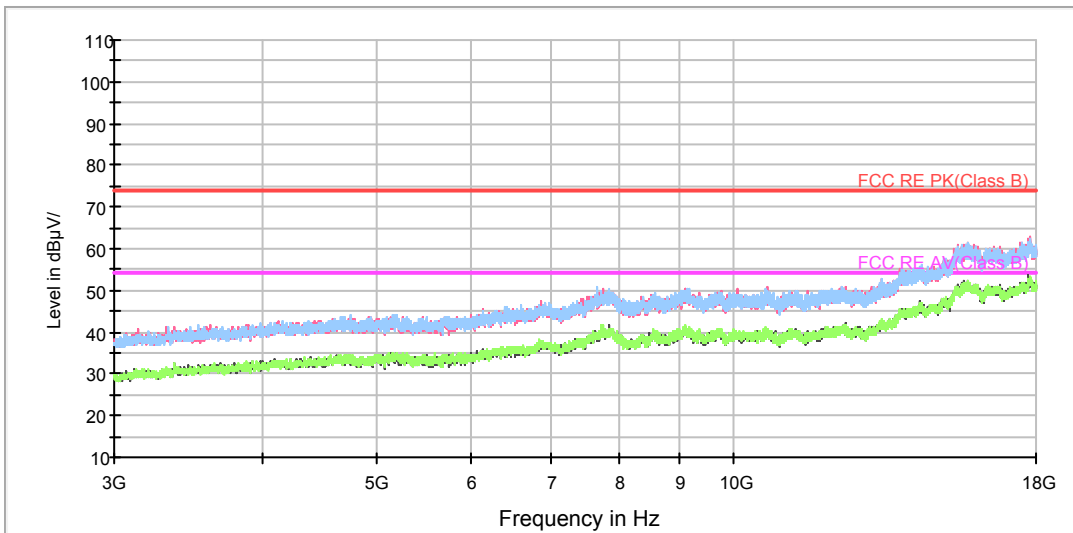

Radiates Emission from 3GHz to 18GHz



Frequency (MHz)	Peak (dBuV/m)	Height (cm)	Polarization	Azimuth (deg)	Correct Factor (dB)	Margin (dB)	Limit (dBuV/m)
1117.625000	45.3	100.0	H	192.0	-0.4	28.7	74.0
1424.000000	46.0	200.0	H	294.0	1.4	28.0	74.0
1587.625000	46.9	100.0	H	184.0	1.9	27.1	74.0
2049.000000	48.0	100.0	V	0.0	3.7	26.0	74.0
2680.625000	48.9	200.0	H	354.0	6.4	25.1	74.0
2872.625000	50.1	100.0	V	281.0	7.0	23.9	74.0

Remark: 1. Correction Factor = Antenna factor+ Insertion loss (cable loss + amplifier gain)

Frequency (MHz)	Average (dBuV/m)	Height (cm)	Polarization	Azimuth (deg)	Correct Factor (dB)	Margin (dB)	Limit (dBuV/m)
1182.875000	35.6	200.0	H	0.0	0.2	18.4	54.0
1425.375000	36.5	200.0	V	99.0	1.4	17.5	54.0
1629.250000	37.6	100.0	H	240.0	2.1	16.4	54.0
2062.875000	38.3	100.0	H	19.0	3.7	15.7	54.0
2686.375000	40.7	100.0	H	108.0	6.4	13.3	54.0
2880.125000	40.4	100.0	V	73.0	7.0	13.6	54.0

Remark: 1. Correction Factor = Antenna factor+ Insertion loss (cable loss + amplifier gain)



802.11n (HT40) CH6

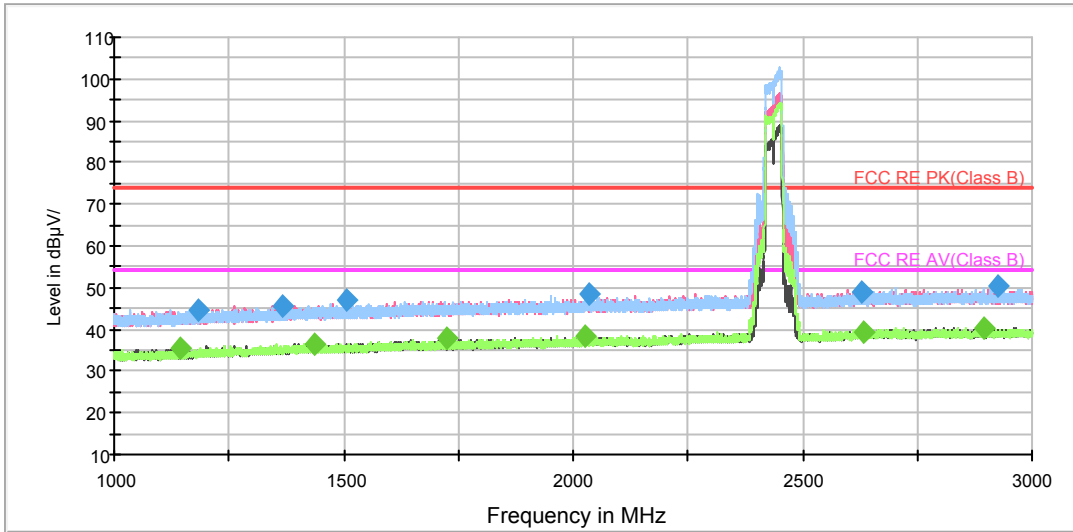

Note: The signal beyond the limit is carrier.  
Radiates Emission from 1GHz to 3GHz

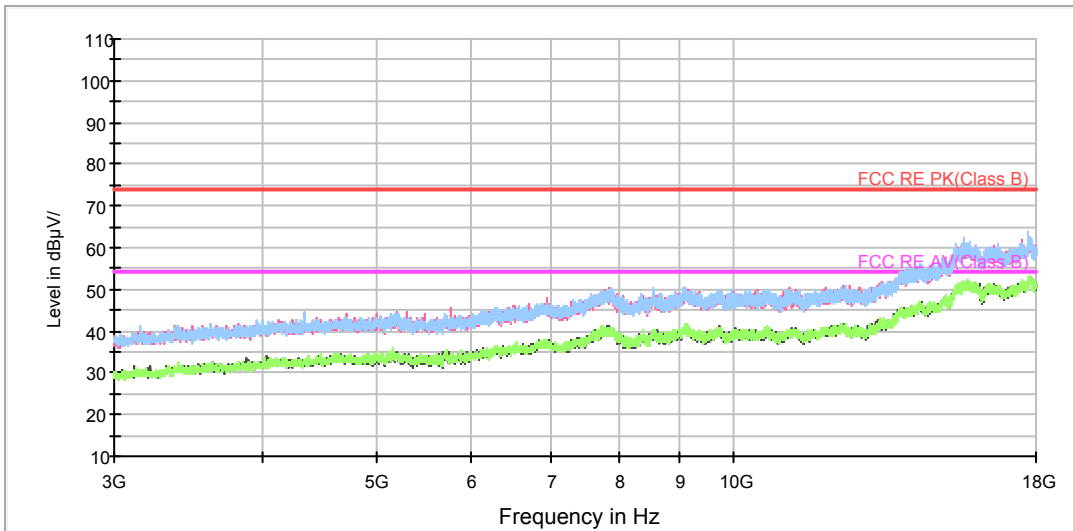

Radiates Emission from 3GHz to 18GHz



Frequency (MHz)	Peak (dBuV/m)	Height (cm)	Polarization	Azimuth (deg)	Correct Factor (dB)	Margin (dB)	Limit (dBuV/m)
1181.250000	44.7	200.0	V	78.0	0.1	29.3	74.0
1368.500000	45.7	200.0	H	163.0	1.0	28.3	74.0
1506.125000	47.0	200.0	V	175.0	1.6	27.0	74.0
2033.375000	48.4	100.0	H	140.0	3.7	25.6	74.0
2627.750000	49.0	100.0	V	0.0	6.1	25.0	74.0
2924.000000	50.2	100.0	H	0.0	7.1	23.8	74.0

Remark: 1. Correction Factor = Antenna factor+ Insertion loss (cable loss + amplifier gain)

Frequency (MHz)	Average (dBuV/m)	Height (cm)	Polarization	Azimuth (deg)	Correct Factor (dB)	Margin (dB)	Limit (dBuV/m)
1145.625000	35.6	200.0	H	1.0	-0.1	18.4	54.0
1437.625000	36.6	100.0	H	244.0	1.4	17.4	54.0
1725.625000	37.8	200.0	H	65.0	2.4	16.2	54.0
2025.875000	38.3	100.0	V	141.0	3.6	15.7	54.0
2632.375000	39.2	200.0	V	120.0	6.1	14.8	54.0
2895.125000	40.5	200.0	V	78.0	7.0	13.5	54.0

Remark: 1. Correction Factor = Antenna factor+ Insertion loss (cable loss + amplifier gain)

802.11n (HT40) CH9

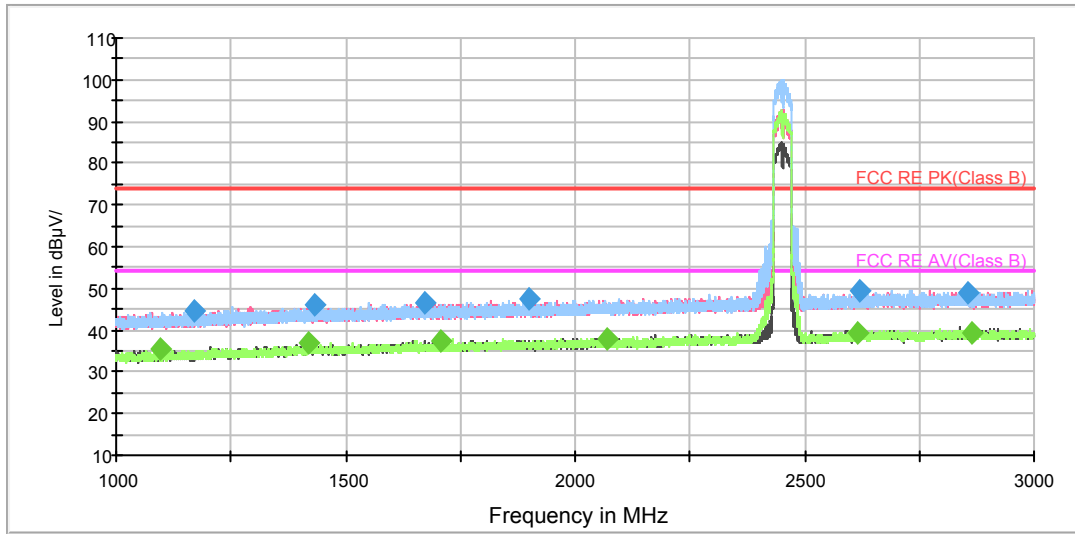

Note: The signal beyond the limit is carrier.  
Radiates Emission from 1GHz to 3GHz

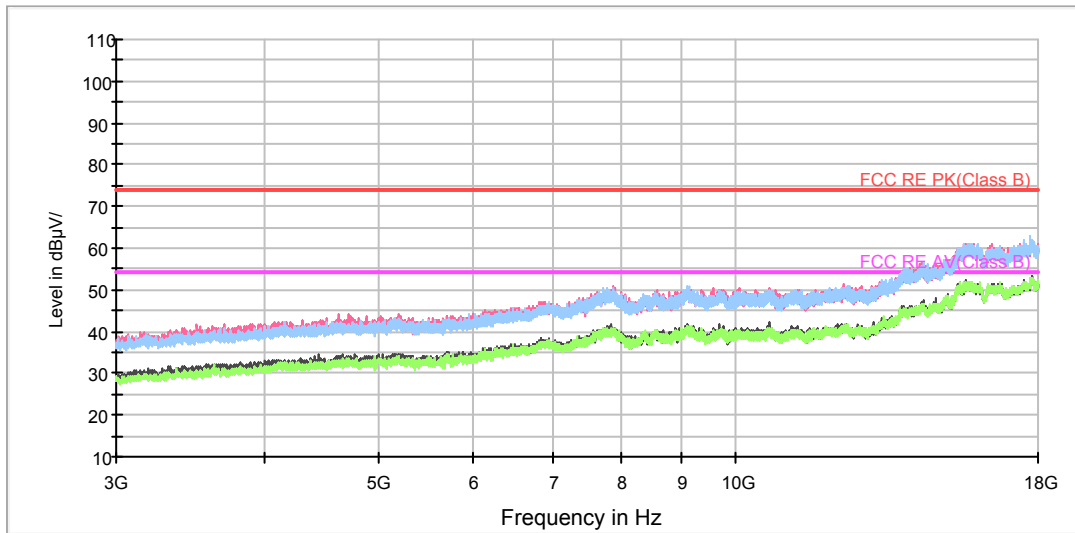

Radiates Emission from 3GHz to 18GHz



Frequency (MHz)	Peak (dBuV/m)	Height (cm)	Polarization	Azimuth (deg)	Correct Factor (dB)	Margin (dB)	Limit (dBuV/m)
1171.875000	44.7	100.0	V	0.0	0.0	29.3	74.0
1431.125000	45.9	100.0	V	200.0	1.5	28.1	74.0
1671.000000	46.5	100.0	H	48.0	2.2	27.5	74.0
1898.625000	47.3	100.0	H	1.0	3.1	26.7	74.0
2622.000000	49.5	100.0	H	0.0	6.1	24.5	74.0
2857.000000	49.0	100.0	H	261.0	6.9	25.0	74.0

Remark: 1. Correction Factor = Antenna factor+ Insertion loss (cable loss + amplifier gain)

Frequency (MHz)	Average (dBuV/m)	Height (cm)	Polarization	Azimuth (deg)	Correct Factor (dB)	Margin (dB)	Limit (dBuV/m)
1094.375000	35.4	100.0	V	275.0	-0.5	18.6	54.0
1417.250000	36.7	100.0	H	0.0	1.4	17.3	54.0
1705.625000	37.5	100.0	V	207.0	2.3	16.5	54.0
2068.500000	38.1	100.0	V	255.0	3.7	15.9	54.0
2614.000000	39.4	100.0	H	125.0	6.0	14.6	54.0
2864.125000	39.5	100.0	H	175.0	7.0	14.5	54.0

Remark: 1. Correction Factor = Antenna factor+ Insertion loss (cable loss + amplifier gain)



During the test, the Radiates Emission from 18GHz to 26.5GHz was performed in all modes with all channels, 802.11b CH1 are selected as the worst condition. The test data of the worst-case condition was recorded in this report.

RE 18-26.5GHz PK+AV

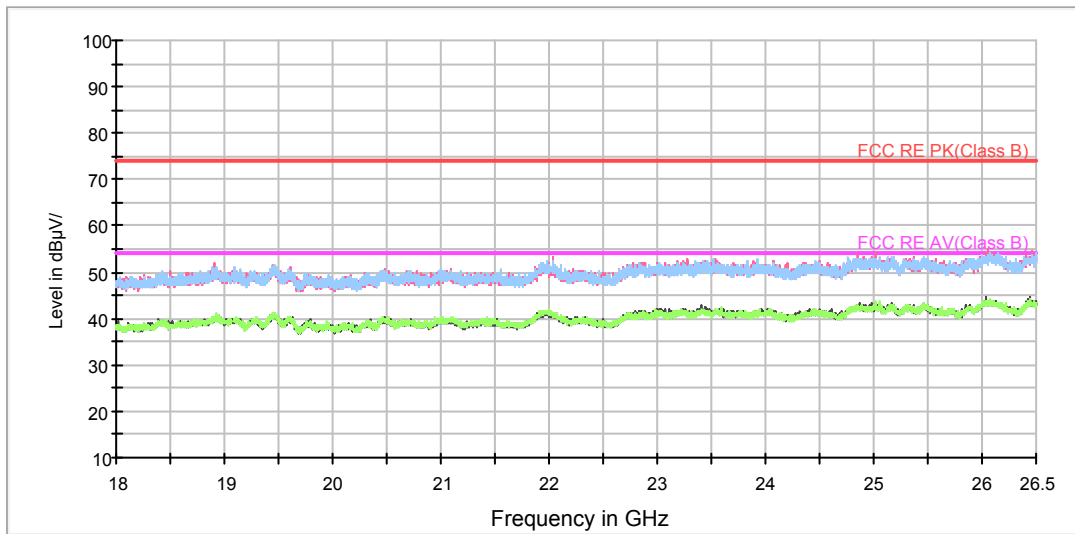

Radiates Emission from 18GHz to 26.5GHz

### 5.7. Conducted Emission

#### Ambient condition

Temperature	Relative humidity	Pressure
23°C ~25°C	45%~50%	101.5kPa

#### Methods of Measurement

The EUT is placed on a non-metallic table of 80cm height above the horizontal metal reference ground plane. During the test, the EUT was operating in its typical mode. The test method is according to ANSI C63.10-2013. Connect the AC power line of the EUT to the L.I.S.N. Use EMI receiver to detect the average and Quasi-peak value. RBW is set to 9 kHz, VBW is set to 30kHz. The measurement result should include both L line and N line.

The test is in transmitting mode.

#### Test Setup

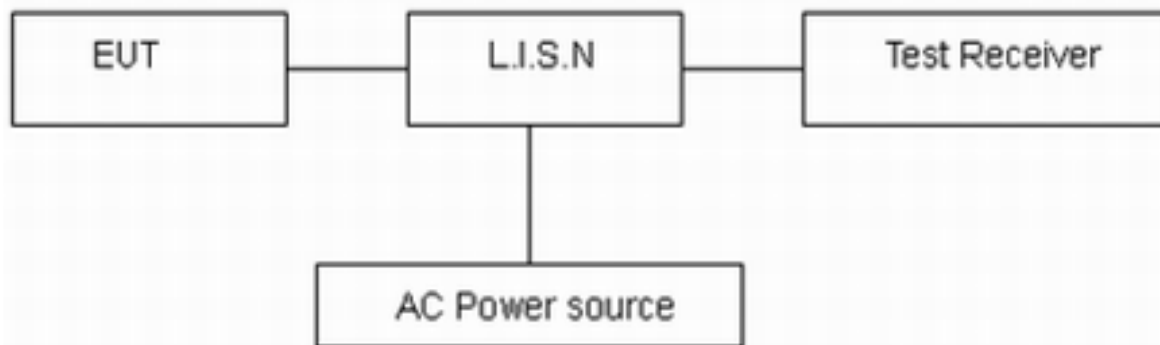

Note: AC Power source is used to change the voltage 110V/60Hz.

#### Limits

Frequency (MHz)	Conducted Limits(dBμV)	
	Quasi-peak	Average
0.15 - 0.5	66 to 56 *	56 to 46 *
0.5 - 5	56	46
5 - 30	60	50

\*: Decreases with the logarithm of the frequency.

#### Measurement Uncertainty

The assessed measurement uncertainty to ensure 95% confidence level for the normal distribution is with the coverage factor  $k = 1.96$ ,  $U = 2.69$  dB.

**Test Results:**

Following plots, Blue trace uses the peak detection and Green trace uses the average detection. During the test, the Conducted Emission was performed in all channels, 802.11b, Channel 1 are selected as the worst condition. The test data of the worst-case condition was recorded in this report.

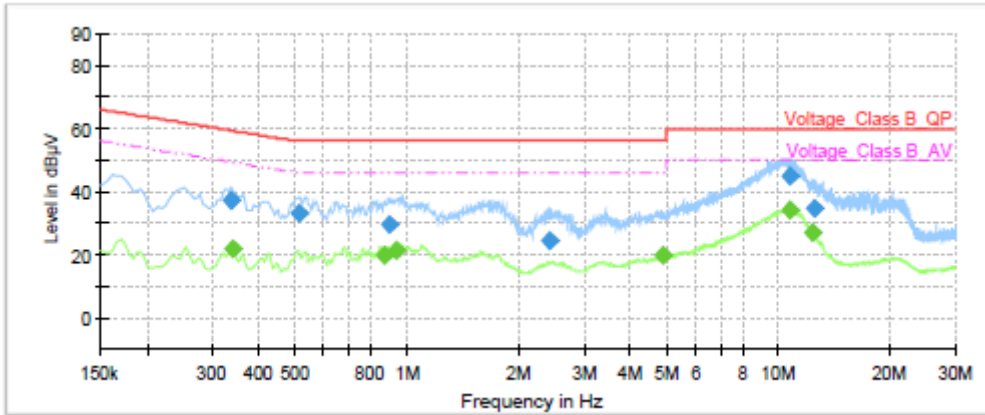

Frequency (MHz)	QuasiPeak (dBµV)	Average (dBµV)	Limit (dBµV)	Margin (dB)	Meas. Time (ms)	Bandwidth (kHz)	Line	Filter	Corr. (dB)
0.34	37.42	---	59.28	21.86	1000.0	9.000	L1	ON	19.19
0.34	---	21.63	49.17	27.54	1000.0	9.000	L1	ON	19.18
0.51	33.04	---	56.00	22.96	1000.0	9.000	L1	ON	19.24
0.87	---	19.98	46.00	26.02	1000.0	9.000	L1	ON	19.24
0.90	29.69	---	56.00	26.31	1000.0	9.000	L1	ON	19.24
0.94	---	21.41	46.00	24.59	1000.0	9.000	L1	ON	19.24
2.44	24.18	---	56.00	31.82	1000.0	9.000	L1	ON	19.03
4.88	---	19.73	46.00	26.27	1000.0	9.000	L1	ON	19.06
10.76	---	34.15	50.00	15.85	1000.0	9.000	L1	ON	19.36
10.79	44.68	---	60.00	15.32	1000.0	9.000	L1	ON	19.36
12.41	---	26.95	50.00	23.05	1000.0	9.000	L1	ON	19.43
12.55	34.81	---	60.00	25.19	1000.0	9.000	L1	ON	19.45

L line Conducted Emission from 150 KHz to 30 MHz

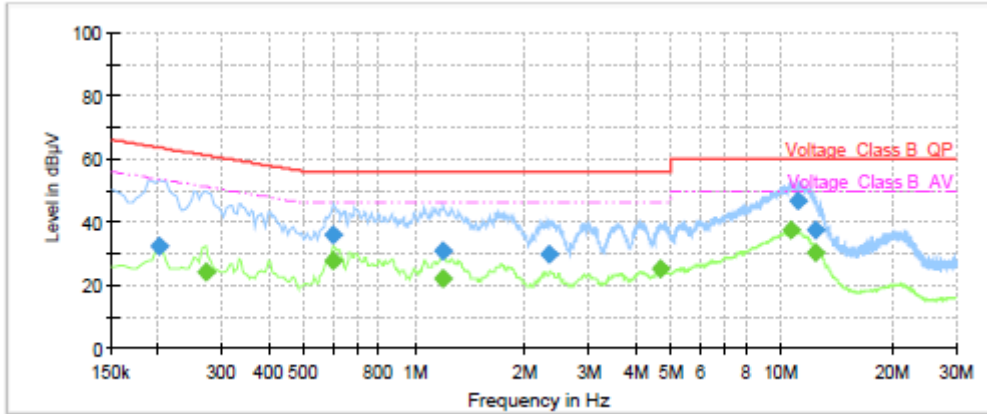

Frequency (MHz)	QuasiPeak (dBµV)	Average (dBµV)	Limit (dBµV)	Margin (dB)	Meas. Time (ms)	Bandwidth (kHz)	Line	Filter	Corr. (dB)
0.20	32.14	---	63.54	31.40	1000.0	9.000	N	ON	19.18
0.27	---	23.94	51.14	27.20	1000.0	9.000	N	ON	19.15
0.60	---	27.72	46.00	18.28	1000.0	9.000	N	ON	19.27
0.60	36.11	---	56.00	19.89	1000.0	9.000	N	ON	19.27
1.19	---	22.06	46.00	23.94	1000.0	9.000	N	ON	19.23
1.20	30.89	---	56.00	25.11	1000.0	9.000	N	ON	19.23
2.33	29.94	---	56.00	26.06	1000.0	9.000	N	ON	19.04
4.69	---	25.06	46.00	20.94	1000.0	9.000	N	ON	19.09
10.64	---	37.38	50.00	12.62	1000.0	9.000	N	ON	19.37
11.15	46.50	---	60.00	13.50	1000.0	9.000	N	ON	19.35
12.41	---	30.03	50.00	19.97	1000.0	9.000	N	ON	19.41
12.43	37.24	---	60.00	22.76	1000.0	9.000	N	ON	19.41

N line Conducted Emission from 150 KHz to 30 MHz





## 6. Main Test Instruments

Name	Manufacturer	Type	Serial Number	Calibration Date	Expiration Date
Spectrum Analyzer	R&S	FSV30	100815	2018-12-16	2019-12-15
EMI Test Receiver	R&S	ESCI	100948	2018-05-20	2019-05-19
Loop Antenna	SCHWARZBECK	FMZB1519	1519-047	2017-09-26	2019-09-25
TRILOG Broadband Antenna	Schwarzbeck	VULB 9163	9163-201	2017-11-18	2019-11-17
Double Ridged Waveguide Horn Antenna	R&S	HF907	100126	2018-07-07	2020-07-06
Standard Gain Horn	ETS-Lindgren	3160-09	00102643	2018-06-20	2020-06-19
EMI Test Receiver	R&S	ESR	101667	2018-05-20	2019-05-19
LISN	R&S	ENV216	101171	2016-12-16	2019-12-15
Spectrum Analyzer	Agilent	N9010A	MY47191109	2018-05-20	2019-05-19
Power Meter	R&S	NRP	104306	2018-05-20	2019-05-19
Power Sensor	R&S	NRP-Z21	104799	2018-05-20	2019-05-19
20dB Attenuator	Star River Highlight	UCL-TS2S-20	18013001	2018-12-16	2019-12-15
RF Cable	Agilent	SMA 15cm	0001	2019-03-15	2019-06-14
Software	R&S	EMC32	9.26.0	/	/

\*\*\*\*\*END OF REPORT \*\*\*\*\*