

# FCC Radio Test Report

## FCC ID: QISALP-LX9

This report concerns (check one): Original Grant Class I Change Class II Change

**Project No.** : 1708C104B  
**Equipment** : Smart Phone  
**Model Name** : ALP-L29  
**Applicant** : Huawei Technologies Co.,Ltd.  
**Address** : Administration Building, Headquarters of Huawei Technologies Co., Ltd., Bantian, Longgang District, Shenzhen, 518129, P.R.C

**Date of Receipt** : Sep. 25, 2017  
**Date of Test** : Sep. 25, 2017 ~ Oct. 10, 2017  
**Issued Date** : Oct. 10, 2017  
**Tested by** : BTL Inc.

**Technical Engineer** :

  
\_\_\_\_\_  
(Kenji Lin)

**Authorized Signatory** :

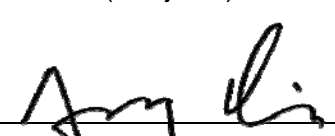
  
\_\_\_\_\_  
(Andy Chiu)

# **B T L I N C .**

No.18, Ln. 171, Sec. 2, Jiuzong Rd., Neihu Dist., Taipei City 114,  
Taiwan (R.O.C.)

TEL:+886-2-2657-3299 FAX: +886-2- 2657-3331



### **Declaration**

**BTL** represents to the client that testing is done in accordance with standard procedures as applicable and that test instruments used has been calibrated with standards traceable to international standard(s) and/or national standard(s).

**BTL's** reports apply only to the specific samples tested under conditions. It is manufacture's responsibility to ensure that additional production units of this model are manufactured with the identical electrical and mechanical components. **BTL** shall have no liability for any declarations, inferences or generalizations drawn by the client or others from **BTL** issued reports.

**BTL's** report must not be used by the client to claim product certification, approval, or endorsement by NVLAP, NIST, or any agency of the Federal Government.

This report is the confidential property of the client. As a mutual protection to the clients, the public and **BTL-self**, extracts from the test report shall not be reproduced except in full with **BTL's** authorized written approval.

**BTL's** laboratory quality assurance procedures are in compliance with the **ISO Guide17025** requirements, and accredited by the conformity assessment authorities listed in this test report.

### **Limitation**

For the use of the authority's logo is limited unless the Test Standard(s)/Scope(s)/Item(s) mentioned in this test report is (are) included in the conformity assessment authorities acceptance respective.

<b>Table of Contents</b>	<b>Page</b>
<b>REPORT ISSUED HISTORY</b>	<b>5</b>
<b>1 . CERTIFICATION</b>	<b>6</b>
<b>2 . SUMMARY OF TEST RESULTS</b>	<b>7</b>
2.1 TEST FACILITY	8
2.2 MEASUREMENT UNCERTAINTY	8
<b>3 . GENERAL INFORMATION</b>	<b>9</b>
3.1 GENERAL DESCRIPTION OF EUT	9
3.2 DESCRIPTION OF TEST MODES AND TEST CONDITION	11
3.3 BLOCK DIGRAM SHOWING THECONFIGURATIONOFSYSTEMTESTED FOR RADIATED	12
3.4 DESCRIPTION OF SUPPORT UNITS	12
<b>4 . TEST RESULT</b>	<b>13</b>
4.1 OUTPUT POWER MEASUREMENT	13
4.1.1 LIMIT	13
4.1.2 TEST PROCEDURE	13
4.1.3 TESTSETUP LAYOUT	13
4.1.4 TEST DEVIATION	13
4.1.5 TEST RESULTS	13
4.2 OCCUPIED BANDWIDTH MEASUREMENT	14
4.2.1 TEST PROCEDURE	14
4.2.2 TEST SETUP LAYOUT	14
4.2.3 TEST DEVIATION	14
4.2.4 TEST RESULTS	14
4.3 CONDUCTED EMISSIONS MEASUREMENT	15
4.3.1 LIMIT	15
4.3.2 TEST PROCEDURES	15
4.3.3 TESTSETUP LAYOUT	15
4.3.4 TESTDEVIATION	15
4.3.5 TEST RESULTS	15
4.4 RADIATED EMISSIONS MEASUREMENT	16
4.4.1 LIMIT	16
4.4.2 TEST PROCEDURES	16
4.4.3 TESTSETUP LAYOUT	17
4.4.4 TESTDEVIATION	17
4.4.5 TEST RESULTS	17
4.5 BAND EDGE /EMISSION MASK MEASUREMENT	18
4.5.1 LIMIT	18

<b>Table of Contents</b>	<b>Page</b>
<b>4.5.2 TEST PROCEDURES</b>	<b>18</b>
<b>4.5.3 TESTSETUP LAYOUT</b>	<b>18</b>
<b>4.5.4 TESTDEVIATION</b>	<b>18</b>
<b>4.5.5 TEST RESULTS</b>	<b>18</b>
<b>4.6 FREQUENCY STABILITY MEASUREMENT</b>	<b>19</b>
<b>4.6.1 LIMIT</b>	<b>19</b>
<b>4.6.2 TEST PROCEDURES</b>	<b>19</b>
<b>4.6.3 TESTSETUP LAYOUT</b>	<b>19</b>
<b>4.6.4 TESTDEVIATION</b>	<b>19</b>
<b>4.6.5 TEST RESULTS</b>	<b>19</b>
<b>5. LIST OF MEASUREMENT EQUIPMENTS</b>	<b>20</b>
<b>APPENDIX A - OUTPUT POWER</b>	<b>21</b>
<b>APPENDIX B - OCCUPIED BANDWIDTH</b>	<b>26</b>
<b>APPENDIX C - CONDUCTED EMISSIONS</b>	<b>34</b>
<b>APPENDIX D - RADIATED EMISSION</b>	<b>39</b>
<b>APPENDIX E - EMISSION MASK</b>	<b>72</b>
<b>APPENDIX F - FREQUENCY STABILITY</b>	<b>77</b>

### REPORT ISSUED HISTORY

Issued No.	Description	Issued Date
BTL-FCCP-2-1708C104B	Original Issue.	Oct. 10, 2017

## 1. CERTIFICATION

Equipment : Smart Phone  
Brand Name : HUAWEI  
Model Name : ALP-L29  
Applicant : Huawei Technologies Co.,Ltd.  
Manufacturer : Huawei Technologies Co.,Ltd.  
Address : Administration Building, Huawei Base, Bantian, Longgang District ,  
Shenzhen 518129, P.R.China  
Factory : Huawei Technologies Co.,Ltd.  
Address : Administration Building, Huawei Base, Bantian, Longgang District ,  
Shenzhen 518129, P.R.China  
Date of Test : Sep. 25, 2017 ~ Oct. 10, 2017  
Test Sample : Engineering Sample  
Standard(s) : 47 CFR FCC Part 90 Subpart S  
47 CFR FCC Part 2 & ANSI/TIA-603-D-2010  
FCC KDB 971168 D01 Power Meas License Digital Systems v02r02

The above equipment has been tested and found compliance with the requirement of the relative standards by BTL Inc.

The test data, data evaluation, and equipment configuration contained in our test report (Ref No. BTL-FCCP-2-1708C104B) were obtained utilizing the test procedures, test instruments, test sites that has been accredited by the Authority of TAF according to the ISO-17025 quality assessment standard and technical standard(s).

**Test results included in this report is only for the LTE Band 26 part.**

## 2. SUMMARY OF TEST RESULTS

Test procedures according to the technical standard(s):

FCC Part 90 Subpart S & Part 2			
Standard(s) Section	Test Item	Judgment	Tested By
2.1046 & 90.635 (b)	Radiated power	PASS	Paul Li
2.1046 & 90.635 (b)	Conducted Output Power	PASS	Paul Li
2.1049 & 90.209	Occupied Bandwidth	PASS	Paul Li
2.1051 & 90.691	Conducted Spurious Emissions	PASS	Paul Li
2.1053 & 90.691	Radiated Spurious Emissions	PASS	Paul Li
2.1055 & 90.213	Frequency Stability	PASS	Paul Li
2.1051 & 90.209	Emission Mask	PASS	Paul Li

Note:

(1) "N/A" denotes test is not applicable to this device.

## 2.1 TEST FACILITY

The test facilities used to collect the test data in this report:

### Radiated emissions Test (Below 1 GHz):

**CB15:** (FCC RN:674415; FCC DN:TW0659)

No. 68-1, Ln. 169, Sec.2, Datong Rd., Xizhi Dist., New Taipei City 221, Taiwan

### Radiated emissions Test (Above 1 GHz):

**CB15:** (FCC RN:674415; FCC DN:TW0659)

No. 68-1, Ln. 169, Sec.2, Datong Rd., Xizhi Dist., New Taipei City 221, Taiwan

### Conducted Test:

**TR01:** (FCC RN:674415; FCC DN:TW0659)

No. 68-1, Ln. 169, Sec.2, Datong Rd., Xizhi Dist., New Taipei City 221, Taiwan

## 2.2 MEASUREMENT UNCERTAINTY

Where relevant, the following measurement uncertainty levels have been estimated for tests performed on the EUT as specified in CISPR 16-4-2. The BTL measurement uncertainty is less than the CISPR 16-4-2  $U_{\text{CISPR}}$  requirement.

The reported uncertainty of measurement  $y \pm U$ , where expanded uncertainty  $U$  is based on a standard uncertainty multiplied by a coverage factor of  $k=2$ , providing a level of confidence of approximately **95%**.

### A. Radiated Measurement :

Test Site	Method	Measurement Frequency Range	U,(dB)
CB15 (3m)	CISPR	9kHz ~ 150kHz	2.82
		150kHz ~ 30MHz	2.58

Test Site	Method	Measurement Frequency Range	Ant. H / V	U,(dB)
CB15 (3m)	CISPR	30MHz ~ 200MHz	V	4.20
		30MHz ~ 200MHz	H	3.64
		200MHz ~ 1,000MHz	V	4.56
		200MHz ~ 1,000MHz	H	3.90

Test Site	Method	Measurement Frequency Range	Ant. H / V	U,(dB)
CB15 (3m)	CISPR	1GHz ~ 6GHz	V	4.46
		1GHz ~ 6GHz	H	4.40
		6GHz ~ 18GHz	V	3.88
		6GHz ~ 18GHz	H	4.00

Note: Unless specifically mentioned, the uncertainty of measurement has not been taken into account to declare the compliance or non-compliance to the specification.



### 3. GENERAL INFORMATION

#### 3.1 GENERAL DESCRIPTION OF EUT

Equipment	Smart Phone			
Brand Name	HUAWEI			
Model Name	ALP-L29			
Model Difference	N/A			
Modulation Type	QPSK, 16QAM			
Operation Frequency	Bandwidth: 1.4MHz	814.7 ~ 823.3 MHz		
	Bandwidth: 3MHz	815.5 ~ 822.5 MHz		
	Bandwidth: 5MHz	816.5 ~ 821.5 MHz		
	Bandwidth: 10MHz	819 MHz		
Max. ERP Power	Bandwidth: 1.4MHz	QPSK	21.17	dBm
		16QAM	20.09	dBm
	Bandwidth: 3MHz	QPSK	21.03	dBm
		16QAM	20.36	dBm
	Bandwidth: 5MHz	QPSK	21.13	dBm
		16QAM	20.38	dBm
	Bandwidth: 10MHz	QPSK	21.91	dBm
		16QAM	21.17	dBm
Antenna Type	Fixed Internal Antenna			
Antenna Gain	-2 dBi(Top Ant),-2.2 dBi(Bottom Ant)			
Hardware Version	HL1AALPSM			
Software Version	ALP-L29 5.0.1.67(C432log)			
IMEI No. 1	Radiated	866214030024848		
	Conducted	866214030024822		
IMEI No. 2	Radiated	866214030025845		
	Conducted	866214030025829		
Power Source	#1 Supplied from AC/DC adapter. #2 Battery Supplied. #3 USB Supplied.			
Power Rating	#1 Input: 100-240V~50/60Hz 0.75A Output: 5V  2A or 5V  5A or 5V  4.5A #2  3.82V 3900mA #3 DC 5V			

Note:

- For a more detailed features description, please refer to the manufacturer's specifications or the user's manual.

2. The EUT contains following accessory devices.

Item	Mfr/Brand	Model.
Battery	Sunwoda Electronic Co., LTD	HB436486ECW
	SCUD (FUJIAN) Electronics Co., Ltd	HB436486ECW
	Desay Battery Co., Ltd.	HB436486ECW
USB Cable	LUXSHARE-ICT Co., Ltd.	L99UC018-CS-H
	Chang Shu Honglin Technology Co.,Ltd.	130-27309
Adapter	DONGGUAN PHITEK ELECTRONICS CO.,LTD	HW-050450B00 (UK) HW-050450U00 (US) HW-050450E00 (EU) HW-050450A00 (AU)
	SHENZHEN HUNTKEY ELECTRONIC CO.,LTD.	
	Salcomp (Shenzhen)Co.,Ltd	
	HUAWEI Technologies Co., Ltd.(only for UK,US, EU type)	
Earphone	JIANGXI LIANCHUANG HONGSHENG ELECTRONIC CO., LTD	MEMD1632B580C00
	BOLUO COUNTY QUANCHENG ELECTRONIC CO., LTD	1311-3291-3.5mm-229
	Goer Tek Inc	NA12
	MERRY ELECTRONICS (SHENZHEN) CO., LTD.	EMC309-001

### 3.2 DESCRIPTION OF TEST MODES AND TEST CONDITION

Following channel(s) was (were) selected for the final test as listed below:

LTE Band 26												
Test Item	Channel Bandwidth(MHz)				Modulation		Tested Channel			RB		
	1.4	3	5	10	QPSK	16QAM	Low	Middle	High	1	50%	100%
ERP	V	V	V	V	V	V	V	V	V	V	V	V
Occupied Bandwidth	V	V	V	V	V	V	V	V	V	-	-	V
Conducted Emission	V	V	V	V	V	-	-	V	-	V	-	-
Emission Mask	V	V	V	V	V	-	V	-	V	V	-	V
Radiated Emission	V	-	-	V	V	-	-	V	-	V	-	-
Frequency Stability	V	V	V	V	V	-	-	V	-	-	-	V

Note:

- 1) The mark "V" means that this configuration is chosen for testing.
- 2) The mark "-" means that this configuration is not testing.

**EUT TEST CONDITIONS:**

Test Item	Environmental Conditions	Test Voltage
ERP	24°C, 63%RH	DC 3.82V
Conducted Output Power	25°C, 65%RH	DC 3.82V
Occupied Bandwidth	25°C, 65%RH	DC 3.82V
Conducted Emission	25°C, 65%RH	DC 3.82V
Radiated Emission	25°C, 60%RH	AC 120V/60Hz
Emission Mask	25°C, 65%RH	DC 3.82V
Frequency Stability	25°C, 65%RH	DC 3.82V

**3.3 BLOCK DIGRAM SHOWING THE CONFIGURATION OF SYSTEM TESTED FOR RADIATED**

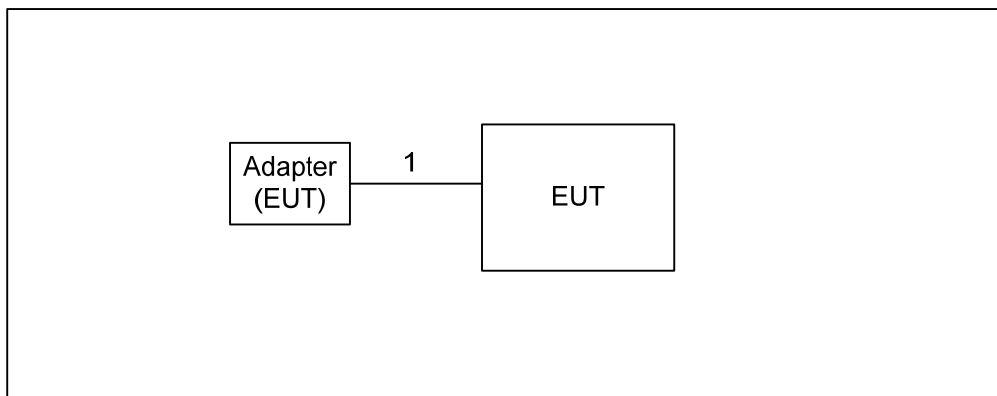

**3.4 DESCRIPTION OF SUPPORT UNITS**

The EUT has been tested as an independent unit together with other necessary accessories or support units. The following support units or accessories were used to form a representative test configuration during the tests.

Item	Equipment	Mfr/Brand	Model/Type No.	FCC ID	Series No.
-	-	-	-	-	-

Item	Shielded Type	Ferrite Core	Length	Note
1	NO	NO	1.5m	USB cable

## 4. TEST RESULT

### 4.1 OUTPUT POWER MEASUREMENT

#### 4.1.1 LIMIT

Mobile / Portable station are limited to 100 watts e.r.p.

#### 4.1.2 TEST PROCEDURE

##### EIRP/ERP:

EIRP= Conducted Power +Antenan gain

ERP power=EIPR power-2.15dBi.

##### Conducted Power:

The EUT was set up for the maximum power with GSM, GPRS, EDGE, WCDMA, CDMA, and LTE link data modulation and link up with simulator. Set the EUT to transmit under low, middle and high channel and record the power level shown on simulator.

#### 4.1.3 TESTSETUP LAYOUT

##### Conducted Power Measurement

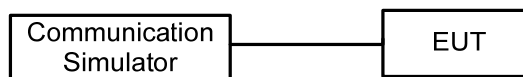

#### 4.1.4 TEST DEVIATION

No deviation

#### 4.1.5 TEST RESULTS

Please refer to the Appendix A.

## 4.2 OCCUPIED BANDWIDTH MEASUREMENT

### 4.2.1 TEST PROCEDURE

The EUT makes a call to the communication simulator. All measurements were done at low, middle and high operational frequency range. The communication simulator station system controlled a EUT to export maximum output power under transmission mode and specific channel frequency. Use OBW measurement function of Spectrum analyzer to measure 99 % occupied bandwidth and 26dB bandwidth.

### 4.2.2 TEST SETUP LAYOUT

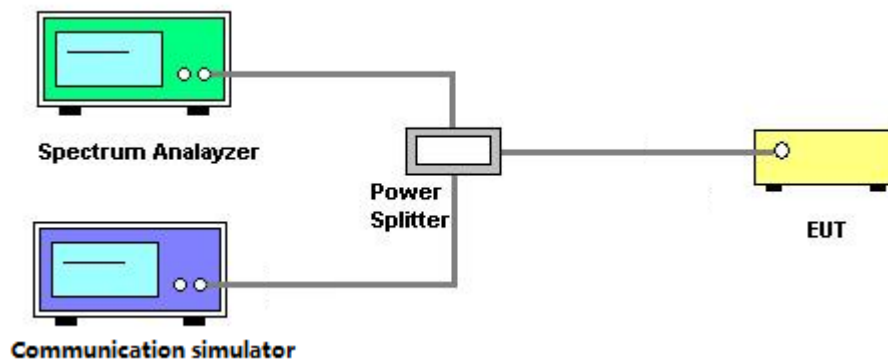

### 4.2.3 TEST DEVIATION

No deviation

### 4.2.4 TEST RESULTS

Please refer to the Appendix B.

### 4.3 CONDUCTED EMISSIONS MEASUREMENT

#### 4.3.1 LIMIT

The power of any emission outside a licensee's frequency block shall be attenuated below the transmitter power (P) by at least  $43 + 10 \log_{10}(P)$  dB. The limit of emission is equal to -13dBm.

#### 4.3.2 TEST PROCEDURES

1. The testing follows FCC KDB 971168 v02r02 Section 6.0.
2. The EUT was connected to spectrum analyzer and system simulator via a power divider.
3. The band edges of low and high channels for the highest RF powers were measured. Set  $RBW \geq 1\%$  EBW in the 1MHz band immediately outside and adjacent to the band edge.
4. Set spectrum analyzer with RMS detector.
5. The RF fundamental frequency should be excluded against the limit line in the operating frequency band.
6. The limit line is derived from  $43 + 10 \log(P)$  dB below the transmitter power P(Watts)  
 $= P(W) - [43 + 10 \log(P)](dB)$   
 $= [30 + 10 \log(P)](dBm) - [43 + 10 \log(P)](dB)$   
 $= -13dBm$

#### 4.3.3 TESTSETUP LAYOUT

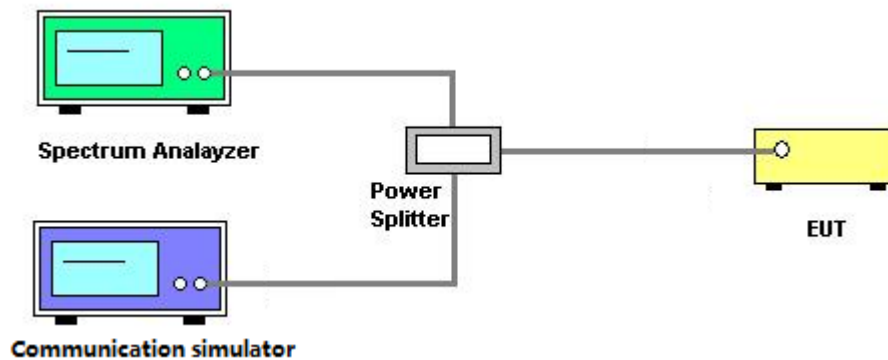

#### 4.3.4 TESTDEVIATION

No deviation

#### 4.3.5 TEST RESULTS

Please refer to the Appendix C.

## 4.4 RADIATED EMISSIONS MEASUREMENT

### 4.4.1 LIMIT

The power of any emission outside a licensee's frequency block shall be attenuated below the transmitter power (P) by at least  $43 + 10 \log_{10}(P)$  dB. The limit of emission is equal to -13dBm.

### 4.4.2 TEST PROCEDURES

1. In the semi-anechoic chamber, EUT placed on the 0.8m height of Turn Table, rotated the table around 360 degrees to search the maximum radiation power and receiver antenna shall be rotated vertical and horizontal polarization and moved height from 1m to 4m to find the maximum polar radiated power. The "Read Value" is the spectrum reading the maximum power value.
2. The substitution horn antenna is substituted for EUT at the same position and signals generator export the CW signal to the substitution antenna via a TX cable. Rotated the Turn Table and moved receiving antenna to find the maximum radiation power. Adjust output power level of S.G to get a Value of spectrum reading equal to "Read Value" of step a. Record the power level of S.G
3. EIRP = Output power level of S.G – TX cable loss + Antenna gain of substitution horn.
4. E.R.P power can be calculated form E.I.R.P power by subtracting the gain of dipole, E.R.P power = E.I.P.R power - 2.15dBi.
5. The resolution bandwidth and video bandwidth of test receiver/spectrum analyzer is 1MHz/3MHz.



#### 4.4.3 TESTSETUP LAYOUT

##### Below 1G

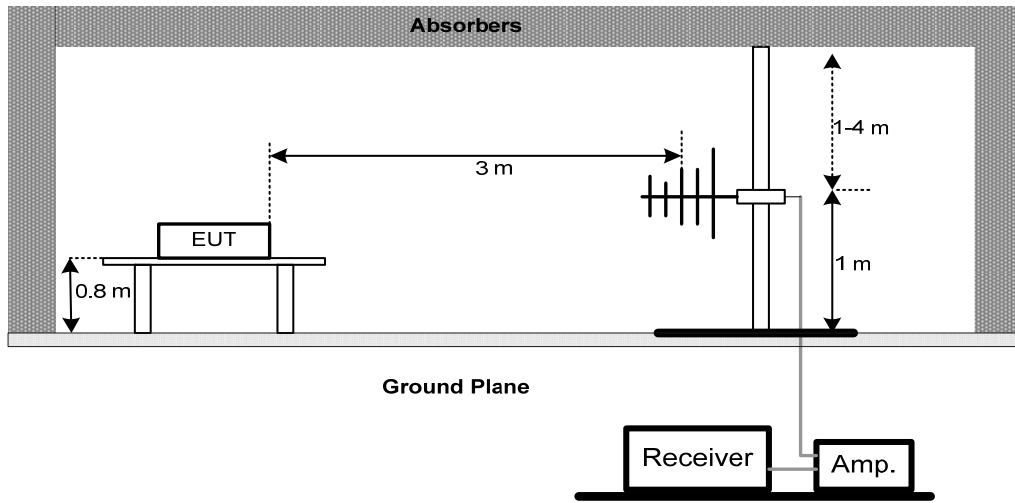

##### Above 1G

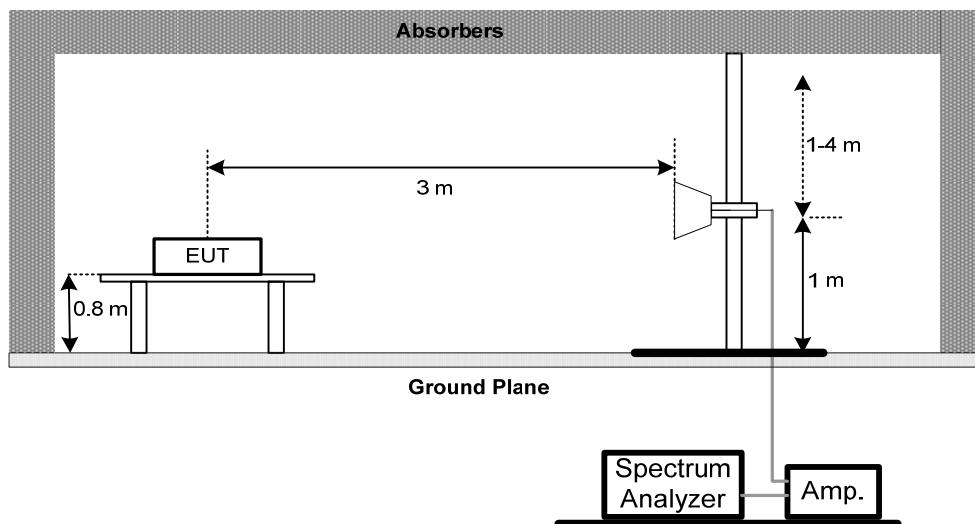

#### 4.4.4 TESTDEVIATION

No deviation

#### 4.4.5 TEST RESULTS

Please refer to the Appendix D.

## 4.5 BAND EDGE /EMISSION MASK MEASUREMENT

### 4.5.1 LIMIT

According to FCC part 90.691 shall be tested the emission mask. For any frequency removed from the EA licensee's frequency block by up to and including 37.5 kHz, the power of any emission shall be attenuated below the transmitter power (P) in watts by at least  $116 \log_{10}(f/6.1)$  decibels or  $50+10\log_{10}(P)$  decibels or 80 decibels, whichever is the lesser attenuation, where f is the frequency removed from the center of the outer channel in the block in kilohertz and where f is greater than 12.5 kHz.

### 4.5.2 TEST PROCEDURES

1. All measurements were done at low and high operational frequency range.
2. Set RBW=1% of 26dBc bandwidth, VBW=3 X RBW, detector=RMS, Sweep time = Auto.
3. Record the max trace plot into the test report.

### 4.5.3 TESTSETUP LAYOUT

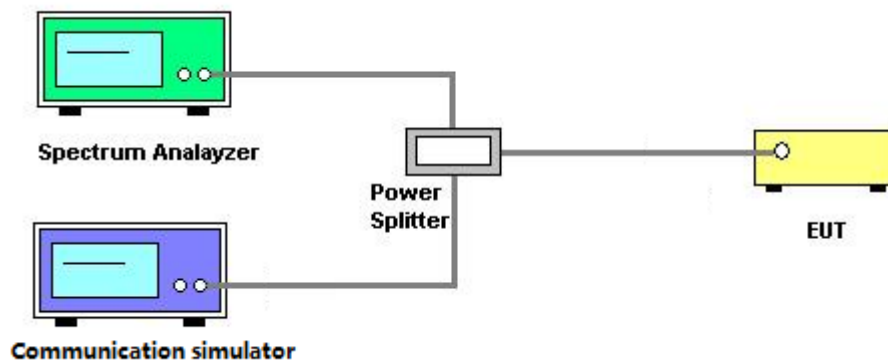

### 4.5.4 TESTDEVIATION

No deviation

### 4.5.5 TEST RESULTS

Please refer to the Appendix E.

## 4.6 FREQUENCY STABILITY MEASUREMENT

### 4.6.1 LIMIT

1.5 ppm is for base and fixed station. 2.5 ppm is for mobile station.

### 4.6.2 TEST PROCEDURES

1. Device is placed at the oven room. The oven room could control the temperatures and humidity. Power warm up is at least 15 min and power applied should perform before recording frequency error.
2. EUT is connected the external power supply to control the DC input power. The test voltage range is from minimum to maximum working voltage. Each step shall be record the frequency error rate.
3. The temperature range step is 10 degrees in this test items. All temperature levels shall be hold the  $\pm 0.5^{\circ}\text{C}$  during the measurement testing. The each temperature step shall be at least 0.5 hours, consider the EUT could be test under the stability condition.
4. The frequency error was recorded frequency error from the communication simulator.

### 4.6.3 TESTSETUP LAYOUT

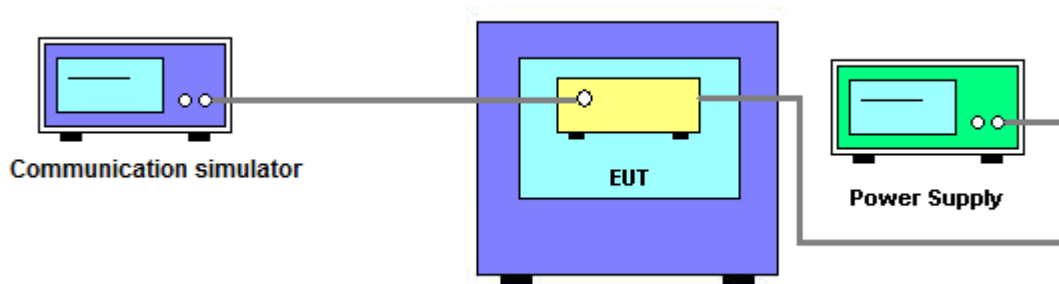

### 4.6.4 TESTDEVIATION

No deviation

### 4.6.5 TEST RESULTS

Please refer to the Appendix F.

## 5. LIST OF MEASUREMENT EQUIPMENTS

Radiated Emission Measurement					
Item	Kind of Equipment	Manufacturer	Type No.	Serial No.	Calibrated until
1	Preamplifier	EMCI	012645B	980267	Feb. 28, 2018
2	Preamplifier	EMCI	EMC02325	980217	Dec. 29, 2017
3	Preamplifier	EMCI	EMC2654045	980030	Feb. 14, 2018
4	Test Cable	EMCI	EMC104-SM-S M-8000	8m	Jan. 04, 2018
5	Test Cable	EMCI	EMC104-SM-S M-800	150207	Jan. 04, 2018
6	Test Cable	EMCI	EEMC104-SM-S M-3000	151205	Jan. 04, 2018
7	MXE EMI Receiver	Agilent	N9038A	MY55420127	Jan. 09, 2018
8	Signal Analyzer	Agilent	N9010A	MY52220990	Feb. 22, 2018
9	Loop Ant	EMCO	6502	42960	Nov. 24, 2017
10	Horn Ant	SCHWARZBECK	BBHA 9120D	9120D-1342	Feb. 28, 2018
11	Horn Ant	Schwarzbeck	BBHA 9170	187	Dec. 07, 2017
12	Trilog-Broadband Antenna	Schwarzbeck	VULB 9168	9168-548	Jan. 16, 2018
13	5dB Attenuator	EMCI	EMCI-N-6-05	AT-N0623	Jan. 16, 2018

Conducted Measurement					
Item	Kind of Equipment	Manufacturer	Type No.	Serial No.	Calibrated until
1	Spectrum Analyzer	Keysight	N9010A	MY54200240	Aug. 27, 2018
2	Spectrum Analyzer	R&S	FSP-40	100129	Jan. 16, 2018
2	Radio Com Analyzer	Anritsu	MT8820C	6201525878	Sep. 05, 2019

Frequency Stability Measurement					
Item	Kind of Equipment	Manufacturer	Type No.	Serial No.	Calibrated until
1	Spectrum Analyzer	Keysight	N9010A	MY54200240	Aug. 27, 2018
2	Radio Com Analyzer	Anritsu	MT8820C	6201525878	Sep. 05, 2019
3	Thermal Chamber	HOLINK	CHOLINK/H-T- 1F-D	BA03101701	May 14, 2018

Remark: "N/A" denotes no model name, serial no. or calibration specified.  
All calibration period of equipment list is one year.

## APPENDIX A - OUTPUT POWER

Conducted Power_Band 26						
Bandwith	Modulation	RB Sizer	RB Offset	Low CH	Mid CH	High CH
				26697 CH	26740 CH	26783 CH
				814.7 MHz	819 MHz	823.3 MHz
1.4M	QPSK	1	0	22.64	22.59	23.17
		1	2	22.70	22.78	22.92
		1	5	22.82	22.65	22.87
		3	0	22.65	22.75	22.84
		3	1	22.71	22.97	22.85
		3	2	22.74	22.93	22.85
		6	0	21.57	21.97	21.87
	16QAM	1	0	21.86	22.09	22.05
		1	2	21.89	22.09	22.05
		1	5	21.98	21.98	21.99
		3	0	21.77	22.02	21.90
		3	1	21.83	22.00	21.90
		3	2	21.87	21.97	21.89
		6	0	20.81	20.88	20.91
Bandwith	Modulation	RB Sizer	RB Offset	Low CH	Mid CH	High CH
				26705 CH	26740 CH	26775 CH
				815.5 MHz	819 MHz	822.5 MHz
3M	QPSK	1	0	22.59	22.47	22.95
		1	7	23.03	22.95	22.91
		1	14	22.86	22.71	22.68
		8	0	21.60	21.97	21.91
		8	4	21.96	21.91	21.94
		8	7	21.81	21.83	21.84
		15	0	21.86	21.95	21.93
	16QAM	1	0	22.05	22.13	22.09
		1	7	22.36	22.05	22.17
		1	14	22.32	21.84	21.92
		8	0	20.94	20.93	20.85
		8	4	21.10	20.90	21.00
		8	7	21.01	20.81	20.91
		15	0	20.95	20.87	20.98

Note: The Conducted Power=measured value+cabel loss.

Conducted Power_Band 26						
Bandwith	Modulation	RB Sizet	RB Offset	Low CH	Mid CH	High CH
				26715 CH	26740 CH	26765 CH
				816.5 MHz	819 MHz	821.5 MHz
5M	QPSK	1	0	22.76	22.62	22.68
		1	13	23.01	22.88	22.96
		1	24	23.13	22.90	22.94
		12	0	22.10	22.15	21.98
		12	6	22.01	22.04	22.10
		12	11	21.90	21.98	22.16
		25	0	21.94	22.04	21.92
	16QAM	1	0	22.16	22.38	22.11
		1	13	22.33	22.17	22.35
		1	24	22.31	22.09	22.12
		12	0	21.01	21.01	20.96
		12	6	20.17	20.91	21.08
		12	11	21.07	20.87	21.14
		25	0	21.00	20.95	20.90

Bandwith	Modulation	RB Sizet	RB Offset	Mid CH
				26740 CH
				819 MHz
10M	QPSK	1	0	22.91
		1	25	23.91
		1	49	23.69
		25	0	22.11
		25	13	22.12
		25	25	22.28
		50	0	22.10
	16QAM	1	0	22.14
		1	25	23.17
		1	49	22.88
		25	0	21.23
		25	13	21.36
		25	25	21.44
		50	0	21.18

Note: The Conducted Power=measured value+cabel loss.

**ERP Power\_Band 26**

Bandwith	Modulation	RB Sizet	RB Offset	Low CH	Mid CH	High CH
				26697 CH	26740 CH	26783 CH
				814.7 MHz	819 MHz	823.3 MHz
1.4M	QPSK	1	0	20.64	20.59	21.17
		1	2	20.70	20.78	20.92
		1	5	20.82	20.65	20.87
		3	0	20.65	20.75	20.84
		3	1	20.71	20.97	20.85
		3	2	20.74	20.93	20.85
		6	0	19.57	19.97	19.87
	16QAM	1	0	19.86	20.09	20.05
		1	2	19.89	20.09	20.05
		1	5	19.98	19.98	19.99
		3	0	19.77	20.02	19.90
		3	1	19.83	20.00	19.90
		3	2	19.87	19.97	19.89
		6	0	18.81	18.88	18.91
Bandwith	Modulation	RB Sizet	RB Offset	Low CH	Mid CH	High CH
				26705 CH	26740 CH	26775 CH
				815.5 MHz	819 MHz	822.5 MHz
3M	QPSK	1	0	20.59	20.47	20.95
		1	7	21.03	20.95	20.91
		1	14	20.86	20.71	20.68
		8	0	19.60	19.97	19.91
		8	4	19.96	19.91	19.94
		8	7	19.81	19.83	19.84
		15	0	19.86	19.95	19.93
	16QAM	1	0	20.05	20.13	20.09
		1	7	20.36	20.05	20.17
		1	14	20.32	19.84	19.92
		8	0	18.94	18.93	18.85
		8	4	19.10	18.90	19.00
		8	7	19.01	18.81	18.91
		15	0	18.95	18.87	18.98



EIRP Power_Band 26						
Bandwith	Modulation	RB Sizet	RB Offset	Low CH	Mid CH	High CH
				26715 CH	26740 CH	26765 CH
				816.5 MHz	819 MHz	821.5 MHz
5M	QPSK	1	0	20.76	20.62	20.68
		1	13	21.01	20.88	20.96
		1	24	21.13	20.90	20.94
		12	0	20.10	20.15	19.98
		12	6	20.01	20.04	20.10
		12	11	19.90	19.98	20.16
		25	0	19.94	20.04	19.92
	16QAM	1	0	20.16	20.38	20.11
		1	13	20.33	20.17	20.35
		1	24	20.31	20.09	20.12
		12	0	19.01	19.01	18.96
		12	6	18.17	18.91	19.08
		12	11	19.07	18.87	19.14
		25	0	19.00	18.95	18.90

Bandwith	Modulation	RB Sizet	RB Offset	Mid CH
				26740 CH
				819 MHz
10M	QPSK	1	0	20.91
		1	25	21.91
		1	49	21.69
		25	0	20.11
		25	13	20.12
		25	25	20.28
		50	0	20.10
	16QAM	1	0	20.14
		1	25	21.17
		1	49	20.88
		25	0	19.23
		25	13	19.36
		25	25	19.44
		50	0	19.18

## APPENDIX B - OCCUPIED BANDWIDTH

LTE Band 26_1.4M					
QPSK			16QAM		
Channel	Frequency (MHz)	99% Occupied Bandwidth (MHz)	Channel	Frequency (MHz)	99% Occupied Bandwidth (MHz)
26697	814.7	1.0980	26697	814.7	1.0982
26740	819	1.0988	26740	819	1.0973
26783	823.3	1.0929	26783	823.3	1.1041
Channel	Frequency (MHz)	26dB Bandwidth (MHz)	Channel	Frequency (MHz)	26dB Bandwidth (MHz)
26697	814.7	1.249	26697	814.7	1.243
26740	819	1.250	26740	819	1.243
26783	823.3	1.243	26783	823.3	1.243

### Spectrum Plot



LTE Band 26_3M					
QPSK			16QAM		
Channel	Frequency (MHz)	99% Occupied Bandwidth (MHz)	Channel	Frequency (MHz)	99% Occupied Bandwidth (MHz)
26705	815.5	2.7185	26705	815.5	2.7199
26740	819	2.7109	26740	819	2.7104
26775	822.5	2.7136	26775	822.5	2.7194
Channel	Frequency (MHz)	26dB Bandwidth (MHz)	Channel	Frequency (MHz)	26dB Bandwidth (MHz)
26705	815.5	3.019	26705	815.5	3.007
26740	819	2.995	26740	819	2.997
26775	822.5	2.996	26775	822.5	3.009

### Spectrum Plot

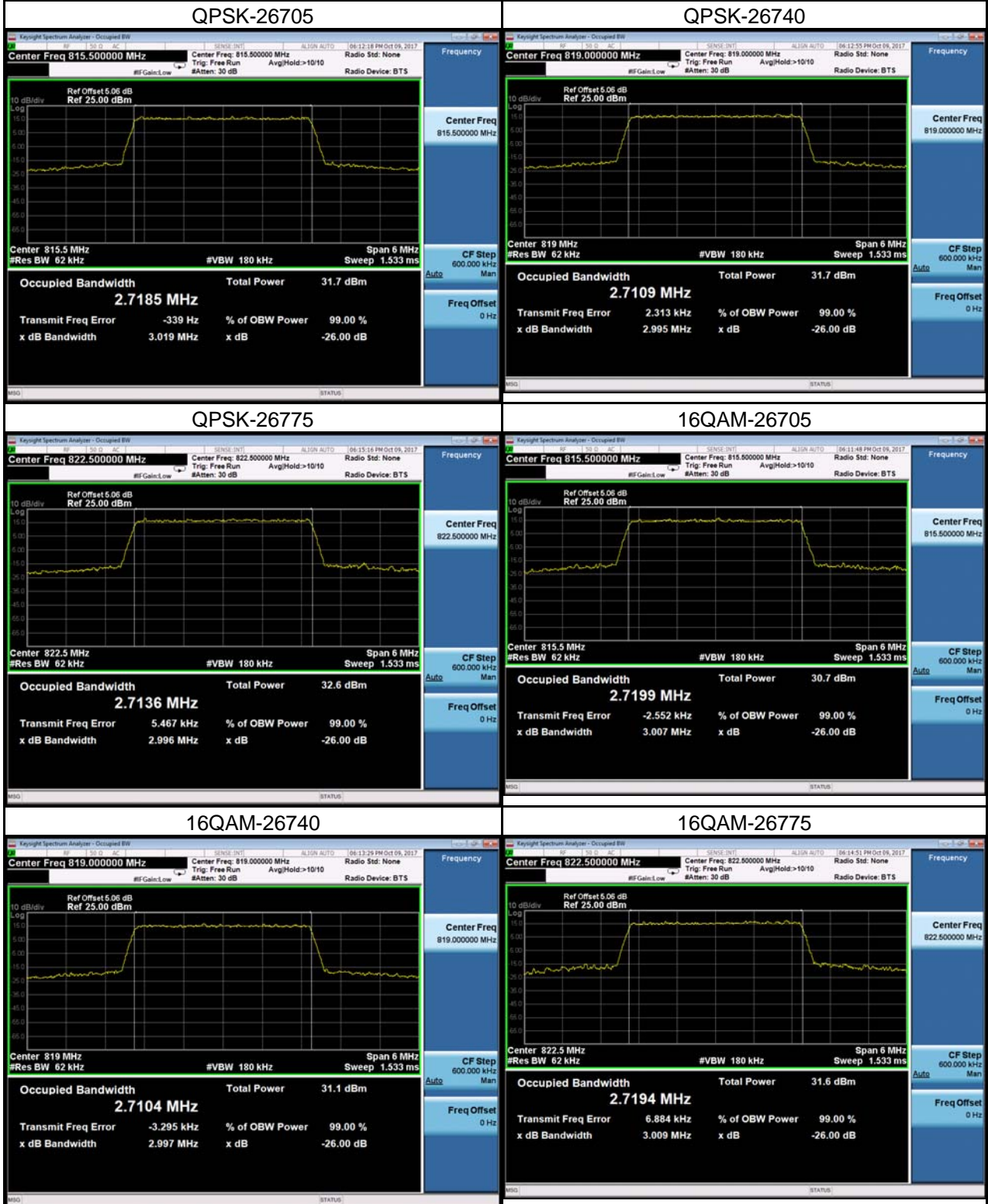

LTE Band 26_5M					
QPSK			16QAM		
Channel	Frequency (MHz)	99% Occupied Bandwidth (MHz)	Channel	Frequency (MHz)	99% Occupied Bandwidth (MHz)
26715	816.5	4.5251	26715	816.5	4.5270
26740	819	4.5289	26740	819	4.5258
26765	821.5	4.5284	26765	821.5	4.5294
Channel	Frequency (MHz)	26dB Bandwidth (MHz)	Channel	Frequency (MHz)	26dB Bandwidth (MHz)
26715	816.5	4.990	26715	816.5	5.002
26740	819	5.011	26740	819	5.021
26765	821.5	4.983	26765	821.5	4.975

### Spectrum Plot

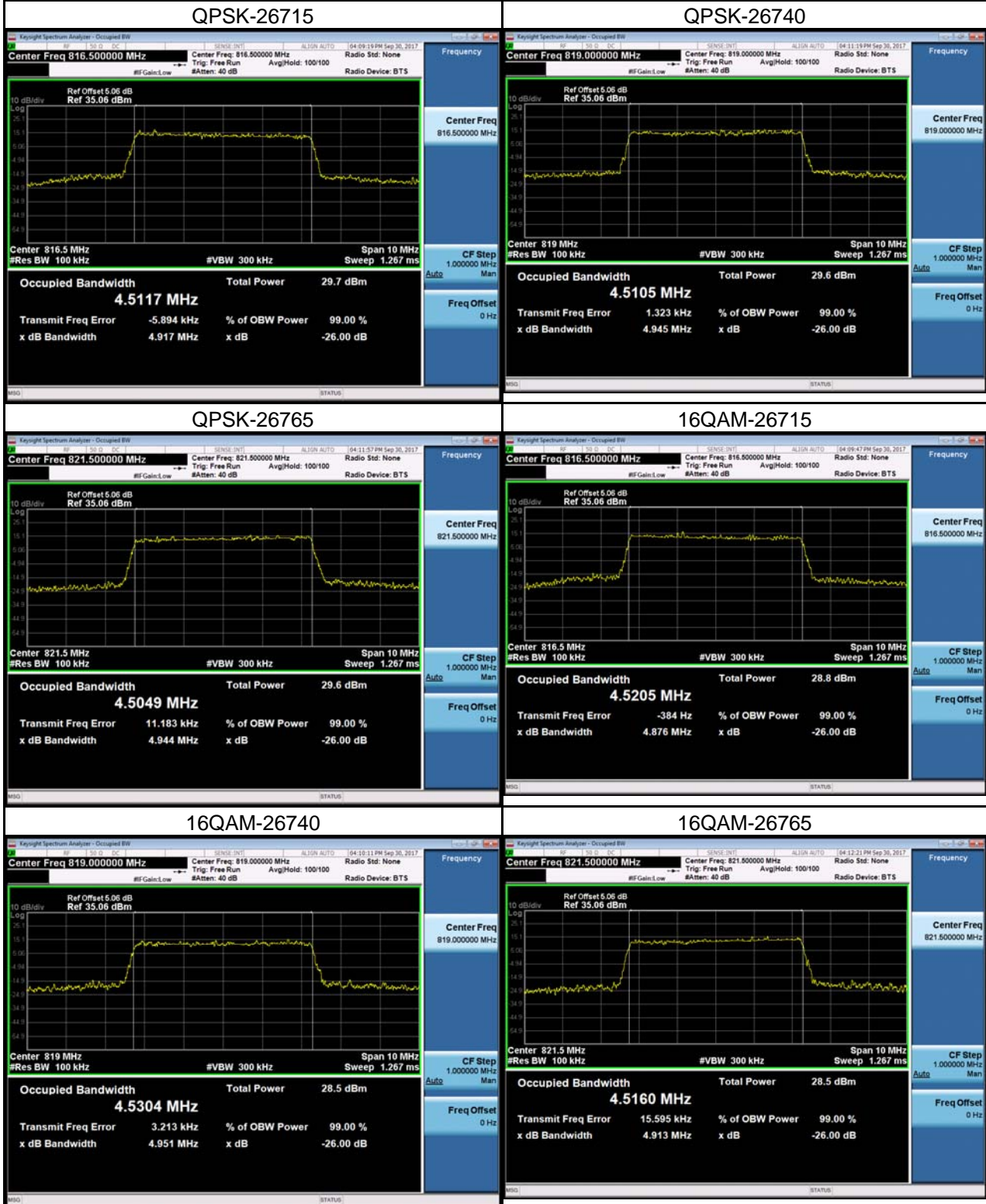



LTE Band 26_10M					
QPSK			16QAM		
Channel	Frequency (MHz)	99% Occupied Bandwidth (MHz)	Channel	Frequency (MHz)	99% Occupied Bandwidth (MHz)
26740	819	9.0346	26740	819	9.0073
Channel	Frequency (MHz)	26dB Bandwidth (MHz)	Channel	Frequency (MHz)	26dB Bandwidth (MHz)
26740	819	9.910	26740	819	9.966

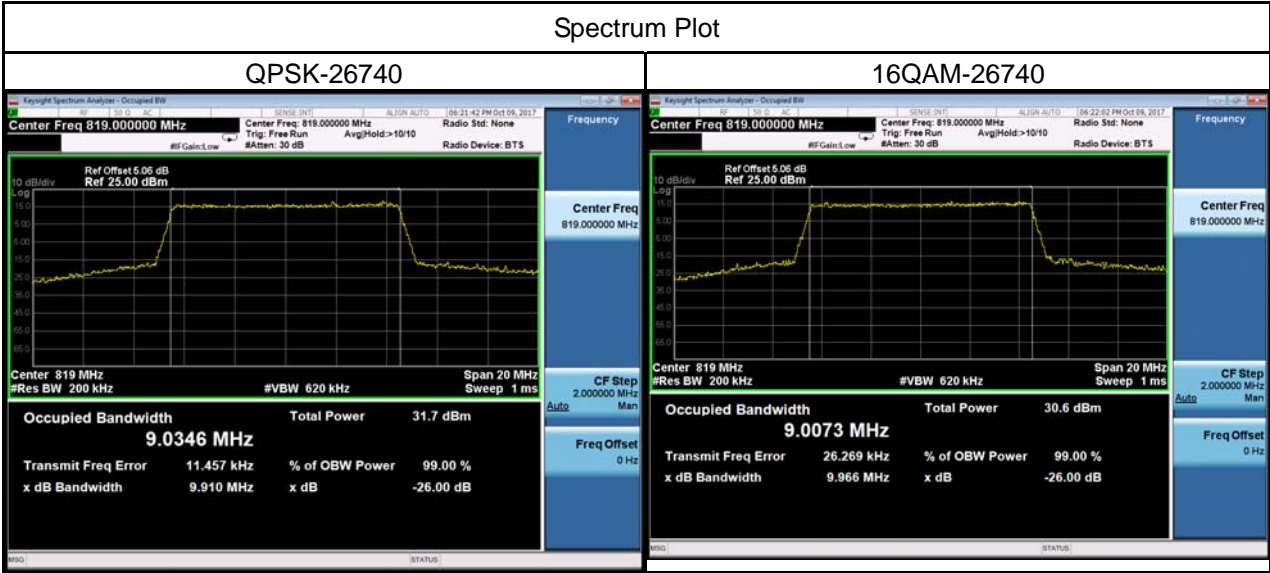

## APPENDIX C - CONDUCTED EMISSIONS

LTE Band 26_1.4M			
Channel	Frequency(MHz)	Channel	Frequency(MHz)
26740	819	26740	819
Date: 26.SEP.2017 21:24:31		Date: 26.SEP.2017 21:26:34	
Channel	Frequency(MHz)	-	-
26740	819	-	-

LTE Band 26_3M			
Channel	Frequency(MHz)	Channel	Frequency(MHz)
26740	819	26740	819
Date: 26.SEP.2017 21:28:20		Date: 26.SEP.2017 21:33:34	
Channel	Frequency(MHz)	-	-
26740	819	-	-

LTE Band 26_5M			
Channel	Frequency(MHz)	Channel	Frequency(MHz)
26740	819	26740	819
Channel	Frequency(MHz)	-	-
26740	819	-	-

LTE Band 26_10M			
Channel	Frequency(MHz)	Channel	Frequency(MHz)
26740	819	26740	819
Date: 26.SEP.2017 21:39:52		Date: 26.SEP.2017 21:44:12	
Channel	Frequency(MHz)	-	-
26740	819	-	-

## APPENDIX D - RADIATED EMISSION

Test Mode: TX Mode (Adapter: PHITEK)

Ant 0°

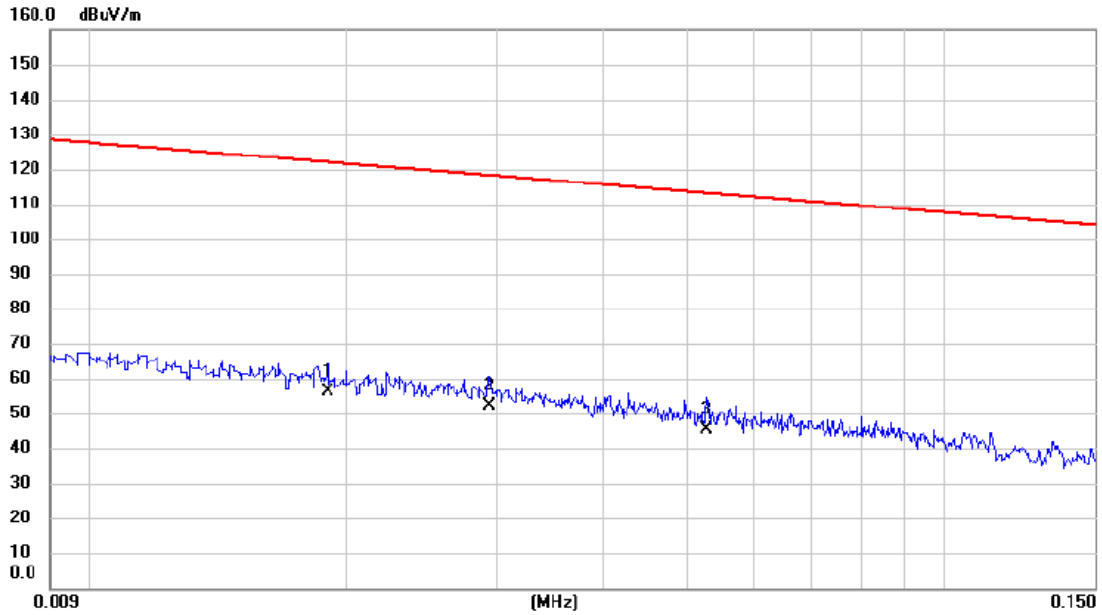

No.	Mk.	Freq. MHz	Reading Level dBuV	Correct Factor dB	Measure- ment dBuV/m	Limit dBuV/m	Margin dB	Detector	Comment
1	*	0.019	36.58	19.75	56.33	122.03	-65.70	AVG	
2		0.029	32.67	19.34	52.01	118.24	-66.23	AVG	
3		0.053	26.57	18.66	45.23	113.15	-67.92	AVG	



Test Mode: TX Mode (Adapter: PHITEK)

Ant 0°

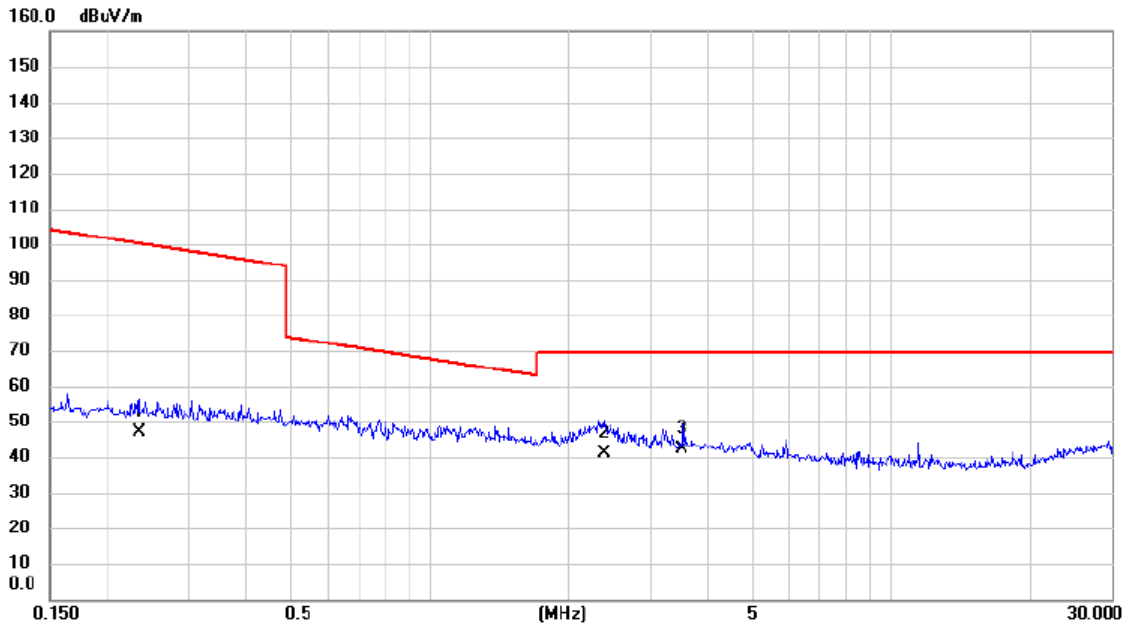

No.	Mk.	Freq. MHz	Reading Level dBuV	Correct Factor dB	Measure- ment dBuV/m	Limit dBuV/m	Margin dB	Detector	Comment
1		0.234	30.46	16.70	47.16	100.22	-53.06	AVG	
2		2.384	25.76	15.40	41.16	69.54	-28.38	QP	
3	*	3.528	26.94	15.08	42.02	69.54	-27.52	QP	

Test Mode: TX Mode (Adapter: PHITEK)

Ant 90°

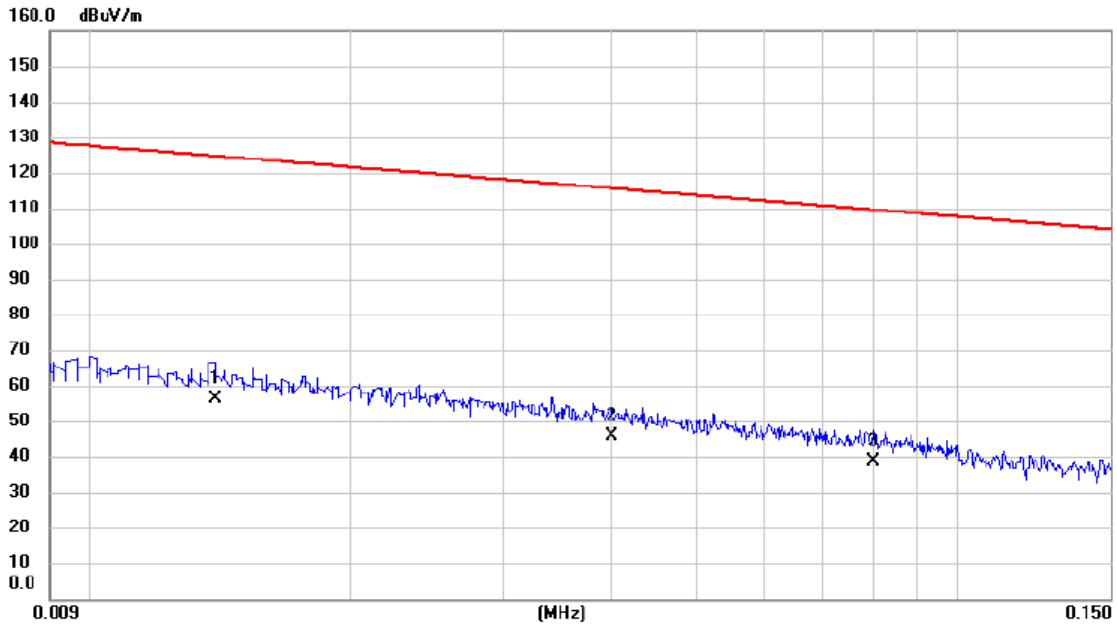

No.	Mk.	Freq. MHz	Reading Level dBuV	Correct Factor dB	Measure- ment dBuV/m	Limit dBuV/m	Margin dB	Detector	Comment
1	*	0.014	35.70	20.40	56.10	124.68	-68.58	AVG	
2		0.040	26.64	19.02	45.66	115.56	-69.90	AVG	
3		0.080	20.43	18.11	38.54	109.53	-70.99	AVG	

Test Mode: TX Mode (Adapter: PHITEK)

Ant 90°

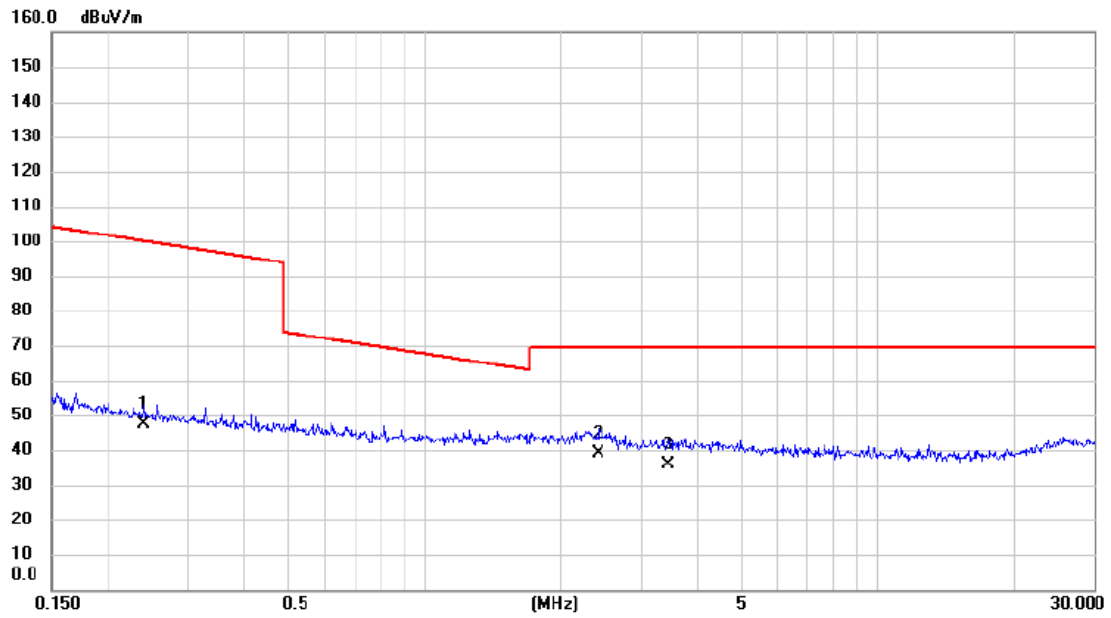

No.	Mk.	Freq. MHz	Reading Level dBuV	Correct Factor dB	Measure- ment dBuV/m	Limit dBuV/m	Margin dB	Detector	Comment
1		0.240	30.58	16.69	47.27	99.99	-52.72	AVG	
2	*	2.422	23.49	15.39	38.88	69.54	-30.66	QP	
3		3.454	20.84	15.10	35.94	69.54	-33.60	QP	

Test Mode: TX Mode (Adapter: HUNTKEY)

Ant 0°

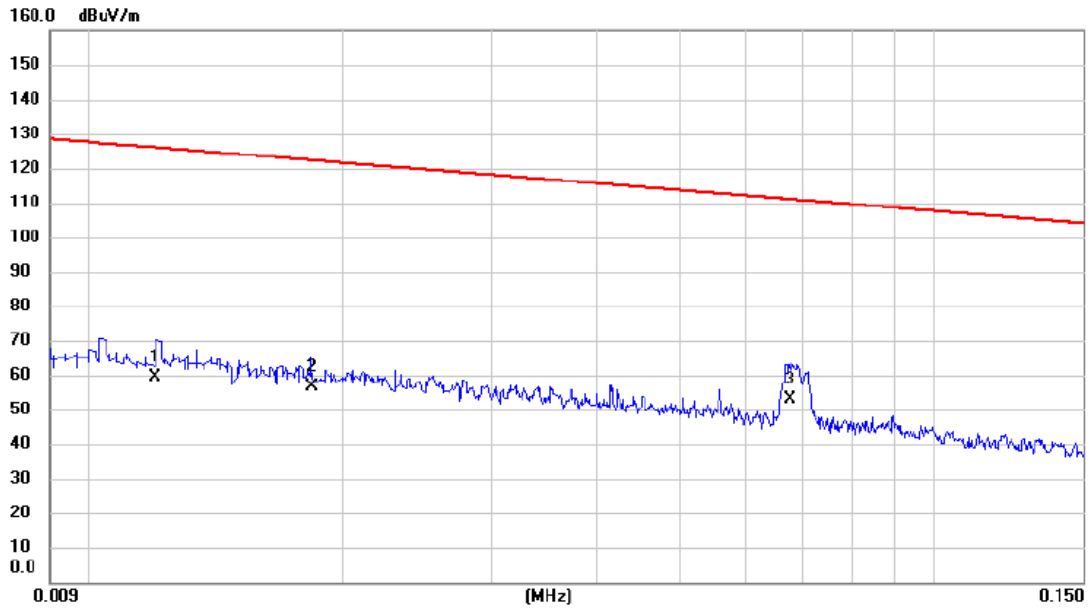

No.	Mk.	Freq.	Reading Level	Correct Factor	Measurement	Limit	Margin	Detector	Comment
		MHz	dBuV	dB	dBuV/m	dBuV/m	dB		
1		0.012	38.55	20.66	59.21	126.02	-66.81	AVG	
2		0.018	36.97	19.83	56.80	122.31	-65.51	AVG	
3	*	0.068	34.69	18.38	53.07	110.99	-57.92	AVG	

Test Mode: TX Mode (Adapter: HUNTKEY)

Ant 0°



No.	Mk.	Freq. MHz	Reading Level dBuV	Correct Factor dB	Measure- ment dBuV/m	Limit dBuV/m	Margin dB	Detector	Comment
1		0.190	33.69	16.83	50.52	102.01	-51.49	AVG	
2	*	2.273	26.57	15.44	42.01	69.54	-27.53	QP	
3		7.137	22.63	14.10	36.73	69.54	-32.81	QP	

Test Mode: TX Mode (Adapter: HUNTKEY)

Ant 90°

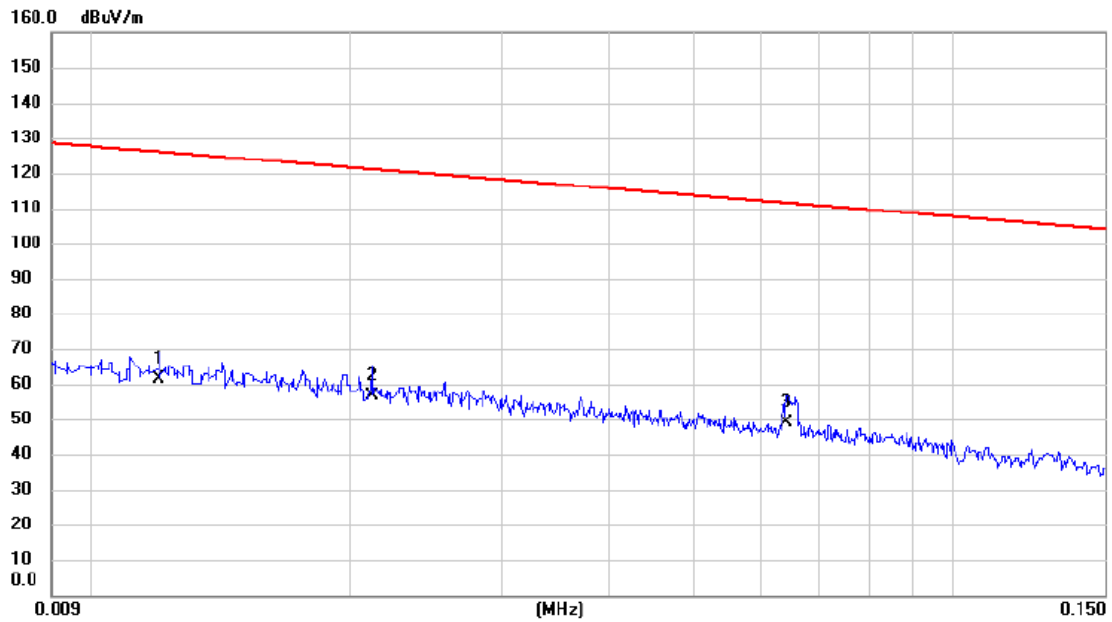

No.	Mk.	Freq. MHz	Reading Level dBuV	Correct Factor dB	Measure- ment dBuV/m	Limit dBuV/m	Margin dB	Detector	Comment
1		0.012	40.65	20.66	61.31	126.02	-64.71	AVG	
2		0.021	36.84	19.58	56.42	121.08	-64.66	AVG	
3	*	0.064	30.49	18.45	48.94	111.47	-62.53	AVG	

Test Mode: TX Mode (Adapter: HUNTKEY)

Ant 90°

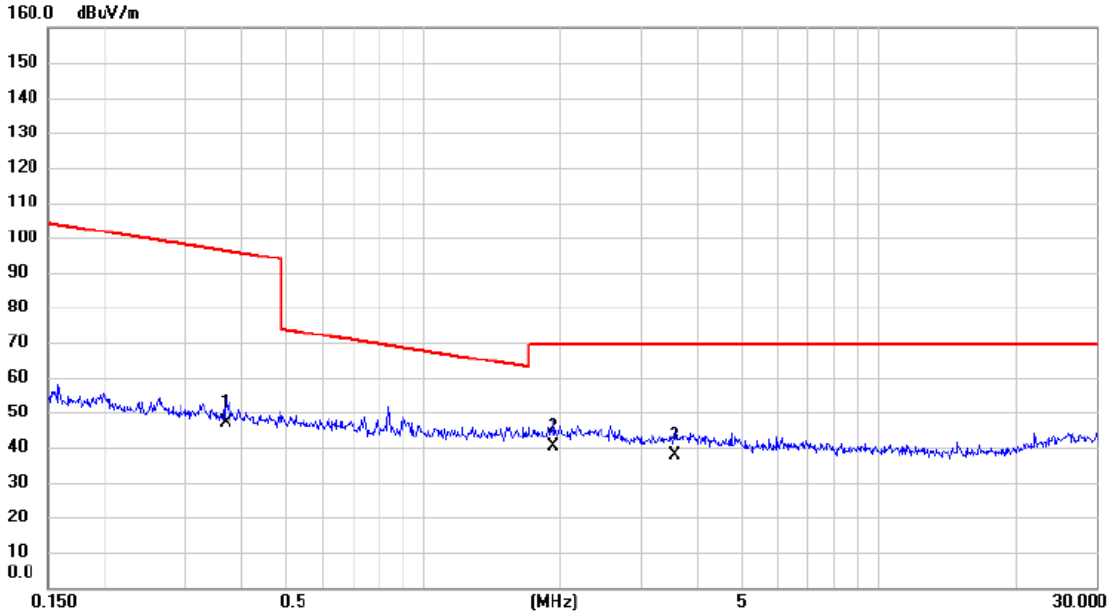

No.	Mk.	Freq. MHz	Reading Level dBuV	Correct Factor dB	Measure- ment dBuV/m	Limit dBuV/m	Margin dB	Detector	Comment
1		0.369	30.59	16.56	47.15	96.26	-49.11	AVG	
2	*	1.928	24.63	15.54	40.17	69.54	-29.37	QP	
3		3.565	22.73	15.07	37.80	69.54	-31.74	QP	

Test Mode: TX Mode (Adapter: Salcomp)

Ant 0°

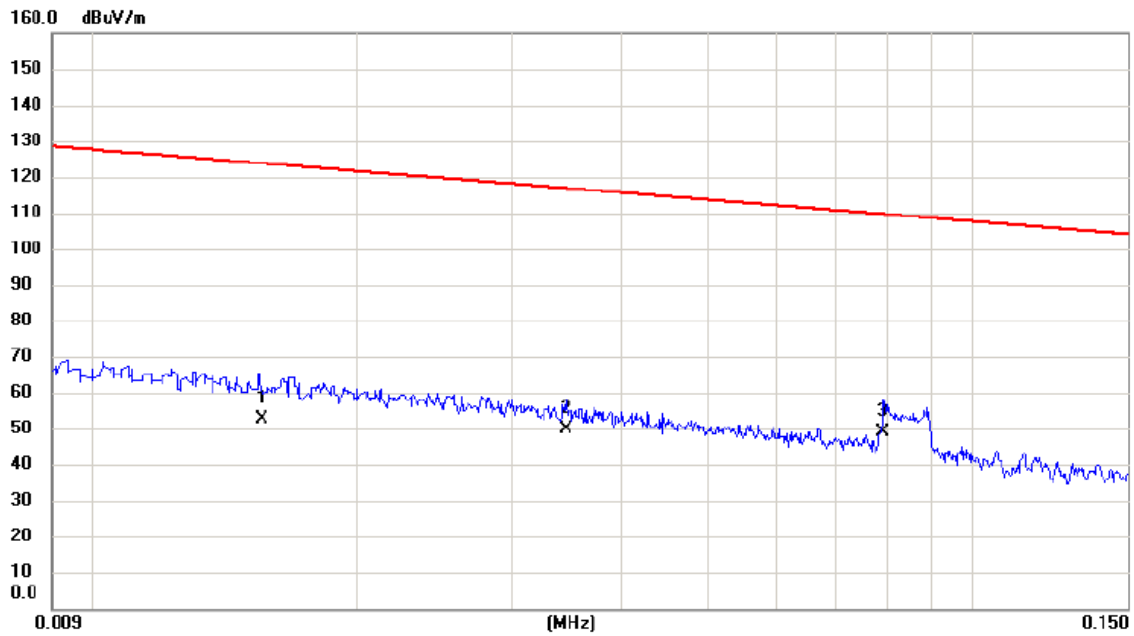

No.	Mk.	Freq. MHz	Reading Level dBuV	Correct Factor dB	Measure- ment dBuV/m	Limit dBuV/m	Margin dB	Detector	Comment
1		0.0156	32.25	20.19	52.44	123.74	-71.30	AVG	
2		0.0345	30.49	19.18	49.67	116.85	-67.18	AVG	
3	*	0.0792	30.68	18.13	48.81	109.63	-60.82	AVG	



Test Mode: TX Mode (Adapter: Salcomp)

Ant 0°

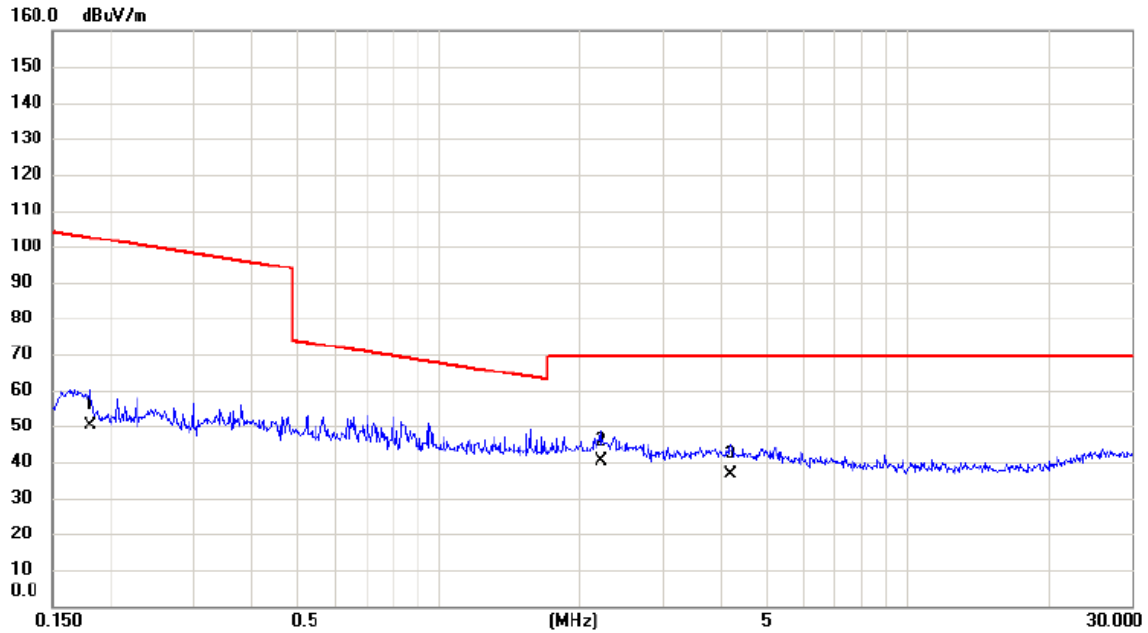

No.	Mk.	Freq. MHz	Reading Level dBuV	Correct Factor dB	Measure- ment dBuV/m	Limit dBuV/m	Margin dB	Detector	Comment
1		0.1806	33.21	16.86	50.07	102.47	-52.40	AVG	
2	*	2.2132	24.59	15.45	40.04	69.54	-29.50	QP	
3		4.2018	21.87	14.83	36.70	69.54	-32.84	QP	

Test Mode: TX Mode (Adapter: Salcomp)

Ant 90°

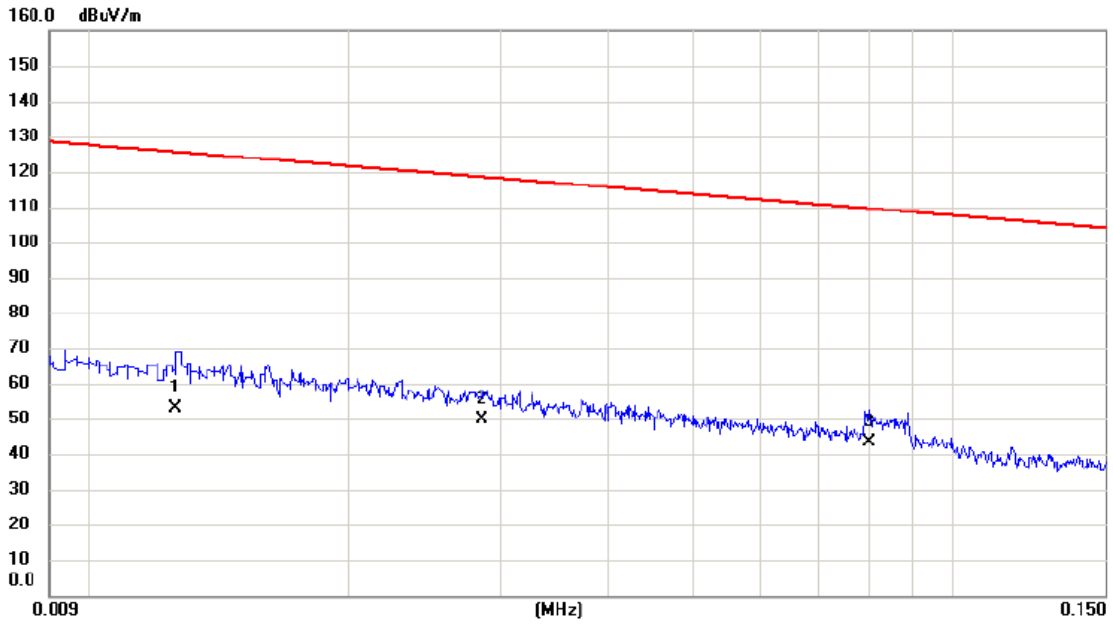

No.	Mk.	Freq. MHz	Reading Level dBuV	Correct Factor dB	Measure- ment dBuV/m	Limit dBuV/m	Margin dB	Detector	Comment
1		0.0126	32.40	20.58	52.98	125.60	-72.62	AVG	
2		0.0285	30.59	19.37	49.96	118.51	-68.55	AVG	
3	*	0.0801	25.48	18.11	43.59	109.53	-65.94	AVG	

Test Mode: TX Mode (Adapter: Salcomp)

Ant 90°

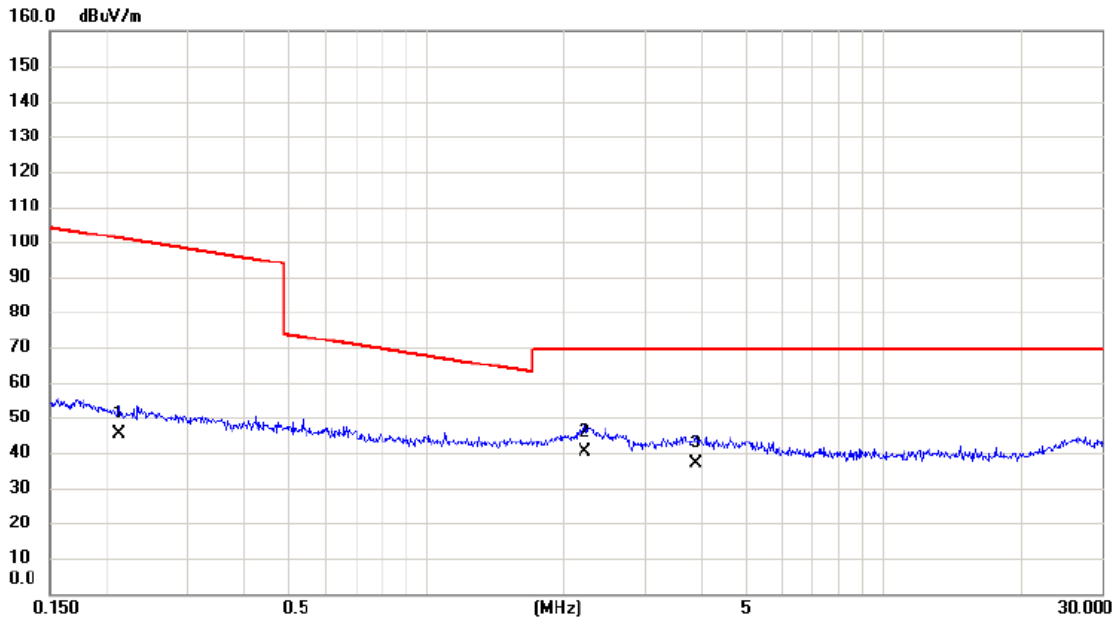

No.	Mk.	Freq. MHz	Reading Level dBuV	Correct Factor dB	Measure- ment dBuV/m	Limit dBuV/m	Margin dB	Detector	Comment
1		0.2128	28.49	16.76	45.25	101.05	-55.80	AVG	
2	*	2.2132	24.73	15.45	40.18	69.54	-29.36	QP	
3		3.8808	21.89	14.99	36.88	69.54	-32.66	QP	

Test Mode: TX Mode (Adapter: HUAWEI)

Ant 0°

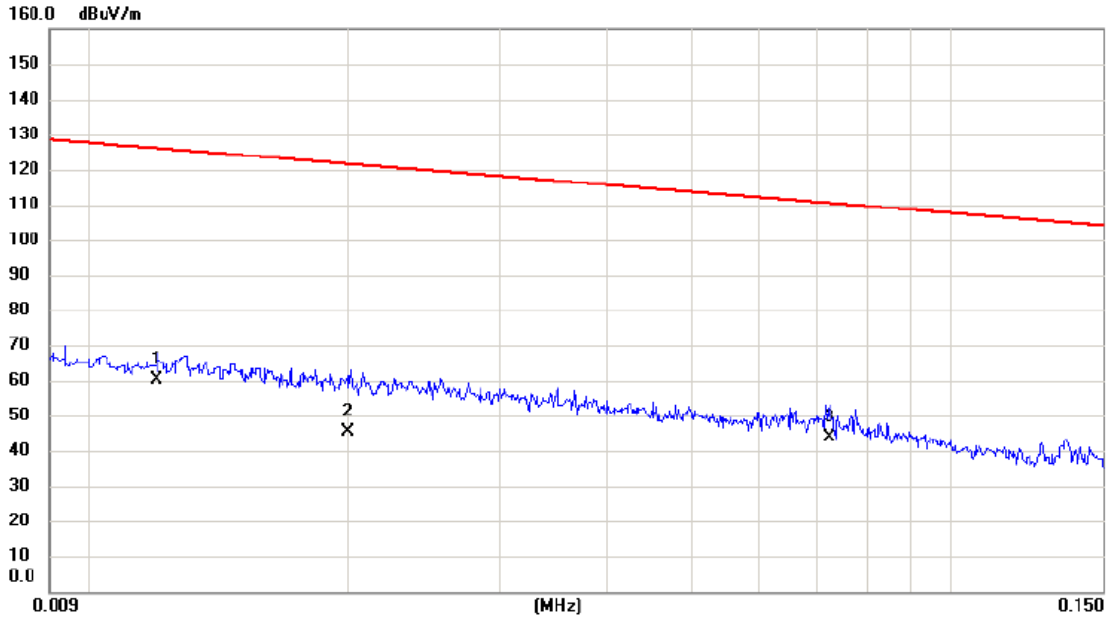

No.	Mk.	Freq. MHz	Reading Level dBuV	Correct Factor dB	Measure- ment dBuV/m	Limit dBuV/m	Margin dB	Detector	Comment
1	*	0.0120	39.48	20.66	60.14	126.02	-65.88	AVG	
2		0.0200	25.76	19.62	45.38	121.58	-76.20	AVG	
3		0.0724	25.63	18.28	43.91	110.41	-66.50	AVG	

Test Mode: TX Mode (Adapter: HUAWEI)

Ant 0°

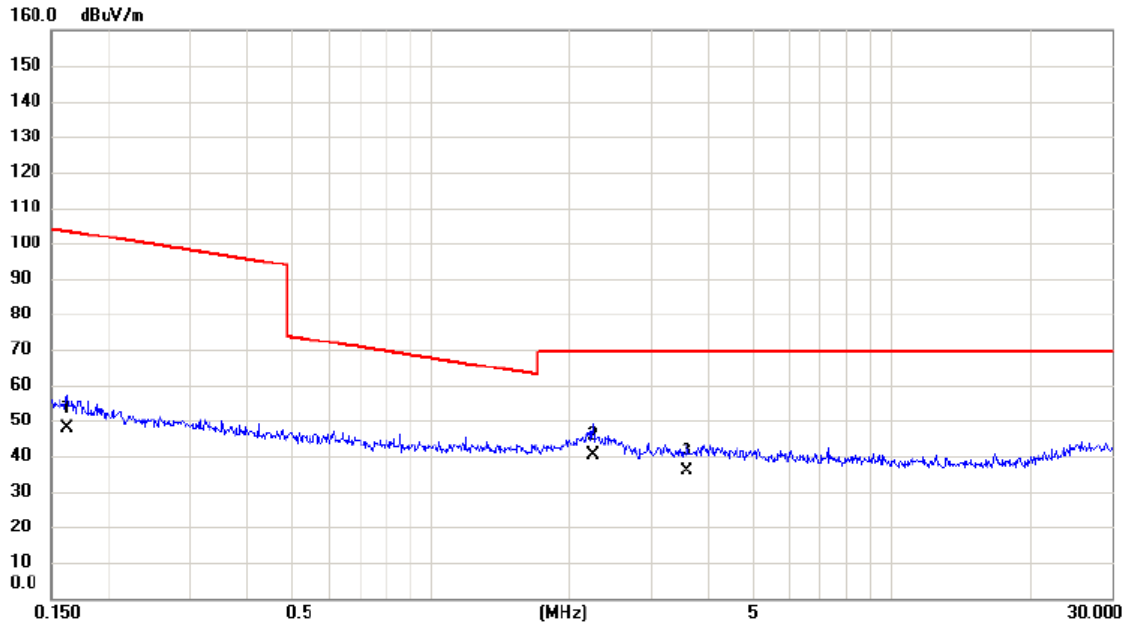

No.	Mk.	Freq. MHz	Reading Level dBuV	Correct Factor dB	Measure- ment dBuV/m	Limit dBuV/m	Margin dB	Detector	Comment
1		0.1624	30.85	16.91	47.76	103.40	-55.64	AVG	
2	*	2.2486	24.69	15.44	40.13	69.54	-29.41	QP	
3		3.5843	20.57	15.06	35.63	69.54	-33.91	QP	

Test Mode: TX Mode (Adapter: HUAWEI)

Ant 90°

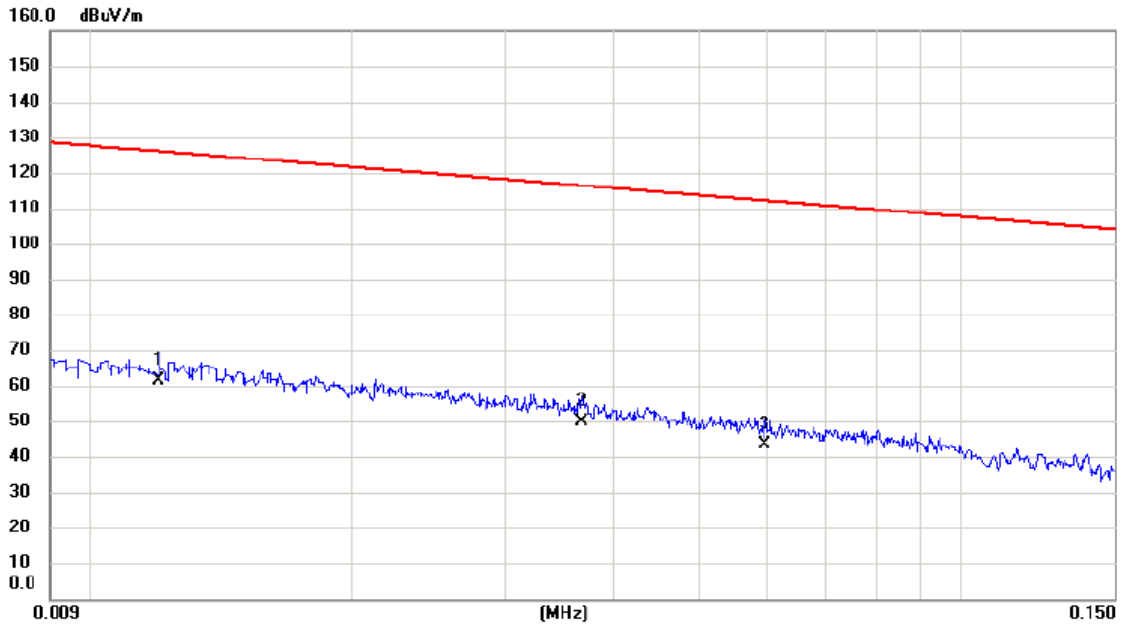

No.	Mk.	Freq. MHz	Reading Level dBuV	Correct Factor dB	Measure- ment dBuV/m	Limit dBuV/m	Margin dB	Detector	Comment
1	*	0.0120	40.86	20.66	61.52	126.02	-64.50	AVG	
2		0.0367	30.64	19.12	49.76	116.31	-66.55	AVG	
3		0.0594	24.69	18.54	43.23	112.13	-68.90	AVG	

Test Mode: TX Mode (Adapter: HUAWEI)

Ant 90°

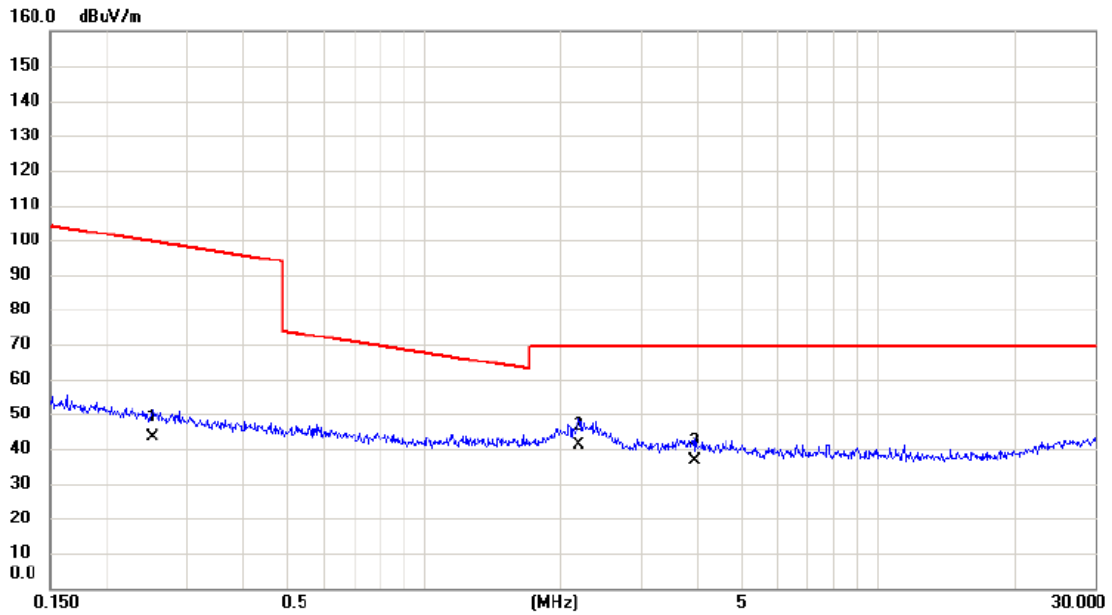

No.	Mk.	Freq. MHz	Reading Level dBuV	Correct Factor dB	Measure- ment dBuV/m	Limit dBuV/m	Margin dB	Detector	Comment
1		0.2521	26.59	16.66	43.25	99.57	-56.32	AVG	
2	*	2.1898	25.74	15.45	41.19	69.54	-28.35	QP	
3		3.9430	21.63	14.97	36.60	69.54	-32.94	QP	

Test Mode: LTE Band 26\_TX CH26740\_1.4M\_Top Ant

Vertical

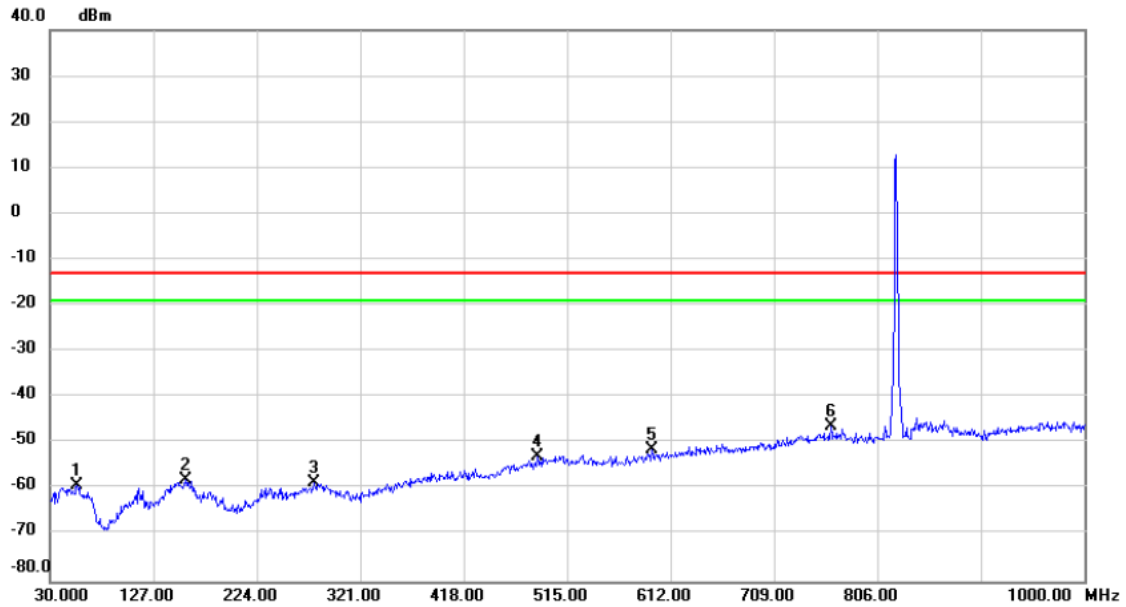

No.	Mk.	Freq. MHz	Reading Level dBm	Correct Factor dB	Measure- ment dBm	Limit dBm	Margin dB	Detector	Comment
1		55.220	-63.81	4.57	-59.24	-13.00	-46.24	peak	
2		157.070	-67.50	9.46	-58.04	-13.00	-45.04	peak	
3		277.350	-67.02	8.43	-58.59	-13.00	-45.59	peak	
4		486.870	-67.14	14.39	-52.75	-13.00	-39.75	peak	
5		594.540	-67.25	15.89	-51.36	-13.00	-38.36	peak	
6	*	762.350	-65.21	18.91	-46.30	-13.00	-33.30	peak	



Test Mode: LTE Band 26\_TX CH26740\_1.4M\_Top Ant

### Horizontal

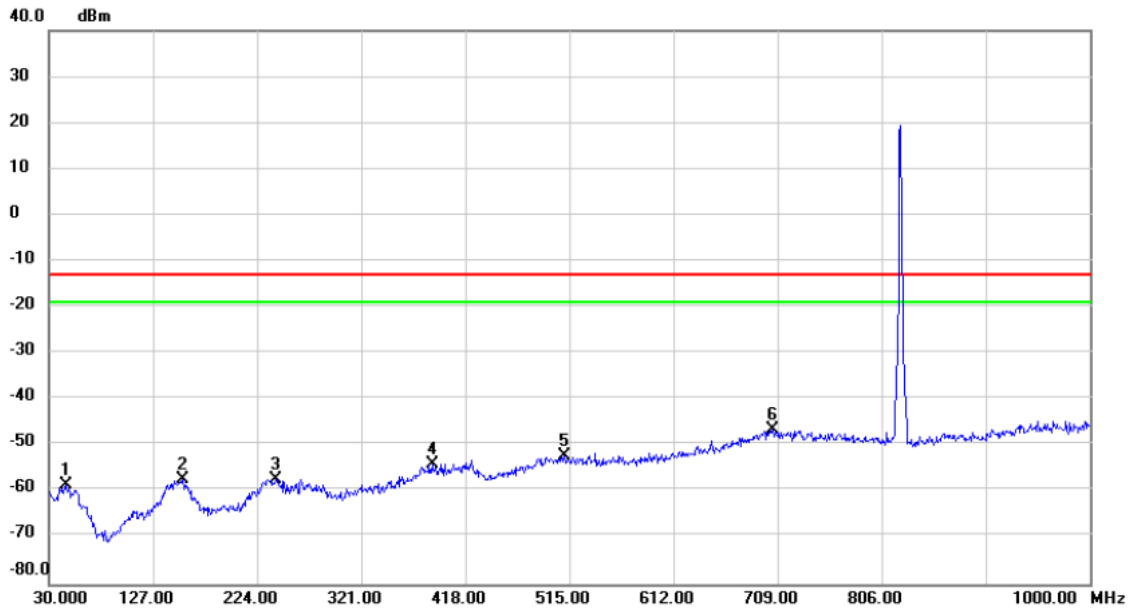

No.	Mk.	Freq. MHz	Reading Level dBm	Correct Factor dB	Measure- ment dBm	Limit dBm	Margin dB	Detector	Comment
1		45.520	-61.16	2.75	-58.41	-13.00	-45.41	peak	
2		155.130	-66.87	9.60	-57.27	-13.00	-44.27	peak	
3		241.460	-64.04	6.71	-57.33	-13.00	-44.33	peak	
4		386.960	-66.77	12.71	-54.06	-13.00	-41.06	peak	
5		510.150	-66.84	14.58	-52.26	-13.00	-39.26	peak	
6	*	704.150	-64.20	17.52	-46.68	-13.00	-33.68	peak	

Test Mode: LTE Band 26\_TX CH26740\_1.4M\_Top Ant

Vertical

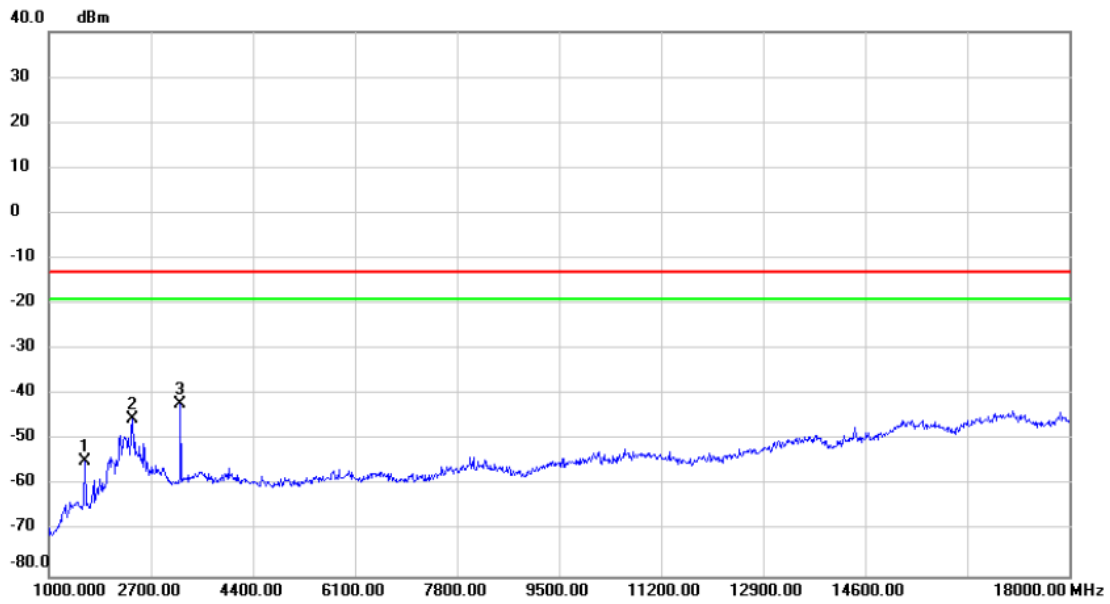

No.	Mk.	Freq. MHz	Reading Level dBm	Correct Factor dB	Measure- ment dBm	Limit dBm	Margin dB	Detector	Comment
1		1595.000	-45.38	-9.12	-54.50	-13.00	-41.50	peak	
2		2394.000	-39.34	-6.12	-45.46	-13.00	-32.46	peak	
3	*	3193.000	-38.05	-4.12	-42.17	-13.00	-29.17	peak	

Test Mode: LTE Band 26\_TX CH26740\_1.4M\_Top Ant

**Horizontal**

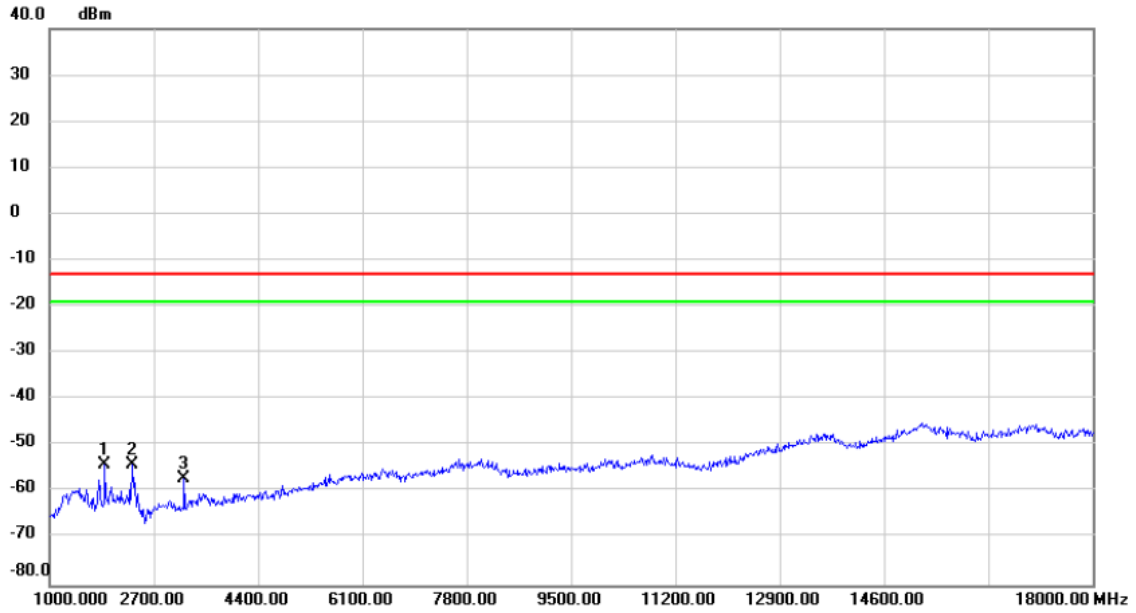

No.	Mk.	Freq. MHz	Reading Level dBm	Correct Factor dB	Measure- ment dBm	Limit dBm	Margin dB	Detector	Comment
1		1901.000	-45.21	-8.75	-53.96	-13.00	-40.96	peak	
2	*	2343.000	-47.49	-6.45	-53.94	-13.00	-40.94	peak	
3		3193.000	-52.93	-4.12	-57.05	-13.00	-44.05	peak	

Test Mode: LTE Band 26\_TX CH26740\_10M\_Top Ant

Vertical

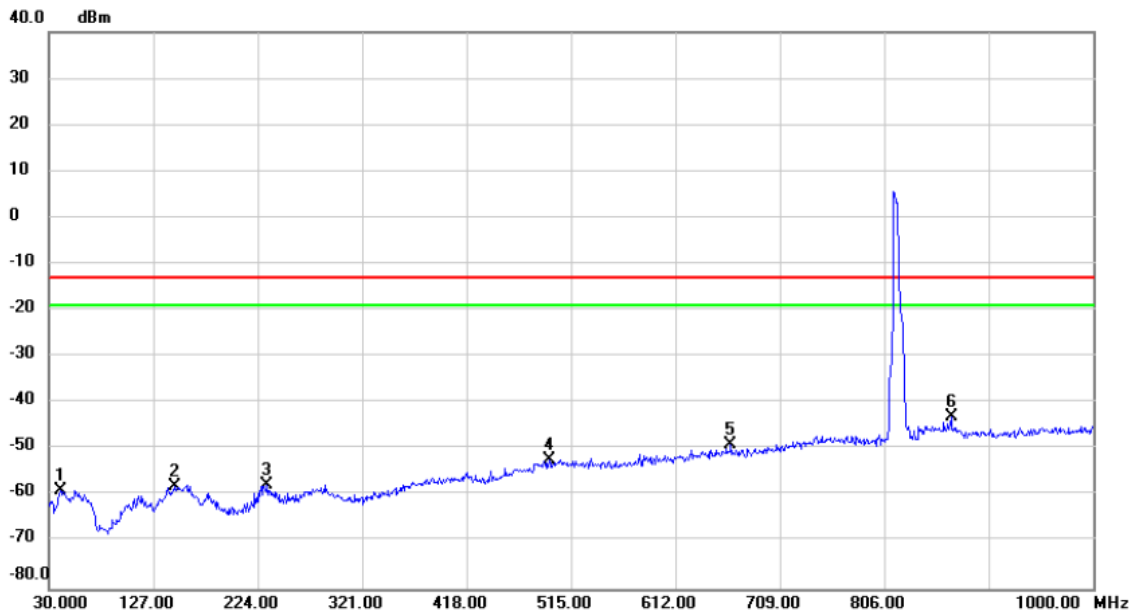

No.	Mk.	Freq. MHz	Reading Level dBm	Correct Factor dB	Measure- ment dBm	Limit dBm	Margin dB	Detector	Comment
1		40.670	-59.84	1.11	-58.73	-13.00	-45.73	peak	
2		146.400	-68.14	10.07	-58.07	-13.00	-45.07	peak	
3		232.730	-63.87	6.23	-57.64	-13.00	-44.64	peak	
4		494.630	-66.71	14.47	-52.24	-13.00	-39.24	peak	
5		663.410	-65.90	16.96	-48.94	-13.00	-35.94	peak	
6	*	868.080	-63.89	20.93	-42.96	-13.00	-29.96	peak	

Test Mode: LTE Band 26\_TX CH26740\_10M\_Top Ant

### Horizontal

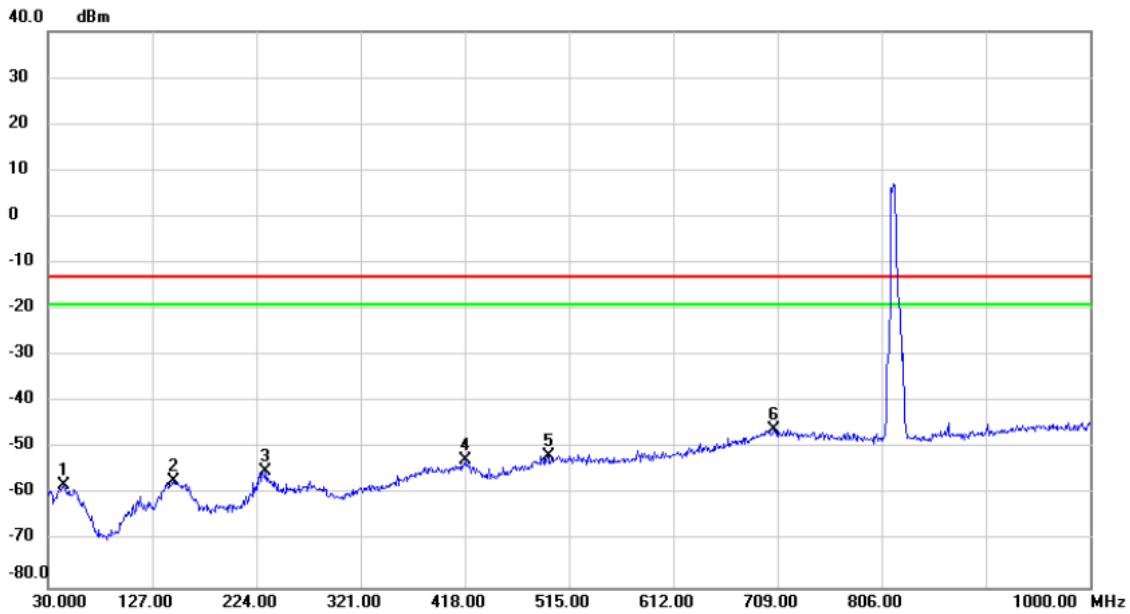

No. Mk.	Freq. MHz	Reading Level dBm	Correct Factor dB	Measure- ment dBm	Limit dBm	Margin dB	Detector	Comment
1	44.550	-60.30	2.28	-58.02	-13.00	-45.02	peak	
2	146.400	-67.09	10.07	-57.02	-13.00	-44.02	peak	
3	232.730	-61.26	6.23	-55.03	-13.00	-42.03	peak	
4	418.970	-66.28	13.59	-52.69	-13.00	-39.69	peak	
5	495.600	-66.20	14.48	-51.72	-13.00	-38.72	peak	
6 *	705.120	-63.35	17.54	-45.81	-13.00	-32.81	peak	

Test Mode: LTE Band 26\_TX CH26740\_10M\_Top Ant

**Vertical**

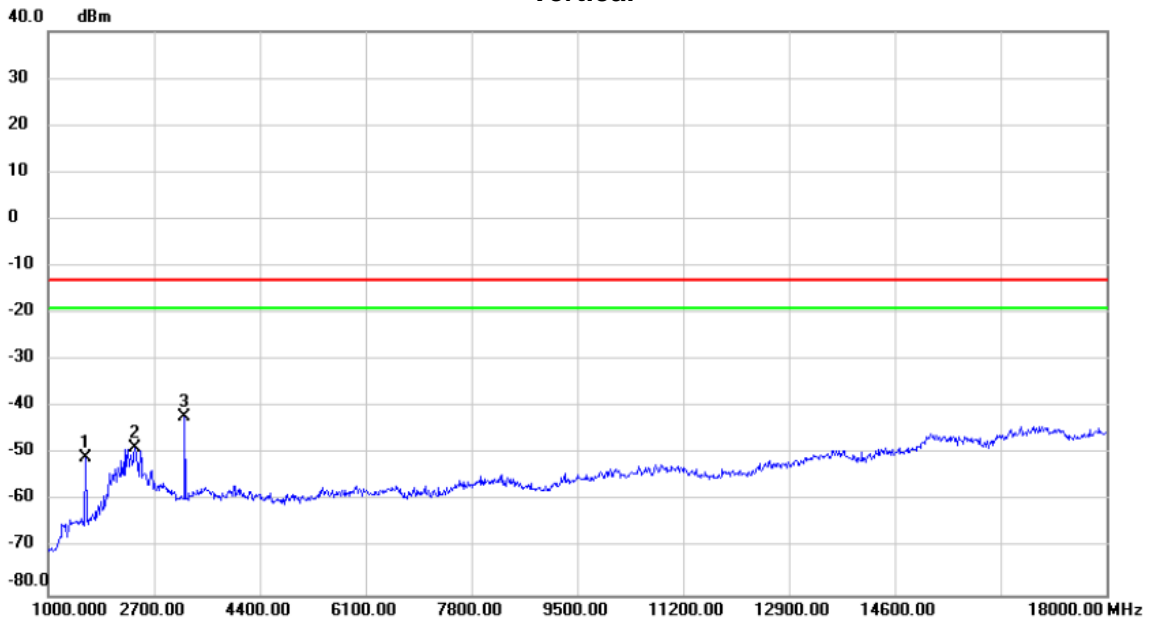

No.	Mk.	Freq. MHz	Reading Level dBm	Correct Factor dB	Measure- ment dBm	Limit dBm	Margin dB	Detector	Comment
1		1595.000	-41.76	-9.12	-50.88	-13.00	-37.88	peak	
2		2394.000	-42.67	-6.12	-48.79	-13.00	-35.79	peak	
3	*	3193.000	-38.04	-4.12	-42.16	-13.00	-29.16	peak	

Test Mode: LTE Band 26\_TX CH26740\_10M\_Top Ant

**Horizontal**

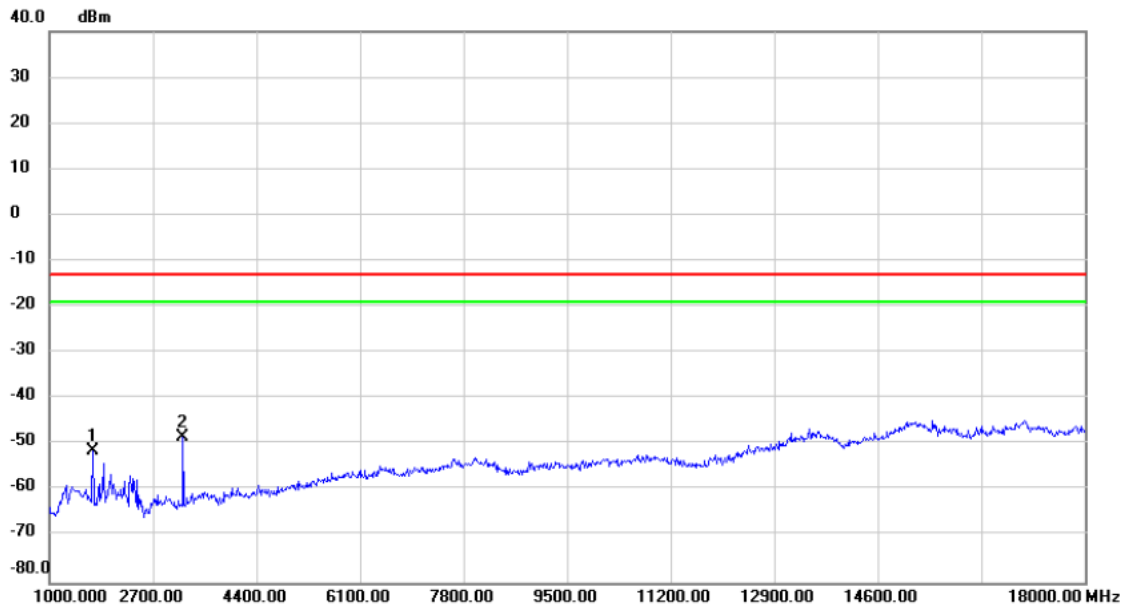

No.	Mk.	Freq. MHz	Reading Level dBm	Correct Factor dB	Measure- ment dBm	Limit dBm	Margin dB	Detector	Comment
1		1714.000	-42.43	-8.98	-51.41	-13.00	-38.41	peak	
2	*	3193.000	-44.29	-4.12	-48.41	-13.00	-35.41	peak	

Test Mode: LTE Band 26\_TX CH26740\_1.4M\_Bottom Ant

Vertical

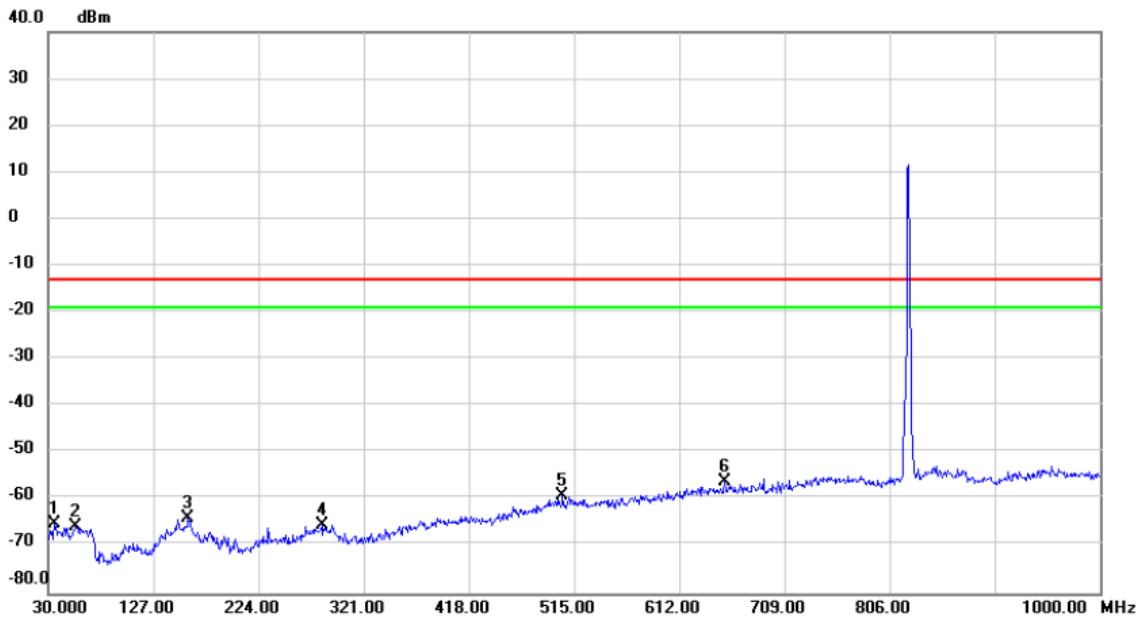

No.	Mk.	Freq. MHz	Reading Level dBm	Correct Factor dB	Measure- ment dBm	Limit dBm	Margin dB	Detector	Comment
1		35.820	-68.37	3.13	-65.24	-13.00	-52.24	peak	
2		55.220	-70.24	4.57	-65.67	-13.00	-52.67	peak	
3		159.010	-73.23	9.31	-63.92	-13.00	-50.92	peak	
4		282.200	-74.23	8.66	-65.57	-13.00	-52.57	peak	
5		504.330	-73.70	14.55	-59.15	-13.00	-46.15	peak	
6	*	653.710	-72.98	16.84	-56.14	-13.00	-43.14	peak	



Test Mode: LTE Band 26\_TX CH26740\_1.4M\_Bottom Ant

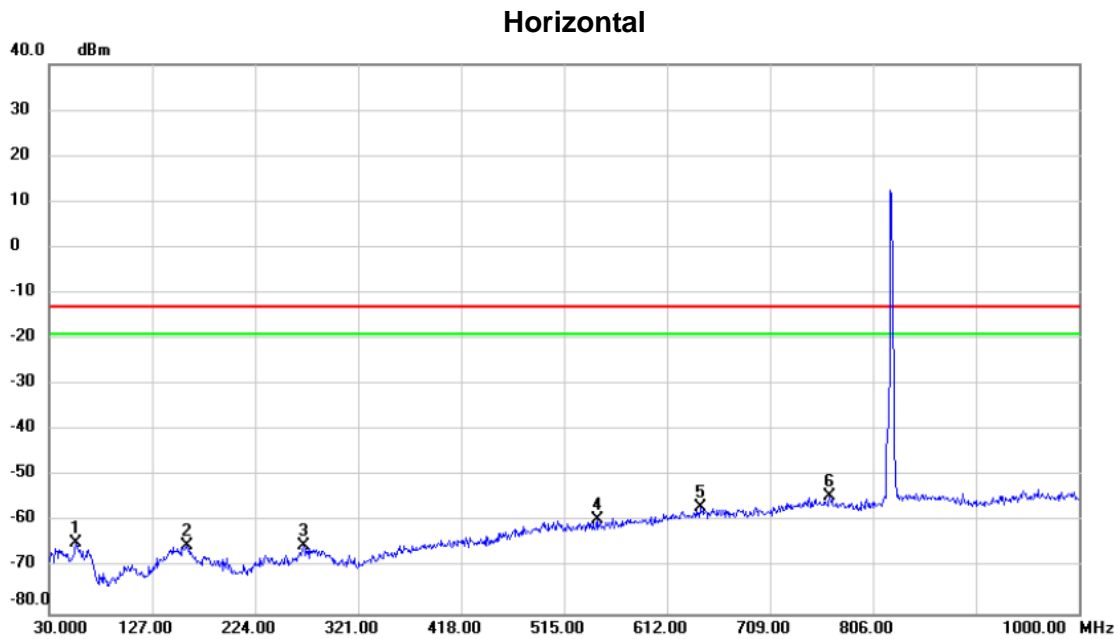

No.	Mk.	Freq. MHz	Reading Level dBm	Correct Factor dB	Measure- ment dBm	Limit dBm	Margin dB	Detector	Comment
1		55.220	-69.22	4.57	-64.65	-13.00	-51.65	peak	
2		159.980	-74.39	9.24	-65.15	-13.00	-52.15	peak	
3		269.590	-73.13	7.83	-65.30	-13.00	-52.30	peak	
4		546.040	-74.25	14.76	-59.49	-13.00	-46.49	peak	
5		643.040	-73.38	16.68	-56.70	-13.00	-43.70	peak	
6	*	765.260	-73.31	19.00	-54.31	-13.00	-41.31	peak	

Test Mode: LTE Band 26\_TX CH26740\_1.4M\_Bottom Ant

**Vertical**

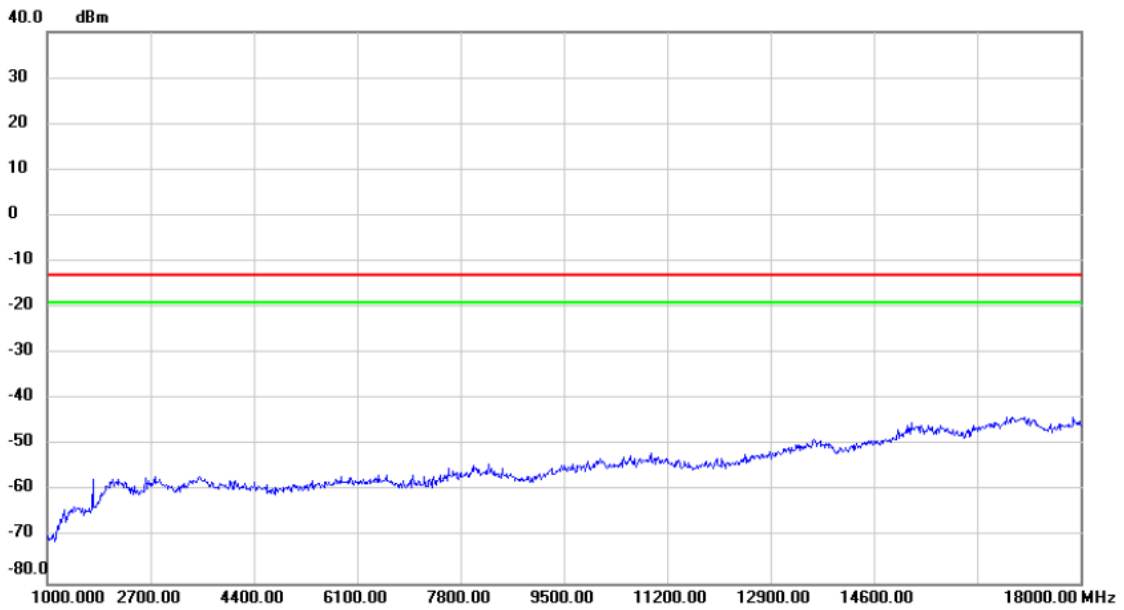

No.	Mk.	Freq.	Reading Level	Correct Factor	Measurement	Limit	Margin	Detector	Comment
		MHz	dBm	dB	dBm	dBm	dB		

Test Mode: LTE Band 26\_TX CH26740\_1.4M\_Bottom Ant

**Horizontal**

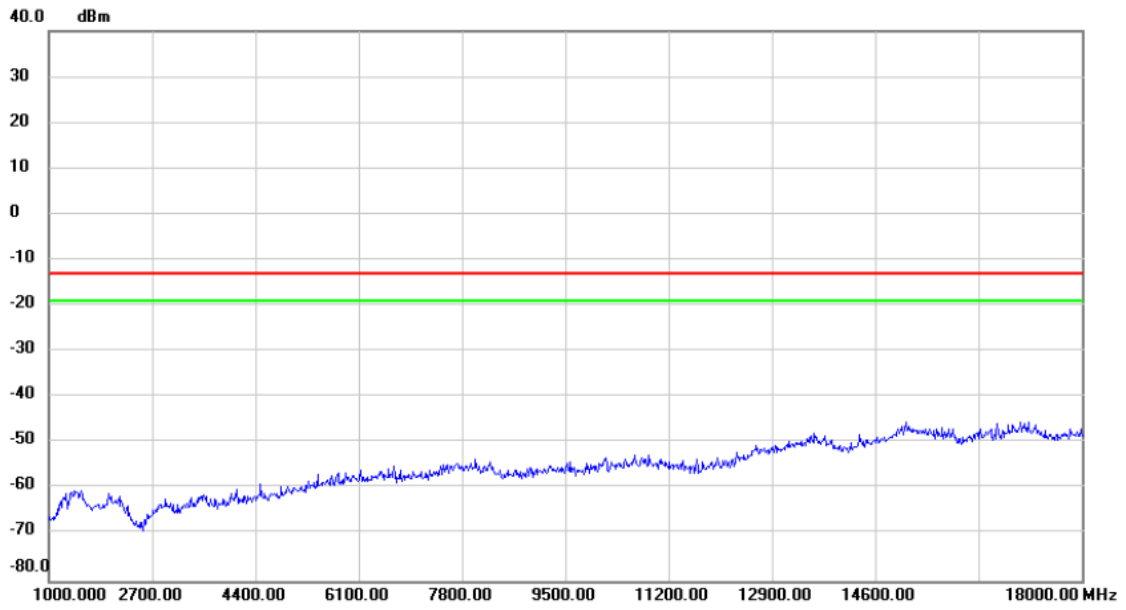

No.	Mk.	Freq.	Reading Level	Correct Factor	Measurement	Limit	Margin	Detector	Comment
		MHz	dBm	dB	dBm	dBm	dB		

Test Mode: LTE Band 26\_TX CH26740\_10M\_Bottom Ant

Vertical

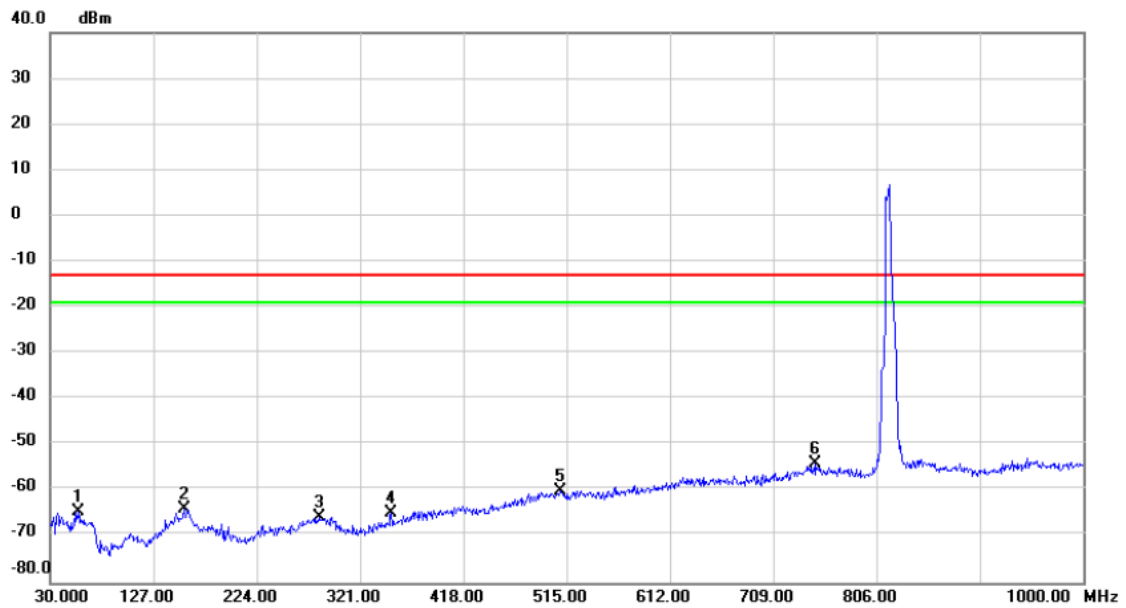

No. Mk.	Freq. MHz	Reading Level dBm	Correct Factor dB	Measurement dBm	Limit dBm	Margin dB	Detector	Comment
1	56.190	-69.06	4.39	-64.67	-13.00	-51.67	peak	
2	156.100	-73.54	9.53	-64.01	-13.00	-51.01	peak	
3	282.200	-74.36	8.66	-65.70	-13.00	-52.70	peak	
4	350.100	-75.75	10.90	-64.85	-13.00	-51.85	peak	
5	509.180	-74.77	14.58	-60.19	-13.00	-47.19	peak	
6 *	748.770	-72.58	18.50	-54.08	-13.00	-41.08	peak	

Test Mode: LTE Band 26\_TX CH26740\_10M\_Bottom Ant

### Horizontal

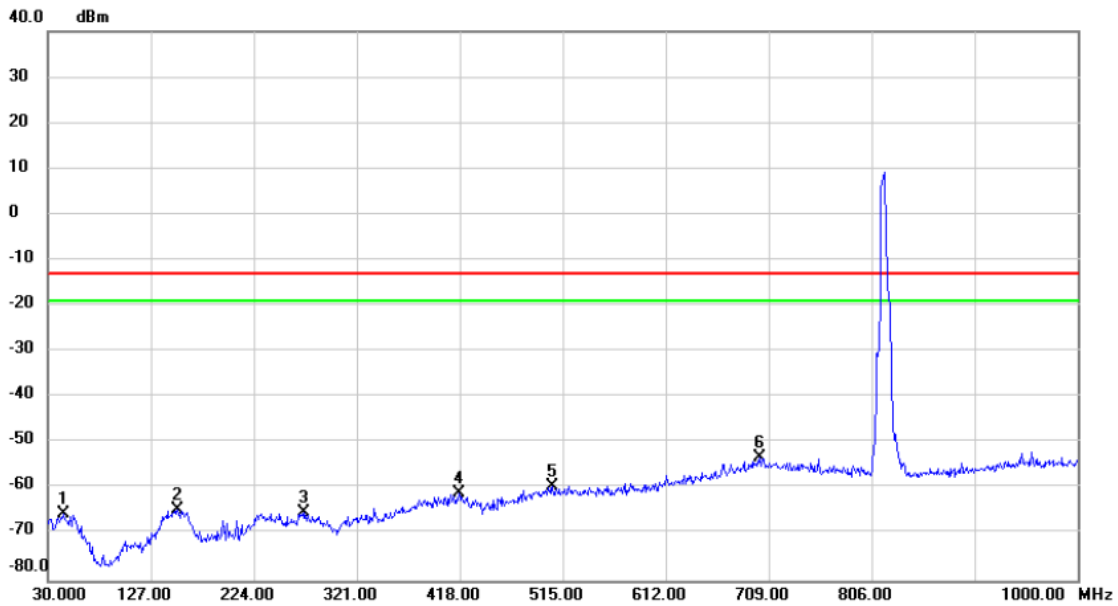

No.	Mk.	Freq. MHz	Reading Level dBm	Correct Factor dB	Measure- ment dBm	Limit dBm	Margin dB	Detector	Comment
1		44.550	-67.69	2.28	-65.41	-13.00	-52.41	peak	
2		152.220	-74.49	9.82	-64.67	-13.00	-51.67	peak	
3		270.560	-72.95	7.89	-65.06	-13.00	-52.06	peak	
4		417.030	-74.53	13.56	-60.97	-13.00	-47.97	peak	
5		505.300	-73.97	14.56	-59.41	-13.00	-46.41	peak	
6	*	700.270	-70.62	17.44	-53.18	-13.00	-40.18	peak	

Test Mode: LTE Band 26\_TX CH26740\_10M\_Bottom Ant

**Vertical**

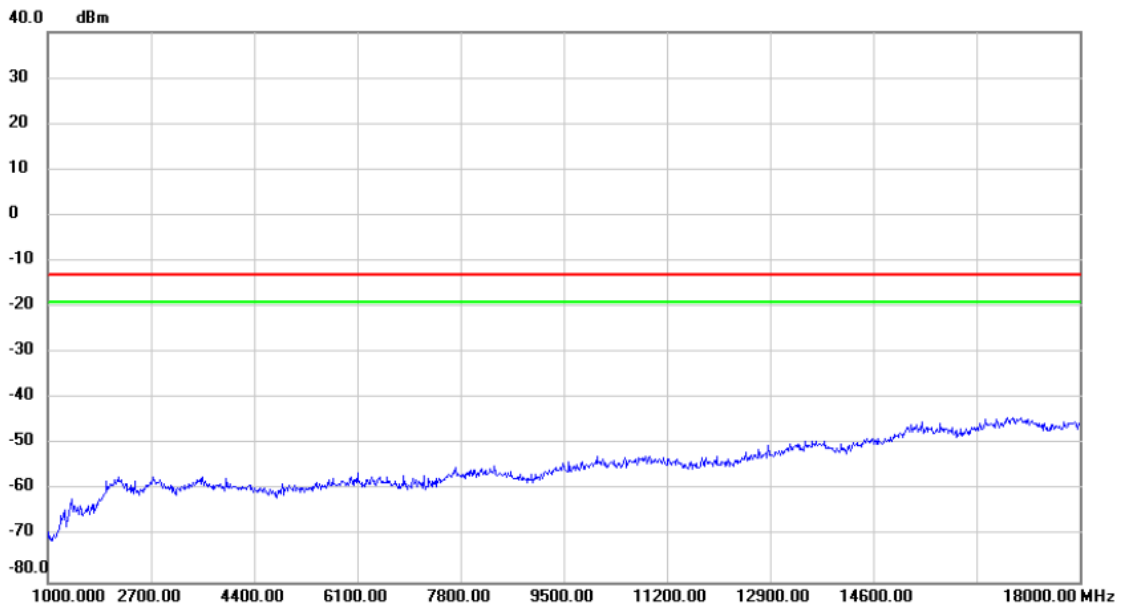

No.	Mk.	Freq.	Reading Level	Correct Factor	Measurement	Limit	Margin	Detector	Comment
		MHz	dBm	dB	dBm	dBm	dB		

Test Mode: LTE Band 26\_TX CH26740\_10M\_Bottom Ant

**Horizontal**

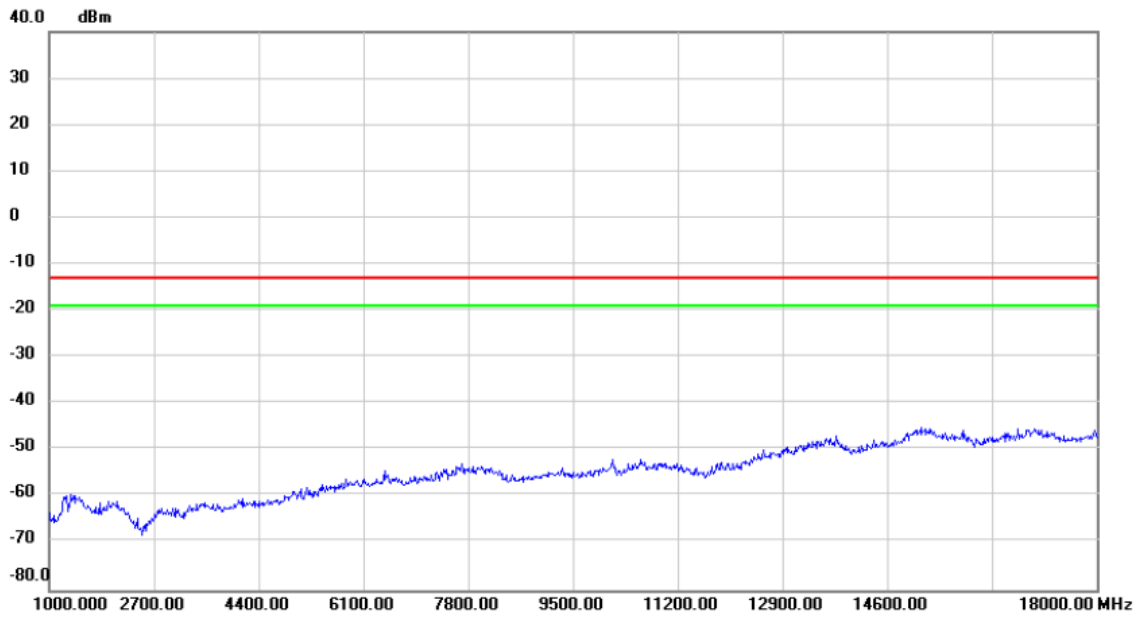

No.	Mk.	Freq.	Reading Level	Correct Factor	Measurement	Limit	Margin	Detector	Comment
		MHz	dBm	dB	dBm	dBm	dB		

## APPENDIX E - EMISSION MASK



LTE Band 26\_1.4M

1RB0		1RB5	
Channel	26697	Channel	26783

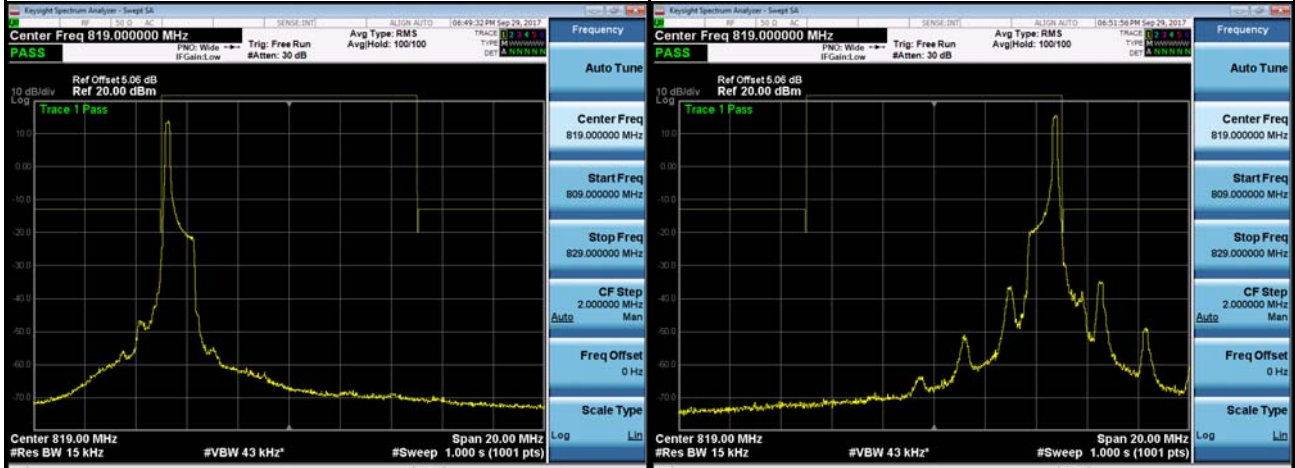

6RB0

26697		26783	
Channel	26697	Channel	26783

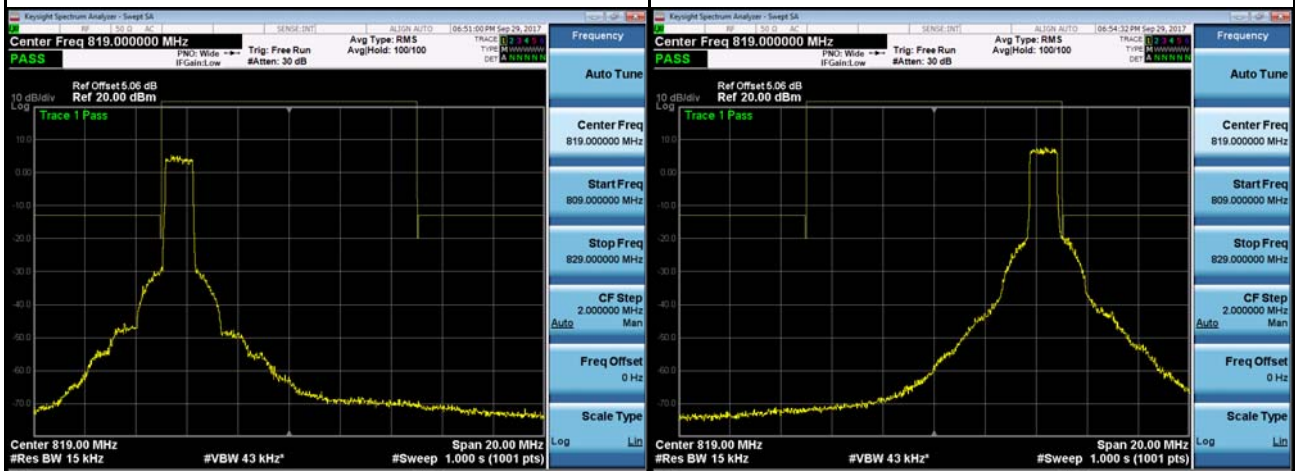

LTE Band 26\_3M

1RB0

1RB14

Channel

26705

Channel

26775

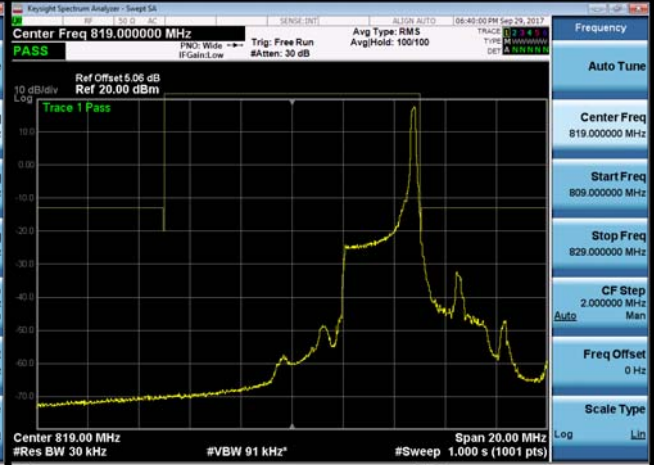
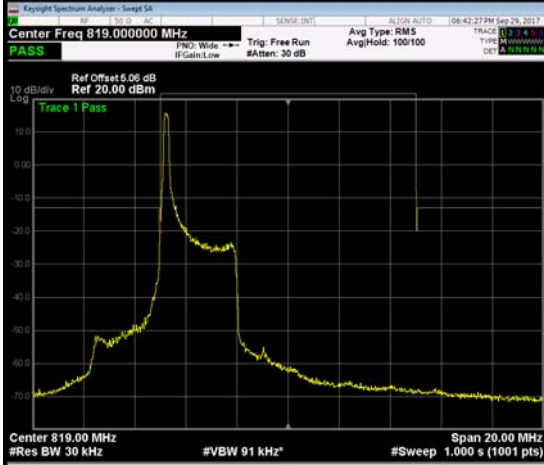

15RB0

Channel

26705

Channel

26775

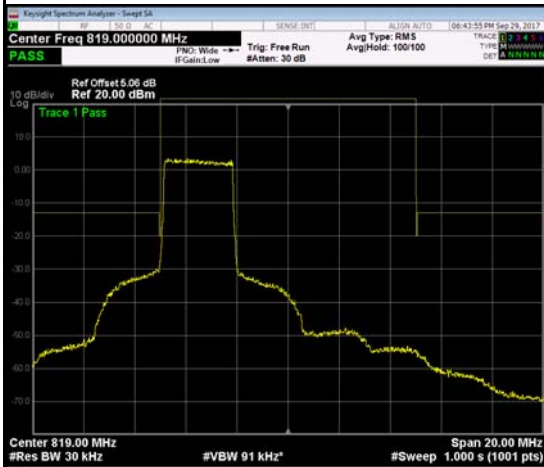

LTE Band 26\_5M

1RB0

1RB24

Channel

26715

Channel

26765

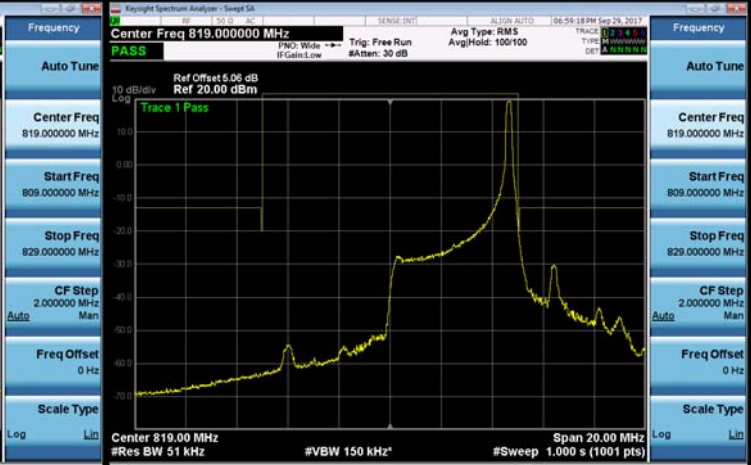
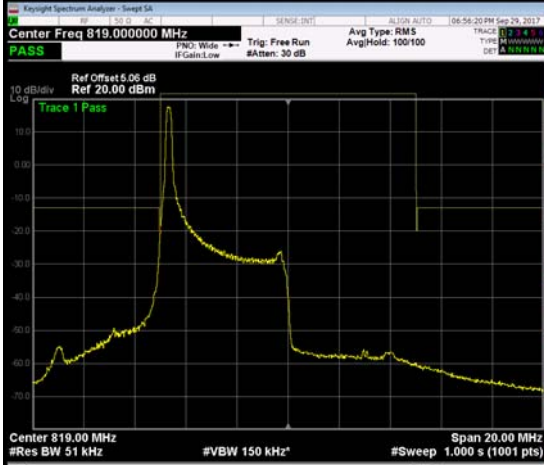

25RB0

Channel

26715

Channel

26765

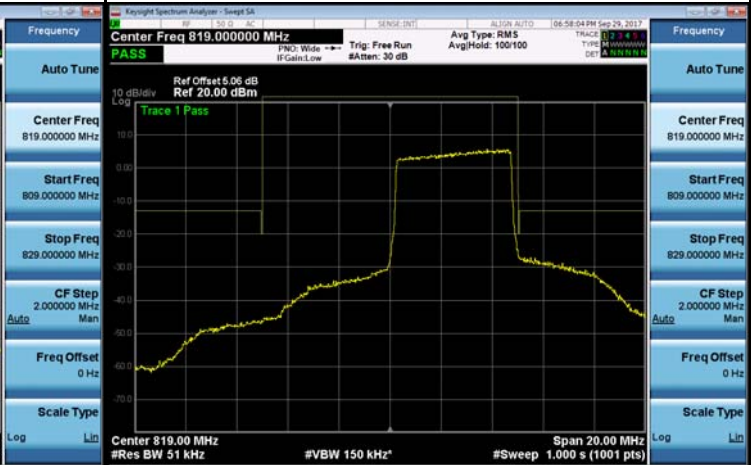
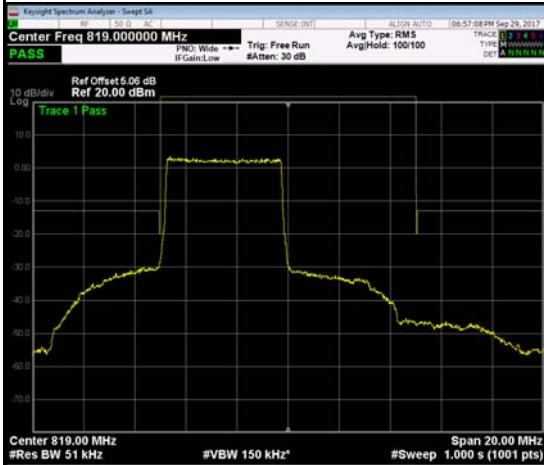

LTE Band 26\_10M

1RB0

1RB50

Channel

26740

Channel

26740

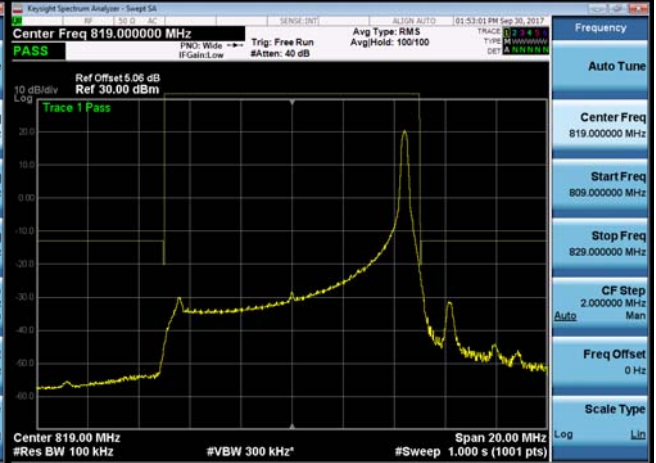
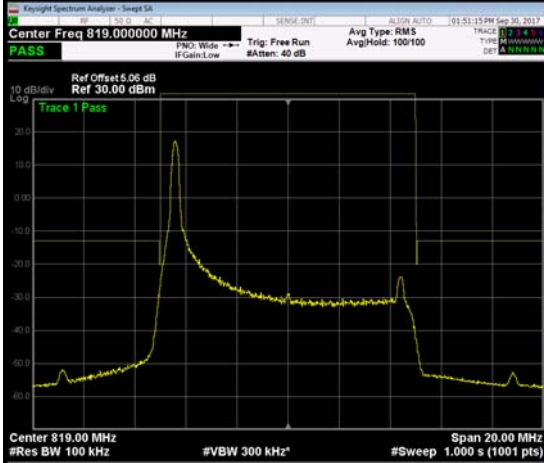

50RB0

-

Channel

26740

-

-



## APPENDIX F - FREQUENCY STABILITY

Test Mode:	LTE Band 26_CH26740_1.4M
------------	--------------------------

### Temperature vs. Frequency Stability

Temperature(°C)	Frequency Error (Hz)	Frequency Error (ppm)	Limit(ppm)
-30	1.73	0.002112332	2.5
-20	-2.41	0.002942613	2.5
-10	3.36	0.004102564	2.5
0	-2.26	0.002759463	2.5
10	1.99	0.002429792	2.5
20	3.78	0.004615385	2.5
30	4.05	0.004945055	2.5
40	-3.66	0.004468864	2.5
50	2.84	0.003467643	2.5
Max. Deviation (ppm)	<b>4.05</b>	<b>0.004945055</b>	2.5

### Voltage vs. Frequency Stability

Voltage(Volts)	Frequency Error (Hz)	Frequency Error (ppm)	Limit(ppm)
3.50	2.54	0.003101343	2.5
3.82	-3.49	0.004261294	2.5
4.35	3.86	0.004713065	2.5
Max. Deviation (ppm)	<b>3.86</b>	<b>0.004713065</b>	2.5

Test Mode:	LTE Band 26_CH26740_3M
------------	------------------------

### Temperature vs. Frequency Stability

Temperature(°C)	Frequency Error (Hz)	Frequency Error (ppm)	Limit(ppm)
-30	2.58	0.003150183	2.5
-20	3.35	0.004090354	2.5
-10	-2.44	0.002979243	2.5
0	-1.83	0.002234432	2.5
10	4.10	0.005006105	2.5
20	2.69	0.003284493	2.5
30	3.46	0.004224664	2.5
40	2.19	0.002673993	2.5
50	-4.08	0.004981685	2.5
Max. Deviation (ppm)	<b>4.1</b>	<b>0.005006105</b>	2.5

### Voltage vs. Frequency Stability

Voltage(Volts)	Frequency Error (Hz)	Frequency Error (ppm)	Limit(ppm)
3.50	-2.71	0.003308913	2.5
3.82	-3.24	0.003956044	2.5
4.35	3.43	0.004188034	2.5
Max. Deviation (ppm)	<b>3.43</b>	<b>0.004188034</b>	2.5

Test Mode:	LTE Band 26_CH26740_5M
------------	------------------------

### Temperature vs. Frequency Stability

Temperature(°C)	Frequency Error (Hz)	Frequency Error (ppm)	Limit(ppm)
-30	3.76	0.004590965	2.5
-20	2.94	0.003589744	2.5
-10	3.48	0.004249084	2.5
0	-2.81	0.003431013	2.5
10	-1.42	0.001733822	2.5
20	1.67	0.002039072	2.5
30	-2.19	0.002673993	2.5
40	-3.73	0.004554335	2.5
50	2.81	0.003431013	2.5
Max. Deviation (ppm)	<b>3.76</b>	<b>0.004590965</b>	2.5

### Voltage vs. Frequency Stability

Voltage(Volts)	Frequency Error (Hz)	Frequency Error (ppm)	Limit(ppm)
3.50	1.86	0.002271062	2.5
3.82	2.80	0.003418803	2.5
4.35	2.61	0.003186813	2.5
Max. Deviation (ppm)	<b>2.8</b>	<b>0.003418803</b>	2.5



Test Mode:	LTE Band 26_CH26740_10M
------------	-------------------------

### Temperature vs. Frequency Stability

Temperature(°C)	Frequency Error (Hz)	Frequency Error (ppm)	Limit(ppm)
-30	1.81	0.002210012	2.5
-20	2.21	0.002698413	2.5
-10	3.79	0.004627595	2.5
0	-3.33	0.004065934	2.5
10	2.88	0.003516484	2.5
20	2.74	0.003345543	2.5
30	-3.44	0.004200244	2.5
40	-3.80	0.004639805	2.5
50	1.93	0.002356532	2.5
Max. Deviation (ppm)	<b>3.8</b>	<b>0.004639805</b>	2.5

### Voltage vs. Frequency Stability

Voltage(Volts)	Frequency Error (Hz)	Frequency Error (ppm)	Limit(ppm)
3.50	-3.47	0.004236874	2.5
3.82	2.58	0.003150183	2.5
4.35	3.11	0.003797314	2.5
Max. Deviation (ppm)	3.47	<b>0.004236874</b>	2.5