



RF TEST REPORT

Applicant Huawei Technologies Co., Ltd.
FCC ID QISAGS2-L09
Product Tablet
Model AGS2-L09
Report No. R1806H0068-R3
Issue Date June 26, 2018

TA Technology (Shanghai) Co., Ltd. tested the above equipment in accordance with the requirements in **FCC CFR47 Part 2 (2017)/ FCC CFR47 Part 27C (2017)**. The test results show that the equipment tested is capable of demonstrating compliance with the requirements as documented in this report.

Performed by: Jiangpeng Lan

Approved by: Kai Xu

TA Technology (Shanghai) Co., Ltd.

No.145, Jintang Rd, Tangzhen Industry Park, Pudong Shanghai, China

TEL: +86-021-50791141/2/3

FAX: +86-021-50791141/2/3-8000

Table of Contents

| | | |
|-----|--|----|
| 1 | Test Laboratory..... | 4 |
| 1.1 | Notes of the Test Report..... | 4 |
| 1.2 | Test facility..... | 4 |
| 1.3 | Testing Location..... | 5 |
| 2 | General Description of Equipment under Test..... | 6 |
| 3 | Applied Standards..... | 7 |
| 4 | Test Configuration..... | 8 |
| 5 | Test Case Results..... | 9 |
| 5.1 | RF Power Output..... | 9 |
| 5.2 | Effective Isotropic Radiated Power..... | 12 |
| 5.3 | Occupied Bandwidth..... | 16 |
| 5.4 | Band Edge Compliance..... | 22 |
| 5.5 | Peak-to-Average Power Ratio (PAPR)..... | 30 |
| 5.6 | Frequency Stability..... | 32 |
| 5.7 | Spurious Emissions at Antenna Terminals..... | 34 |
| 5.8 | Radiates Spurious Emission..... | 41 |
| 6 | Main Test Instruments..... | 44 |

Summary of Measurement Results

| Number | Test Case | Clause in FCC rules | Verdict |
|---|---|-----------------------------|---------|
| 1 | RF power output | 2.1046 | PASS |
| 2 | Effective Isotropic Radiated power | 27.50(h)(2) | PASS |
| 3 | Occupied Bandwidth | 2.1049 | PASS |
| 4 | Band Edge Compliance | 27.53(m) | PASS |
| 5 | Peak-to-Average Power Ratio | 27.50(d)/KDB971168 D01(5.7) | PASS |
| 6 | Frequency Stability | 2.1055 / 27.54 | PASS |
| 7 | Spurious Emissions at Antenna Terminals | 2.1051 / 27.53(m) | PASS |
| 8 | Radiates Spurious Emission | 2.1053 / 27.53(m) | PASS |
| Date of Testing: June 6, 2018 ~ June 22, 2018 | | | |
| Note: PASS: The EUT complies with the essential requirements in the standard. FAIL: The EUT does not comply with the essential requirements in the standard. | | | |

1 Test Laboratory

1.1 Notes of the Test Report

This report shall not be reproduced in full or partial, without the written approval of **TA technology (shanghai) co., Ltd.** The results documented in this report apply only to the tested sample, under the conditions and modes of operation as described herein .Measurement Uncertainties were not taken into account and are published for informational purposes only. This report is written to support regulatory compliance of the applicable standards stated above.

1.2 Test facility

CNAS (accreditation number: L2264)

TA Technology (Shanghai) Co., Ltd. has obtained the accreditation of China National Accreditation Service for Conformity Assessment (CNAS).

FCC (Designation number: CN1179, Test Firm Registration Number: 446626)

TA Technology (Shanghai) Co., Ltd. has been listed on the US Federal Communications Commission list of test facilities recognized to perform electromagnetic emissions measurements.

IC (recognition number is 8510A)

TA Technology (Shanghai) Co., Ltd. has been listed by industry Canada to perform electromagnetic emission measurement.

VCCI (recognition number is C-4595, T-2154, R-4113, G-10766)

TA Technology (Shanghai) Co., Ltd. has been listed by industry Japan to perform electromagnetic emission measurement.

A2LA (Certificate Number: 3857.01)

TA Technology (Shanghai) Co., Ltd. has been listed by American Association for Laboratory Accreditation to perform electromagnetic emission measurement.

1.3 Testing Location

Company: TA Technology (Shanghai) Co., Ltd.
Address: No.145, Jintang Rd, Tangzhen Industry Park, Pudong Shanghai, China
City: Shanghai
Post code: 201201
Country: P. R. China
Contact: Xu Kai
Telephone: +86-021-50791141/2/3
Fax: +86-021-50791141/2/3-8000
Website: <http://www.ta-shanghai.com>
E-mail: xukai@ta-shanghai.com

2 General Description of Equipment under Test

Client Information

| | |
|-----------------------------|--|
| Applicant | Huawei Technologies Co., Ltd. |
| Applicant address | Administration Building, Headquarters of Huawei Technologies Co., Ltd., Bantian, Longgang District, Shenzhen, 518129, P.R.China. |
| Manufacturer | Huawei Technologies Co., Ltd. |
| Manufacturer address | Administration Building, Headquarters of Huawei Technologies Co., Ltd., Bantian, Longgang District, Shenzhen, 518129, P.R.China. |

General information

| EUT Description | | | |
|--|--|-------------|-------------|
| Model | AGS2-L09 | | |
| IMEI | 004401721144414 | | |
| Hardware Version | A6t6e | | |
| Software Version | AGS2-L09 8.0.0.1(SP1C432log) | | |
| Power Supply | Battery/AC adapter | | |
| Antenna Type | Internal Antenna | | |
| Test Mode(s) | LTE Band 7 | | |
| Test Modulation | (LTE)QPSK 16QAM; | | |
| LTE Category | 6 | | |
| Maximum E.I.R.P./ E.R.P. | LTE Band 7: | 23.63dBm | |
| Rated Power Supply Voltage: | 3.8V | | |
| Extreme Voltage | Minimum: 3.6V Maximum: 4.3V | | |
| Extreme Temperature | Lowest: 0°C Highest: +35°C | | |
| Operating Frequency Range(s) | Mode | Tx (MHz) | Rx (MHz) |
| | LTE Band 7 | 2500 ~ 2570 | 2620 ~ 2690 |
| EUT Accessory | | | |
| Adapter 1 | Manufacturer: Huawei Technologies Co., Ltd. Model: HW-050100E01 | | |
| Adapter 2 | Manufacturer: Huawei Technologies Co., Ltd. Model: HW-050100B01 | | |
| Adapter 3 | Manufacturer: Huawei Technologies Co., Ltd. Model: HW-050100A01 | | |
| Adapter 4 | Manufacturer: Huawei Technologies Co., Ltd. Model: HW-050100U01 | | |
| Battery | Manufacturer: Huawei Technologies Co., Ltd. (SCUD) Model: HB2899C0ECW-C | | |
| USB Extend Cable | 100cm Cable, Signal Cable, USB2.0, 5V 1A | | |
| Note: 1. The information of the EUT is declared by the manufacturer. | | | |

3 Applied Standards

According to the specifications of the manufacturer, it must comply with the requirements of the following standards:

Test standards

FCC CFR47 Part 2 (2017)

FCC CFR47 Part 27C (2017)

ANSI/TIA-603-E (2016)

KDB 971168 D01 Power Meas License Digital Systems v03r01

4 Test Configuration

Radiated measurements are performed by rotating the EUT in three different orthogonal test planes. EUT stand-up position (Z axis), lie-down position (X, Y axis). Receiver antenna polarization (horizontal and vertical), the worst emission was found in position (Z axis, horizontal polarization) and the worst case was recorded.

All mode and data rates and positions and RB size and modulations were investigated.

Subsequently, only the worst case emissions are reported.

The following testing in LTE is set based on the maximum RF Output Power.

The following testing in different Bandwidth is set to detail in the following table:

Test modes are chosen to be reported as the worst case configuration below for LTE Band 7:

| Test items | Bandwidth (MHz) | | | | Modulation | | RB | | | Test Channel | | |
|---|---|----|----|----|------------|-------|----|-----|------|--------------|---|---|
| | 5 | 10 | 15 | 20 | QPSK | 16QAM | 1 | 50% | 100% | L | M | H |
| RF power output | O | O | O | O | O | O | O | O | O | O | O | O |
| Effective Isotropic Radiated power | O | O | O | O | O | O | O | - | - | O | O | O |
| Occupied Bandwidth | O | O | O | O | O | O | - | - | O | O | O | O |
| Band Edge Compliance | O | O | O | O | O | O | O | - | O | O | - | O |
| Peak-to-Average Power Ratio | O | O | O | O | O | O | - | - | O | O | O | O |
| Frequency Stability | O | O | O | O | O | O | - | - | O | O | - | O |
| Spurious Emissions at Antenna Terminals | O | O | O | O | - | O | O | O | O | O | O | O |
| Radiates Spurious Emission | O | O | O | O | - | O | O | O | O | - | O | - |
| Note | 1. The mark "O" means that this configuration is chosen for testing. 2. The mark "-" means that this configuration is not testing. | | | | | | | | | | | |

5 Test Case Results

5.1 RF Power Output

Ambient condition

| Temperature | Relative humidity | Pressure |
|-------------|-------------------|----------|
| 23°C ~25°C | 45%~50% | 101.5kPa |

Methods of Measurement

During the process of the testing, The EUT is controlled by the Base Station Simulator to ensure max power transmission and proper modulation.

Test Setup

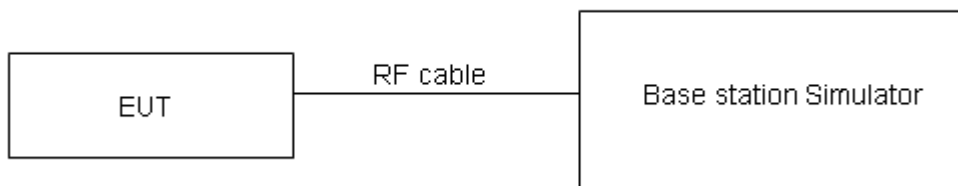

The loss between RF output port of the EUT and the input port of the tester has been taken into consideration.

Limits

No specific RF power output requirements in part 2.1046.

Measurement Uncertainty

The assessed measurement uncertainty to ensure 95% confidence level for the normal distribution is with the coverage factor $k = 2$, $U=0.4$ dB.

Test Results

| LTE Band 7 | | | | Conducted Power(dBm) | | |
|------------|------------|---------|-----------|-------------------------|------------|--------------|
| Bandwidth | Modulation | RB size | RB offset | Channel/Frequency (MHz) | | |
| | | | | 20775/2502.5 | 21100/2535 | 21425/2567.5 |
| 5MHz | QPSK | 1 | 0 | 22.78 | 23.58 | 23.48 |
| | | 1 | 13 | 21.48 | 21.32 | 21.50 |
| | | 1 | 24 | 23.71 | 23.79 | 22.67 |
| | | 12 | 0 | 21.25 | 21.88 | 21.85 |
| | | 12 | 6 | 21.67 | 21.69 | 21.63 |
| | | 12 | 13 | 21.95 | 21.52 | 21.33 |
| | | 25 | 0 | 21.57 | 21.68 | 21.64 |
| | 16QAM | 1 | 0 | 23.03 | 23.72 | 23.72 |
| | | 1 | 13 | 21.25 | 21.87 | 21.35 |
| | | 1 | 24 | 23.40 | 24.21 | 23.86 |
| | | 12 | 0 | 21.17 | 21.21 | 21.26 |
| | | 12 | 6 | 20.91 | 21.04 | 21.10 |
| | | 12 | 13 | 20.90 | 21.01 | 20.89 |
| | | 25 | 0 | 21.00 | 21.09 | 21.04 |
| Bandwidth | Modulation | RB size | RB offset | Channel/Frequency (MHz) | | |
| | | | | 20800/2505 | 21100/2535 | 21400/2565 |
| 10MHz | QPSK | 1 | 0 | 22.80 | 23.59 | 23.51 |
| | | 1 | 25 | 21.51 | 21.37 | 21.54 |
| | | 1 | 49 | 23.73 | 23.83 | 22.70 |
| | | 25 | 0 | 21.28 | 21.93 | 21.89 |
| | | 25 | 13 | 21.70 | 21.74 | 21.67 |
| | | 25 | 25 | 21.97 | 21.56 | 21.38 |
| | | 50 | 0 | 21.65 | 21.70 | 21.68 |
| | 16QAM | 1 | 0 | 23.05 | 23.75 | 23.74 |
| | | 1 | 25 | 21.28 | 21.91 | 21.38 |
| | | 1 | 49 | 23.43 | 24.23 | 23.89 |
| | | 25 | 0 | 21.20 | 21.26 | 21.30 |
| | | 25 | 13 | 20.93 | 21.08 | 21.13 |
| | | 25 | 25 | 20.93 | 21.06 | 20.93 |
| | | 50 | 0 | 21.03 | 21.14 | 21.08 |
| Bandwidth | Modulation | RB size | RB offset | Channel/Frequency (MHz) | | |
| | | | | 20825/2507.5 | 21100/2535 | 21375/2562.5 |
| 15MHz | QPSK | 1 | 0 | 22.79 | 23.55 | 23.49 |
| | | 1 | 38 | 21.49 | 21.36 | 21.51 |
| | | 1 | 74 | 23.70 | 23.78 | 22.66 |
| | | 36 | 0 | 21.26 | 21.89 | 21.86 |
| | | 36 | 18 | 21.67 | 21.69 | 21.63 |
| | | 36 | 39 | 21.94 | 21.53 | 21.34 |
| | | 75 | 0 | 21.63 | 21.66 | 21.63 |



| Bandwidth | Modulation | RB size | RB offset | Channel/Frequency (MHz) | | |
|-----------|------------|---------|-----------|-------------------------|------------|------------|
| | | | | 20850/2510 | 21100/2535 | 21350/2560 |
| 20MHz | 16QAM | 1 | 0 | 23.00 | 23.73 | 23.72 |
| | | 1 | 38 | 21.26 | 21.88 | 21.36 |
| | | 1 | 74 | 23.40 | 24.19 | 23.86 |
| | | 36 | 0 | 21.17 | 21.24 | 21.27 |
| | | 36 | 18 | 20.90 | 21.03 | 21.09 |
| | | 36 | 39 | 20.91 | 21.02 | 20.90 |
| | | 75 | 0 | 21.00 | 21.09 | 21.04 |
| | QPSK | 1 | 0 | 22.76 | 23.51 | 23.46 |
| | | 1 | 50 | 21.48 | 21.32 | 21.49 |
| | | 1 | 99 | 23.68 | 23.77 | 22.63 |
| | | 50 | 0 | 21.23 | 21.84 | 21.82 |
| | | 50 | 25 | 21.65 | 21.65 | 21.60 |
| | | 50 | 50 | 21.91 | 21.48 | 21.30 |
| | | 100 | 0 | 21.60 | 21.61 | 21.59 |
| 16QAM | 1 | 0 | 22.98 | 23.69 | 23.67 | |
| | 1 | 50 | 21.22 | 21.86 | 21.32 | |
| | 1 | 99 | 23.38 | 24.16 | 23.84 | |
| | 50 | 0 | 21.14 | 21.20 | 21.24 | |
| | 50 | 25 | 20.87 | 21.01 | 21.06 | |
| | 50 | 50 | 20.88 | 20.97 | 20.86 | |
| | 100 | 0 | 20.98 | 21.05 | 21.01 | |

5.2 Effective Isotropic Radiated Power

Ambient condition

| Temperature | Relative humidity | Pressure |
|-------------|-------------------|----------|
| 23°C ~25°C | 45%~50% | 101.5kPa |

Methods of Measurement

1. The testing follows FCC KDB 971168 D01 v03r01 Section 5.8 and ANSI/TIA-603-E (2016).

a) Connect the equipment as illustrated. Mount the equipment with the manufacturer specified antenna in a vertical orientation on a manufacturer specified mounting surface located on a non-conducting rotating platform of a RF anechoic chamber (preferred) or a standard radiation site.

b) Key the transmitter, then rotate the EUT 360° azimuthally and record spectrum analyzer power level (LVL) measurements at angular increments that are sufficiently small to permit resolution of all peaks. If a standard radiation test site is used, raise and lower the test antenna to obtain a maximum reading at each angular increment. (Note: several batteries may be needed to offset the effect of battery voltage droop, which should not exceed 5% of the manufactured specified battery voltage during transmission).

c) Replace the transmitter under test with a vertically polarized half-wave dipole (or an antenna whose gain is known relative to an ideal half-wave dipole). The center of the antenna should be at the same location as the center of the antenna under test.

d) Connect the antenna to a signal generator with a known output power and record the path loss (in dB) as LOSS. If a standard radiation test site is used, raise and lower the test antenna to obtain a maximum reading. $LOSS = \text{Generator Output Power (dBm)} - \text{Analyzer reading (dBm)}$

e) Determine the effective radiated output power at each angular position from the readings in steps b) and d) using the following equation: $ERP \text{ (dBm)} = LVL \text{ (dBm)} + LOSS \text{ (dB)}$

f) The maximum ERP is the maximum value determined in the preceding step.

g) When calculating ERP, in addition to knowing the antenna radiation and matching characteristics, it is necessary to know the loss values of all elements (e.g. transmission line attenuation, mismatches, filters, combiners) interposed between the point where transmitter output power is measured, and the point where power is applied to the antenna. ERP can then be calculated as follows:

$$ERP \text{ (dBm)} = \text{Output Power (dBm)} - \text{Losses (dB)} + \text{Antenna Gain (dBd)}$$

where: dBd refers to gain relative to an ideal dipole.

$$EIRP \text{ (dBm)} = ERP \text{ (dBm)} + 2.15 \text{ (dB.)}$$

The RB allocation refers to section 5.1, using the maximum output power configuration.

Test setup

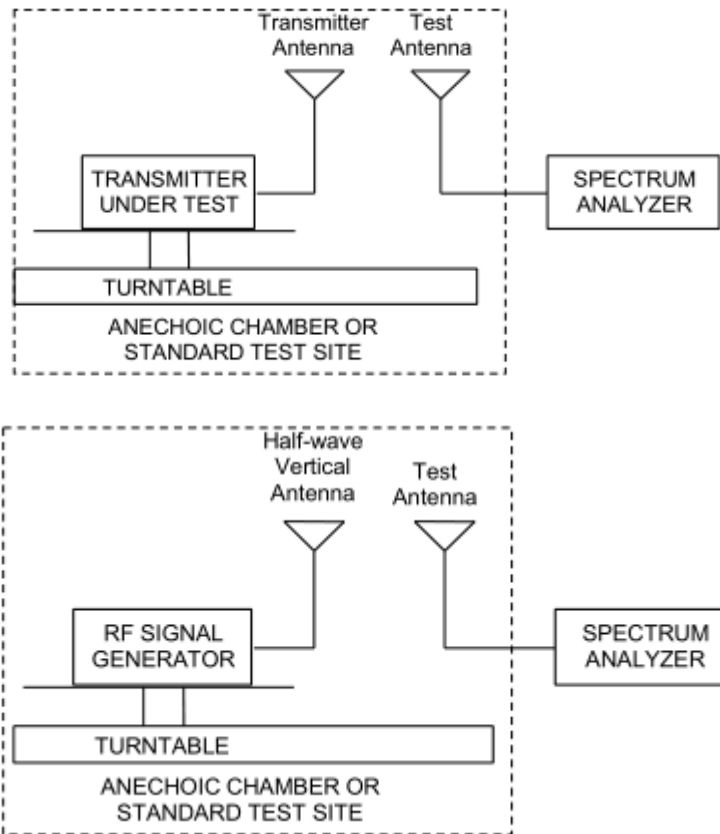

Note: Area side:2.4mX3.6m

The radiated emission was measured in the following position: EUT stand-up position (Z axis), lie-down position (X, Y axis). The worst emission was found in stand-up position (Z axis) and the worst case was recorded.

**Limits**

Rule Part 27.50(h) (2) specifies that “Mobile and other user stations. Mobile stations are limited to 2.0 watts EIRP. All user stations are limited to 2.0 watts transmitter output power.”

| | |
|------------------|-----------------------------|
| Part 27.50(h)(2) | $\leq 2 \text{ W}$ (33 dBm) |
|------------------|-----------------------------|

Measurement Uncertainty

The assessed measurement uncertainty to ensure 95% confidence level for the normal distribution is with the coverage factor $k = 2$, $U = 1.19 \text{ dB}$

Test Results

The measurement is performed for both of horizontal and vertical antenna Polarization, and only the data of worst mode is recorded in this report.

| LTE Band 7 | | | | | | |
|-----------------------|---------|-----------------|--------------|------------|-------------|------------|
| Band width | Channel | Frequency (MHz) | Polarization | EIRP (dBm) | Limit (dBm) | Conclusion |
| 5 MHz (QPSK) | Low | 2502.5 | Horizontal | 23.42 | 33 | Pass |
| | Mid | 2535 | Horizontal | 22.62 | 33 | Pass |
| | High | 2567.5 | Horizontal | 23.36 | 33 | Pass |
| 10 MHz (QPSK) | Low | 2505 | Horizontal | 23.63 | 33 | Pass |
| | Mid | 2535 | Horizontal | 22.98 | 33 | Pass |
| | High | 2565 | Horizontal | 23.17 | 33 | Pass |
| 15 MHz (QPSK) | Low | 2507.5 | Horizontal | 23.45 | 33 | Pass |
| | Mid | 2535 | Horizontal | 22.58 | 33 | Pass |
| | High | 2562.5 | Horizontal | 21.68 | 33 | Pass |
| 20 MHz (QPSK) | Low | 2510 | Horizontal | 23.39 | 33 | Pass |
| | Mid | 2535 | Horizontal | 22.37 | 33 | Pass |
| | High | 2560 | Horizontal | 21.39 | 33 | Pass |
| 5 MHz (16QAM) | Low | 2502.5 | Horizontal | 23.21 | 33 | Pass |
| | Mid | 2535 | Horizontal | 22.48 | 33 | Pass |
| | High | 2567.5 | Horizontal | 23.11 | 33 | Pass |
| 10 MHz (16QAM) | Low | 2505 | Horizontal | 23.41 | 33 | Pass |
| | Mid | 2535 | Horizontal | 22.73 | 33 | Pass |
| | High | 2565 | Horizontal | 22.92 | 33 | Pass |
| 15 MHz (16QAM) | Low | 2507.5 | Horizontal | 23.16 | 33 | Pass |
| | Mid | 2535 | Horizontal | 22.24 | 33 | Pass |
| | High | 2562.5 | Horizontal | 21.32 | 33 | Pass |
| 20 MHz (16QAM) | Low | 2510 | Horizontal | 23.13 | 33 | Pass |
| | Mid | 2535 | Horizontal | 22.05 | 33 | Pass |
| | High | 2560 | Horizontal | 21.03 | 33 | Pass |

5.3 Occupied Bandwidth

Ambient condition

| | | |
|-------------|-------------------|----------|
| Temperature | Relative humidity | Pressure |
| 23°C ~25°C | 45%~50% | 101.5kPa |

Method of Measurement

The EUT was connected to Spectrum Analyzer and Base Station Simulator via power Splitter. The occupied bandwidth is measured using spectrum analyzer.

RBW is set to 100 kHz, VBW is set to 300 kHz for LTE Band 7(5MHz).

RBW is set to 300 kHz, VBW is set to 1MHz for LTE Band 7(10MHz/15MHz/20MHz).

99% power and -26dBc occupied bandwidths are recorded. Spectrum analyzer plots are included on the following pages.

Test Setup

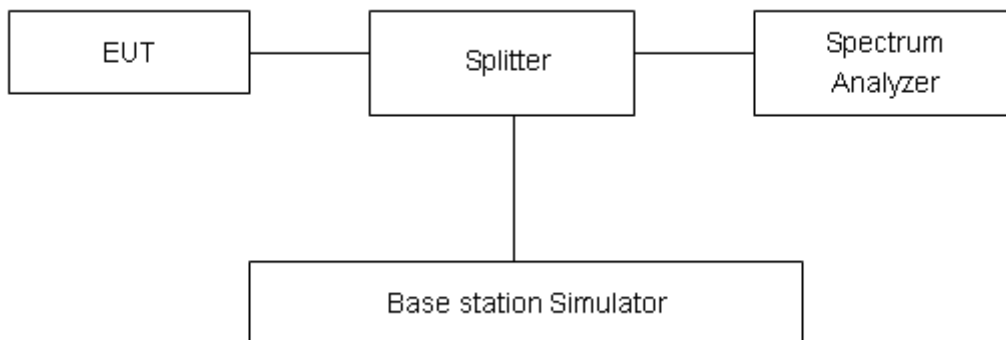

Limits

No specific occupied bandwidth requirements in part 2.1049.

Measurement Uncertainty

The assessed measurement uncertainty to ensure 95% confidence level for the normal distribution is with the coverage factor $k = 2$, $U=624\text{Hz}$.

Test Result

| LTE Band 7 | | | | | | |
|------------|------------|-----------------|---------|-----------------|--------------------------|-----------------------|
| RB | Modulation | Bandwidth (MHz) | Channel | Frequency (MHz) | 99% Power Bandwidth(MHz) | -26dBc Bandwidth(MHz) |
| 100% | QPSK | 5 | 20775 | 2502.5 | 4.5263 | 4.978 |
| | | | 21100 | 2535 | 4.5207 | 4.984 |
| | | | 21425 | 2567.5 | 4.5247 | 4.985 |
| | | 10 | 20800 | 2505 | 9.0883 | 10.08 |
| | | | 21100 | 2535 | 9.0904 | 10.14 |
| | | | 21400 | 2565 | 9.078 | 10.11 |
| | | 15 | 20825 | 2507.5 | 13.507 | 14.93 |
| | | | 21100 | 2535 | 13.536 | 15.04 |
| | | | 21375 | 2562.5 | 13.507 | 15.05 |
| | | 20 | 20850 | 2510 | 17.995 | 19.71 |
| | | | 21100 | 2535 | 17.988 | 19.7 |
| | | | 21350 | 2560 | 17.938 | 19.62 |
| | 16QAM | 5 | 20775 | 2502.5 | 4.5232 | 4.997 |
| | | | 21100 | 2535 | 4.5296 | 5.022 |
| | | | 21425 | 2567.5 | 4.5224 | 5.003 |
| | | 10 | 20800 | 2505 | 9.1056 | 10.07 |
| | | | 21100 | 2535 | 9.0896 | 10.13 |
| | | | 21400 | 2565 | 9.1185 | 10.09 |
| | | 15 | 20825 | 2507.5 | 13.592 | 15.02 |
| | | | 21100 | 2535 | 13.537 | 15.1 |
| | | | 21375 | 2562.5 | 13.543 | 15.12 |
| | | 20 | 20850 | 2510 | 17.997 | 19.81 |
| | | | 21100 | 2535 | 18.003 | 19.62 |
| | | | 21350 | 2560 | 17.926 | 19.68 |

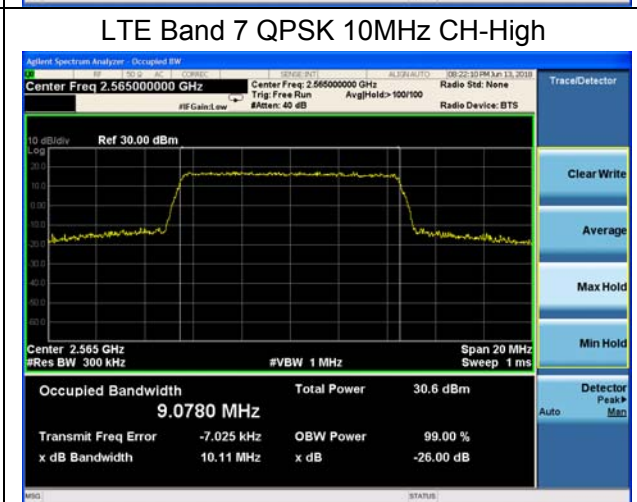
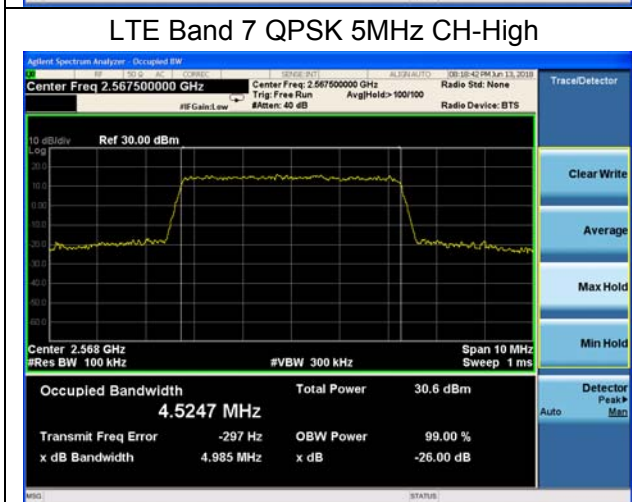
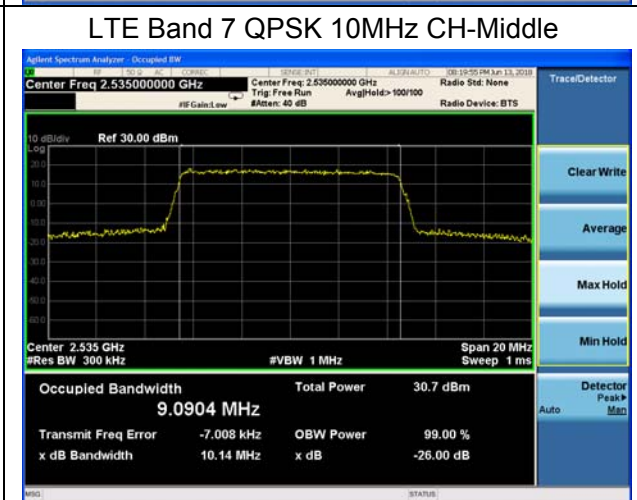
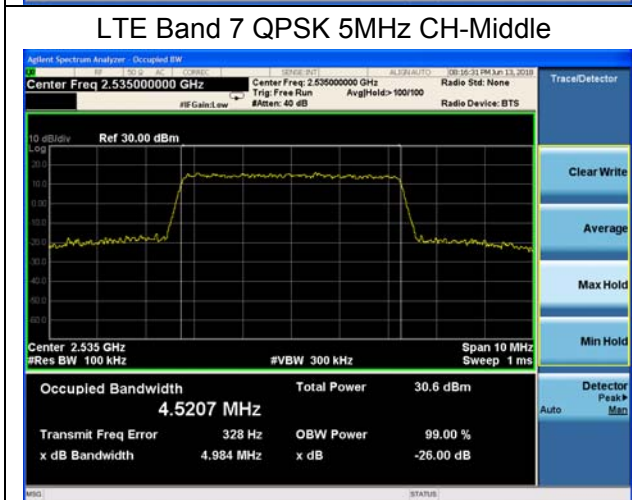
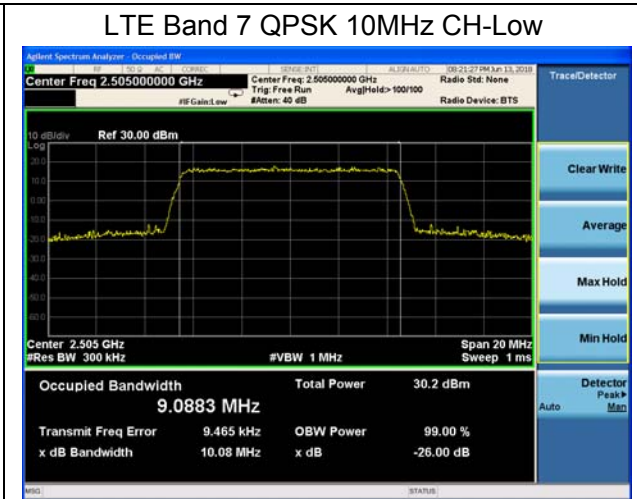
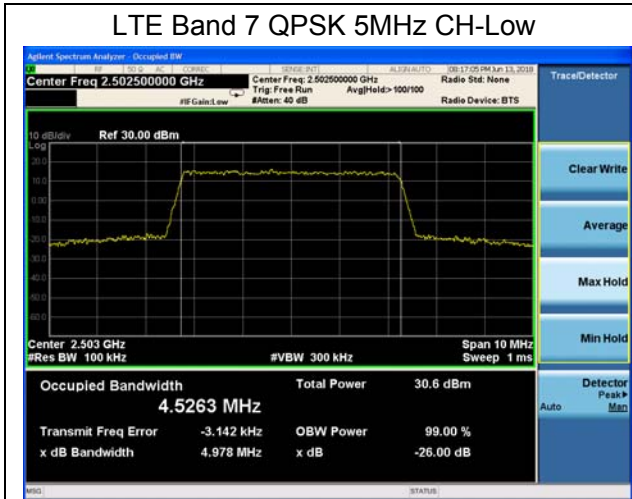

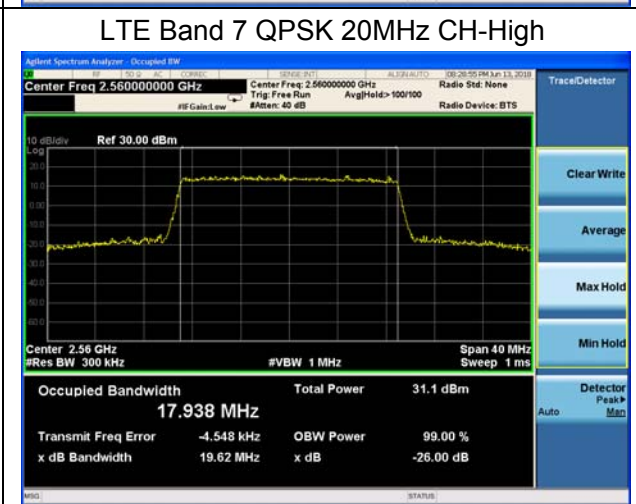
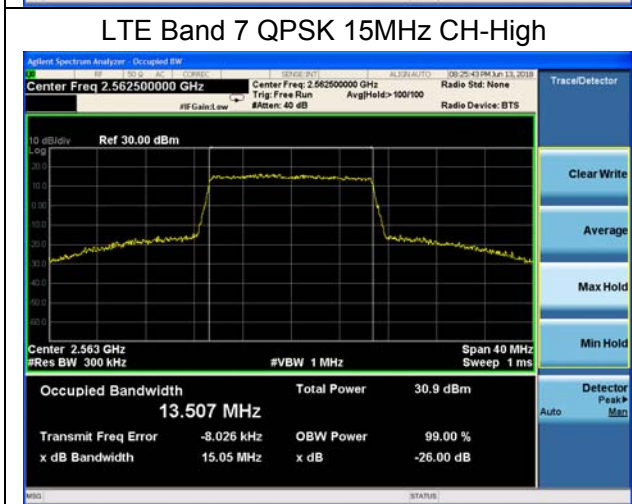
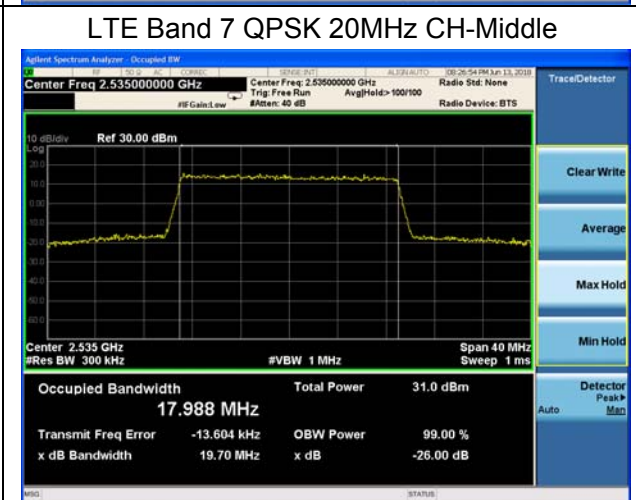
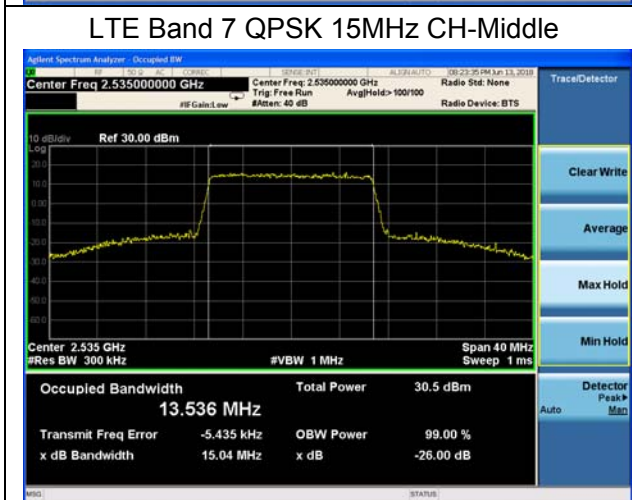
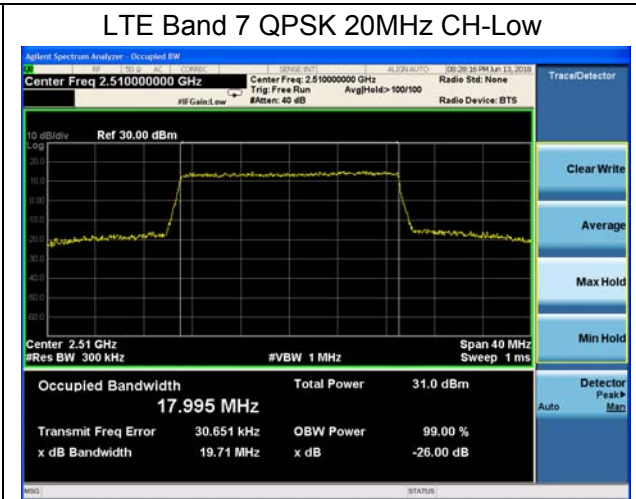
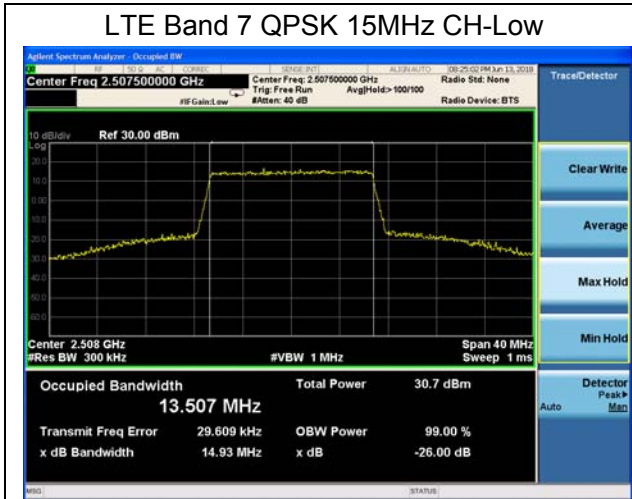

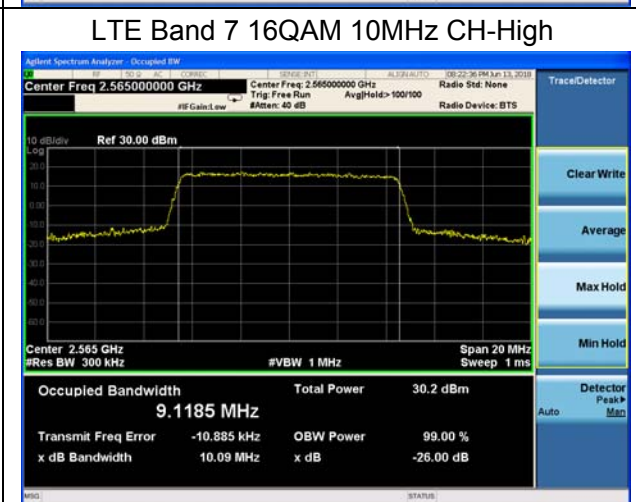
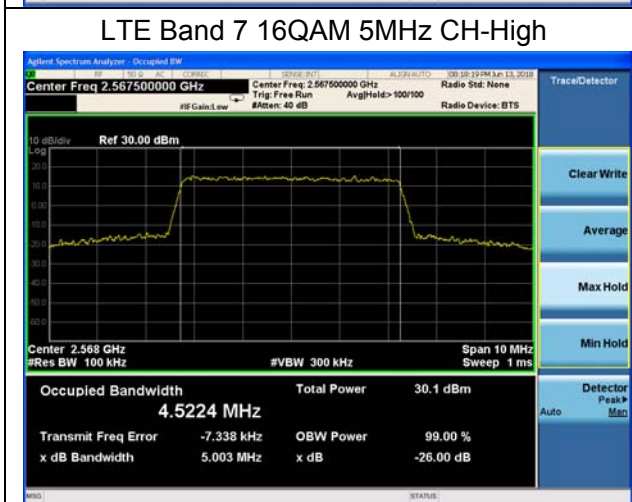
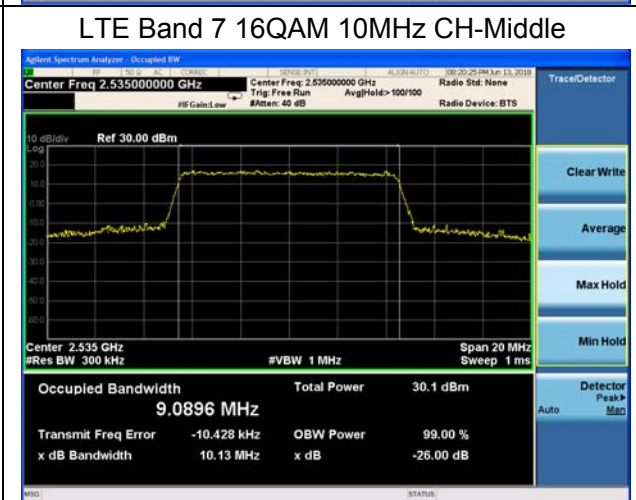
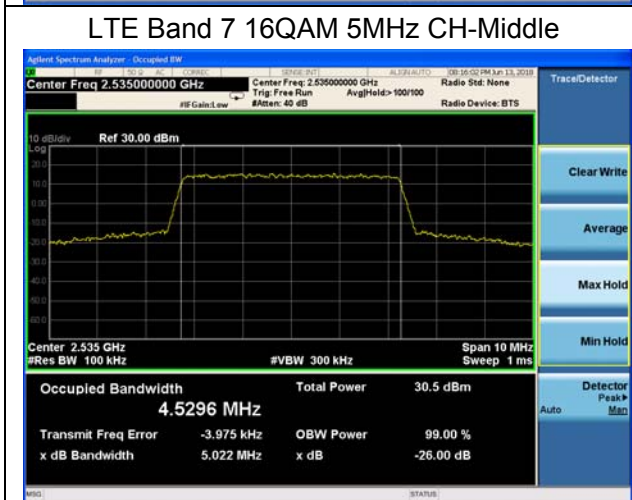
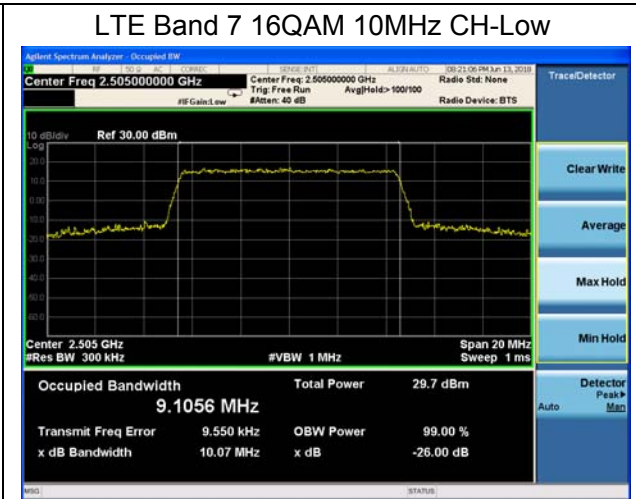
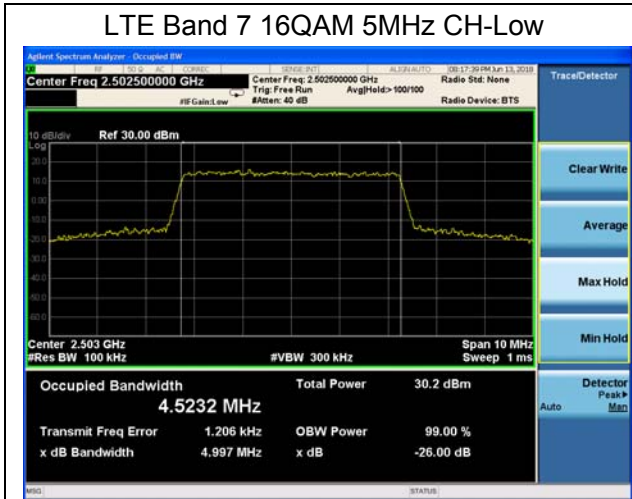

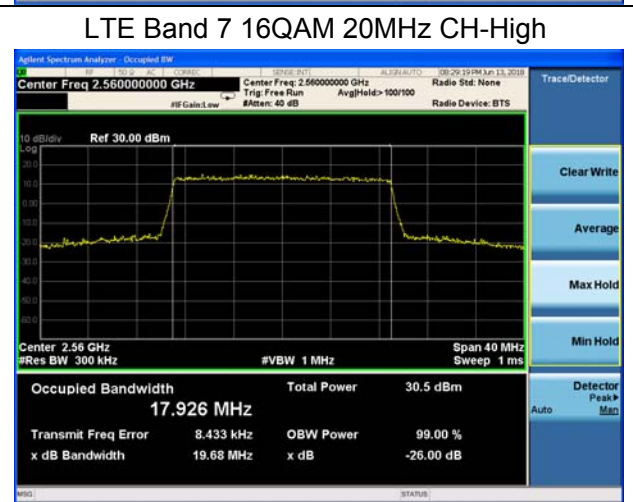
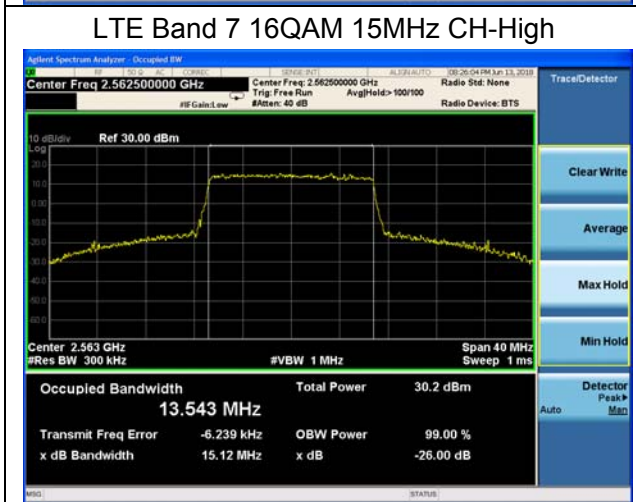
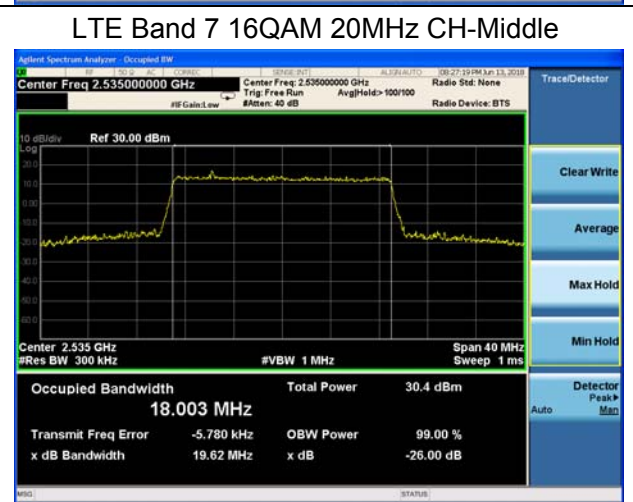
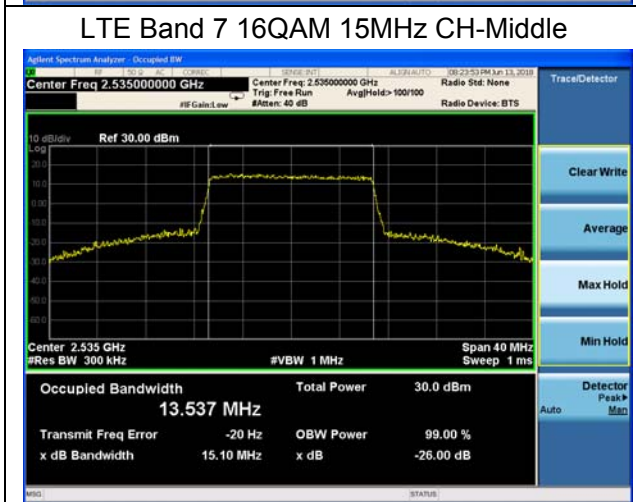
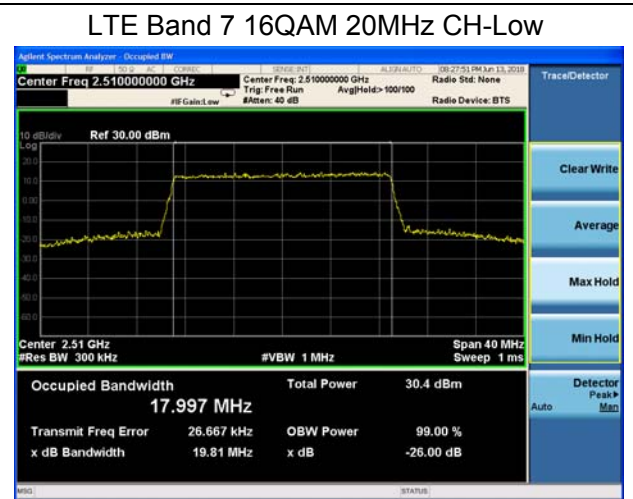
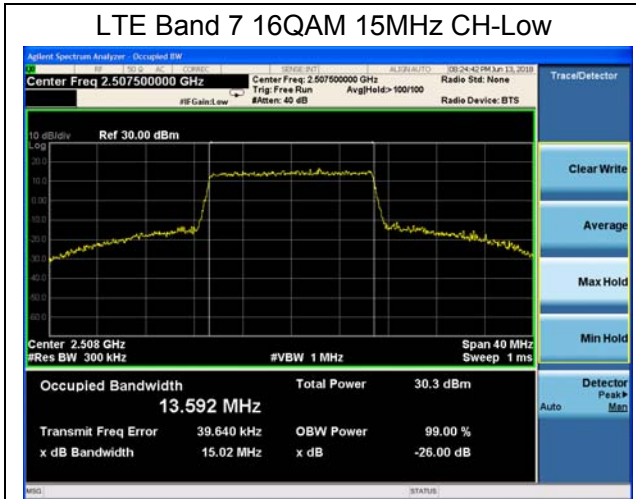

5.4 Band Edge Compliance

Ambient condition

| Temperature | Relative humidity | Pressure |
|-------------|-------------------|----------|
| 23°C ~25°C | 45%~50% | 101.5kPa |

Method of Measurement

The EUT was connected to Spectrum Analyzer and Base Station Simulator via power Splitter. The band edge of the lowest and highest channels were measured.

The testing follows KDB 971168 D01 v03r01 Section 6.0

1. The EUT was connected to spectrum analyzer and system simulator via a power divider.
2. The band edges of low and high channels for the highest RF powers were measured.
3. RBW is set to 50 kHz, VBW is set to 200 kHz for LTE Band 7 (5MHz).
RBW is set to 100 kHz, VBW is set to 300kHz for LTE Band 7 (10MHz).
RBW is set to 200 kHz, VBW is set to 1 MHz for LTE Band 7(15MHz/20MHz) on spectrum analyzer.
4. Set spectrum analyzer with RMS detector.
5. The RF fundamental frequency should be excluded against the limit line in the operating frequency band.
6. Checked that all the results comply with the emission limit line.

Test Setup

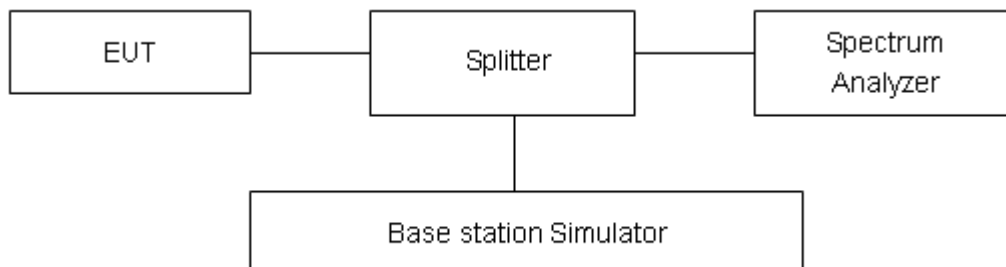

Limits

Part 27.53(m) (4) specifies that “for BRS and EBS stations. For mobile digital stations, the attenuation factor shall be not less than $40 + 10 \log (P)$ dB on all frequencies between the channel edge and 5 megahertz from the channel edge, $43 + 10 \log (P)$ dB on all frequencies between 5 megahertz and X megahertz from the channel edge, and $55 + 10 \log (P)$ dB on all frequencies more than X megahertz from the channel edge, where X is the greater of 6 megahertz or the actual emission bandwidth as defined in paragraph (m)(4) of this section. In addition, the attenuation factor shall not be less that $43 + 10 \log (P)$ dB on all frequencies between 2490.5 MHz and 2496 MHz and $55 + 10 \log (P)$ dB at or below 2490.5 MHz. Mobile Satellite Service licensees operating on



frequencies below 2495 MHz may also submit a documented interference complaint against BRS licensees operating on channel BRS Channel 1 on the same terms and conditions as adjacent channel BRS or EBS licensees.

Example:

The limit line is derived from $43 + 10\log(P)$ dB below the transmitter power P (Watts)

$= P(W) - [43 + 10\log(P)]$ (dB)

$= [30 + 10\log(P)]$ (dBm) - $[43 + 10\log(P)]$ (dB) = -13dBm.

Measurement Uncertainty

The assessed measurement uncertainty to ensure 95% confidence level for the normal distribution is with the coverage factor $k = 1.96$, $U=0.684$ dB.

Test Result

All the test traces in the plots shows the test results clearly.

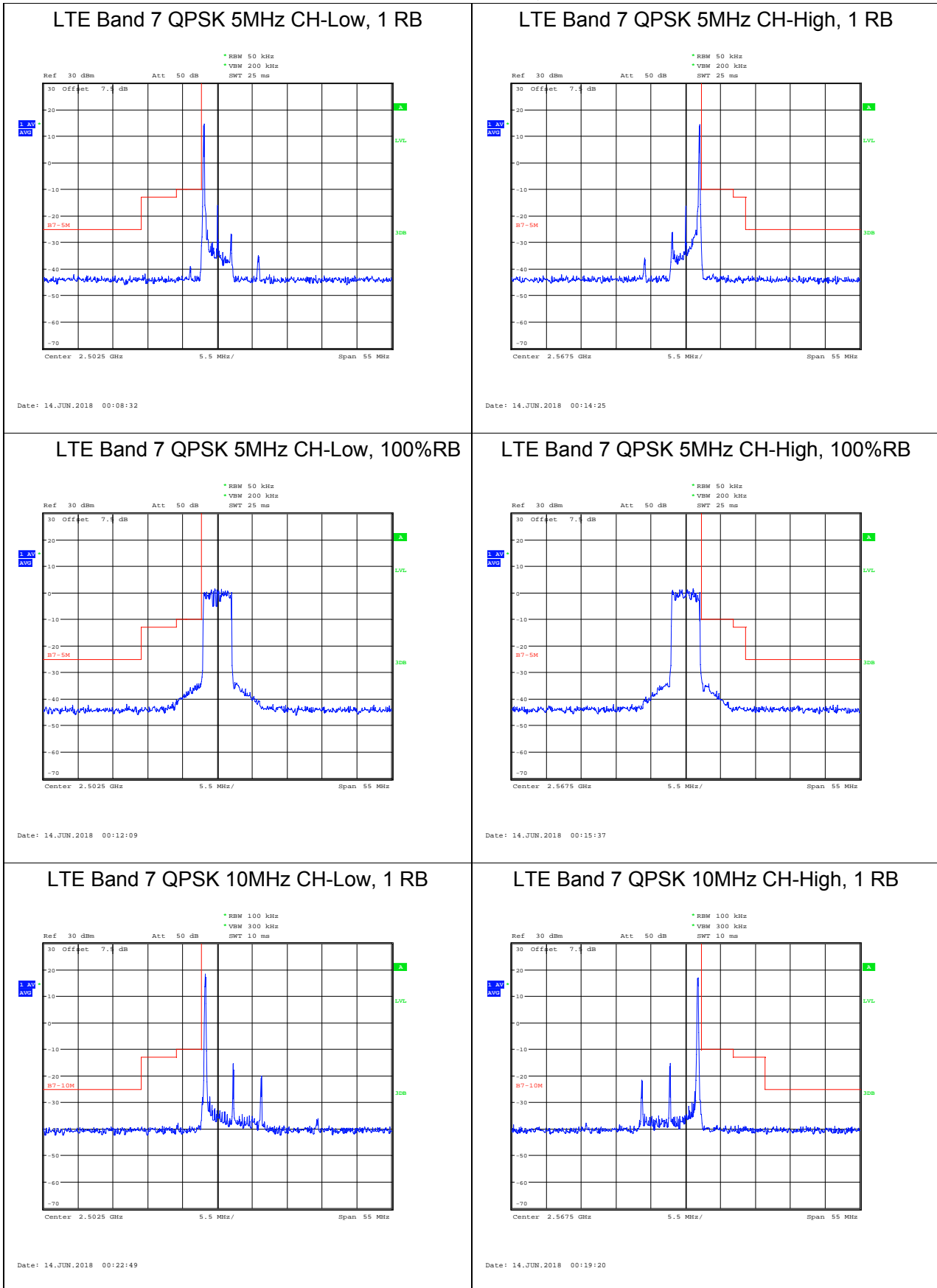



LTE Band 7 QPSK 10MHz CH-Low, 100%RB

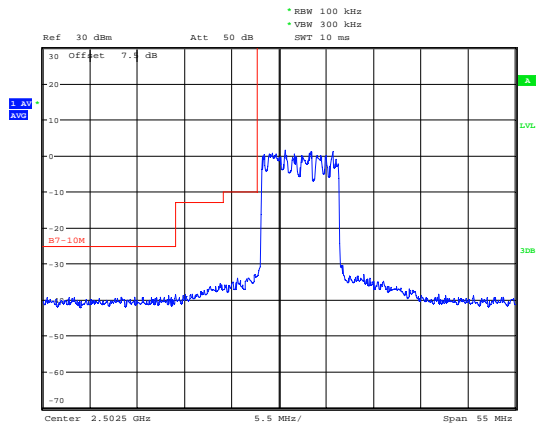

Date: 14.JUN.2018 00:24:05

LTE Band 7 QPSK 10MHz CH-High, 100%RB

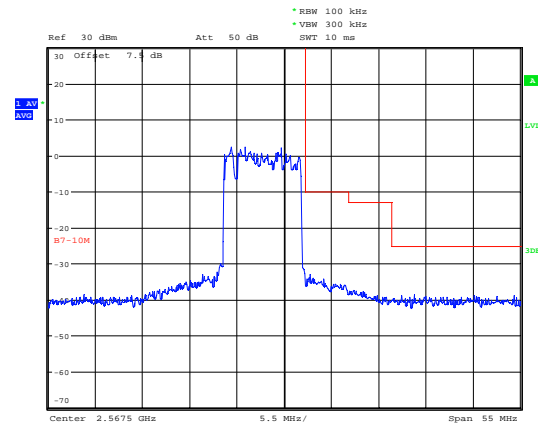

Date: 14.JUN.2018 00:20:46

LTE Band 7 QPSK 15MHz CH-Low, 1 RB

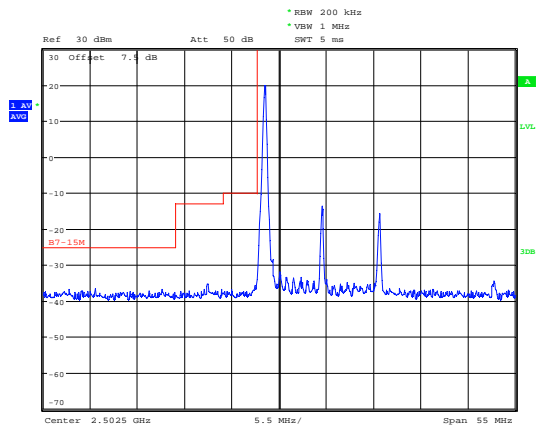

Date: 14.JUN.2018 00:27:05

LTE Band 7 QPSK 15MHz CH-High, 1 RB

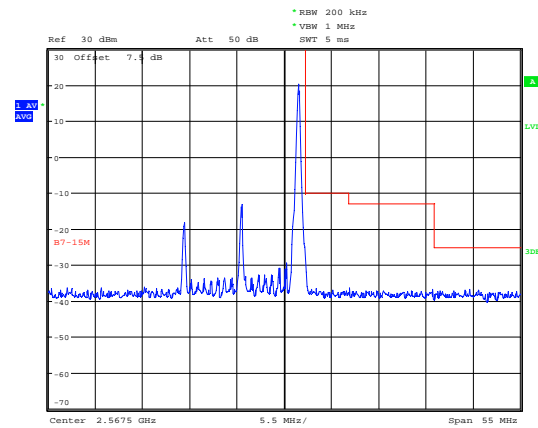

Date: 14.JUN.2018 00:33:22

LTE Band 7 QPSK 15MHz CH-Low, 100%RB

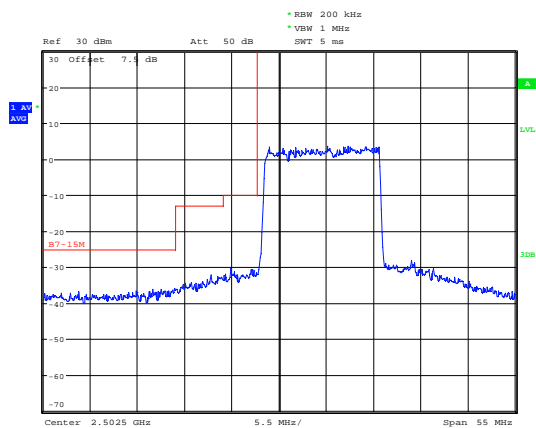

Date: 14.JUN.2018 00:28:25

LTE Band 7 QPSK 15MHz CH-High, 100%RB

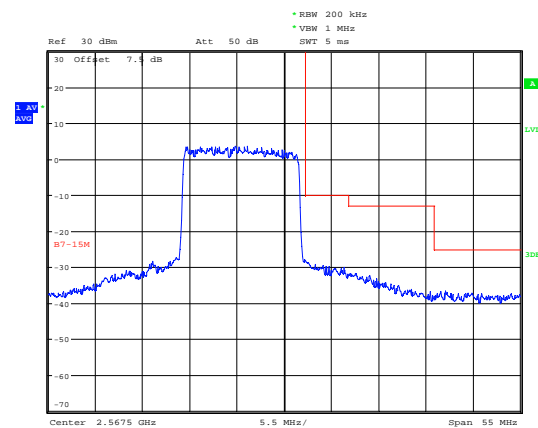

Date: 14.JUN.2018 00:34:27



LTE Band 7 QPSK 20MHz CH-Low, 1 RB

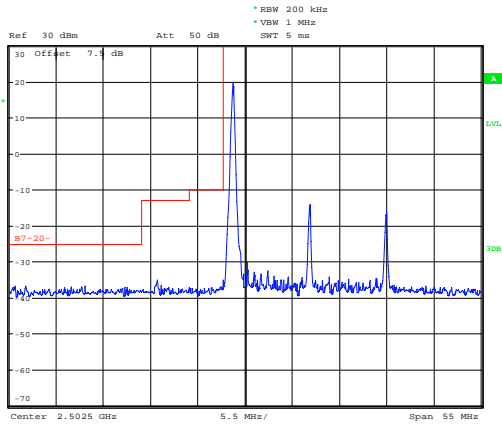

Date: 14.JUN.2018 00:38:06

LTE Band 7 QPSK 20MHz CH-High, 1 RB

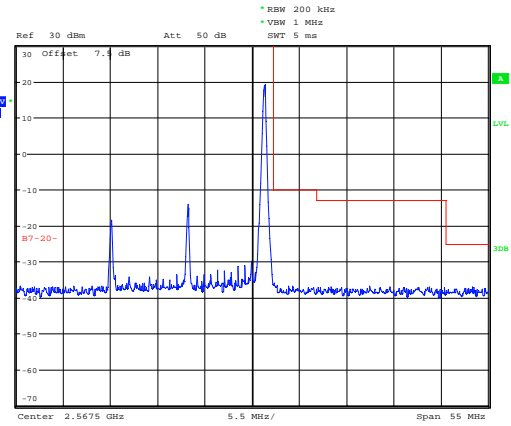

Date: 14.JUN.2018 00:36:00

LTE Band 7 QPSK 20MHz CH-Low, 100%RB

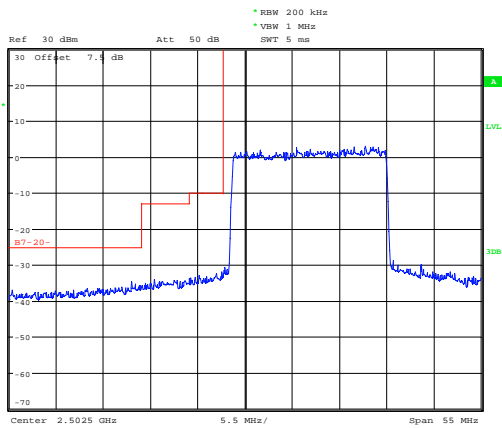

Date: 14.JUN.2018 00:39:03

LTE Band 7 QPSK 20MHz CH-High, 100%RB

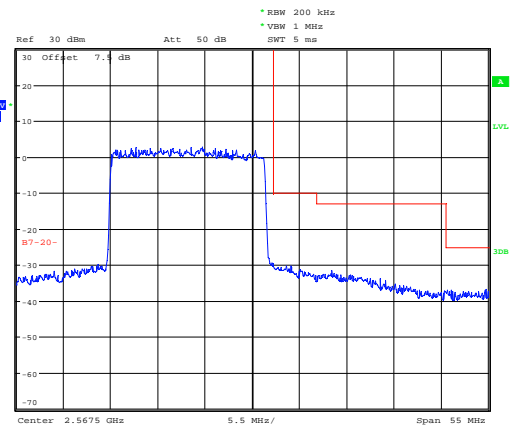

Date: 14.JUN.2018 00:37:09

LTE Band 7 16QAM 5MHz CH-Low, 1 RB

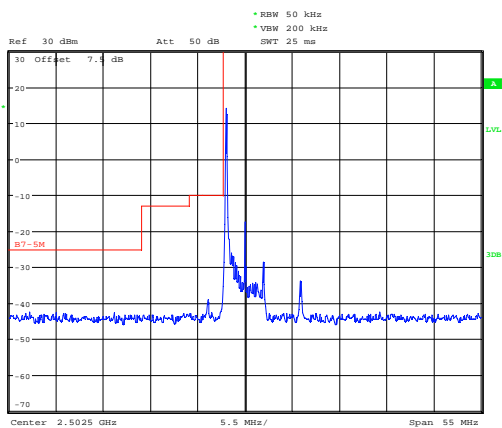

Date: 14.JUN.2018 00:10:03

LTE Band 7 16QAM 5MHz CH-High, 1 RB

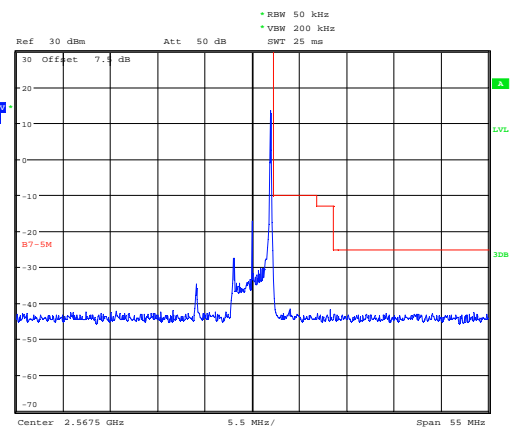

Date: 14.JUN.2018 00:14:53



LTE Band 7 16QAM 5MHz CH-Low, 100%RB

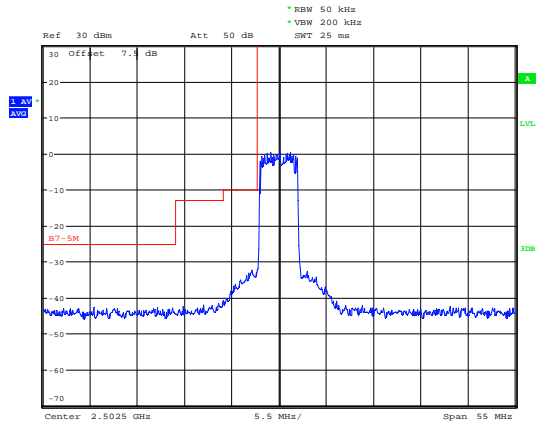

Date: 14.JUN.2018 00:10:49

LTE Band 7 16QAM 5MHz CH-High, 100%RB

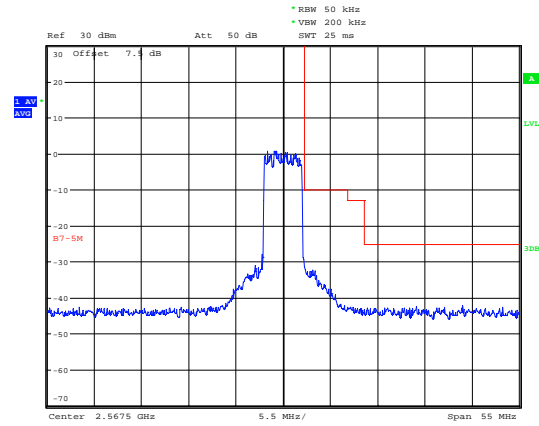

Date: 14.JUN.2018 00:15:16

LTE Band 7 16QAM 10MHz CH-Low, 1 RB

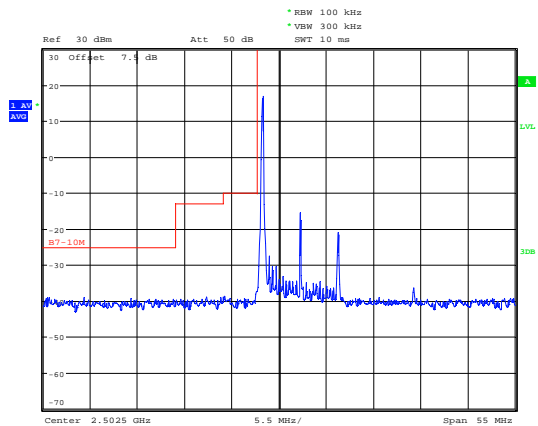

Date: 14.JUN.2018 00:23:37

LTE Band 7 16QAM 10MHz CH-High, 1 RB

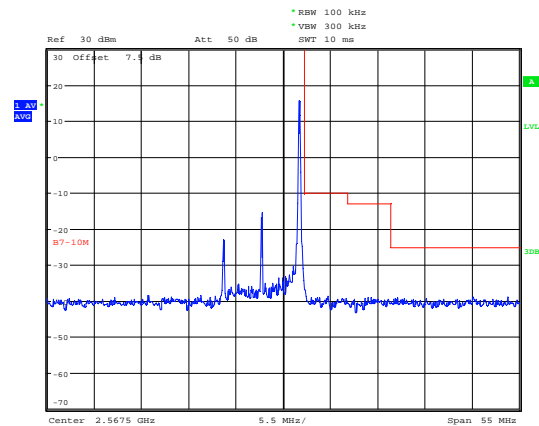

Date: 14.JUN.2018 00:19:43

LTE Band 7 16QAM 10MHz CH-Low, 100%RB

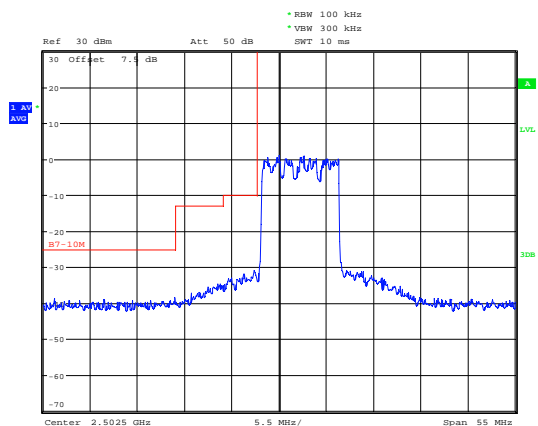

Date: 14.JUN.2018 00:23:52

LTE Band 7 16QAM 10MHz CH-High, 100%RB

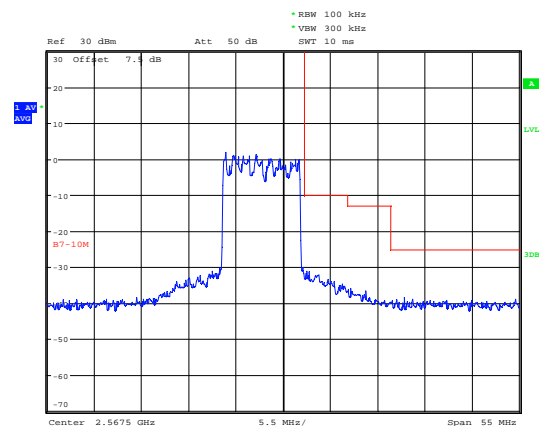

Date: 14.JUN.2018 00:20:21



LTE Band 7 16QAM 15MHz CH-Low, 1 RB

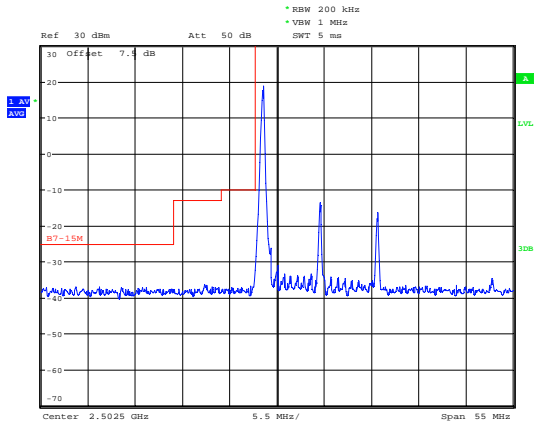

Date: 14.JUN.2018 00:27:28

LTE Band 7 16QAM 15MHz CH-High, 1 RB

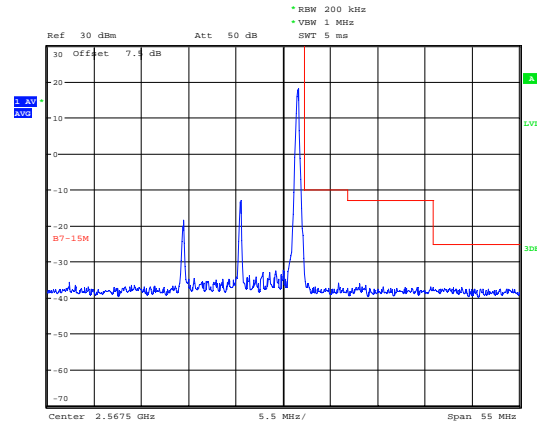

Date: 14.JUN.2018 00:33:45

LTE Band 7 16QAM 15MHz CH-Low, 100%RB

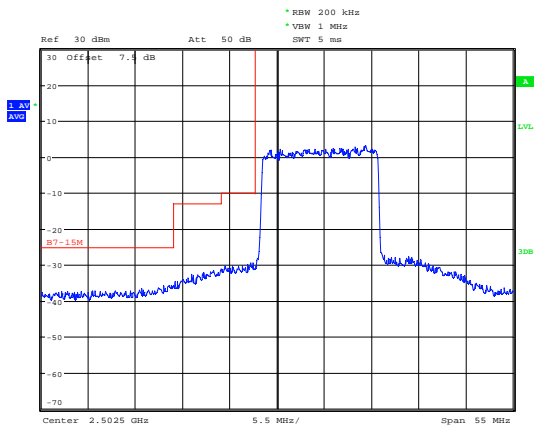

Date: 14.JUN.2018 00:27:46

LTE Band 7 16QAM 15MHz CH-High, 100%RB

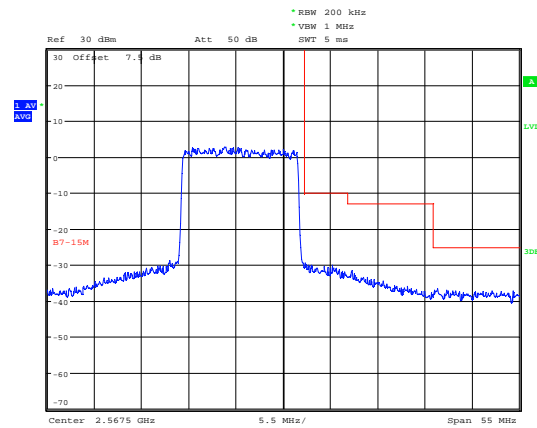

Date: 14.JUN.2018 00:34:02

LTE Band 7 16QAM 20MHz CH-Low, 1 RB

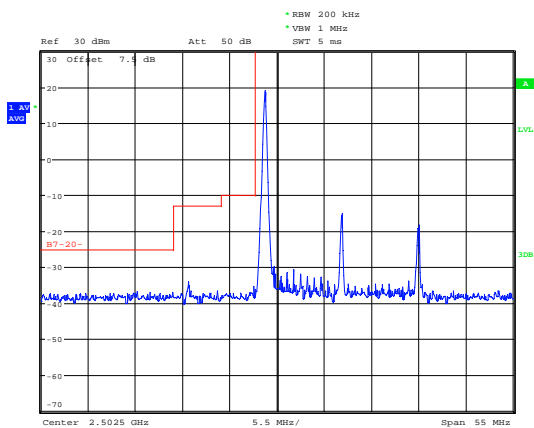

Date: 14.JUN.2018 00:38:32

LTE Band 7 16QAM 20MHz CH-High, 1 RB

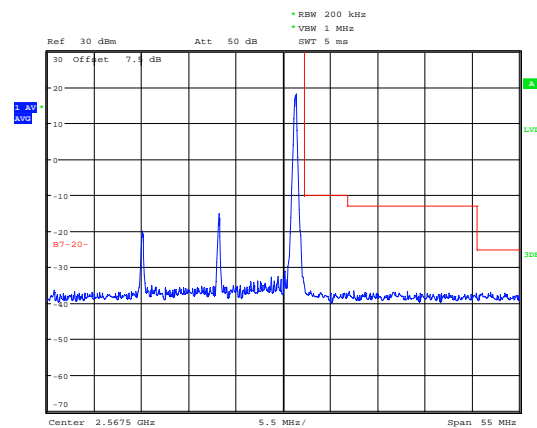

Date: 14.JUN.2018 00:36:24



LTE Band 7 16QAM 20MHz CH-Low, 100%RB

LTE Band 7 16QAM 20MHz CH-High, 100%RB

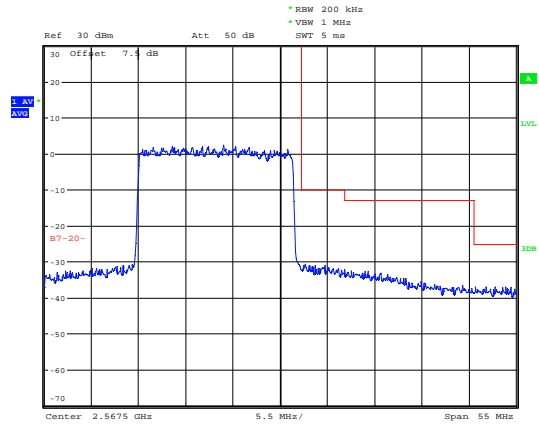
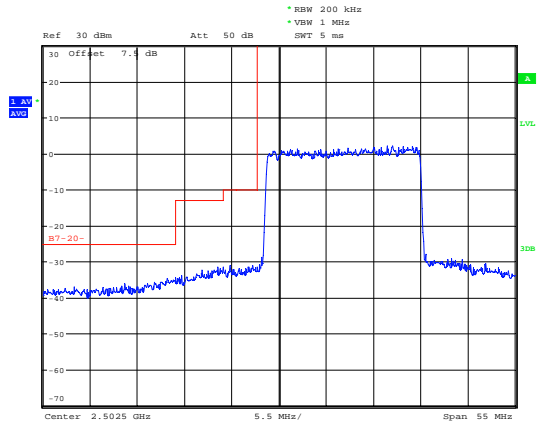

5.5 Peak-to-Average Power Ratio (PAPR)

Ambient condition

| Temperature | Relative humidity | Pressure |
|-------------|-------------------|----------|
| 23°C ~25°C | 45%~50% | 101.5kPa |

Methods of Measurement

Measure the total peak power and record as PPK. And measure the total average power and record as PAvg. Both the peak and average power levels must be expressed in the same logarithmic units (e.g., dBm). Determine the PAPR from:

$$PAPR (dB) = PPK (dBm) - PAvg (dBm).$$

Test Setup

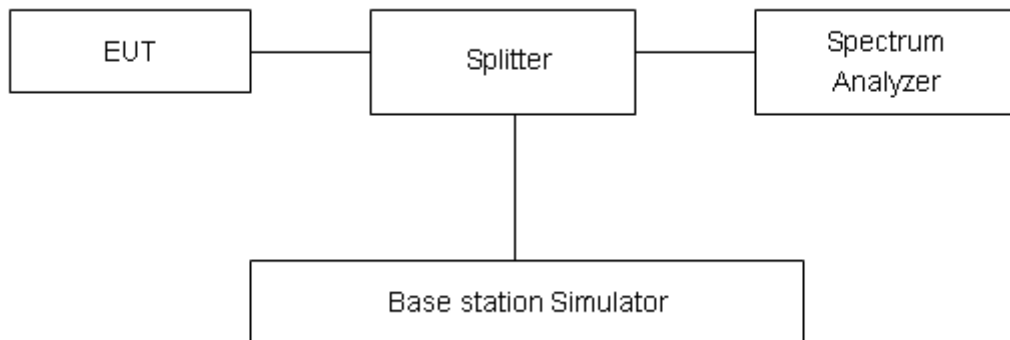

Limits

Rule Part 27.50(d)(5) Equipment employed must be authorized in accordance with the provisions of 24.51. Power measurements for transmissions by stations authorized under this section may be made either in accordance with a Commission-approved average power technique or in compliance with paragraph (d)(6) of this section. In measuring transmissions in this band using an average power technique, the peak-to-average ratio (PAR) of the transmission may not exceed 13 dB.

Measurement Uncertainty

The assessed measurement uncertainty to ensure 95% confidence level for the normal distribution is with the coverage factor k = 2, U= 0.4 dB.

Test Results

| LTE Band 7 | | | | | | | | |
|------------|-----------------|---------|-----------------|------------|-----------|-----------|------------|------------|
| Modulation | Bandwidth (MHz) | Channel | Frequency (MHz) | Peak (dBm) | Avg (dBm) | PAPR (dB) | Limit (dB) | Conclusion |
| QPSK | 5 | 20775 | 2502.5 | 26.65 | 21.57 | 5.08 | ≤13 | PASS |
| | | 21100 | 2535 | 26.64 | 21.68 | 4.96 | ≤13 | PASS |
| | | 21425 | 2567.5 | 26.50 | 21.64 | 4.86 | ≤13 | PASS |
| | 10 | 20800 | 2505 | 26.76 | 21.65 | 5.11 | ≤13 | PASS |
| | | 21100 | 2535 | 26.78 | 21.70 | 5.08 | ≤13 | PASS |
| | | 21400 | 2565 | 26.61 | 21.68 | 4.93 | ≤13 | PASS |
| | 15 | 20825 | 2507.5 | 26.81 | 21.63 | 5.18 | ≤13 | PASS |
| | | 21100 | 2535 | 26.70 | 21.66 | 5.04 | ≤13 | PASS |
| | | 21375 | 2562.5 | 26.57 | 21.63 | 4.94 | ≤13 | PASS |
| | 20 | 20850 | 2510 | 26.61 | 21.60 | 5.01 | ≤13 | PASS |
| | | 21100 | 2535 | 26.67 | 21.61 | 5.06 | ≤13 | PASS |
| | | 21350 | 2560 | 26.46 | 21.59 | 4.87 | ≤13 | PASS |
| 16QAM | 5 | 20775 | 2502.5 | 26.51 | 21.00 | 5.51 | ≤13 | PASS |
| | | 21100 | 2535 | 26.66 | 21.09 | 5.57 | ≤13 | PASS |
| | | 21425 | 2567.5 | 26.52 | 21.04 | 5.48 | ≤13 | PASS |
| | 10 | 20800 | 2505 | 26.61 | 21.03 | 5.58 | ≤13 | PASS |
| | | 21100 | 2535 | 26.77 | 21.14 | 5.63 | ≤13 | PASS |
| | | 21400 | 2565 | 26.62 | 21.08 | 5.54 | ≤13 | PASS |
| | 15 | 20825 | 2507.5 | 26.49 | 21.00 | 5.49 | ≤13 | PASS |
| | | 21100 | 2535 | 26.62 | 21.09 | 5.53 | ≤13 | PASS |
| | | 21375 | 2562.5 | 26.49 | 21.04 | 5.45 | ≤13 | PASS |
| | 20 | 20850 | 2510 | 26.60 | 20.98 | 5.62 | ≤13 | PASS |
| | | 21100 | 2535 | 26.67 | 21.05 | 5.62 | ≤13 | PASS |
| | | 21350 | 2560 | 26.51 | 21.01 | 5.50 | ≤13 | PASS |

5.6 Frequency Stability

Ambient condition

| Temperature | Relative humidity | Pressure |
|-------------|-------------------|----------|
| 23°C ~25°C | 45%~50% | 101.5kPa |

Method of Measurement

Frequency Stability (Temperature Variation)

The temperature inside the climate chamber is varied from -30°C to +50°C in 10°C step size.

(1) With all power removed, the temperature was decreased to -10°C and permitted to stabilize for three hours.

(2) Measure the carrier frequency with the test equipment in a “call mode”. These measurements should be made within 1 minute of powering up the mobile station, to prevent significant self warming.

(3) Repeat the above measurements at 10°C increments from -30°C to +50°C. Allow at least 1.5 hours at each temperature, un-powered, before making measurements.

Frequency Stability (Voltage Variation)

The frequency stability shall be measured with variation of primary supply voltage as follows:

(1) Vary primary supply voltage from 85 to 115 percent of the nominal value for other than hand carried battery equipment.

(2) For hand carried, battery powered equipment, reduce primary supply voltage to the battery-operating end point which shall be specified by the manufacturer.

This transceiver is specified to operate with an input voltage of between 3.6 V and 4.3 V, with a nominal voltage of 3.8V.

Test setup

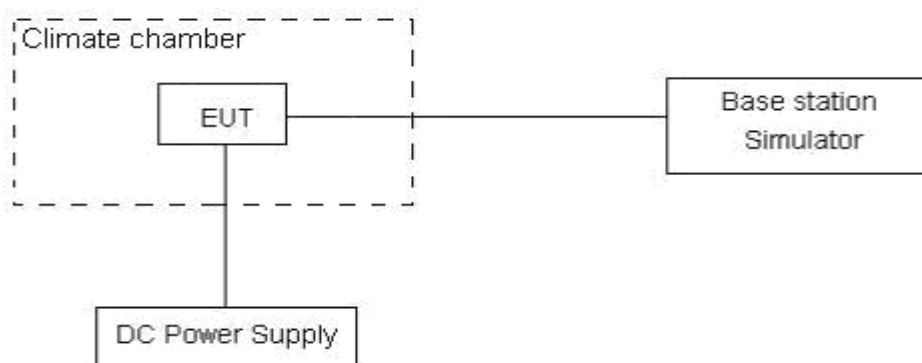

Limits

No specific frequency stability requirements in part 27.54

Measurement Uncertainty

The assessed measurement uncertainty to ensure 99.75% confidence level for the normal distribution is with the coverage factor $k = 3, U=0.01\text{ppm}$.

Test Result

| LTE Band 7 | | | | | |
|-------------------------|---------|-------------------|--------------------|---------------|-----------------------------|
| (QPSK, 20MHz BANDWIDTH) | | | | | |
| Condition | | 2500 | 2570 | Delta (Hz) | Frequency Stability(ppm) |
| Temperature | Voltage | F low@-13dBm(MHz) | F high@-13dBm(MHz) | | |
| Normal (25°C) | Normal | 2500.4392 | 2569.6772 | -3.45 | -0.00136 |
| Extreme (50°C) | | 2500.4381 | 2569.6781 | -2.02 | -0.00080 |
| Extreme (40°C) | | 2500.4387 | 2569.6775 | -1.23 | -0.00049 |
| Extreme (30°C) | | 2500.4381 | 2569.6782 | 1.75 | 0.00069 |
| Extreme (20°C) | | 2500.4386 | 2569.6776 | -2.09 | -0.00082 |
| Extreme (10C) | | 2500.4385 | 2569.6777 | -3.38 | -0.00133 |
| Extreme (0°C) | | 2500.4383 | 2569.6779 | -4.39 | -0.00173 |
| Extreme (-10°C) | | 2500.4384 | 2569.6778 | 3.22 | 0.00127 |
| Extreme (-20°C) | | 2500.4388 | 2569.6774 | -0.25 | -0.00010 |
| Extreme (-30°C) | | 2500.4391 | 2569.6772 | 3.69 | 0.00146 |
| 25°C | LV | 2500.4382 | 2569.678 | 3.02 | 0.00119 |
| | HV | 2500.4386 | 2569.6776 | -9.67 | -0.00381 |
| (16QAM,20MHz BANDWIDTH) | | | | | |
| Condition | | 2500 | 2570 | Delta (Hz) | Frequency Stability(ppm) |
| Temperature | Voltage | F low@-13dBm(MHz) | F high@-13dBm(MHz) | | |
| Normal (25°C) | Normal | 2500.4007 | 2569.6111 | -1.00 | -0.00039 |
| Extreme (50°C) | | 2500.3996 | 2569.6122 | -2.30 | -0.00091 |
| Extreme (40°C) | | 2500.4002 | 2569.6116 | 0.63 | 0.00025 |
| Extreme (30°C) | | 2500.3995 | 2569.6123 | -2.96 | -0.00117 |
| Extreme (20°C) | | 2500.4001 | 2569.6117 | -1.02 | -0.00040 |
| Extreme (10C) | | 2500.4002 | 2569.6118 | -1.13 | -0.00045 |
| Extreme (0°C) | | 2500.3998 | 2569.6121 | -1.54 | -0.00061 |
| Extreme (-10°C) | | 2500.3999 | 2569.6119 | 2.93 | 0.00116 |
| Extreme (-20°C) | | 2500.4003 | 2569.6115 | 0.97 | 0.00038 |
| Extreme (-30°C) | | 2500.4005 | 2569.6113 | -0.40 | -0.00016 |
| 25°C | LV | 2500.3997 | 2569.6121 | 0.06 | 0.00002 |
| | HV | 2500.4001 | 2569.6117 | 3.08 | 0.00121 |

5.7 Spurious Emissions at Antenna Terminals

Ambient condition

| Temperature | Relative humidity | Pressure |
|-------------|-------------------|----------|
| 23°C ~25°C | 45%~50% | 101.5kPa |

Method of Measurement

The EUT was connected to Spectrum Analyzer and Base Station Simulator via power Splitter. The measurement is carried out using a spectrum analyzer. The spectrum analyzer scans from 9kHz to the 10th harmonic of the carrier. The peak detector is used.

RBW is set to 100kHz, VBW is set to 300kHz for 30MHz~1GHz

RBW is set to 1MHz, VBW is set to 3MHz for above 1GHz, Sweep is set to ATUO.

Of those disturbances below (limit – 20 dB), the mark is not required for the EUT.

The modulation mode and RB allocation refer to section 5.1, using the maximum output power configuration.

Test setup

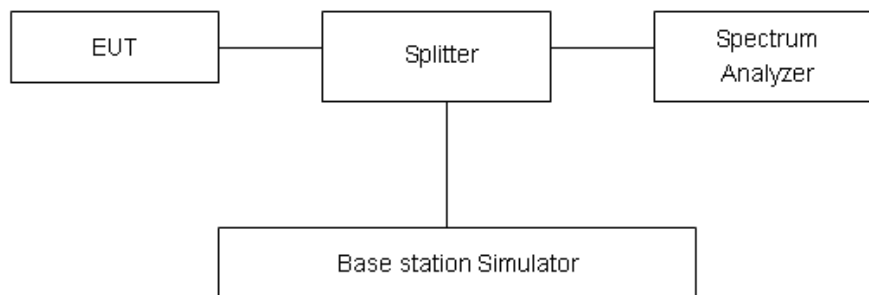

Limits

Rule Part 27.53(m) $55 + 10 \log (P)$ dB on all frequencies more than X megahertz from the channel edge, where X is the greater of 6 megahertz or the actual emission bandwidth as defined in paragraph (m)(4) of this section.

| | |
|---------------------|---------|
| Part 27.53(m) Limit | -25 dBm |
|---------------------|---------|

Measurement Uncertainty

The assessed measurement uncertainty to ensure 99.75% confidence level for the normal distribution is with the coverage factor $k = 1.96$.

| Frequency | Uncertainty |
|------------|-------------|
| 9kHz-1GHz | 0.684 dB |
| 1GHz-26GHz | 1.407 dB |

Test Result

Sweep the whole frequency band through the range from 9kHz to the 10th harmonic of the carrier, the emissions more than 20 dB below the permissible value are not reported.

The signal beyond the limit is carrier.

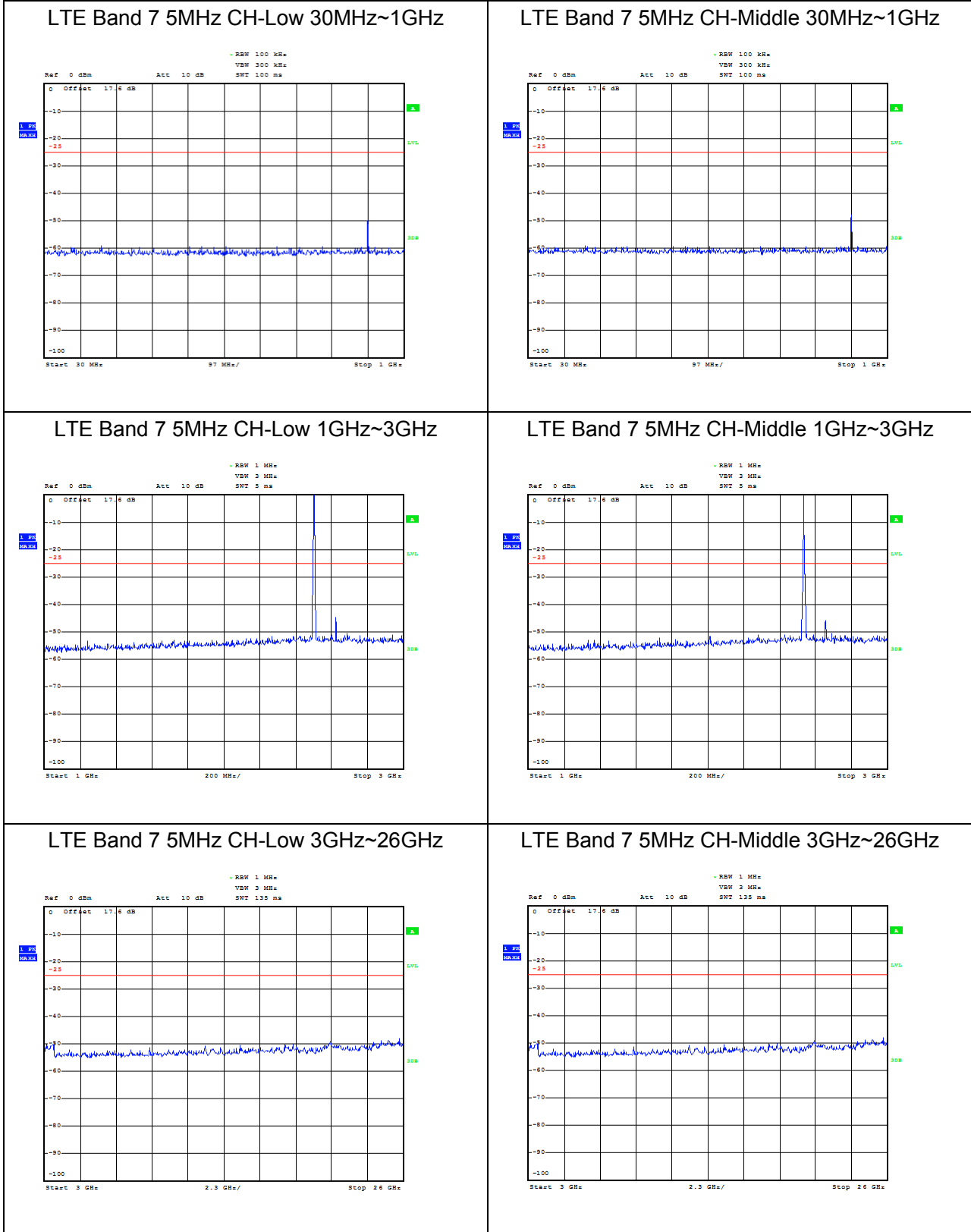



LTE Band 7 5MHz CH-High 30MHz~1GHz

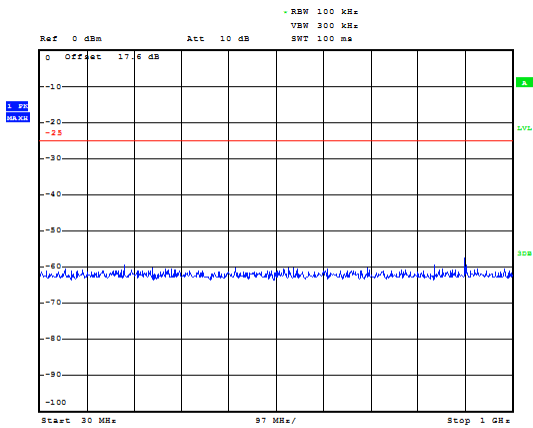

LTE Band 7 10MHz CH-Low 30MHz~1GHz

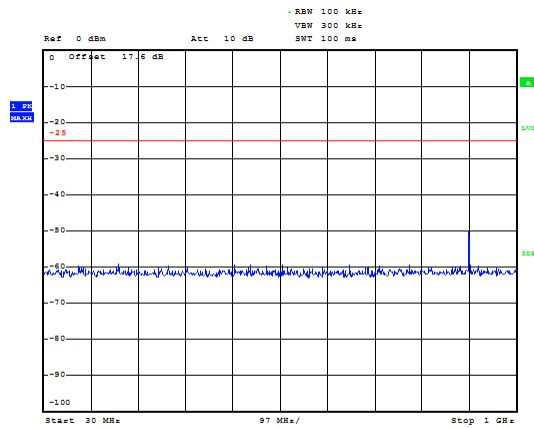

LTE Band 7 5MHz CH-High 1GHz~3GHz

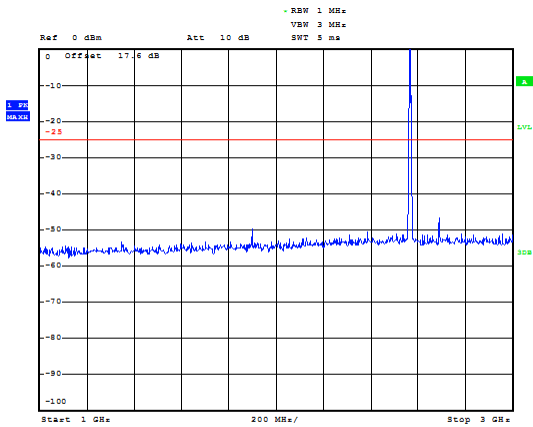

LTE Band 7 10MHz CH-Low 1GHz~3GHz

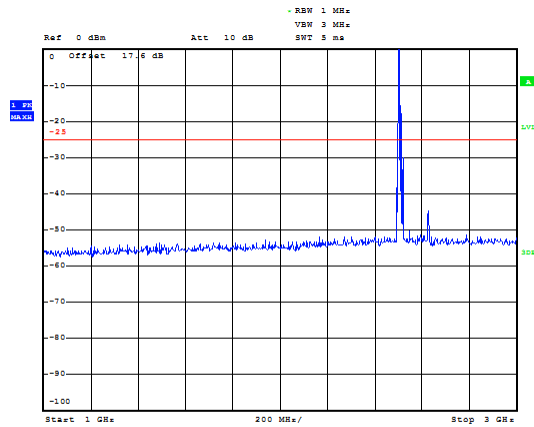

LTE Band 7 5MHz CH-High 3GHz~26GHz

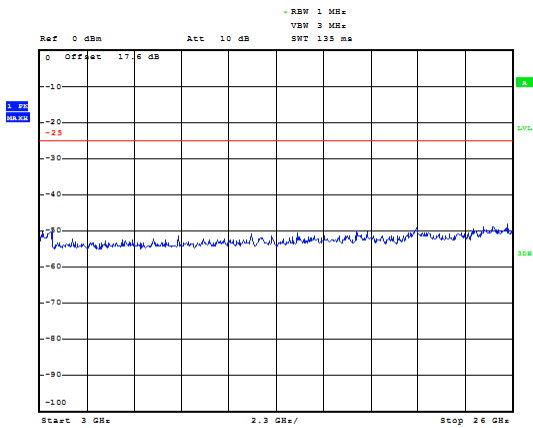

LTE Band 7 10MHz CH-Low 3GHz~26GHz

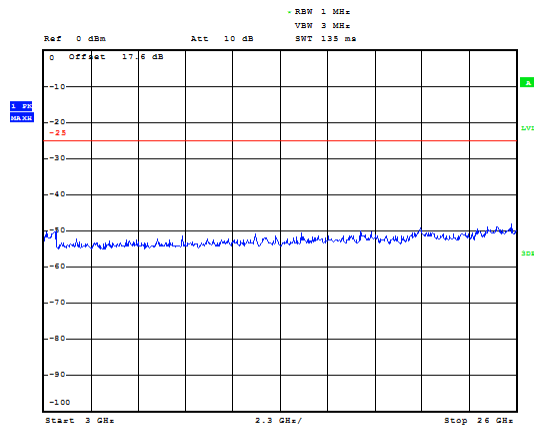



LTE Band 7 10MHz CH-Middle 30MHz~1GHz

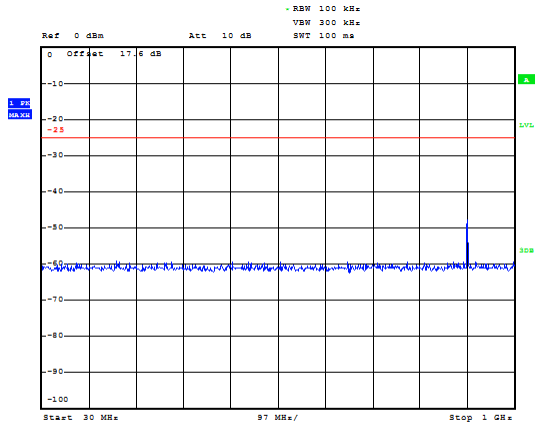

LTE Band 7 10MHz CH-High 30MHz~1GHz

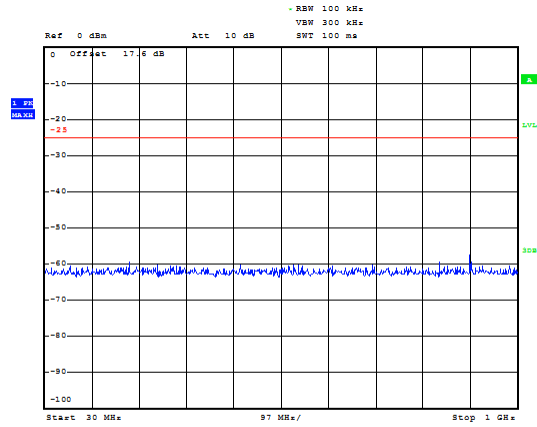

LTE Band 7 10MHz CH-Middle 1GHz~3GHz

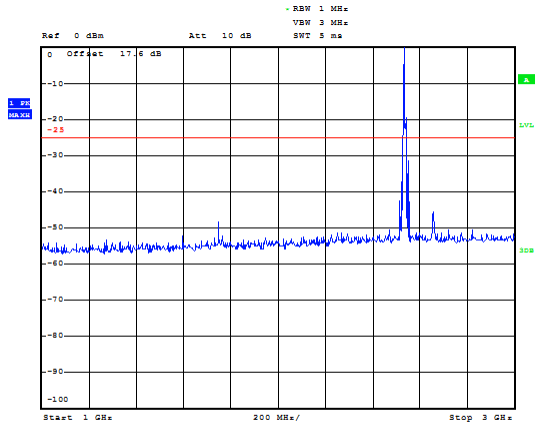

LTE Band 7 10MHz CH-High 1GHz~3GHz

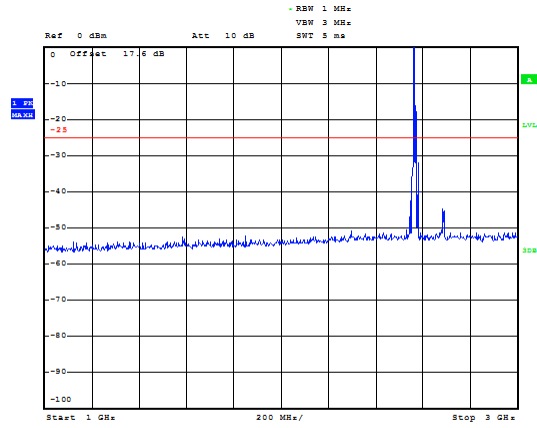

LTE Band 7 10MHz CH-Middle 3GHz~26GHz

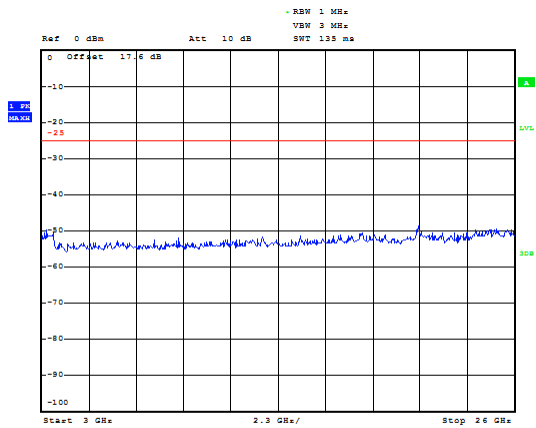

LTE Band 7 10MHz CH-High 3GHz~26GHz

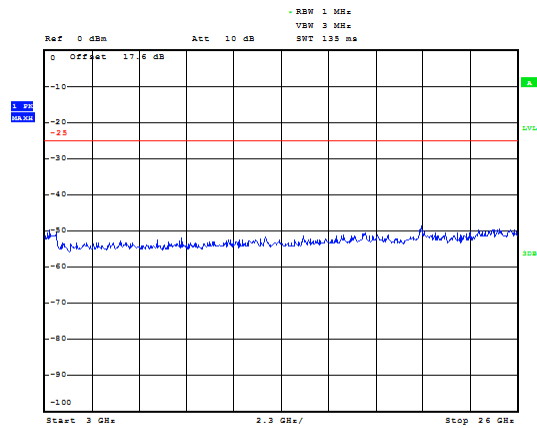



LTE Band 7 15MHz CH-Low 30MHz~1GHz

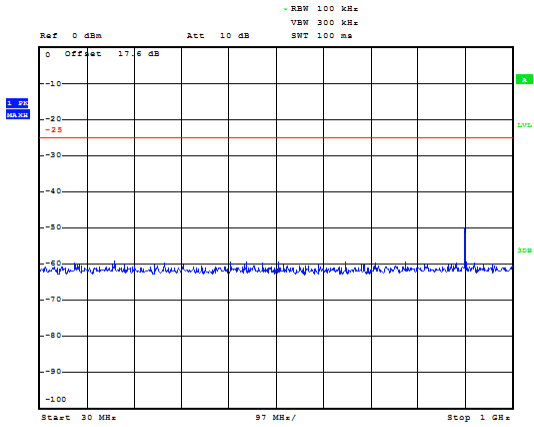

LTE Band 7 15MHz CH-Middle 30MHz~1GHz

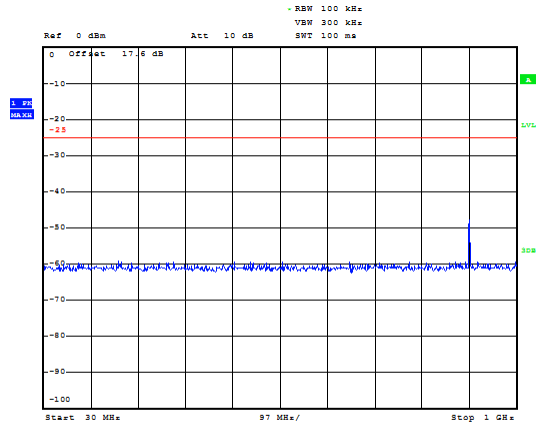

LTE Band 7 15MHz CH-Low 1GHz~3GHz

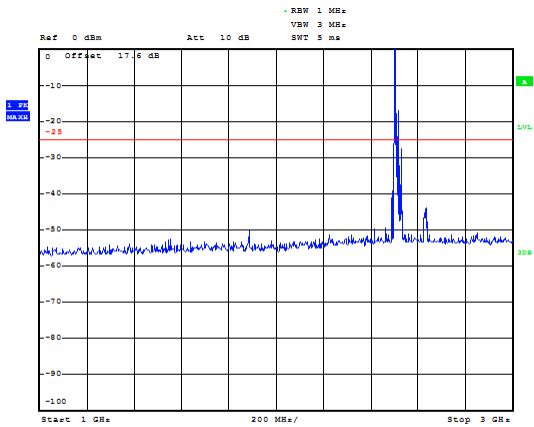

LTE Band 7 15MHz CH-Middle 1GHz~3GHz

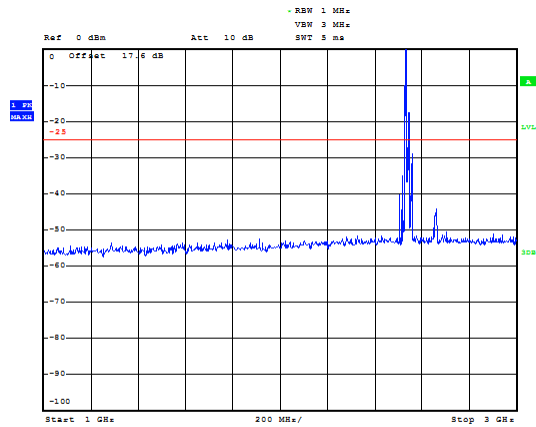

LTE Band 7 15MHz CH-Low 3GHz~26GHz

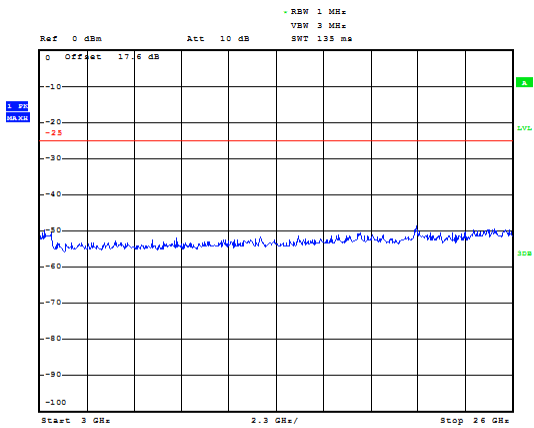

LTE Band 7 15MHz CH-Middle 3GHz~26GHz

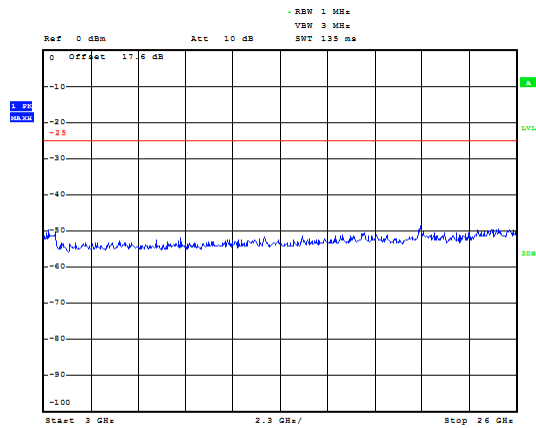



LTE Band 7 15MHz CH-High 30MHz~1GHz

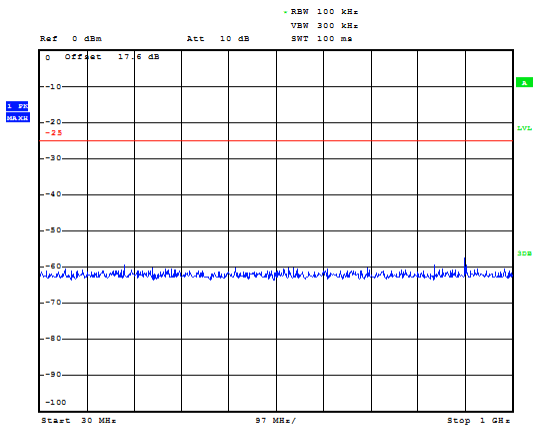

LTE Band 7 20MHz CH-Low 30MHz~1GHz

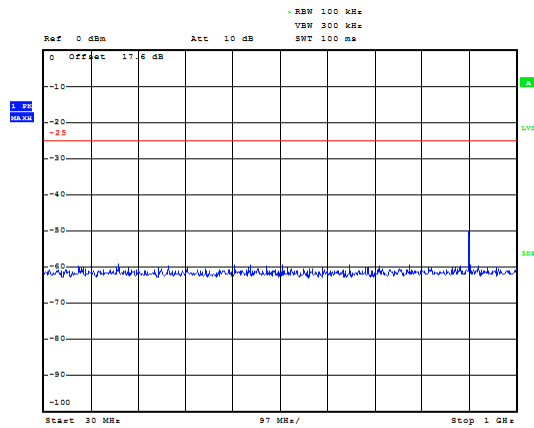

LTE Band 7 15MHz CH-High 1GHz~3GHz

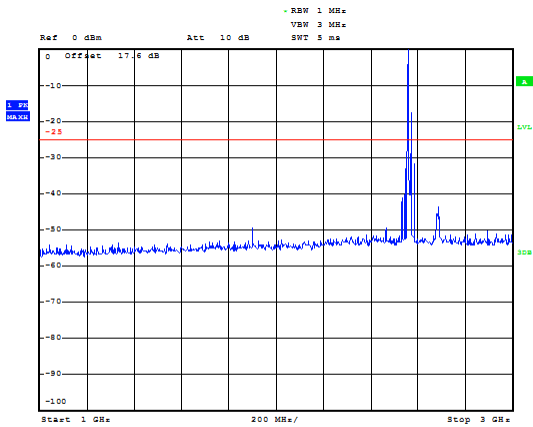

LTE Band 7 20MHz CH-Low 1GHz~3GHz

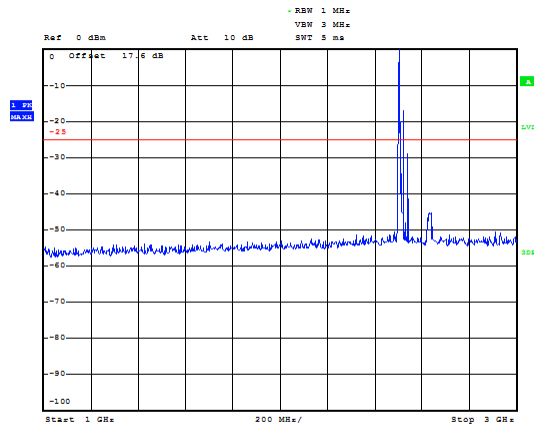

LTE Band 7 15MHz CH-High 3GHz~26GHz

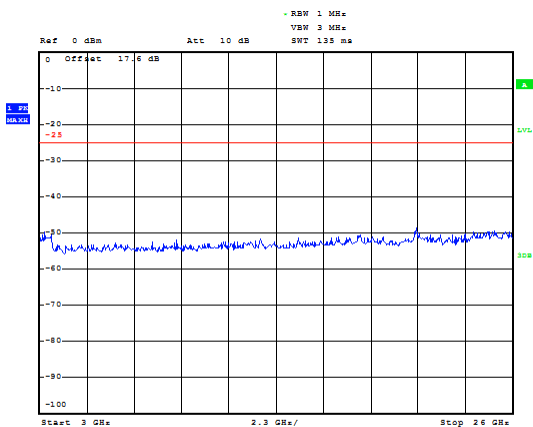

LTE Band 7 20MHz CH-Low 3GHz~26GHz

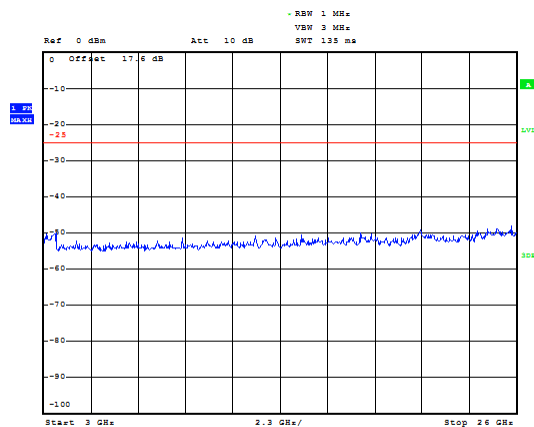

LTE Band 7 20MHz CH-Middle 30MHz~1GHz

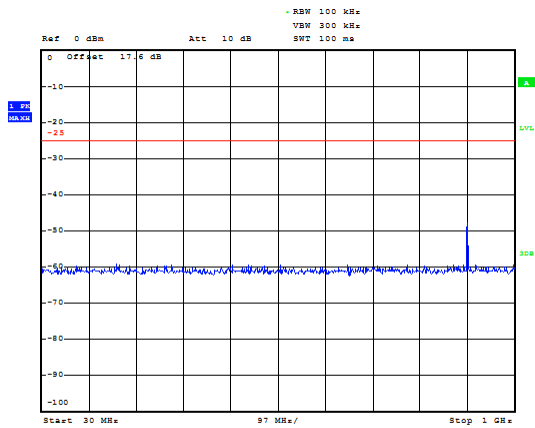

LTE Band 7 20MHz CH-High 30MHz~1GHz

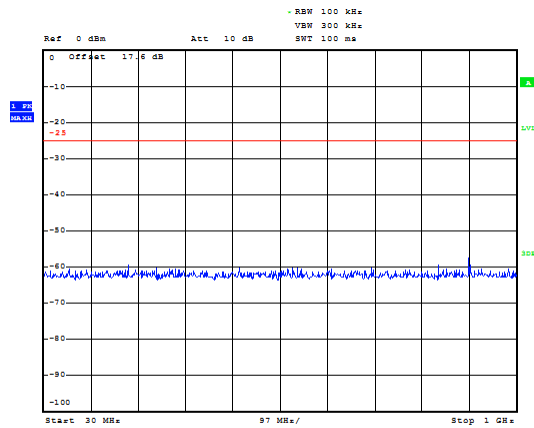

LTE Band 7 20MHz CH-Middle 1GHz~3GHz

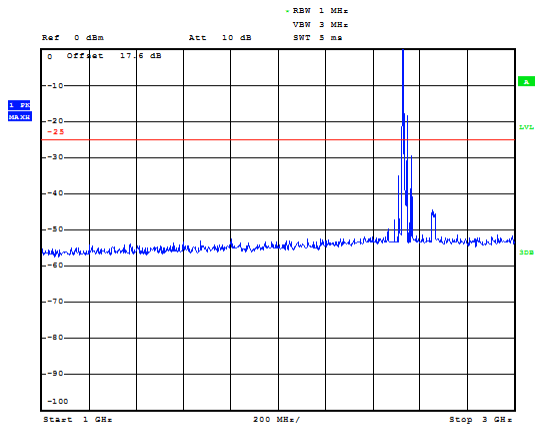

LTE Band 7 20MHz CH-High 1GHz~3GHz

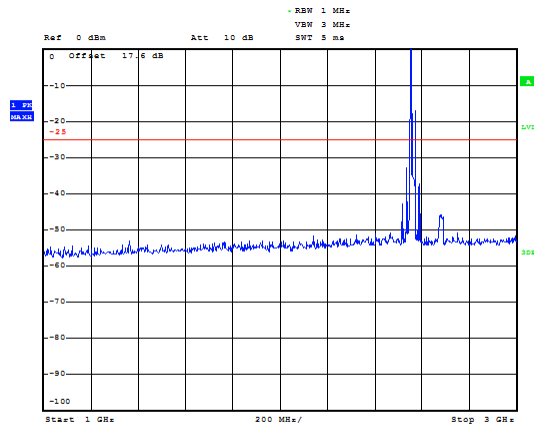

LTE Band 7 20MHz CH-Middle 3GHz~26GHz

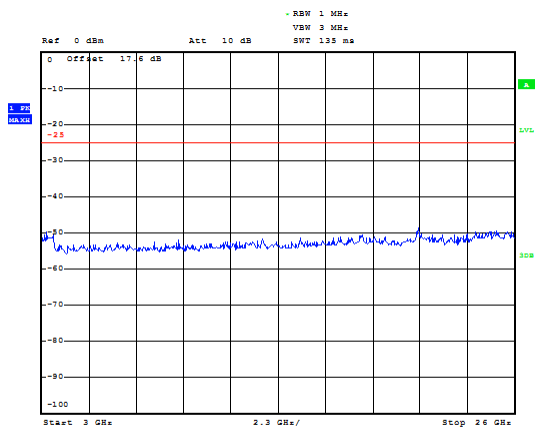

LTE Band 7 20MHz CH-High 3GHz~26GHz

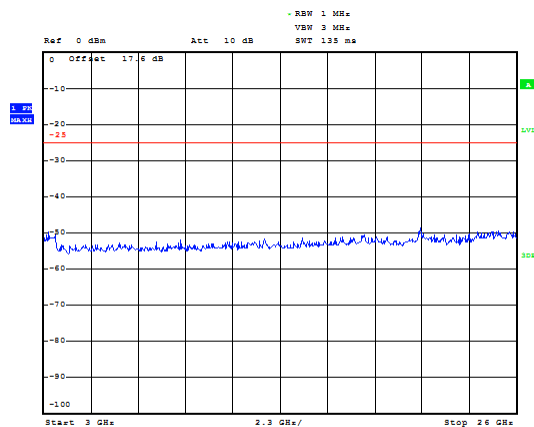

5.8 Radiates Spurious Emission

Ambient condition

| Temperature | Relative humidity | Pressure |
|-------------|-------------------|----------|
| 23°C ~25°C | 45%~50% | 101.5kPa |

Method of Measurement

1. The testing follows FCC KDB 971168 D01 v03r01 Section 5.8 and ANSI/TIA-603-E (2016).
2. The EUT is placed on a turntable 0.8 meters above the ground in the chamber, 3 meter away from the antenna. The maximal emission value is acquired by adjusting the antenna height, polarisation and turntable azimuth. Normally, the height range of antenna is 1 m to 4 m, the azimuth range of turntable is 0° to 360°, and the receive antenna has two polarizations Vertical (V) and Horizontal (H).
3. A log-periodic antenna or double-ridged waveguide horn antenna shall be substituted in place of the EUT. The log-periodic antenna will be driven by a signal generator and the level will be adjusted till the same power value on the spectrum analyzer or receiver. The level of the spurious emissions can be calculated through the level of the signal generator, cable loss, the gain of the substitution antenna and the reading of the spectrum analyzer or receiver.
4. The EUT is then put into continuously transmitting mode at its maximum power level during the test. Set Test Receiver or Spectrum RBW=1MHz, VBW=3MHz, And the maximum value of the receiver should be recorded as (Pr).
5. The EUT shall be replaced by a substitution antenna. In the chamber, an substitution antenna for the frequency band of interest is placed at the reference point of the chamber. An RF Signal source for the frequency band of interest is connected to the substitution antenna with a cable that has been constructed to not interfere with the radiation pattern of the antenna. A power (PMea) is applied to the input of the substitution antenna, and adjust the level of the signal generator output until the value of the receiver reach the previously recorded (Pr). The power of signal source (PMea) is recorded. The test should be performed by rotating the test item and adjusting the receiving antenna polarization.
6. A amplifier should be connected to the Signal Source output port. And the cable should be connect between the Amplifier and the Substitution Antenna. The cable loss (Pcl) ,the Substitution Antenna Gain (Ga) and the Amplifier Gain (PAg) should be recorded after test.
7. The measurement results are obtained as described below:

$$\text{Power(EIRP)} = \text{PMea} - \text{PAg} - \text{Pcl} + \text{Ga}$$
 The measurement results are amend as described below:

$$\text{Power(EIRP)} = \text{PMea} - \text{Pcl} + \text{Ga}$$
8. This value is EIRP since the measurement is calibrated using an antenna of known gain (2.15 dBi) and known input power. ERP can be calculated from EIRP by subtracting the gain of the dipole, $\text{ERP} = \text{EIRP} - 2.15\text{dBi}$.
 The modulation mode and RB allocation refer to section 5.1, using the maximum output power configuration.

Test setup

30MHz~~~ 1GHz

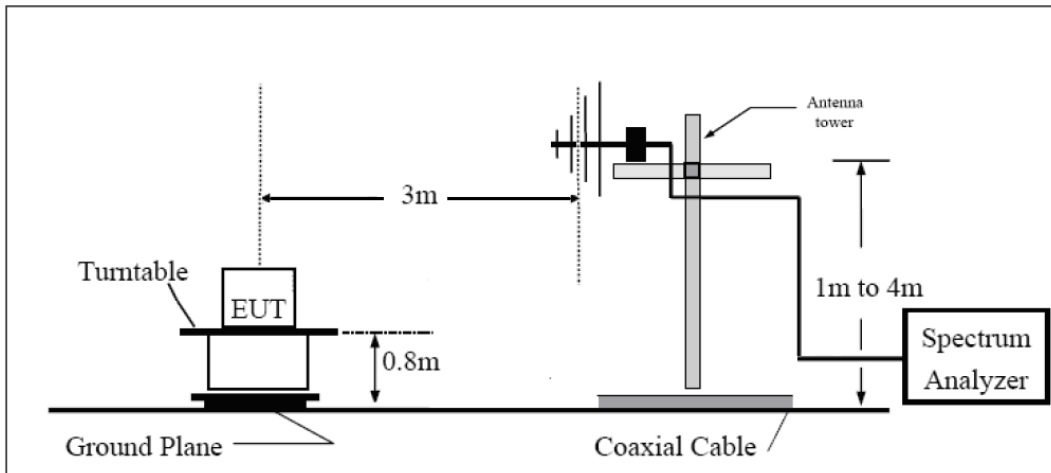

Above 1GHz

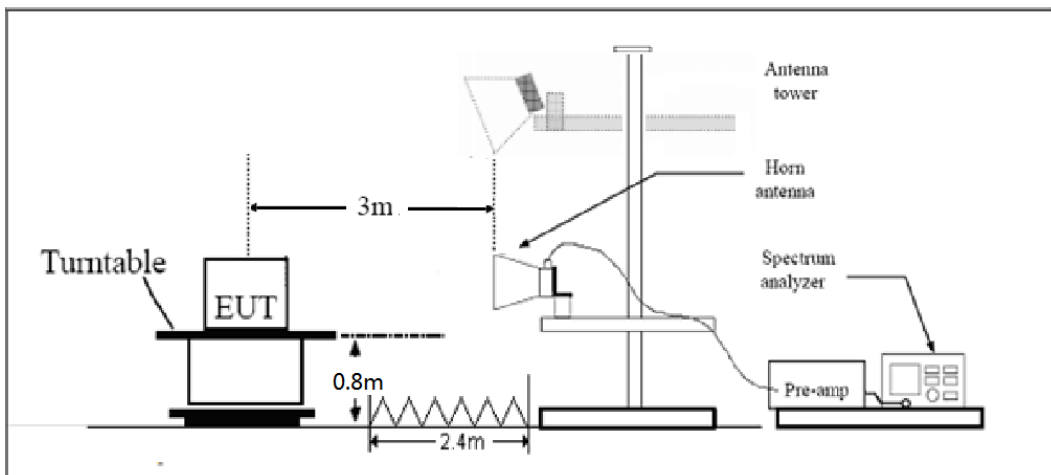

Note: Area side:2.4mX3.6m

The radiated emission was measured in the following position: EUT stand-up position (Z axis), lie-down position (X, Y axis). The worst emission was found in lie-down position (X axis) and the worst case was recorded.

Limits

Rule Part 27.53(m) $55 + 10 \log (P)$ dB on all frequencies more than X megahertz from the channel edge, where X is the greater of 6 megahertz or the actual emission bandwidth as defined in paragraph (m)(4) of this section.

| | |
|-------|---------|
| Limit | -25 dBm |
|-------|---------|

Measurement Uncertainty

The assessed measurement uncertainty to ensure 95% confidence level for the normal distribution is with the coverage factor $k = \pm 1.96$, $U = \pm 3.55$ dB.

Test Result

Sweep the whole frequency band through the range from 30MHz to the 10th harmonic of the carrier, from 30MHz to 1GHz and above 12 GHz are all base noise will not recorded in the report.

LTE Band 7 20MHz CH-Middle

| Harmonic | Frequency (MHz) | SG (dBm) | Cable Loss (dB) | Gain (dBi) | Antenna Polarization | EIRP Level (dBm) | Limit (dBm) | Margin (dB) | Azimuth (deg) |
|----------|-----------------|----------|-----------------|------------|----------------------|------------------|-------------|-------------|---------------|
| 2 | 5070.0 | -56.75 | 2.00 | 10.15 | Horizontal | -48.6 | -25.00 | 23.6 | 225 |
| 3 | 7605.0 | -53.25 | 2.50 | 11.35 | Horizontal | -44.4 | -25.00 | 19.4 | 225 |
| 4 | 10140.0 | -48.55 | 4.20 | 12.05 | Horizontal | -40.7 | -25.00 | 15.7 | 315 |
| 5 | 12675.0 | -- | -- | -- | -- | -- | -- | -- | -- |
| 6 | 15210.0 | -- | -- | -- | -- | -- | -- | -- | -- |
| 7 | 17745.0 | -- | -- | -- | -- | -- | -- | -- | -- |
| 8 | 20280.0 | -- | -- | -- | -- | -- | -- | -- | -- |
| 9 | 22815.0 | -- | -- | -- | -- | -- | -- | -- | -- |
| 10 | 25350.0 | -- | -- | -- | -- | -- | -- | -- | -- |

Note: 1.The other Spurious RF Radiated emissions level is no more than noise floor.

2. The worst emission was found in the antenna is Horizontal position.

6 Main Test Instruments

| Name | Manufacturer | Type | Serial Number | Calibration Date | Expiration Date |
|------------------------|--------------|--------------|---------------|------------------|-----------------|
| Base Station Simulator | R&S | CMW500 | 113645 | 2018-05-20 | 2019-05-19 |
| Power Splitter | Hua Xiang | SHX-GF2-2-13 | 10120101 | 2018-05-20 | 2019-05-19 |
| Spectrum Analyzer | Key sight | N9010A | MY50210259 | 2018-05-20 | 2019-05-19 |
| Signal Analyzer | R&S | FSV30 | 100815 | 2017-12-17 | 2018-12-16 |
| Signal generator | R&S | SMB 100A | 102594 | 2018-05-20 | 2019-05-19 |
| EMI Test Receiver | R&S | ESCI | 100948 | 2018-05-20 | 2019-05-19 |
| Loop Antenna | SCHWARZBECK | FMZB1519 | 1519-047 | 2014-12-06 | 2019-12-05 |
| Trilog Antenna | SCHWARZBECK | VUBL 9163 | 9163-201 | 2017-11-18 | 2020-11-17 |
| Horn Antenna | R&S | HF907 | 100126 | 2014-12-06 | 2019-12-05 |
| Horn Antenna | ETS-Lindgren | 3160-09 | 00102643 | 2015-01-30 | 2020-01-29 |
| Climatic Chamber | Re Ce | PT-30B | 20101891 | 2015-07-18 | 2018-07-17 |
| RF Cable | Agilent | SMA 15cm | 0001 | NA | NA |
| Preamplifier | R&S | SCU18 | 102327 | 2018-05-20 | 2019-05-19 |
| MOB COMMS DC SUPPLY | Keysight | 66319D | MY43004105 | 2018-05-20 | 2019-05-19 |
| Software | R&S | EMC32 | V 8.52.0 | NA | NA |

*****END OF REPORT *****