



RF TEST REPORT

Applicant Huawei Technologies Co., Ltd.
FCC ID QISAGS2-L09
Product Tablet
Model AGS2-L09
Report No. R1806H0068-R2
Issue Date June 26, 2018

TA Technology (Shanghai) Co., Ltd. tested the above equipment in accordance with the requirements in **FCC CFR47 Part 2 (2017)/ FCC CFR 47 Part 24E (2017)**. The test results show that the equipment tested is capable of demonstrating compliance with the requirements as documented in this report.

Jiang peng Lan

Performed by: Jiangpeng Lan

Kai Xu

Approved by: Kai Xu

TA Technology (Shanghai) Co., Ltd.

No.145, Jintang Rd, Tangzhen Industry Park, Pudong Shanghai, China

TEL: +86-021-50791141/2/3

FAX: +86-021-50791141/2/3-8000



TABLE OF CONTENT

1. Test Laboratory	4
1.1. Notes of the test report.....	4
1.2. Test facility.....	4
1.3. Testing Location	5
2. General Description of Equipment under Test.....	6
3. Applied Standards.....	8
4. Test Configuration.....	9
5. Test Case Results.....	10
5.1. RF Power Output.....	10
5.2. Effective Isotropic Radiated Power	12
5.3. Occupied Bandwidth	15
5.4. Band Edge Compliance.....	19
5.5. Peak-to-Average Power Ratio (PAPR)	22
5.6. Frequency Stability	24
5.7. Spurious Emissions at Antenna Terminals	28
5.8. Radiates Spurious Emission	32
6. Main Test Instruments	35

Summary of measurement results

No.	Test Case	Clause in FCC rules	Verdict
1	RF power output	2.1046	PASS
2	Effective Isotropic Radiated power	24.232(c)	PASS
3	Occupied Bandwidth	2.1049	PASS
4	Band Edge Compliance	2.1051 /24.238(a)	PASS
5	Peak-to-Average Power Ratio	24.232/KDB 971168 D01(5.7)	PASS
6	Frequency Stability	2.1055 / 24.235	PASS
7	Spurious Emissions at Antenna Terminals	2.1051 / 24.238(a)	PASS
8	Radiates Spurious Emission	2.1053 / 24.238(a)	PASS
Date of Testing: June 6, 2018 ~ June 22, 2018			
Note: PASS: The EUT complies with the essential requirements in the standard. FAIL: The EUT does not comply with the essential requirements in the standard.			

1. Test Laboratory

1.1. Notes of the test report

This report shall not be reproduced in full or partial, without the written approval of **TA technology (shanghai) co., Ltd.** The results documented in this report apply only to the tested sample, under the conditions and modes of operation as described herein. Measurement Uncertainties were not taken into account and are published for informational purposes only. This report is written to support regulatory compliance of the applicable standards stated above.

1.2. Test facility

CNAS (accreditation number: L2264)

TA Technology (Shanghai) Co., Ltd. has obtained the accreditation of China National Accreditation Service for Conformity Assessment (CNAS).

FCC (Designation number: CN1179, Test Firm Registration Number: 446626)

TA Technology (Shanghai) Co., Ltd. has been listed on the US Federal Communications Commission list of test facilities recognized to perform electromagnetic emissions measurements.

IC (recognition number is 8510A)

TA Technology (Shanghai) Co., Ltd. has been listed by industry Canada to perform electromagnetic emission measurement.

VCCI (recognition number is C-4595, T-2154, R-4113, G-10766)

TA Technology (Shanghai) Co., Ltd. has been listed by industry Japan to perform electromagnetic emission measurement.

A2LA (Certificate Number: 3857.01)

TA Technology (Shanghai) Co., Ltd. has been listed by American Association for Laboratory Accreditation to perform electromagnetic emission measurement.



1.3. Testing Location

Company: TA Technology (Shanghai) Co., Ltd.
Address: No.145, Jintang Rd, Tangzhen Industry Park, Pudong
City: Shanghai
Post code: 201201
Country: P. R. China
Contact: Xu Kai
Telephone: +86-021-50791141/2/3
Fax: +86-021-50791141/2/3-8000
Website: <http://www.ta-shanghai.com>
E-mail: xukai@ta-shanghai.com

2. General Description of Equipment under Test

Client Information

Applicant	Huawei Technologies Co., Ltd.
Applicant address	Administration Building, Headquarters of Huawei Technologies Co., Ltd., Bantian, Longgang District, Shenzhen, 518129, P.R.China.
Manufacturer	Huawei Technologies Co., Ltd.
Manufacturer address	Administration Building, Headquarters of Huawei Technologies Co., Ltd., Bantian, Longgang District, Shenzhen, 518129, P.R.China.

General information

EUT Description			
Model	AGS2-L09		
IMEI	004401721144414		
Hardware Version	A6t6e		
Software Version	AGS2-L09 8.0.0.1(SP1C432log)		
Power Supply	Battery/AC adapter		
Antenna Type	Internal Antenna		
Test Mode(s)	GSM1900; WCDMA Band II		
Test Modulation	(GSM)GMSK,8PSK; (WCDMA)QPSK;		
GPRS Multislot Class	12		
EGPRS Multislot Class	12		
HSDPA UE Category	24		
HSUPA UE Category	6		
Maximum E.I.R.P	GSM 1900:	28.24dBm	
	WCDMA Band II:	22.28dBm	
Rated Power Supply Voltage	3.8V		
Extreme Voltage	Minimum: 3.6V Maximum: 4.3V		
Extreme Temperature	Lowest: 0°C Highest: +35°C		
Operating Frequency Range(s)	Band	Tx (MHz)	Rx (MHz)
	GSM1900	1850 ~ 1910	1930 ~ 1990
	WCDMA Band II	1850 ~ 1910	1930 ~ 1990
EUT Accessory			
Adapter 1	Manufacturer: Huawei Technologies Co., Ltd. Model: HW-050100E01		
Adapter 2	Manufacturer: Huawei Technologies Co., Ltd. Model: HW-050100B01		
Adapter 3	Manufacturer: Huawei Technologies Co., Ltd. Model: HW-050100A01		
Adapter 4	Manufacturer: Huawei Technologies Co., Ltd.		



	Model: HW-050100U01
Battery	Manufacturer: Huawei Technologies Co., Ltd. (SCUD) Model: HB2899C0ECW-C
USB Extend Cable	100cm Cable, Signal Cable, USB2.0, 5V 1A
Note: The information of the EUT is declared by the manufacturer.	



3. Applied Standards

According to the specifications of the manufacturer, it must comply with the requirements of the following standards:

FCC CFR47 Part 2 (2017)

FCC CFR 47 Part 24E (2017)

ANSI/TIA-603-E (2016)

KDB 971168 D01 Power Meas License Digital Systems v03r01

4. Test Configuration

Radiated measurements are performed by rotating the EUT in three different orthogonal test planes. EUT stand-up position (Z axis), lie-down position (X, Y axis). Receiver antenna polarization (horizontal and vertical), the worst emission was found in position (Z axis, horizontal polarization) and the worst case was recorded.

All mode and data rates and positions and RB size and modulations were investigated.

Subsequently, only the worst case emissions are reported.

The following testing in GSM/WCDMA is set based on the maximum RF Output Power.

Test modes are chosen to be reported as the worst case configuration below:

	Test items	Modes/Modulation	
		GSM 1900	WCDMA Band II
Conducted Test cases	RF power output	GSM GPRS EGPRS	RMC HSDPA/ HSUPA
	Occupied Bandwidth	GSM GPRS(1Tx slot) EGPRS(1Tx slot)	RMC
	Band Edge Compliance	GSM GPRS(1Tx slot) EGPRS(1Tx slot)	RMC
	Peak-to-Average Power Ratio	GSM GPRS(1Tx slot) EGPRS(1Tx slot)	RMC
	Frequency Stability	GSM GPRS(1Tx slot) EGPRS(1Tx slot)	RMC
	Spurious Emissions at Antenna Terminals	GSM	RMC
Radiated Test cases	Effective Isotropic Radiated power	GSM GPRS(1Tx slot) EGPRS(1Tx slot)	RMC
	Radiates Spurious Emission	GSM	RMC

5. Test Case Results

5.1.RF Power Output

Ambient condition

Temperature	Relative humidity	Pressure
23°C ~25°C	45%~50%	101.5kPa

Methods of Measurement

During the process of the testing, The EUT is controlled by the Base Station Simulator to ensure max power transmission and proper modulation.

Test Setup

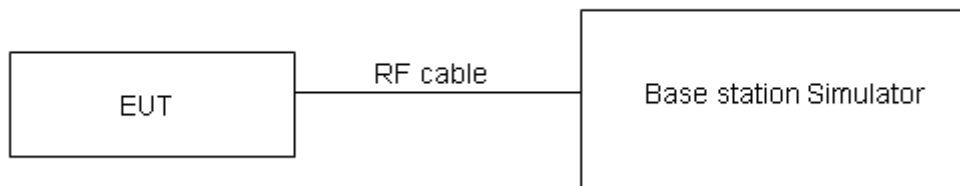

The loss between RF output port of the EUT and the input port of the tester has been taken into consideration.

Limits

No specific RF power output requirements in part 2.1046.

Measurement Uncertainty

The assessed measurement uncertainty to ensure 95% confidence level for the normal distribution is with the coverage factor $k = 2$, $U = 0.4$ dB.

Test Results

GSM 1900		Conducted Power(dBm)		
		Channel 512	Channel 661	Channel 810
		1850.2(MHz)	1880(MHz)	1909.8(MHz)
GSM	CS	30.05	29.91	29.68
GPRS (GMSK)	1TXslot	29.66	29.60	29.57
	2TXslots	27.63	27.52	27.52
	3TXslots	25.57	25.50	25.51
	4TXslots	24.64	24.54	24.53
EGPRS (8PSK)	1TXslot	25.19	25.17	25.18
	2TXslots	23.78	23.74	23.73
	3TXslots	22.01	21.95	21.97
	4TXslots	20.78	20.75	20.73

WCDMA Band II		Conducted Power(dBm)		
		Channel 9262	Channel 9400	Channel 9538
		1852.4(MHz)	1880(MHz)	1907.6(MHz)
RMC	12.2k	22.55	22.48	22.53
HSDPA	Sub - Test 1	20.89	20.84	20.90
	Sub - Test 2	22.29	22.39	22.40
	Sub - Test 3	21.82	21.90	21.90
	Sub - Test 4	22.27	21.87	21.88
HSUPA	Sub - Test 1	19.82	19.74	19.66
	Sub - Test 2	18.52	18.44	18.11
	Sub - Test 3	19.38	20.42	20.09
	Sub - Test 4	18.47	18.41	19.10
	Sub - Test 5	22.38	22.41	22.46

5.2. Effective Isotropic Radiated Power

Ambient condition

Temperature	Relative humidity	Pressure
23°C ~25°C	45%~50%	101.5kPa

Methods of Measurement

The testing follows FCC KDB 971168 v03r01 Section 5.8 and ANSI/TIA-603-E (2016).

- a) Connect the equipment as illustrated. Mount the equipment with the manufacturer specified antenna in a vertical orientation on a manufacturer specified mounting surface located on a non-conducting rotating platform of a RF anechoic chamber (preferred) or a standard radiation site.
- b) Key the transmitter, then rotate the EUT 360° azimuthally and record spectrum analyzer power level (LVL) measurements at angular increments that are sufficiently small to permit resolution of all peaks. If a standard radiation test site is used, raise and lower the test antenna to obtain a maximum reading at each angular increment. (Note: several batteries may be needed to offset the effect of battery voltage droop, which should not exceed 5% of the manufactured specified battery voltage during transmission).
- c) Replace the transmitter under test with a vertically polarized half-wave dipole (or an antenna whose gain is known relative to an ideal half-wave dipole). The center of the antenna should be at the same location as the center of the antenna under test.
- d) Connect the antenna to a signal generator with a known output power and record the path loss (in dB) as LOSS. If a standard radiation test site is used, raise and lower the test antenna to obtain a maximum reading. $LOSS = \text{Generator Output Power (dBm)} - \text{Analyzer reading (dBm)}$
- e) Determine the effective radiated output power at each angular position from the readings in steps b) and d) using the following equation: $ERP \text{ (dBm)} = \text{LVL (dBm)} + \text{LOSS (dB)}$
- f) The maximum ERP is the maximum value determined in the preceding step.
- g) When calculating ERP, in addition to knowing the antenna radiation and matching characteristics, it is necessary to know the loss values of all elements (e.g. transmission line attenuation, mismatches, filters, combiners) interposed between the point where transmitter output power is measured, and the point where power is applied to the antenna. ERP can then be calculated as follows:
 $ERP \text{ (dBm)} = \text{Output Power (dBm)} - \text{Losses (dB)} + \text{Antenna Gain (dBd)}$
where: dBd refers to gain relative to an ideal dipole.
 $EIRP \text{ (dBm)} = ERP \text{ (dBm)} + 2.15 \text{ (dB.)}$

The RB allocation refers to section 5.1, using the maximum output power configuration.

Test setup

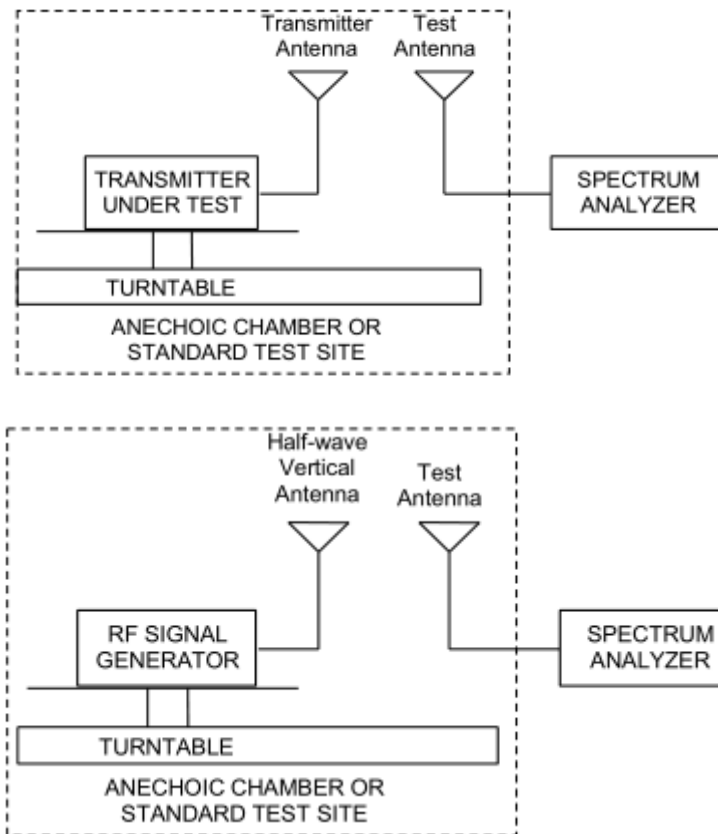

Limits

Rule Part 24.232(c) Mobile and portable stations are limited to 2 watts EIRP.

Rule Part 24.232(e) Peak transmit power must be measured over any interval of continuous transmission using instrumentation calibrated in terms of an rms-equivalent voltage.

Limit	$\leq 2\text{ W}$ (33 dBm)
-------	----------------------------

Measurement Uncertainty

The assessed measurement uncertainty to ensure 95% confidence level for the normal distribution is with the coverage factor $k = 2$, $U = 1.19\text{ dB}$

Test Results:

The measurement is performed for both of horizontal and vertical antenna Polarization, and only the data of worst mode is recorded in this report.

Mode	Channel	Frequency (MHz)	Polarization	EIRP (dBm)	Limit (dBm)	Conclusion
GSM 1900	Low	1850.2	Horizontal	27.85	33	Pass
	Mid	1880	Horizontal	27.71	33	Pass
	High	1909.8	Horizontal	28.24	33	Pass
GPRS 1900	Low	1850.2	Horizontal	26.74	33	Pass
	Mid	1880	Horizontal	26.69	33	Pass
	High	1909.8	Horizontal	27.15	33	Pass
EGPRS 1900	Low	1850.2	Horizontal	26.32	33	Pass
	Mid	1880	Horizontal	26.29	33	Pass
	High	1909.8	Horizontal	26.87	33	Pass
WCDMA Band II	Low	1852.4	Horizontal	22.28	33	Pass
	Mid	1880	Horizontal	22.23	33	Pass
	High	1907.6	Horizontal	21.82	33	Pass

5.3.Occupied Bandwidth

Ambient condition

Temperature	Relative humidity	Pressure
23°C ~25°C	45%~50%	101.5kPa

Method of Measurement

The EUT was connected to Spectrum Analyzer and Base Station Simulator via power Splitter. The occupied bandwidth is measured using spectrum analyzer.

RBW is set to 3kHz, VBW is set to 10kHz for GSM 1900,

RBW is set to 51kHz, VBW is set to 160kHz for WCDMA Band II.

99% power and -26dBc occupied bandwidths are recorded. Spectrum analyzer plots are included on the following pages.

Test Setup

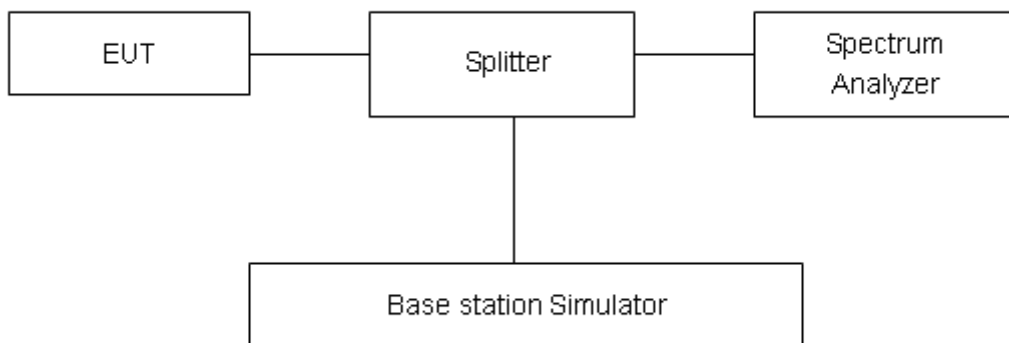

Limits

No specific occupied bandwidth requirements in part 2.1049.

Measurement Uncertainty

The assessed measurement uncertainty to ensure 95% confidence level for the normal distribution is with the coverage factor $k = 2$, $U = 624\text{Hz}$.

**Test Result**

Mode	Channel	Frequency (MHz)	99% Power Bandwidth (MHz)	-26dBc Bandwidth(MHz)
GSM 1900 (GSM)	512	1850.2	0.24676	0.3084
	661	1880.0	0.24547	0.3084
	810	1909.8	0.2457	0.3053
GPRS 1900 (GMSK)	512	1850.2	0.2455	0.3091
	661	1880.0	0.2466	0.3122
	810	1909.8	0.24562	0.3148
EGPRS 1900 (8-PSK)	512	1850.2	0.24916	0.3158
	661	1880.0	0.24927	0.3143
	810	1909.8	0.25223	0.3221
WCDMA Band II (RMC)	9262	1852.4	4.1485	4.675
	9400	1880	4.1378	4.673
	9538	1907.6	4.1463	4.698

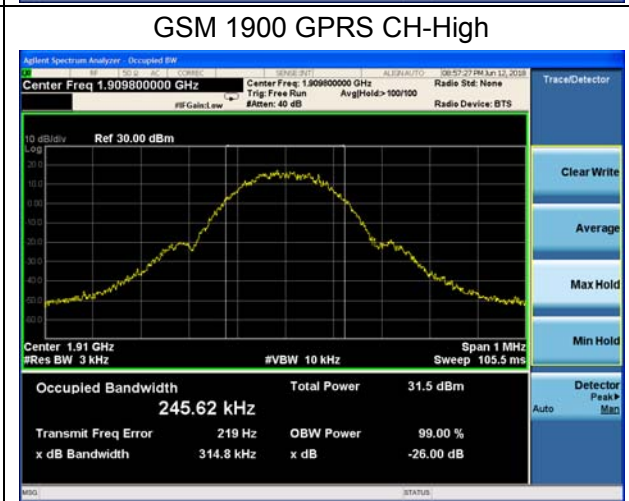
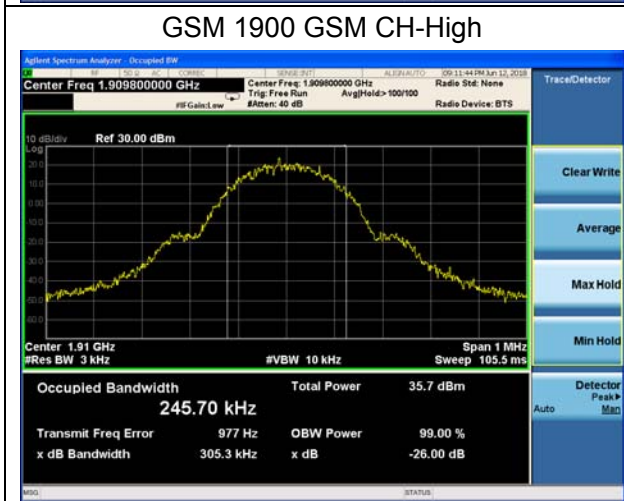
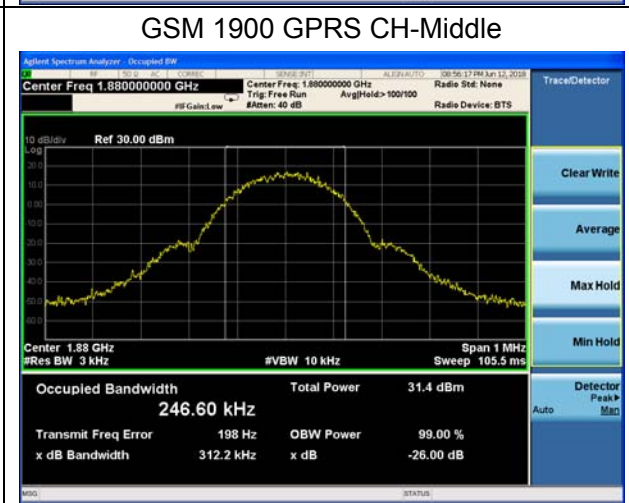
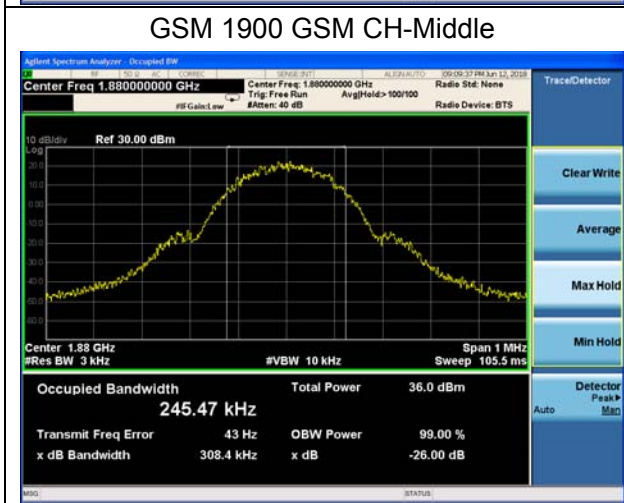
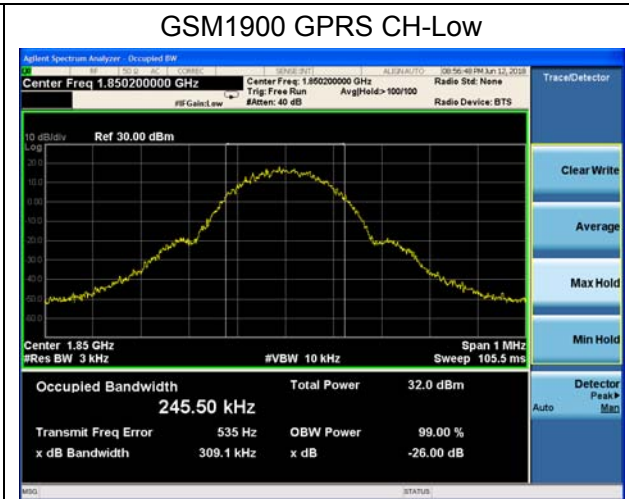

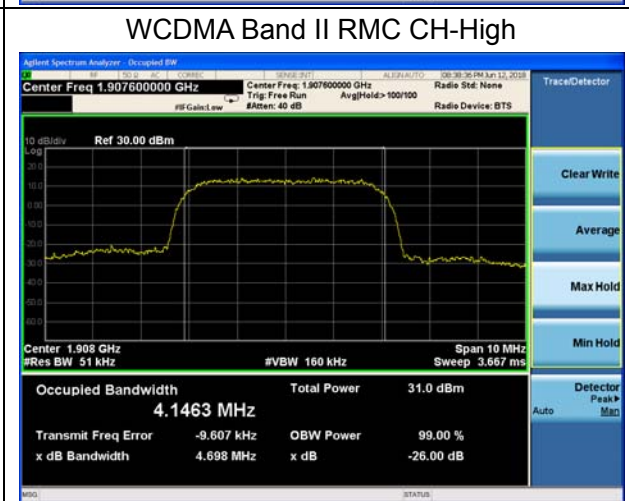
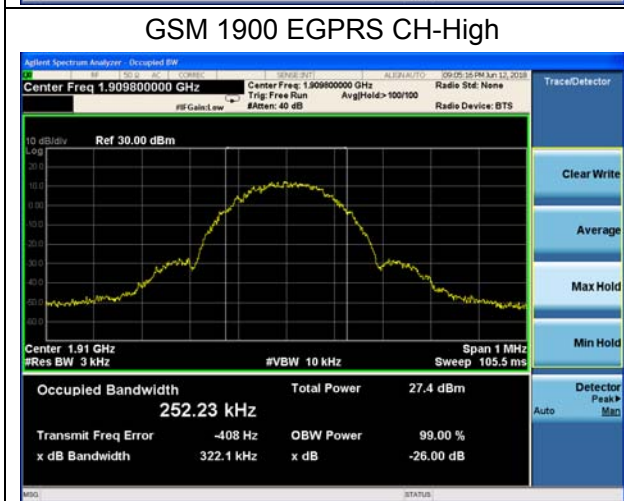
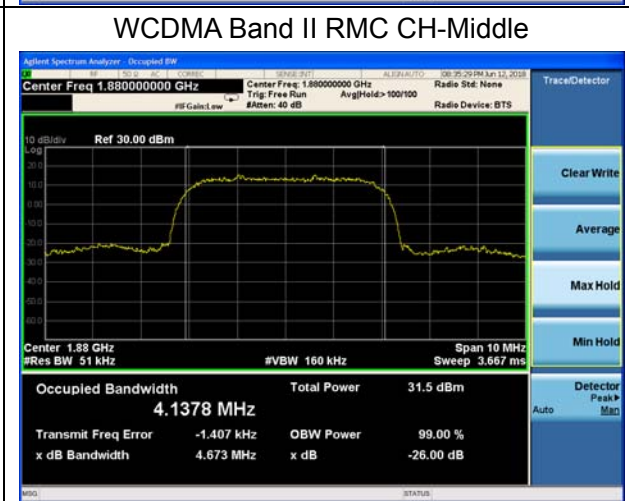
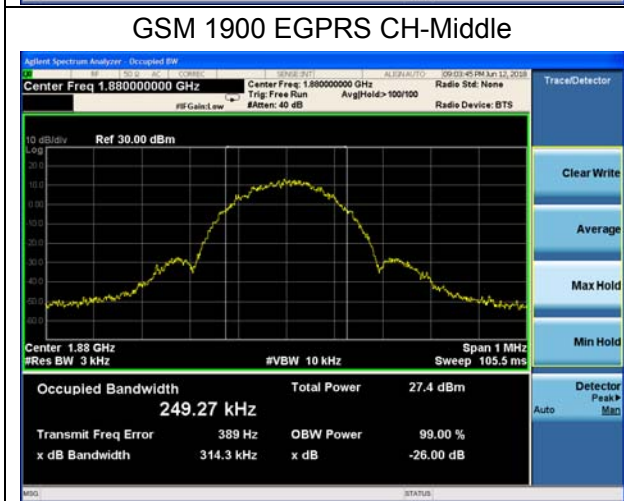
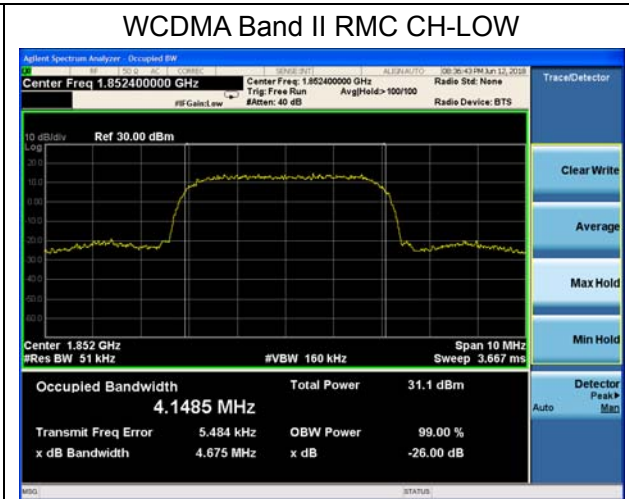
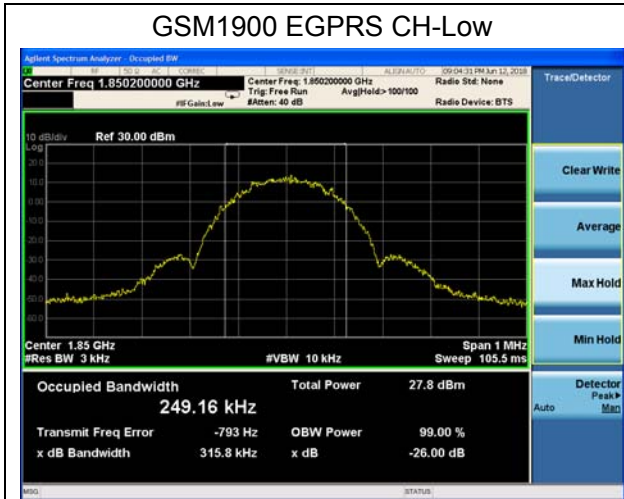

5.4. Band Edge Compliance

Ambient condition

Temperature	Relative humidity	Pressure
23°C ~25°C	45%~50%	101.5kPa

Method of Measurement

The EUT was connected to Spectrum Analyzer and Base Station Simulator via power Splitter. The band edge of the lowest and highest channels were measured. The Average detector is used and RBW is set to 3kHz, VBW is set to 10kHz for GSM 1900, RBW is set to 51kHz, VBW is set to 160kHz for WCDMA Band II. Spectrum analyzer plots are included on the following pages.

Test Setup

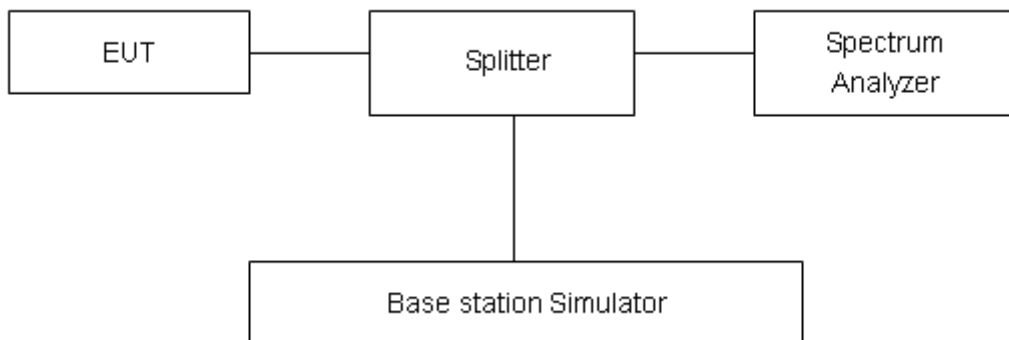

Limits

Rule Part 24.238(a) specifies that “on any frequency outside a licensee's frequency block, the power of any emission shall be attenuated below the transmitter power (P) by at least 43 + 10 log₁₀ (P) dB.”

Limit	-13 dBm
-------	---------

Measurement Uncertainty

The assessed measurement uncertainty to ensure 95% confidence level for the normal distribution is with the coverage factor $k = 1.96$, $U=0.684$ dB.



Test Result:

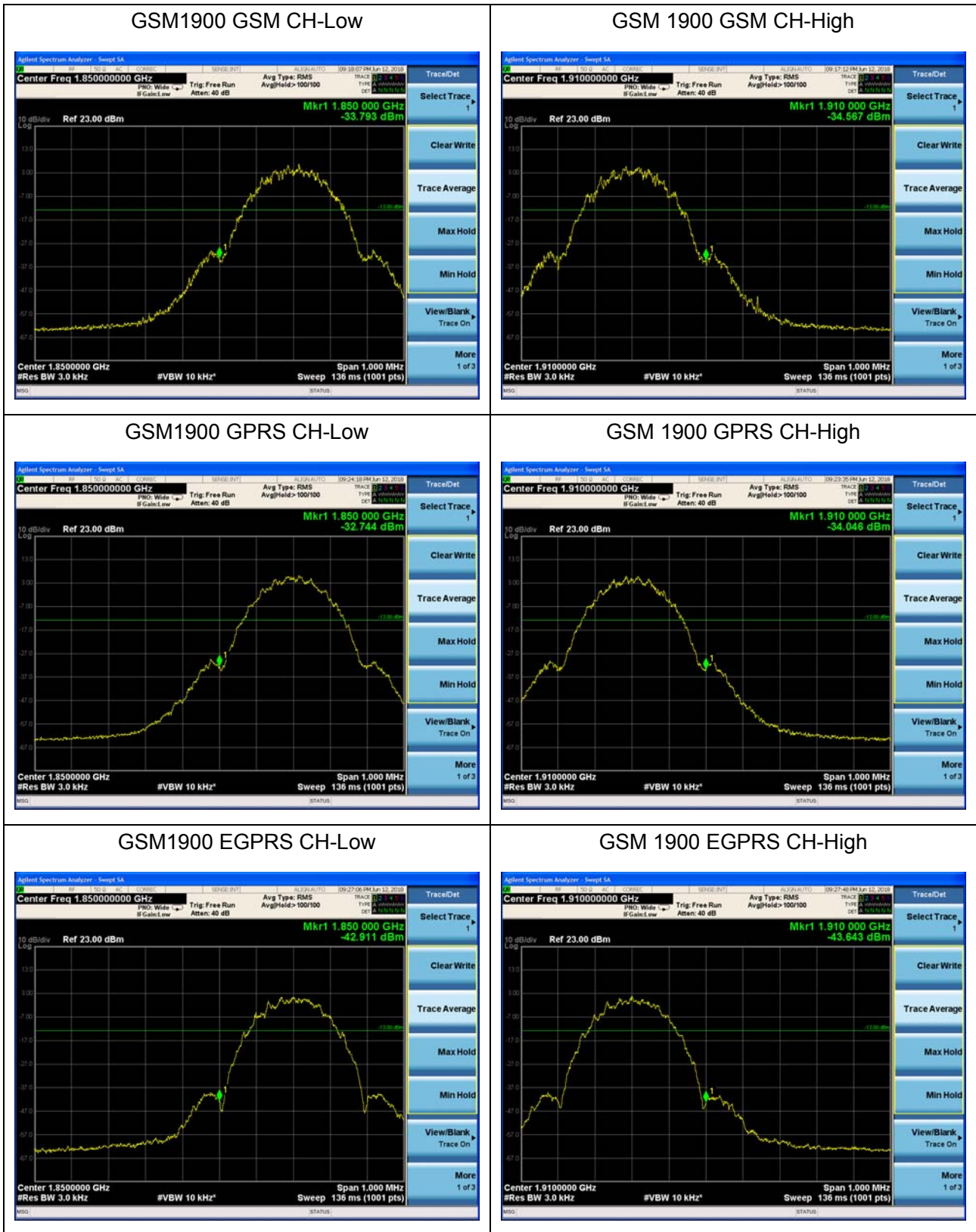



WCDMA Band II RMC CH-Low



WCDMA Band II RMC CH-High



5.5. Peak-to-Average Power Ratio (PAPR)

Ambient condition

Temperature	Relative humidity	Pressure
23°C ~25°C	45%~50%	101.5kPa

Methods of Measurement

Measure the total peak power and record as PPk. And measure the total average power and record as PAvg. Both the peak and average power levels must be expressed in the same logarithmic units (e.g., dBm). Determine the PAPR from:

$$PAPR (dB) = PPk (dBm) - PAvg (dBm).$$

Test Setup

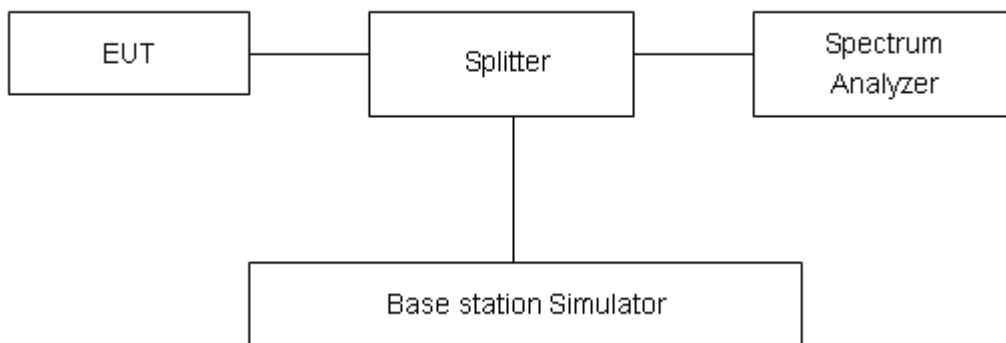

Limits

In measuring transmissions in this band using an average power technique, the peak-to-average ratio (PAR) of the transmission may not exceed 13 dB in 24.232(d).

Measurement Uncertainty

The assessed measurement uncertainty to ensure 95% confidence level for the normal distribution is with the coverage factor $k = 2$, $U = 0.4$ dB.

**Test Results**

Mode	Channel	Frequency (MHz)	Peak(dBm)	Avg(dBm)	PAPR(dB)	Limit(dB)	Conclusion
GSM 1900 (GSM)	512	1850.2	31.13	30.05	1.08	≤13	PASS
	661	1880	30.97	29.91	1.06	≤13	PASS
	810	1909.8	30.69	29.68	1.01	≤13	PASS
GPRS 1900 (GMSK)	512	1850.2	30.72	29.66	1.06	≤13	PASS
	661	1880	30.73	29.60	1.13	≤13	PASS
	810	1909.8	30.72	29.57	1.15	≤13	PASS
EGPRS 1900 (8-PSK)	512	1850.2	26.29	25.19	1.10	≤13	PASS
	661	1880	26.34	25.17	1.17	≤13	PASS
	810	1909.8	26.38	25.18	1.20	≤13	PASS
WCDMA Band II (RMC)	9262	1852.4	25.59	22.55	3.04	≤13	PASS
	9400	1880	25.50	22.48	3.02	≤13	PASS
	9538	1907.6	25.31	22.53	2.78	≤13	PASS

5.6. Frequency Stability

Ambient condition

Temperature	Relative humidity	Pressure
23°C ~25°C	45%~50%	101.5kPa

Method of Measurement

Frequency Stability (Temperature Variation)

The temperature inside the climate chamber is varied from -30°C to +50°C in 10°C step size,

(1) With all power removed, the temperature was decreased to 0°C and permitted to stabilize for three hours.

(2) Measure the carrier frequency with the test equipment in a “call mode”. These measurements should be made within 1 minute of powering up the mobile station, to prevent significant self warming.

(3) Repeat the above measurements at 10°C increments from -30°C to +50°C. Allow at least 1.5 hours at each temperature, un-powered, before making measurements.

Frequency Stability (Voltage Variation)

The frequency stability shall be measured with variation of primary supply voltage as follows:

(1) Vary primary supply voltage from 85 to 115 percent of the nominal value for other than hand carried battery equipment.

(2) For hand carried, battery powered equipment, reduce primary supply voltage to the battery-operating end point which shall be specified by the manufacturer.

This transceiver is specified to operate with an input voltage of between 3.6 V and 4.3 V, with a nominal voltage of 3.8V.

Test setup

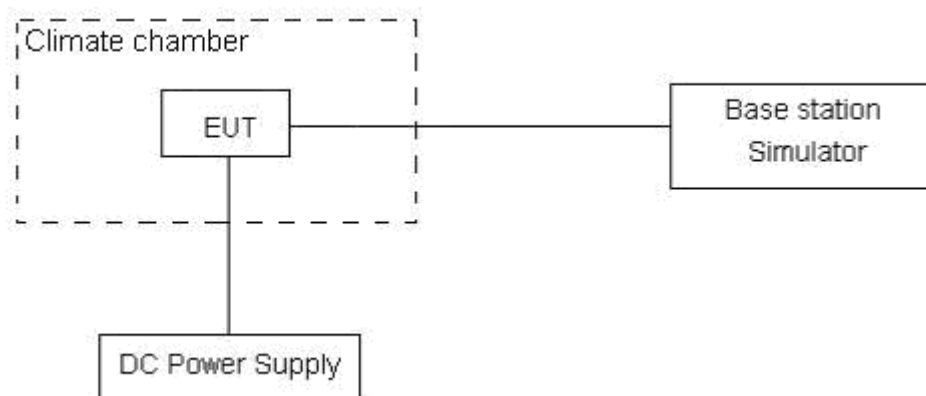

**Limits**

No specific frequency stability requirements in part 24.235

Measurement Uncertainty

The assessed measurement uncertainty to ensure 99.75% confidence level for the normal distribution is with the coverage factor $k = 3$, $U = 0.01\text{ppm}$.



Test Result

GSM 1900					
Condition		1850	1910	Delta (Hz)	Frequency Stability (ppm)
Temperature	Voltage	F low@-13dBm(MHz)	F high@-13dBm(MHz)		
Normal (25°C)	Normal	1850.0682	1909.9518	16.91	0.00899
Extreme (50°C)		1850.0667	1909.9505	24.59	0.01308
Extreme (40°C)		1850.0675	1909.9513	-36.81	-0.01958
Extreme (30°C)		1850.0663	1909.9498	27.57	0.01466
Extreme (20°C)		1850.0668	1909.9506	-30.37	-0.01615
Extreme (10C)		1850.0686	1909.9524	23.87	0.01270
Extreme (0°C)		1850.0673	1909.9511	-39.55	-0.02104
Extreme (-10°C)		1850.0675	1909.9513	19.55	0.01040
Extreme (-20°C)		1850.0674	1909.9508	-16.60	-0.00883
Extreme (-30°C)		1850.0685	1909.9523	26.33	0.01400
25°C		LV	1850.0664	1909.9502	15.72
	HV	1850.0666	1909.9504	-21.23	-0.01129
GPRS 1900					
Condition		1850	1910	Delta (Hz)	Frequency Stability (ppm)
Temperature	Voltage	F low@-13dBm(MHz)	F high@-13dBm(MHz)		
Normal (25°C)	Normal	1850.0558	1909.9394	24.87	0.01323
Extreme (50°C)		1850.0571	1909.9403	-22.64	-0.01204
Extreme (40°C)		1850.0563	1909.9395	-17.07	-0.00908
Extreme (30°C)		1850.0578	1909.9413	2.15	0.00114
Extreme (20°C)		1850.0572	1909.9402	-22.74	-0.01210
Extreme (10C)		1850.0552	1909.9384	-21.67	-0.01153
Extreme (0°C)		1850.0565	1909.9397	-9.96	-0.00530
Extreme (-10°C)		1850.0563	1909.9395	-26.50	-0.01410
Extreme (-20°C)		1850.0568	1909.9421	-4.97	-0.00264
Extreme (-30°C)		1850.0553	1909.9385	9.87	0.00525
25°C		LV	1850.0574	1909.9406	-24.30
	HV	1850.0572	1909.9404	30.48	0.01621
EGPRS 1900					
Condition		1850	1910	Delta (Hz)	Frequency Stability (ppm)
Temperature	Voltage	F low@-13dBm(MHz)	F high@-13dBm(MHz)		
Normal (25°C)	Normal	1850.0606	1909.9252	31.05	0.01652
Extreme (50°C)		1850.0619	1909.9265	29.40	0.01564
Extreme (40°C)		1850.0611	1909.9257	-35.40	-0.01883



Extreme (30°C)		1850.0626	1909.9272	30.08	0.01600
Extreme (20°C)		1850.0618	1909.9264	-39.73	-0.02113
Extreme (10C)		1850.0623	1909.9246	0.15	0.00008
Extreme (0°C)		1850.0613	1909.9259	-23.77	-0.01264
Extreme (-10°C)		1850.0611	1909.9257	1.85	0.00098
Extreme (-20°C)		1850.0616	1909.9262	-29.40	-0.01564
Extreme (-30°C)		1850.0601	1909.9247	24.13	0.01284
25°C	LV	1850.0622	1909.9268	-30.67	-0.01631
	HV	1850.0621	1909.9266	-12.57	-0.00668

WCDMA Band II					
Condition		1850	1910	Delta(Hz)	Frequency Stability(ppm)
Temperature	Voltage	F low@-13dBm(MHz)	F high@-13dBm(MHz)		
Normal (25°C)	Normal	1850.0282	1909.9567	12.63	0.00672
Extreme (50°C)		1850.0267	1909.9514	1.69	0.00090
Extreme (40°C)		1850.0275	1909.9506	-3.30	-0.00176
Extreme (30°C)		1850.0265	1909.9521	4.70	0.00250
Extreme (20°C)		1850.0268	1909.9513	-5.51	-0.00293
Extreme (10C)		1850.0286	1909.9495	1.96	0.00104
Extreme (0°C)		1850.0273	1909.9508	-3.63	-0.00193
Extreme (-10°C)		1850.0275	1909.9506	12.07	0.00642
Extreme (-20°C)		1850.0273	1909.9511	1.57	0.00084
Extreme (-30°C)		1850.0285	1909.9496	20.95	0.01114
25°C		LV	1850.0264	1909.9517	15.76
	HV	1850.0266	1909.9515	14.00	0.00745

5.7. Spurious Emissions at Antenna Terminals

Ambient condition

Temperature	Relative humidity	Pressure
23°C ~25°C	45%~50%	101.5kPa

Method of Measurement

The EUT was connected to Spectrum Analyzer and Base Station Simulator via power Splitter. The measurement is carried out using a spectrum analyzer. The spectrum analyzer scans from 9kHz to the 10th harmonic of the carrier. The peak detector is used.

RBW is set to 100kHz, VBW is set to 300kHz for 30MHz~1GHz

RBW is set to 1MHz, VBW is set to 3MHz for above 1GHz, Sweep is set to ATUO.

The modulation mode and RB allocation refer to section 5.1, using the maximum output power configuration.

Test setup

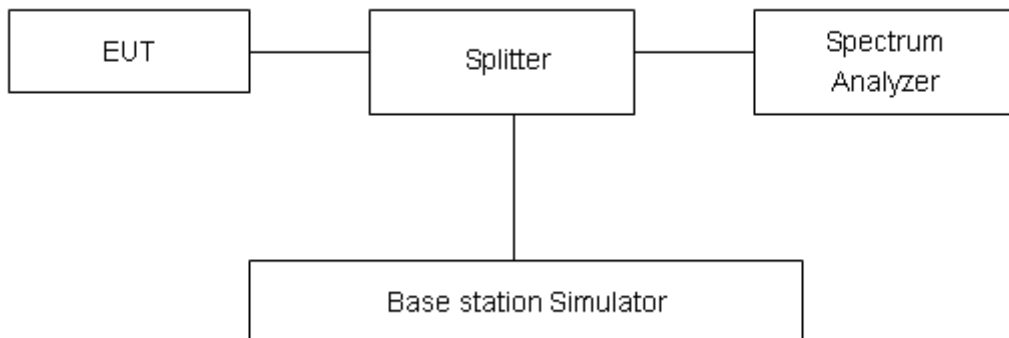

Limits

Rule Part 24.238(a) specifies that “on any frequency outside a licensee's frequency block, the power of any emission shall be attenuated below the transmitter power (P) by at least 43 + 10 log₁₀ (P) dB.”

Limit	-13 dBm
-------	---------

Measurement Uncertainty

The assessed measurement uncertainty to ensure 99.75% confidence level for the normal distribution is with the coverage factor $k = 1.96$.

Frequency	Uncertainty
9kHz-1GHz	0.684 dB
1GHz-20GHz	1.407 dB

Test Result

Sweep the whole frequency band through the range from 9kHz to the 10th harmonic of the carrier, the emissions more than 20 dB below the permissible value are not reported.

The signal beyond the limit is carrier.

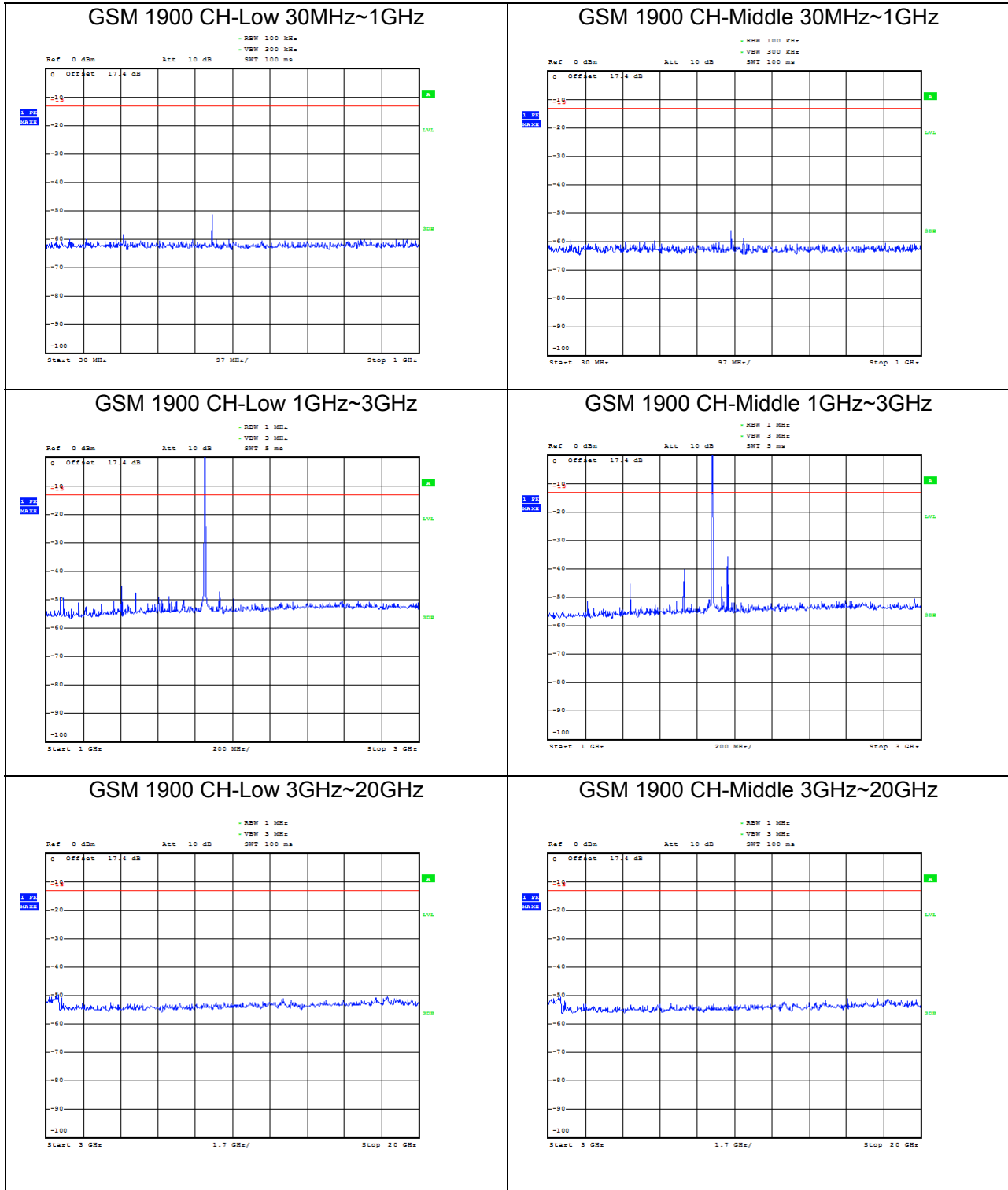



GSM 1900 CH-High 30MHz~1GHz

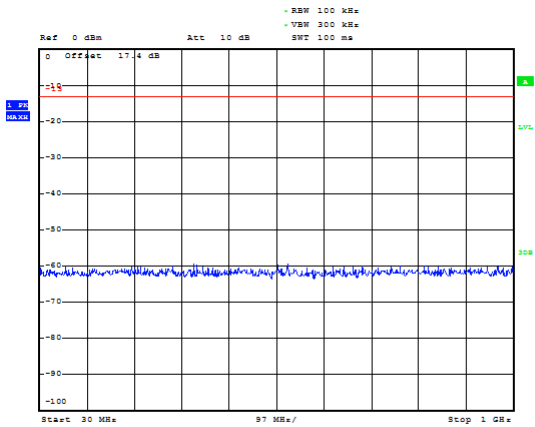

WCDMA Band II CH-Low 30MHz~1GHz

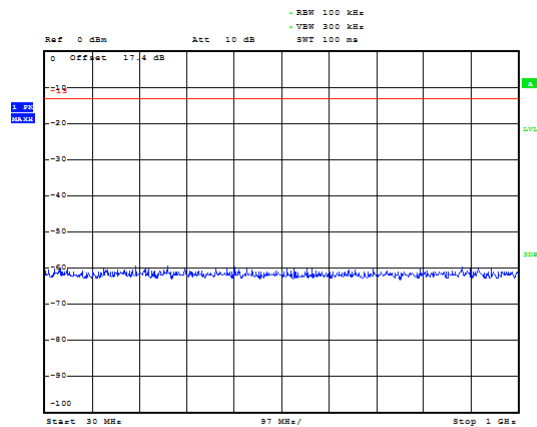

GSM 1900 CH-High 1GHz~3GHz

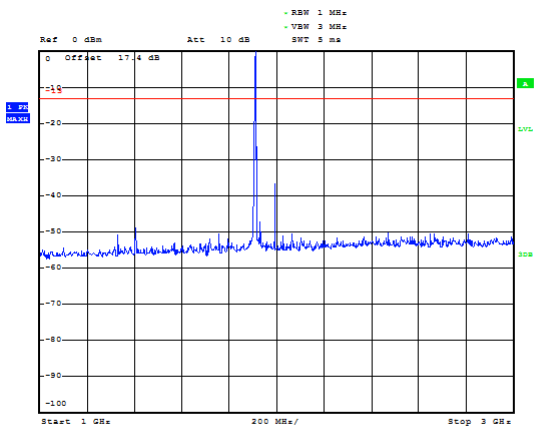

WCDMA BAND II CH-Low 1GHz~3GHz

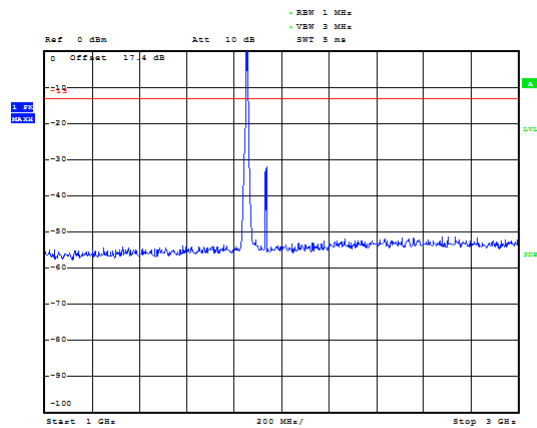

GSM 1900 CH-High 3GHz~20GHz

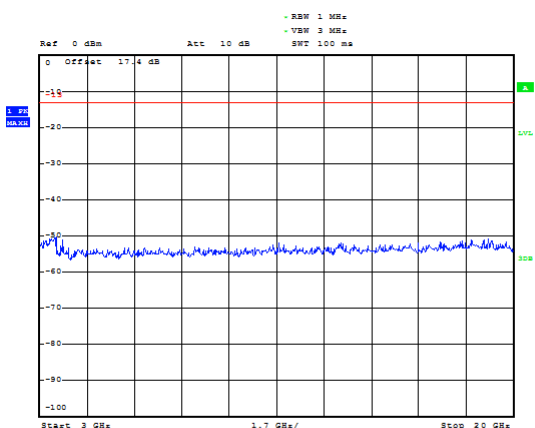

WCDMA BAND II CH-Low 3GHz~20GHz

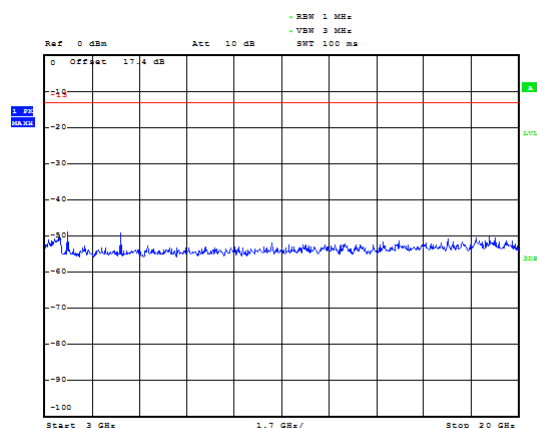



WCDMA Band II CH- Middle 30MHz~1GHz

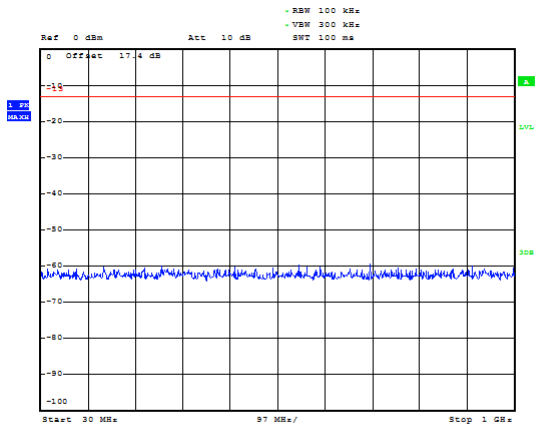

WCDMA Band II CH- High 30MHz~1GHz

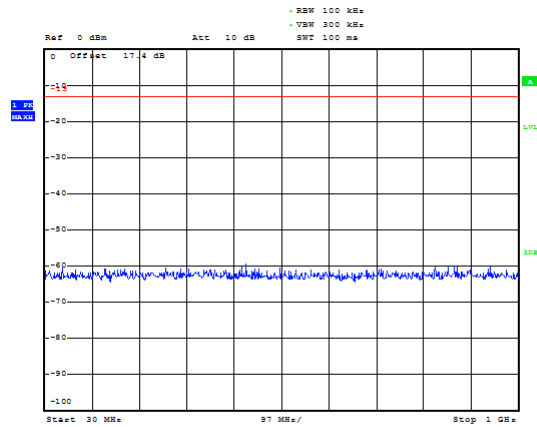

WCDMA BAND II CH-Middle 1GHz~3GHz

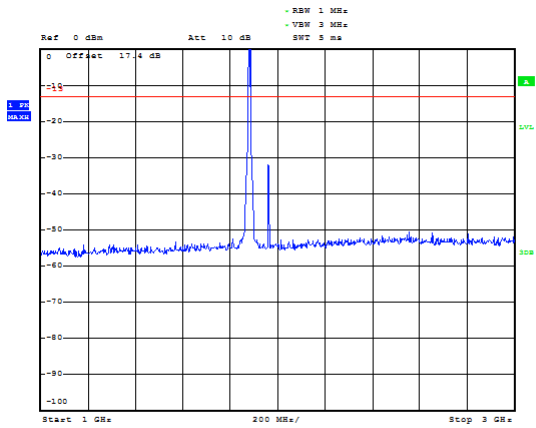

WCDMA BAND II CH-High 1GHz~3GHz

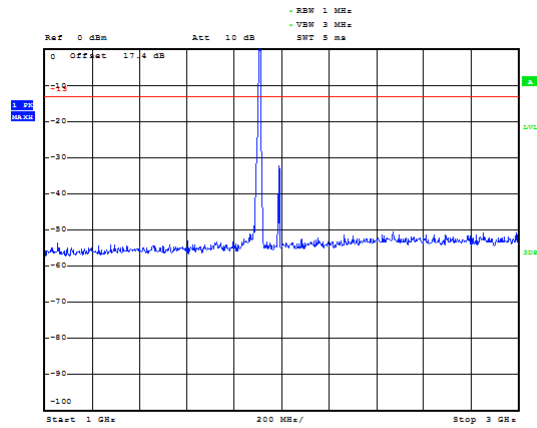

WCDMA BAND II CH-Middle 3GHz~20GHz

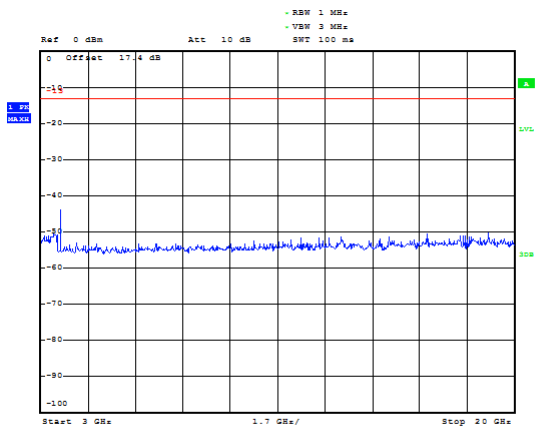

WCDMA BAND II CH-High 3GHz~20GHz

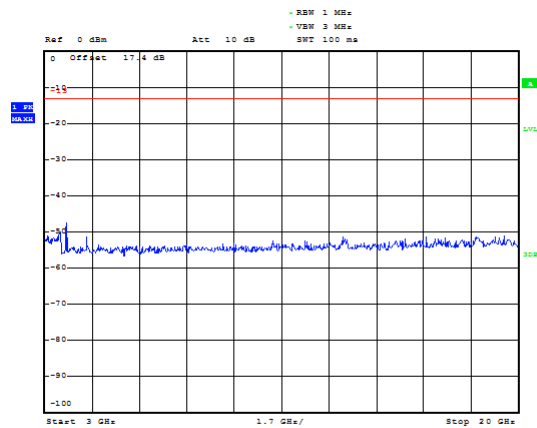

5.8. Radiates Spurious Emission

Ambient condition

Temperature	Relative humidity	Pressure
23°C ~25°C	45%~50%	101.5kPa

Method of Measurement

1. The testing follows FCC KDB 971168 v03r01 Section 5.8 and ANSI/TIA-603-E (2016).
2. The EUT is placed on a turntable 0.8 meters above the ground in the chamber, 3 meter away from the antenna. The maximal emission value is acquired by adjusting the antenna height, polarisation and turntable azimuth. Normally, the height range of antenna is 1 m to 4 m, the azimuth range of turntable is 0° to 360°, and the receive antenna has two polarizations Vertical (V) and Horizontal (H).
3. A log-periodic antenna or double-ridged waveguide horn antenna shall be substituted in place of the EUT. The log-periodic antenna will be driven by a signal generator and the level will be adjusted till the same power value on the spectrum analyzer or receiver. The level of the spurious emissions can be calculated through the level of the signal generator, cable loss, the gain of the substitution antenna and the reading of the spectrum analyzer or receiver.
4. The EUT is then put into continuously transmitting mode at its maximum power level during the test. Set Test Receiver or Spectrum RBW=1MHz, VBW=3MHz, And the maximum value of the receiver should be recorded as (Pr).
5. The EUT shall be replaced by a substitution antenna. In the chamber, an substitution antenna for the frequency band of interest is placed at the reference point of the chamber. An RF Signal source for the frequency band of interest is connected to the substitution antenna with a cable that has been constructed to not interfere with the radiation pattern of the antenna. A power (PMea) is applied to the input of the substitution antenna, and adjust the level of the signal generator output until the value of the receiver reach the previously recorded (Pr). The power of signal source (PMea) is recorded. The test should be performed by rotating the test item and adjusting the receiving antenna polarization.
6. A amplifier should be connected to the Signal Source output port. And the cable should be connect between the Amplifier and the Substitution Antenna. The cable loss (Pcl), the Substitution Antenna Gain (Ga) and the Amplifier Gain (PAg) should be recorded after test.
7. The measurement results are obtained as described below:
$$\text{Power(EIRP)} = \text{PMea} - \text{PAg} - \text{Pcl} + \text{Ga}$$

The measurement results are amend as described below:
$$\text{Power(EIRP)} = \text{PMea} - \text{Pcl} + \text{Ga}$$
8. This value is EIRP since the measurement is calibrated using an antenna of known gain (2.15 dBi) and known input power. ERP can be calculated from EIRP by subtracting the gain of the dipole, $\text{ERP} = \text{EIRP} - 2.15\text{dBi}$.

The modulation mode and RB allocation refer to section 5.1, using the maximum output power configuration.

Test setup

30MHz~~~ 1GHz

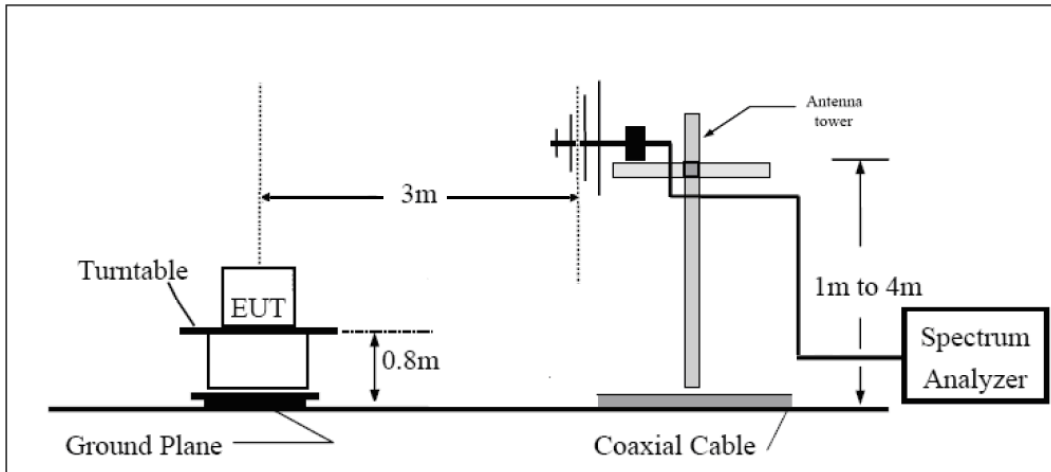

Above 1GHz

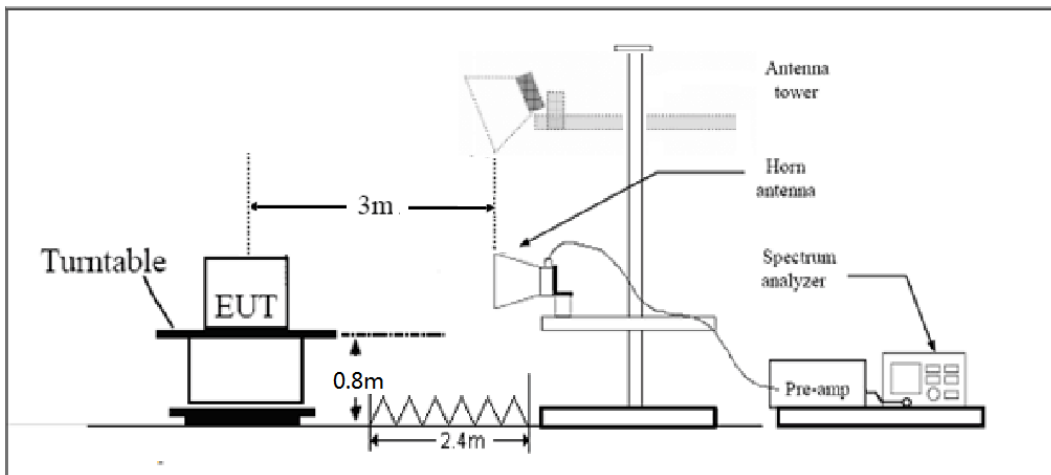

Note: Area side: 2.4mX3.6m

The radiated emission was measured in the following position: EUT stand-up position (Z axis), lie-down position (X, Y axis). The worst emission was found in lie-down position (X axis) and the worst case was recorded.

Limits

Rule Part 24.238(a) specifies that “on any frequency outside a licensee's frequency block, the power of any emission shall be attenuated below the transmitter power (P) by at least 43 + 10 log10 (P) dB.”

Limit	-13 dBm
-------	---------

Measurement Uncertainty

The assessed measurement uncertainty to ensure 95% confidence level for the normal distribution is with the coverage factor $k = 1.96$, $U = 3.55$ dB.

Test Result

Sweep the whole frequency band through the range from 30MHz to the 10th harmonic of the carrier, from 30MHz to 1GHz and above 18 GHz are all base noise will not recorded in the report.

GSM 1900 CH-Middle

Harmonic	Frequency (MHz)	SG (dBm)	Cable Loss (dB)	Gain (dBi)	Antenna Polarization	EIRP Level (dBm)	Limit (dBm)	Margin (dB)	Azimuth (deg)
2	3759.9	-56.95	5.1	11.05	Horizontal	-51.0	-13.00	38.0	45
3	5640.2	-50.73	5.42	12.65	Horizontal	-43.5	-13.00	30.5	90
4	7519.5	-52.15	6.7	13.85	Horizontal	-45.0	-13.00	32.0	225
5	9402.8	-49.84	7.01	14.75	Horizontal	-42.1	-13.00	29.1	45
6	11279.3	-46.37	7.48	15.95	Horizontal	-37.9	-13.00	24.9	180
7	13159.1	-46.14	7.51	16.55	Horizontal	-37.1	-13.00	24.1	135
8	15041.3	-45.01	8.24	15.35	Horizontal	-37.9	-13.00	24.9	270
9	16922.3	-43.64	8.41	14.95	Horizontal	-37.1	-13.00	24.1	90
10	18800.0	/	/	/	/	/	/	/	/

Note: 1.The other Spurious RF Radiated emissions level is no more than noise floor.
 2. The worst emission was found in the antenna is Horizontal position.

WCDMA Band II CH-Middle

Harmonic	Frequency (MHz)	SG (dBm)	Cable Loss (dB)	Gain (dBi)	Antenna Polarization	EIRP Level (dBm)	Limit (dBm)	Margin (dB)	Azimuth (deg)
2	3760.0	-56.95	5.1	11.05	Horizontal	-51.0	-13.00	38.0	225
3	5640.0	-55.23	5.42	12.65	Horizontal	-48.0	-13.00	35.0	45
4	7520.0	-50.45	6.7	13.85	Horizontal	-43.3	-13.00	30.3	90
5	9400.0	-51.64	7.01	14.75	Horizontal	-43.9	-13.00	30.9	180
6	11280.0	-45.77	7.48	15.95	Horizontal	-37.3	-13.00	24.3	180
7	13160.0	-46.24	7.51	16.55	Horizontal	-37.2	-13.00	24.2	270
8	15040.0	-44.21	8.24	15.35	Horizontal	-37.1	-13.00	24.1	135
9	16920.0	-40.74	8.41	14.95	Horizontal	-34.2	-13.00	21.2	180
10	18800.0	/	/	/	/	/	/	/	/

Note: 1.The other Spurious RF Radiated emissions level is no more than noise floor.
 2. The worst emission was found in the antenna is Horizontal position.



6. Main Test Instruments

Name	Manufacturer	Type	Serial Number	Calibration Date	Expiration Date
Base Station Simulator	R&S	CMU200	118133	2018-05-13	2019-05-12
Power Splitter	Hua Xiang	SHX-GF2-2-13	10120101	NA	NA
Spectrum Analyzer	Agilent	N9010A	MY47191109	2018-05-20	2019-05-19
Universal Radio Communication Tester	Agilent	E5515C	MY48367192	2018-05-20	2019-05-19
Signal Analyzer	R&S	FSV30	100815	2017-12-17	2018-12-16
EMI Test Receiver	R&S	ESCI	100948	2018-05-20	2019-05-19
Signal generator	R&S	SMB 100A	102594	2018-05-13	2019-05-12
Loop Antenna	SCHWARZBECK	FMZB1519	1519-047	2014-12-06	2019-12-05
Trilog Antenna	SCHWARZBECK	VUBL 9163	9163-201	2017-11-18	2020-11-17
Horn Antenna	R&S	HF907	100126	2014-12-06	2019-12-05
Climatic Chamber	Re Ce	PT-30B	20101891	2015-07-18	2018-07-17
Horn Antenna	ETS-Lindgren	3160-09	00102644	2015-01-30	2020-01-29
RF Cable	Agilent	SMA 15cm	0001	2018-02-03	2018-08-02
Preamplifier	R&S	SCU18	102327	2018-05-20	2019-05-19
Software	R&S	EMC32	V 8.52.0	NA	NA
MOB COMMS DC SUPPLY	Keysight	66319D	MY43004105	2018-05-07	2019-05-06

*****END OF REPORT *****