

FCC Radio Test Report

FCC ID: QISAGS2-L03

This report concerns (check one): Original Grant Class I Change Class II Change

Project No. : 1808C216
Equipment : HUAWEI MediaPad T5
Test Model : AGS2-L03
Series Model : N/A
Applicant : Huawei Technologies Co., Ltd.
Address : Administration Building, Headquarters of Huawei Technologies Co., Ltd., Bantian, Longgang District, Shenzhen, 518129, P.R.C

Date of Receipt : Aug. 24, 2018
Date of Test : Aug. 27, 2018 ~ Sep. 07, 2018
Issued Date : Sep. 12, 2018
Tested by : BTL Inc.

Testing Engineer : Paul Li
(Paul Li)

Technical Manager : David Mao
(David Mao)

Authorized Signatory : Steven Lu
(Steven Lu)

B T L I N C .

No.3, Jinshagang 1st Road, Shixia, Dalang Town, Dongguan, Guangdong, China.

TEL: +86-769-8318-3000 FAX: +86-769-8319-6000



Declaration

BTL represents to the client that testing is done in accordance with standard procedures as applicable and that test instruments used has been calibrated with standards traceable to international standard(s) and/or national standard(s).

BTL's reports apply only to the specific samples tested under conditions. It is manufacture's responsibility to ensure that additional production units of this model are manufactured with the identical electrical and mechanical components. **BTL** shall have no liability for any declarations, inferences or generalizations drawn by the client or others from **BTL** issued reports.

The report must not be used by the client to claim product certification, approval, or endorsement by NVLAP, NIST, or any agency of the U.S. Government.

This report is the confidential property of the client. As a mutual protection to the clients, the public and ourselves, the test report shall not be reproduced, except in full, without our written approval.

BTL's laboratory quality assurance procedures are in compliance with the **ISO Guide 17025** requirements, and accredited by the conformity assessment authorities listed in this test report.

BTL is not responsible for the sampling stage, so the results only apply to the sample as received.

The information, data and test plan are provided by manufacturer, so it is manufacturer's responsibility to ensure that the apparatus meets the essential requirements in all the possible configurations as representative of its intended use.

Limitation

For the use of the authority's logo is limited unless the Test Standard(s)/Scope(s)/Item(s) mentioned in this test report is (are) included in the conformity assessment authorities acceptance respective.

Table of Contents	Page
1 . CERTIFICATION	7
2 . SUMMARY OF TEST RESULTS	8
2.1 TEST FACILITY	9
2.2 MEASUREMENT UNCERTAINTY	9
3 . GENERAL INFORMATION	10
3.1 GENERAL DESCRIPTION OF EUT	10
3.2 DESCRIPTION OF TEST MODES	13
3.3 TABLE OF PARAMETERS OF TEXT SOFTWARE SETTING	13
3.4 BLOCK DIAGRAM SHOWING THE CONFIGURATION OF SYSTEM TESTED	14
3.5 DESCRIPTION OF SUPPORT UNITS	14
4 . EMC EMISSION TEST	15
4.1 CONDUCTED EMISSION MEASUREMENT	15
4.1.1 POWER LINE CONDUCTED EMISSION LIMITS	15
4.1.2 TEST PROCEDURE	15
4.1.3 DEVIATION FROM TEST STANDARD	15
4.1.4 TEST SETUP	16
4.1.5 EUT OPERATING CONDITIONS	16
4.1.6 EUT TEST CONDITIONS	16
4.1.7 TEST RESULTS	16
4.2 RADIATED EMISSION MEASUREMENT	17
4.2.1 RADIATED EMISSION LIMITS	17
4.2.2 TEST PROCEDURE	18
4.2.3 DEVIATION FROM TEST STANDARD	18
4.2.4 TEST SETUP	19
4.2.5 EUT OPERATING CONDITIONS	21
4.2.6 EUT TEST CONDITIONS	21
4.2.7 TEST RESULTS (9 KHZ TO 30 MHZ)	21
4.2.8 TEST RESULTS (30 MHZ TO 1000 MHZ)	21
4.2.9 TEST RESULTS (ABOVE 1000 MHZ)	21
5 . NUMBER OF HOPPING CHANNEL	22
5.1 APPLIED PROCEDURES	22
5.1.1 TEST PROCEDURE	22
5.1.2 DEVIATION FROM STANDARD	22
5.1.3 TEST SETUP	22
5.1.4 EUT OPERATION CONDITIONS	22
5.1.5 EUT TEST CONDITIONS	22
5.1.6 TEST RESULTS	22
6 . AVERAGE TIME OF OCCUPANCY	23

Table of Contents	Page
6.1 APPLIED PROCEDURES / LIMIT	23
6.1.1 TEST PROCEDURE	23
6.1.2 DEVIATION FROM STANDARD	23
6.1.3 TEST SETUP	23
6.1.4 EUT OPERATION CONDITIONS	24
6.1.5 EUT TEST CONDITIONS	24
6.1.6 TEST RESULTS	24
7 . HOPPING CHANNEL SEPARATION MEASUREMENT	25
7.1 APPLIED PROCEDURES / LIMIT	25
7.1.1 TEST PROCEDURE	25
7.1.2 DEVIATION FROM STANDARD	25
7.1.3 TEST SETUP	25
7.1.4 EUT TEST CONDITIONS	25
7.1.5 TEST RESULTS	25
8 . BANDWIDTH TEST	26
8.1 APPLIED PROCEDURES	26
8.1.1 TEST PROCEDURE	26
8.1.2 DEVIATION FROM STANDARD	26
8.1.3 TEST SETUP	26
8.1.4 EUT OPERATION CONDITIONS	26
8.1.5 EUT TEST CONDITIONS	26
8.1.6 TEST RESULTS	26
9 . MAXIMUM OUTPUT POWER	27
9.1 APPLIED PROCEDURES / LIMIT	27
9.1.1 TEST PROCEDURE	27
9.1.2 DEVIATION FROM STANDARD	27
9.1.3 TEST SETUP	27
9.1.4 EUT OPERATION CONDITIONS	27
9.1.5 EUT TEST CONDITIONS	27
9.1.6 TEST RESULTS	27
10 . ANTENNA CONDUCTED SPURIOUS EMISSION	28
10.1 APPLIED PROCEDURES / LIMIT	28
10.1.1 TEST PROCEDURE	28
10.1.2 DEVIATION FROM STANDARD	28
10.1.3 TEST SETUP	28
10.1.4 EUT OPERATION CONDITIONS	28
10.1.5 EUT TEST CONDITIONS	28
10.1.6 TEST RESULTS	28
11 . MEASUREMENT INSTRUMENTS LIST	29
APPENDIX A - CONDUCTED EMISSION	32

Table of Contents**Page**

APPENDIX B - RADIATED EMISSION (9 KHZ-30 MHZ)	39
APPENDIX C - RADIATED EMISSION (30 MHZ TO 1000 MHZ)	52
APPENDIX D - RADIATED EMISSION (ABOVE 1000 MHZ)	59
APPENDIX E - NUMBER OF HOPPING CHANNEL	80
APPENDIX F - AVERAGE TIME OF OCCUPANCY	82
APPENDIX G - HOPPING CHANNEL SEPARATION MEASUREMENT	95
APPENDIX H - BANDWIDTH	100
APPENDIX I - MAXIMUM OUTPUT POWER	105
APPENDIX J - ANTENNA CONDUCTED SPURIOUS EMISSION	110

REPORT ISSUED HISTORY

Issued No.	Description	Issued Date
BTL-FCCP-1-1808C216	Original Issue.	Sep. 12, 2018

1. CERTIFICATION

Equipment : HUAWEI MediaPad T5
Brand Name : HUAWEI
Test Model : AGS2-L03
Series Model : N/A
Applicant : Huawei Technologies Co., Ltd.
Manufacturer : Huawei Technologies Co., Ltd.
Address : Administration Building, Headquarters of Huawei Technologies Co., Ltd.,
Bantian, Longgang District, Shenzhen, 518129, P.R.C
Factory : Huawei Technologies Co., Ltd.
Address : Building, Headquarters of Huawei Technologies Co., Ltd., Bantian, Longgang
District, Shenzhen, 518129, P.R.C
Date of Test : Aug. 27, 2018 ~ Sep. 07, 2018
Test Sample : Engineering Sample No.: D180807232 for conducted, D180807229 for
radiated.
Standard(s) : FCC Part15, Subpart C (15.247)/ ANSI C63.10-2013

The above equipment has been tested and found compliance with the requirement of the relative standards by BTL Inc.

The test data, data evaluation, and equipment configuration contained in our test report (Ref No. BTL-FCCP-1-1808C216) were obtained utilizing the test procedures, test instruments, test sites that has been accredited by the Authority of NVLAP according to the ISO-17025 quality assessment standard and technical standard(s).

Test results included in this report is only for the Bluetooth part.

2. SUMMARY OF TEST RESULTS

Test procedures according to the technical standard(s):

FCC Part15, Subpart C (15.247)			
Standard(s) Section	Test Item	Judgment	Remark
15.207	Conducted Emission	PASS	
15.247(d)	Antenna conducted Spurious Emission	PASS	
15.247(a)(1)	Hopping Channel Separation	PASS	
15.247(a)(1)	Bandwidth	PASS	
15.247(a)(1)	Maximum output power	PASS	
15.247(d) 15.209 15.205	Radiated Spurious Emission	PASS	
15.247(a)(1)(iii)	Number of Hopping Frequency	PASS	
15.247(a)(1)(iii)	Average Time Of Occupancy	PASS	
15.203	Antenna Requirement	PASS	

Note:

(1) "N/A" denotes test is not applicable in this test report

2.1 TEST FACILITY

The test facilities used to collect the test data in this report is at the location of No.3, Jinshagang 1st Road, Shixia, Dalang Town, Dongguan, Guangdong, China
 BTL's test firm number for FCC: 854385
 BTL's designation number for FCC: CN5020

2.2 MEASUREMENT UNCERTAINTY

The measurement uncertainty figures shall be calculated according the methods described in the ETSI TR 100 028 and shall correspond to an expansion factor (coverage factor) $k=1.96$ or $k=2$ (which provide confidence levels of respectively 90% and 95.45% in the case where the distributions characterizing the actual measurement uncertainties are normal (Gaussian)).
 Measurement Uncertainty for a Level of Confidence of 95 %, $U=2xUc(y)$.

The BTL measurement uncertainty as below table:

A. Conducted Measurement :

Test Site	Method	Measurement Frequency Range	U, (dB)
DG-C02	CISPR	150 kHz ~ 30 MHz	2.32

B. Radiated Measurement :

Test Site	Method	Measurement Frequency Range	Ant. H / V	U, (dB)
DG-CB03	CISPR	9 kHz ~ 30 MHz	V	3.79
		9 kHz ~ 30 MHz	H	3.57
		30 MHz ~ 200 MHz	V	3.82
		30 MHz ~ 200 MHz	H	3.78
		200 MHz ~ 1,000 MHz	V	4.10
		200 MHz ~ 1,000 MHz	H	4.06
		1 GHz ~ 18 GHz	V	3.12
		1 GHz ~ 18 GHz	H	3.68
		18 GHz ~ 40 GHz	V	4.15
18 GHz ~ 40 GHz	H	4.14		

C. Other Measurement:

Test Item	Uncertainty
Conducted Spurious Emission	2.67 dB
Hopping Channel Separation	53.46 MHz
Output Power	0.95 dB
Number of Hopping Frequency	53.46 MHz
Temperature	0.08 °C
Humidity	1.5%

Note: Unless specifically mentioned, the uncertainty of measurement has not been taken into account to declare the compliance or non-compliance to the specification.

3. GENERAL INFORMATION

3.1 GENERAL DESCRIPTION OF EUT

Equipment	HUAWEI MediaPad T5	
Brand Name	HUAWEI	
Test Model	AGS2-L03	
Series Model	N/A	
Model Difference(s)	N/A	
Software Version	A6t6e	
Hardware Version	AGS2-L03 8.0.0.20(C605)	
Output Power (Max.)	Operation Frequency	2402 MHz ~2480 MHz
	Modulation Technology	GFSK(1Mbps) π /4-DQPSK(2Mbps)
	Bit Rate of Transmitter	8-DPSK(3Mbps)
	Output Power Max.	8.80 dBm (1Mbps) 9.40 dBm (3Mbps)
Power Source	1# DC voltage supplied from AC/DC adapter. Model: HW-050100U01 2# Supplied from battery. Model: HB2899C0ECW-C	
Power Rating	1# I/P: 100-240V~,50/60Hz,0.2A O/P: DC 5V, 1A 2# DC 3.82V, 4980mAh	

Note:

1. For a more detailed features description, please refer to the manufacturer's specifications or the user's manual.

2. Channel List:

Channel	Frequency (MHz)	Channel	Frequency (MHz)	Channel	Frequency (MHz)
00	2402	27	2429	54	2456
01	2403	28	2430	55	2457
02	2404	29	2431	56	2458
03	2405	30	2432	57	2459
04	2406	31	2433	58	2460
05	2407	32	2434	59	2461
06	2408	33	2435	60	2462
07	2409	34	2436	61	2463
08	2410	35	2437	62	2464
09	2411	36	2438	63	2465
10	2412	37	2439	64	2466
11	2413	38	2440	65	2467
12	2414	39	2441	66	2468
13	2415	40	2442	67	2469
14	2416	41	2443	68	2470
15	2417	42	2444	69	2471
16	2418	43	2445	70	2472
17	2419	44	2446	71	2473
18	2420	45	2447	72	2474
19	2421	46	2448	73	2475
20	2422	47	2449	74	2476
21	2423	48	2450	75	2477
22	2424	49	2451	76	2478
23	2425	50	2452	77	2479
24	2426	51	2453	78	2480
25	2427	52	2454		
26	2428	53	2455		

3 Table for Filed Antenna:

Ant.	Brand	Model Name	Antenna Type	Connector	Gain (dBi)
1	HUAWEI	N/A	Internal	N/A	0.1

4 The EUT contains following accessory devices.

Item	Manufacturer	Factory	Description
Adapter	Huawei Technologies Co., Ltd.	HUIZHOU BYD ELECTRONIC CO., LTD.	PDM Number: 02220780 Model Name:HW-050100U01 Input Voltage : 100-240V ~50/60Hz, 0.2A Output Voltage: DC 5V,1A (The EU and US adapter are the same PCB board of same factory)
		Shenzhen Huntkey Electric Co., Ltd.	
		DONG GUAN PHITEK ELECTRONICS CO., LTD.	
Battery	Huawei Technologies Co.,Ltd.	SCUD (FUJIAN) Electronics Co., Ltd	PDM Number: 24022744 Model Name: HB2899C0ECW-C Rated Voltage: DC 3.82V Rated Capacity: 4980mAh
USB Cable	Huawei Technologies Co.,Ltd.	FOXCONN INTERCONNECT TECHNOLOGY LIMITED	Model Name: 04071002
		HONGLIN TECHNOLOGY CO.,LTD	
		Luxshare Precision Industry Co., Ltd.	

3.2 DESCRIPTION OF TEST MODES

To investigate the maximum EMI emission characteristics generated from EUT, the test system was pre-scanning tested based on the consideration of following EUT operation mode or test configuration mode which possibly have effect on EMI emission level. Each of these EUT operation mode(s) or test configuration mode(s) mentioned above was evaluated respectively.

Pretest Mode	Description
Mode 1	TX Mode Note (1) (2)

The EUT system operated these modes were found to be the worst case during the pre-scanning test as following:

For Conducted Emission	
Final Test Mode	Description
Mode 1	TX Mode

For Radiated Emission	
Final Test Mode	Description
Mode 1	TX Mode Note (1)

Note:

- (1) Radiated Emissions of middle channel is performed and Band edge of high and low channels are performed.
- (2) The measurements for Hopping Channel Separation, Bandwidth and Peak Output Power were tested during 1Mbps, 2Mbps and 3Mbps, the worst case are 1Mbps and 3Mbps, only worst case was documented.

3.3 TABLE OF PARAMETERS OF TEST SOFTWARE SETTING

During testing, channel & power controlling software provided by the customer was used to control the operating channel as well as the output power level. The RF output power selection is for the setting of RF output power expected by the customer and is going to be fixed on the firmware of the final end product power parameters of FHSS

Test Software Version	BluetoothRfTest_APK_7.0		
Frequency (MHz)	2402	2441	2480
Parameters(1Mbps)	N/A	N/A	N/A
Parameters(3Mbps)	N/A	N/A	N/A

3.4 BLOCK DIAGRAM SHOWING THE CONFIGURATION OF SYSTEM TESTED

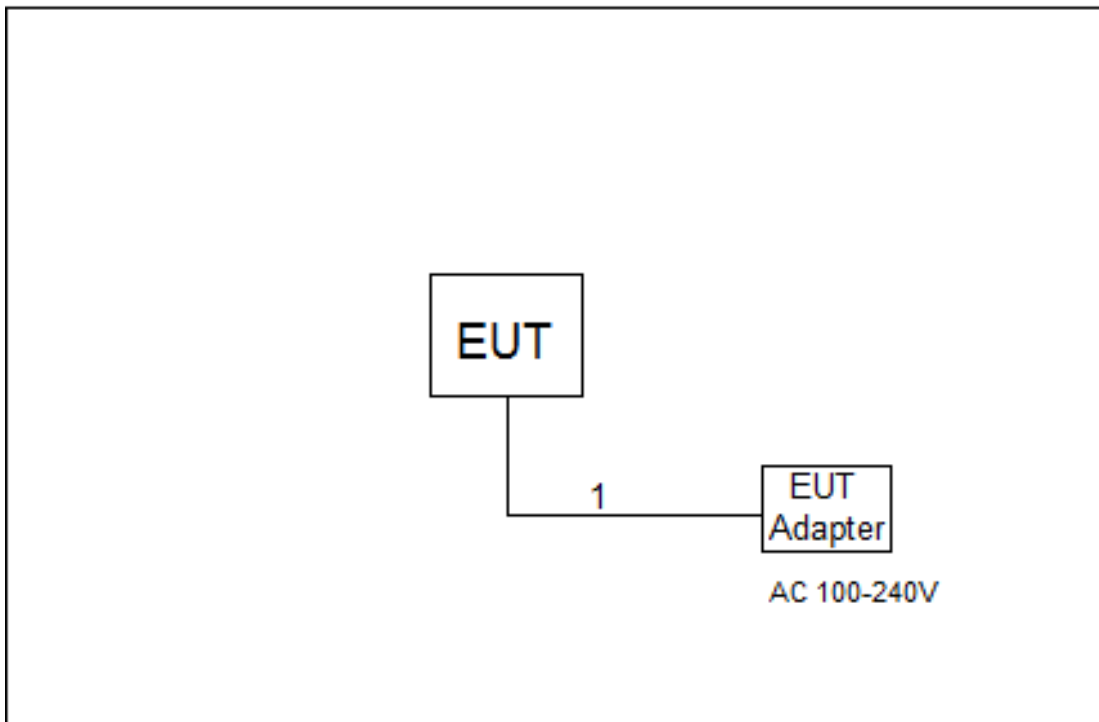

3.5 DESCRIPTION OF SUPPORT UNITS

The EUT has been tested as an independent unit together with other necessary accessories or support units. The following support units or accessories were used to form a representative test configuration during the tests.

Item	Equipment	Mfr/Brand	Model/Type No.	FCC ID	Series No.
-	-	-	-	-	-

Item	Shielded Type	Ferrite Core	Length	Note
1	NO	NO	1.2m	DC Cable

4. EMC EMISSION TEST

4.1 CONDUCTED EMISSION MEASUREMENT

4.1.1 POWER LINE CONDUCTED EMISSION LIMITS (Frequency Range 150 kHz-30 MHz)

Frequency of Emission (MHz)	Conducted Limit (dB μ V)	
	Quasi-peak	Average
0.15 - 0.50	66 to 56*	56 to 46*
0.50 - 5.0	56	46
5.0 - 30.0	60	50

Note:

- (1) The limit of " * " decreases with the logarithm of the frequency
- (2) The test result calculated as following:
 Measurement Value = Reading Level + Correct Factor
 Correct Factor = Insertion Loss + Cable Loss + Attenuator Factor(if use)
 Margin Level = Measurement Value - Limit Value

The following table is the setting of the receiver

Receiver Parameters	Setting
Attenuation	10 dB
Start Frequency	0.15 MHz
Stop Frequency	30 MHz
IF Bandwidth	9 kHz

4.1.2 TEST PROCEDURE

- a. The EUT was placed 0.8 meters from the horizontal ground plane with EUT being connected to the power mains through a line impedance stabilization network (LISN). All other support equipment powered from additional LISN(s). The LISN provide 50 Ohm/ 50uH of coupling impedance for the measuring instrument.
- b. Interconnecting cables that hang closer than 40 cm to the ground plane shall be folded back and forth in the center forming a bundle 30 to 40 cm long.
- c. I/O cables that are not connected to a peripheral shall be bundled in the center. The end of the cable may be terminated, if required, using the correct terminating impedance. The overall length shall not exceed 1 m.
- d. LISN at least 80 cm from nearest part of EUT chassis.
- e. For the actual test configuration, please refer to the related Item –EUT Test Photos.

4.1.3 DEVIATION FROM TEST STANDARD

No deviation

4.1.4 TEST SETUP

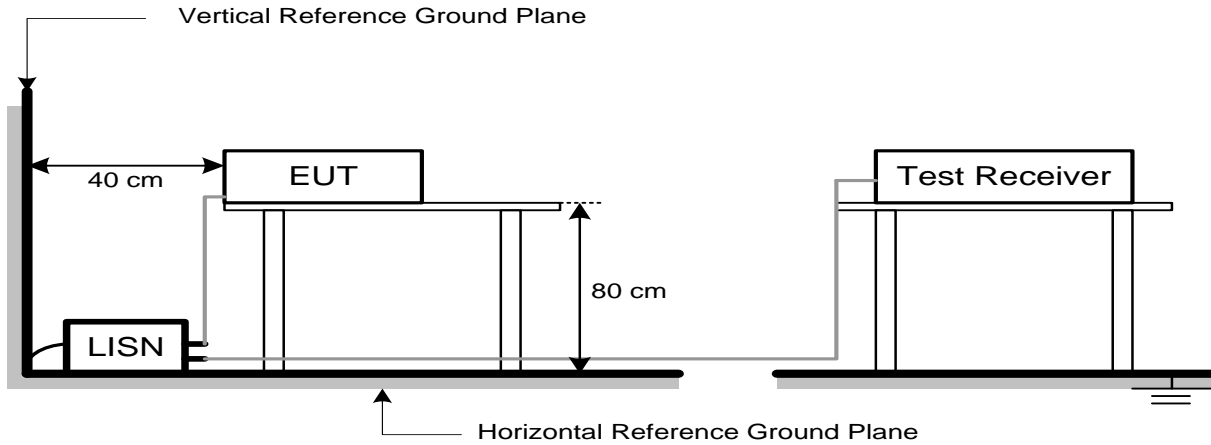

4.1.5 EUT OPERATING CONDITIONS

The EUT was configured for testing in a typical function (as a customer would normally use it), EUT was programmed to be in continuously transmitting/receiving data or hopping on mode.

4.1.6 EUT TEST CONDITIONS

Temperature: 25°C

Relative Humidity: 55%

Test Voltage: AC 120V/60Hz

4.1.7 TEST RESULTS

Please refer to the Appendix A.

Remark:

- (1) All readings are QP Mode value unless otherwise stated AVG in column of『Note』. If the QP Mode Measured value compliance with the QP Limits and lower than AVG Limits, the EUT shall be deemed to meet both QP & AVG Limits and then only QP Mode was measured, but AVG Mode didn't perform in this case, a "*" marked in AVG Mode column of Interference Voltage Measured.
- (2) Measuring frequency range from 150 kHz to 30 MHz.

4.2 RADIATED EMISSION MEASUREMENT

4.2.1 RADIATED EMISSION LIMITS

In case the emission fall within the restricted band specified on 15.205(a), then the 15.209(a) limit in the table below has to be followed.

LIMITS OF RADIATED EMISSION MEASUREMENT (9 kHz-1000 MHz)

Frequency (MHz)	Field Strength (microvolts/meter)	Measurement Distance (meters)
0.009~0.490	2400/F(kHz)	300
0.490~1.705	24000/F(kHz)	30
1.705~30.0	30	30
30~88	100	3
88~216	150	3
216~960	200	3
960~1000	500	3

LIMITS OF RADIATED EMISSION MEASUREMENT (Above 1000 MHz)

Frequency (MHz)	Band edge at 3m (dBµV/m)		Harmonic at 1.5m (dBµV/m)	
	Peak	Average	Peak	Average
Above 1000	74	54	80 (Note 5)	60 (Note 5)

Note:

- (1) The limit for radiated test was performed according to FCC PART 15C.
- (2) The tighter limit applies at the band edges.
- (3) Emission level (dBuV/m)=20log Emission level (uV/m).
- (4) The test result calculated as following:
 Measurement Value = Reading Level + Correct Factor
 Correct Factor = Antenna Factor + Cable Loss - Amplifier Gain(if use)
 Margin Level = Measurement Value - Limit Value

(5)

$$FS_{\text{limit}} = FS_{\text{max}} - 20 \log \left(\frac{d_{\text{limit}}}{d_{\text{measure}}} \right)$$

$$20 \log d_{\text{limit}}/d_{\text{measure}} = 20 \log 3/1.5 = 6 \text{ dB.}$$

Spectrum Parameter	Setting
Attenuation	Auto
Start Frequency	1000 MHz
Stop Frequency	10th carrier harmonic
RBW / VBW (emission in restricted band)	1 MHz / 1 MHz for Peak, 1 MHz / 10Hz for Average

Spectrum Receiver Parameter	Setting
Attenuation	Auto
Start ~ Stop Frequency	9 kHz~90 kHz for PK/AVG detector
Start ~ Stop Frequency	90 kHz~110 kHz for QP detector
Start ~ Stop Frequency	110 kHz~490 kHz for PK/AVG detector
Start ~ Stop Frequency	490 kHz~30 MHz for QP detector
Start ~ Stop Frequency	30 MHz~1000 MHz for QP detector

4.2.2 TEST PROCEDURE

- a. The measuring distance of 3 m shall be used for measurements. The EUT was placed on the top of a rotating table 0.8 meter above the ground at a 3 meter semi-anechoic chamber. The table was rotated 360 degrees to determine the position of the highest radiation.(below 1 GHz)
- b. The measuring distance of 3 m or 1.5m shall be used for measurements. The EUT was placed on the top of a rotating table 1.5 meter above the ground at a 3 meter semi-anechoic chamber. The table was rotated 360 degrees to determine the position of the highest radiation.(above 1GHz)
- c. The height of the equipment or of the substitution antenna shall be 0.8m or 1.5m; the height of the test antenna shall vary between 1 m to 4 m. Both horizontal and vertical polarizations of the antenna are set to make the measurement.
- d. For each suspected emission, the EUT was arranged to its worst case and then the antenna was tuned to heights find the maximum reading (used Bore sight function).
- e. The receiver system was set to peak and average detect function and specified bandwidth with maximum hold mode when the test frequency is above 1 GHz.
- f. The initial step in collecting radiated emission data is a receiver peak detector mode pre-scanning the measurement frequency range. Significant peaks are then marked and then Quasi Peak detector mode re-measured.
- g. All readings are Peak unless otherwise stated QP in column of Note. Peak denotes that the Peak reading compliance with the QP Limits and then QP Mode measurement didn't perform. (below 1 GHz)
- h. All readings are Peak Mode value unless otherwise stated AVG in column of Note. If the Peak Mode Measured value compliance with the Peak Limits and lower than AVG Limits, the EUT shall be deemed to meet both Peak & AVG Limits and then only Peak Mode was measured, but AVG Mode didn't perform. (above 1 GHz)
- i. For the actual test configuration, please refer to the related Item –EUT Test Photos.

4.2.3 DEVIATION FROM TEST STANDARD

No deviation

4.2.4 TEST SETUP

(A) Radiated Emission Test Set-Up Frequency 30 MHz-1000 MHz

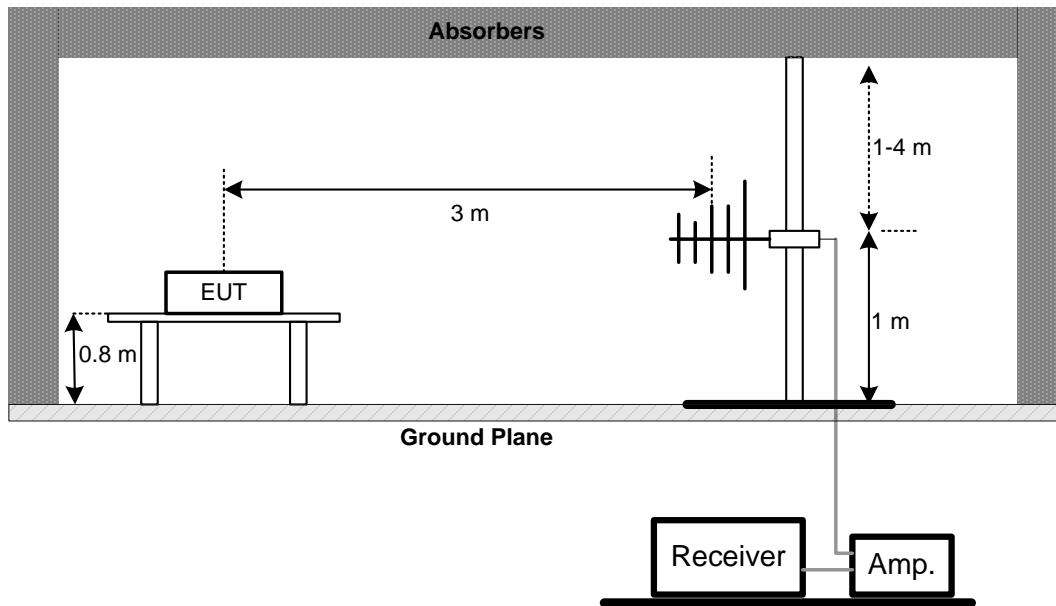

(B) Radiated Emission Test Set-Up Frequency Above 1 GHz
Band edge

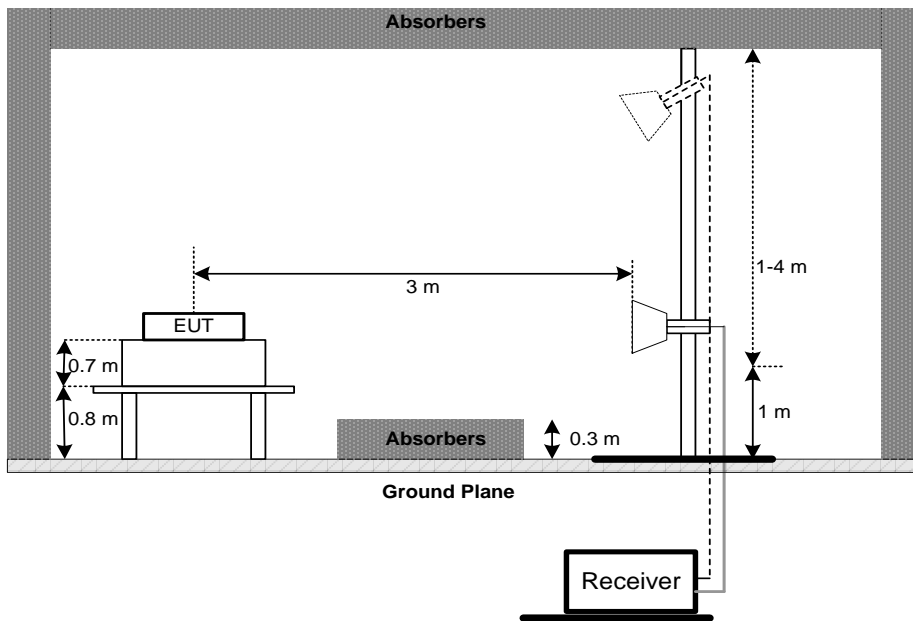

Harmonic

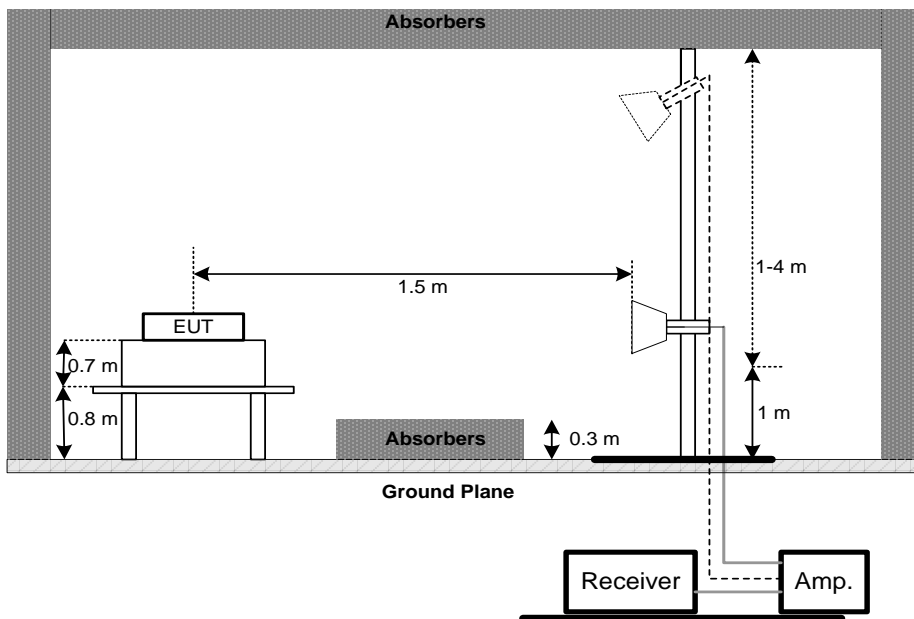

(C) For Radiated Emissions 9 kHz-30 MHz

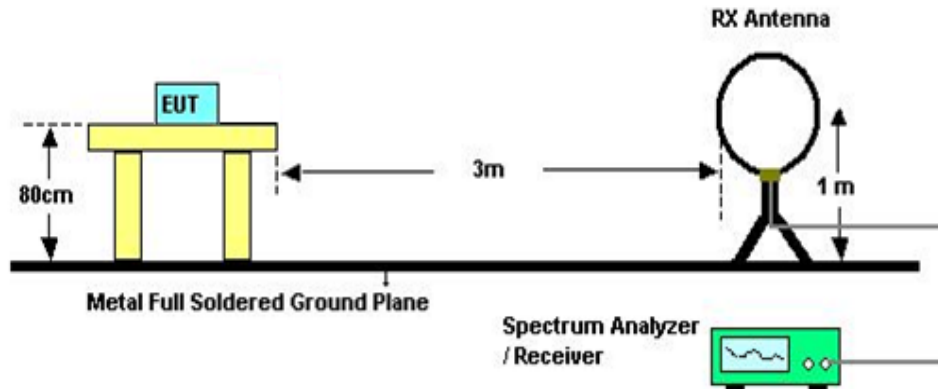

4.2.5 EUT OPERATING CONDITIONS

The EUT was programmed to be in continuously transmitting mode.

4.2.6 EUT TEST CONDITIONS

Temperature: 25°C

Relative Humidity: 55%

Test Voltage: AC 120V/60Hz

4.2.7 TEST RESULTS (9 kHz TO 30 MHz)

Please refer to the Appendix B

Remark:

- (1) The amplitude of spurious emissions which are attenuated by more than 20 dB below the permissible value has no need to be reported.
- (2) Distance extrapolation factor = $40 \log (\text{specific distance} / \text{test distance})$ (dB).
- (3) Limit line = specific limits (dBuV) + distance extrapolation factor.

4.2.8 TEST RESULTS (30 MHz TO 1000 MHz)

Please refer to the Appendix C.

4.2.9 TEST RESULTS (ABOVE 1000 MHz)

Please refer to the Appendix D.

Remark:

- (1) No limit: This is fundamental signal, the judgment is not applicable. For fundamental signal judgment was referred to Peak output test.

5. NUMBER OF HOPPING CHANNEL

5.1 APPLIED PROCEDURES

FCC Part15 (15.247) , Subpart C			
Section	Test Item	Frequency Range (MHz)	Result
15.247(a)(1)(iii)	Number of Hopping Channel	2400-2483.5	PASS

Spectrum Parameters	Setting
Attenuation	Auto
Span Frequency	> Operating Frequency Range
RBW	100 kHz
VBW	100 kHz
Detector	Peak
Trace	Max Hold
Sweep Time	Auto

5.1.1 TEST PROCEDURE

- a. The EUT was directly connected to the spectrum analyzer and antenna output port as show in the block diagram below.
- b. Spectrum Setting: RBW=100 kHz, VBW=100 kHz, Sweep time = Auto.

5.1.2 DEVIATION FROM STANDARD

No deviation.

5.1.3 TEST SETUP



5.1.4 EUT OPERATION CONDITIONS

The EUT tested system was configured as the statements of 4.1.5 unless otherwise a special operating condition is specified in the follows during the testing.

5.1.5 EUT TEST CONDITIONS

Temperature: 25°C
 Relative Humidity: 55%
 Test Voltage: AC 120V/60Hz

5.1.6 TEST RESULTS

Please refer to the Appendix E

6. AVERAGE TIME OF OCCUPANCY

6.1 APPLIED PROCEDURES / LIMIT

FCC Part15 (15.247) , Subpart C				
Section	Test Item	Limit	Frequency Range (MHz)	Result
15.247(a)(1)(iii)	Average Time of Occupancy	0.4sec	2400-2483.5	PASS

6.1.1 TEST PROCEDURE

- a. The transmitter output (antenna port) was connected to the spectrum analyzer
- b. Set RBW of spectrum analyzer to 1 MHz and VBW to 1 MHz
- c. Use a video trigger with the trigger level set to enable triggering only on full pulses
- d. Sweep Time is more than once pulse time
- e. Set the center frequency on any frequency would be measure and set the frequency span to zero span
- f. Measure the maximum time duration of one single pulse
- g. Set the EUT for DH5, DH3 and DH1 packet transmitting
- h. Measure the maximum time duration of one single pulse
 - i. DH5 Packet permit maximum $1600 / 79 / 6 = 3.37$ hops per second in each channel (5 time slots TX, 1 time slot RX). So, the dwell time is the time duration of the pulse times $3.37 \times 31.6 = 106.6$ within 31.6 seconds
 - j. DH3 Packet permit maximum $1600 / 79 / 4 = 5.06$ hops per second in each channel (3 time slots TX, 1 time slot RX). So, the dwell time is the time duration of the pulse times $5.06 \times 31.6 = 160$ within 31.6 seconds
 - k. DH1 Packet permit maximum $1600 / 79 / 2 = 10.12$ hops per second in each channel (1 time slot TX, 1 time slot RX). So, the dwell time is the time duration of the pulse times $10.12 \times 31.6 = 320$ within 31.6 seconds

6.1.2 DEVIATION FROM STANDARD

No deviation.

6.1.3 TEST SETUP



6.1.4 EUT OPERATION CONDITIONS

The EUT tested system was configured as the statements of 4.1.5 unless otherwise a special operating condition is specified in the follows during the testing.

6.1.5 EUT TEST CONDITIONS

Temperature: 25°C

Relative Humidity: 55%

Test Voltage:AC 120V/60Hz

6.1.6 TEST RESULTS

Please refer to the Appendix F

7. HOPPING CHANNEL SEPARATION MEASUREMENT

7.1 APPLIED PROCEDURES / LIMIT

Frequency hopping systems operating in the 2400-2483.5 MHz band may have hopping channel carrier frequencies that are separated by 25 kHz or two-thirds of the 20 dB bandwidth of the hopping channel, whichever is greater.

Spectrum Parameter	Setting
Attenuation	Auto
Span Frequency	> Measurement Bandwidth or Channel Separation
RBW	30 kHz
VBW	100 kHz
Detector	Peak
Trace	Max Hold
Sweep Time	Auto

7.1.1 TEST PROCEDURE

- a. The EUT must have its hopping function enabled
- b. Span = wide enough to capture the peaks of two adjacent channels
 - Resolution (or IF) Bandwidth (RBW) \geq 1% of the span
 - Video (or Average) Bandwidth (VBW) \geq RBW
 - Sweep = Auto
 - Detector function = Peak
 - Trace = Max Hold

7.1.2 DEVIATION FROM STANDARD

No deviation.

7.1.3 TEST SETUP



7.1.4 EUT TEST CONDITIONS

Temperature: 25°C
 Relative Humidity: 55%
 Test Voltage: AC 120V/60Hz

7.1.5 TEST RESULTS

Please refer to the Appendix G

8. BANDWIDTH TEST

8.1 APPLIED PROCEDURES

FCC Part15 (15.247) , Subpart C		
Section	Test Item	Frequency Range (MHz)
15.247(a)(2)	Bandwidth	2400-2483.5

Spectrum Parameter	Setting
Attenuation	Auto
Span Frequency	> Measurement Bandwidth or Channel Separation
RBW	30 kHz (20dB Bandwidth) / 30 kHz (Channel Separation)
VBW	100 kHz (20dB Bandwidth) / 100 kHz (Channel Separation)
Detector	Peak
Trace	Max Hold
Sweep Time	Auto

8.1.1 TEST PROCEDURE

- a. The EUT was directly connected to the spectrum analyzer and antenna output port as show in the block diagram below.
- b. Spectrum Setting: RBW= 30 kHz, VBW=100 kHz, Sweep Time = Auto.

8.1.2 DEVIATION FROM STANDARD

No deviation.

8.1.3 TEST SETUP



8.1.4 EUT OPERATION CONDITIONS

The EUT tested system was configured as the statements of 4.1.5 unless otherwise a special operating condition is specified in the follows during the testing.

8.1.5 EUT TEST CONDITIONS

Temperature: 25°C
 Relative Humidity: 55%
 Test Voltage: AC 120V/60Hz

8.1.6 TEST RESULTS

Please refer to the Appendix H

9. MAXIMUM OUTPUT POWER

9.1 APPLIED PROCEDURES / LIMIT

FCC Part15 (15.247) , Subpart C				
Section	Test Item	Limit	Frequency Range (MHz)	Result
15.247(a)(1)	Maximum Output Power	0.125Watt or 21dBm	2400-2483.5	PASS

Note: Frequency hopping systems shall have hopping channel carrier frequencies separated by a minimum of 25 kHz or the 20 dB bandwidth of the hopping channel, whichever is greater. Alternatively, frequency hopping systems operating in the 2400-2483.5 MHz band may have hopping channel carrier frequencies that are separated by 25 kHz or two-thirds of the 20 dB bandwidth of the hopping channel, whichever is greater, provided the systems operate with an output power no greater than 125 mW.

9.1.1 TEST PROCEDURE

- a. The EUT was directly connected to the spectrum analyzer and antenna output port as show in the block diagram below.
- b. Spectrum Setting: RBW= 1 MHz/3 MHz, VBW= 1 MHz/3 MHz, Sweep time = Auto.

9.1.2 DEVIATION FROM STANDARD

No deviation.

9.1.3 TEST SETUP

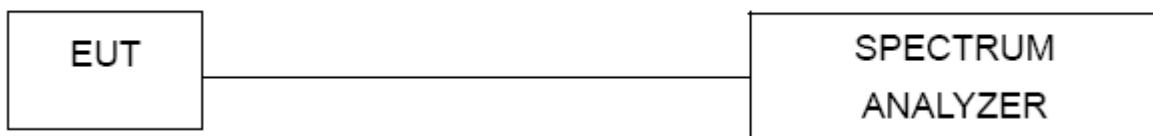

9.1.4 EUT OPERATION CONDITIONS

The EUT tested system was configured as the statements of 4.1.5 unless otherwise a special operating condition is specified in the follows during the testing.

9.1.5 EUT TEST CONDITIONS

Temperature: 25°C
 Relative Humidity: 55%
 Test Voltage: AC 120V/60Hz

9.1.6 TEST RESULTS

Please refer to the Appendix I

10. ANTENNA CONDUCTED SPURIOUS EMISSION

10.1 APPLIED PROCEDURES / LIMIT

In any 100 kHz bandwidth outside the frequency band in which the spread spectrum or digitally modulated intentional radiator is operating, the radio frequency power that is produced by the intentional radiator shall be at least 20 dB below that in the 100 kHz bandwidth within the band that contains the highest level of the desired power, based on either an RF conducted or a radiated measurement, provided the transmitter demonstrates compliance with the peak Output Power limits. If the transmitter complies with the Output Power limits based on the use of RMS averaging over a time interval, as permitted under paragraph (b)(3) of this section, the attenuation required under this paragraph shall be 30 dB instead of 20 dB. Attenuation below the general limits specified in Section 15.209(a) is not required. In addition, radiated emissions which fall in the restricted bands, as defined in Section 15.205(a), must also comply with the radiated emission limits specified in Section 15.209(a) (see Section 15.205(c)).

10.1.1 TEST PROCEDURE

- a. The EUT was directly connected to the spectrum analyzer and antenna output port as show in the block diagram below.
- b. Spectrum Setting: RBW= 100 kHz, VBW=100 kHz, Sweep time = Auto.

10.1.2 DEVIATION FROM STANDARD

No deviation.

10.1.3 TEST SETUP



10.1.4 EUT OPERATION CONDITIONS

The EUT tested system was configured as the statements of 4.1.5 unless otherwise a special operating condition is specified in the follows during the testing.

10.1.5 EUT TEST CONDITIONS

Temperature: 25°C
 Relative Humidity: 55%
 Test Voltage: AC 120V/60Hz

10.1.6 TEST RESULTS

Please refer to the Appendix J

11. MEASUREMENT INSTRUMENTS LIST

Conducted Emission Measurement					
Item	Kind of Equipment	Manufacturer	Type No.	Serial No.	Calibrated until
1	EMI Test Receiver	R&S	ESCI	100382	Mar. 11, 2019
2	LISN	EMCO	3816/2	52765	Mar. 11, 2019
3	50Ω Terminator	SHX	TF2-3G-A	8122901	Mar. 11, 2019
4	TWO-LINE V-NETWORK	R&S	ENV216	101447	Mar. 11, 2019
5	Measurement Software	Farad	EZ-EMC Ver.NB-03A1-01	N/A	N/A
6	Cable	N/A	RG223	12m	Mar. 23, 2019

Radiated Emission Measurement - 9kHz TO 30 MHz					
Item	Kind of Equipment	Manufacturer	Type No.	Serial No.	Calibrated until
1	Loop Antenna	EM	EM-6876-1	230	Feb. 07, 2019
2	Cable	N/A	RG 213/U	C-102	Jun. 01, 2019
3	EMI Test Receiver	R&S	ESCI	100382	Mar. 11, 2019
4	Measurement Software	Farad	EZ-EMC Ver.NB-03A1-01	N/A	N/A

Radiated Emission Measurement – 30 MHz TO 1000 MHz					
Item	Kind of Equipment	Manufacturer	Type No.	Serial No.	Calibrated until
1	Antenna	Schwarbeck	VULB9160	9160-3232	Mar. 11, 2019
2	Amplifier	HP	8447D	2944A09673	Aug. 11, 2019
3	Receiver	Agilent	N9038A	MY52130039	Aug. 11, 2019
4	Cable	emci	LMR-400(30MHz-1 GHz)(8m+5m)	N/A	May 25, 2019
5	Controller	CT	SC100	N/A	N/A
6	Controller	MF	MF-7802	MF780208416	N/A
7	Measurement Software	Farad	EZ-EMC Ver.NB-03A1-01	N/A	N/A

Radiated Emission Measurement - Above 1 GHz

Item	Kind of Equipment	Manufacturer	Type No.	Serial No.	Calibrated until
1	Double Ridged Guide Antenna	ETS	3115	75789	Mar. 11, 2019
2	Broad-Band Horn Antenna	Schwarzbeck	BBHA 9170	9170319	Jun. 30, 2019
3	Amplifier	Agilent	8449B	3008A02274	Mar. 11, 2019
4	Microwave Preamplifier With Adaptor	EMC INSTRUMENT	EMC2654045	980039 & HA01	Mar. 11, 2019
5	Receiver	Agilent	N9038A	MY52130039	Aug. 11, 2019
6	Controller	CT	SC100	N/A	N/A
7	Controller	MF	MF-7802	MF780208416	N/A
8	Cable	mitron	B10-01-01-12M	18072744	Jul. 30, 2019
9	Measurement Software	Farad	EZ-EMC Ver.NB-03A1-01	N/A	N/A

Number of Hopping Channel

Item	Kind of Equipment	Manufacturer	Type No.	Serial No.	Calibrated until
1	Spectrum Analyzer	R&S	FSP40	100185	Aug. 11, 2019

Average Time of Occupancy

Item	Kind of Equipment	Manufacturer	Type No.	Serial No.	Calibrated until
1	Spectrum Analyzer	R&S	FSP40	100185	Aug. 11, 2019

Hopping Channel Separation Measurement

Item	Kind of Equipment	Manufacturer	Type No.	Serial No.	Calibrated until
1	Spectrum Analyzer	R&S	FSP40	100185	Aug. 11, 2019

Bandwidth

Item	Kind of Equipment	Manufacturer	Type No.	Serial No.	Calibrated until
1	Spectrum Analyzer	R&S	FSP40	100185	Aug. 11, 2019

Peak Output Power

Item	Kind of Equipment	Manufacturer	Type No.	Serial No.	Calibrated until
1	Spectrum Analyzer	R&S	FSP40	100185	Aug. 11, 2019

Antenna Conducted Spurious Emission

Item	Kind of Equipment	Manufacturer	Type No.	Serial No.	Calibrated until
1	Spectrum Analyzer	R&S	FSP40	100185	Aug. 11, 2019

Remark "N/A" denotes no model name, serial no. or calibration specified.
All calibration period of equipment list is one year.

APPENDIX A - CONDUCTED EMISSION

Test Mode: TX Mode _Adapter: Huntkey

Line

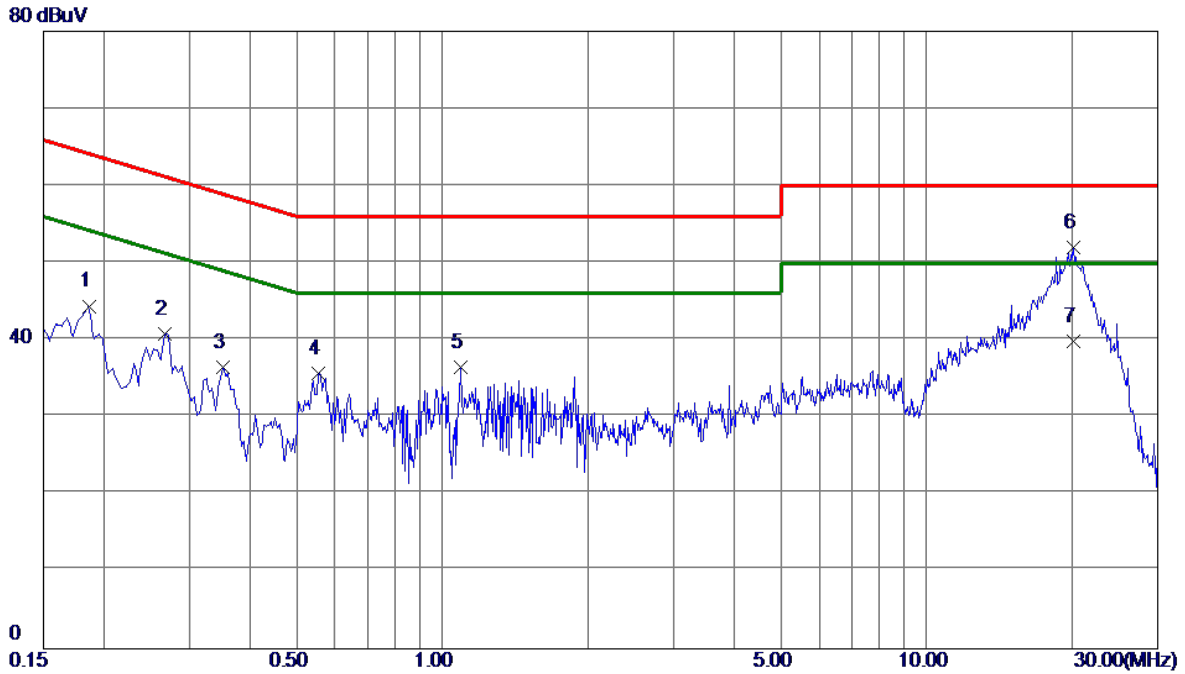

No.	Freq. MHz	Reading Level dBuV	Correct Factor dB	Measure ment dBuV	Limit dBuV	Margin dB	Detector	Comment
1	0.1860	34.58	9.82	44.40	64.21	-19.81	Peak	
2	0.2670	31.03	9.82	40.85	61.21	-20.36	Peak	
3	0.3525	26.73	9.81	36.54	58.90	-22.36	Peak	
4	0.5550	25.85	9.81	35.66	56.00	-20.34	Peak	
5	1.0905	26.53	9.93	36.46	56.00	-19.54	Peak	
6 *	20.0715	40.75	11.19	51.94	60.00	-8.06	Peak	
7	20.0715	28.60	11.19	39.79	50.00	-10.21	AVG	

Test Mode: TX Mode _Adapter: Huntkey

Neutral

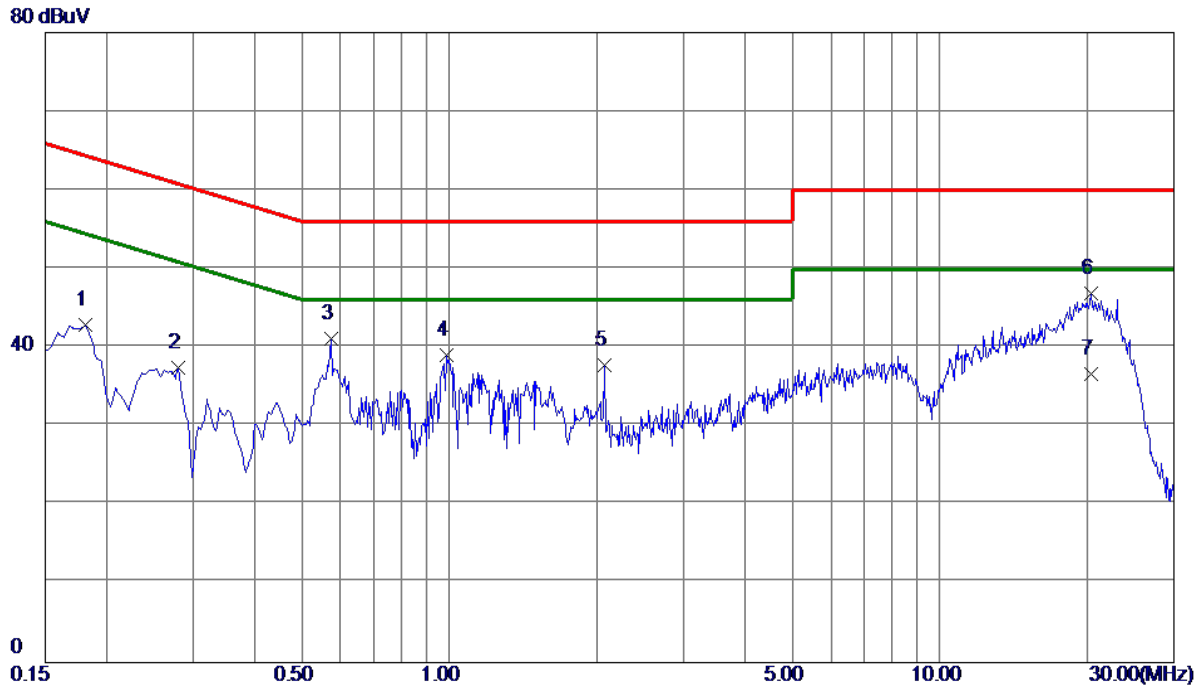

No.	Freq. MHz	Reading Level dBuV	Correct Factor dB	Measure ment dBuV	Limit dBuV	Margin dB	Detector	Comment
1	0.1815	33.01	9.91	42.92	64.42	-21.50	Peak	
2	0.2805	27.48	9.93	37.41	60.80	-23.39	Peak	
3	0.5730	31.19	9.97	41.16	56.00	-14.84	Peak	
4	0.9870	28.91	10.12	39.03	56.00	-16.97	Peak	
5	2.0715	27.57	10.19	37.76	56.00	-18.24	Peak	
6 *	20.3190	35.34	11.48	46.82	60.00	-13.18	Peak	
7	20.3190	25.11	11.48	36.59	50.00	-13.41	AVG	

Test Mode: TX Mode _Adapter: PHITEK

Line

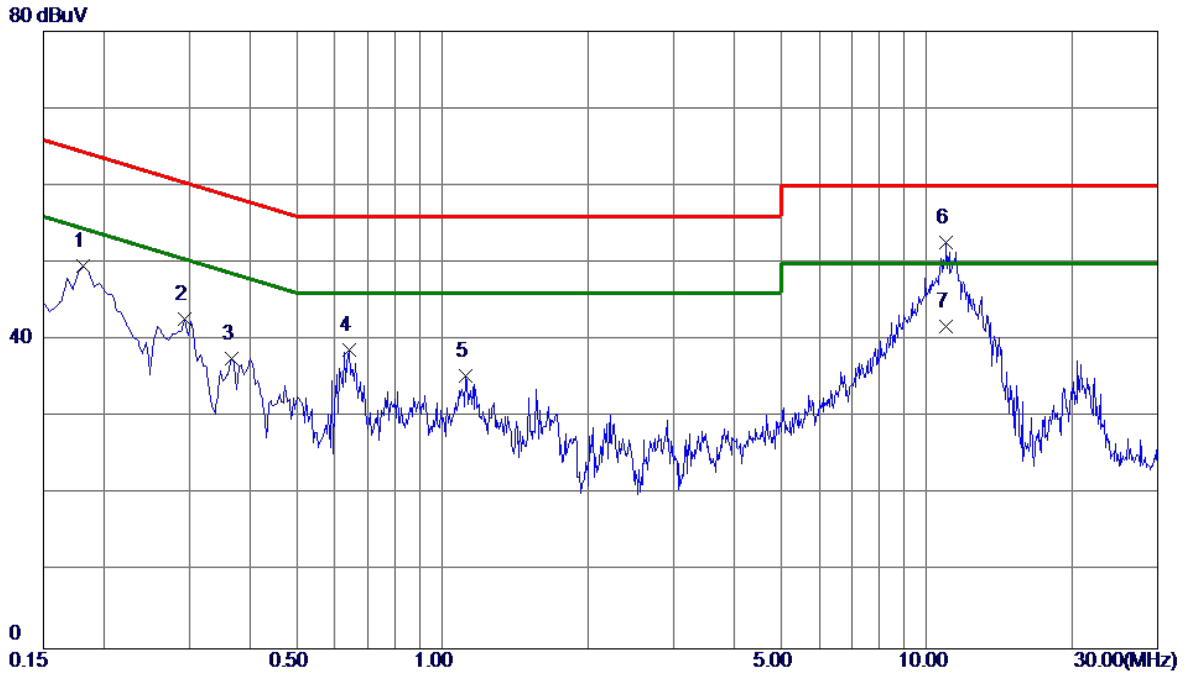

No.	Freq. MHz	Reading Level dBuV	Correct Factor dB	Measure ment dBuV	Limit dBuV	Margin dB	Detector	Comment
1	0.1815	39.84	9.82	49.66	64.42	-14.76	Peak	
2	0.2940	32.84	9.82	42.66	60.41	-17.75	Peak	
3	0.3660	27.76	9.81	37.57	58.59	-21.02	Peak	
4	0.6405	28.85	9.85	38.70	56.00	-17.30	Peak	
5	1.1174	25.43	9.93	35.36	56.00	-20.64	Peak	
6 *	10.9950	42.13	10.54	52.67	60.00	-7.33	Peak	
7	10.9950	31.20	10.54	41.74	50.00	-8.26	AVG	

Test Mode: TX Mode_Adapter: PHITEK

Neutral

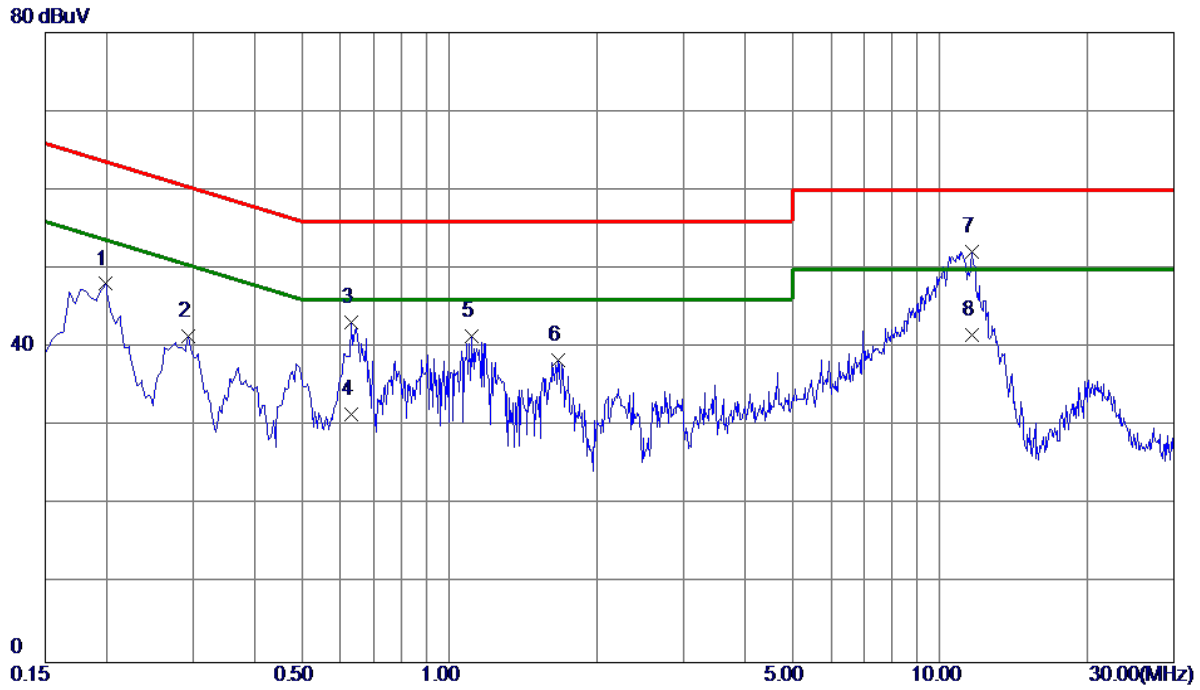

No.	Freq. MHz	Reading Level dBuV	Correct Factor dB	Measure ment dBuV	Limit dBuV	Margin dB	Detector	Comment
1	0.1995	38.17	9.91	48.08	63.63	-15.55	Peak	
2	0.2940	31.50	9.93	41.43	60.41	-18.98	Peak	
3	0.6315	33.22	10.00	43.22	56.00	-12.78	Peak	
4	0.6315	21.50	10.00	31.50	46.00	-14.50	AVG	
5	1.1085	31.36	10.13	41.49	56.00	-14.51	Peak	
6	1.6710	28.23	10.17	38.40	56.00	-17.60	Peak	
7 *	11.6520	41.35	10.86	52.21	60.00	-7.79	Peak	
8	11.6520	30.80	10.86	41.66	50.00	-8.34	AVG	

Test Mode: TX Mode_Adapter: BYD

Line

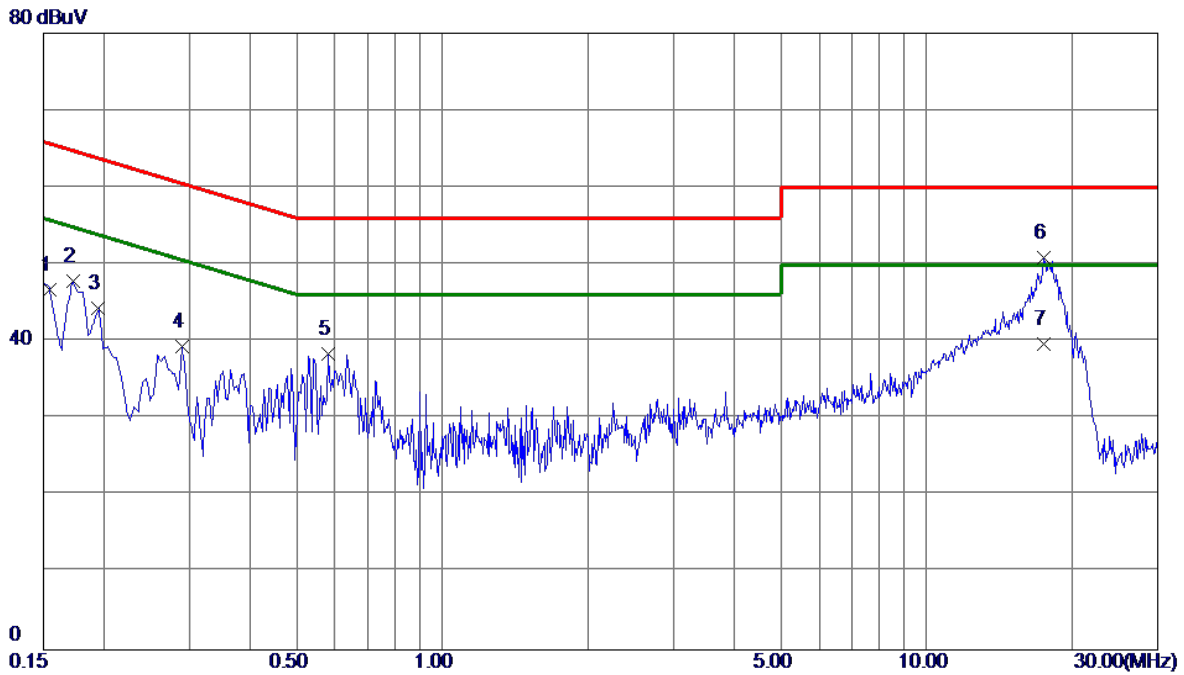

No.	Freq. MHz	Reading Level dBuV	Correct Factor dB	Measure ment dBuV	Limit dBuV	Margin dB	Detector	Comment
1	0.1548	36.92	9.82	46.74	65.74	-19.00	Peak	
2	0.1725	38.07	9.82	47.89	64.84	-16.95	Peak	
3	0.1949	34.45	9.82	44.27	63.83	-19.56	Peak	
4	0.2895	29.53	9.82	39.35	60.54	-21.19	Peak	
5	0.5820	28.53	9.82	38.35	56.00	-17.65	Peak	
6 *	17.4480	39.87	10.97	50.84	60.00	-9.16	Peak	
7	17.4480	28.70	10.97	39.67	50.00	-10.33	AVG	

Test Mode: TX Mode _Adapter: BYD

Neutral

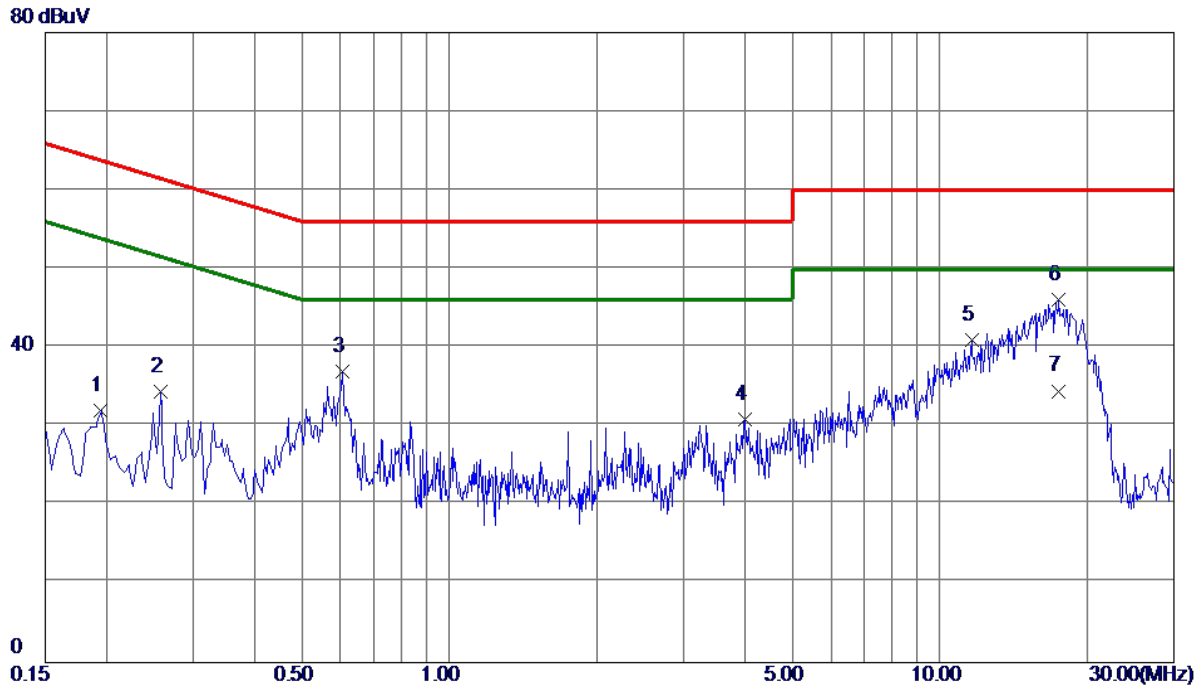

No.	Freq. MHz	Reading Level dBuV	Correct Factor dB	Measure ment dBuV	Limit dBuV	Margin dB	Detector	Comment
1	0.1949	22.09	9.91	32.00	63.83	-31.83	Peak	
2	0.2580	24.44	9.92	34.36	61.50	-27.14	Peak	
3	0.6045	26.91	9.98	36.89	56.00	-19.11	Peak	
4	4.0109	20.50	10.32	30.82	56.00	-25.18	Peak	
5	11.5980	30.13	10.85	40.98	60.00	-19.02	Peak	
6 *	17.4794	34.73	11.28	46.01	60.00	-13.99	Peak	
7	17.4794	23.20	11.28	34.48	50.00	-15.52	AVG	

APPENDIX B - RADIATED EMISSION (9 KHZ-30 MHZ)

Test Mode: TX Mode _Adapter: Huntkey

Ant 0°

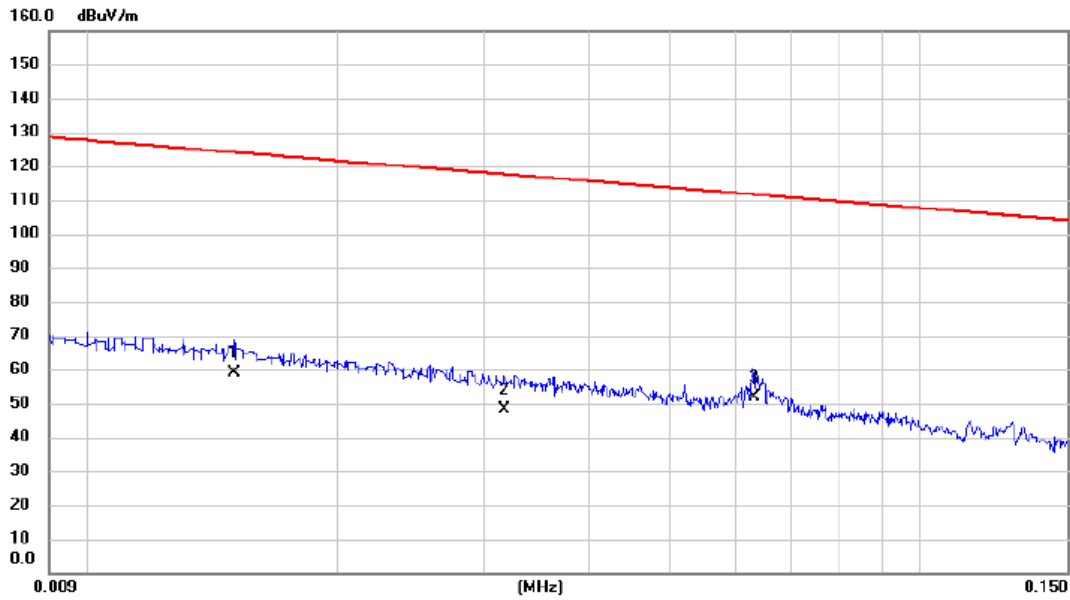

No.	Mk.	Freq. MHz	Reading Level dBuV	Correct Factor dB	Measure- ment dBuV/m	Limit dBuV/m	Margin dB	Detector	Comment
1		0.0150	38.10	20.72	58.82	124.08	-65.26	AVG	
2		0.0317	28.30	19.82	48.12	117.58	-69.46	AVG	
3	*	0.0631	32.50	19.27	51.77	111.60	-59.83	AVG	

Test Mode: TX Mode_ Adapter: Huntkey

Ant 0°

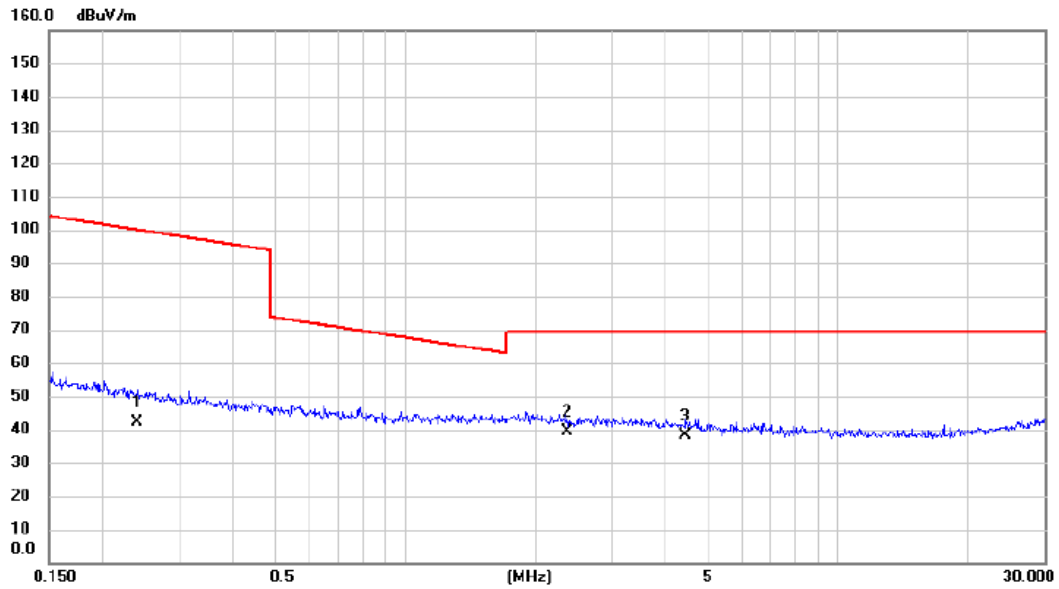

No.	Mk.	Freq. MHz	Reading Level dBuV	Correct Factor dB	Measure- ment dBuV/m	Limit dBuV/m	Margin dB	Detector	Comment
1		0.2404	25.10	17.08	42.18	99.99	-57.81	AVG	
2	*	2.3585	22.70	16.90	39.60	69.54	-29.94	QP	
3		4.4540	22.80	15.49	38.29	69.54	-31.25	QP	

Test Mode: TX Mode_Adapter: Huntkey

Ant 90°

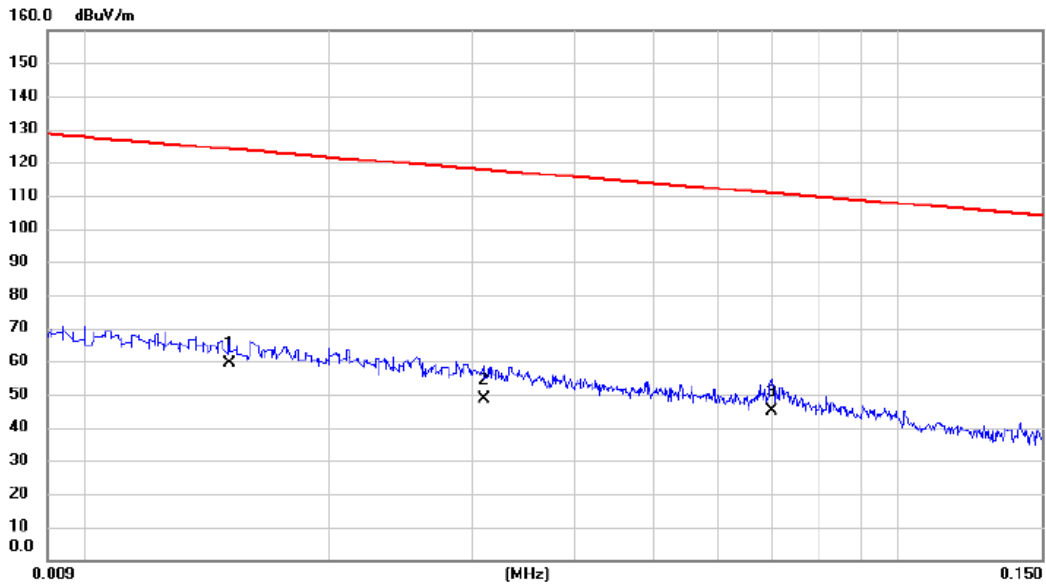

No.	Mk.	Freq. MHz	Reading Level dBuV	Correct Factor dB	Measure- ment dBuV/m	Limit dBuV/m	Margin dB	Detector	Comment
1	*	0.0151	38.50	20.71	59.21	124.03	-64.82	AVG	
2		0.0310	28.80	19.84	48.64	117.78	-69.14	AVG	
3		0.0700	25.70	19.13	44.83	110.70	-65.87	AVG	

Test Mode: TX Mode_Adapter: Huntkey

Ant 90°

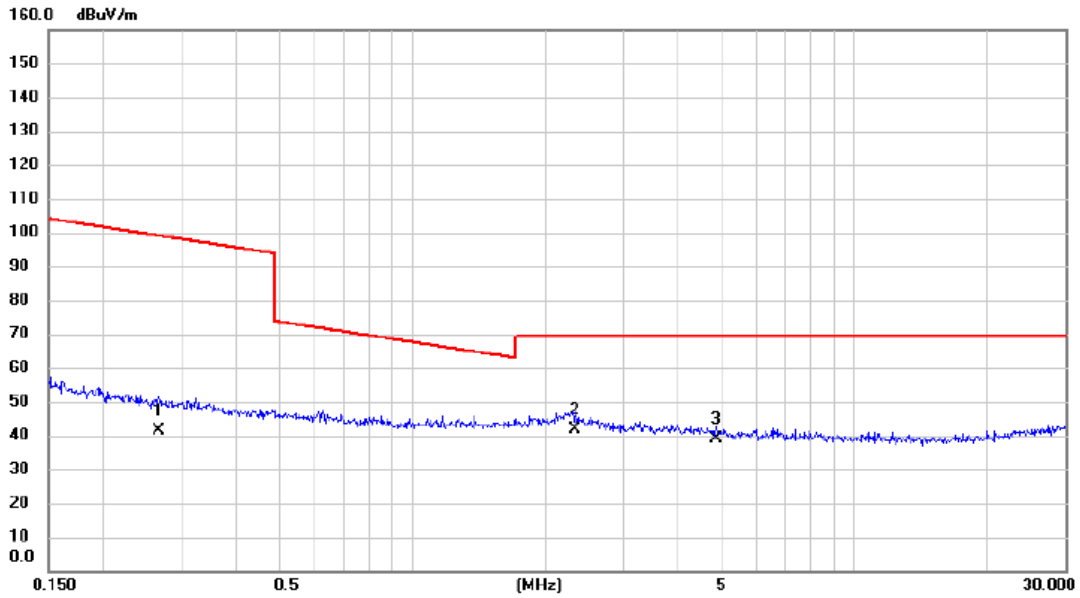

No.	Mk.	Freq. MHz	Reading Level dBuV	Correct Factor dB	Measure- ment dBuV/m	Limit dBuV/m	Margin dB	Detector	Comment
1		0.2672	24.30	17.05	41.35	99.07	-57.72	AVG	
2	*	2.3336	24.70	16.92	41.62	69.54	-27.92	QP	
3		4.8738	23.60	15.25	38.85	69.54	-30.69	QP	

Test Mode: TX Mode _Adapter: PHITEK

Ant 0°

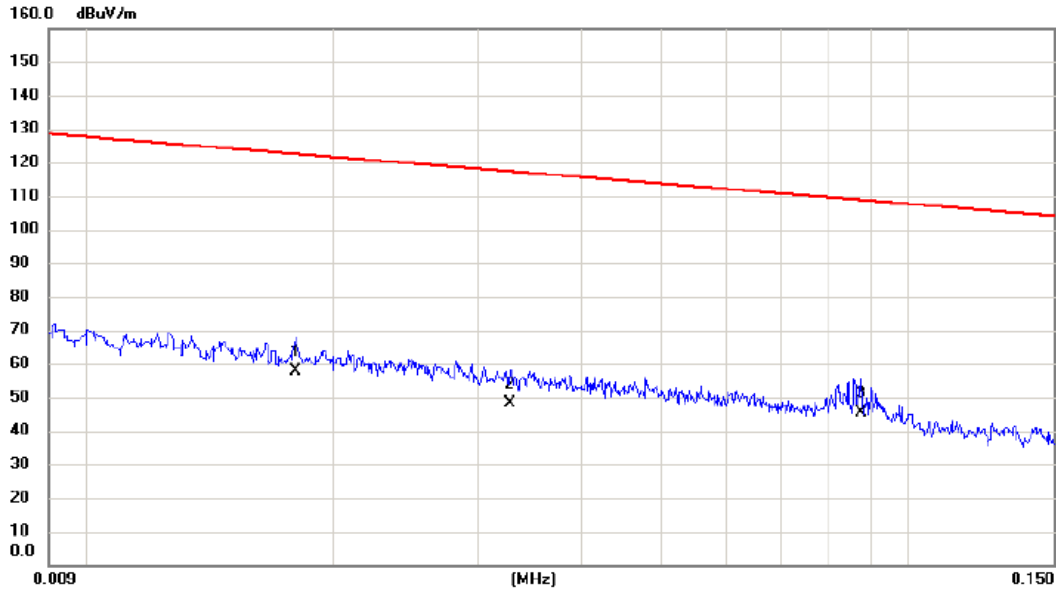

No.	Mk.	Freq. MHz	Reading Level dBuV	Correct Factor dB	Measure- ment dBuV/m	Limit dBuV/m	Margin dB	Detector	Comment
1		0.0180	37.60	20.30	57.90	122.50	-64.60	AVG	
2		0.0328	28.50	19.81	48.31	117.29	-68.98	AVG	
3	*	0.0875	26.80	18.73	45.53	108.76	-63.23	AVG	

Test Mode: TX Mode_ Adapter: PHITEK

Ant 0°

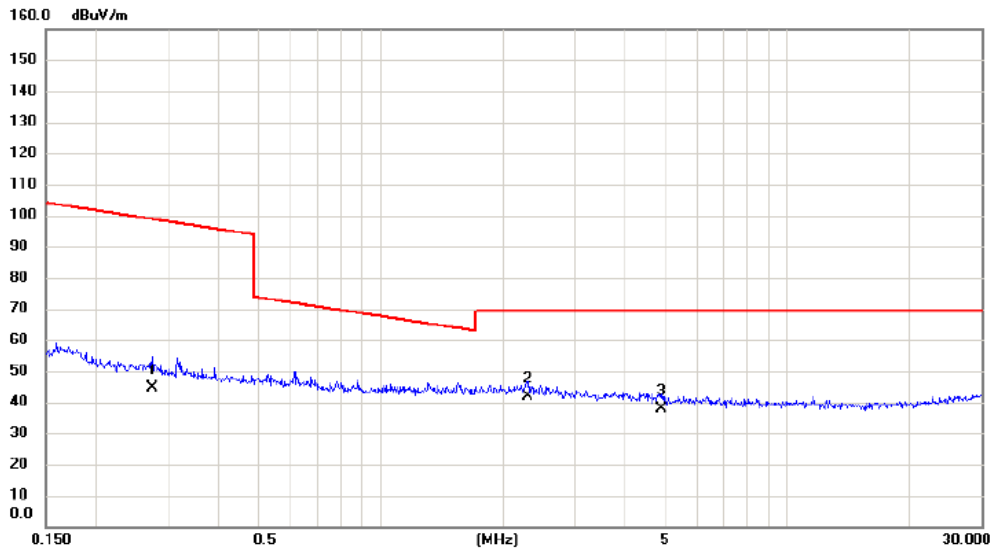

No.	Mk.	Freq. MHz	Reading Level dBuV	Correct Factor dB	Measure- ment dBuV/m	Limit dBuV/m	Margin dB	Detector	Comment
1		0.2744	27.50	17.05	44.55	98.84	-54.29	AVG	
2	*	2.2968	24.80	16.94	41.74	69.54	-27.80	QP	
3		4.8997	22.40	15.23	37.63	69.54	-31.91	QP	

Test Mode: TX Mode_Adapter: PHITEK

Ant 90°

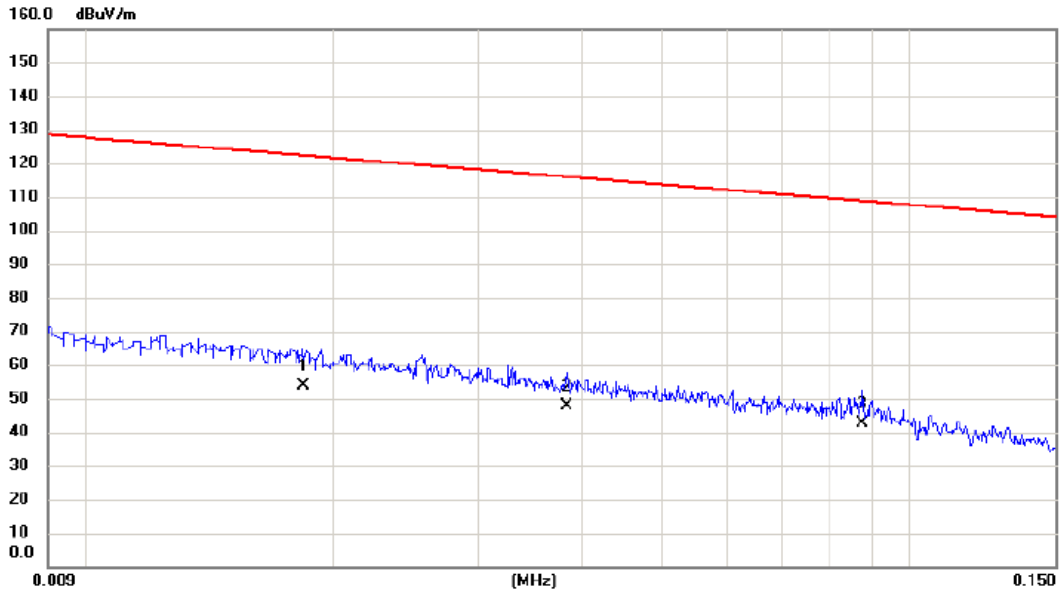

No.	Mk.	Freq. MHz	Reading Level dBuV	Correct Factor dB	Measure- ment dBuV/m	Limit dBuV/m	Margin dB	Detector	Comment
1		0.0184	33.60	20.24	53.84	122.31	-68.47	AVG	
2		0.0383	28.10	19.72	47.82	115.94	-68.12	AVG	
3	*	0.0875	23.70	18.73	42.43	108.76	-66.33	AVG	

Test Mode: TX Mode_ Adapter: PHITEK

Ant 90°

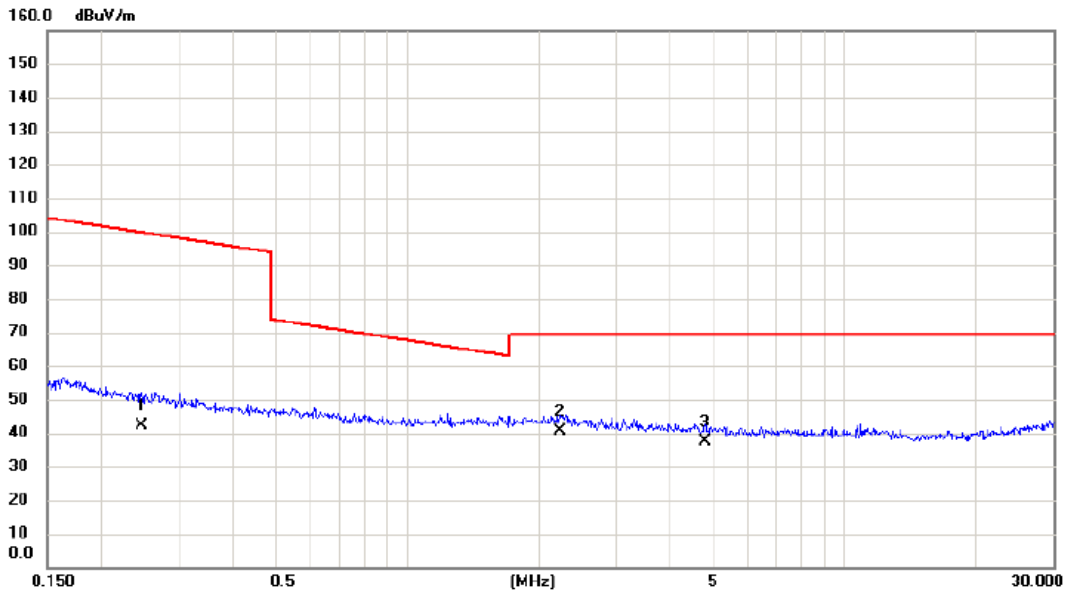

No.	Mk.	Freq. MHz	Reading Level dBuV	Correct Factor dB	Measure- ment dBuV/m	Limit dBuV/m	Margin dB	Detector	Comment
1		0.2468	25.20	17.07	42.27	99.76	-57.49	AVG	
2	*	2.2367	23.60	16.97	40.57	69.54	-28.97	QP	
3		4.7970	22.20	15.29	37.49	69.54	-32.05	QP	

Test Mode: TX Mode _Adapter: BYD

Ant 0°

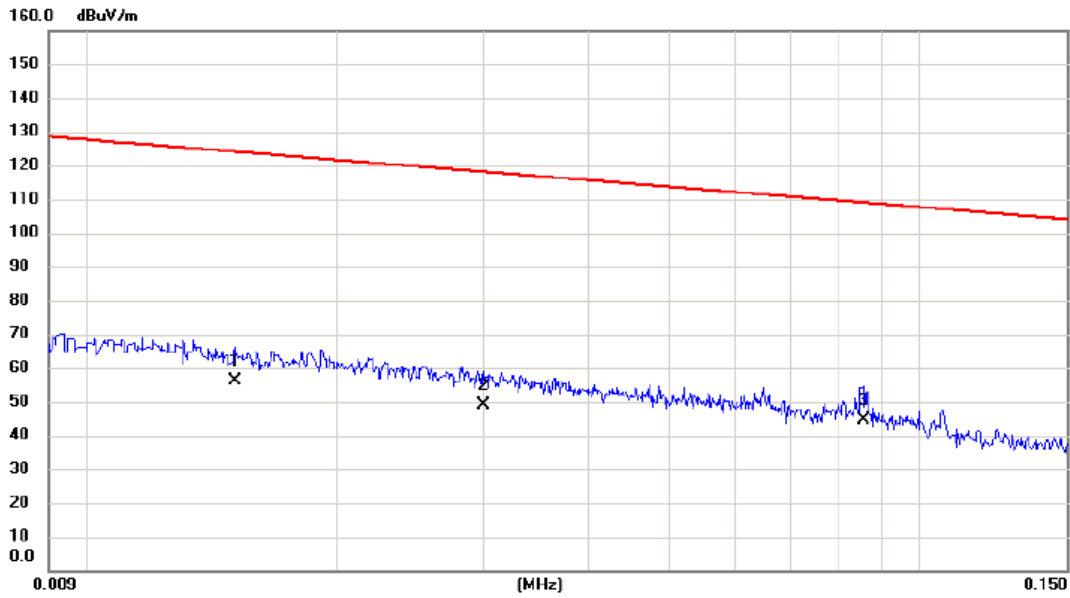

No.	Mk.	Freq. MHz	Reading Level dBuV	Correct Factor dB	Measure- ment dBuV/m	Limit dBuV/m	Margin dB	Detector	Comment
1		0.0151	35.60	20.71	56.31	124.03	-67.72	AVG	
2		0.0300	29.21	19.85	49.06	118.06	-69.00	AVG	
3	*	0.0857	25.90	18.77	44.67	108.95	-64.28	AVG	

Test Mode: TX Mode_ Adapter: BYD

Ant 0°

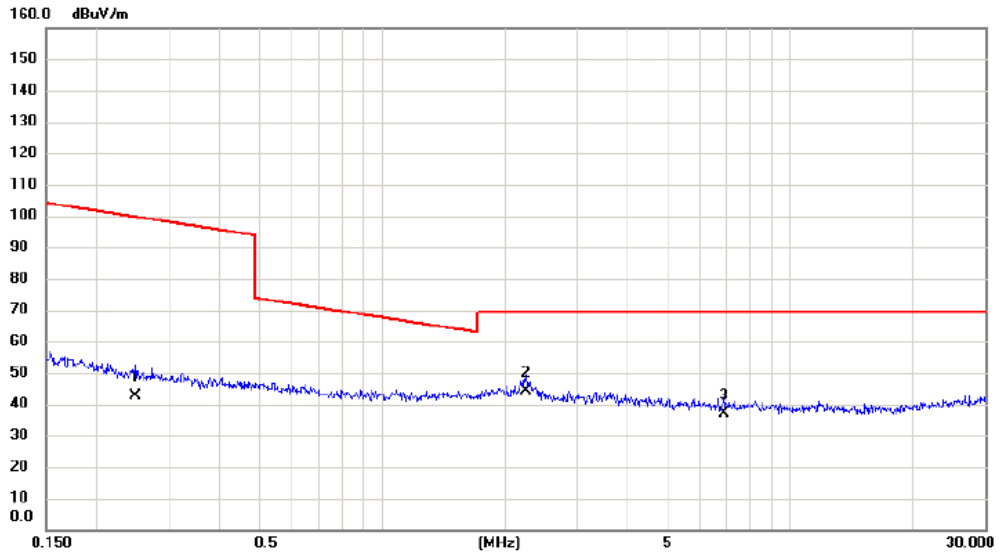

No.	Mk.	Freq. MHz	Reading Level dBuV	Correct Factor dB	Measure- ment dBuV/m	Limit dBuV/m	Margin dB	Detector	Comment
1		0.2481	25.40	17.06	42.46	99.71	-57.25	AVG	
2	*	2.2486	27.30	16.96	44.26	69.54	-25.28	QP	
3		6.8776	22.10	14.86	36.96	69.54	-32.58	QP	

Test Mode: TX Mode_ Adapter: BYD

Ant 90°

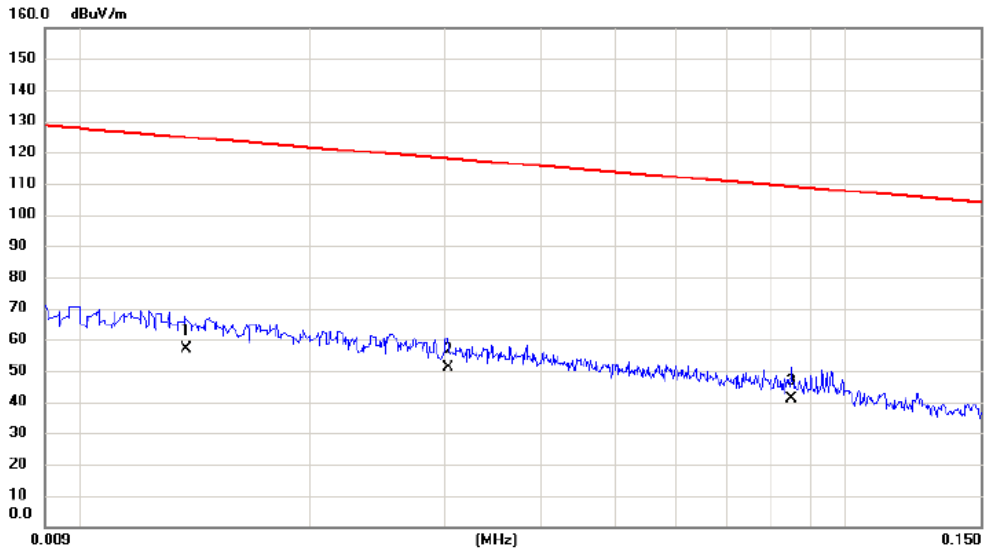

No. Mk.	Freq. MHz	Reading Level dBuV	Correct Factor dB	Measurement dBuV/m	Limit dBuV/m	Margin dB	Detector	Comment
1	0.0138	36.30	20.89	57.19	124.81	-67.62	AVG	
2 *	0.0303	31.10	19.85	50.95	117.98	-67.03	AVG	
3	0.0850	22.40	18.79	41.19	109.02	-67.83	AVG	

Test Mode: TX Mode_ Adapter: BYD

Ant 90°

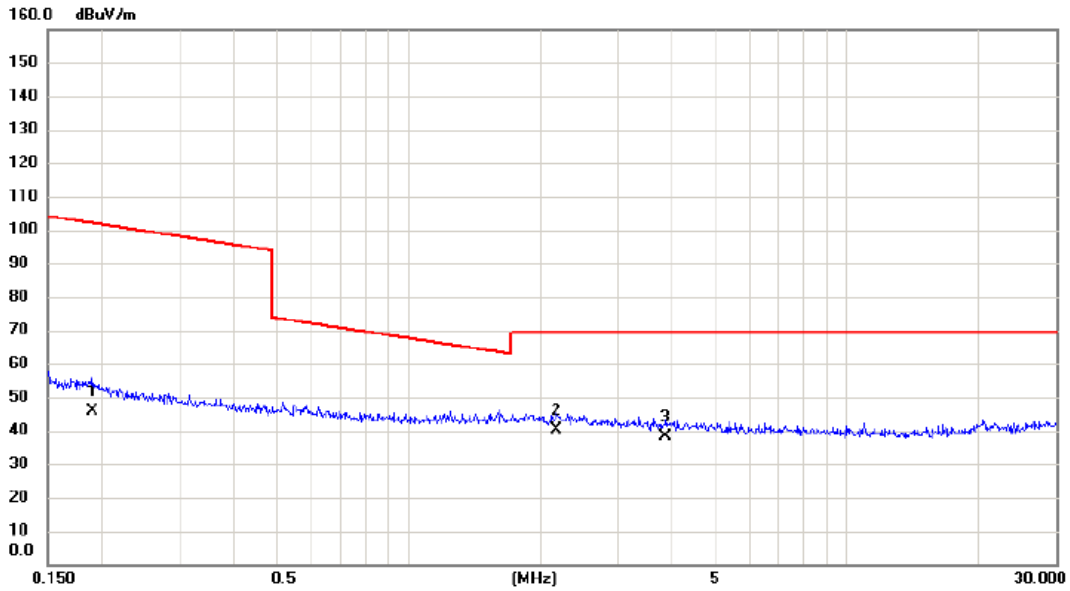

No.	Mk.	Freq. MHz	Reading Level dBuV	Correct Factor dB	Measure- ment dBuV/m	Limit dBuV/m	Margin dB	Detector	Comment
1		0.1894	28.50	17.17	45.67	102.06	-56.39	AVG	
2	*	2.1783	23.40	17.00	40.40	69.54	-29.14	QP	
3		3.8603	22.30	15.86	38.16	69.54	-31.38	QP	

APPENDIX C - RADIATED EMISSION (30 MHZ TO 1000 MHZ)

Test Mode: TX 2441 MHz _CH39_1Mbps_Adapter: Huntkey

Vertical

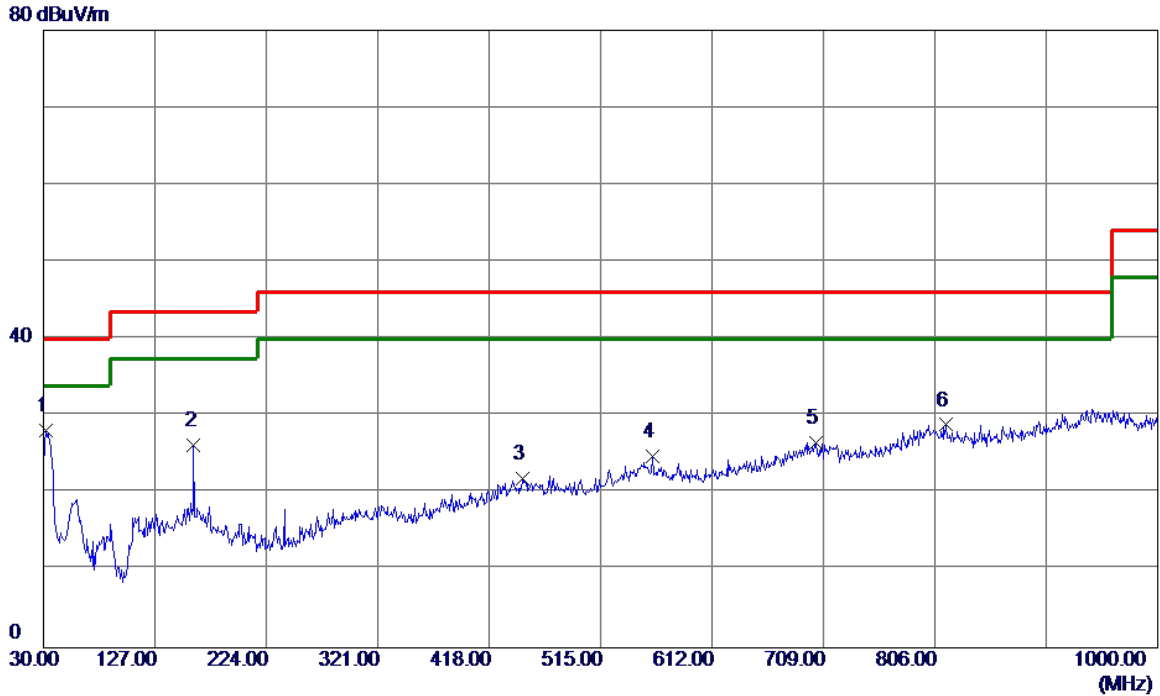

No.	Freq. MHz	Reading Level dBuV/m	Correct Factor dB	Measure ment dBuV/m	Limit dBuV/m	Margin dB	Detector	Comment
1 *	32.4250	43.20	-14.99	28.21	40.00	-11.79	Peak	
2	160.9500	36.97	-10.66	26.31	43.50	-17.19	Peak	
3	447.1000	29.47	-7.52	21.95	46.00	-24.05	Peak	
4	560.1050	30.50	-5.63	24.87	46.00	-21.13	Peak	
5	702.6950	29.43	-2.82	26.61	46.00	-19.39	Peak	
6	815.7000	30.17	-1.29	28.88	46.00	-17.12	Peak	

Test Mode: TX 2441 MHz _CH39_1Mbps_Adapter: Huntkey

Horizontal

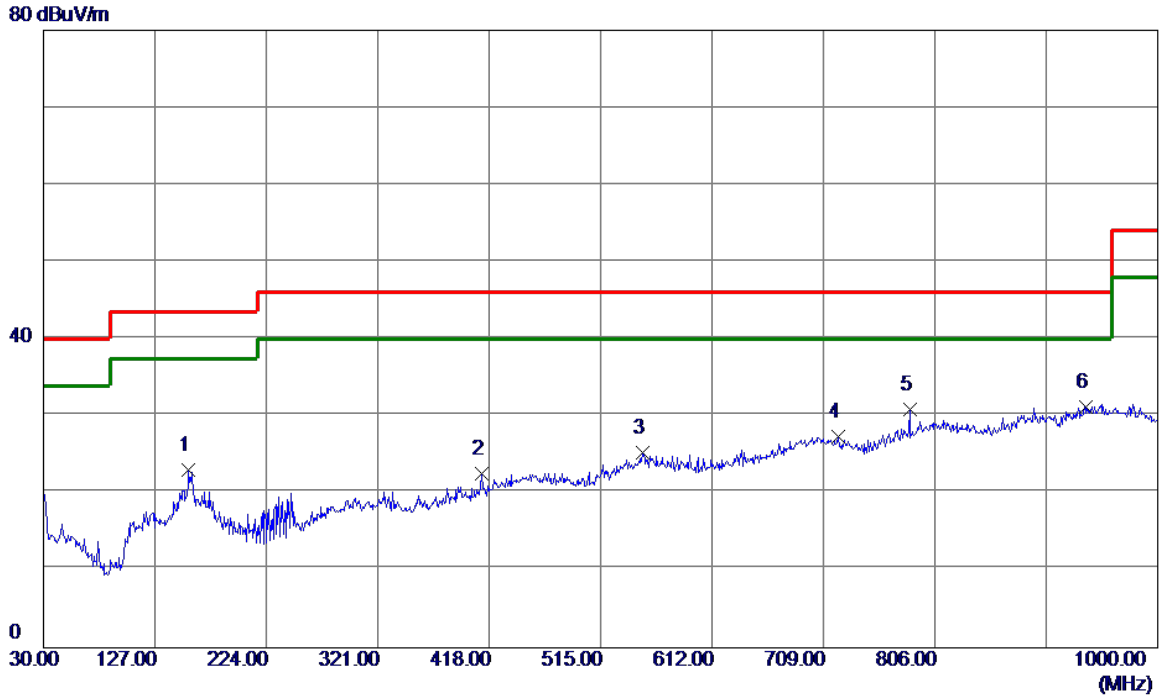

No.	Freq. MHz	Reading Level dBuV/m	Correct Factor dB	Measure ment dBuV/m	Limit dBuV/m	Margin dB	Detector	Comment
1	156.1000	33.93	-10.95	22.98	43.50	-20.52	Peak	
2	411.2100	31.43	-8.94	22.49	46.00	-23.51	Peak	
3	551.8600	30.84	-5.49	25.35	46.00	-20.65	Peak	
4	721.6100	30.67	-3.31	27.36	46.00	-18.64	Peak	
5	784.1750	32.90	-1.99	30.91	46.00	-15.09	Peak	
6 *	936.9500	30.38	0.89	31.27	46.00	-14.73	Peak	

Test Mode: TX 2441 MHz_CH39_1Mbps_Adapter: PHITEK

Vertical

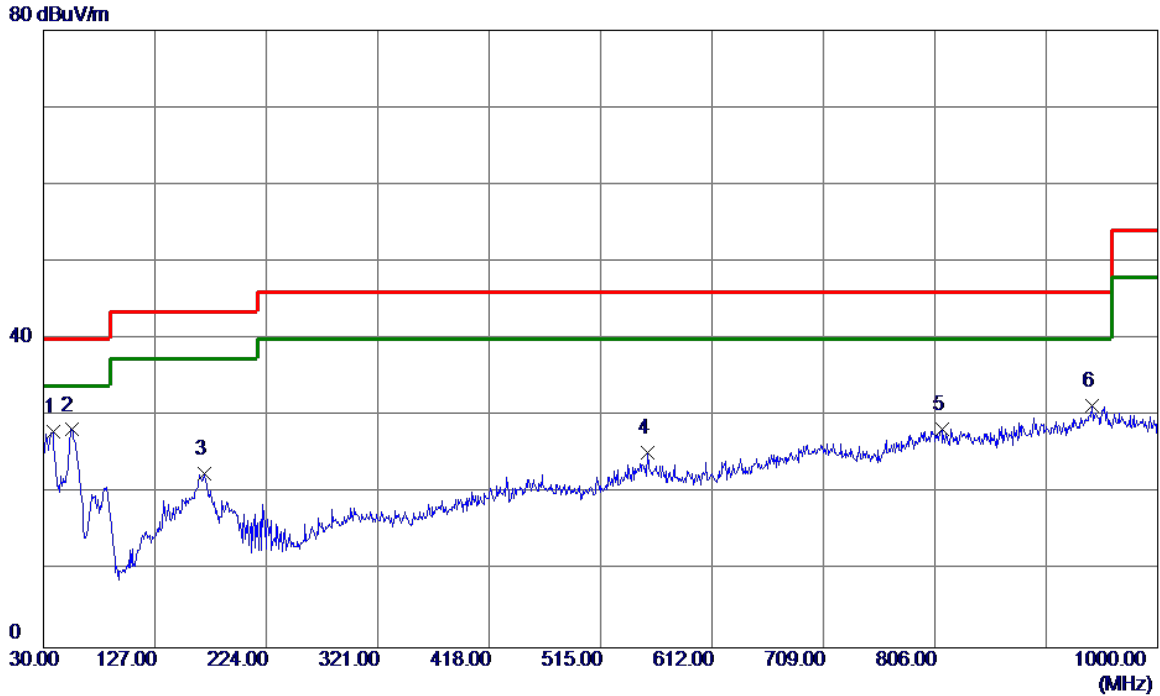

No.	Freq. MHz	Reading Level dBuV/m	Correct Factor dB	Measure ment dBuV/m	Limit dBuV/m	Margin dB	Detector	Comment
1	38.2450	42.63	-14.66	27.97	40.00	-12.03	Peak	
2 *	54.2500	43.20	-14.96	28.24	40.00	-11.76	Peak	
3	169.6799	33.71	-11.18	22.53	43.50	-20.97	Peak	
4	556.2250	30.91	-5.57	25.34	46.00	-20.66	Peak	
5	812.3050	29.57	-1.23	28.34	46.00	-17.66	Peak	
6	942.7700	30.23	1.12	31.35	46.00	-14.65	Peak	

Test Mode: TX 2441 MHz_CH39_1Mbps_Adapter: PHITEK

Horizontal

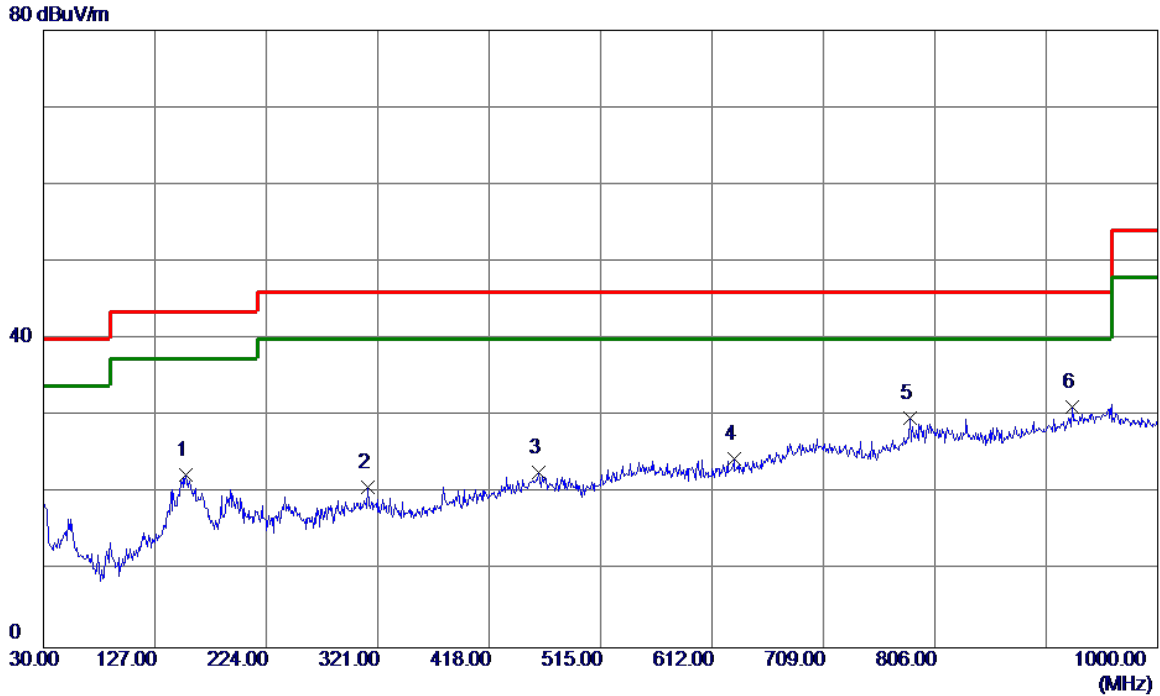

No.	Freq. MHz	Reading Level dBuV/m	Correct Factor dB	Measure ment dBuV/m	Limit dBuV/m	Margin dB	Detector	Comment
1	153.6750	33.51	-11.17	22.34	43.50	-21.16	Peak	
2	312.2700	31.31	-10.54	20.77	46.00	-25.23	Peak	
3	460.6800	30.31	-7.64	22.67	46.00	-23.33	Peak	
4	630.9150	30.11	-5.60	24.51	46.00	-21.49	Peak	
5	784.1750	31.79	-1.99	29.80	46.00	-16.20	Peak	
6 *	925.3100	30.82	0.42	31.24	46.00	-14.76	Peak	

Test Mode: TX 2441 MHz_CH39_1Mbps_Adapter: BYD

Vertical

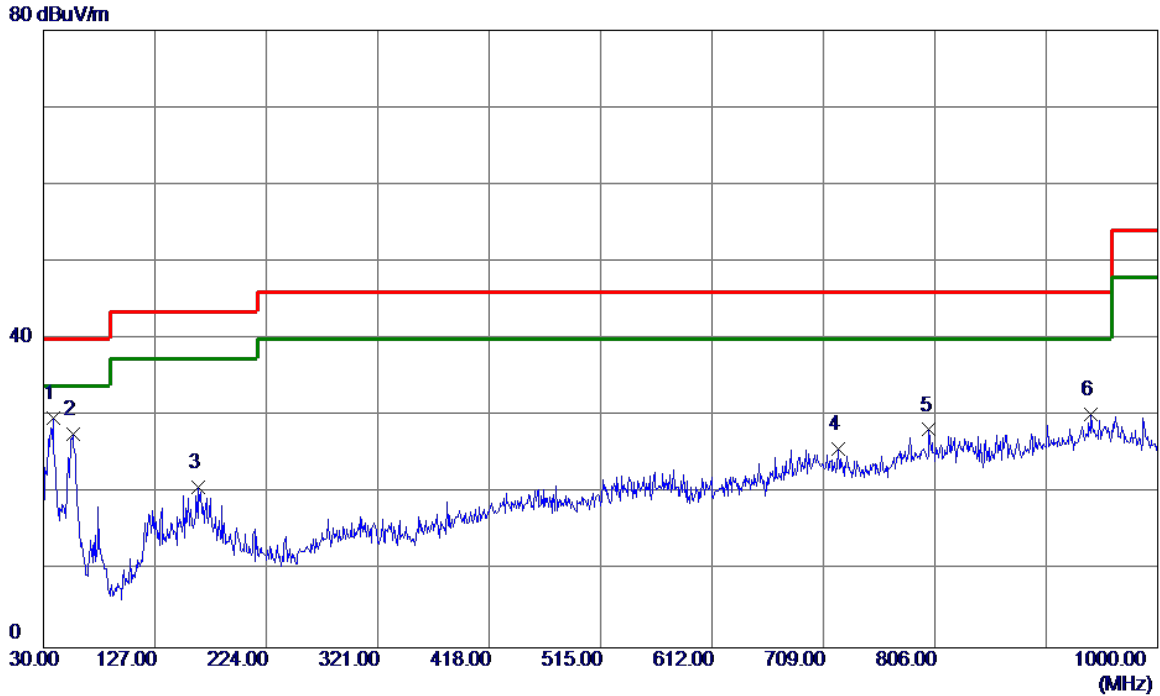

No.	Freq. MHz	Reading Level dBuV/m	Correct Factor dB	Measure ment dBuV/m	Limit dBuV/m	Margin dB	Detector	Comment
1 *	38.2450	44.47	-14.66	29.81	40.00	-10.19	Peak	
2	55.7050	42.67	-15.02	27.65	40.00	-12.35	Peak	
3	164.8300	31.69	-10.89	20.80	43.50	-22.70	Peak	
4	721.6100	29.08	-3.31	25.77	46.00	-20.23	Peak	
5	801.1500	29.30	-1.06	28.24	46.00	-17.76	Peak	
6	941.8000	29.15	1.08	30.23	46.00	-15.77	Peak	

Test Mode: TX 2441 MHz_CH39_1Mbps_Adapter: BYD

Horizontal

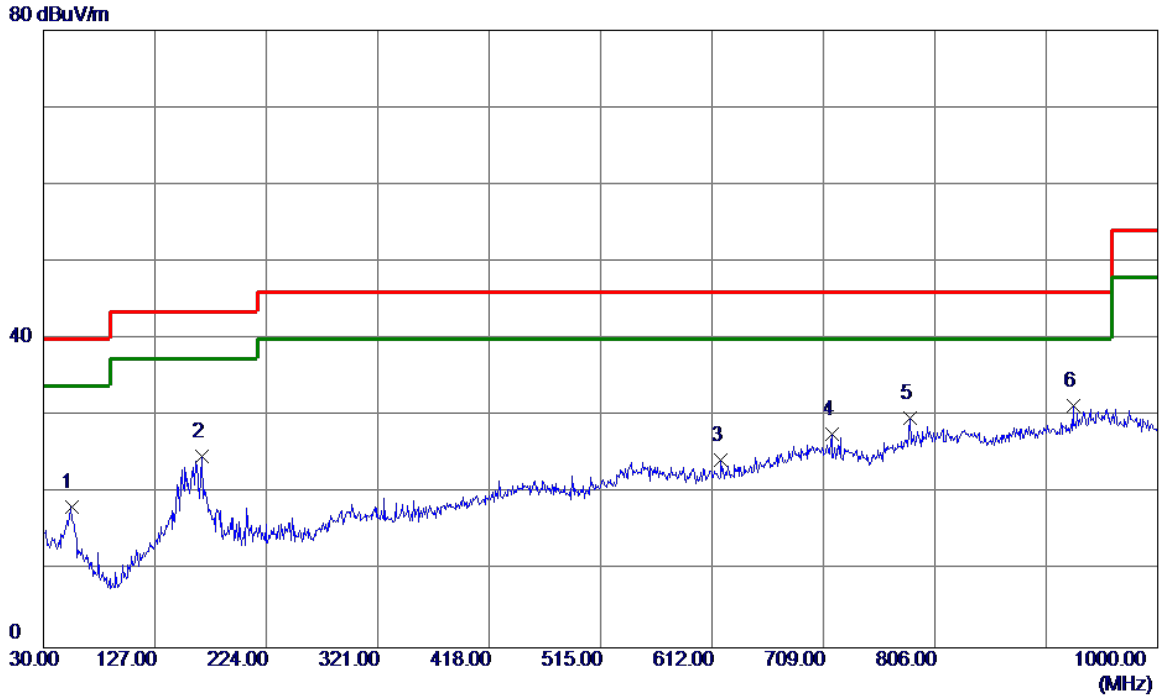

No.	Freq. MHz	Reading Level dBuV/m	Correct Factor dB	Measure ment dBuV/m	Limit dBuV/m	Margin dB	Detector	Comment
1	54.2500	33.22	-14.96	18.26	40.00	-21.74	Peak	
2	167.7400	35.92	-11.06	24.86	43.50	-18.64	Peak	
3	619.7600	30.16	-5.85	24.31	46.00	-21.69	Peak	
4	716.2750	30.91	-3.17	27.74	46.00	-18.26	Peak	
5	784.1750	31.71	-1.99	29.72	46.00	-16.28	Peak	
6 *	926.7650	30.81	0.48	31.29	46.00	-14.71	Peak	

APPENDIX D - RADIATED EMISSION (ABOVE 1000 MHZ)

Test Mode: TX 2402 MHz _CH00_1Mbps

Vertical

130 dBuV/m

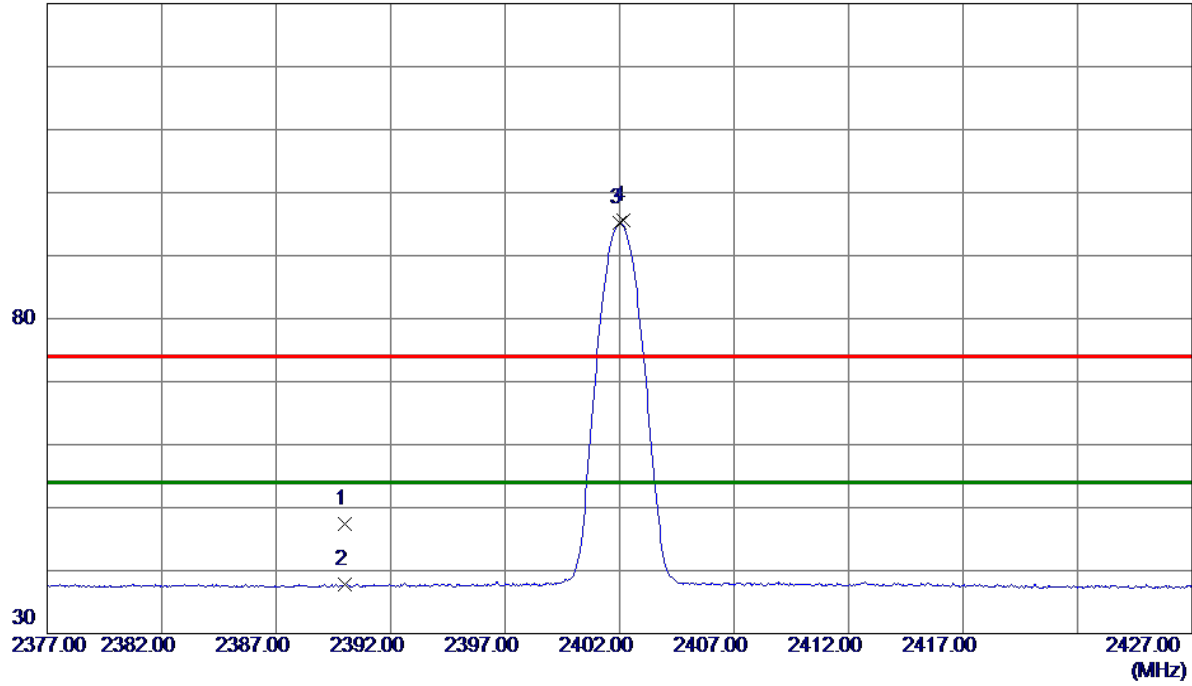

No.	Freq. MHz	Reading Level dBuV/m	Correct Factor dB	Measure ment dBuV/m	Limit dBuV/m	Margin dB	Detector	Comment
1	2390.0000	40.00	7.39	47.39	74.00	-26.61	Peak	
2	2390.0000	30.45	7.39	37.84	54.00	-16.16	AVG	
3 *	2402.0250	87.76	7.38	95.14	54.00	41.14	AVG	No Limit
4	2402.1500	88.15	7.38	95.53	74.00	21.53	Peak	No Limit

Test Mode: TX 2402 MHz _CH00_1Mbps

Horizontal

130 dBuV/m

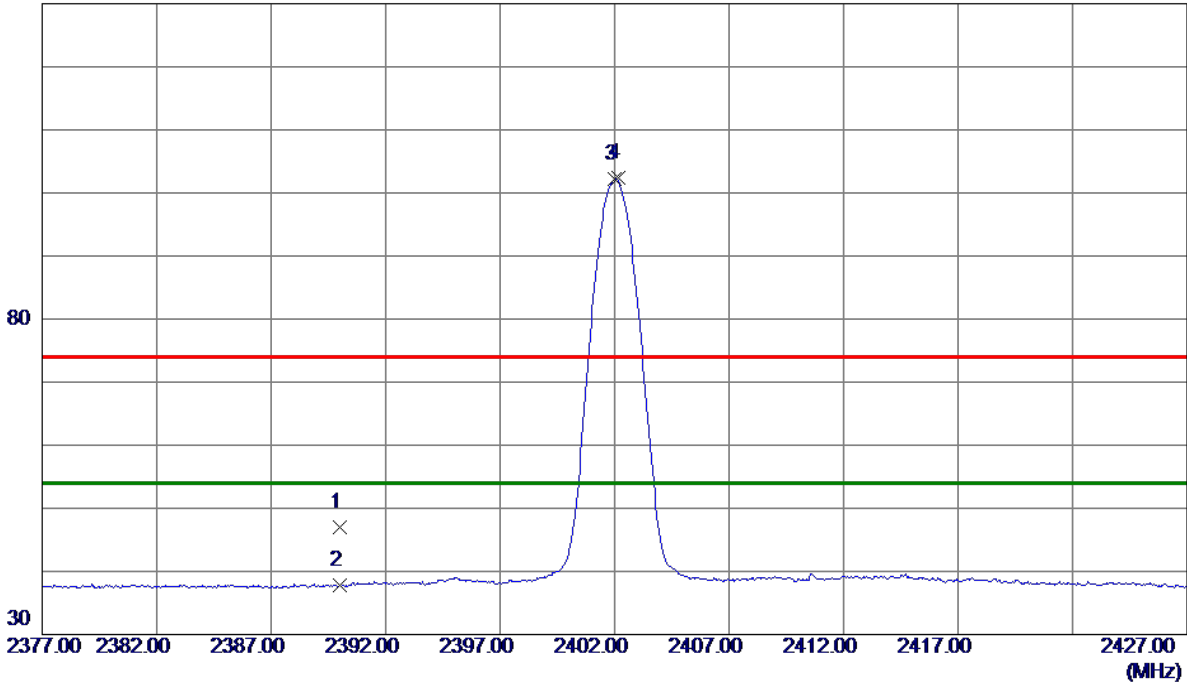

No.	Freq. MHz	Reading Level dBuV/m	Correct Factor dB	Measure ment dBuV/m	Limit dBuV/m	Margin dB	Detector	Comment
1	2390.0000	39.64	7.39	47.03	74.00	-26.97	Peak	
2	2390.0000	30.32	7.39	37.71	54.00	-16.29	AVG	
3 *	2402.0250	94.88	7.38	102.26	54.00	48.26	AVG	No Limit
4	2402.1500	95.11	7.38	102.49	74.00	28.49	Peak	No Limit

Test Mode: TX 2441 MHz _CH39_1Mbps

Vertical

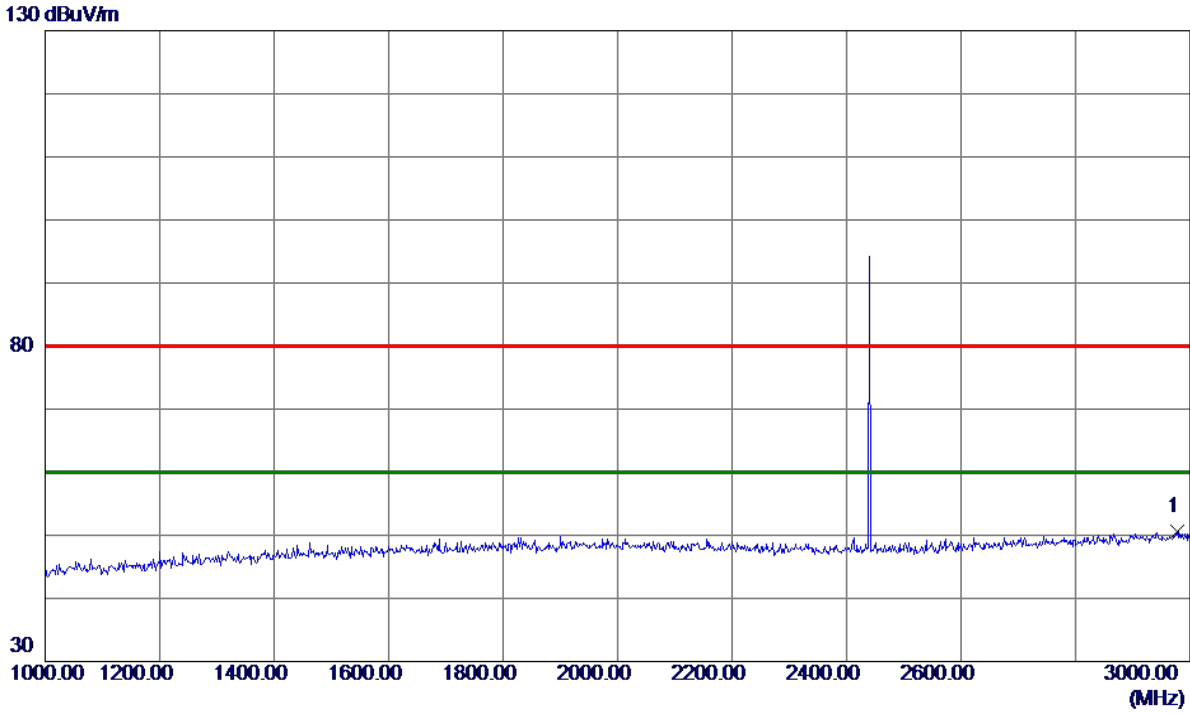

No.	Freq.	Reading Level	Correct Factor	Measurement	Limit	Margin	Detector	Comment
	MHz	dBuV/m	dB	dBuV/m	dBuV/m	dB		
1 *	2977.0000	40.42	10.22	50.64	80.00	-29.36	Peak	

Test Mode: TX 2441 MHz _CH39_1Mbps

Vertical

130 dBuV/m

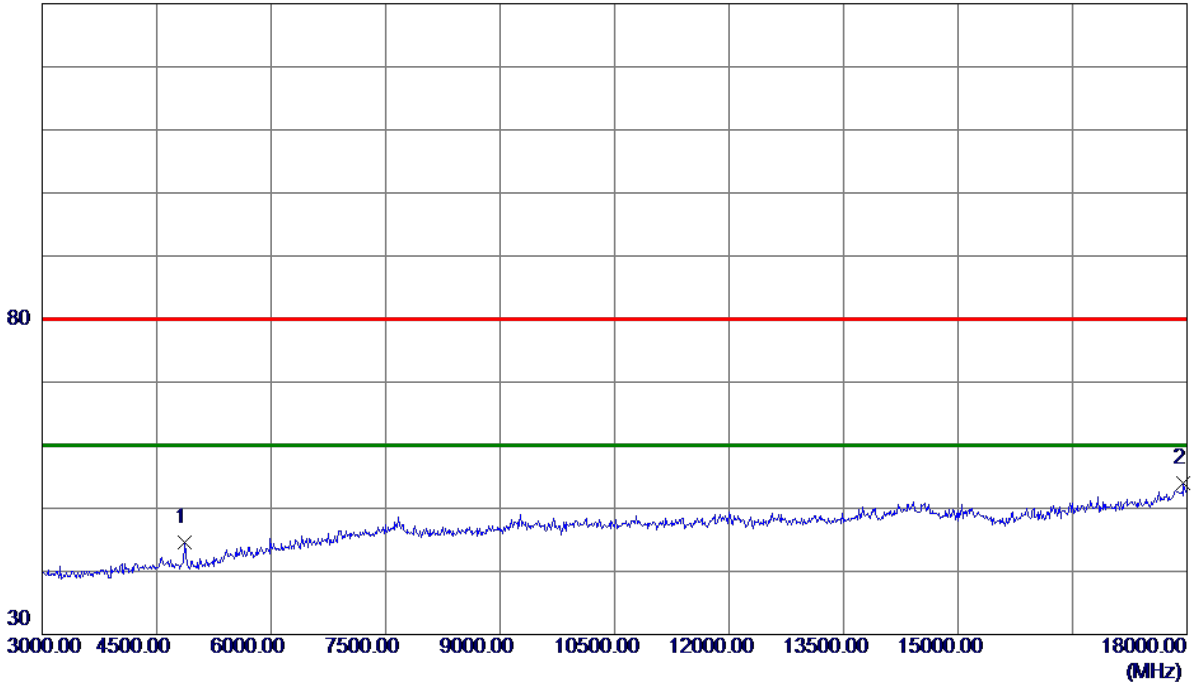

No.	Freq. MHz	Reading Level dBuV/m	Correct Factor dB	Measure ment dBuV/m	Limit dBuV/m	Margin dB	Detector	Comment
1	4867.5000	40.97	3.60	44.57	80.00	-35.43	Peak	
2 *	17955.0000	36.44	17.63	54.07	80.00	-25.93	Peak	

Test Mode: TX 2441 MHz _CH39_1Mbps

Vertical

130 dBuV/m

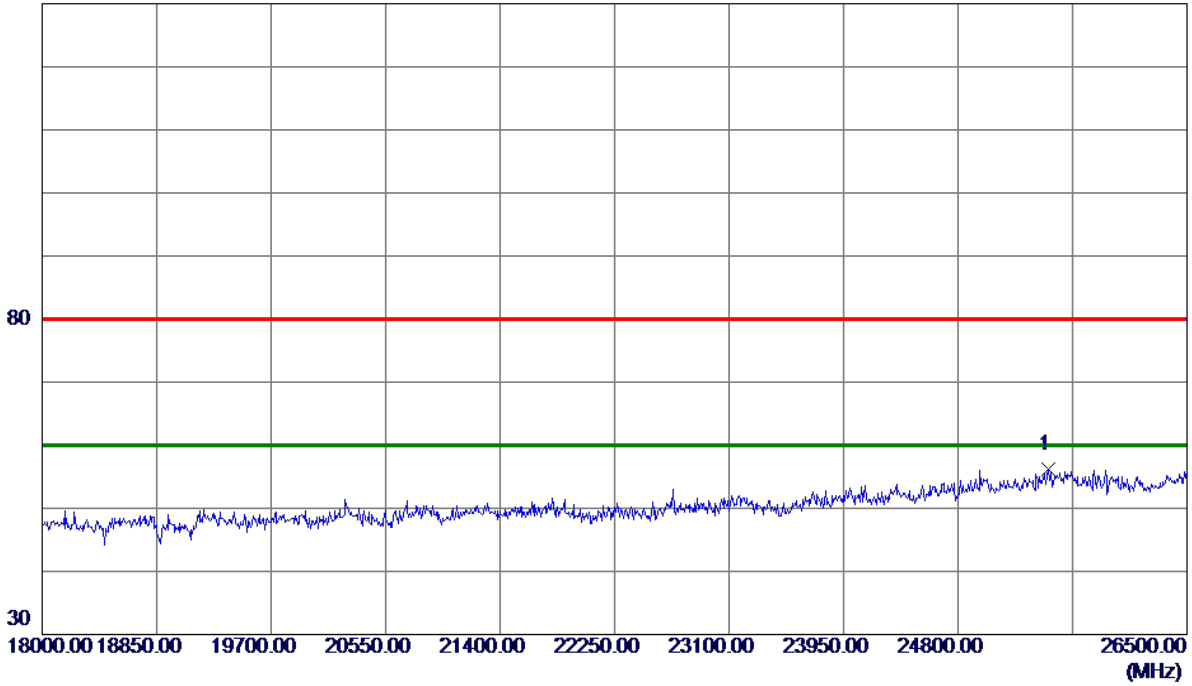

No.	Freq. MHz	Reading Level dBuV/m	Correct Factor dB	Measure ment dBuV/m	Limit dBuV/m	Margin dB	Detector	Comment
1 *	25467.2500	38.88	17.31	56.19	80.00	-23.81	Peak	

Test Mode: TX 2441 MHz _CH39_1Mbps

Horizontal

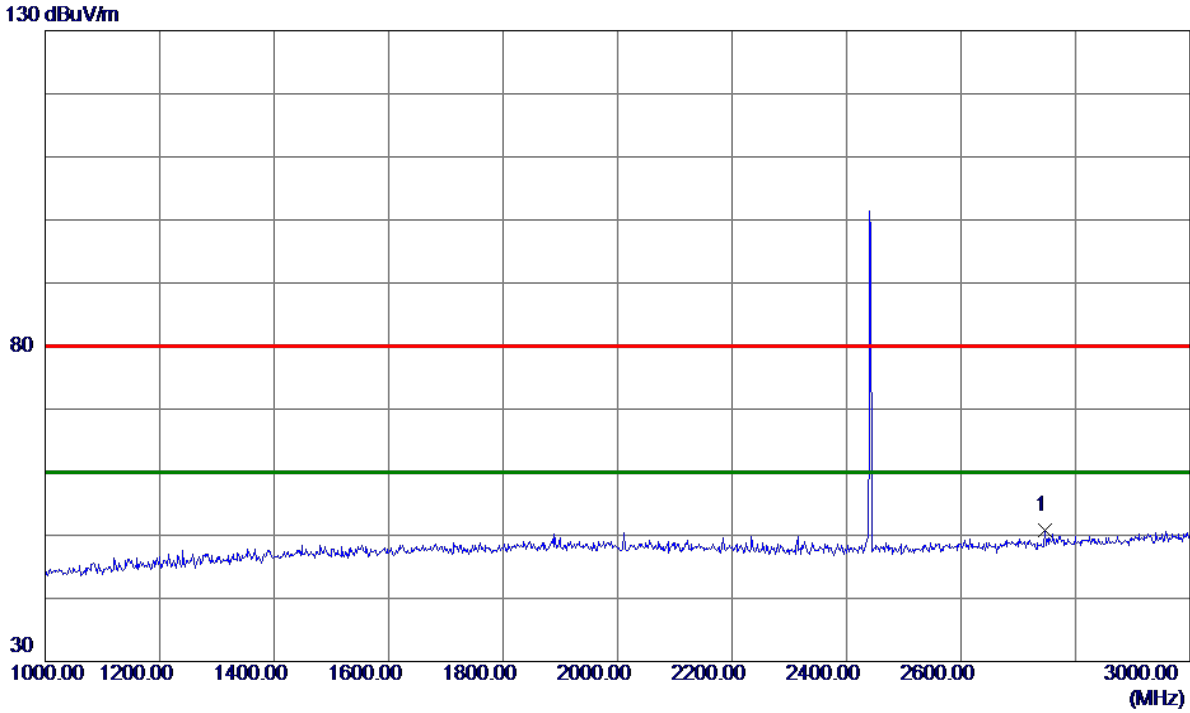

No.	Freq. MHz	Reading Level dBuV/m	Correct Factor dB	Measure ment dBuV/m	Limit dBuV/m	Margin dB	Detector	Comment
1 *	2746.0000	41.99	8.81	50.80	80.00	-29.20	Peak	

Test Mode: TX 2441 MHz _CH39_1Mbps

Horizontal

130 dBuV/m

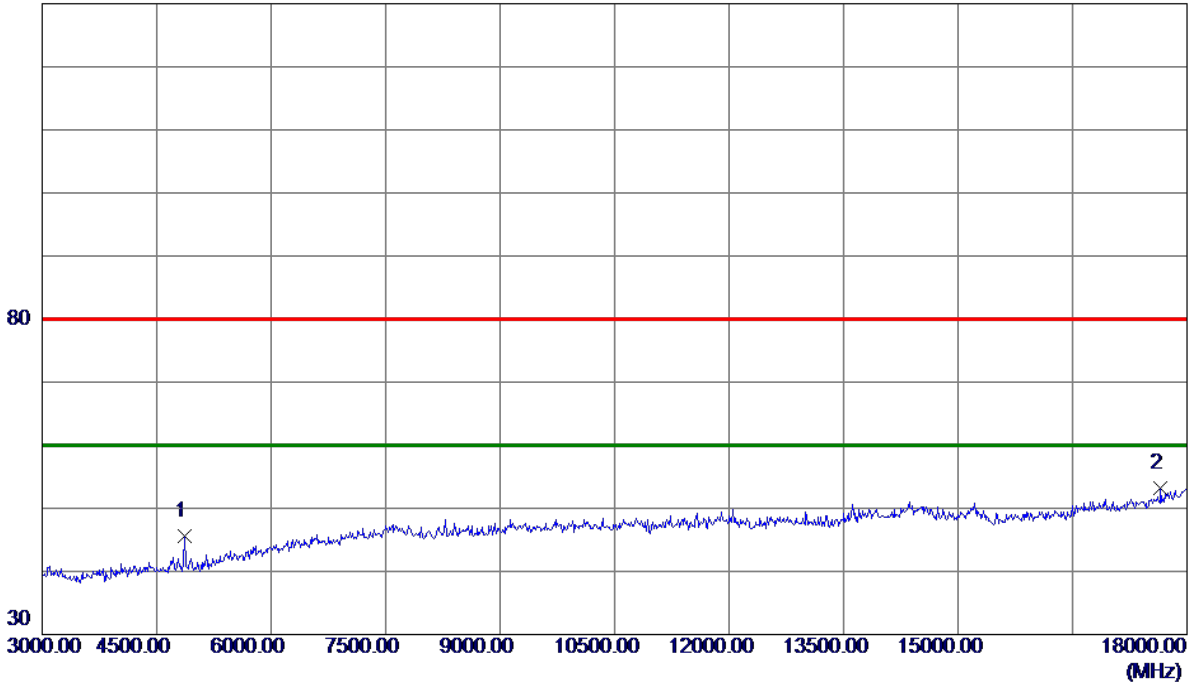

No.	Freq. MHz	Reading Level dBuV/m	Correct Factor dB	Measure ment dBuV/m	Limit dBuV/m	Margin dB	Detector	Comment
1	4867.5000	42.00	3.60	45.60	80.00	-34.40	Peak	
2 *	17655.0000	36.40	16.72	53.12	80.00	-26.88	Peak	

Test Mode: TX 2441 MHz _CH39_1Mbps

Horizontal

130 dBuV/m

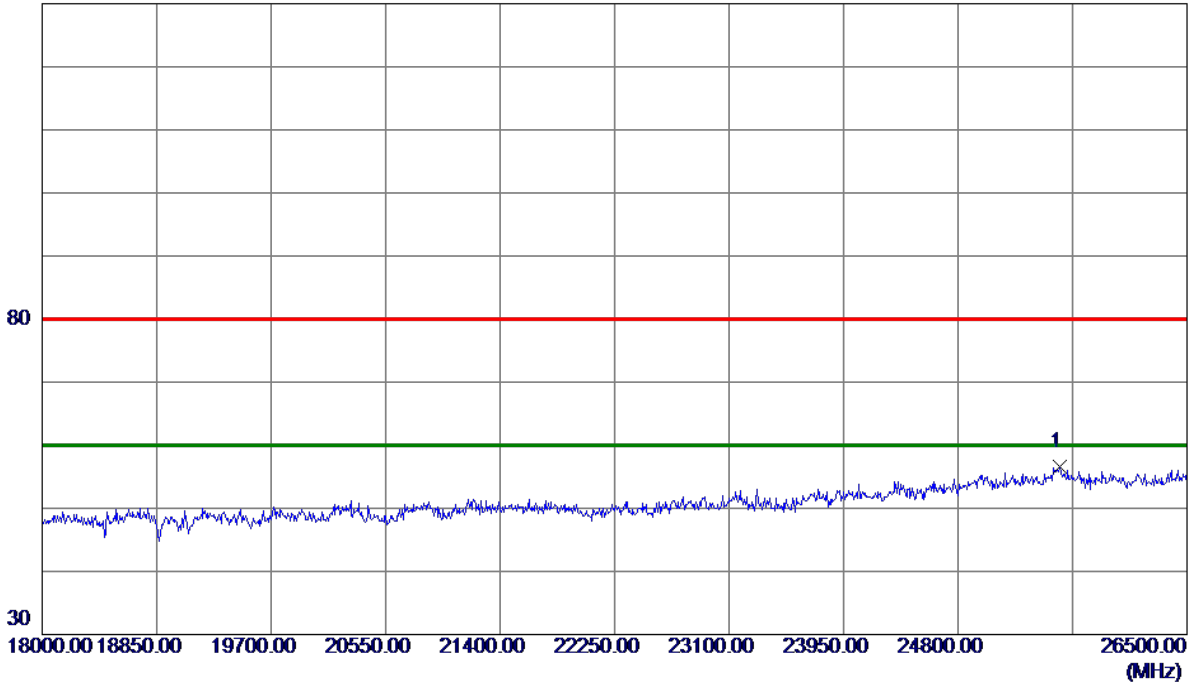

No.	Freq. MHz	Reading Level dBuV/m	Correct Factor dB	Measure ment dBuV/m	Limit dBuV/m	Margin dB	Detector	Comment
1 *	25556.5000	39.31	17.26	56.57	80.00	-23.43	Peak	

Test Mode: TX 2480 MHz _CH78_1Mbps

Vertical

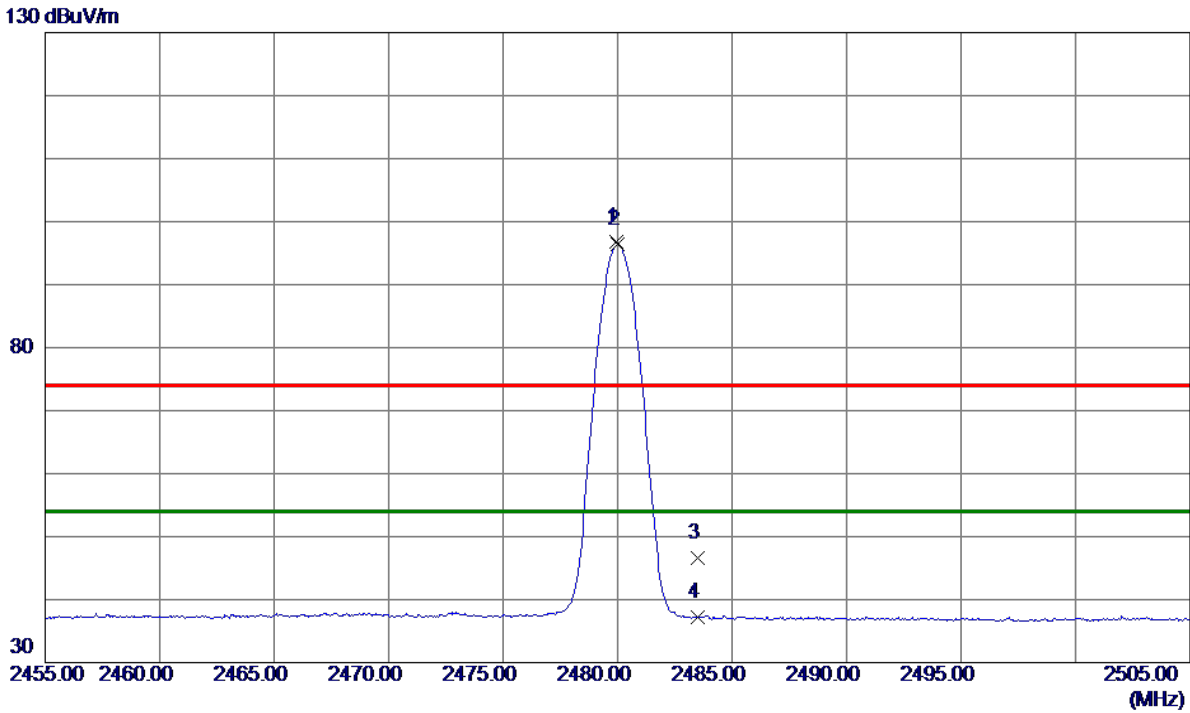

No.	Freq. MHz	Reading Level dBuV/m	Correct Factor dB	Measure ment dBuV/m	Limit dBuV/m	Margin dB	Detector	Comment
1	2479.9250	89.56	7.32	96.88	74.00	22.88	Peak	No Limit
2 *	2480.0000	89.10	7.32	96.42	54.00	42.42	AVG	No Limit
3	2483.5000	39.32	7.32	46.64	74.00	-27.36	Peak	
4	2483.5000	29.83	7.32	37.15	54.00	-16.85	AVG	

Test Mode: TX 2480 MHz _CH78_1Mbps

Horizontal

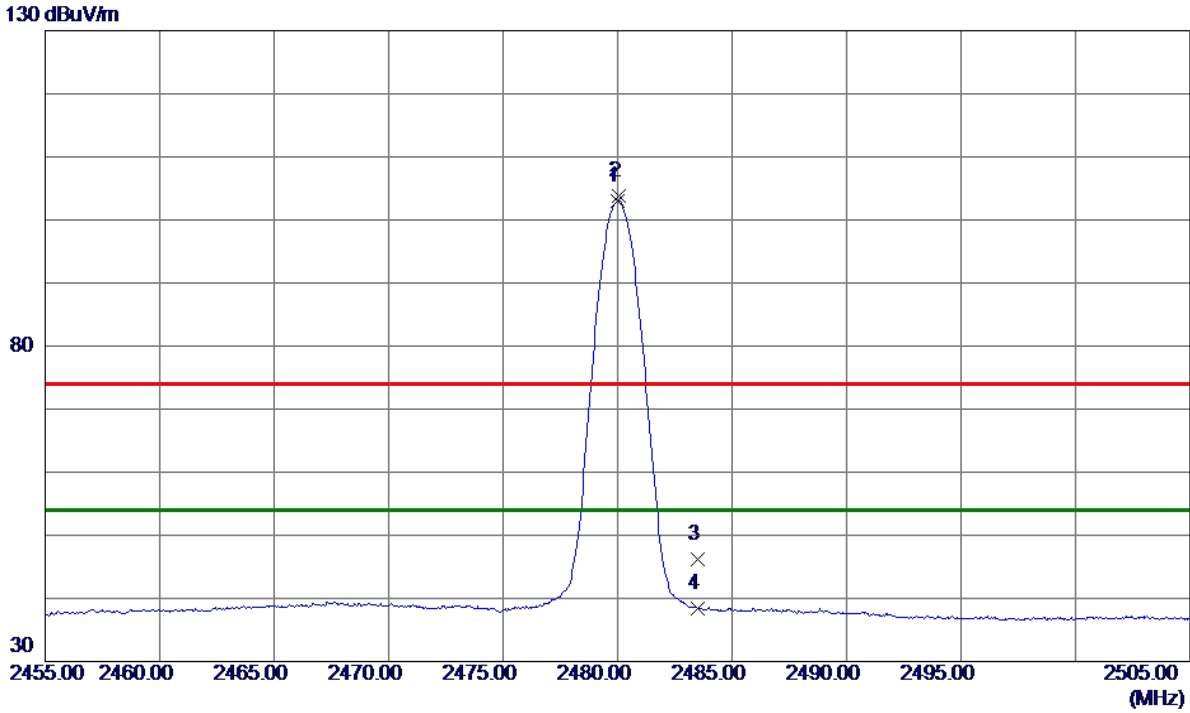

No.	Freq. MHz	Reading Level dBuV/m	Correct Factor dB	Measure ment dBuV/m	Limit dBuV/m	Margin dB	Detector	Comment
1 *	2480.0250	95.69	7.32	103.01	54.00	49.01	AVG	No Limit
2	2480.0500	96.44	7.32	103.76	74.00	29.76	Peak	No Limit
3	2483.5000	38.83	7.32	46.15	74.00	-27.85	Peak	
4	2483.5000	31.11	7.32	38.43	54.00	-15.57	AVG	

Test Mode: TX 2402 MHz _CH00_3Mbps

Vertical

130 dBuV/m

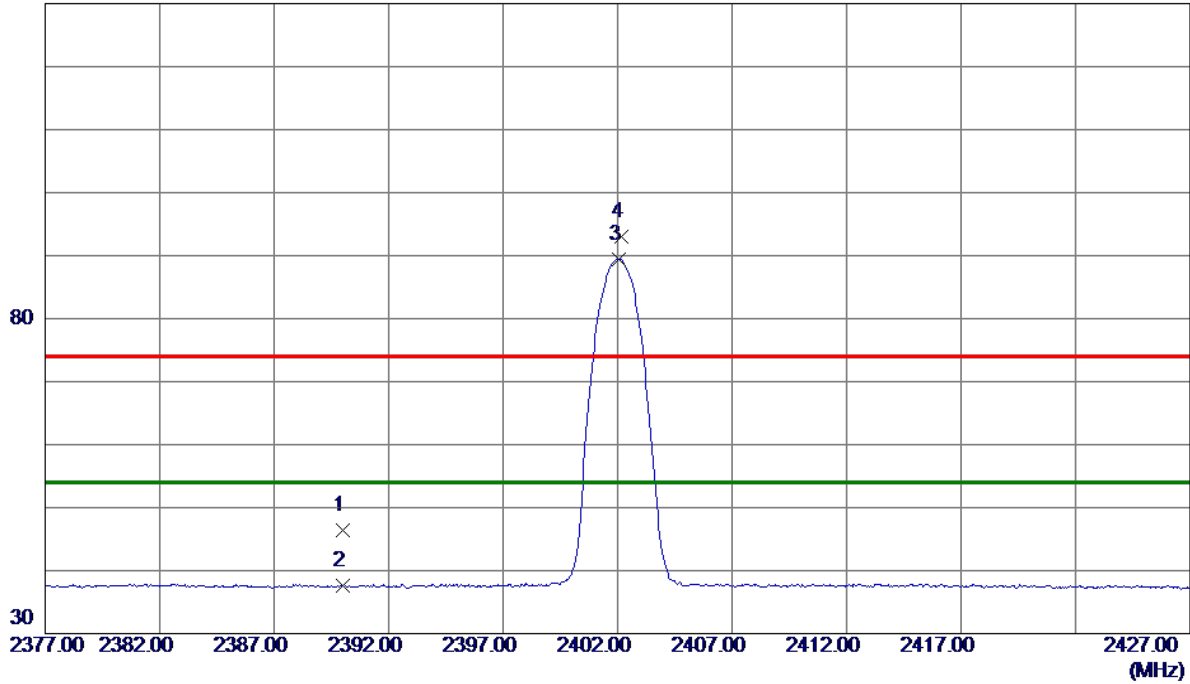

No.	Freq. MHz	Reading Level dBuV/m	Correct Factor dB	Measure ment dBuV/m	Limit dBuV/m	Margin dB	Detector	Comment
1	2390.0000	38.98	7.39	46.37	74.00	-27.63	Peak	
2	2390.0000	30.19	7.39	37.58	54.00	-16.42	AVG	
3 *	2402.0750	82.06	7.38	89.44	54.00	35.44	AVG	No Limit
4	2402.1500	85.55	7.38	92.93	74.00	18.93	Peak	No Limit

Test Mode: TX 2402 MHz _CH00_3Mbps

Horizontal

130 dBuV/m

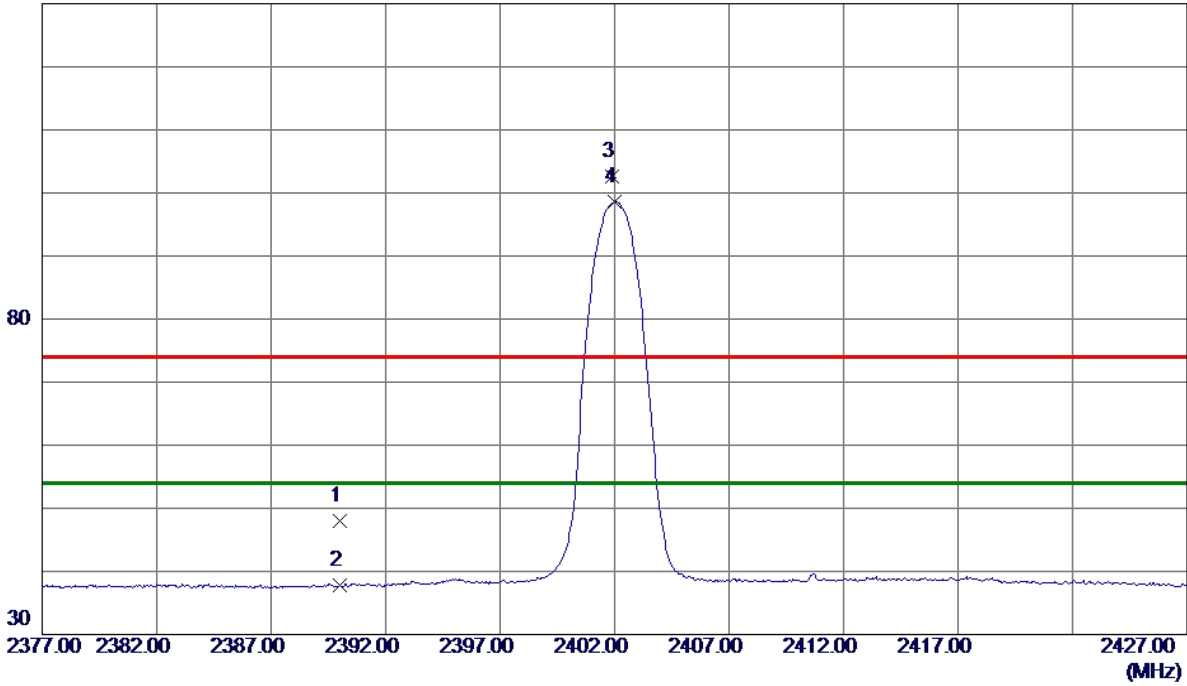

No.	Freq. MHz	Reading Level dBuV/m	Correct Factor dB	Measure ment dBuV/m	Limit dBuV/m	Margin dB	Detector	Comment
1	2390.0000	40.58	7.39	47.97	74.00	-26.03	Peak	
2	2390.0000	30.44	7.39	37.83	54.00	-16.17	AVG	
3	2401.8750	95.31	7.38	102.69	74.00	28.69	Peak	No Limit
4 *	2402.0250	91.20	7.38	98.58	54.00	44.58	AVG	No Limit

Test Mode: TX 2441 MHz _CH39_3Mbps

Vertical

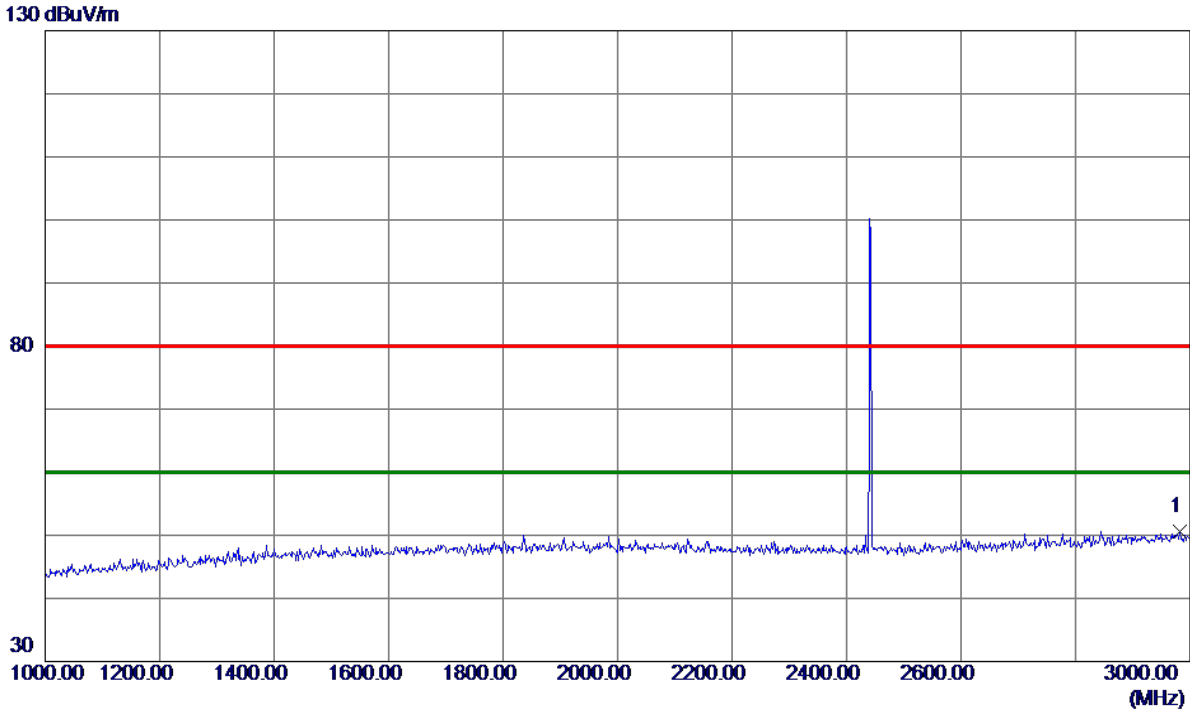

No.	Freq.	Reading Level	Correct Factor	Measurement	Limit	Margin	Detector	Comment
	MHz	dBuV/m	dB	dBuV/m	dBuV/m	dB		
1 *	2982.0000	40.33	10.25	50.58	80.00	-29.42	Peak	

Test Mode: TX 2441 MHz _CH39_3Mbps

Vertical

130 dBuV/m

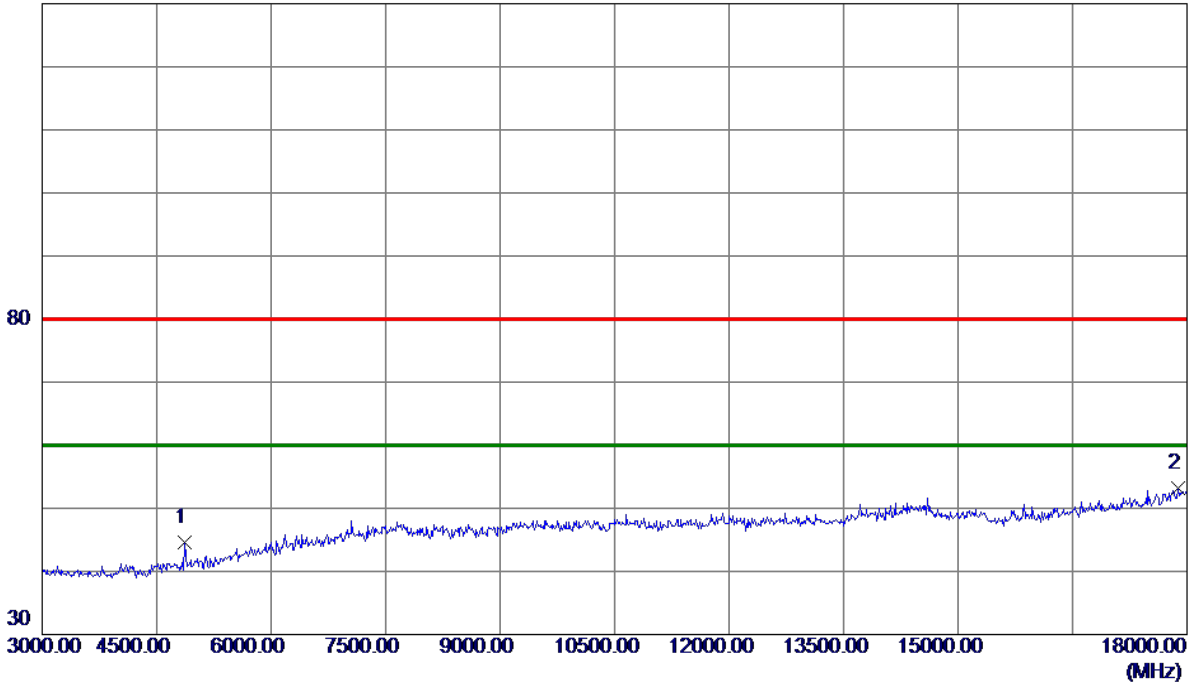

No.	Freq. MHz	Reading Level dBuV/m	Correct Factor dB	Measure ment dBuV/m	Limit dBuV/m	Margin dB	Detector	Comment
1	4867.5000	40.93	3.60	44.53	80.00	-35.47	Peak	
2 *	17880.0000	35.73	17.41	53.14	80.00	-26.86	Peak	

Test Mode: TX 2441 MHz _CH39_3Mbps

Vertical

130 dBuV/m

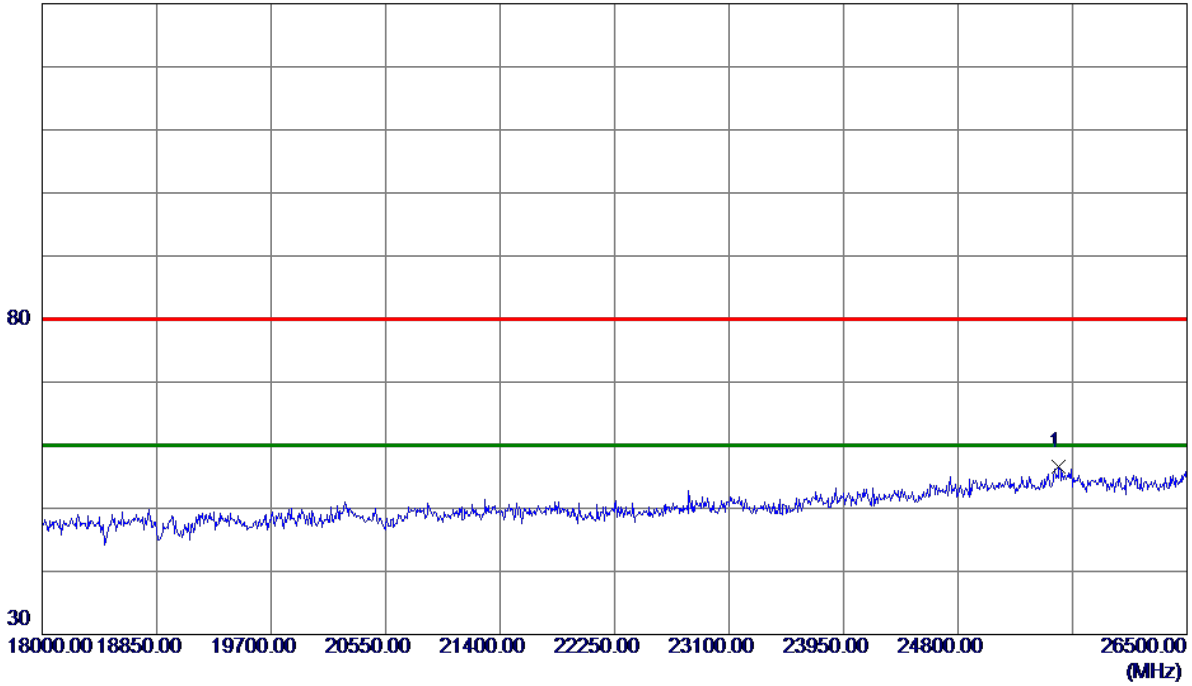

No.	Freq. MHz	Reading Level dBuV/m	Correct Factor dB	Measure ment dBuV/m	Limit dBuV/m	Margin dB	Detector	Comment
1 *	25548.0000	39.28	17.27	56.55	80.00	-23.45	Peak	

Test Mode: TX 2441 MHz _CH39_3Mbps

Horizontal

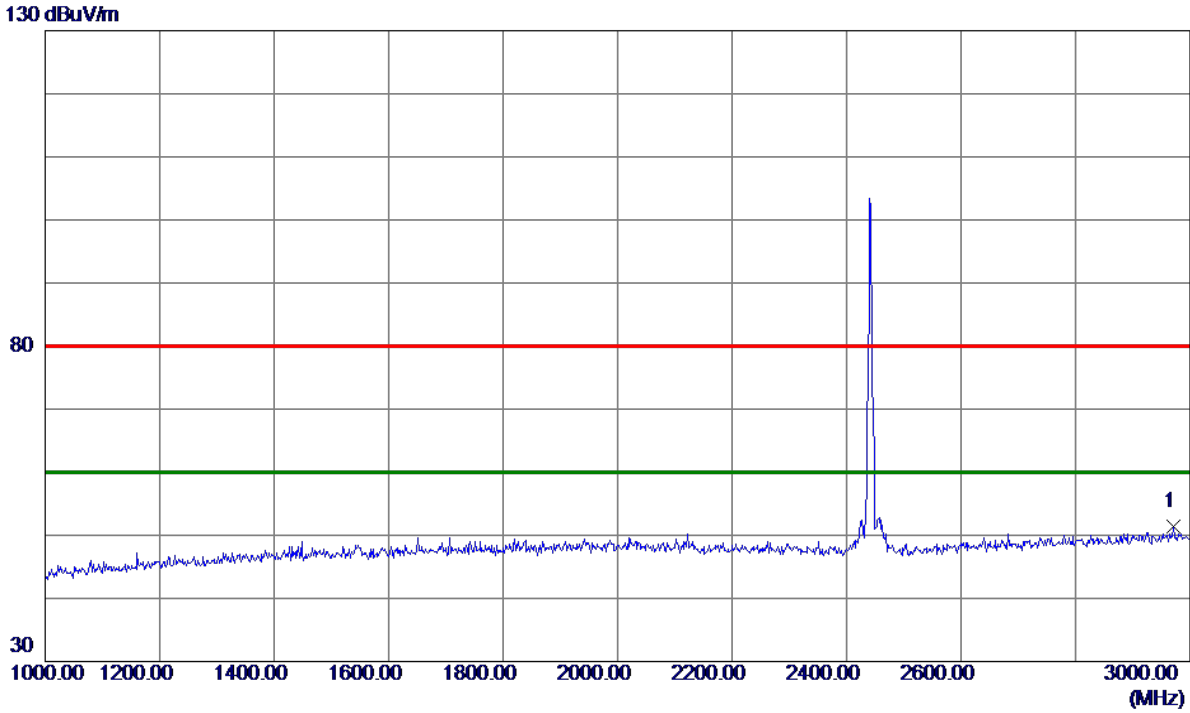

No.	Freq.	Reading Level	Correct Factor	Measurement	Limit	Margin	Detector	Comment
	MHz	dBuV/m	dB	dBuV/m	dBuV/m	dB		
1 *	2971.0000	41.27	10.18	51.45	80.00	-28.55	Peak	

Test Mode: TX 2441 MHz _CH39_3Mbps

Horizontal

130 dBuV/m

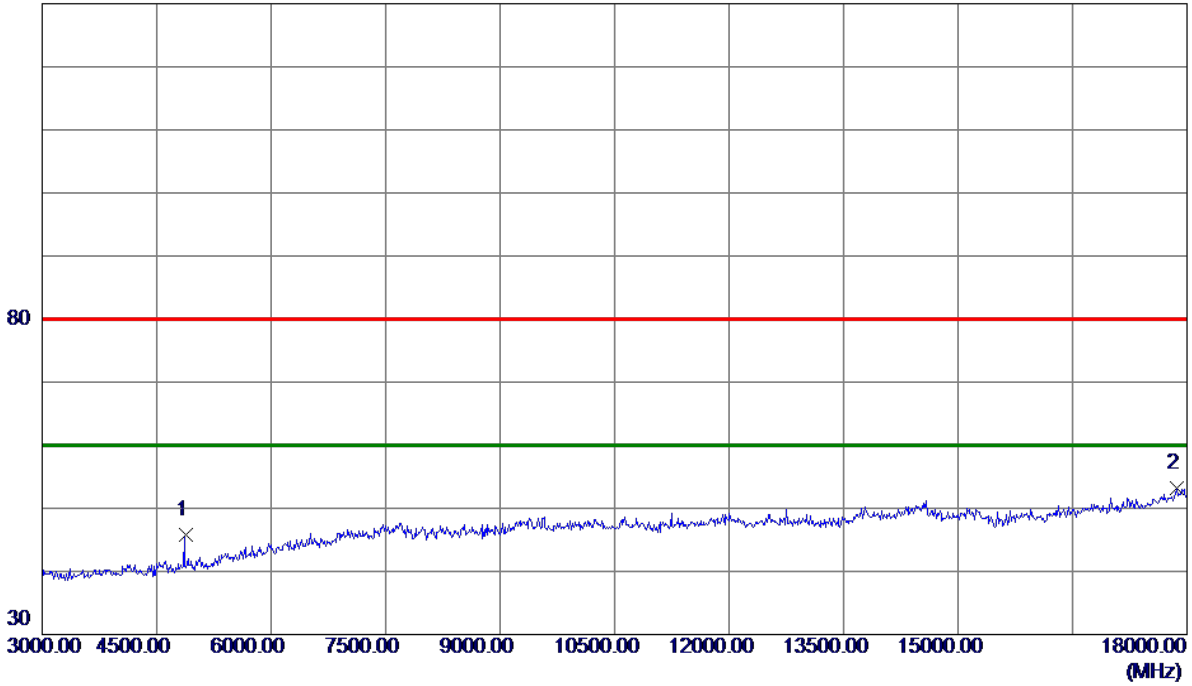

No.	Freq. MHz	Reading Level dBuV/m	Correct Factor dB	Measure ment dBuV/m	Limit dBuV/m	Margin dB	Detector	Comment
1	4882.0019	42.24	3.63	45.87	80.00	-34.13	Peak	
2 *	17872.5000	35.74	17.38	53.12	80.00	-26.88	Peak	

Test Mode: TX 2441 MHz _CH39_3Mbps

Horizontal

130 dBuV/m

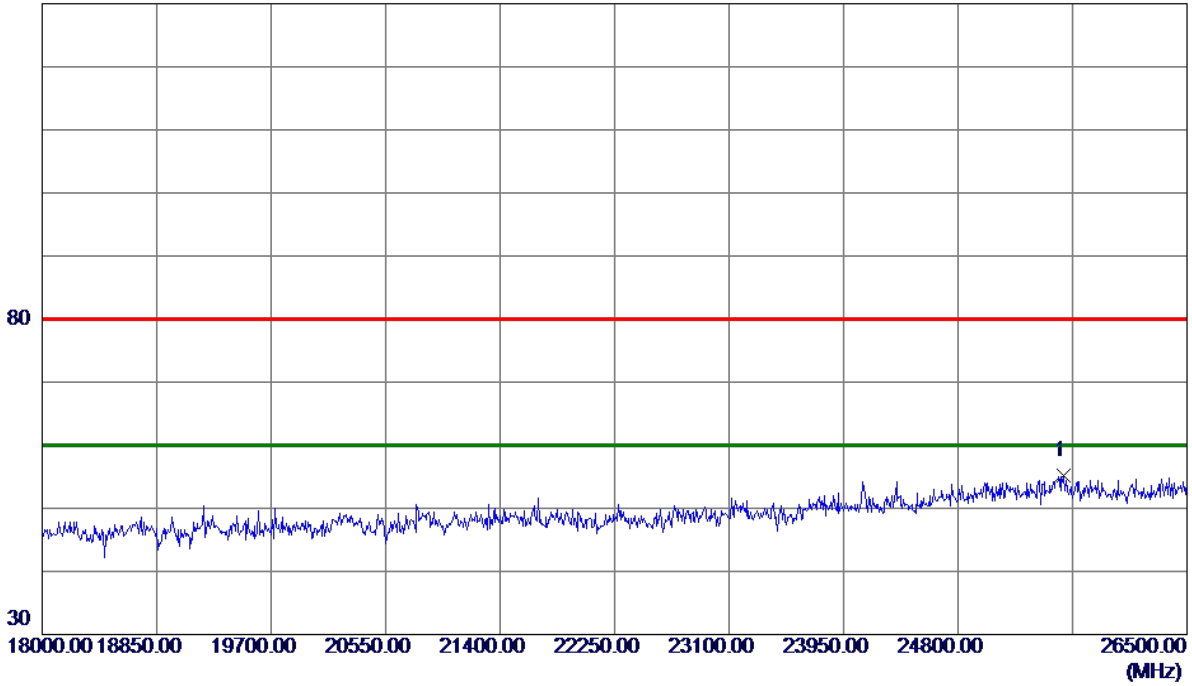

No.	Freq. MHz	Reading Level dBuV/m	Correct Factor dB	Measure ment dBuV/m	Limit dBuV/m	Margin dB	Detector	Comment
1 *	25586.2500	37.93	17.23	55.16	80.00	-24.84	Peak	

Test Mode: TX 2480 MHz _CH78_3Mbps

Vertical

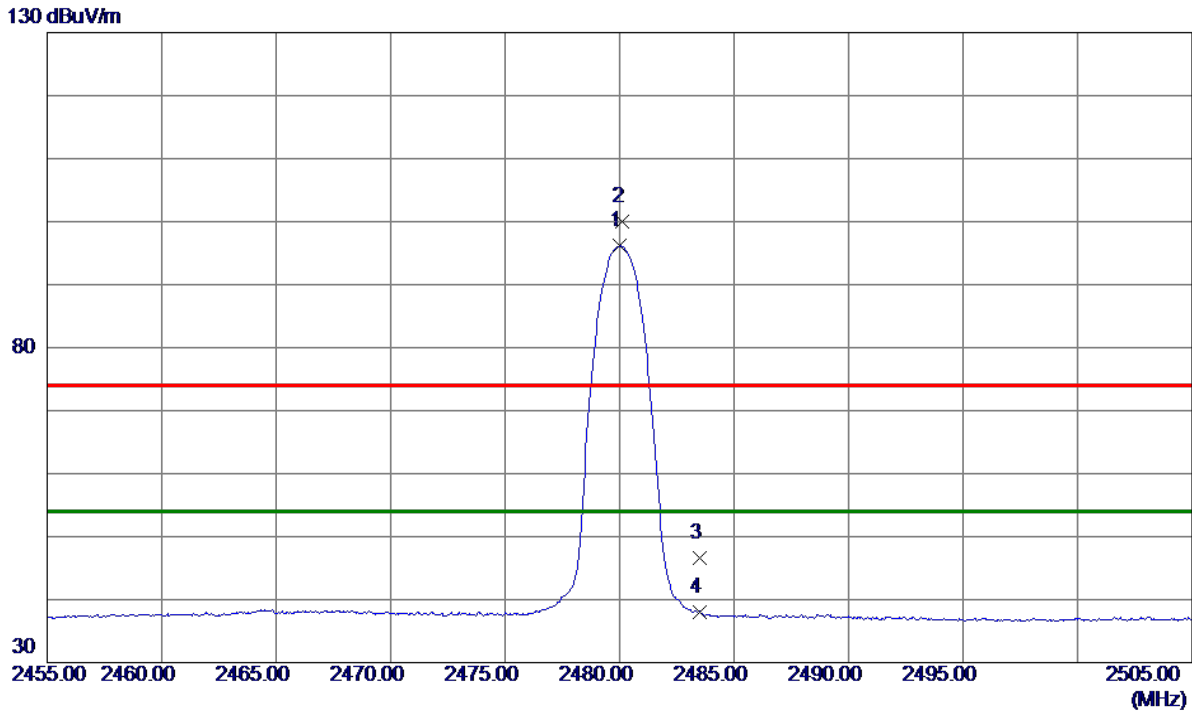

No.	Freq. MHz	Reading Level dBuV/m	Correct Factor dB	Measure ment dBuV/m	Limit dBuV/m	Margin dB	Detector	Comment
1 *	2480.0250	88.80	7.32	96.12	54.00	42.12	AVG	No Limit
2	2480.1000	92.64	7.32	99.96	74.00	25.96	Peak	No Limit
3	2483.5000	39.20	7.32	46.52	74.00	-27.48	Peak	
4	2483.5000	30.76	7.32	38.08	54.00	-15.92	AVG	

Test Mode: TX 2480 MHz _CH78_3Mbps

Horizontal

130 dBuV/m

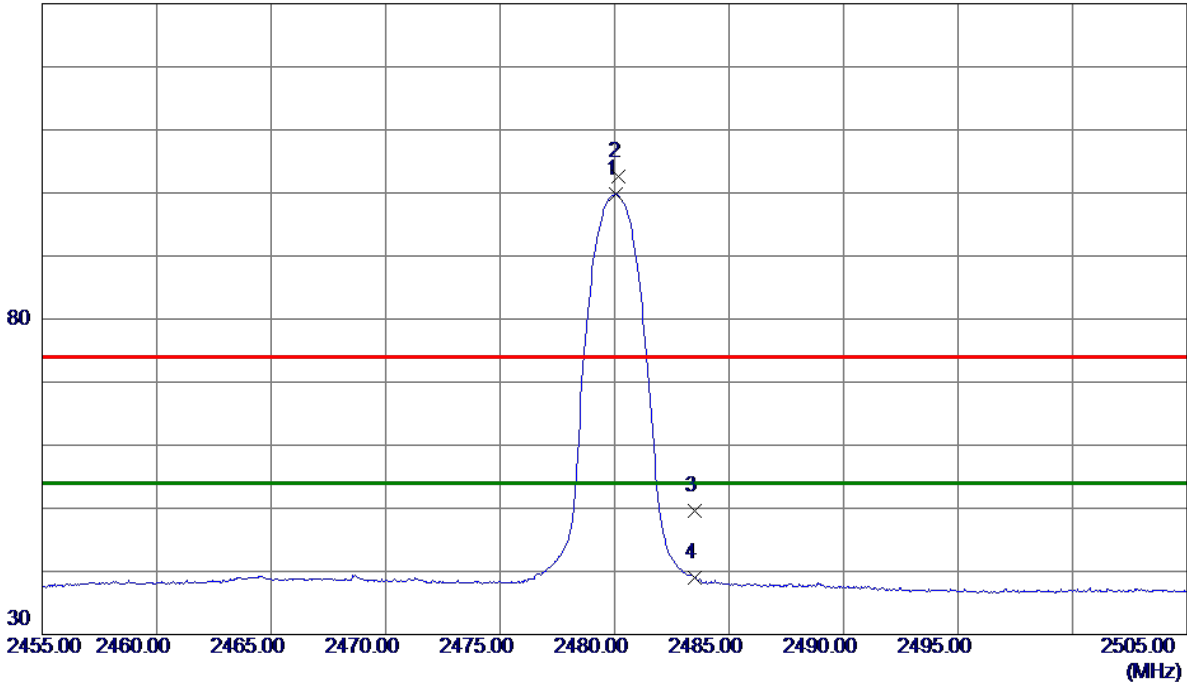

No.	Freq. MHz	Reading Level dBuV/m	Correct Factor dB	Measure ment dBuV/m	Limit dBuV/m	Margin dB	Detector	Comment
1 *	2480.0500	92.48	7.32	99.80	54.00	45.80	AVG	No Limit
2	2480.1750	95.30	7.32	102.62	74.00	28.62	Peak	No Limit
3	2483.5000	42.22	7.32	49.54	74.00	-24.46	Peak	
4	2483.5000	31.61	7.32	38.93	54.00	-15.07	AVG	

APPENDIX E - NUMBER OF HOPPING CHANNEL

Test Mode	Hopping Mode_1Mbps
Number of Hopping Channel	79

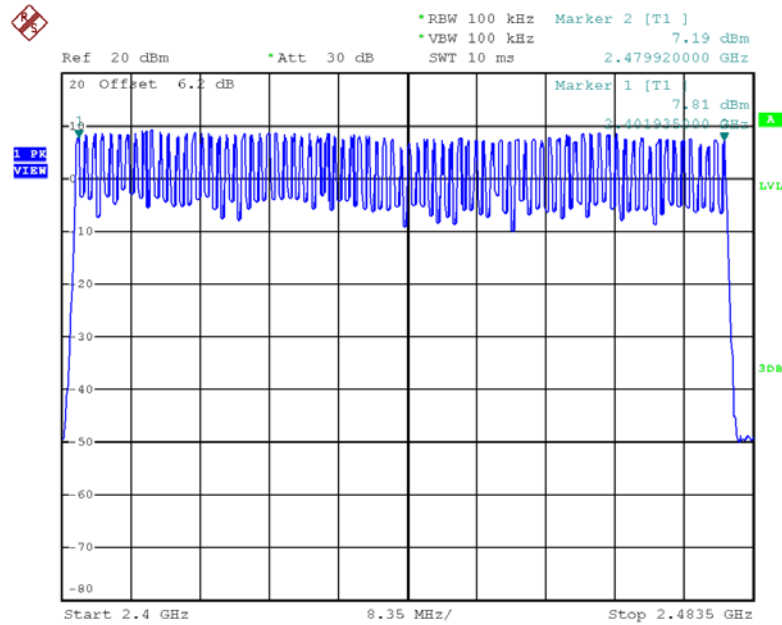

Date: 28.AUG.2018 11:07:51

Test Mode	Hopping Mode_3Mbps
Number of Hopping Channel	79

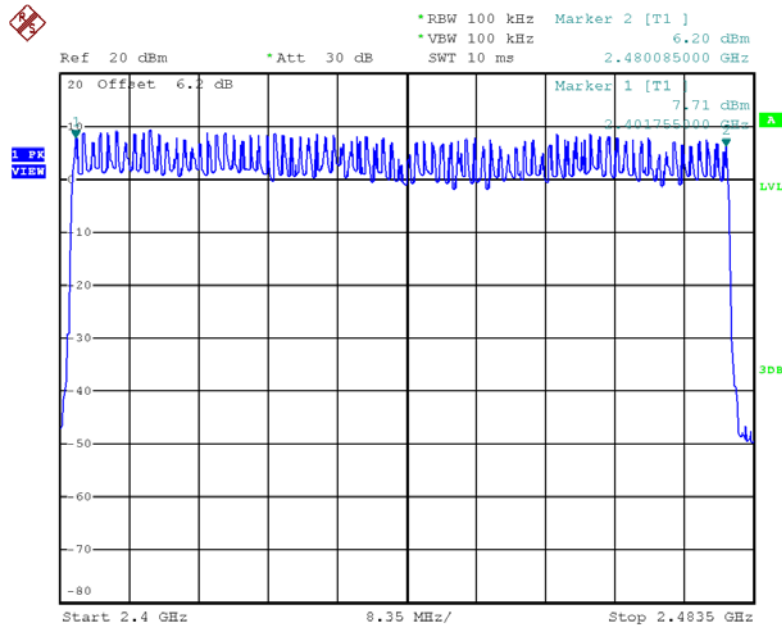

Date: 28.AUG.2018 11:37:17

APPENDIX F - AVERAGE TIME OF OCCUPANCY

Test Mode:	TX Mode_1Mbps
------------	---------------

Data Packet	Frequency (MHz)	Pulse Duration (ms)	Dwell Time (s)	Limits (s)	Test Result
DH5	2402	2.8800	0.3072	0.4000	Pass
DH3	2402	1.6400	0.2624	0.4000	Pass
DH1	2402	0.3700	0.1184	0.4000	Pass
DH5	2441	2.8800	0.3072	0.4000	Pass
DH3	2441	1.6400	0.2624	0.4000	Pass
DH1	2441	0.3700	0.1184	0.4000	Pass
DH5	2480	2.8800	0.3072	0.4000	Pass
DH3	2480	1.6400	0.2624	0.4000	Pass
DH1	2480	0.3750	0.1200	0.4000	Pass

CH00-DH1

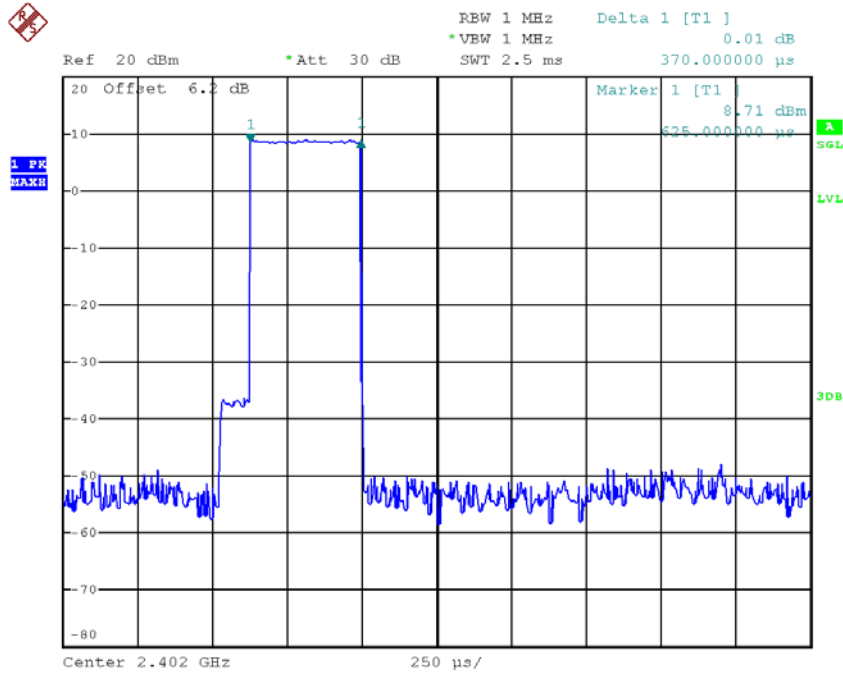

Date: 28.AUG.2018 11:02:06

CH00-DH3

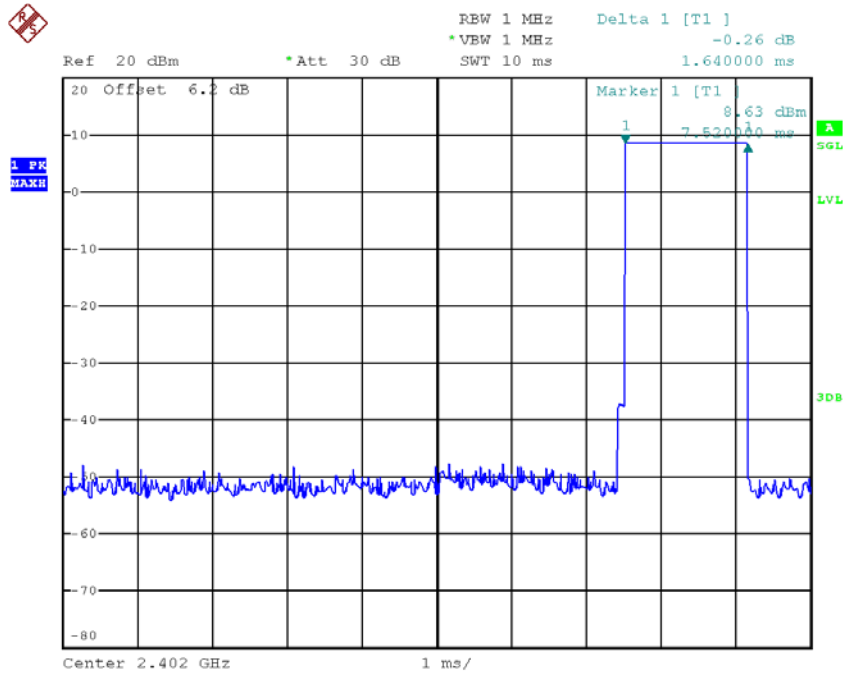

Date: 28.AUG.2018 11:10:38

CH00-DH5

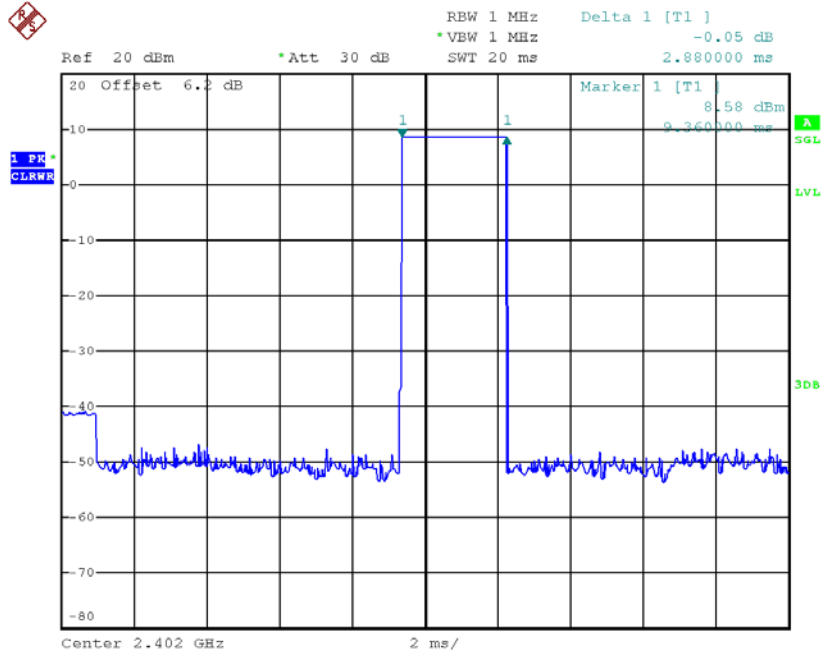

Date: 28.AUG.2018 11:13:52

CH39-DH1

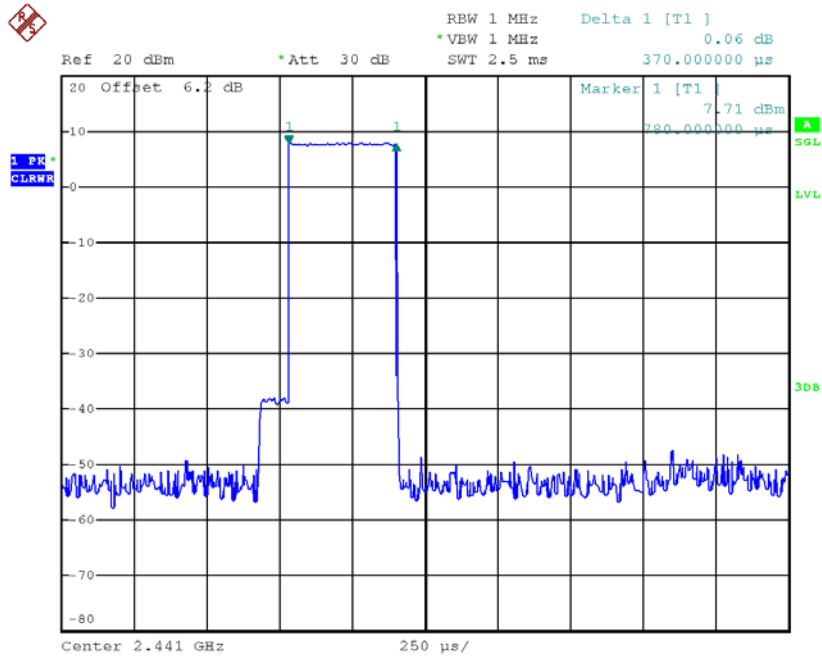

Date: 28.AUG.2018 11:02:31

CH39-DH3

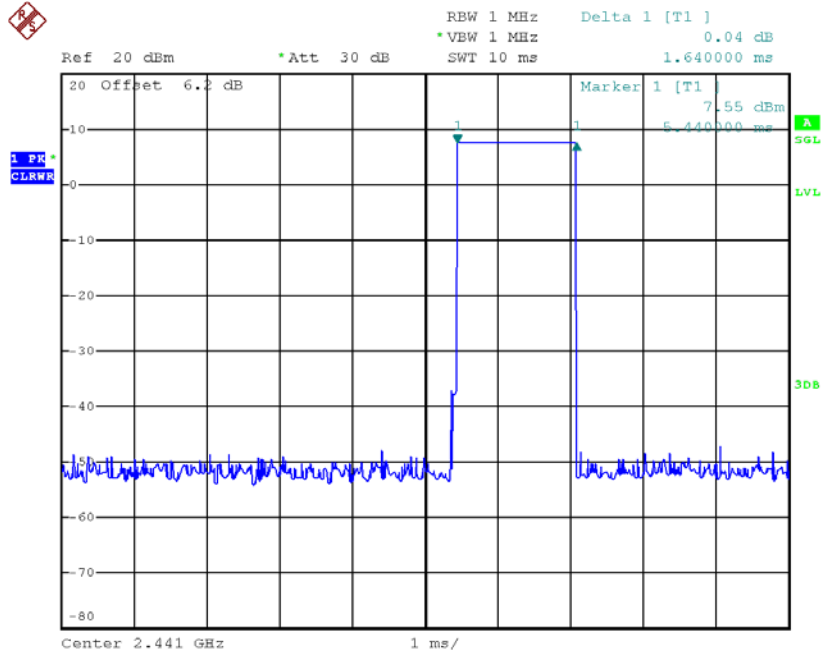

Date: 28.AUG.2018 11:16:04

CH39-DH5

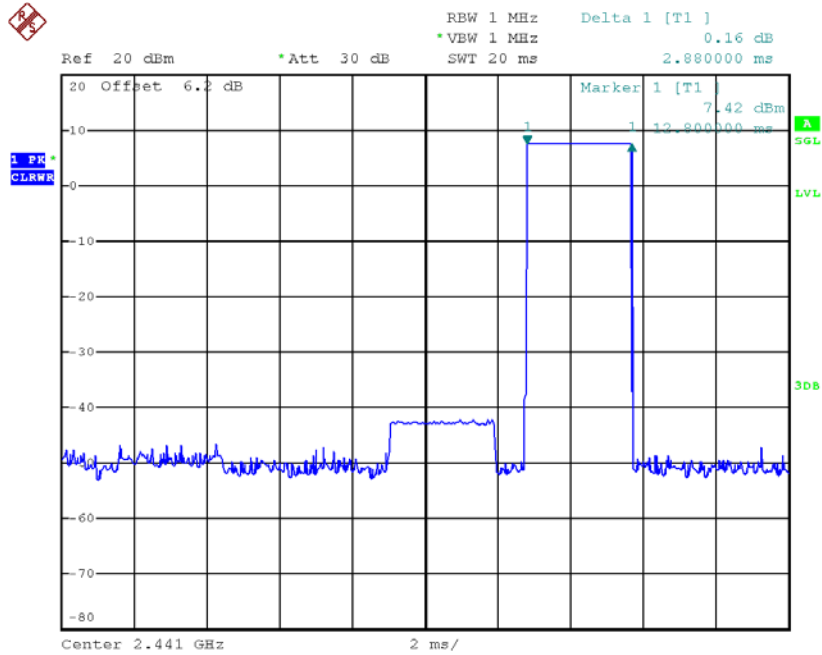

Date: 28.AUG.2018 11:14:43

CH78-DH1

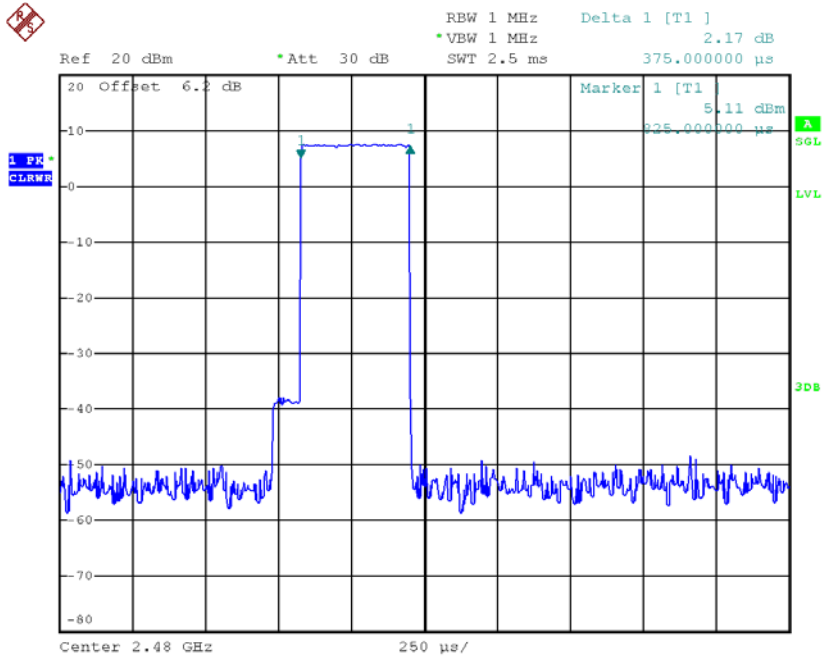

Date: 28.AUG.2018 11:20:27

CH78-DH3

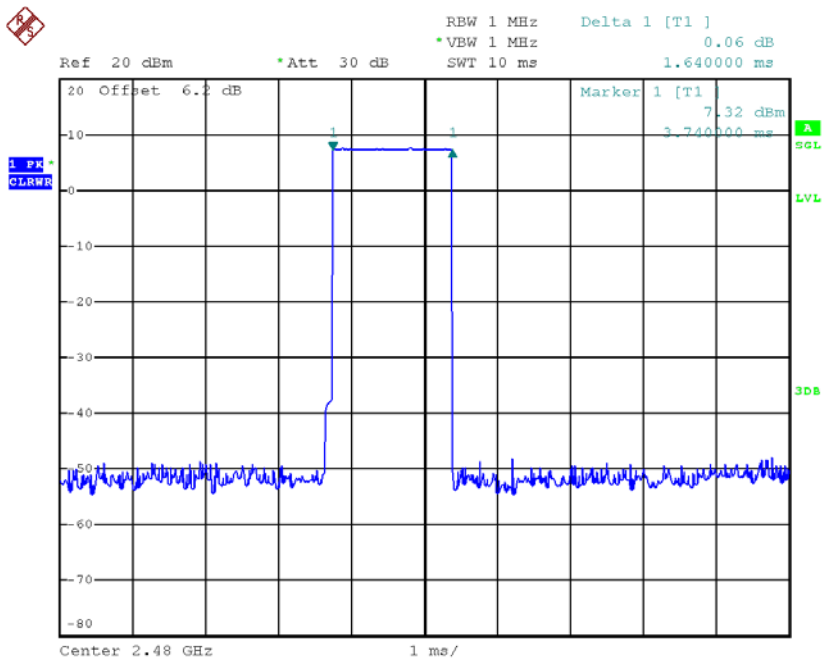

Date: 28.AUG.2018 11:18:22

CH78-DH5

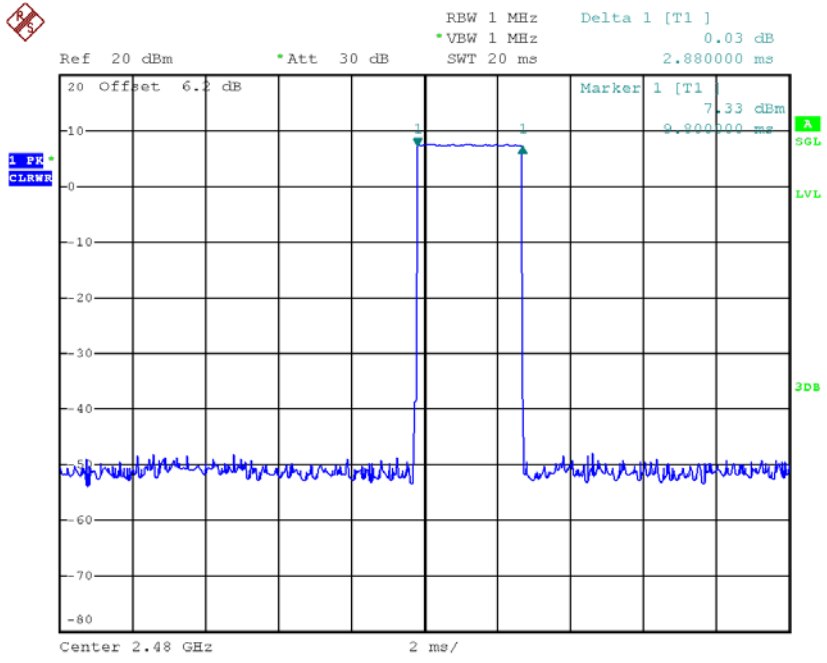

Date: 28.AUG.2018 11:14:06

Test Mode:	TX Mode_3Mbps
------------	---------------

Data Packet	Frequency	Pulse Duration(ms)	Dwell Time(s)	Limits(s)	Test Result
DH5	2402	2.9200	0.3115	0.4000	Pass
DH3	2402	1.6400	0.2624	0.4000	Pass
DH1	2402	0.3800	0.1216	0.4000	Pass
DH5	2441	2.8800	0.3072	0.4000	Pass
DH3	2441	1.6400	0.2624	0.4000	Pass
DH1	2441	0.3800	0.1216	0.4000	Pass
DH5	2480	2.8800	0.3072	0.4000	Pass
DH3	2480	1.6400	0.2624	0.4000	Pass
DH1	2480	0.3800	0.1216	0.4000	Pass

CH00-DH1

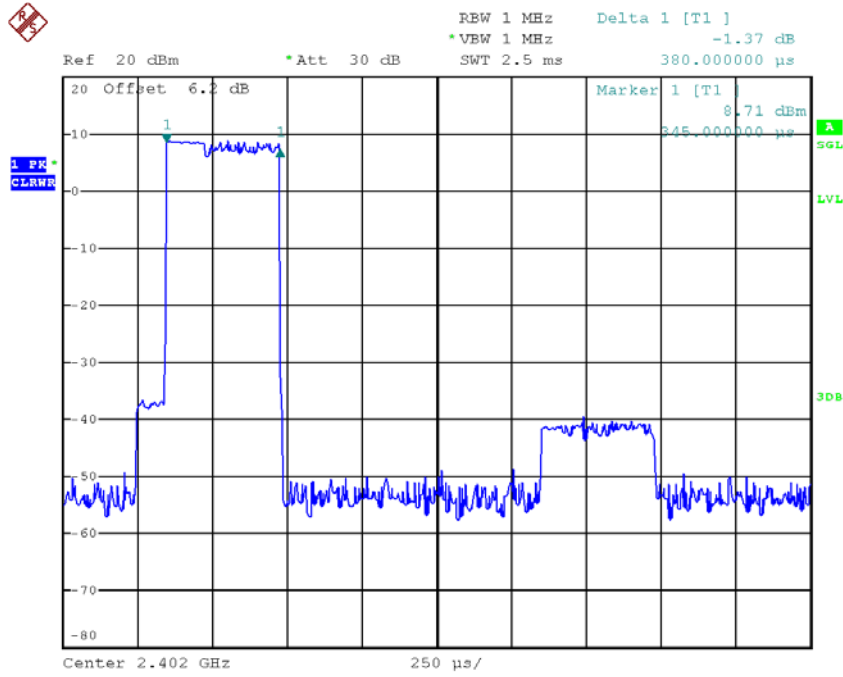

Date: 28.AUG.2018 11:44:52

CH00-DH3

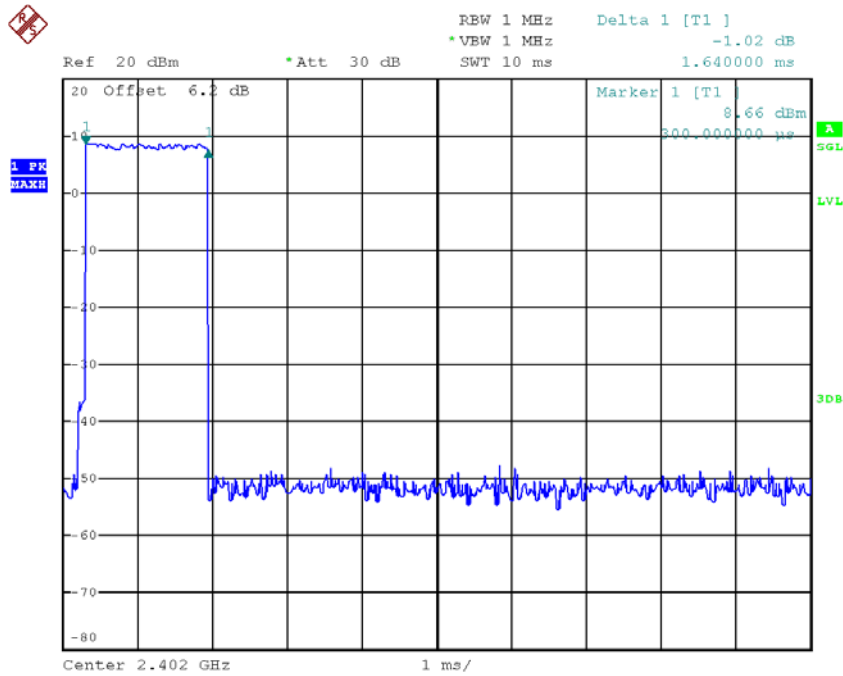

Date: 28.AUG.2018 11:39:14

CH00-DH5

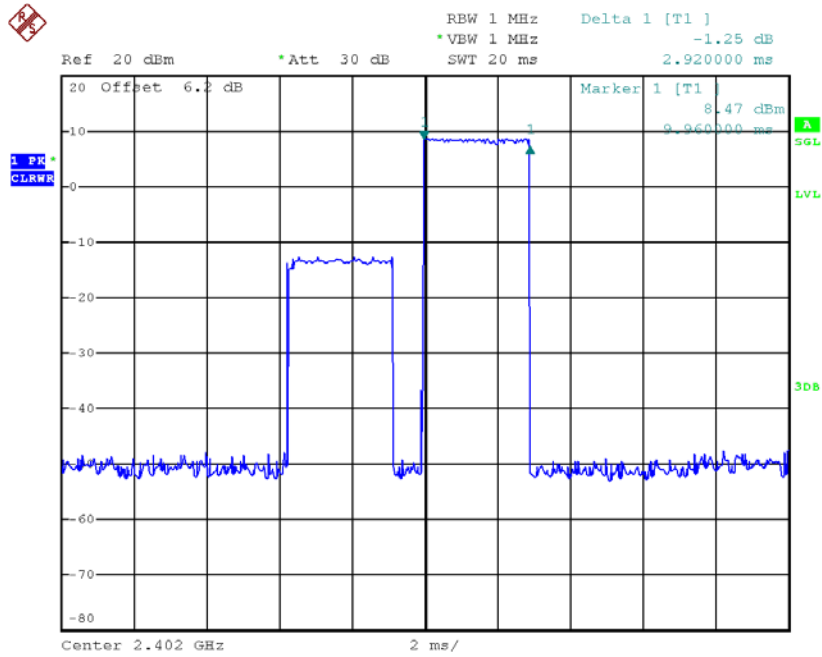

Date: 28.AUG.2018 11:40:13

CH39-DH1

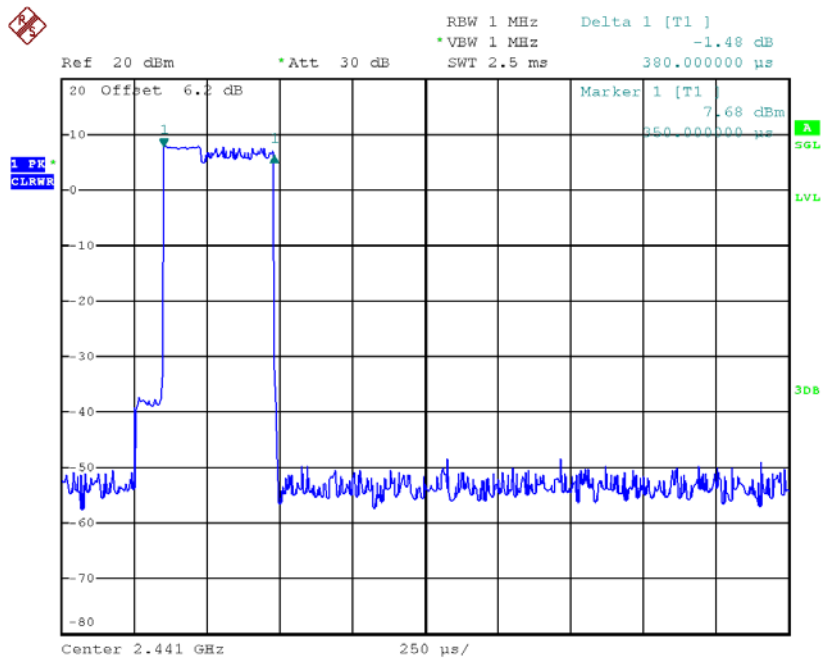

Date: 28.AUG.2018 11:45:28

CH39-DH3

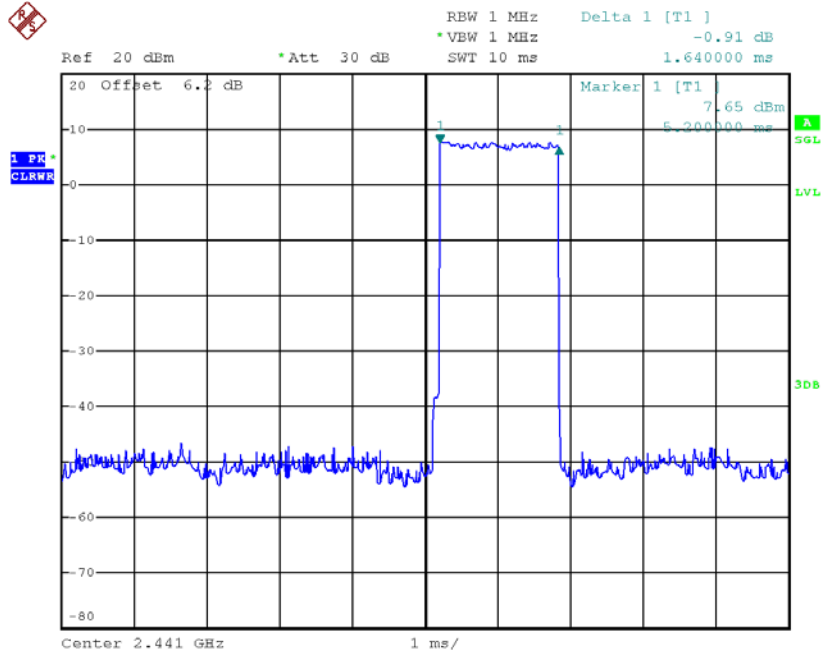

Date: 28.AUG.2018 11:43:38

CH39-DH5

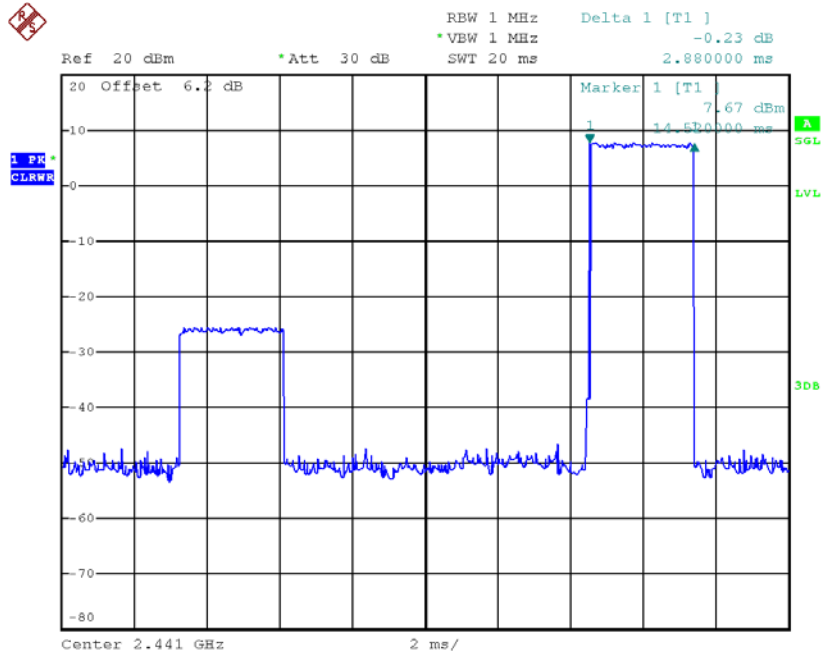

Date: 28.AUG.2018 11:41:19

CH78-DH1

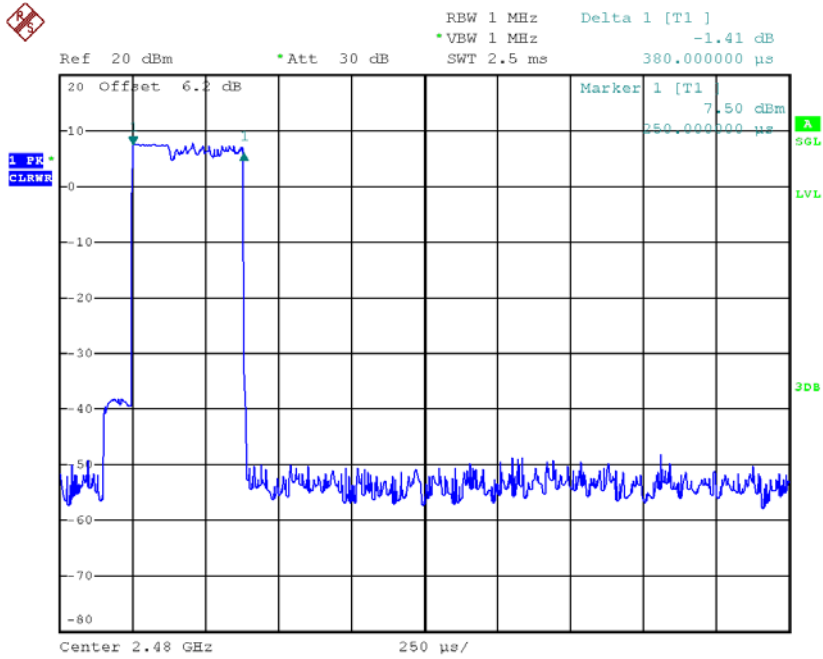

Date: 28.AUG.2018 11:44:39

CH78-DH3

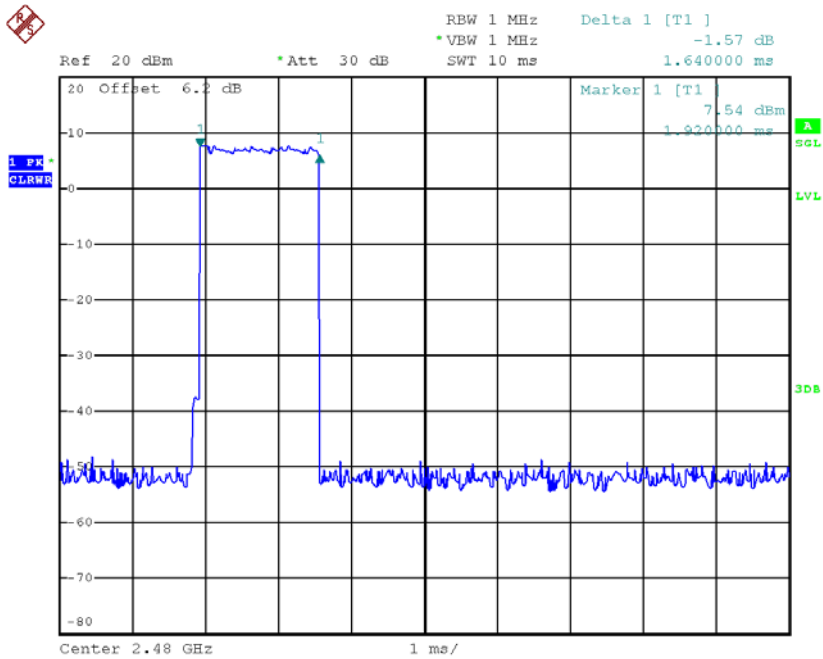

Date: 28.AUG.2018 11:39:46

CH78-DH5

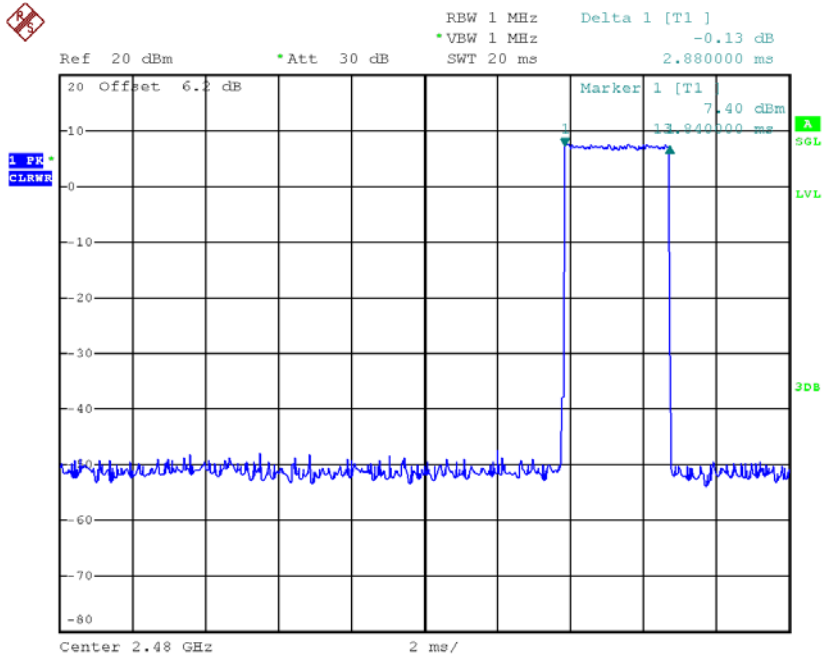

Date: 28.AUG.2018 11:42:08

APPENDIX G - HOPPING CHANNEL SEPARATION MEASUREMENT

Test Mode: Hopping on _1Mbps

Frequency (MHz)	Channel Separation (MHz)	2/3 of 20 dB Bandwidth (MHz)	Test Result
2402	1.008	0.644	Pass
2441	0.868	0.632	Pass
2480	1.335	0.639	Pass

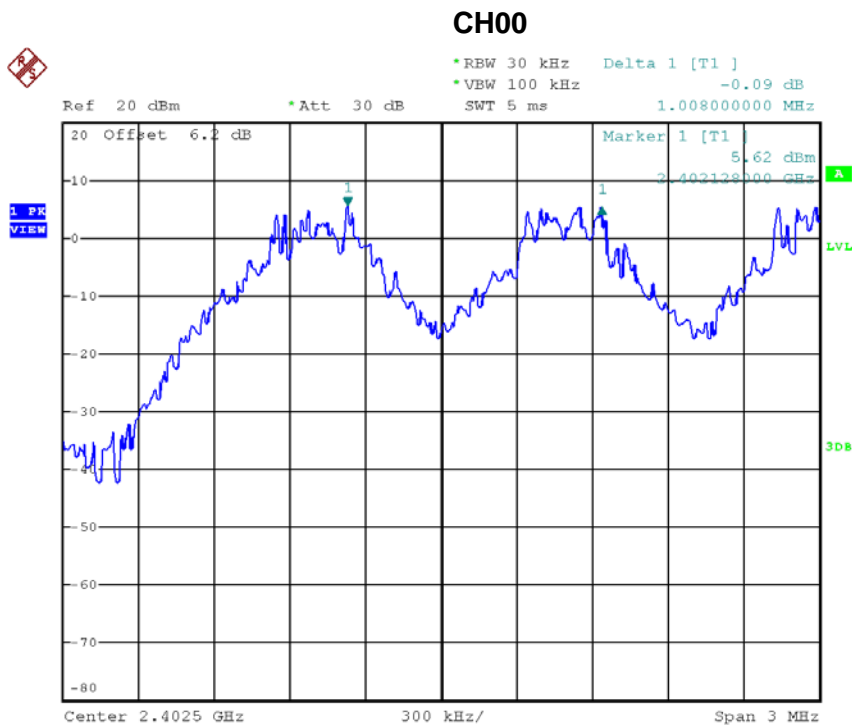

Date: 28.AUG.2018 11:03:41

CH39

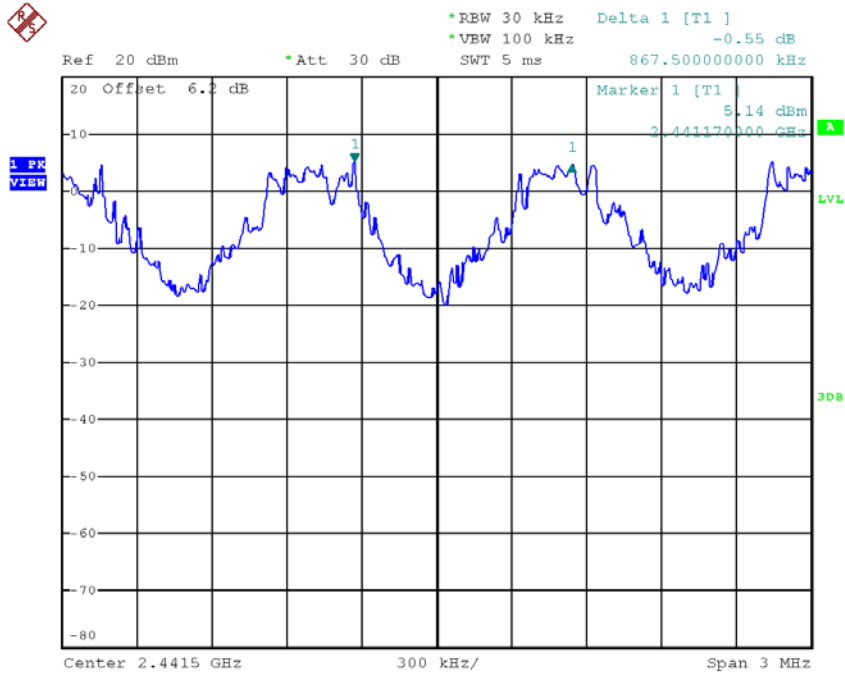

Date: 28.AUG.2018 11:22:06

CH78

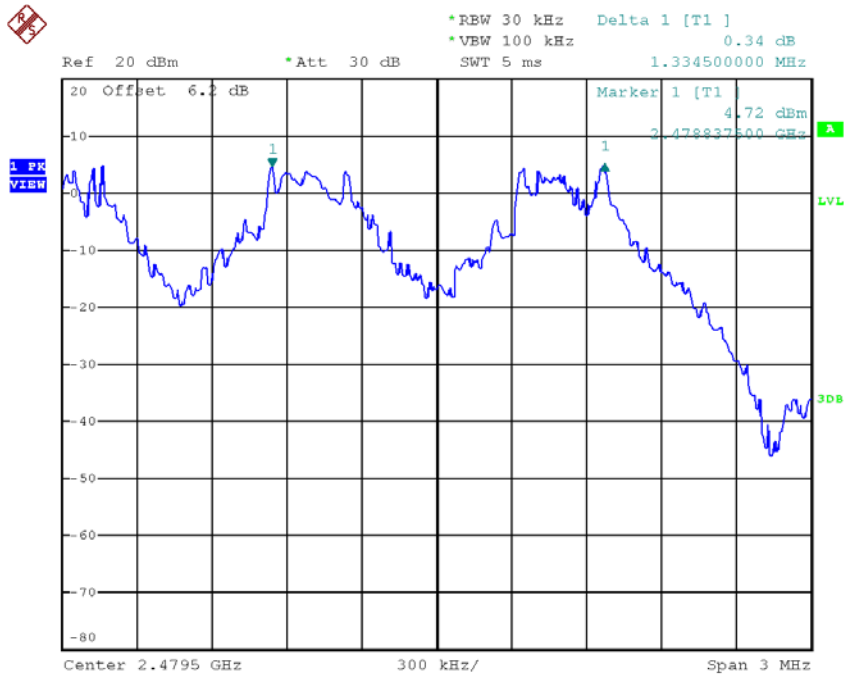

Date: 28.AUG.2018 11:06:00

Test Mode: Hopping on _3Mbps

Frequency (MHz)	Channel Separation (MHz)	2/3 of 20 dB Bandwidth (MHz)	Test Result
2402	1.095	0.864	Pass
2441	1.205	0.868	Pass
2480	1.197	0.864	Pass

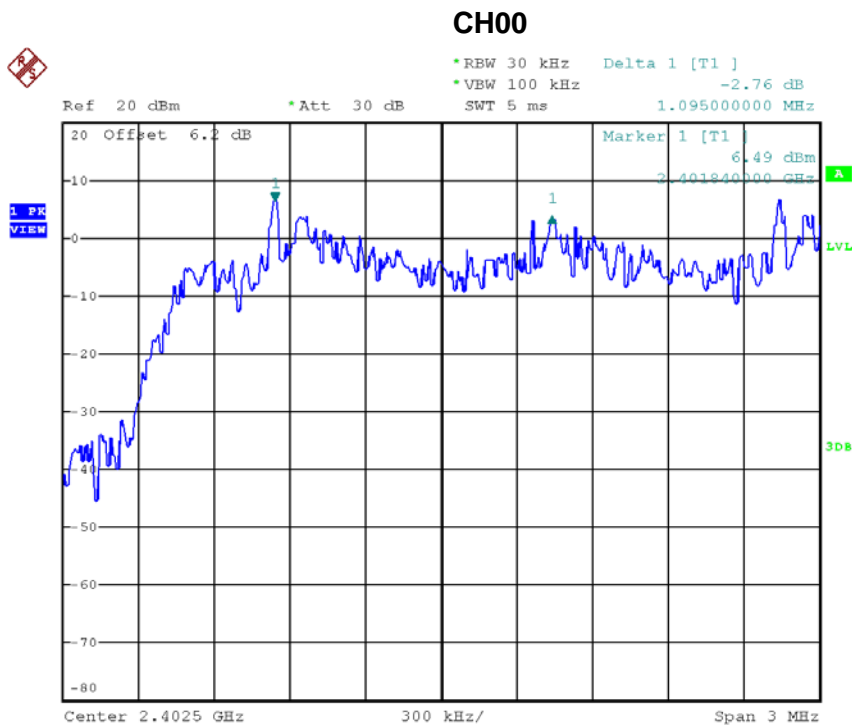

Date: 28.AUG.2018 11:47:33

CH39

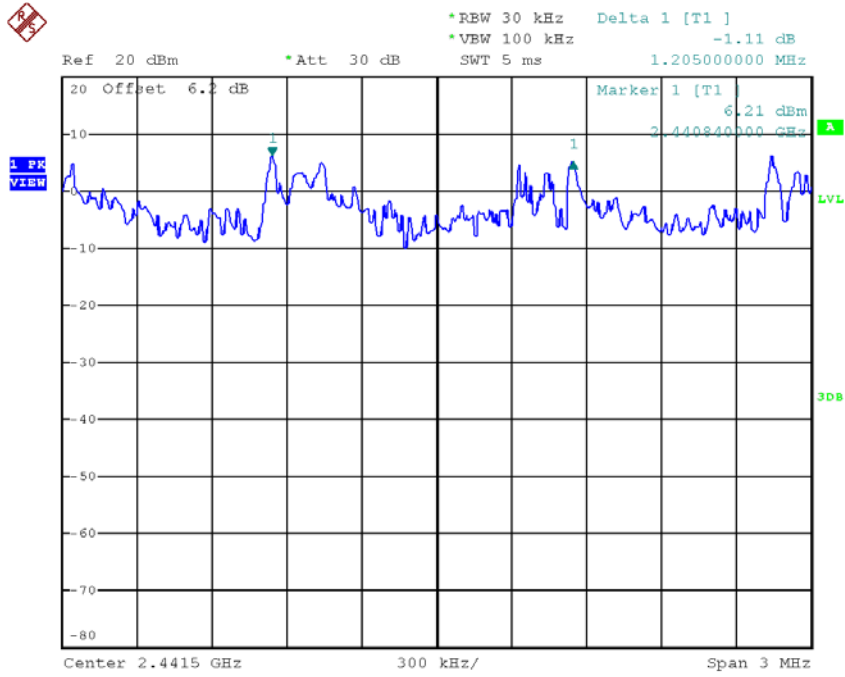

Date: 30.AUG.2018 18:57:51

CH78

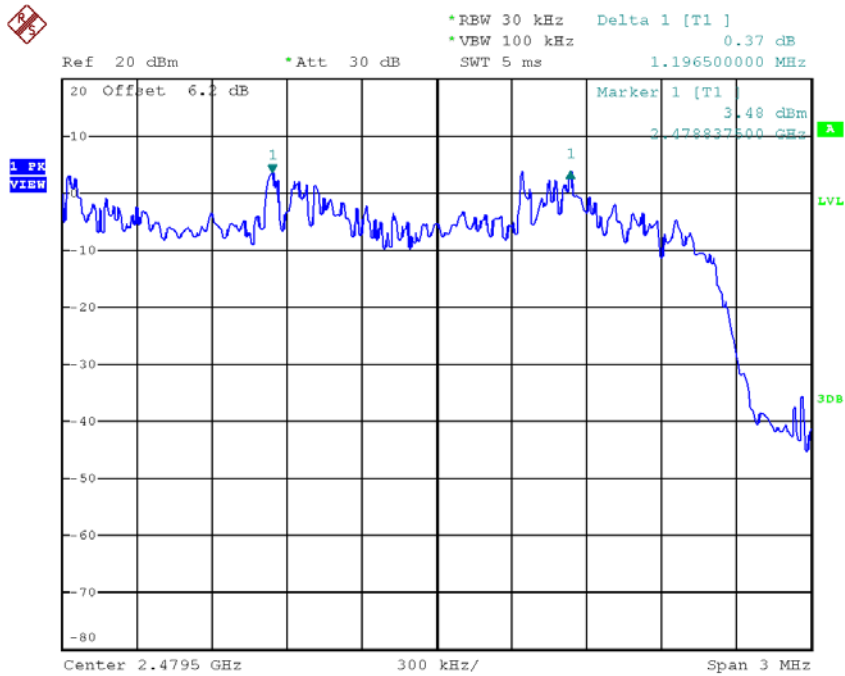

Date: 28.AUG.2018 11:35:27

APPENDIX H - BANDWIDTH

Test Mode: TX Mode _1Mbps

Frequency (MHz)	20 dB Bandwidth (MHz)	99% Occupied BW (MHz)	Test Result
2402	0.966	0.876	Pass
2441	0.948	0.880	Pass
2480	0.958	0.876	Pass

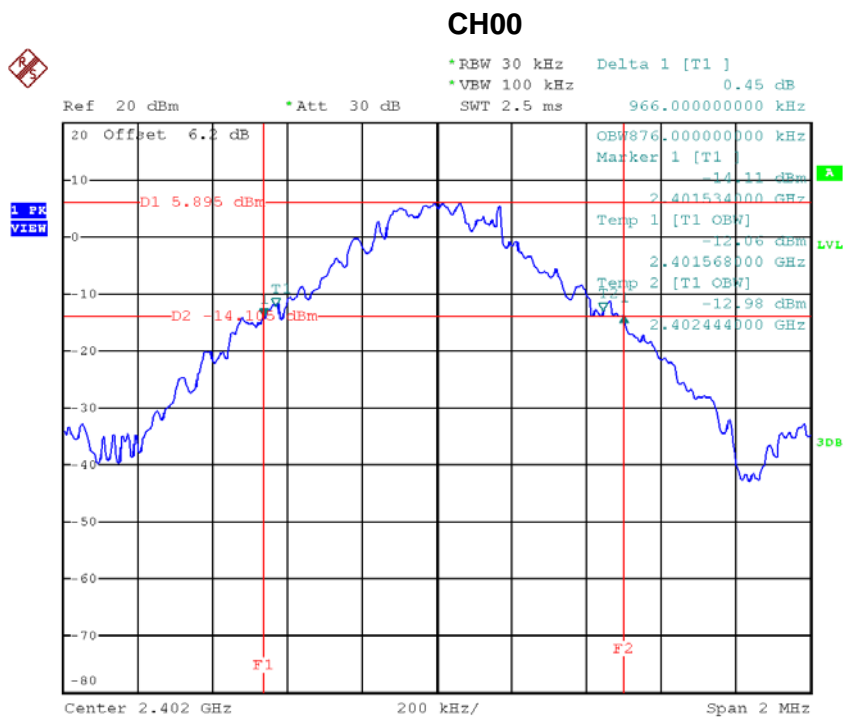

Date: 28.AUG.2018 10:56:58

CH39

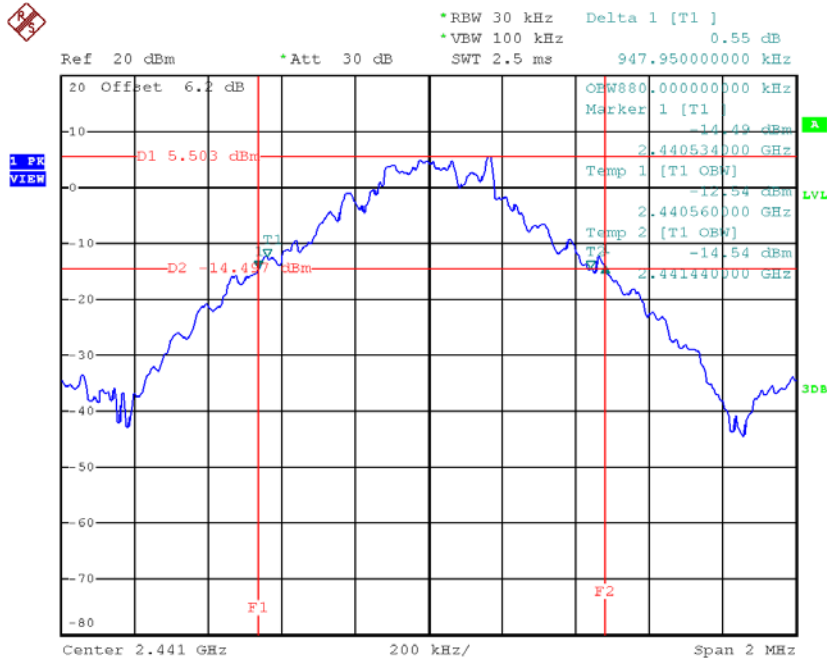

Date: 28.AUG.2018 10:59:24

CH78

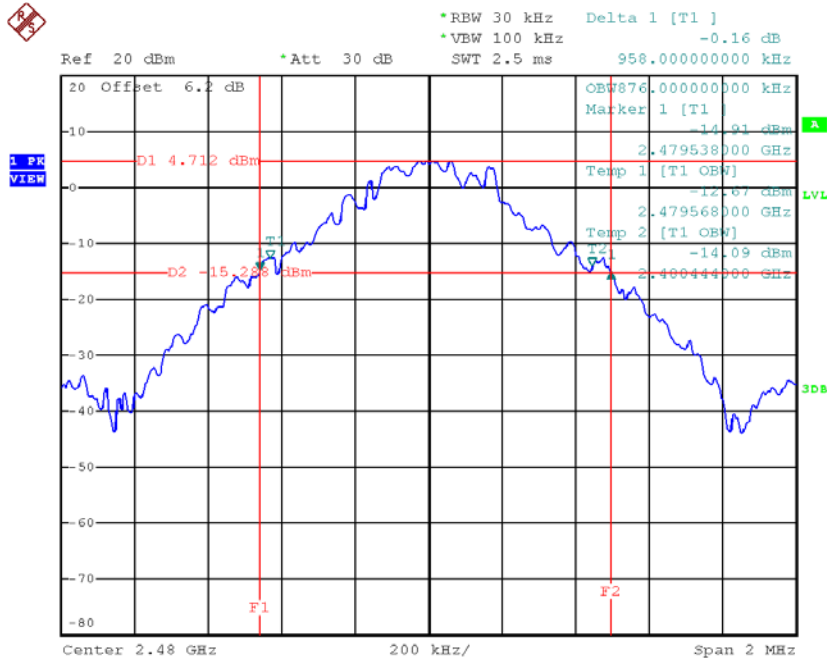

Date: 28.AUG.2018 11:00:39

Test Mode: TX Mode _3Mbps

Frequency (MHz)	20 dB Bandwidth (MHz)	99% Occupied BW (MHz)	Test Result
2402	1.296	1.188	Pass
2441	1.302	1.180	Pass
2480	1.296	1.176	Pass

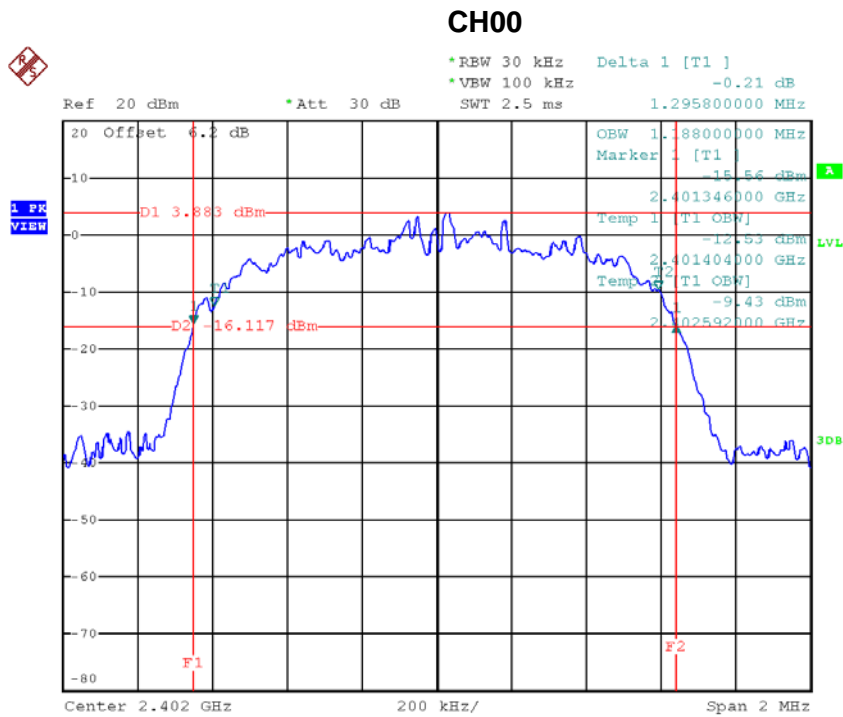

Date: 28.AUG.2018 11:26:01

CH39

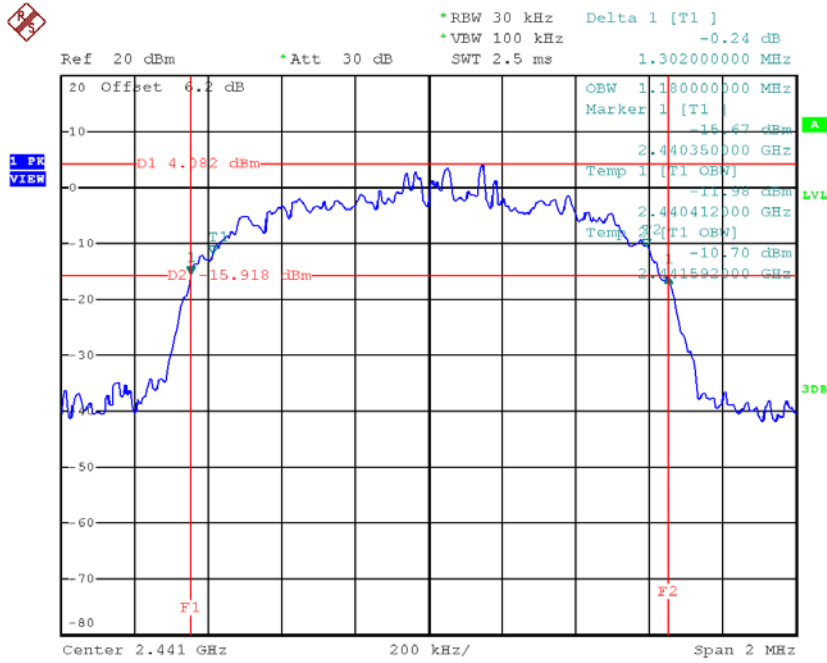

Date: 28.AUG.2018 11:28:15

CH78

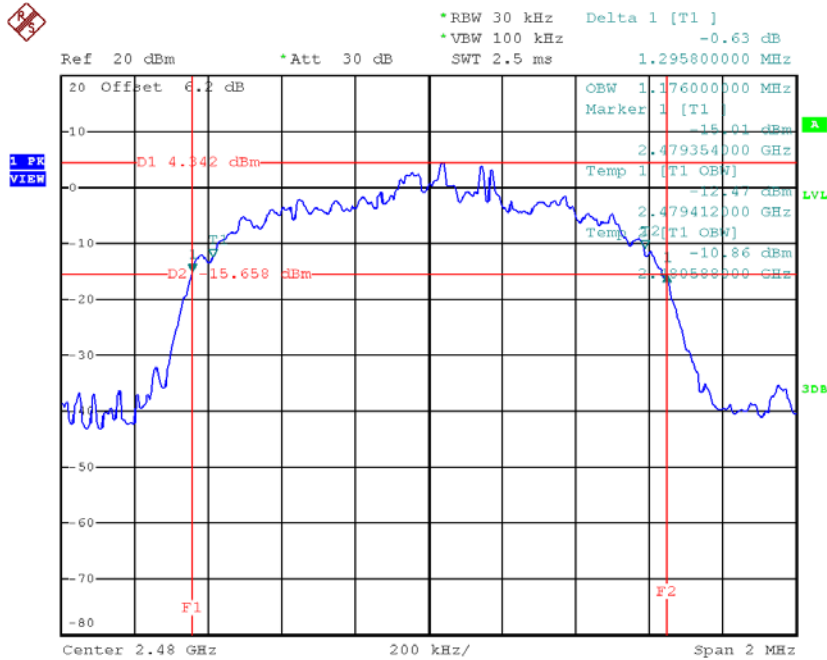

Date: 28.AUG.2018 11:29:33

APPENDIX I - MAXIMUM OUTPUT POWER

Test Mode: TX Mode _1Mbps

Frequency (MHz)	Output Power (dBm)	Output Power (W)	Max. Limit (dBm)	Max. Limit (W)	Test Result
2402	8.80	0.0076	21.00	0.125	Pass
2441	7.86	0.0061	21.00	0.125	Pass
2480	7.60	0.0058	21.00	0.125	Pass

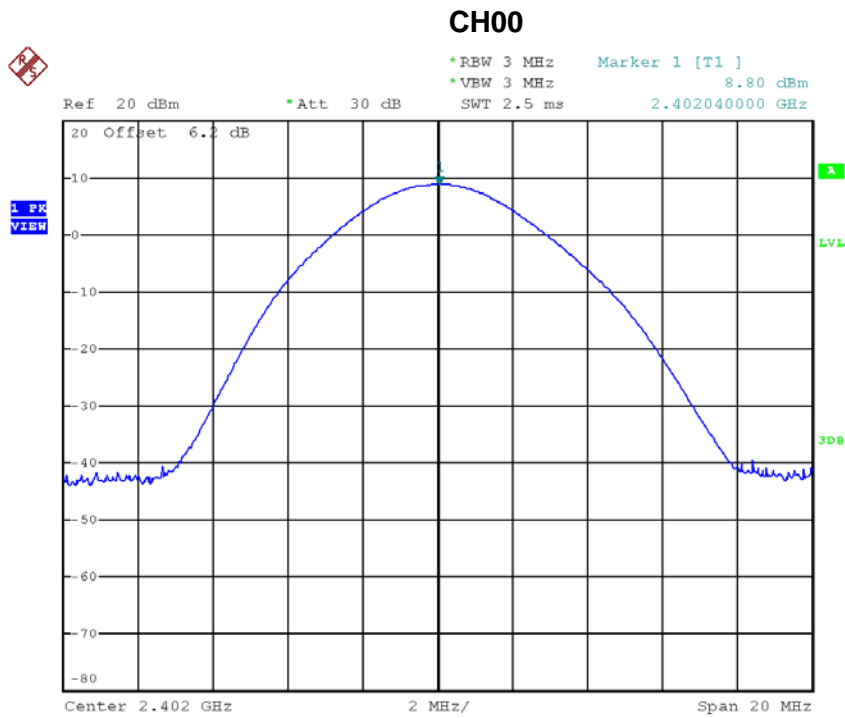

Date: 28.AUG.2018 10:50:37

CH39

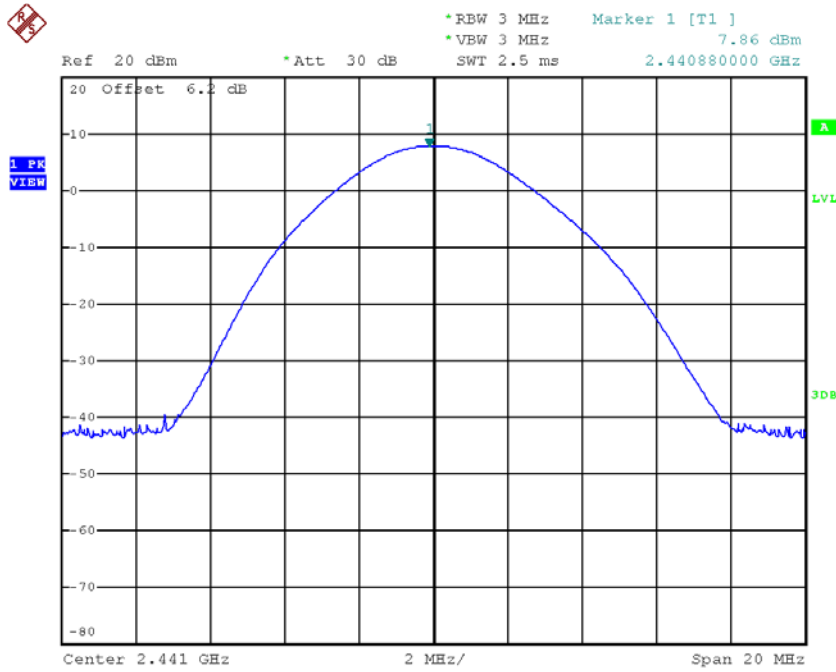

Date: 28.AUG.2018 10:50:56

CH78

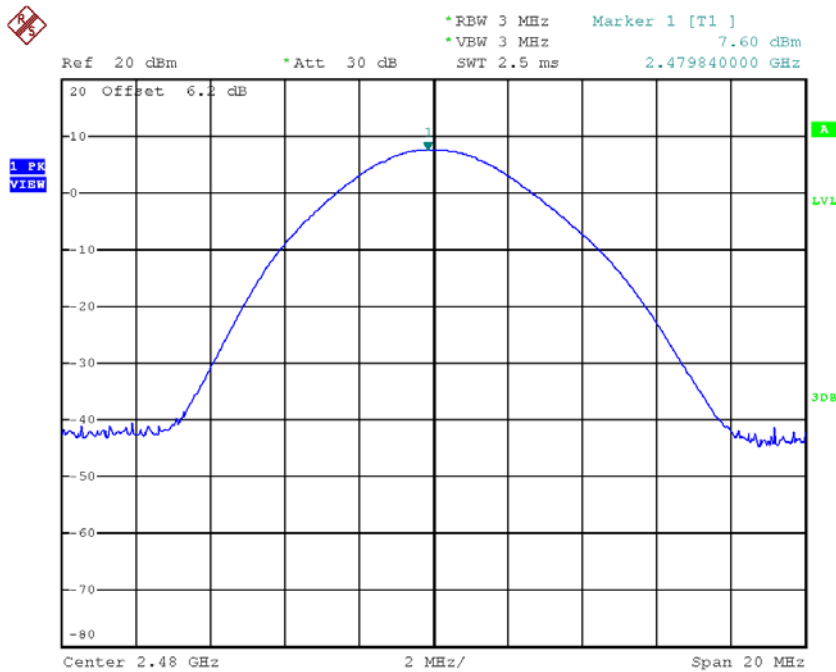

Date: 28.AUG.2018 10:51:20

Test Mode: TX Mode _3Mbps

Frequency (MHz)	Output Power (dBm)	Output Power (W)	Max. Limit (dBm)	Max. Limit (W)	Test Result
2402	9.40	0.0087	21.00	0.125	Pass
2441	8.54	0.0071	21.00	0.125	Pass
2480	8.28	0.0067	21.00	0.125	Pass

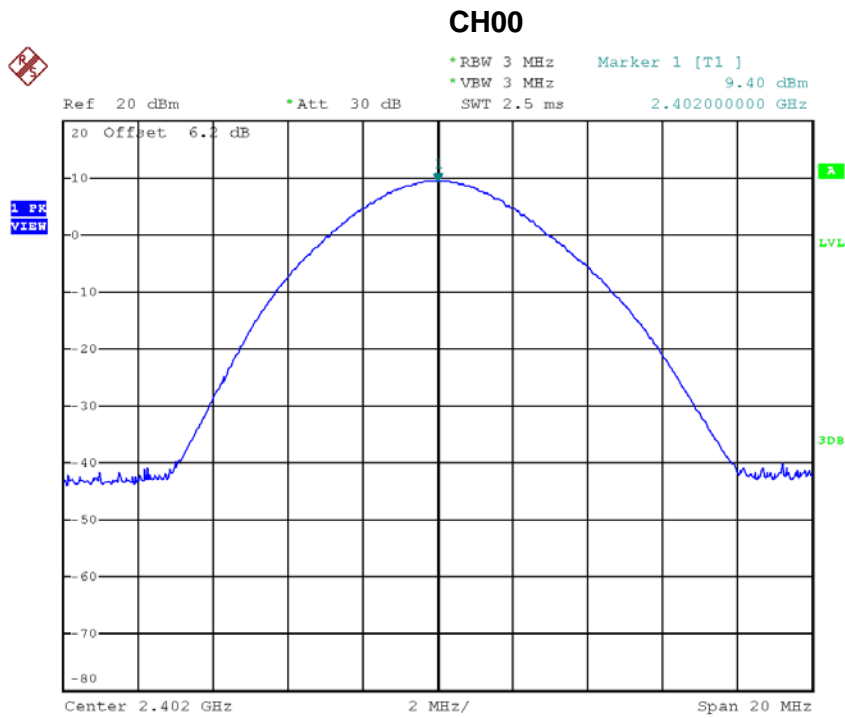

Date: 28.AUG.2018 10:53:12

CH39

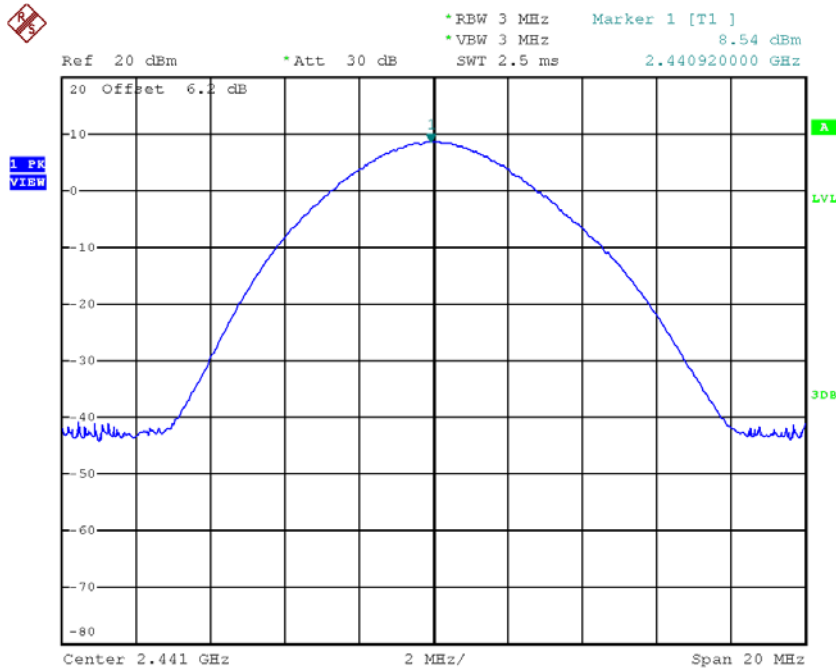

Date: 28.AUG.2018 10:53:33

CH78

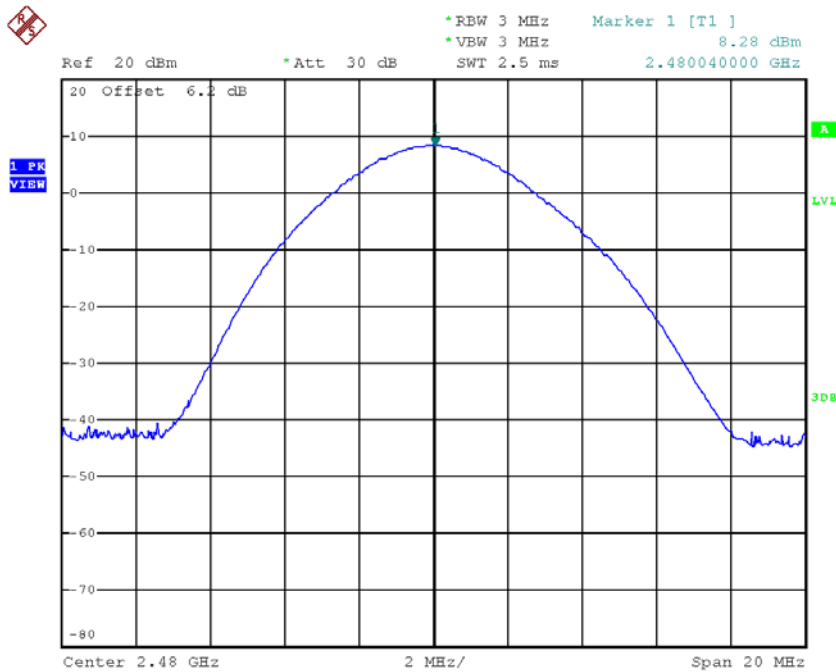

Date: 28.AUG.2018 10:53:53

APPENDIX J - ANTENNA CONDUCTED SPURIOUS EMISSION

CH00 (Lower)_1Mbps

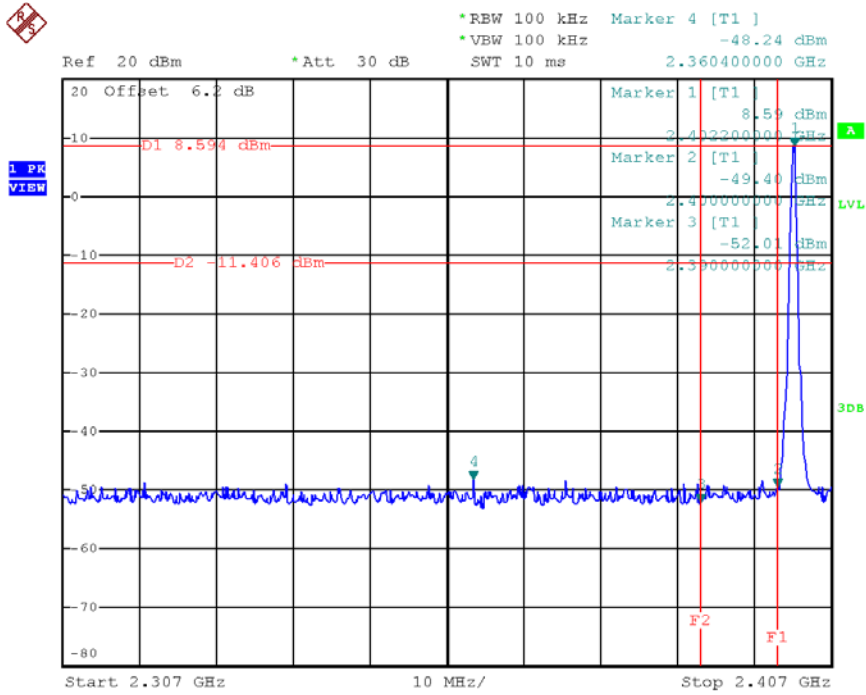

Date: 28.AUG.2018 10:56:18

CH78 (Upper)_1Mbps

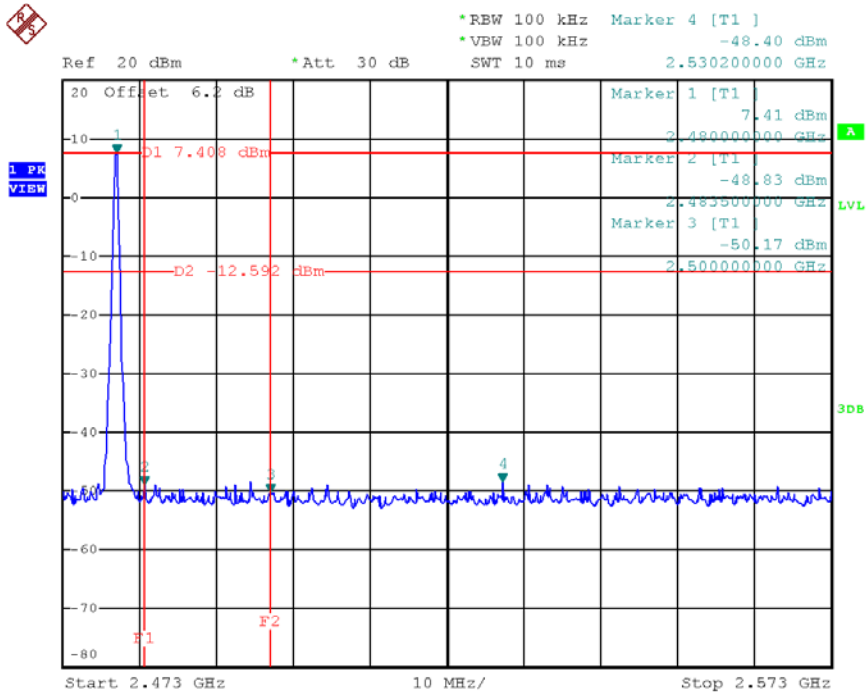

Date: 28.AUG.2018 10:59:49

CH00 Hopping on mode (Lower)_1Mbps

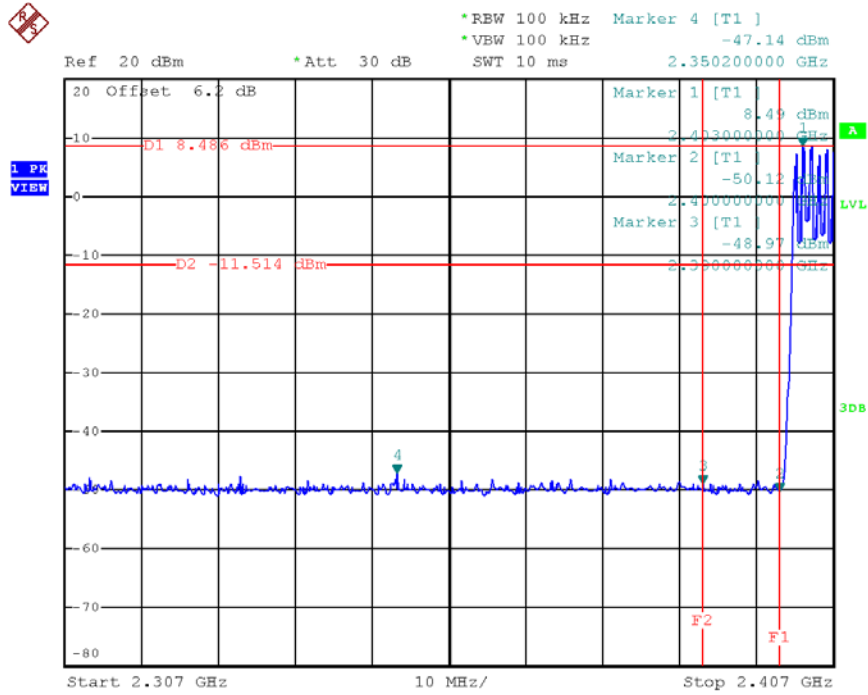

Date: 28.AUG.2018 11:08:42

CH78 Hopping on mode (Upper)_1Mbps

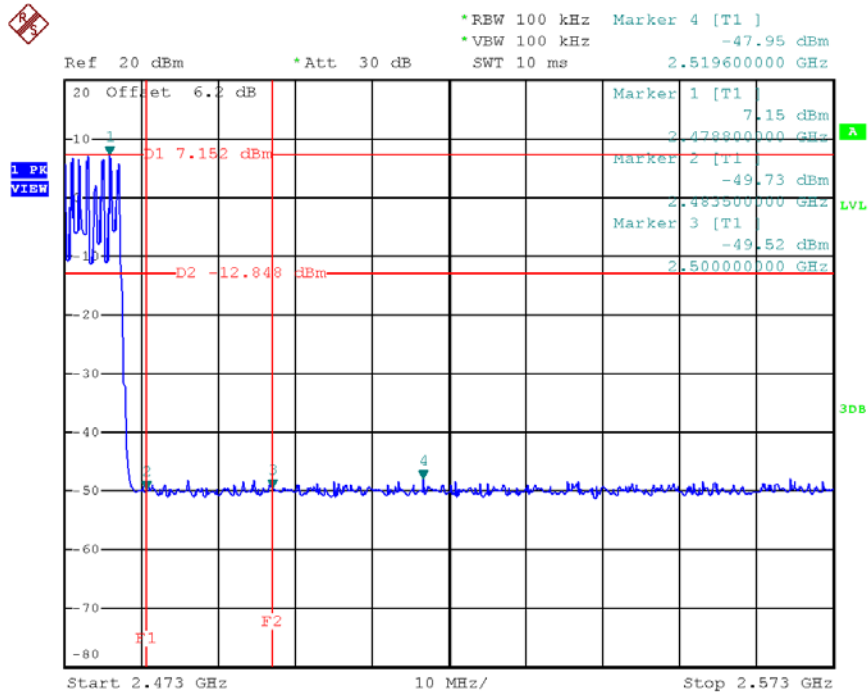

Date: 28.AUG.2018 11:09:17

CH00 (10th Harmonic of the frequency) _1Mbps

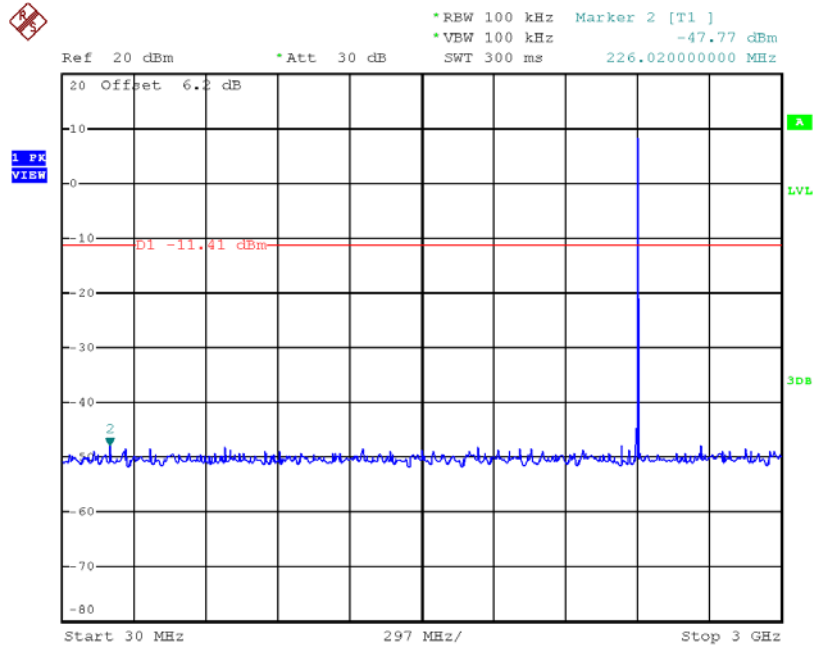

Date: 28.AUG.2018 10:57:12

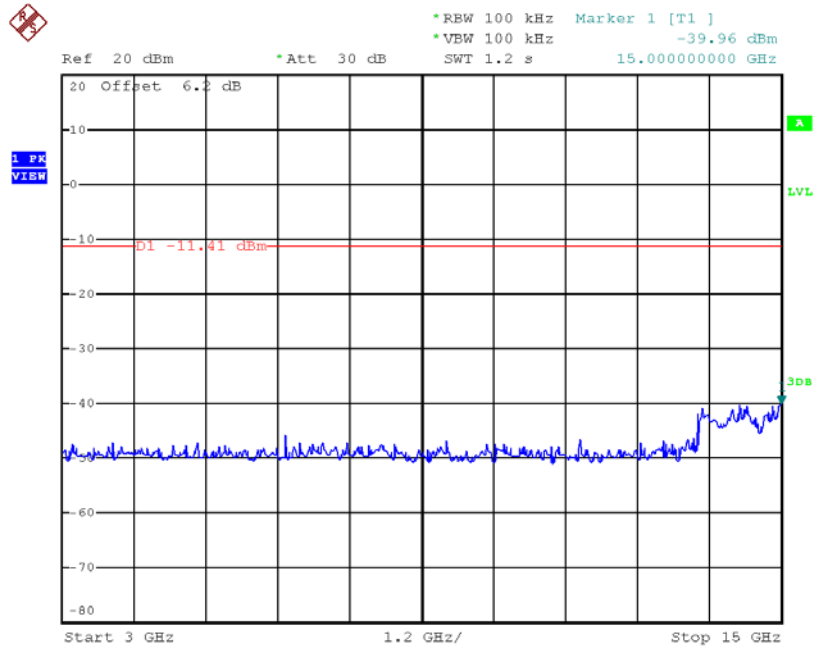

Date: 28.AUG.2018 10:57:20

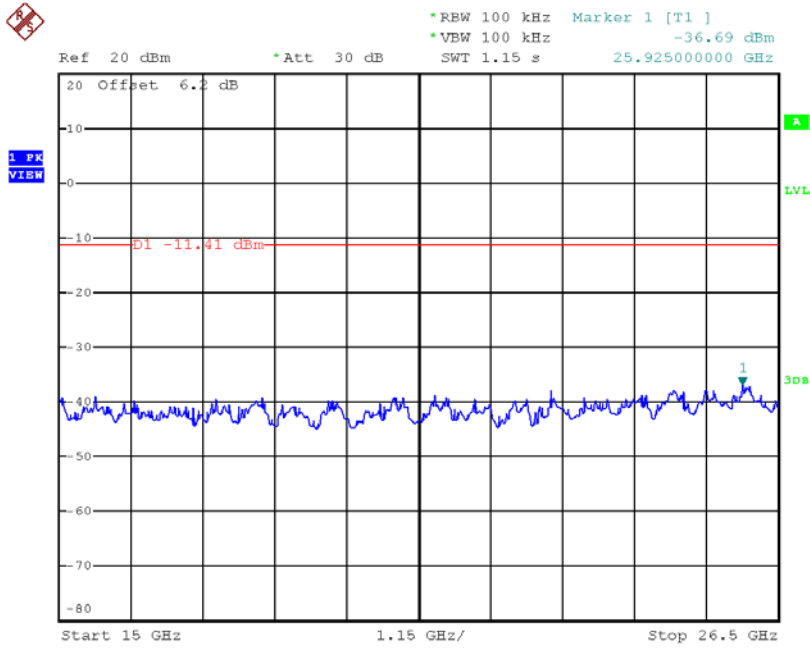

Date: 28.AUG.2018 10:57:28

CH39 (10th Harmonic of the frequency) _1Mbps

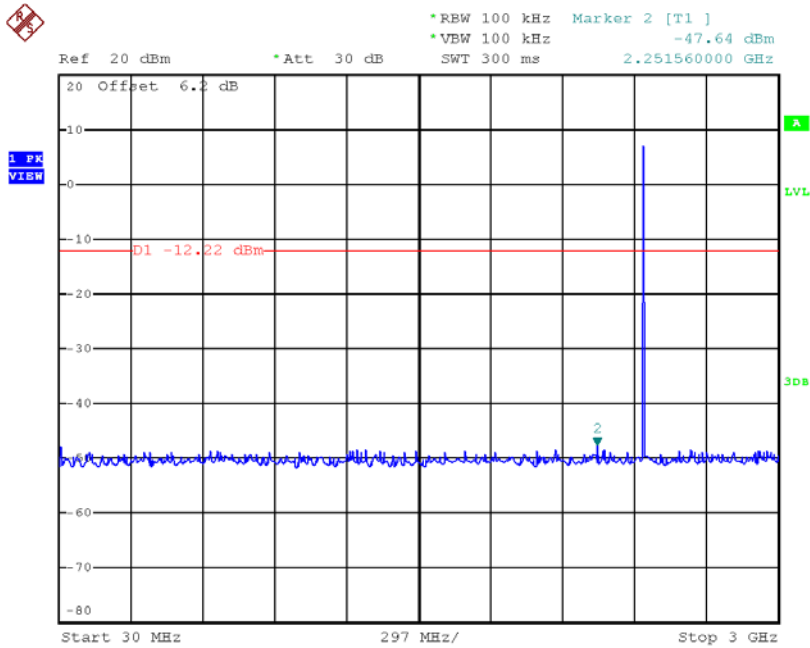

Date: 28.AUG.2018 10:58:27

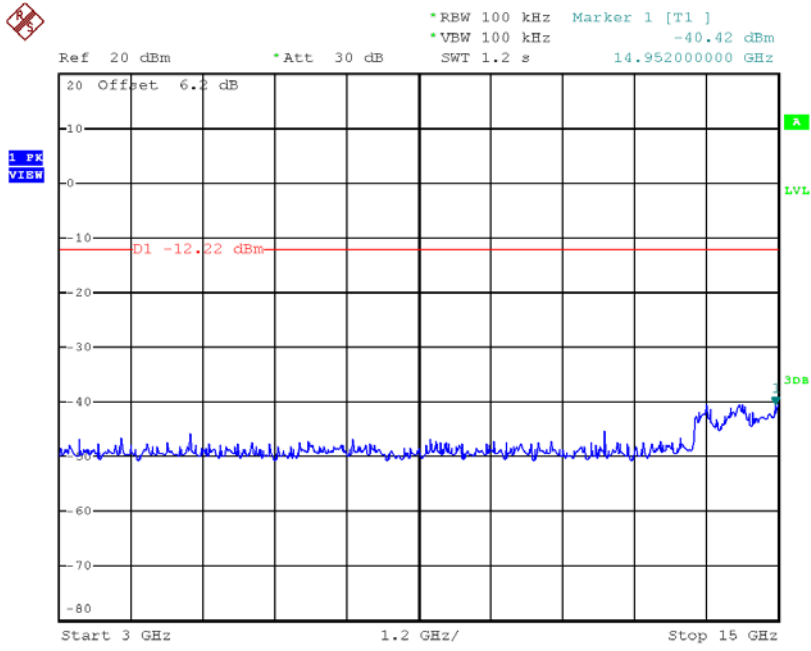

Date: 28.AUG.2018 10:58:35

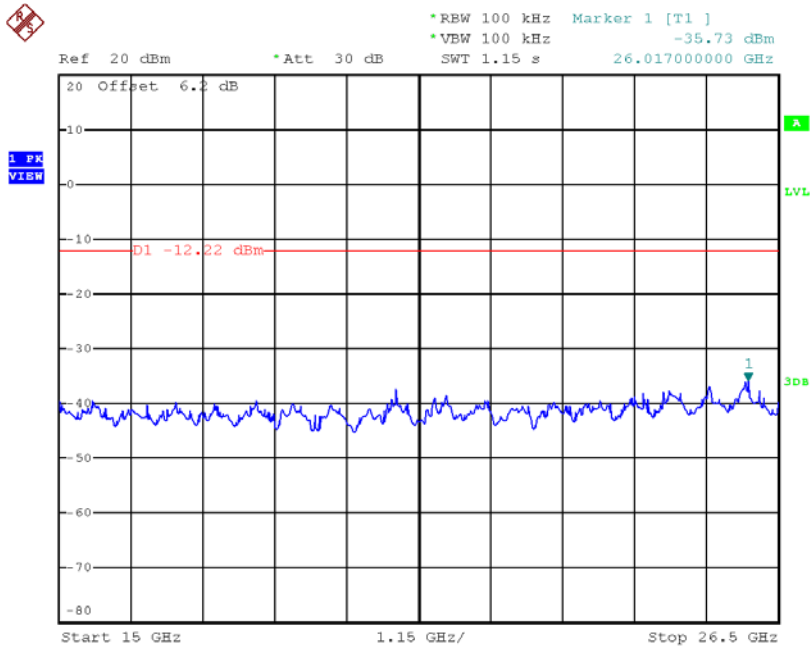

Date: 28.AUG.2018 10:58:43

CH78 (10th Harmonic of the frequency) _1Mbps

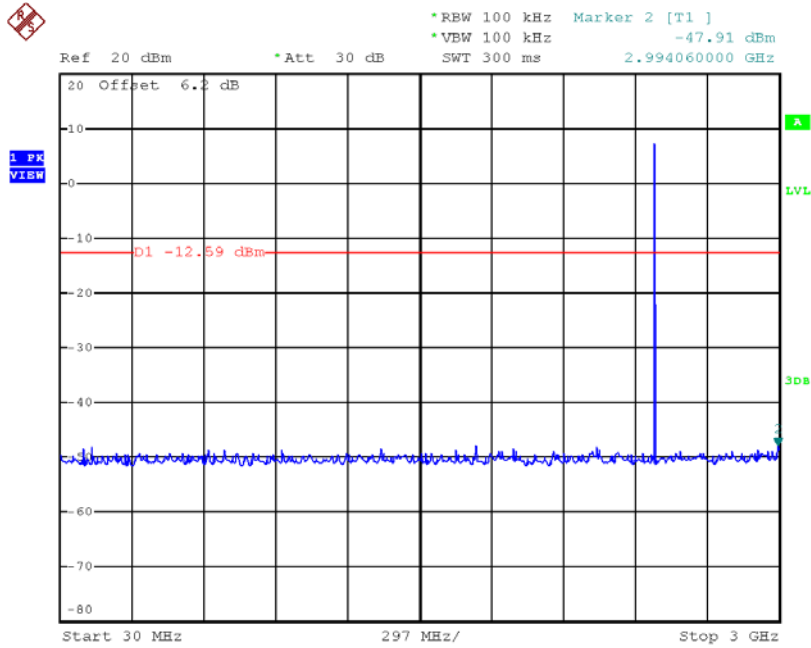

Date: 28.AUG.2018 11:00:53

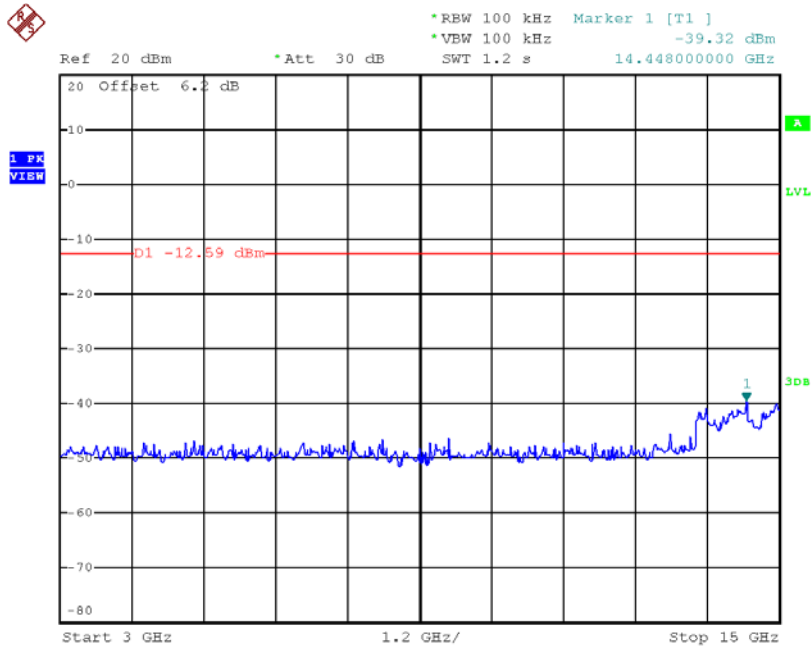

Date: 28.AUG.2018 11:01:01

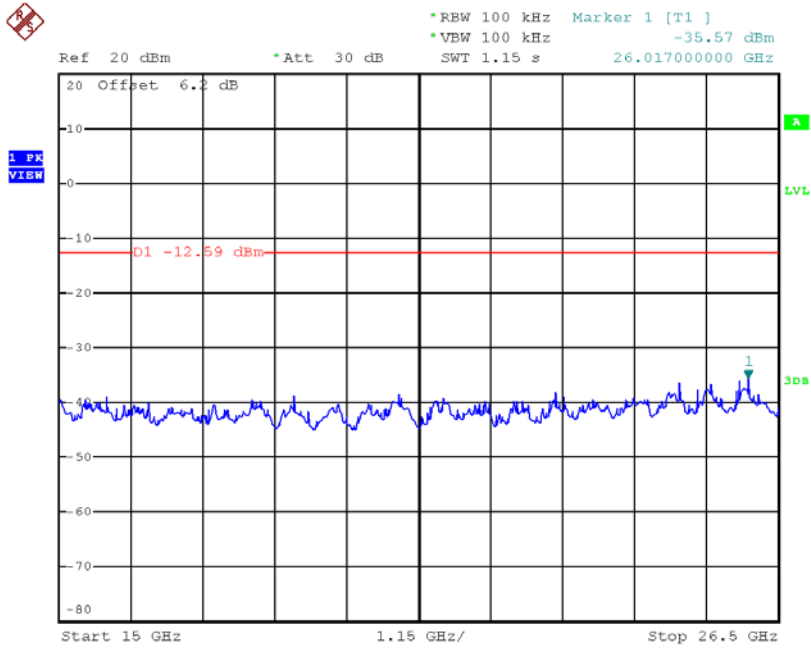

Date: 28.AUG.2018 11:01:09

CH00 (Lower) _3Mbps

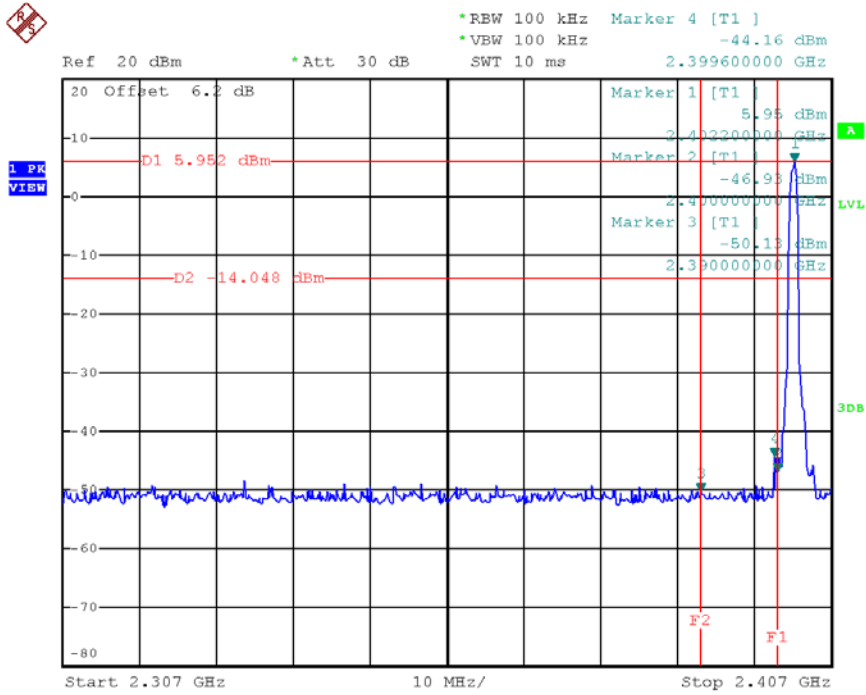

Date: 28.AUG.2018 11:25:30

CH78 (Upper) _3Mbps

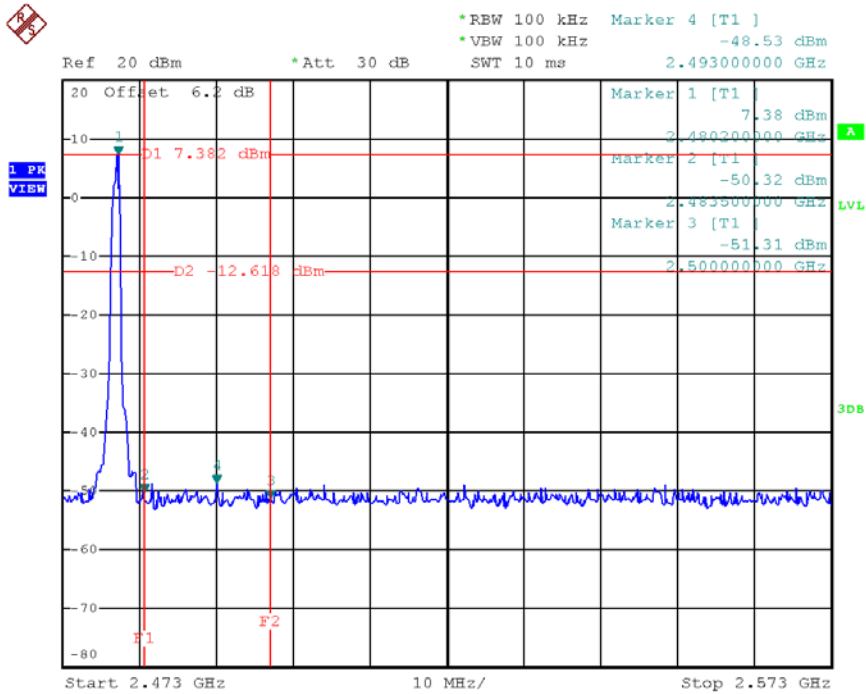

Date: 28.AUG.2018 11:28:55

CH00 Hopping on mode (Lower)_3Mbps

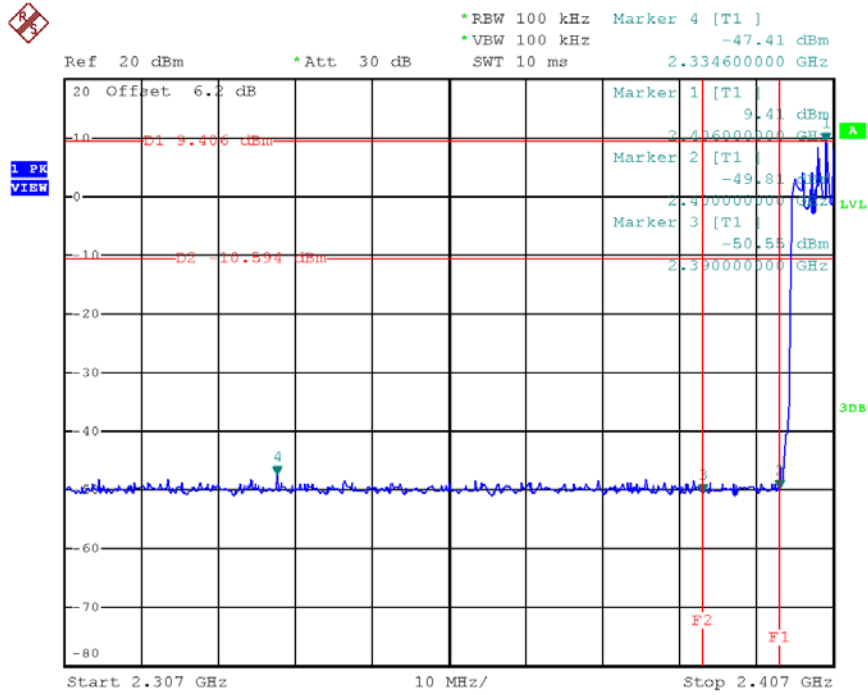

Date: 28.AUG.2018 11:38:09

CH78 Hopping on mode (Upper)_3Mbps

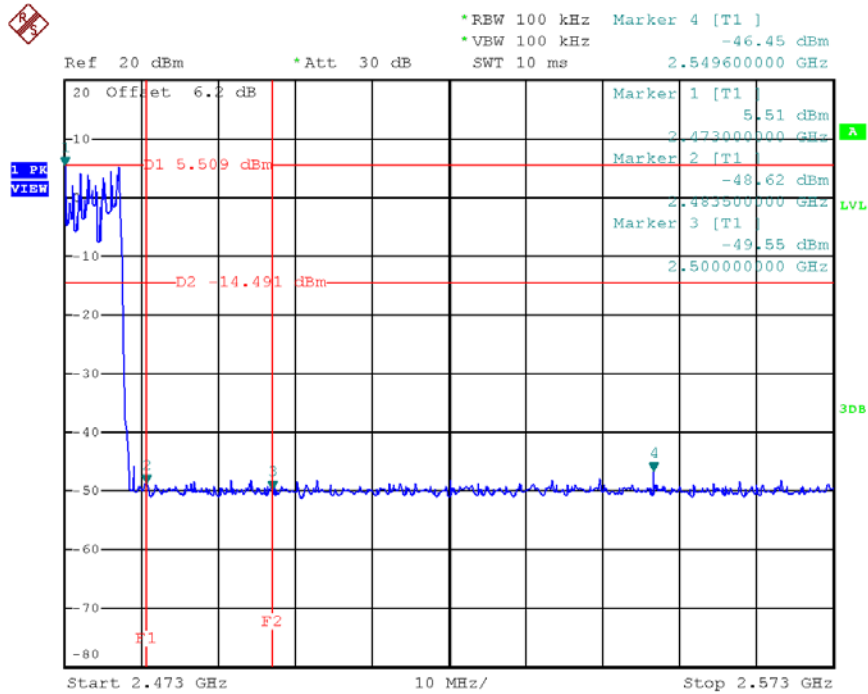

Date: 28.AUG.2018 11:38:44

CH00 (10th Harmonic of the frequency) _3Mbps

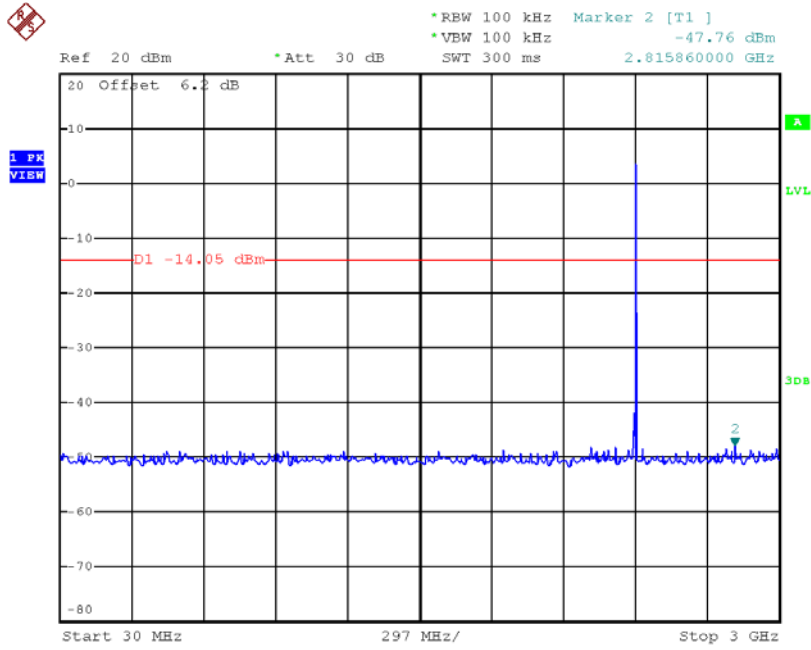

Date: 28.AUG.2018 11:26:16

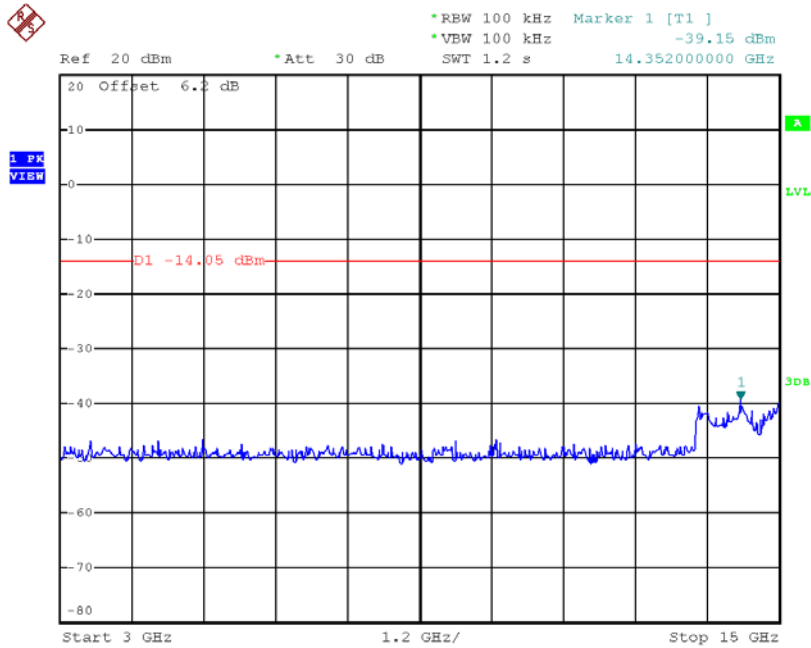

Date: 28.AUG.2018 11:26:24

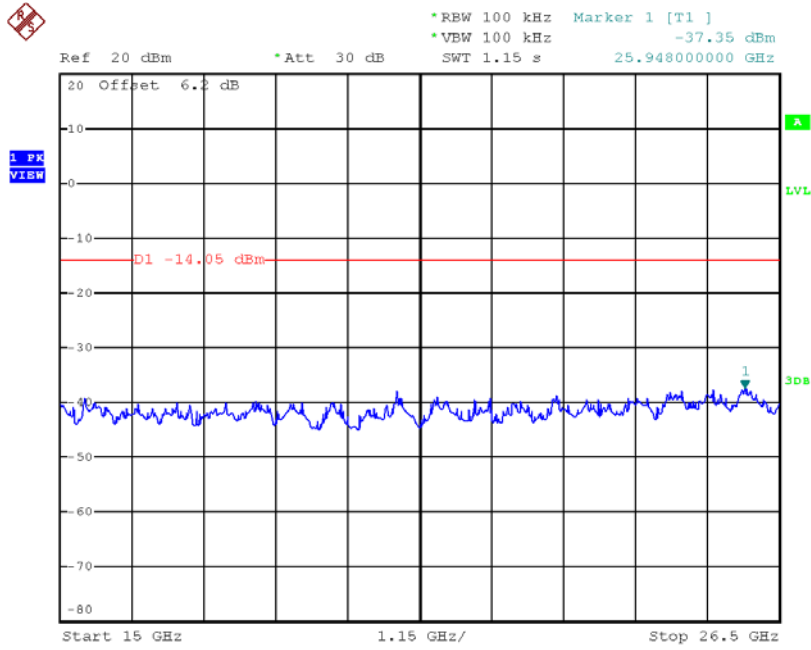

Date: 28.AUG.2018 11:26:32

CH39 (10th Harmonic of the frequency) _3Mbps

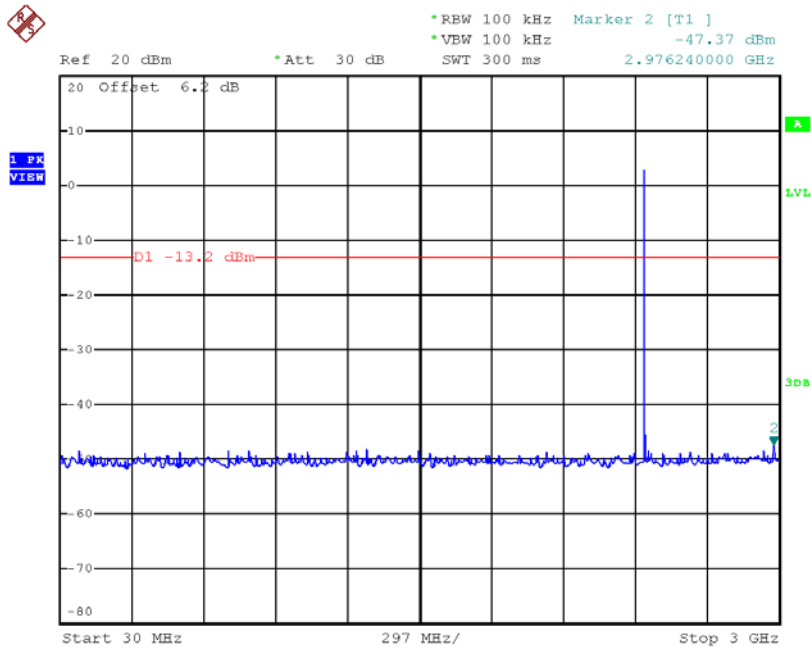

Date: 28.AUG.2018 11:27:30

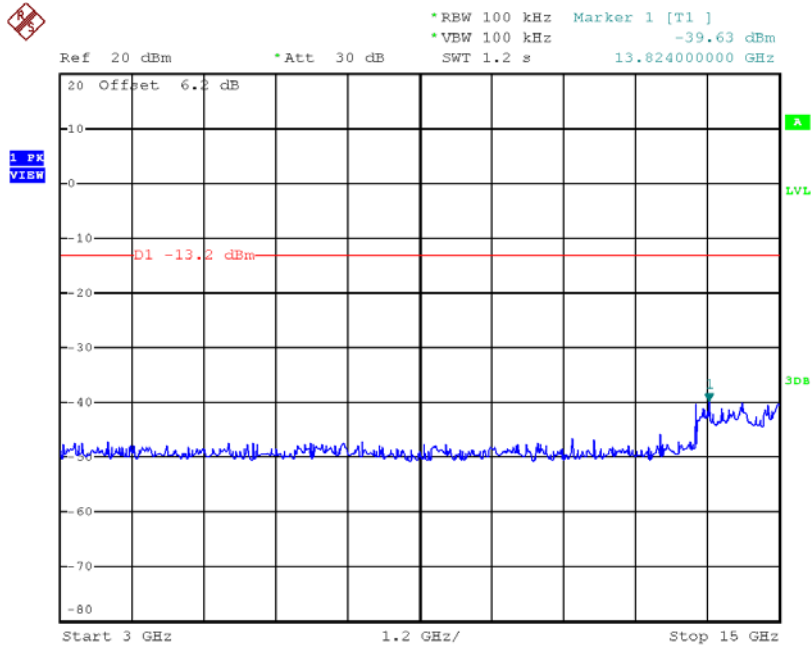

Date: 28.AUG.2018 11:27:38

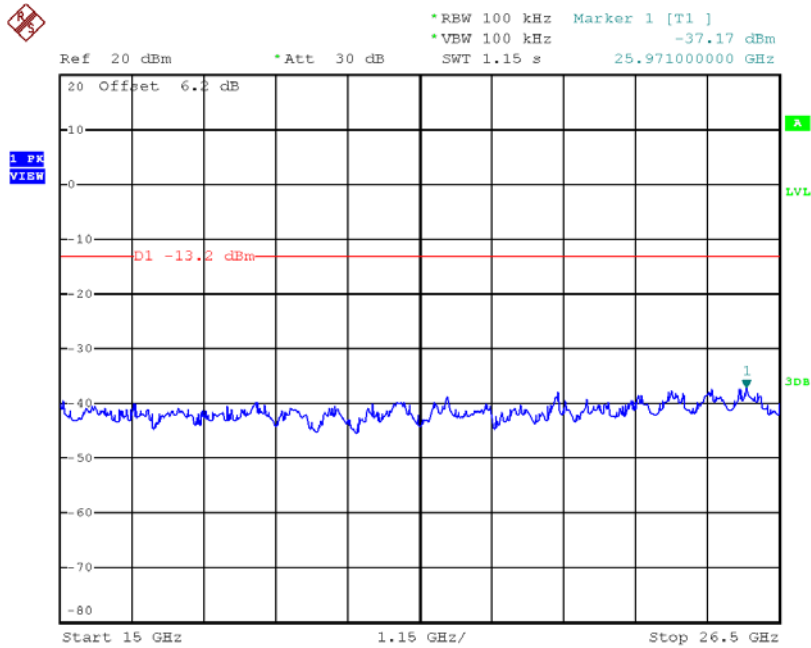

Date: 28.AUG.2018 11:27:46

CH78 (10th Harmonic of the frequency) _3Mbps

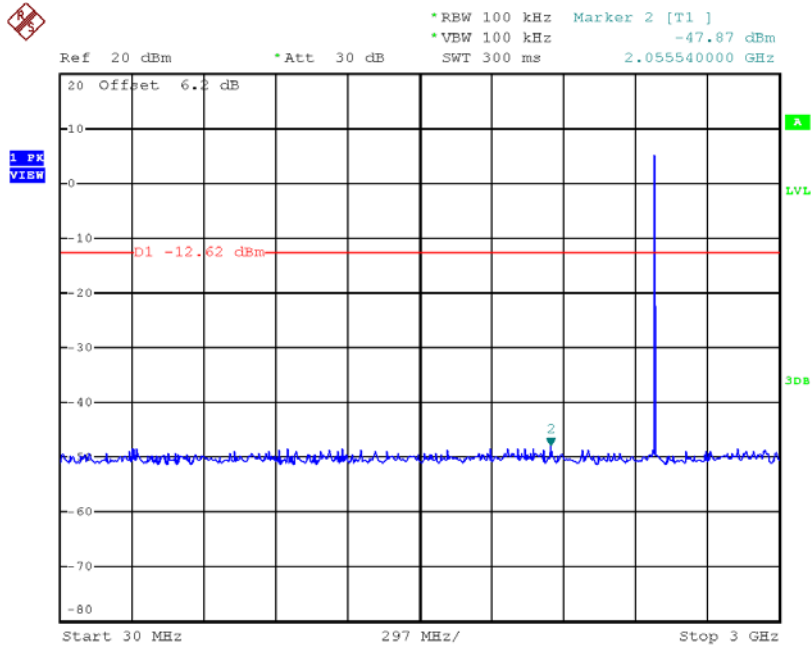

Date: 28.AUG.2018 11:29:50

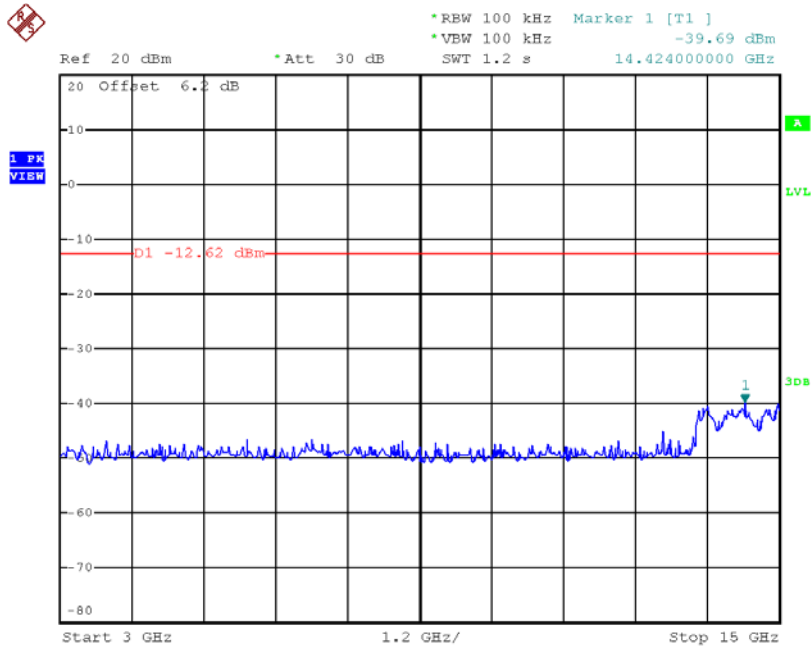

Date: 28.AUG.2018 11:29:58

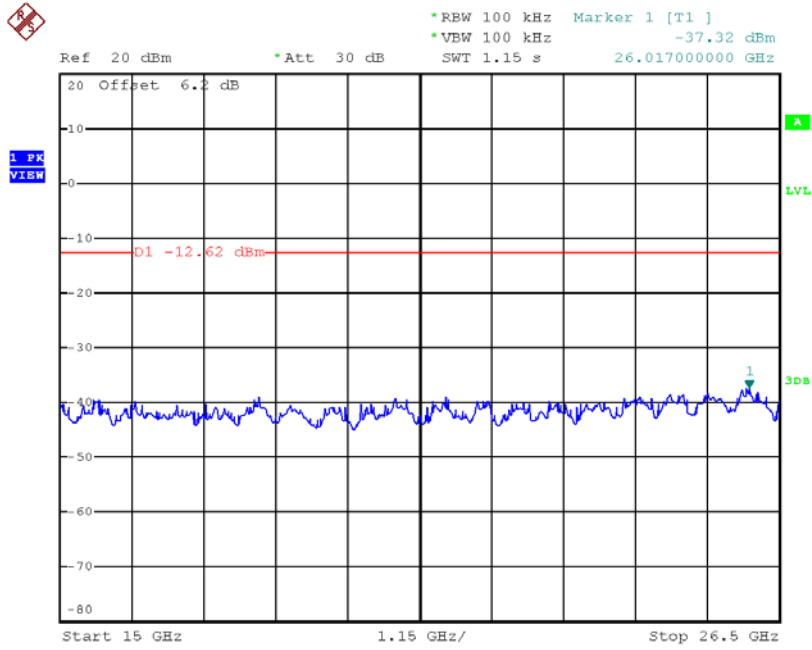

Date: 28.AUG.2018 11:30:06