



In Collaboration with  
**s p e a g**  
**CALIBRATION LABORATORY**



中国认可  
 国际互认  
 校准  
 CALIBRATION  
 CNAS L0570

Add: No.51 Xueyuan Road, Haidian District, Beijing, 100191, China  
 Tel: +86-10-62304633-2512 Fax: +86-10-62304633-2504  
 E-mail: cttl@chinattl.com [Http://www.chinattl.cn](http://www.chinattl.cn)

Client : **BTL**

Certificate No: **Z18-60132**

## CALIBRATION CERTIFICATE

Object **DAE4 - SN: 1390**

Calibration Procedure(s) **FF-Z11-002-01**  
**Calibration Procedure for the Data Acquisition Electronics (DAEx)**

Calibration date: **May 11, 2018**

This calibration Certificate documents the traceability to national standards, which realize the physical units of measurements(SI). The measurements and the uncertainties with confidence probability are given on the following pages and are part of the certificate.

All calibrations have been conducted in the closed laboratory facility: environment temperature(22±3)°C and humidity<70%.

Calibration Equipment used (M&TE critical for calibration)

Primary Standards	ID #	Cal Date(Calibrated by, Certificate No.)	Scheduled Calibration
Process Calibrator 753	1971018	27-Jun-17 (CTTL, No.J17X05859)	June-18

	Name	Function	Signature
Calibrated by:	Yu Zongying	SAR Test Engineer	
Reviewed by:	Lin Hao	SAR Test Engineer	
Approved by:	Qi Dianyuan	SAR Project Leader	

Issued: May 12, 2018

This calibration certificate shall not be reproduced except in full without written approval of the laboratory.



In Collaboration with

**s p e a g**  
**CALIBRATION LABORATORY**

Add: No.51 Xueyuan Road, Haidian District, Beijing, 100191, China  
Tel: +86-10-62304633-2512 Fax: +86-10-62304633-2504  
E-mail: cttl@chinattl.com Http://www.chinattl.cn

### **Glossary:**

DAE data acquisition electronics  
Connector angle information used in DASY system to align probe sensor X to the robot coordinate system.

### **Methods Applied and Interpretation of Parameters:**

- *DC Voltage Measurement:* Calibration Factor assessed for use in DASY system by comparison with a calibrated instrument traceable to national standards. The figure given corresponds to the full scale range of the voltmeter in the respective range.
- *Connector angle:* The angle of the connector is assessed measuring the angle mechanically by a tool inserted. Uncertainty is not required.
- The report provide only calibration results for DAE, it does not contain other performance test results.



In Collaboration with

**s p e a g**

**CALIBRATION LABORATORY**

Add: No.51 Xueyuan Road, Haidian District, Beijing, 100191, China

Tel: +86-10-62304633-2512

Fax: +86-10-62304633-2504

E-mail: cttl@chinattl.com

Http://www.chinattl.cn

## DC Voltage Measurement

A/D - Converter Resolution nominal

High Range: 1LSB = 6.1 $\mu$ V, full range = -100...+300 mV

Low Range: 1LSB = 61nV, full range = -1.....+3mV

DASY measurement parameters: Auto Zero Time: 3 sec; Measuring time: 3 sec

Calibration Factors	X	Y	Z
High Range	403.561 $\pm$ 0.15% (k=2)	403.471 $\pm$ 0.15% (k=2)	404.347 $\pm$ 0.15% (k=2)
Low Range	3.98488 $\pm$ 0.7% (k=2)	3.98399 $\pm$ 0.7% (k=2)	3.98521 $\pm$ 0.7% (k=2)

## Connector Angle

Connector Angle to be used in DASY system	70.5 $^{\circ}$ $\pm$ 1 $^{\circ}$
---	------------------------------------



In Collaboration with  
**s p e a g**  
CALIBRATION LABORATORY



中国认可  
国际互认  
校准  
CALIBRATION  
CNAS L0570

Add: No.51 Xueyuan Road, Haidian District, Beijing, 100191, China  
Tel: +86-10-62304633-2512 Fax: +86-10-62304633-2504  
E-mail: cttl@chinattl.com Http://www.chinattl.cn

Client

**BTL**

Certificate No: **Z18-60131**

## CALIBRATION CERTIFICATE

Object **EX3DV4 - SN:7396**

Calibration Procedure(s) **FF-Z11-004-01**  
**Calibration Procedures for Dosimetric E-field Probes**

Calibration date: **May 29, 2018**

This calibration Certificate documents the traceability to national standards, which realize the physical units of measurements(SI). The measurements and the uncertainties with confidence probability are given on the following pages and are part of the certificate.

All calibrations have been conducted in the closed laboratory facility: environment temperature(22±3)°C and humidity<70%.

Calibration Equipment used (M&TE critical for calibration)

Primary Standards	ID #	Cal Date(Calibrated by, Certificate No.)	Scheduled Calibration
Power Meter NRP2	101919	27-Jun-17 (CTTL, No.J17X05857)	Jun-18
Power sensor NRP-Z91	101547	27-Jun-17 (CTTL, No.J17X05857)	Jun-18
Power sensor NRP-Z91	101548	27-Jun-17 (CTTL, No.J17X05857)	Jun-18
Reference10dBAttenuator	18N50W-10dB	09-Feb-18(CTTL, No.J18X01133)	Feb-20
Reference20dBAttenuator	18N50W-20dB	09-Feb-18(CTTL, No.J18X01132)	Feb-20
Reference Probe EX3DV4	SN 3846	25-Jan-18(SPEAG,No.EX3-3846_Jan18)	Jan-19
DAE4	SN 777	15-Dec-17(SPEAG, No.DAE4-777_Dec17)	Dec -18
Secondary Standards	ID #	Cal Date(Calibrated by, Certificate No.)	Scheduled Calibration
SignalGeneratorMG3700A	6201052605	27-Jun-17 (CTTL, No.J17X05858)	Jun-18
Network Analyzer E5071C	MY46110673	14-Jan-18 (CTTL, No.J18X00561)	Jan -19

	Name	Function	Signature
Calibrated by:	Yu Zongying	SAR Test Engineer	
Reviewed by:	Lin Hao	SAR Test Engineer	
Approved by:	Qi Dianyuan	SAR Project Leader	

Issued: May 31, 2018

This calibration certificate shall not be reproduced except in full without written approval of the laboratory.



In Collaboration with

**s p e a g**  
**CALIBRATION LABORATORY**

Add: No.51 Xueyuan Road, Haidian District, Beijing, 100191, China

Tel: +86-10-62304633-2512

Fax: +86-10-62304633-2504

E-mail: [cttl@chinattl.com](mailto:cttl@chinattl.com)

[Http://www.chinattl.cn](http://www.chinattl.cn)

## Glossary:

TSL	tissue simulating liquid
NORM <sub>x,y,z</sub>	sensitivity in free space
ConvF	sensitivity in TSL / NORM <sub>x,y,z</sub>
DCP	diode compression point
CF	crest factor (1/duty_cycle) of the RF signal
A,B,C,D	modulation dependent linearization parameters
Polarization $\Phi$	$\Phi$ rotation around probe axis
Polarization $\theta$	$\theta$ rotation around an axis that is in the plane normal to probe axis (at measurement center), $\theta=0$ is normal to probe axis
Connector Angle	information used in DASY system to align probe sensor X to the robot coordinate system

## Calibration is Performed According to the Following Standards:

- IEEE Std 1528-2013, "IEEE Recommended Practice for Determining the Peak Spatial-Averaged Specific Absorption Rate (SAR) in the Human Head from Wireless Communications Devices: Measurement Techniques", June 2013
- IEC 62209-1, "Measurement procedure for the assessment of Specific Absorption Rate (SAR) from hand-held and body-mounted devices used next to the ear (frequency range of 300 MHz to 6 GHz)", July 2016
- IEC 62209-2, "Procedure to determine the Specific Absorption Rate (SAR) for wireless communication devices used in close proximity to the human body (frequency range of 30 MHz to 6 GHz)", March 2010
- KDB 865664, "SAR Measurement Requirements for 100 MHz to 6 GHz"

## Methods Applied and Interpretation of Parameters:

- NORM<sub>x,y,z</sub>**: Assessed for E-field polarization  $\theta=0$  ( $f \leq 900\text{MHz}$  in TEM-cell;  $f > 1800\text{MHz}$ : waveguide). NORM<sub>x,y,z</sub> are only intermediate values, i.e., the uncertainties of NORM<sub>x,y,z</sub> does not effect the  $E^2$ -field uncertainty inside TSL (see below ConvF).
- NORM(f)<sub>x,y,z</sub>** = NORM<sub>x,y,z</sub> \* frequency\_response (see Frequency Response Chart). This linearization is implemented in DASY4 software versions later than 4.2. The uncertainty of the frequency response is included in the stated uncertainty of ConvF.
- DCP<sub>x,y,z</sub>**: DCP are numerical linearization parameters assessed based on the data of power sweep (no uncertainty required). DCP does not depend on frequency nor media.
- PAR**: PAR is the Peak to Average Ratio that is not calibrated but determined based on the signal characteristics.
- A<sub>x,y,z</sub>; B<sub>x,y,z</sub>; C<sub>x,y,z</sub>; VR<sub>x,y,z</sub>**: A,B,C are numerical linearization parameters assessed based on the data of power sweep for specific modulation signal. The parameters do not depend on frequency nor media. VR is the maximum calibration range expressed in RMS voltage across the diode.
- ConvF and Boundary Effect Parameters**: Assessed in flat phantom using E-field (or Temperature Transfer Standard for  $f \leq 800\text{MHz}$ ) and inside waveguide using analytical field distributions based on power measurements for  $f > 800\text{MHz}$ . The same setups are used for assessment of the parameters applied for boundary compensation (alpha, depth) of which typical uncertainty valued are given. These parameters are used in DASY4 software to improve probe accuracy close to the boundary. The sensitivity in TSL corresponds to NORM<sub>x,y,z</sub>\* ConvF whereby the uncertainty corresponds to that given for ConvF. A frequency dependent ConvF is used in DASY version 4.4 and higher which allows extending the validity from  $\pm 50\text{MHz}$  to  $\pm 100\text{MHz}$ .
- Spherical isotropy (3D deviation from isotropy)**: in a field of low gradients realized using a flat phantom exposed by a patch antenna.
- Sensor Offset**: The sensor offset corresponds to the offset of virtual measurement center from the probe tip (on probe axis). No tolerance required.
- Connector Angle**: The angle is assessed using the information gained by determining the NORM<sub>x</sub> (no uncertainty required).



In Collaboration with

**s p e a g**

**CALIBRATION LABORATORY**

Add: No.51 Xueyuan Road, Haidian District, Beijing, 100191, China

Tel: +86-10-62304633-2512

Fax: +86-10-62304633-2504

E-mail: [ctl@chinattl.com](mailto:ctl@chinattl.com)

[Http://www.chinattl.cn](http://www.chinattl.cn)

# Probe EX3DV4

## SN: 7396

Calibrated: May 29, 2018

Calibrated for DASY/EASY Systems

(Note: non-compatible with DASY2 system!)



## DASY/EASY – Parameters of Probe: EX3DV4 – SN: 7396

### Basic Calibration Parameters

	Sensor X	Sensor Y	Sensor Z	Unc (k=2)
Norm( $\mu\text{V}/(\text{V}/\text{m})^2$ ) <sup>A</sup>	0.54	0.49	0.51	$\pm 10.0\%$
DCP(mV) <sup>B</sup>	98.2	103.6	102.7	

### Modulation Calibration Parameters

UID	Communication System Name		A dB	B dB/ $\mu\text{V}$	C	D dB	VR mV	Unc <sup>E</sup> (k=2)
0	CW	X	0.0	0.0	1.0	0.00	174.5	$\pm 2.9\%$
		Y	0.0	0.0	1.0		162.3	
		Z	0.0	0.0	1.0		166.2	

The reported uncertainty of measurement is stated as the standard uncertainty of Measurement multiplied by the coverage factor k=2, which for a normal distribution Corresponds to a coverage probability of approximately 95%.

<sup>A</sup> The uncertainties of Norm X, Y, Z do not affect the E<sup>2</sup>-field uncertainty inside TSL (see Page 5 and Page 6).

<sup>B</sup> Numerical linearization parameter: uncertainty not required.

<sup>E</sup> Uncertainty is determined using the max. deviation from linear response applying rectangular distribution and is expressed for the square of the field value.



## DASY/EASY – Parameters of Probe: EX3DV4 – SN: 7396

### Calibration Parameter Determined in Head Tissue Simulating Media

f [MHz] <sup>C</sup>	Relative Permittivity <sup>F</sup>	Conductivity (S/m) <sup>F</sup>	ConvF X	ConvF Y	ConvF Z	Alpha <sup>G</sup>	Depth <sup>G</sup> (mm)	Unct. (k=2)
750	41.9	0.89	10.06	10.06	10.06	0.40	0.85	± 12.1%
835	41.5	0.90	9.88	9.88	9.88	0.17	1.47	± 12.1%
900	41.5	0.97	9.85	9.85	9.85	0.14	1.71	± 12.1%
1750	40.1	1.37	8.64	8.64	8.64	0.30	0.94	± 12.1%
1900	40.0	1.40	8.18	8.18	8.18	0.26	1.01	± 12.1%
2100	39.8	1.49	8.32	8.32	8.32	0.39	0.82	± 12.1%
2300	39.5	1.67	8.10	8.10	8.10	0.50	0.70	± 12.1%
2450	39.2	1.80	7.80	7.80	7.80	0.55	0.74	± 12.1%
2600	39.0	1.96	7.50	7.50	7.50	0.40	0.96	± 12.1%
3500	37.9	2.91	7.27	7.27	7.27	0.48	1.12	± 13.3%
5200	36.0	4.66	5.70	5.70	5.70	0.40	1.52	± 13.3%
5300	35.9	4.76	5.35	5.35	5.35	0.40	1.38	± 13.3%
5600	35.5	5.07	4.94	4.94	4.94	0.40	1.25	± 13.3%
5800	35.3	5.27	5.05	5.05	5.05	0.40	1.40	± 13.3%

<sup>C</sup> Frequency validity above 300 MHz of ±100MHz only applies for DASY v4.4 and higher (Page 2), else it is restricted to ±50MHz. The uncertainty is the RSS of ConvF uncertainty at calibration frequency and the uncertainty for the indicated frequency band. Frequency validity below 300 MHz is ± 10, 25, 40, 50 and 70 MHz for ConvF assessments at 30, 64, 128, 150 and 220 MHz respectively. Above 5 GHz frequency validity can be extended to ± 110 MHz.

<sup>F</sup> At frequency below 3 GHz, the validity of tissue parameters ( $\epsilon$  and  $\sigma$ ) can be relaxed to ±10% if liquid compensation formula is applied to measured SAR values. At frequencies above 3 GHz, the validity of tissue parameters ( $\epsilon$  and  $\sigma$ ) is restricted to ±5%. The uncertainty is the RSS of the ConvF uncertainty for indicated target tissue parameters.

<sup>G</sup> Alpha/Depth are determined during calibration. SPEAG warrants that the remaining deviation due to the boundary effect after compensation is always less than ± 1% for frequencies below 3 GHz and below ± 2% for the frequencies between 3-6 GHz at any distance larger than half the probe tip diameter from the boundary.





## DASY/EASY – Parameters of Probe: EX3DV4 – SN: 7396

### Calibration Parameter Determined in Body Tissue Simulating Media

f [MHz] <sup>C</sup>	Relative Permittivity <sup>F</sup>	Conductivity (S/m) <sup>F</sup>	ConvF X	ConvF Y	ConvF Z	Alpha <sup>G</sup>	Depth <sup>G</sup> (mm)	Unct. (k=2)
750	55.5	0.96	10.30	10.30	10.30	0.40	0.80	± 12.1%
835	55.2	0.97	9.89	9.89	9.89	0.28	1.15	± 12.1%
900	55.0	1.05	9.88	9.88	9.88	0.23	1.26	± 12.1%
1750	53.4	1.49	8.20	8.20	8.20	0.25	1.03	± 12.1%
1900	53.3	1.52	7.91	7.91	7.91	0.19	1.20	± 12.1%
2100	53.2	1.62	8.35	8.35	8.35	0.29	1.06	± 12.1%
2300	52.9	1.81	7.91	7.91	7.91	0.57	0.79	± 12.1%
2450	52.7	1.95	7.70	7.70	7.70	0.37	1.14	± 12.1%
2600	52.5	2.16	7.30	7.30	7.30	0.61	0.74	± 12.1%
3500	51.3	3.31	6.79	6.79	6.79	0.48	1.12	± 13.3%
5200	49.0	5.30	5.30	5.30	5.30	0.40	1.82	± 13.3%
5300	48.9	5.42	5.05	5.05	5.05	0.55	1.17	± 13.3%
5600	48.5	5.77	4.38	4.38	4.38	0.57	1.18	± 13.3%
5800	48.2	6.00	4.50	4.50	4.50	0.50	1.60	± 13.3%

<sup>C</sup> Frequency validity above 300 MHz of ±100MHz only applies for DASY v4.4 and higher (Page 2), else it is restricted to ±50MHz. The uncertainty is the RSS of ConvF uncertainty at calibration frequency and the uncertainty for the indicated frequency band. Frequency validity below 300 MHz is ± 10, 25, 40, 50 and 70 MHz for ConvF assessments at 30, 64, 128, 150 and 220 MHz respectively. Above 5 GHz frequency validity can be extended to ± 110 MHz.

<sup>F</sup> At frequency below 3 GHz, the validity of tissue parameters ( $\epsilon$  and  $\sigma$ ) can be relaxed to ±10% if liquid compensation formula is applied to measured SAR values. At frequencies above 3 GHz, the validity of tissue parameters ( $\epsilon$  and  $\sigma$ ) is restricted to ±5%. The uncertainty is the RSS of the ConvF uncertainty for indicated target tissue parameters.

<sup>G</sup> Alpha/Depth are determined during calibration. SPEAG warrants that the remaining deviation due to the boundary effect after compensation is always less than ± 1% for frequencies below 3 GHz and below ± 2% for the frequencies between 3-6 GHz at any distance larger than half the probe tip diameter from the boundary.



Add: No.51 Xueyuan Road, Haidian District, Beijing, 100191, China  
Tel: +86-10-62304633-2512 Fax: +86-10-62304633-2504  
E-mail: [cttl@chinattl.com](mailto:cttl@chinattl.com) [Http://www.chinattl.cn](http://www.chinattl.cn)

## Frequency Response of E-Field (TEM-Cell: ifi110 EXX, Waveguide: R22)

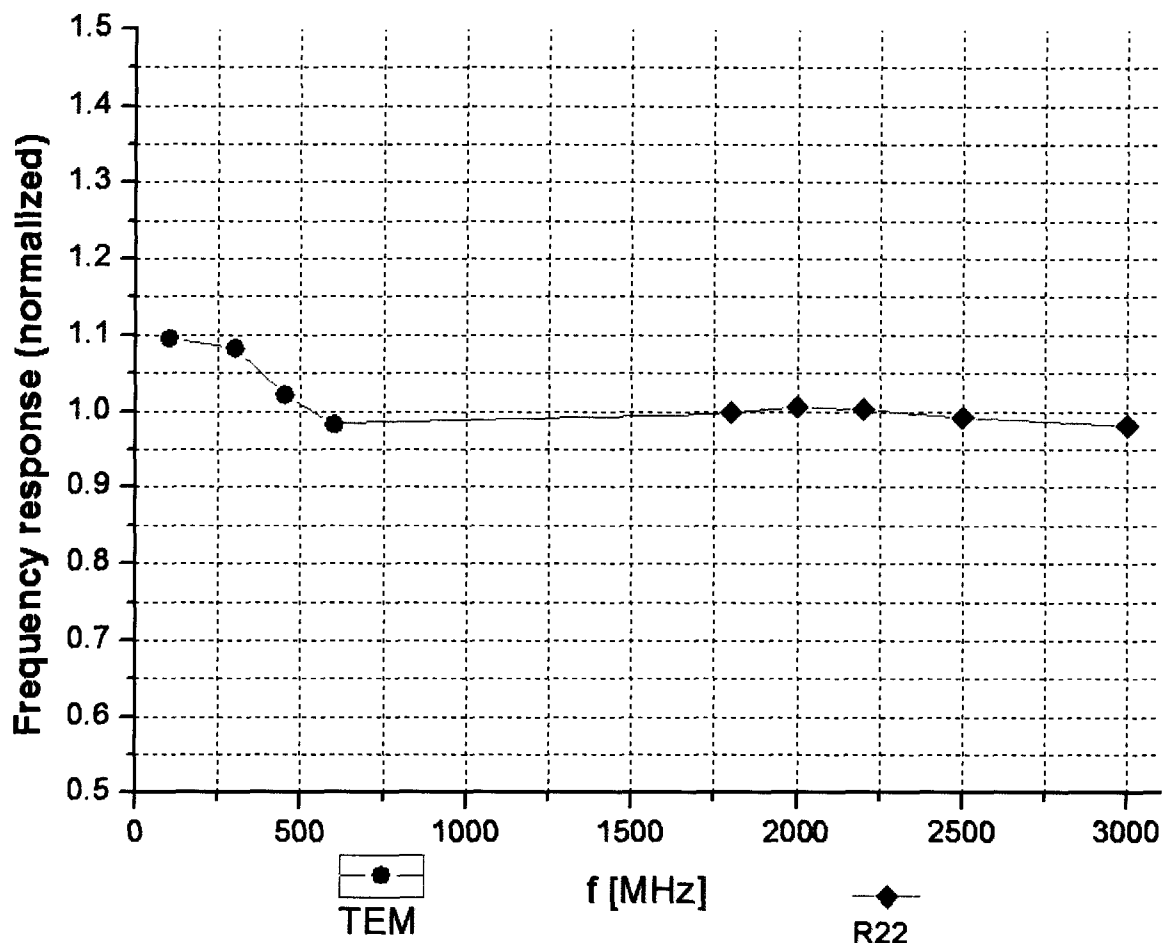

Uncertainty of Frequency Response of E-field:  $\pm 7.4\%$  ( $k=2$ )



Add: No.51 Xueyuan Road, Haidian District, Beijing, 100191, China  
Tel: +86-10-62304633-2512 Fax: +86-10-62304633-2504  
E-mail: cttl@chinattl.com [Http://www.chinattl.cn](http://www.chinattl.cn)

## Receiving Pattern ( $\Phi$ ), $\theta=0^\circ$

**f=600 MHz, TEM**

**f=1800 MHz, R22**

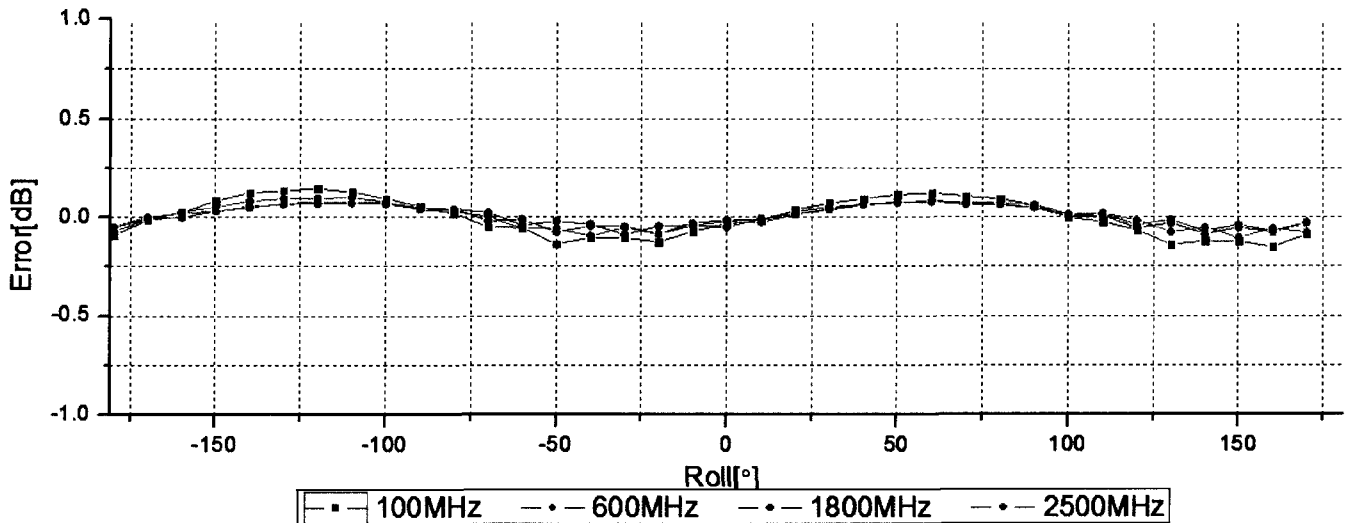
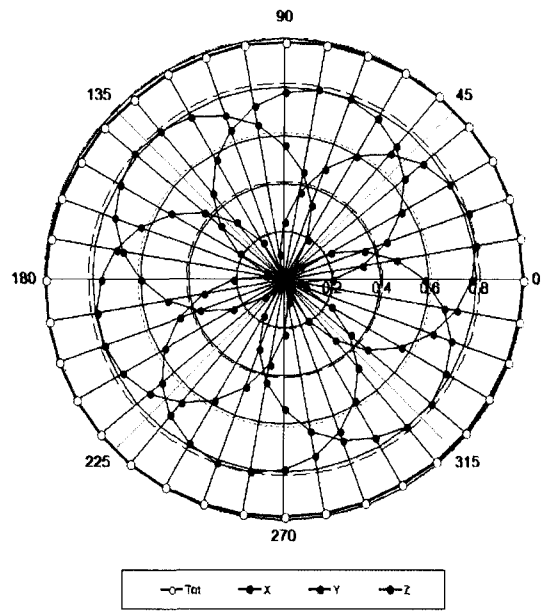
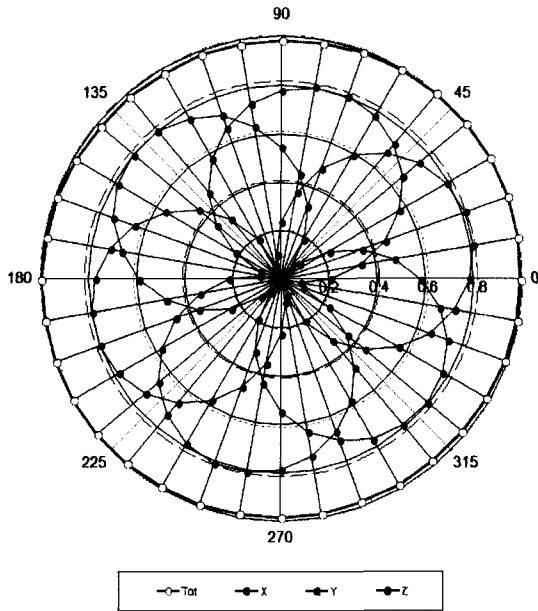

**Uncertainty of Axial Isotropy Assessment:  $\pm 1.2\%$  (k=2)**



Add: No.51 Xueyuan Road, Haidian District, Beijing, 100191, China  
Tel: +86-10-62304633-2512 Fax: +86-10-62304633-2504  
E-mail: [ctl@chinattl.com](mailto:ctl@chinattl.com) [Http://www.chinattl.cn](http://www.chinattl.cn)

## Dynamic Range f(SAR<sub>head</sub>) (TEM cell, f = 900 MHz)

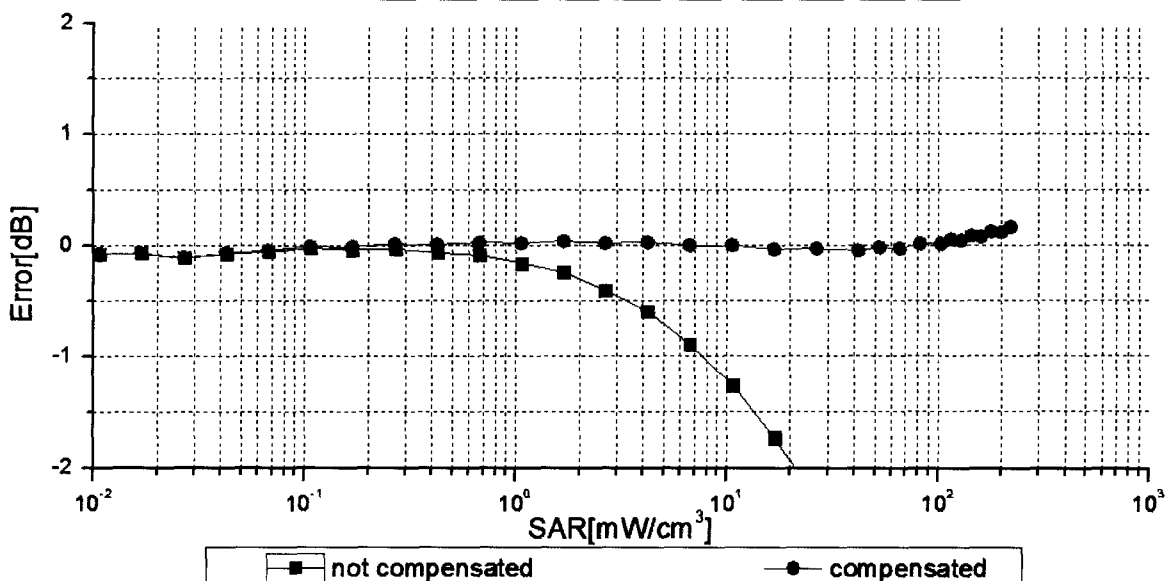
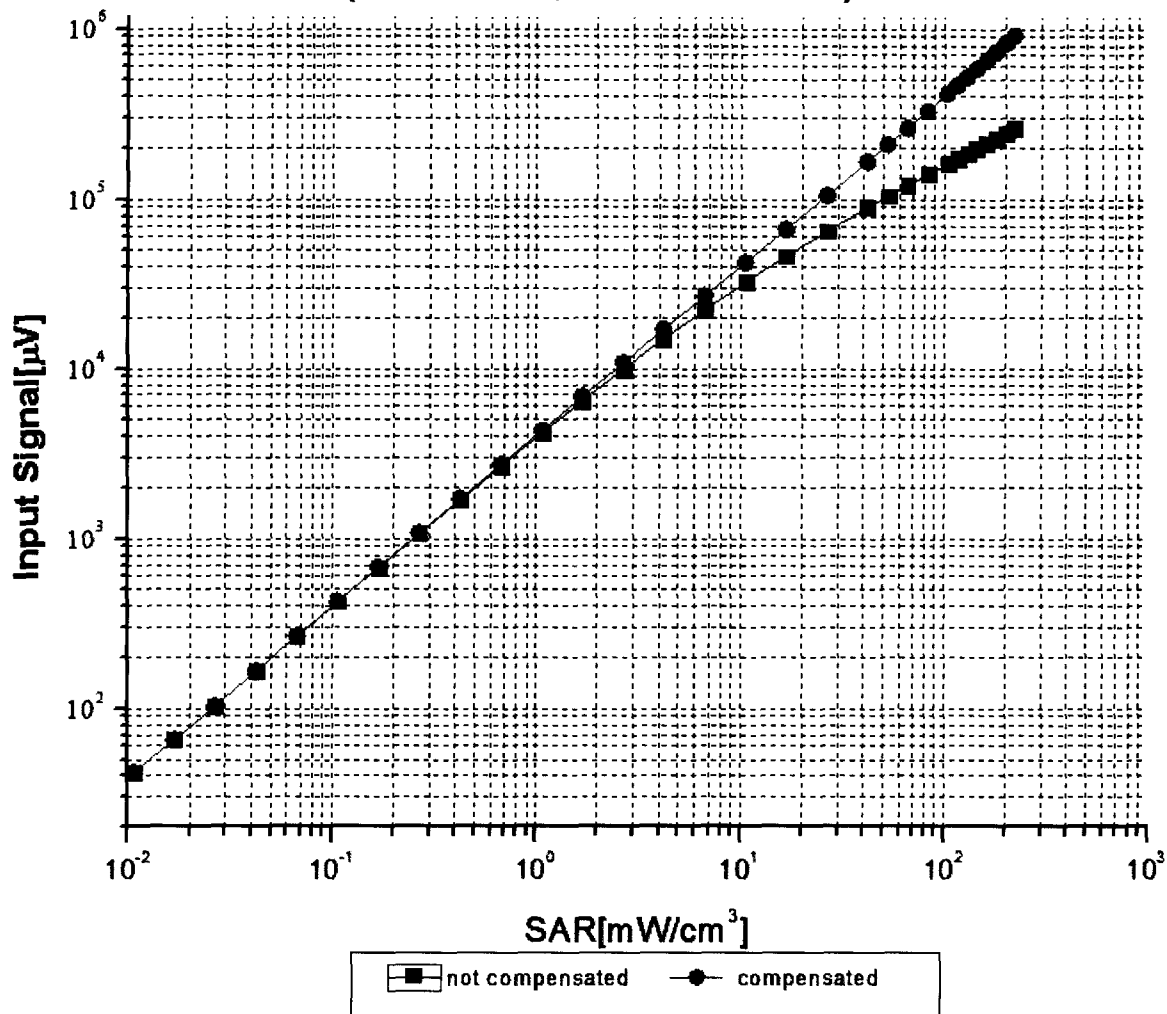

Uncertainty of Linearity Assessment: ±0.9% (k=2)



Add: No.51 Xueyuan Road, Haidian District, Beijing, 100191, China  
Tel: +86-10-62304633-2512 Fax: +86-10-62304633-2504  
E-mail: cttl@chinattl.com [Http://www.chinattl.cn](http://www.chinattl.cn)

## Conversion Factor Assessment

f=750 MHz, WGLS R9(H\_convF)

f=1750 MHz, WGLS R22(H\_convF)

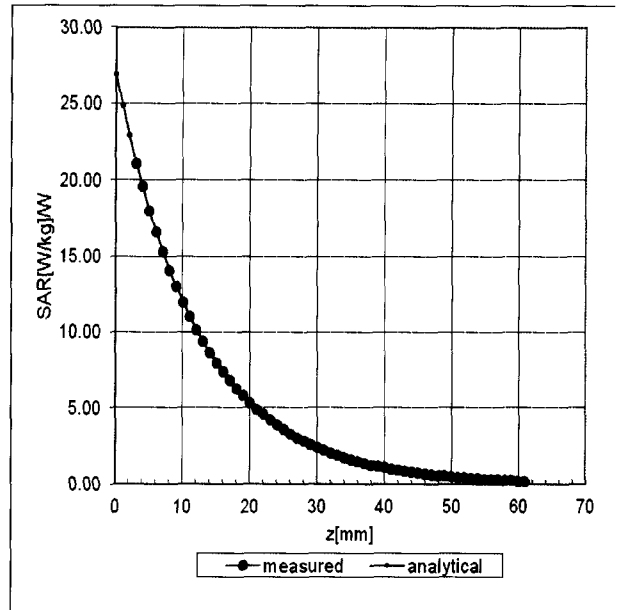
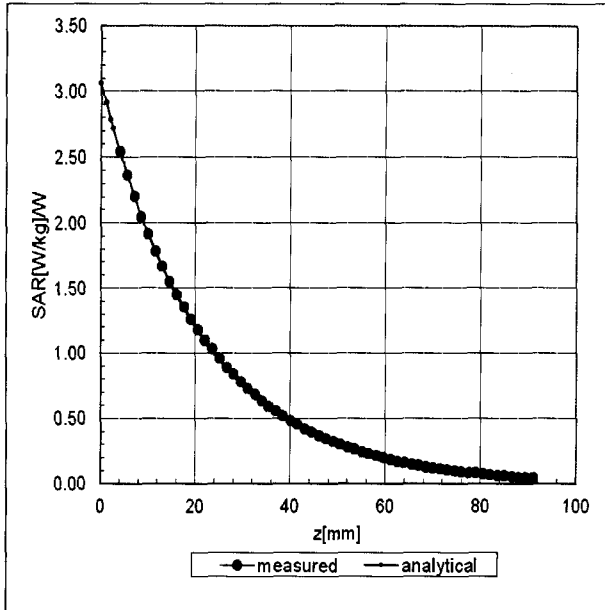

## Deviation from Isotropy in Liquid

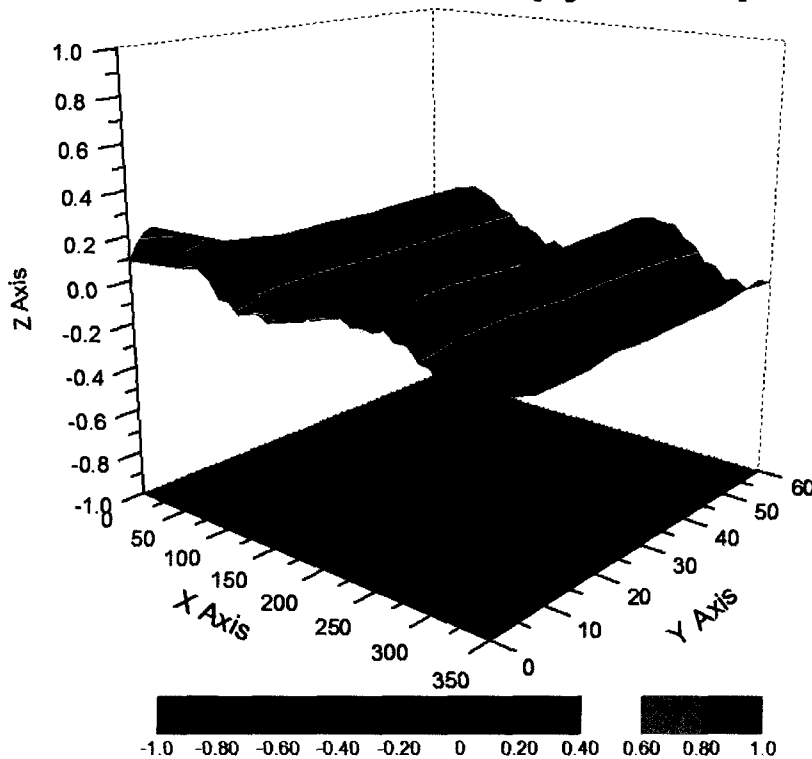

Uncertainty of Spherical Isotropy Assessment:  $\pm 3.2\%$  (K=2)



In Collaboration with  
**s p e a g**  
**CALIBRATION LABORATORY**

Add: No.51 Xueyuan Road, Haidian District, Beijing, 100191, China  
Tel: +86-10-62304633-2512 Fax: +86-10-62304633-2504  
E-mail: [ctl@chinattl.com](mailto:ctl@chinattl.com) [Http://www.chinattl.cn](http://www.chinattl.cn)

## DASY/EASY – Parameters of Probe: EX3DV4 – SN: 7396

### Other Probe Parameters

<b>Sensor Arrangement</b>	<b>Triangular</b>
<b>Connector Angle (°)</b>	<b>39.7</b>
<b>Mechanical Surface Detection Mode</b>	<b>enabled</b>
<b>Optical Surface Detection Mode</b>	<b>disable</b>
<b>Probe Overall Length</b>	<b>337mm</b>
<b>Probe Body Diameter</b>	<b>10mm</b>
<b>Tip Length</b>	<b>9mm</b>
<b>Tip Diameter</b>	<b>2.5mm</b>
<b>Probe Tip to Sensor X Calibration Point</b>	<b>1mm</b>
<b>Probe Tip to Sensor Y Calibration Point</b>	<b>1mm</b>
<b>Probe Tip to Sensor Z Calibration Point</b>	<b>1mm</b>
<b>Recommended Measurement Distance from Surface</b>	<b>1.4mm</b>



In Collaboration with  
**s p e a g**  
CALIBRATION LABORATORY



中国认可  
国际互认  
校准  
CALIBRATION  
CNAS L0570

Add: No.51 Xueyuan Road, Haidian District, Beijing, 100191, China  
Tel: +86-10-62304633-2079 Fax: +86-10-62304633-2504  
E-mail: cttl@chinattl.com http://www.chinattl.cn

Client **BTL Inc .**

Certificate No: **Z18-60176**

## CALIBRATION CERTIFICATE

Object **D750V3 - SN: 1095**

Calibration Procedure(s) **FF-Z11-003-01**  
**Calibration Procedures for dipole validation kits**

Calibration date: **June 5, 2018**

This calibration Certificate documents the traceability to national standards, which realize the physical units of measurements(SI). The measurements and the uncertainties with confidence probability are given on the following pages and are part of the certificate.

All calibrations have been conducted in the closed laboratory facility: environment temperature(22±3)°C and humidity<70%.

Calibration Equipment used (M&TE critical for calibration)

Primary Standards	ID #	Cal Date(Calibrated by, Certificate No.)	Scheduled Calibration
Power Meter NRVD	102083	01-Nov-17 (CTTL, No.J17X08756)	Oct-18
Power sensor NRV-Z5	100542	01-Nov-17 (CTTL, No.J17X08756)	Oct-18
Reference Probe EX3DV4	SN 7464	12-Sep-17(SPEAG,No.EX3-7464_Sep17)	Sep-18
DAE4	SN 1525	02-Oct-17(SPEAG,No.DAE4-1525_Oct17)	Oct-18
Secondary Standards	ID #	Cal Date(Calibrated by, Certificate No.)	Scheduled Calibration
Signal Generator E4438C	MY49071430	23-Jan-18 (CTTL, No.J18X00560)	Jan-19
NetworkAnalyzer E5071C	MY46110673	24-Jan-18 (CTTL, No.J18X00561)	Jan-19

	Name	Function	Signature
Calibrated by:	Zhao Jing	SAR Test Engineer	
Reviewed by:	Lin Hao	SAR Test Engineer	
Approved by:	Qi Dianyuan	SAR Project Leader	

Issued: June 11, 2018

This calibration certificate shall not be reproduced except in full without written approval of the laboratory.



In Collaboration with

**s p e a g**  
CALIBRATION LABORATORY

Add: No.51 Xueyuan Road, Haidian District, Beijing, 100191, China  
Tel: +86-10-62304633-2079 Fax: +86-10-62304633-2504  
E-mail: cttl@chinattl.com http://www.chinattl.cn

### Glossary:

TSL	tissue simulating liquid
ConvF	sensitivity in TSL / NORM <sub>x,y,z</sub>
N/A	not applicable or not measured

### Calibration is Performed According to the Following Standards:

- IEEE Std 1528-2013, "IEEE Recommended Practice for Determining the Peak Spatial-Averaged Specific Absorption Rate (SAR) in the Human Head from Wireless Communications Devices: Measurement Techniques", June 2013
- IEC 62209-1, "Measurement procedure for assessment of specific absorption rate of human exposure to radio frequency fields from hand-held and body-mounted wireless communication devices- Part 1: Device used next to the ear (Frequency range of 300MHz to 6GHz)", July 2016
- IEC 62209-2, "Procedure to measure the Specific Absorption Rate (SAR) For wireless communication devices used in close proximity to the human body (frequency range of 30MHz to 6GHz)", March 2010
- KDB865664, SAR Measurement Requirements for 100 MHz to 6 GHz

### Additional Documentation:

- DASY4/5 System Handbook

### Methods Applied and Interpretation of Parameters:

- Measurement Conditions:** Further details are available from the Validation Report at the end of the certificate. All figures stated in the certificate are valid at the frequency indicated.
- Antenna Parameters with TSL:** The dipole is mounted with the spacer to position its feed point exactly below the center marking of the flat phantom section, with the arms oriented parallel to the body axis.
- Feed Point Impedance and Return Loss:** These parameters are measured with the dipole positioned under the liquid filled phantom. The impedance stated is transformed from the measurement at the SMA connector to the feed point. The Return Loss ensures low reflected power. No uncertainty required.
- Electrical Delay:** One-way delay between the SMA connector and the antenna feed point. No uncertainty required.
- SAR measured:** SAR measured at the stated antenna input power.
- SAR normalized:** SAR as measured, normalized to an input power of 1 W at the antenna connector.
- SAR for nominal TSL parameters:** The measured TSL parameters are used to calculate the nominal SAR result.

The reported uncertainty of measurement is stated as the standard uncertainty of Measurement multiplied by the coverage factor  $k=2$ , which for a normal distribution Corresponds to a coverage probability of approximately 95%.





Add: No.51 Xueyuan Road, Haidian District, Beijing, 100191, China  
 Tel: +86-10-62304633-2079 Fax: +86-10-62304633-2504  
 E-mail: cttl@chinattl.com http://www.chinattl.cn

### Measurement Conditions

DASY system configuration, as far as not given on page 1.

DASY Version	DASY52	52.10.1.1476
Extrapolation	Advanced Extrapolation	
Phantom	Triple Flat Phantom 5.1C	
Distance Dipole Center - TSL	15 mm	with Spacer
Zoom Scan Resolution	dx, dy, dz = 5 mm	
Frequency	750 MHz $\pm$ 1 MHz	

### Head TSL parameters

The following parameters and calculations were applied.

	Temperature	Permittivity	Conductivity
Nominal Head TSL parameters	22.0 °C	41.9	0.89 mho/m
Measured Head TSL parameters	(22.0 $\pm$ 0.2) °C	42.9 $\pm$ 6 %	0.86 mho/m $\pm$ 6 %
Head TSL temperature change during test	<1.0 °C	---	---

### SAR result with Head TSL

SAR averaged over 1 cm <sup>3</sup> (1 g) of Head TSL	Condition	
SAR measured	250 mW input power	2.06 mW / g
SAR for nominal Head TSL parameters	normalized to 1W	8.47 mW / g $\pm$ 18.8 % (k=2)
SAR averaged over 10 cm <sup>3</sup> (10 g) of Head TSL	Condition	
SAR measured	250 mW input power	1.38 mW / g
SAR for nominal Head TSL parameters	normalized to 1W	5.64 mW / g $\pm$ 18.7 % (k=2)

### Body TSL parameters

The following parameters and calculations were applied.

	Temperature	Permittivity	Conductivity
Nominal Body TSL parameters	22.0 °C	55.5	0.96 mho/m
Measured Body TSL parameters	(22.0 $\pm$ 0.2) °C	55.8 $\pm$ 6 %	0.93 mho/m $\pm$ 6 %
Body TSL temperature change during test	<1.0 °C	---	---

### SAR result with Body TSL

SAR averaged over 1 cm <sup>3</sup> (1 g) of Body TSL	Condition	
SAR measured	250 mW input power	2.08 mW / g
SAR for nominal Body TSL parameters	normalized to 1W	8.51 mW / g $\pm$ 18.8 % (k=2)
SAR averaged over 10 cm <sup>3</sup> (10 g) of Body TSL	Condition	
SAR measured	250 mW input power	1.39 mW / g
SAR for nominal Body TSL parameters	normalized to 1W	5.66 mW / g $\pm$ 18.7 % (k=2)



Add: No.51 Xueyuan Road, Haidian District, Beijing, 100191, China  
Tel: +86-10-62304633-2079 Fax: +86-10-62304633-2504  
E-mail: cttl@chinattl.com http://www.chinattl.cn

## Appendix (Additional assessments outside the scope of CNAS L0570)

### Antenna Parameters with Head TSL

Impedance, transformed to feed point	52.9 $\Omega$ - 1.15j $\Omega$
Return Loss	- 30.4dB

### Antenna Parameters with Body TSL

Impedance, transformed to feed point	47.9 $\Omega$ - 2.43j $\Omega$
Return Loss	- 29.6dB

### General Antenna Parameters and Design

Electrical Delay (one direction)	0.897 ns
----------------------------------	----------

After long term use with 100W radiated power, only a slight warming of the dipole near the feedpoint can be measured.

The dipole is made of standard semirigid coaxial cable. The center conductor of the feeding line is directly connected to the second arm of the dipole. The antenna is therefore short-circuited for DC-signals. On some of the dipoles, small end caps are added to the dipole arms in order to improve matching when loaded according to the position as explained in the "Measurement Conditions" paragraph. The SAR data are not affected by this change. The overall dipole length is still according to the Standard.

No excessive force must be applied to the dipole arms, because they might bend or the soldered connections near the feedpoint may be damaged.

### Additional EUT Data

Manufactured by	SPEAG
-----------------	-------



Add: No.51 Xueyuan Road, Haidian District, Beijing, 100191, China  
Tel: +86-10-62304633-2079 Fax: +86-10-62304633-2504  
E-mail: cttl@chinattl.com http://www.chinattl.cn

**DASY5 Validation Report for Head TSL**

Date: 06.04.2018

Test Laboratory: CTTL, Beijing, China

**DUT: Dipole 750 MHz; Type: D750V3; Serial: D750V3 - SN: 1095**

Communication System: UID 0, CW; Frequency: 750 MHz; Duty Cycle: 1:1

Medium parameters used:  $f = 750$  MHz;  $\sigma = 0.864$  S/m;  $\epsilon_r = 42.91$ ;  $\rho = 1000$  kg/m<sup>3</sup>

Phantom section: Right Section

DASY5 Configuration:

- Probe: EX3DV4 - SN7464; ConvF(10.57, 10.57, 10.57) @ 750 MHz; Calibrated: 9/12/2017
- Sensor-Surface: 1.4mm (Mechanical Surface Detection)
- Electronics: DAE4 Sn1525; Calibrated: 10/2/2017
- Phantom: MFP\_V5.1C ; Type: QD 000 P51CA; Serial: 1062
- Measurement SW: DASY52, Version 52.10 (1); SEMCAD X Version 14.6.11 (7439)

**Dipole Calibration/Zoom Scan (7x7x7) (7x7x7)/Cube 0:** Measurement grid: dx=5mm, dy=5mm, dz=5mm

Reference Value = 53.80 V/m; Power Drift = 0.04 dB

Peak SAR (extrapolated) = 3.05 W/kg

**SAR(1 g) = 2.06 W/kg; SAR(10 g) = 1.38 W/kg**

Maximum value of SAR (measured) = 2.70 W/kg

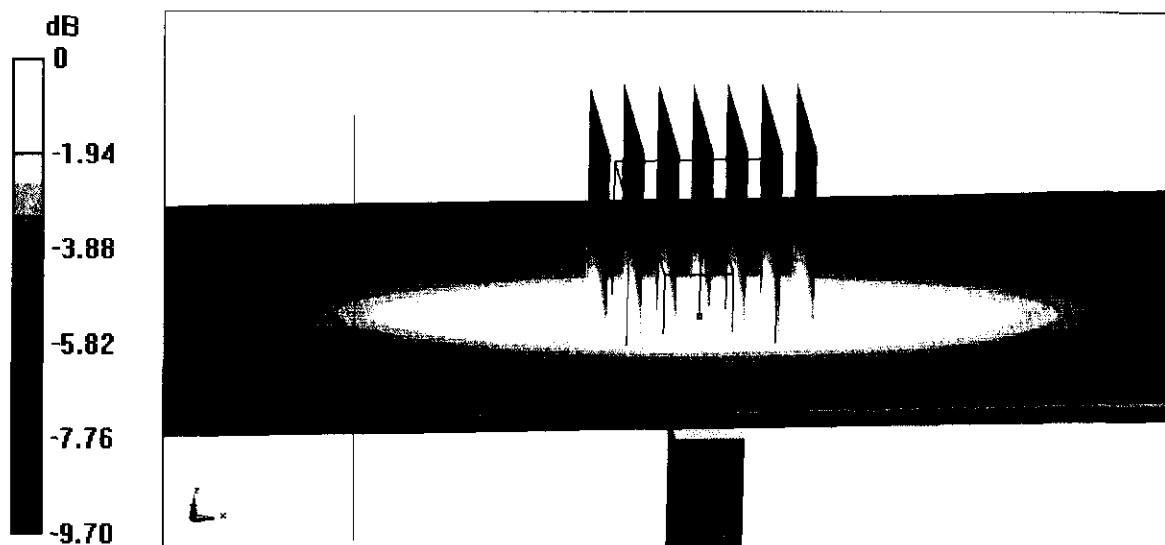

**0 dB = 2.70 W/kg = 4.31 dBW/kg**



Add: No.51 Xueyuan Road, Haidian District, Beijing, 100191, China  
Tel: +86-10-62304633-2079 Fax: +86-10-62304633-2504  
E-mail: cttl@chinattl.com http://www.chinattl.cn

### Impedance Measurement Plot for Head TSL

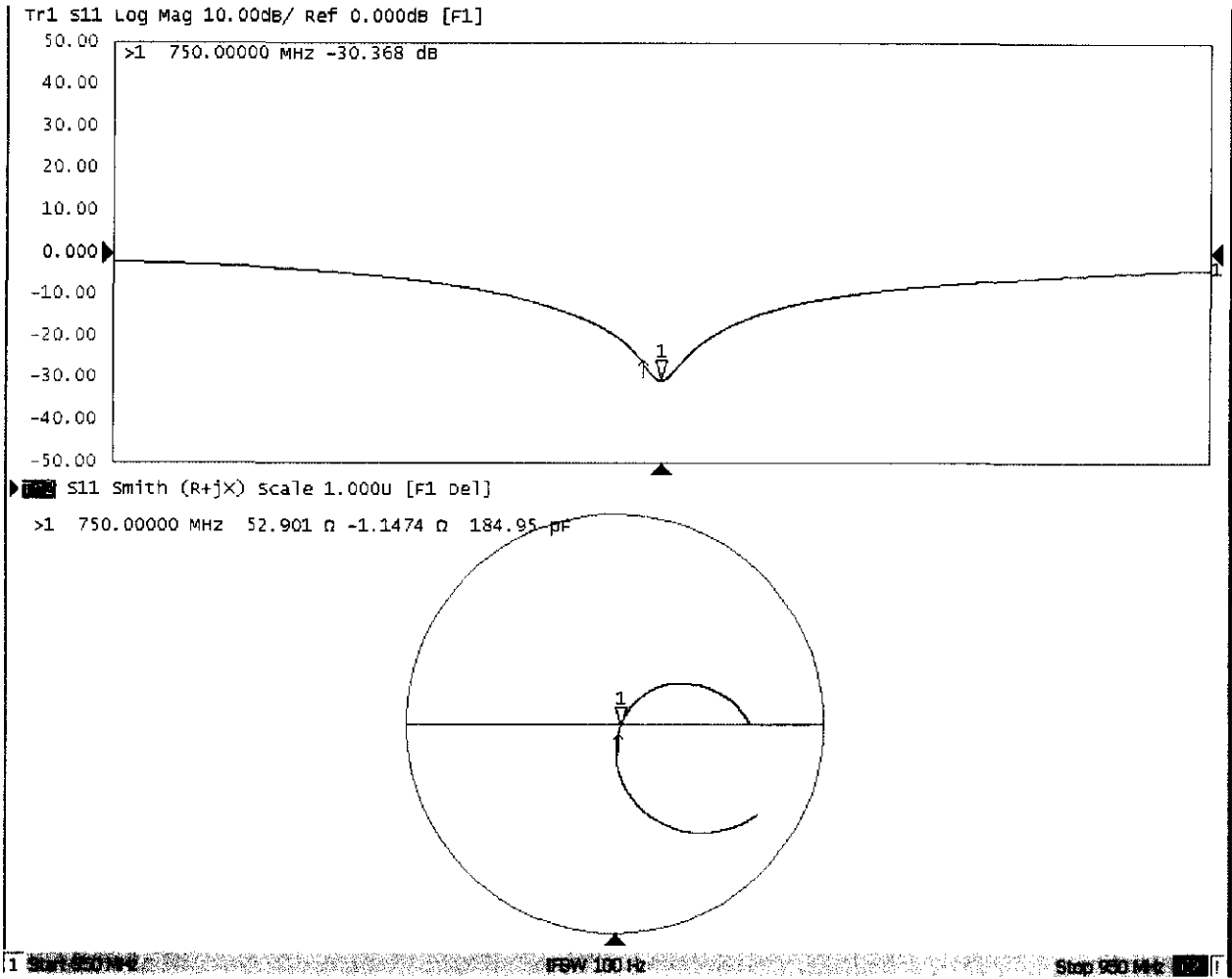



Add: No.51 Xueyuan Road, Haidian District, Beijing, 100191, China  
Tel: +86-10-62304633-2079 Fax: +86-10-62304633-2504  
E-mail: cttl@chinattl.com http://www.chinattl.cn

**DASY5 Validation Report for Body TSL**

Date: 06.04.2018

Test Laboratory: CTTL, Beijing, China

**DUT: Dipole 750 MHz; Type: D750V3; Serial: D750V3 - SN: 1095**

Communication System: UID 0, CW; Frequency: 750 MHz; Duty Cycle: 1:1

Medium parameters used:  $f = 750$  MHz;  $\sigma = 0.933$  S/m;  $\epsilon_r = 55.8$ ;  $\rho = 1000$  kg/m<sup>3</sup>

Phantom section: Left Section

DASY5 Configuration:

- Probe: EX3DV4 - SN7464; ConvF(10.63, 10.63, 10.63) @ 750 MHz; Calibrated: 9/12/2017
- Sensor-Surface: 1.4mm (Mechanical Surface Detection)
- Electronics: DAE4 Sn1525; Calibrated: 10/2/2017
- Phantom: MFP\_V5.1C ; Type: QD 000 P51CA; Serial: 1062
- Measurement SW: DASY52, Version 52.10 (1); SEMCAD X Version 14.6.11 (7439)

**Dipole Calibration/Zoom Scan (7x7x7) (7x7x7)/Cube 0:** Measurement grid: dx=5mm, dy=5mm, dz=5mm

Reference Value = 53.27 V/m; Power Drift = 0.00 dB

Peak SAR (extrapolated) = 3.09 W/kg

**SAR(1 g) = 2.08 W/kg; SAR(10 g) = 1.39 W/kg**

Maximum value of SAR (measured) = 2.76 W/kg

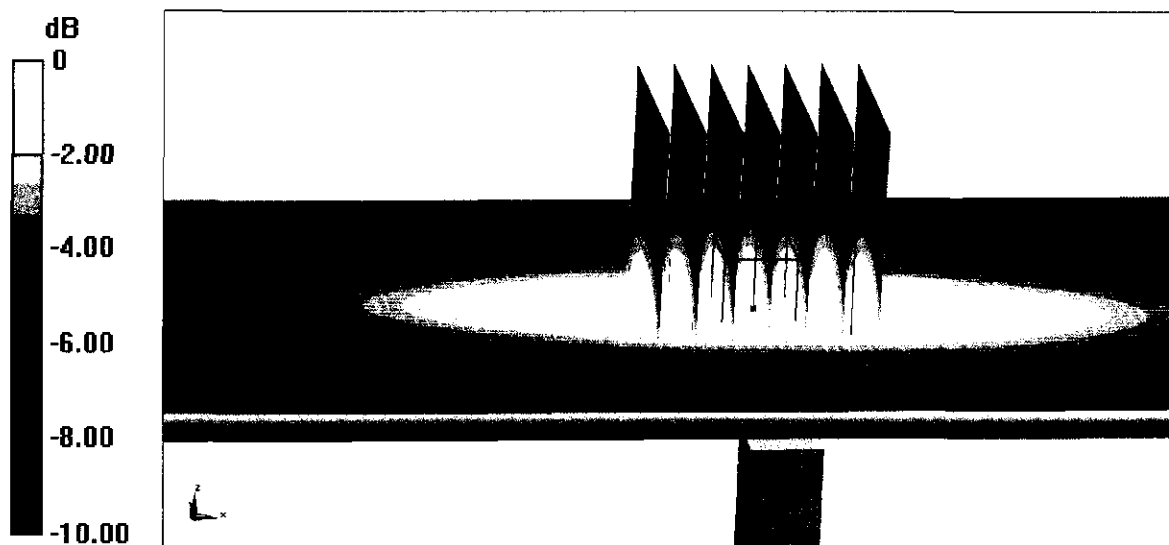

0 dB = 2.76 W/kg = 4.41 dBW/kg



Add: No.51 Xueyuan Road, Haidian District, Beijing, 100191, China  
Tel: +86-10-62304633-2079 Fax: +86-10-62304633-2504  
E-mail: cttl@chinattl.com http://www.chinattl.cn

### Impedance Measurement Plot for Body TSL

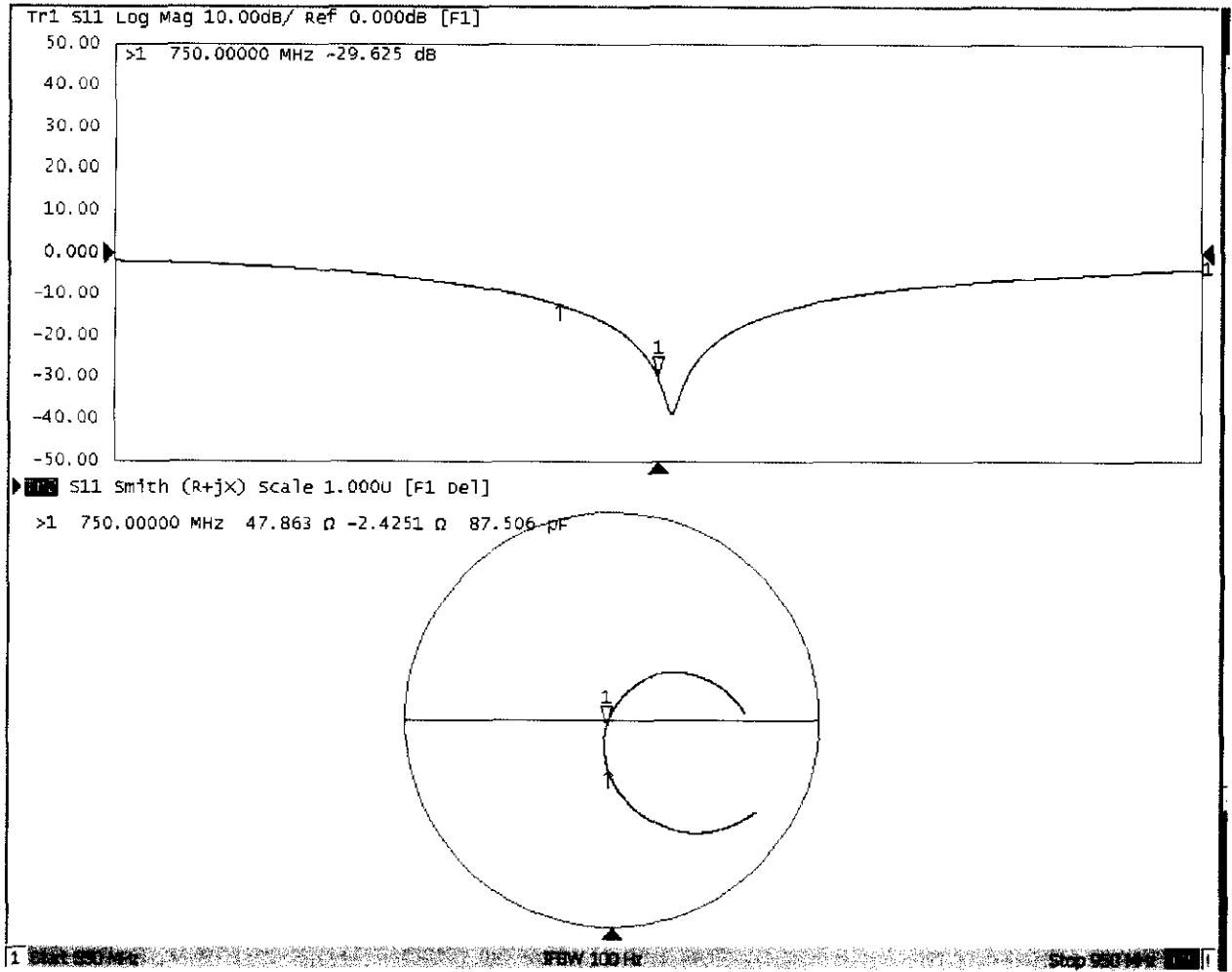



In Collaboration with  
**s p e a g**  
CALIBRATION LABORATORY



中国认可  
国际互认  
校准  
CALIBRATION  
CNAS L0570

Add: No.51 Xueyuan Road, Haidian District, Beijing, 100191, China  
Tel: +86-10-62304633-2079 Fax: +86-10-62304633-2504  
E-mail: cttl@chinattl.com http://www.chinattl.cn

Client **BTL Inc .**

Certificate No: **Z18-60177**

## CALIBRATION CERTIFICATE

Object **D835V2 - SN: 4d160**

Calibration Procedure(s) **FF-Z11-003-01**  
**Calibration Procedures for dipole validation kits**

Calibration date: **June 5, 2018**

This calibration Certificate documents the traceability to national standards, which realize the physical units of measurements(SI). The measurements and the uncertainties with confidence probability are given on the following pages and are part of the certificate.

All calibrations have been conducted in the closed laboratory facility: environment temperature(22±3)°C and humidity<70%.

Calibration Equipment used (M&TE critical for calibration)

Primary Standards	ID #	Cal Date(Calibrated by, Certificate No.)	Scheduled Calibration
Power Meter NRVD	102083	01-Nov-17 (CTTL, No.J17X08756)	Oct-18
Power sensor NRV-Z5	100542	01-Nov-17 (CTTL, No.J17X08756)	Oct-18
Reference Probe EX3DV4	SN 7464	12-Sep-17(SPEAG,No.EX3-7464_Sep17)	Sep-18
DAE4	SN 1525	02-Oct-17(SPEAG,No.DAE4-1525_Oct17)	Oct-18
Secondary Standards	ID #	Cal Date(Calibrated by, Certificate No.)	Scheduled Calibration
Signal Generator E4438C	MY49071430	23-Jan-18 (CTTL, No.J18X00560)	Jan-19
NetworkAnalyzer E5071C	MY46110673	24-Jan-18 (CTTL, No.J18X00561)	Jan-19

	Name	Function	Signature
Calibrated by:	Zhao Jing	SAR Test Engineer	
Reviewed by:	Lin Hao	SAR Test Engineer	
Approved by:	Qi Dianyuan	SAR Project Leader	

Issued: June 11, 2018

This calibration certificate shall not be reproduced except in full without written approval of the laboratory.



In Collaboration with

**s p e a g**  
**CALIBRATION LABORATORY**

Add: No.51 Xueyuan Road, Haidian District, Beijing, 100191, China  
Tel: +86-10-62304633-2079 Fax: +86-10-62304633-2504  
E-mail: cttl@chinattl.com http://www.chinattl.cn

### Glossary:

TSL	tissue simulating liquid
ConvF	sensitivity in TSL / NORM <sub>x,y,z</sub>
N/A	not applicable or not measured

### Calibration is Performed According to the Following Standards:

- IEEE Std 1528-2013, "IEEE Recommended Practice for Determining the Peak Spatial-Averaged Specific Absorption Rate (SAR) in the Human Head from Wireless Communications Devices: Measurement Techniques", June 2013
- IEC 62209-1, "Measurement procedure for assessment of specific absorption rate of human exposure to radio frequency fields from hand-held and body-mounted wireless communication devices- Part 1: Device used next to the ear (Frequency range of 300MHz to 6GHz)", July 2016
- IEC 62209-2, "Procedure to measure the Specific Absorption Rate (SAR) For wireless communication devices used in close proximity to the human body (frequency range of 30MHz to 6GHz)", March 2010
- KDB865664, SAR Measurement Requirements for 100 MHz to 6 GHz

### Additional Documentation:

- DASY4/5 System Handbook

### Methods Applied and Interpretation of Parameters:

- Measurement Conditions:** Further details are available from the Validation Report at the end of the certificate. All figures stated in the certificate are valid at the frequency indicated.
- Antenna Parameters with TSL:** The dipole is mounted with the spacer to position its feed point exactly below the center marking of the flat phantom section, with the arms oriented parallel to the body axis.
- Feed Point Impedance and Return Loss:** These parameters are measured with the dipole positioned under the liquid filled phantom. The impedance stated is transformed from the measurement at the SMA connector to the feed point. The Return Loss ensures low reflected power. No uncertainty required.
- Electrical Delay:** One-way delay between the SMA connector and the antenna feed point. No uncertainty required.
- SAR measured:** SAR measured at the stated antenna input power.
- SAR normalized:** SAR as measured, normalized to an input power of 1 W at the antenna connector.
- SAR for nominal TSL parameters:** The measured TSL parameters are used to calculate the nominal SAR result.

The reported uncertainty of measurement is stated as the standard uncertainty of Measurement multiplied by the coverage factor  $k=2$ , which for a normal distribution Corresponds to a coverage probability of approximately 95%.





Add: No.51 Xueyuan Road, Haidian District, Beijing, 100191, China  
 Tel: +86-10-62304633-2079 Fax: +86-10-62304633-2504  
 E-mail: cttl@chinattl.com http://www.chinattl.cn

### Measurement Conditions

DASY system configuration, as far as not given on page 1.

DASY Version	DASY52	52.10.1.1476
Extrapolation	Advanced Extrapolation	
Phantom	Triple Flat Phantom 5.1C	
Distance Dipole Center - TSL	15 mm	with Spacer
Zoom Scan Resolution	dx, dy, dz = 5 mm	
Frequency	835 MHz ± 1 MHz	

### Head TSL parameters

The following parameters and calculations were applied.

	Temperature	Permittivity	Conductivity
Nominal Head TSL parameters	22.0 °C	41.5	0.90 mho/m
Measured Head TSL parameters	(22.0 ± 0.2) °C	42.1 ± 6 %	0.87 mho/m ± 6 %
Head TSL temperature change during test	<1.0 °C	----	----

### SAR result with Head TSL

SAR averaged over 1 cm <sup>3</sup> (1 g) of Head TSL	Condition	
SAR measured	250 mW input power	2.25 mW / g
SAR for nominal Head TSL parameters	normalized to 1W	9.23 mW / g ± 18.8 % (k=2)
SAR averaged over 10 cm <sup>3</sup> (10 g) of Head TSL	Condition	
SAR measured	250 mW input power	1.47 mW / g
SAR for nominal Head TSL parameters	normalized to 1W	6.00 mW / g ± 18.7 % (k=2)

### Body TSL parameters

The following parameters and calculations were applied.

	Temperature	Permittivity	Conductivity
Nominal Body TSL parameters	22.0 °C	55.2	0.97 mho/m
Measured Body TSL parameters	(22.0 ± 0.2) °C	55.2 ± 6 %	0.99 mho/m ± 6 %
Body TSL temperature change during test	<1.0 °C	----	----

### SAR result with Body TSL

SAR averaged over 1 cm <sup>3</sup> (1 g) of Body TSL	Condition	
SAR measured	250 mW input power	2.42 mW / g
SAR for nominal Body TSL parameters	normalized to 1W	9.53 mW / g ± 18.8 % (k=2)
SAR averaged over 10 cm <sup>3</sup> (10 g) of Body TSL	Condition	
SAR measured	250 mW input power	1.57 mW / g
SAR for nominal Body TSL parameters	normalized to 1W	6.20 mW / g ± 18.7 % (k=2)



In Collaboration with

**s p e a g**  
CALIBRATION LABORATORY

Add: No.51 Xueyuan Road, Haidian District, Beijing, 100191, China

Tel: +86-10-62304633-2079

Fax: +86-10-62304633-2504

E-mail: cttl@chinattl.com

http://www.chinattl.cn

## Appendix (Additional assessments outside the scope of CNAS L0570)

### Antenna Parameters with Head TSL

Impedance, transformed to feed point	51.0 $\Omega$ - 3.97j $\Omega$
Return Loss	- 27.9dB

### Antenna Parameters with Body TSL

Impedance, transformed to feed point	46.4 $\Omega$ - 4.96j $\Omega$
Return Loss	- 23.9dB

### General Antenna Parameters and Design

Electrical Delay (one direction)	1.308 ns
----------------------------------	----------

After long term use with 100W radiated power, only a slight warming of the dipole near the feedpoint can be measured.

The dipole is made of standard semirigid coaxial cable. The center conductor of the feeding line is directly connected to the second arm of the dipole. The antenna is therefore short-circuited for DC-signals. On some of the dipoles, small end caps are added to the dipole arms in order to improve matching when loaded according to the position as explained in the "Measurement Conditions" paragraph. The SAR data are not affected by this change. The overall dipole length is still according to the Standard.

No excessive force must be applied to the dipole arms, because they might bend or the soldered connections near the feedpoint may be damaged.

### Additional EUT Data

Manufactured by	SPEAG
-----------------	-------



Add: No.51 Xueyuan Road, Haidian District, Beijing, 100191, China  
Tel: +86-10-62304633-2079 Fax: +86-10-62304633-2504  
E-mail: cttl@chinattl.com http://www.chinattl.cn

**DASY5 Validation Report for Head TSL**

Date: 06.04.2018

Test Laboratory: CTTL, Beijing, China

**DUT: Dipole 835 MHz; Type: D835V2; Serial: D835V2 - SN: 4d160**

Communication System: UID 0, CW; Frequency: 835 MHz; Duty Cycle: 1:1

Medium parameters used:  $f = 835 \text{ MHz}$ ;  $\sigma = 0.874 \text{ S/m}$ ;  $\epsilon_r = 42.13$ ;  $\rho = 1000 \text{ kg/m}^3$

Phantom section: Right Section

DASY5 Configuration:

- Probe: EX3DV4 - SN7464; ConvF(10.28, 10.28, 10.28) @ 835 MHz; Calibrated: 9/12/2017
- Sensor-Surface: 1.4mm (Mechanical Surface Detection)
- Electronics: DAE4 Sn1525; Calibrated: 10/2/2017
- Phantom: MFP\_V5.1C ; Type: QD 000 P51CA; Serial: 1062
- Measurement SW: DASY52, Version 52.10 (1); SEMCAD X Version 14.6.11 (7439)

**Dipole Calibration/Zoom Scan (7x7x7) (7x7x7)/Cube 0:** Measurement grid:  $dx=5\text{mm}$ ,  $dy=5\text{mm}$ ,  $dz=5\text{mm}$

Reference Value = 56.53 V/m; Power Drift = 0.01 dB

Peak SAR (extrapolated) = 3.44 W/kg

**SAR(1 g) = 2.25 W/kg; SAR(10 g) = 1.47 W/kg**

Maximum value of SAR (measured) = 3.03 W/kg

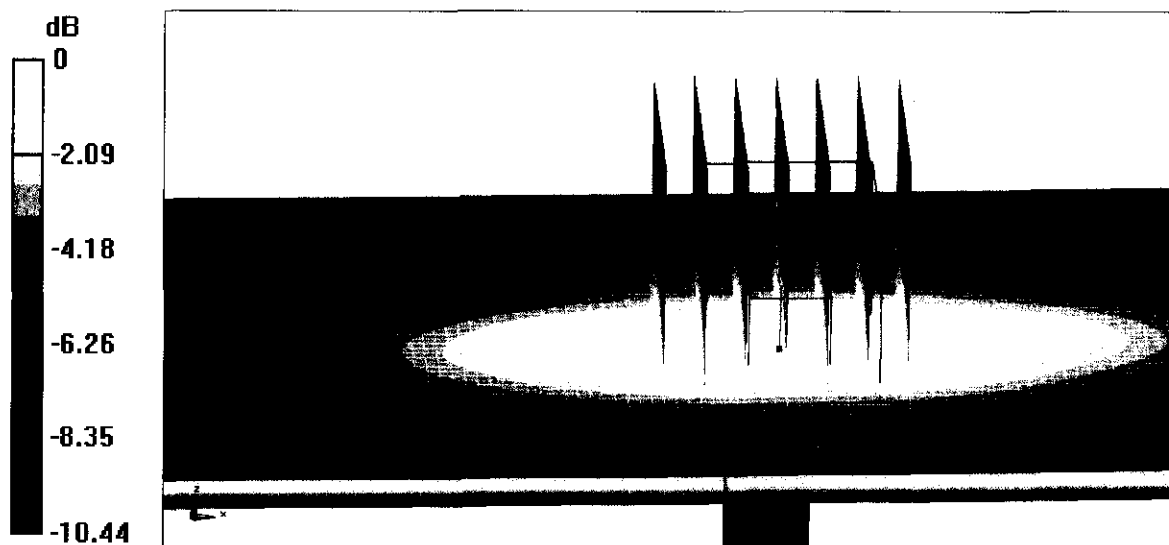

**0 dB = 3.03 W/kg = 4.81 dBW/kg**



Add: No.51 Xueyuan Road, Haidian District, Beijing, 100191, China  
Tel: +86-10-62304633-2079 Fax: +86-10-62304633-2504  
E-mail: cttl@chinattl.com http://www.chinattl.cn

### Impedance Measurement Plot for Head TSL

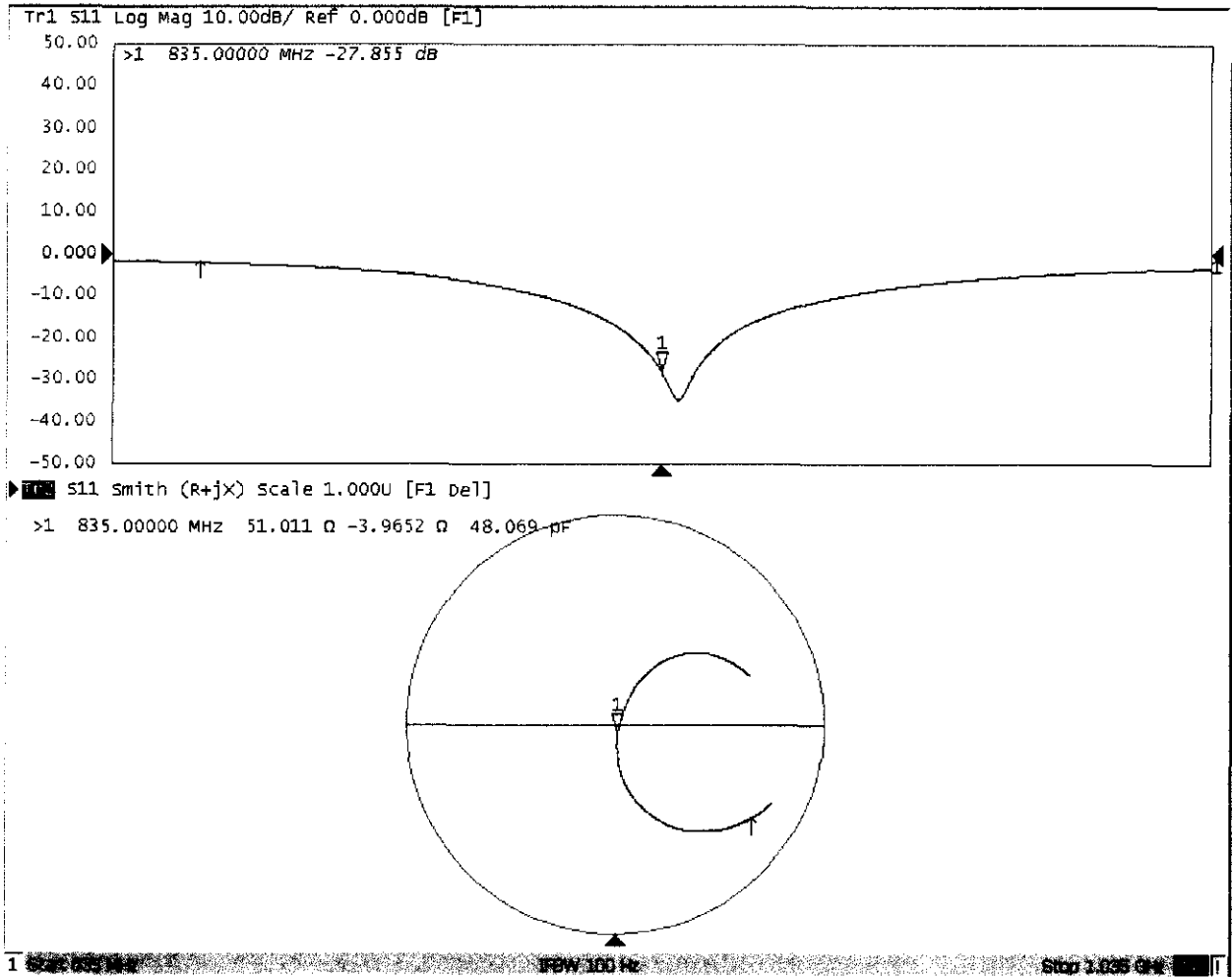



Add: No.51 Xueyuan Road, Haidian District, Beijing, 100191, China  
Tel: +86-10-62304633-2079 Fax: +86-10-62304633-2504  
E-mail: cttl@chinattl.com http://www.chinattl.cn

**DASY5 Validation Report for Body TSL**

Date: 06.04.2018

Test Laboratory: CTTL, Beijing, China

**DUT: Dipole 835 MHz; Type: D835V2; Serial: D835V2 - SN: 4d160**

Communication System: UID 0, CW; Frequency: 835 MHz; Duty Cycle: 1:1

Medium parameters used:  $f = 835 \text{ MHz}$ ;  $\sigma = 0.99 \text{ S/m}$ ;  $\epsilon_r = 55.15$ ;  $\rho = 1000 \text{ kg/m}^3$

Phantom section: Left Section

DASY5 Configuration:

- Probe: EX3DV4 - SN7464; ConvF(10.21, 10.21, 10.21) @ 835 MHz; Calibrated: 9/12/2017
- Sensor-Surface: 1.4mm (Mechanical Surface Detection)
- Electronics: DAE4 Sn1525; Calibrated: 10/2/2017
- Phantom: MFP\_V5.1C ; Type: QD 000 P51CA; Serial: 1062
- Measurement SW: DASY52, Version 52.10 (1); SEMCAD X Version 14.6.11 (7439)

**Dipole Calibration/Zoom Scan (7x7x7) (7x7x7)/Cube 0:** Measurement grid:  $dx=5\text{mm}$ ,  $dy=5\text{mm}$ ,  $dz=5\text{mm}$

Reference Value = 55.82 V/m; Power Drift = 0.05 dB

Peak SAR (extrapolated) = 3.76 W/kg

**SAR(1 g) = 2.42 W/kg; SAR(10 g) = 1.57 W/kg**

Maximum value of SAR (measured) = 3.29 W/kg

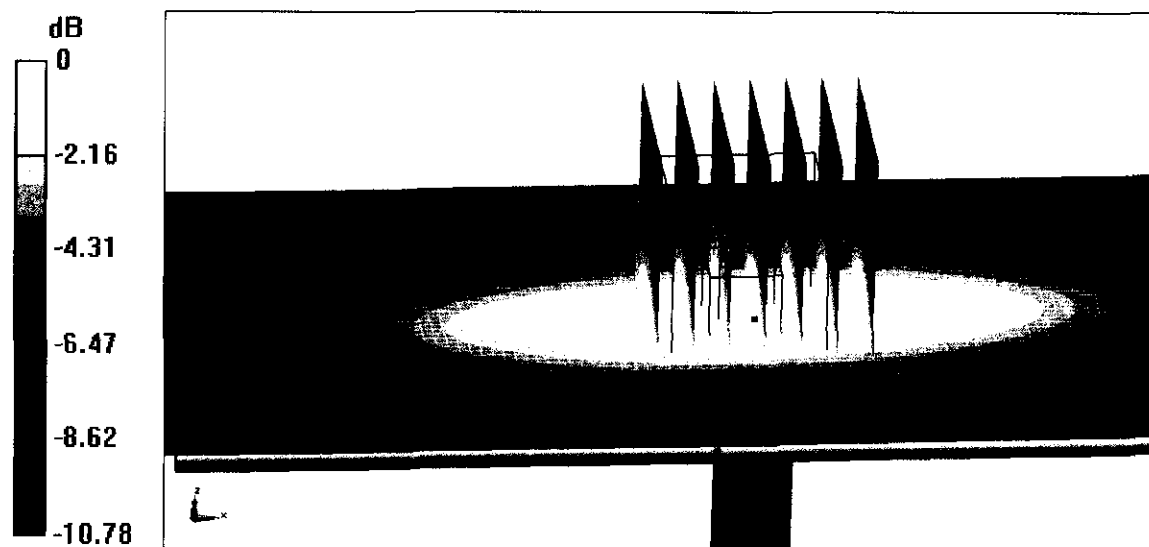

0 dB = 3.29 W/kg = 5.17 dBW/kg



Add: No.51 Xueyuan Road, Haidian District, Beijing, 100191, China  
Tel: +86-10-62304633-2079 Fax: +86-10-62304633-2504  
E-mail: cttl@chinattl.com http://www.chinattl.cn

### Impedance Measurement Plot for Body TSL

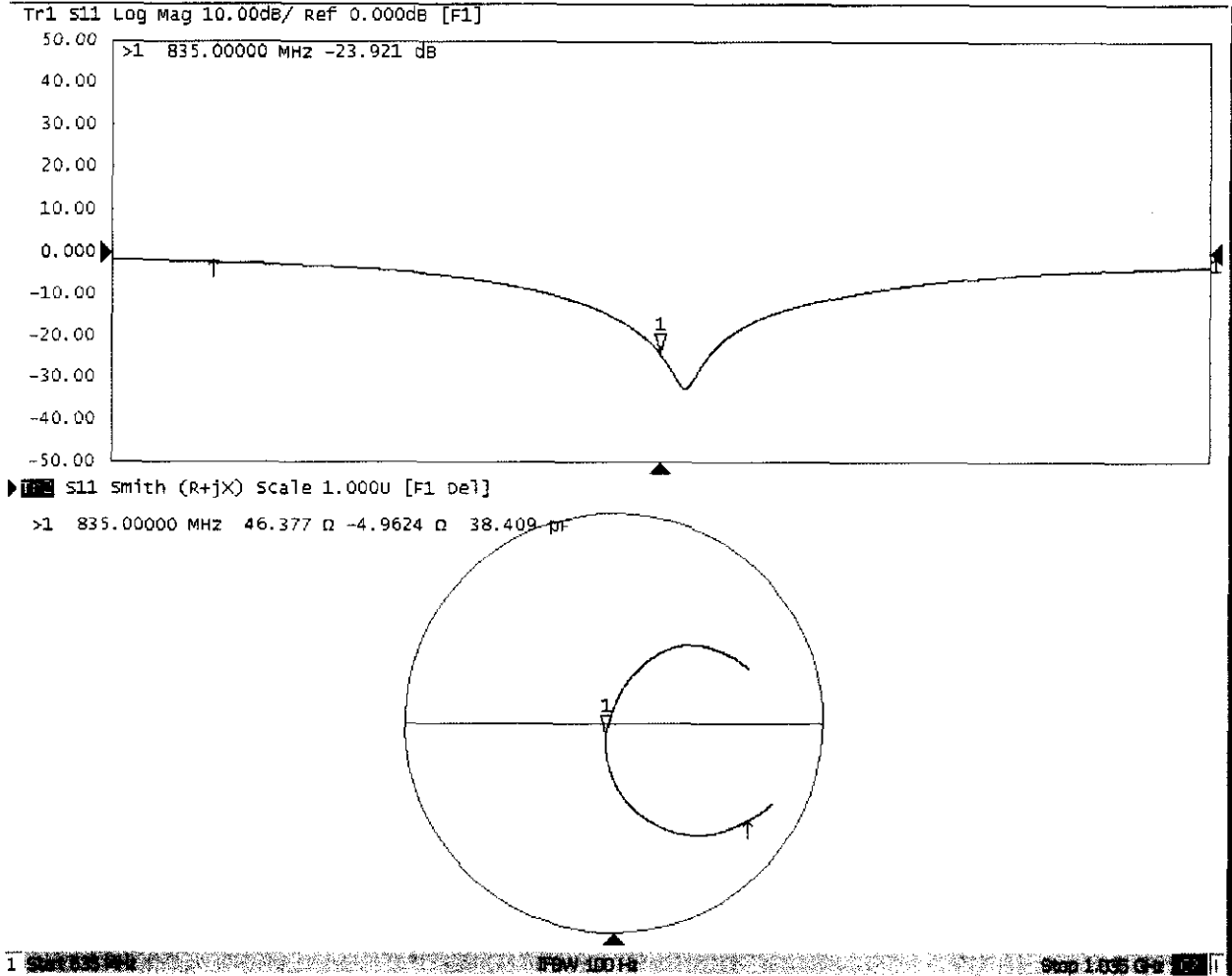



In Collaboration with  
**s p e a g**  
 CALIBRATION LABORATORY



中国认可  
 国际互认  
 校准  
 CALIBRATION  
 CNAS L0570

Add: No.51 Xueyuan Road, Haidian District, Beijing, 100191, China  
 Tel: +86-10-62304633-2079 Fax: +86-10-62304633-2504  
 E-mail: cttl@chinattl.com http://www.chinattl.cn

Client **BTL Inc .**

Certificate No: **Z18-60179**

## CALIBRATION CERTIFICATE

Object **D1750V2 - SN: 1101**

Calibration Procedure(s) **FF-Z11-003-01**  
**Calibration Procedures for dipole validation kits**

Calibration date: **June 7, 2018**

This calibration Certificate documents the traceability to national standards, which realize the physical units of measurements(SI). The measurements and the uncertainties with confidence probability are given on the following pages and are part of the certificate.

All calibrations have been conducted in the closed laboratory facility: environment temperature(22±3)°C and humidity<70%.

Calibration Equipment used (M&TE critical for calibration)

Primary Standards	ID #	Cal Date(Calibrated by, Certificate No.)	Scheduled Calibration
Power Meter NRVD	102083	01-Nov-17 (CTTL, No.J17X08756)	Oct-18
Power sensor NRV-Z5	100542	01-Nov-17 (CTTL, No.J17X08756)	Oct-18
Reference Probe EX3DV4	SN 7464	12-Sep-17(SPEAG,No.EX3-7464_Sep17)	Sep-18
DAE4	SN 1525	02-Oct-17(SPEAG,No.DAE4-1525_Oct17)	Oct-18
Secondary Standards	ID #	Cal Date(Calibrated by, Certificate No.)	Scheduled Calibration
Signal Generator E4438C	MY49071430	23-Jan-18 (CTTL, No.J18X00560)	Jan-19
NetworkAnalyzer E5071C	MY46110673	24-Jan-18 (CTTL, No.J18X00561)	Jan-19

	Name	Function	Signature
Calibrated by:	Zhao Jing	SAR Test Engineer	
Reviewed by:	Lin Hao	SAR Test Engineer	
Approved by:	Qi Dianyuan	SAR Project Leader	

Issued: June 11, 2018

This calibration certificate shall not be reproduced except in full without written approval of the laboratory.



In Collaboration with

**s p e a g**  
**CALIBRATION LABORATORY**

Add: No.51 Xueyuan Road, Haidian District, Beijing, 100191, China  
Tel: +86-10-62304633-2079 Fax: +86-10-62304633-2504  
E-mail: cttl@chinattl.com http://www.chinattl.cn

### Glossary:

TSL	tissue simulating liquid
ConvF	sensitivity in TSL / NORM <sub>x,y,z</sub>
N/A	not applicable or not measured

### Calibration is Performed According to the Following Standards:

- IEEE Std 1528-2013, "IEEE Recommended Practice for Determining the Peak Spatial-Averaged Specific Absorption Rate (SAR) in the Human Head from Wireless Communications Devices: Measurement Techniques", June 2013
- IEC 62209-1, "Measurement procedure for assessment of specific absorption rate of human exposure to radio frequency fields from hand-held and body-mounted wireless communication devices- Part 1: Device used next to the ear (Frequency range of 300MHz to 6GHz)", July 2016
- IEC 62209-2, "Procedure to measure the Specific Absorption Rate (SAR) For wireless communication devices used in close proximity to the human body (frequency range of 30MHz to 6GHz)", March 2010
- KDB865664, SAR Measurement Requirements for 100 MHz to 6 GHz

### Additional Documentation:

- DASY4/5 System Handbook

### Methods Applied and Interpretation of Parameters:

- Measurement Conditions:** Further details are available from the Validation Report at the end of the certificate. All figures stated in the certificate are valid at the frequency indicated.
- Antenna Parameters with TSL:** The dipole is mounted with the spacer to position its feed point exactly below the center marking of the flat phantom section, with the arms oriented parallel to the body axis.
- Feed Point Impedance and Return Loss:** These parameters are measured with the dipole positioned under the liquid filled phantom. The impedance stated is transformed from the measurement at the SMA connector to the feed point. The Return Loss ensures low reflected power. No uncertainty required.
- Electrical Delay:** One-way delay between the SMA connector and the antenna feed point. No uncertainty required.
- SAR measured:** SAR measured at the stated antenna input power.
- SAR normalized:** SAR as measured, normalized to an input power of 1 W at the antenna connector.
- SAR for nominal TSL parameters:** The measured TSL parameters are used to calculate the nominal SAR result.

The reported uncertainty of measurement is stated as the standard uncertainty of Measurement multiplied by the coverage factor  $k=2$ , which for a normal distribution Corresponds to a coverage probability of approximately 95%.





Add: No.51 Xueyuan Road, Haidian District, Beijing, 100191, China  
Tel: +86-10-62304633-2079 Fax: +86-10-62304633-2504  
E-mail: cttl@chinattl.com http://www.chinattl.cn

### Measurement Conditions

DASY system configuration, as far as not given on page 1.

<b>DASY Version</b>	DASY52	52.10.1.1476
<b>Extrapolation</b>	Advanced Extrapolation	
<b>Phantom</b>	Triple Flat Phantom 5.1C	
<b>Distance Dipole Center - TSL</b>	10 mm	with Spacer
<b>Zoom Scan Resolution</b>	dx, dy, dz = 5 mm	
<b>Frequency</b>	1750 MHz ± 1 MHz	

### Head TSL parameters

The following parameters and calculations were applied.

	Temperature	Permittivity	Conductivity
<b>Nominal Head TSL parameters</b>	22.0 °C	40.1	1.37 mho/m
<b>Measured Head TSL parameters</b>	(22.0 ± 0.2) °C	41.2 ± 6 %	1.33 mho/m ± 6 %
<b>Head TSL temperature change during test</b>	<1.0 °C	---	---

### SAR result with Head TSL

<b>SAR averaged over 1 cm<sup>3</sup> (1 g) of Head TSL</b>	Condition	
SAR measured	250 mW input power	9.04 mW / g
SAR for nominal Head TSL parameters	normalized to 1W	<b>37.0 mW / g ± 18.8 % (k=2)</b>
<b>SAR averaged over 10 cm<sup>3</sup> (10 g) of Head TSL</b>	Condition	
SAR measured	250 mW input power	4.90 mW / g
SAR for nominal Head TSL parameters	normalized to 1W	<b>19.9 mW / g ± 18.7 % (k=2)</b>

### Body TSL parameters

The following parameters and calculations were applied.

	Temperature	Permittivity	Conductivity
<b>Nominal Body TSL parameters</b>	22.0 °C	53.4	1.49 mho/m
<b>Measured Body TSL parameters</b>	(22.0 ± 0.2) °C	52.0 ± 6 %	1.53 mho/m ± 6 %
<b>Body TSL temperature change during test</b>	<1.0 °C	---	---

### SAR result with Body TSL

<b>SAR averaged over 1 cm<sup>3</sup> (1 g) of Body TSL</b>	Condition	
SAR measured	250 mW input power	9.57 mW / g
SAR for nominal Body TSL parameters	normalized to 1W	<b>37.4 mW / g ± 18.8 % (k=2)</b>
<b>SAR averaged over 10 cm<sup>3</sup> (10 g) of Body TSL</b>	Condition	
SAR measured	250 mW input power	5.11 mW / g
SAR for nominal Body TSL parameters	normalized to 1W	<b>20.1 mW / g ± 18.7 % (k=2)</b>



Add: No.51 Xueyuan Road, Haidian District, Beijing, 100191, China  
Tel: +86-10-62304633-2079 Fax: +86-10-62304633-2504  
E-mail: cttl@chinattl.com http://www.chinattl.cn

## Appendix (Additional assessments outside the scope of CNAS L0570)

### Antenna Parameters with Head TSL

Impedance, transformed to feed point	49.8Ω- 2.69 jΩ
Return Loss	- 31.4 dB

### Antenna Parameters with Body TSL

Impedance, transformed to feed point	46.3Ω- 2.68 jΩ
Return Loss	- 26.5 dB

### General Antenna Parameters and Design

Electrical Delay (one direction)	1.085 ns
----------------------------------	----------

After long term use with 100W radiated power, only a slight warming of the dipole near the feedpoint can be measured.

The dipole is made of standard semirigid coaxial cable. The center conductor of the feeding line is directly connected to the second arm of the dipole. The antenna is therefore short-circuited for DC-signals. On some of the dipoles, small end caps are added to the dipole arms in order to improve matching when loaded according to the position as explained in the "Measurement Conditions" paragraph. The SAR data are not affected by this change. The overall dipole length is still according to the Standard.

No excessive force must be applied to the dipole arms, because they might bend or the soldered connections near the feedpoint may be damaged.

### Additional EUT Data

Manufactured by	SPEAG
-----------------	-------



In Collaboration with

**s p e a g**  
**CALIBRATION LABORATORY**

Add: No.51 Xueyuan Road, Haidian District, Beijing, 100191, China  
Tel: +86-10-62304633-2079 Fax: +86-10-62304633-2504  
E-mail: cttl@chinattl.com http://www.chinattl.cn

**DASY5 Validation Report for Head TSL**

Date: 06.07.2018

Test Laboratory: CTTL, Beijing, China

**DUT: Dipole 1750 MHz; Type: D1750V2; Serial: D1750V2 - SN: 1101**

Communication System: UID 0, CW; Frequency: 1750 MHz; Duty Cycle: 1:1

Medium parameters used:  $f = 1750$  MHz;  $\sigma = 1.332$  S/m;  $\epsilon_r = 41.23$ ;  $\rho = 1000$  kg/m<sup>3</sup>

Phantom section: Right Section

DASY5 Configuration:

- Probe: EX3DV4 - SN7464; ConvF(8.7, 8.7, 8.7) @ 1750 MHz; Calibrated: 9/12/2017
- Sensor-Surface: 1.4mm (Mechanical Surface Detection)
- Electronics: DAE4 Sn1525; Calibrated: 10/2/2017
- Phantom: MFP\_V5.1C ; Type: QD 000 P51CA; Serial: 1062
- Measurement SW: DASY52, Version 52.10 (1); SEMCAD X Version 14.6.11 (7439)

**System Performance Check/Zoom Scan (7x7x7) (7x7x7)/Cube 0: Measurement grid:**

$dx=5$ mm,  $dy=5$ mm,  $dz=5$ mm

Reference Value = 96.28 V/m; Power Drift = 0.03 dB

Peak SAR (extrapolated) = 16.5 W/kg

**SAR(1 g) = 9.04 W/kg; SAR(10 g) = 4.9 W/kg**

Maximum value of SAR (measured) = 13.8 W/kg

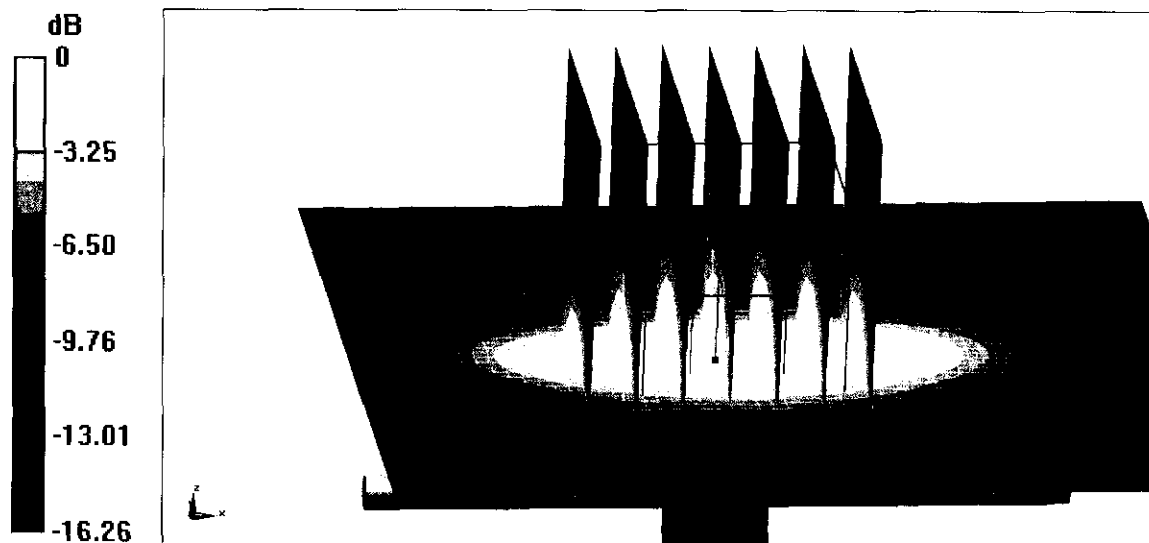

**0 dB = 13.8 W/kg = 11.40 dBW/kg**



In Collaboration with  
**s p e a g**  
CALIBRATION LABORATORY

Add: No.51 Xueyuan Road, Haidian District, Beijing, 100191, China  
Tel: +86-10-62304633-2079 Fax: +86-10-62304633-2504  
E-mail: cttl@chinattl.com http://www.chinattl.cn

### Impedance Measurement Plot for Head TSL

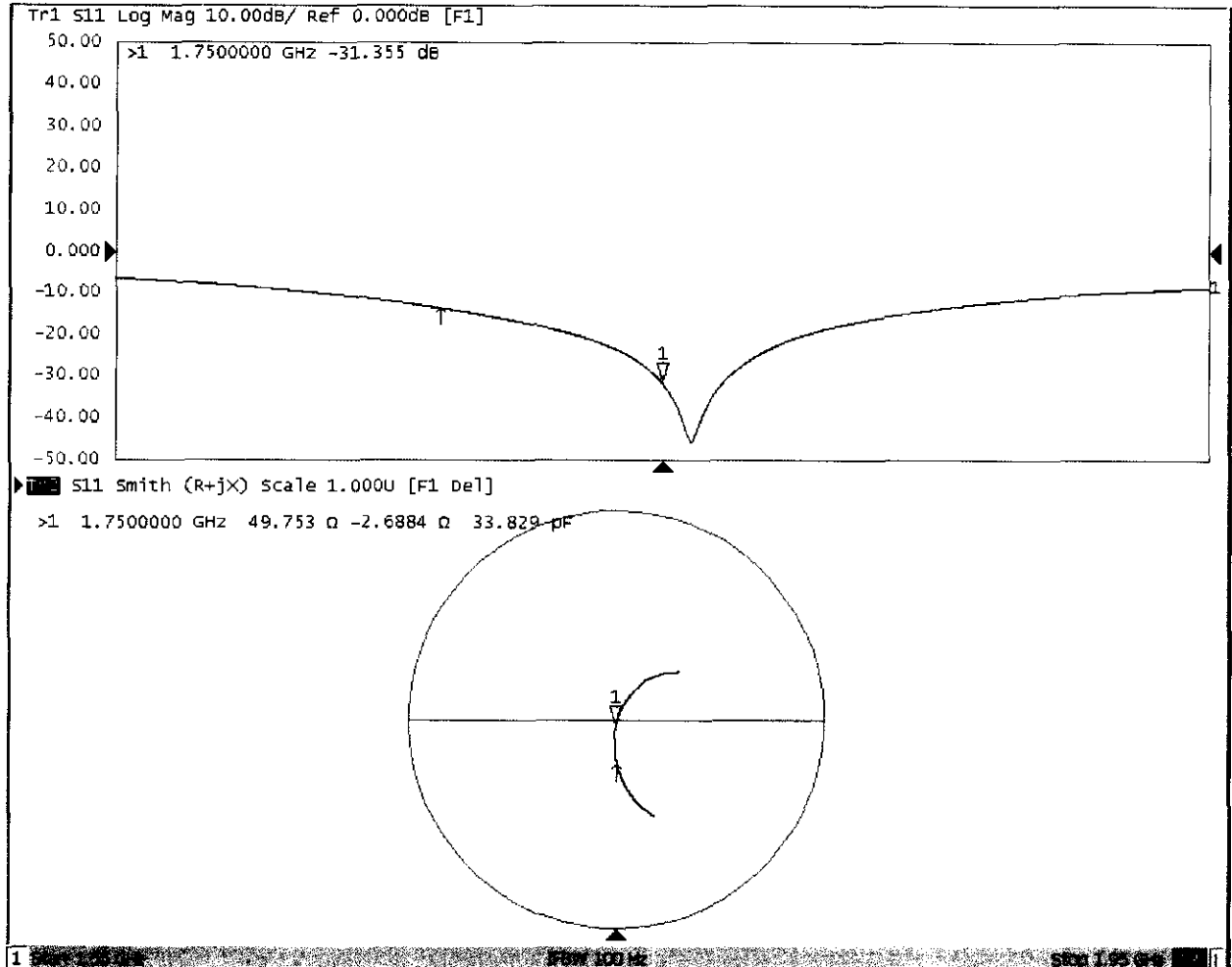



Add: No.51 Xueyuan Road, Haidian District, Beijing, 100191, China  
Tel: +86-10-62304633-2079 Fax: +86-10-62304633-2504  
E-mail: cttl@chinattl.com http://www.chinattl.cn

### DASY5 Validation Report for Body TSL

Date: 06.06.2018

Test Laboratory: CTTL, Beijing, China

**DUT: Dipole 1750 MHz; Type: D1750V2; Serial: D1750V2 - SN: 1101**

Communication System: UID 0, CW; Frequency: 1750 MHz; Duty Cycle: 1:1

Medium parameters used:  $f = 1750$  MHz;  $\sigma = 1.533$  S/m;  $\epsilon_r = 51.99$ ;  $\rho = 1000$  kg/m<sup>3</sup>

Phantom section: Center Section

DASY5 Configuration:

- Probe: EX3DV4 - SN7464; ConvF(8.6, 8.6, 8.6) @ 1750 MHz; Calibrated: 9/12/2017
- Sensor-Surface: 1.4mm (Mechanical Surface Detection)
- Electronics: DAE4 Sn1525; Calibrated: 10/2/2017
- Phantom: MFP\_V5.1C ; Type: QD 000 P51CA; Serial: 1062
- Measurement SW: DASY52, Version 52.10 (1); SEMCAD X Version 14.6.11 (7439)

**System Performance Check/Zoom Scan (7x7x7) (7x7x7)/Cube 0: Measurement grid:**

$dx=5$ mm,  $dy=5$ mm,  $dz=5$ mm

Reference Value = 82.09 V/m; Power Drift = -0.03 dB

Peak SAR (extrapolated) = 17.3 W/kg

**SAR(1 g) = 9.57 W/kg; SAR(10 g) = 5.11 W/kg**

Maximum value of SAR (measured) = 14.6 W/kg

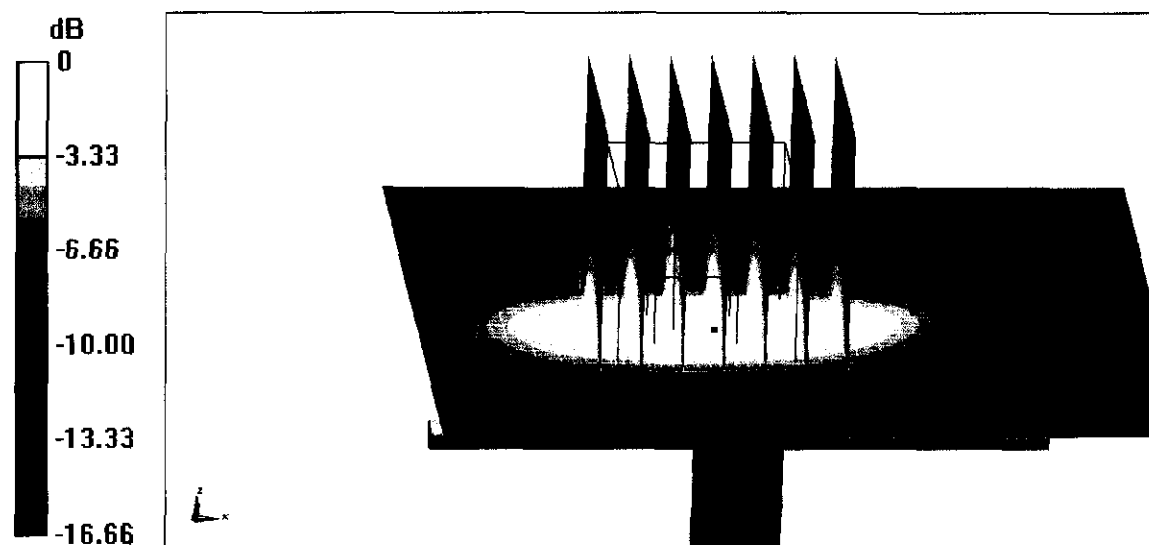

0 dB = 14.6 W/kg = 11.64 dBW/kg



Add: No.51 Xueyuan Road, Haidian District, Beijing, 100191, China  
Tel: +86-10-62304633-2079 Fax: +86-10-62304633-2504  
E-mail: cttl@chinattl.com http://www.chinattl.cn

### Impedance Measurement Plot for Body TSL

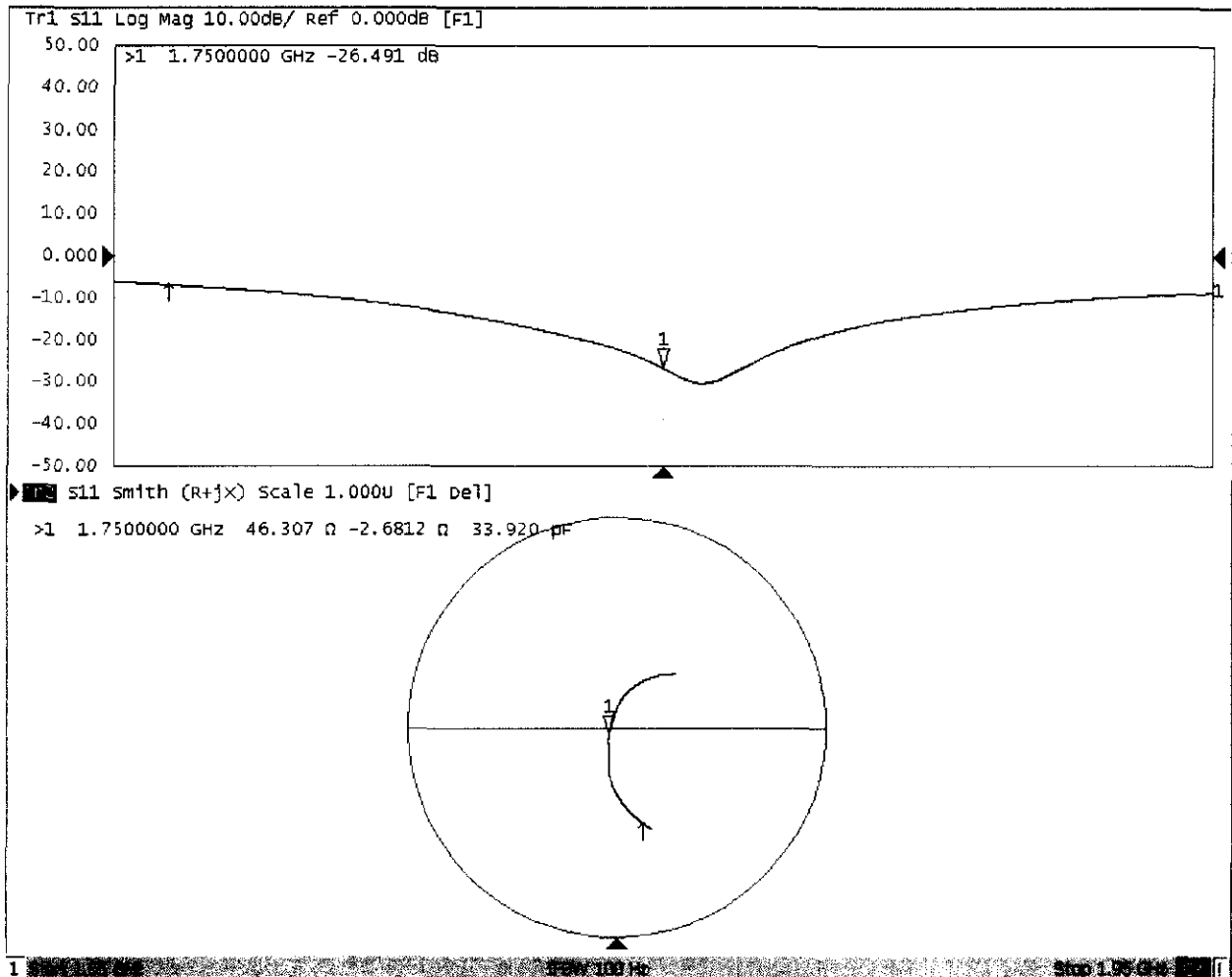



In Collaboration with  
**s p e a g**  
 CALIBRATION LABORATORY



中国认可  
 国际互认  
 校准  
 CALIBRATION  
 CNAS L0570

Add: No.51 Xueyuan Road, Haidian District, Beijing, 100191, China  
 Tel: +86-10-62304633-2079 Fax: +86-10-62304633-2504  
 E-mail: cttl@chinattl.com http://www.chinattl.cn

Client **BTL Inc .**

Certificate No: **Z18-60180**

## CALIBRATION CERTIFICATE

Object **D1900V2 - SN: 5d179**

Calibration Procedure(s) **FF-Z11-003-01**  
**Calibration Procedures for dipole validation kits**

Calibration date: **June 7, 2018**

This calibration Certificate documents the traceability to national standards, which realize the physical units of measurements(SI). The measurements and the uncertainties with confidence probability are given on the following pages and are part of the certificate.

All calibrations have been conducted in the closed laboratory facility: environment temperature(22±3)°C and humidity<70%.

Calibration Equipment used (M&TE critical for calibration)

Primary Standards	ID #	Cal Date(Calibrated by, Certificate No.)	Scheduled Calibration
Power Meter NRVD	102083	01-Nov-17 (CTTL, No.J17X08756)	Oct-18
Power sensor NRV-Z5	100542	01-Nov-17 (CTTL, No.J17X08756)	Oct-18
Reference Probe EX3DV4	SN 7464	12-Sep-17(SPEAG,No.EX3-7464_Sep17)	Sep-18
DAE4	SN 1525	02-Oct-17(SPEAG,No.DAE4-1525_Oct17)	Oct-18
Secondary Standards	ID #	Cal Date(Calibrated by, Certificate No.)	Scheduled Calibration
Signal Generator E4438C	MY49071430	23-Jan-18 (CTTL, No.J18X00560)	Jan-19
NetworkAnalyzer E5071C	MY46110673	24-Jan-18 (CTTL, No.J18X00561)	Jan-19

	Name	Function	Signature
Calibrated by:	Zhao Jing	SAR Test Engineer	
Reviewed by:	Lin Hao	SAR Test Engineer	
Approved by:	Qi Dianyuan	SAR Project Leader	

Issued: June 11, 2018

This calibration certificate shall not be reproduced except in full without written approval of the laboratory.



In Collaboration with

**s p e a g**  
**CALIBRATION LABORATORY**

Add: No.51 Xueyuan Road, Haidian District, Beijing, 100191, China  
Tel: +86-10-62304633-2079 Fax: +86-10-62304633-2504  
E-mail: cttl@chinattl.com http://www.chinattl.cn

#### **Glossary:**

TSL	tissue simulating liquid
ConvF	sensitivity in TSL / NORM <sub>x,y,z</sub>
N/A	not applicable or not measured

#### **Calibration is Performed According to the Following Standards:**

- IEEE Std 1528-2013, "IEEE Recommended Practice for Determining the Peak Spatial-Averaged Specific Absorption Rate (SAR) in the Human Head from Wireless Communications Devices: Measurement Techniques", June 2013
- IEC 62209-1, "Measurement procedure for assessment of specific absorption rate of human exposure to radio frequency fields from hand-held and body-mounted wireless communication devices- Part 1: Device used next to the ear (Frequency range of 300MHz to 6GHz)", July 2016
- IEC 62209-2, "Procedure to measure the Specific Absorption Rate (SAR) For wireless communication devices used in close proximity to the human body (frequency range of 30MHz to 6GHz)", March 2010
- KDB865664, SAR Measurement Requirements for 100 MHz to 6 GHz

#### **Additional Documentation:**

- DASY4/5 System Handbook

#### **Methods Applied and Interpretation of Parameters:**

- Measurement Conditions:** Further details are available from the Validation Report at the end of the certificate. All figures stated in the certificate are valid at the frequency indicated.
- Antenna Parameters with TSL:** The dipole is mounted with the spacer to position its feed point exactly below the center marking of the flat phantom section, with the arms oriented parallel to the body axis.
- Feed Point Impedance and Return Loss:** These parameters are measured with the dipole positioned under the liquid filled phantom. The impedance stated is transformed from the measurement at the SMA connector to the feed point. The Return Loss ensures low reflected power. No uncertainty required.
- Electrical Delay:** One-way delay between the SMA connector and the antenna feed point. No uncertainty required.
- SAR measured:** SAR measured at the stated antenna input power.
- SAR normalized:** SAR as measured, normalized to an input power of 1 W at the antenna connector.
- SAR for nominal TSL parameters:** The measured TSL parameters are used to calculate the nominal SAR result.

The reported uncertainty of measurement is stated as the standard uncertainty of Measurement multiplied by the coverage factor  $k=2$ , which for a normal distribution Corresponds to a coverage probability of approximately 95%.





Add: No.51 Xueyuan Road, Haidian District, Beijing, 100191, China  
Tel: +86-10-62304633-2079 Fax: +86-10-62304633-2504  
E-mail: cttl@chinattl.com http://www.chinattl.cn

### Measurement Conditions

DASY system configuration, as far as not given on page 1.

<b>DASY Version</b>	DASY52	52.10.1.1476
<b>Extrapolation</b>	Advanced Extrapolation	
<b>Phantom</b>	Triple Flat Phantom 5.1C	
<b>Distance Dipole Center - TSL</b>	10 mm	with Spacer
<b>Zoom Scan Resolution</b>	dx, dy, dz = 5 mm	
<b>Frequency</b>	1900 MHz $\pm$ 1 MHz	

### Head TSL parameters

The following parameters and calculations were applied.

	Temperature	Permittivity	Conductivity
<b>Nominal Head TSL parameters</b>	22.0 °C	40.0	1.40 mho/m
<b>Measured Head TSL parameters</b>	(22.0 $\pm$ 0.2) °C	41.2 $\pm$ 6 %	1.44 mho/m $\pm$ 6 %
<b>Head TSL temperature change during test</b>	<1.0 °C	---	---

### SAR result with Head TSL

<b>SAR averaged over 1 cm<sup>3</sup> (1 g) of Head TSL</b>	Condition	
SAR measured	250 mW input power	9.96 mW / g
SAR for nominal Head TSL parameters	normalized to 1W	<b>39.5 mW / g <math>\pm</math> 18.8 % (k=2)</b>
<b>SAR averaged over 10 cm<sup>3</sup> (10 g) of Head TSL</b>	Condition	
SAR measured	250 mW input power	5.21 mW / g
SAR for nominal Head TSL parameters	normalized to 1W	<b>20.7 mW / g <math>\pm</math> 18.7 % (k=2)</b>

### Body TSL parameters

The following parameters and calculations were applied.

	Temperature	Permittivity	Conductivity
<b>Nominal Body TSL parameters</b>	22.0 °C	53.3	1.52 mho/m
<b>Measured Body TSL parameters</b>	(22.0 $\pm$ 0.2) °C	51.8 $\pm$ 6 %	1.57 mho/m $\pm$ 6 %
<b>Body TSL temperature change during test</b>	<1.0 °C	---	---

### SAR result with Body TSL

<b>SAR averaged over 1 cm<sup>3</sup> (1 g) of Body TSL</b>	Condition	
SAR measured	250 mW input power	10.2 mW / g
SAR for nominal Body TSL parameters	normalized to 1W	<b>39.8 mW / g <math>\pm</math> 18.8 % (k=2)</b>
<b>SAR averaged over 10 cm<sup>3</sup> (10 g) of Body TSL</b>	Condition	
SAR measured	250 mW input power	5.29 mW / g
SAR for nominal Body TSL parameters	normalized to 1W	<b>20.8 mW / g <math>\pm</math> 18.7 % (k=2)</b>



In Collaboration with

**s p e a g**  
CALIBRATION LABORATORY

Add: No.51 Xueyuan Road, Haidian District, Beijing, 100191, China

Tel: +86-10-62304633-2079

Fax: +86-10-62304633-2504

E-mail: cttl@chinattl.com

http://www.chinattl.cn

## Appendix (Additional assessments outside the scope of CNAS L0570)

### Antenna Parameters with Head TSL

Impedance, transformed to feed point	50.9Ω+ 3.19jΩ
Return Loss	- 29.7dB

### Antenna Parameters with Body TSL

Impedance, transformed to feed point	47.2Ω+ 3.99jΩ
Return Loss	- 26.0dB

### General Antenna Parameters and Design

Electrical Delay (one direction)	1.065 ns
----------------------------------	----------

After long term use with 100W radiated power, only a slight warming of the dipole near the feedpoint can be measured.

The dipole is made of standard semirigid coaxial cable. The center conductor of the feeding line is directly connected to the second arm of the dipole. The antenna is therefore short-circuited for DC-signals. On some of the dipoles, small end caps are added to the dipole arms in order to improve matching when loaded according to the position as explained in the "Measurement Conditions" paragraph. The SAR data are not affected by this change. The overall dipole length is still according to the Standard.

No excessive force must be applied to the dipole arms, because they might bend or the soldered connections near the feedpoint may be damaged.

### Additional EUT Data

Manufactured by	SPEAG
-----------------	-------



Add: No.51 Xueyuan Road, Haidian District, Beijing, 100191, China  
Tel: +86-10-62304633-2079 Fax: +86-10-62304633-2504  
E-mail: cttl@chinattl.com http://www.chinattl.cn

**DASY5 Validation Report for Head TSL**

Date: 06.06.2018

Test Laboratory: CTTL, Beijing, China

**DUT: Dipole 1900 MHz; Type: D1900V2; Serial: D1900V2 - SN: 5d179**

Communication System: UID 0, CW; Frequency: 1900 MHz; Duty Cycle: 1:1

Medium parameters used:  $f = 1900$  MHz;  $\sigma = 1.438$  S/m;  $\epsilon_r = 41.15$ ;  $\rho = 1000$  kg/m<sup>3</sup>

Phantom section: Right Section

DASY5 Configuration:

- Probe: EX3DV4 - SN7464; ConvF(8.39, 8.39, 8.39) @ 1900 MHz; Calibrated: 9/12/2017
- Sensor-Surface: 1.4mm (Mechanical Surface Detection)
- Electronics: DAE4 Sn1525; Calibrated: 10/2/2017
- Phantom: MFP\_V5.1C ; Type: QD 000 P51CA; Serial: 1062
- Measurement SW: DASY52, Version 52.10 (1); SEMCAD X Version 14.6.11 (7439)

**System Performance Check/Zoom Scan (7x7x7) (7x7x7)/Cube 0: Measurement grid:**

$dx=5$ mm,  $dy=5$ mm,  $dz=5$ mm

Reference Value = 95.41 V/m; Power Drift = 0.03 dB

Peak SAR (extrapolated) = 18.8 W/kg

**SAR(1 g) = 9.96 W/kg; SAR(10 g) = 5.21 W/kg**

Maximum value of SAR (measured) = 15.5 W/kg

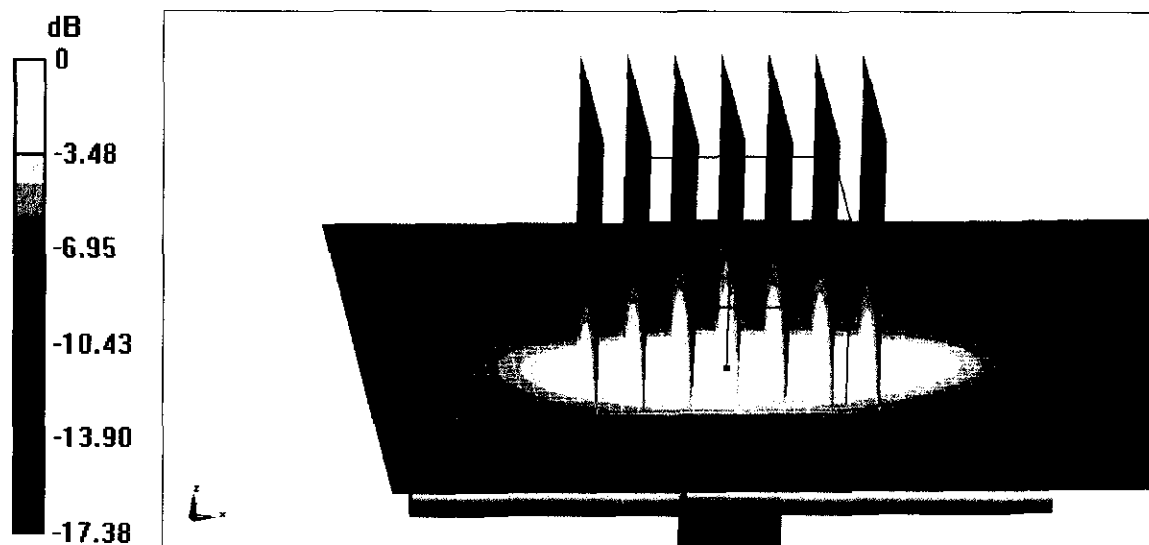

**0 dB = 15.5 W/kg = 11.90 dBW/kg**



Add: No.51 Xueyuan Road, Haidian District, Beijing, 100191, China  
Tel: +86-10-62304633-2079 Fax: +86-10-62304633-2504  
E-mail: cttl@chinattl.com http://www.chinattl.cn

### Impedance Measurement Plot for Head TSL

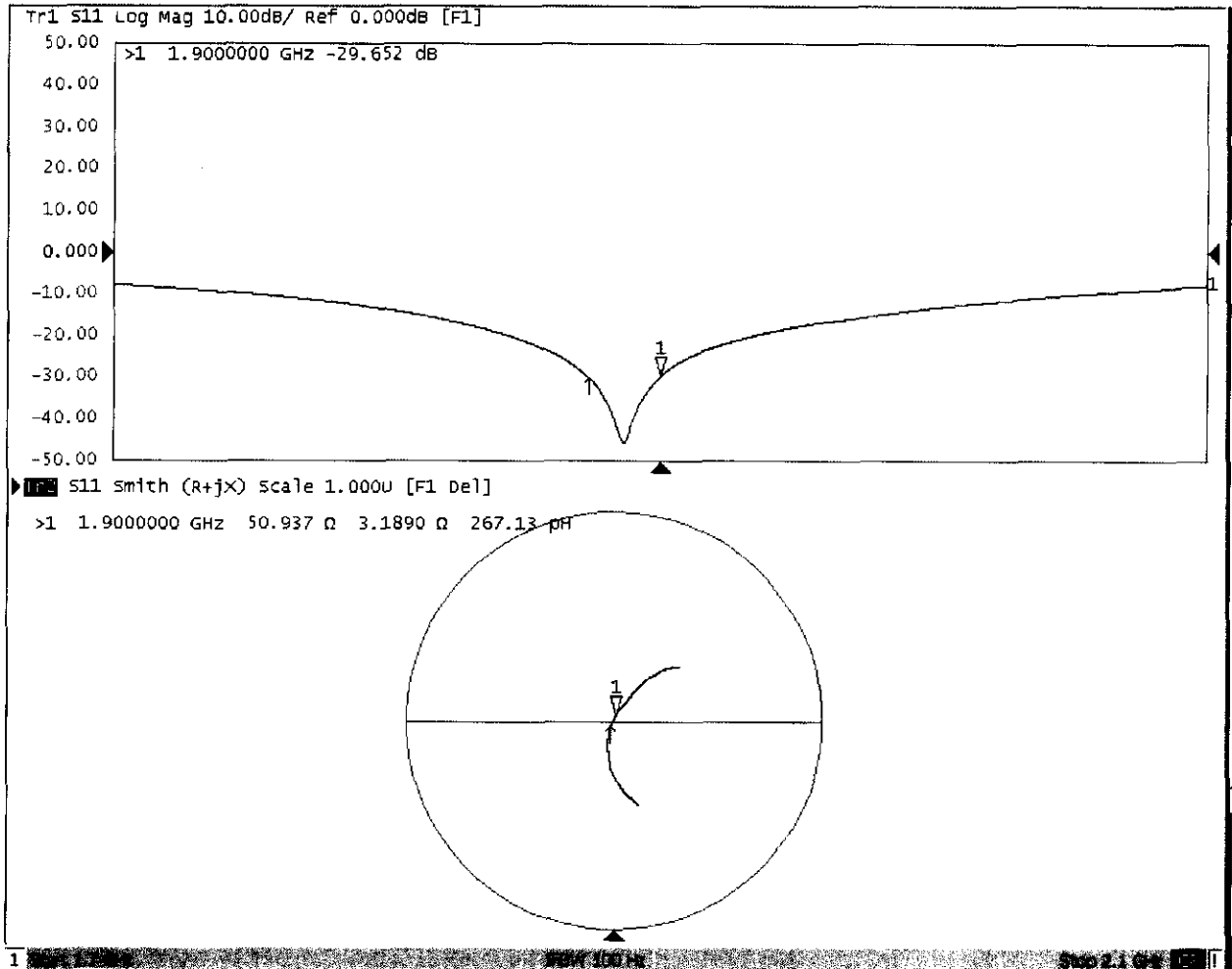



In Collaboration with

**s p e a g**  
CALIBRATION LABORATORY

Add: No.51 Xueyuan Road, Haidian District, Beijing, 100191, China

Tel: +86-10-62304633-2079

Fax: +86-10-62304633-2504

E-mail: cttl@chinattl.com

http://www.chinattl.cn

## DASY5 Validation Report for Body TSL

Date: 06.06.2018

Test Laboratory: CTTL, Beijing, China

**DUT: Dipole 1900 MHz; Type: D1900V2; Serial: D1900V2 - SN: 5d179**

Medium parameters used:  $f = 1900$  MHz;  $\sigma = 1.565$  S/m;  $\epsilon_r = 51.75$ ;  $\rho = 1000$  kg/m<sup>3</sup>

Phantom section: Center Section

DASY5 Configuration:

- Probe: EX3DV4 - SN7464; ConvF(8.32, 8.32, 8.32) @ 1900 MHz; Calibrated: 9/12/2017
- Sensor-Surface: 1.4mm (Mechanical Surface Detection)
- Electronics: DAE4 Sn1525; Calibrated: 10/2/2017
- Phantom: MFP\_V5.1C ; Type: QD 000 P51CA; Serial: 1062
- Measurement SW: DASY52, Version 52.10 (1); SEMCAD X Version 14.6.11 (7439) )

**System Performance Check/Zoom Scan (7x7x7) (7x7x7)/Cube 0: Measurement grid:**

$dx=5$ mm,  $dy=5$ mm,  $dz=5$ mm

Reference Value = 87.58 V/m; Power Drift = -0.05 dB

Peak SAR (extrapolated) = 19.1 W/kg

**SAR(1 g) = 10.2 W/kg; SAR(10 g) = 5.29 W/kg**

Maximum value of SAR (measured) = 15.9 W/kg

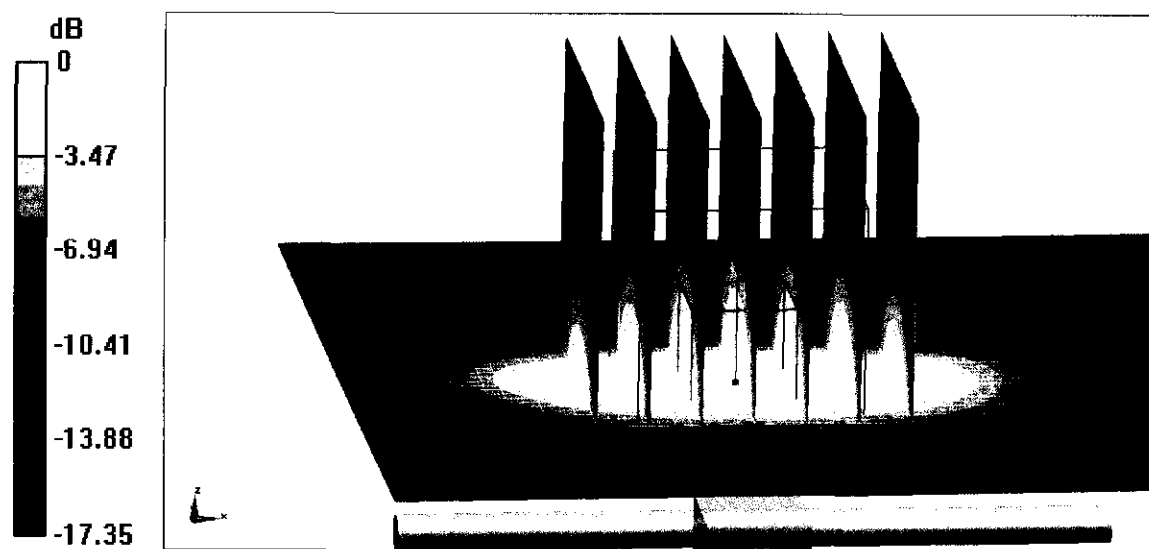



Add: No.51 Xueyuan Road, Haidian District, Beijing, 100191, China  
Tel: +86-10-62304633-2079 Fax: +86-10-62304633-2504  
E-mail: cttl@chinattl.com http://www.chinattl.cn

### Impedance Measurement Plot for Body TSL

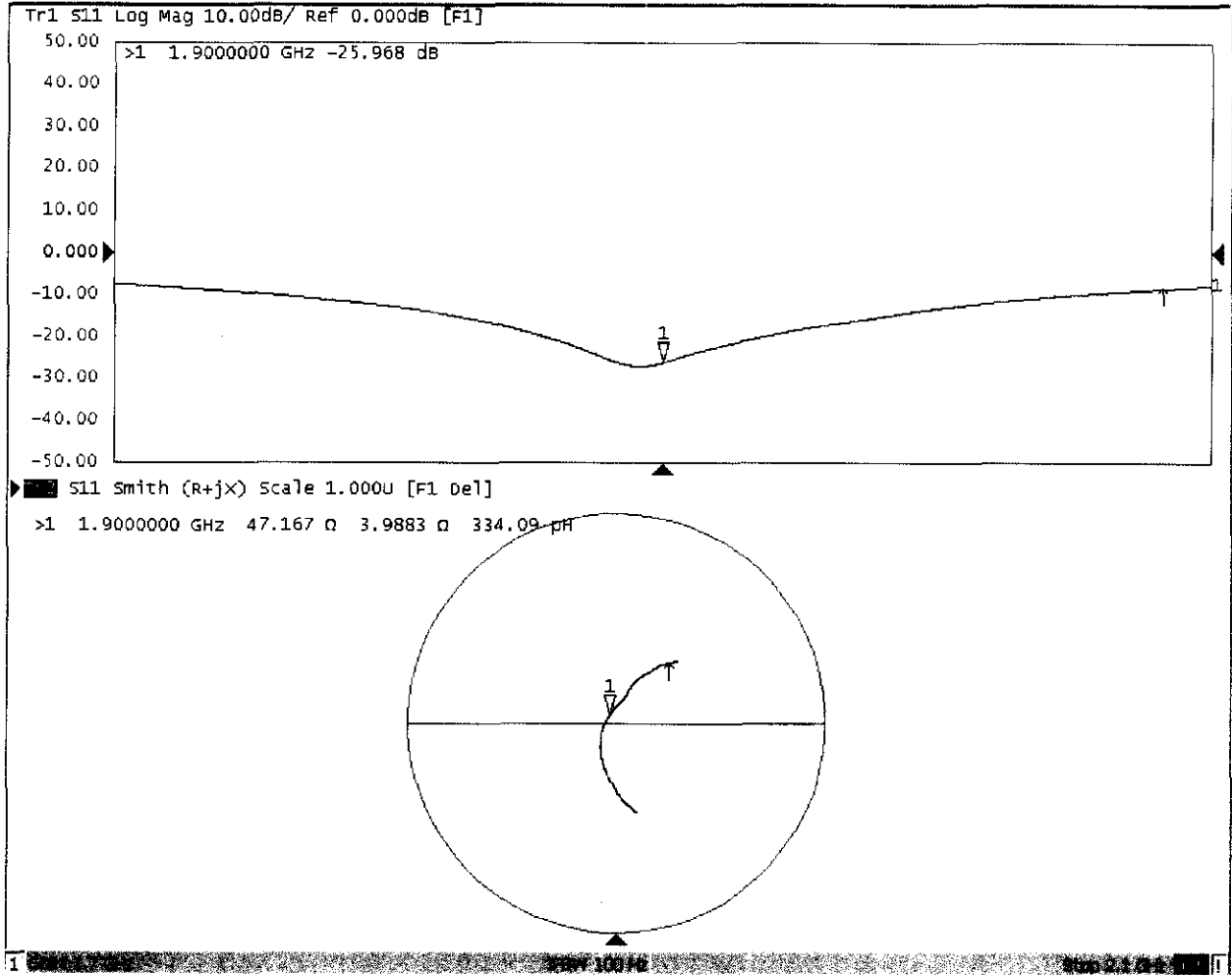



In Collaboration with  
**s p e a g**  
 CALIBRATION LABORATORY



中国认可  
 国际互认  
 校准  
 CALIBRATION  
 CNAS L0570

Add: No.51 Xueyuan Road, Haidian District, Beijing, 100191, China  
 Tel: +86-10-62304633-2079 Fax: +86-10-62304633-2504  
 E-mail: cttl@chinattl.com http://www.chinattl.cn

Client **BTL Inc .**

Certificate No: **Z18-60183**

## CALIBRATION CERTIFICATE

Object **D2450V2 - SN: 919**

Calibration Procedure(s) **FF-Z11-003-01**  
**Calibration Procedures for dipole validation kits**

Calibration date: **June 11, 2018**

This calibration Certificate documents the traceability to national standards, which realize the physical units of measurements(SI). The measurements and the uncertainties with confidence probability are given on the following pages and are part of the certificate.

All calibrations have been conducted in the closed laboratory facility: environment temperature(22±3)°C and humidity<70%.

Calibration Equipment used (M&TE critical for calibration)

Primary Standards	ID #	Cal Date(Calibrated by, Certificate No.)	Scheduled Calibration
Power Meter NRVD	102083	01-Nov-17 (CTTL, No.J17X08756)	Oct-18
Power sensor NRV-Z5	100542	01-Nov-17 (CTTL, No.J17X08756)	Oct-18
Reference Probe EX3DV4	SN 7464	12-Sep-17(SPEAG,No.EX3-7464_Sep17)	Sep-18
DAE4	SN 1525	02-Oct-17(SPEAG,No.DAE4-1525_Oct17)	Oct-18
Secondary Standards	ID #	Cal Date(Calibrated by, Certificate No.)	Scheduled Calibration
Signal Generator E4438C	MY49071430	23-Jan-18 (CTTL, No.J18X00560)	Jan-19
NetworkAnalyzer E5071C	MY46110673	24-Jan-18 (CTTL, No.J18X00561)	Jan-19

	Name	Function	Signature
Calibrated by:	Zhao Jing	SAR Test Engineer	
Reviewed by:	Lin Hao	SAR Test Engineer	
Approved by:	Qi Dianyuan	SAR Project Leader	

Issued: June 13, 2018

This calibration certificate shall not be reproduced in full without written approval of the laboratory.



In Collaboration with

**s p e a g**  
**CALIBRATION LABORATORY**

Add: No.51 Xueyuan Road, Haidian District, Beijing, 100191, China  
Tel: +86-10-62304633-2079 Fax: +86-10-62304633-2504  
E-mail: cttl@chinattl.com http://www.chinattl.cn

### Glossary:

TSL	tissue simulating liquid
ConvF	sensitivity in TSL / NORM <sub>x,y,z</sub>
N/A	not applicable or not measured

### Calibration is Performed According to the Following Standards:

- IEEE Std 1528-2013, "IEEE Recommended Practice for Determining the Peak Spatial-Averaged Specific Absorption Rate (SAR) in the Human Head from Wireless Communications Devices: Measurement Techniques", June 2013
- IEC 62209-1, "Measurement procedure for assessment of specific absorption rate of human exposure to radio frequency fields from hand-held and body-mounted wireless communication devices- Part 1: Device used next to the ear (Frequency range of 300MHz to 6GHz)", July 2016
- IEC 62209-2, "Procedure to measure the Specific Absorption Rate (SAR) For wireless communication devices used in close proximity to the human body (frequency range of 30MHz to 6GHz)", March 2010
- KDB865664, SAR Measurement Requirements for 100 MHz to 6 GHz

### Additional Documentation:

- DASY4/5 System Handbook

### Methods Applied and Interpretation of Parameters:

- Measurement Conditions:** Further details are available from the Validation Report at the end of the certificate. All figures stated in the certificate are valid at the frequency indicated.
- Antenna Parameters with TSL:** The dipole is mounted with the spacer to position its feed point exactly below the center marking of the flat phantom section, with the arms oriented parallel to the body axis.
- Feed Point Impedance and Return Loss:** These parameters are measured with the dipole positioned under the liquid filled phantom. The impedance stated is transformed from the measurement at the SMA connector to the feed point. The Return Loss ensures low reflected power. No uncertainty required.
- Electrical Delay:** One-way delay between the SMA connector and the antenna feed point. No uncertainty required.
- SAR measured:** SAR measured at the stated antenna input power.
- SAR normalized:** SAR as measured, normalized to an input power of 1 W at the antenna connector.
- SAR for nominal TSL parameters:** The measured TSL parameters are used to calculate the nominal SAR result.

The reported uncertainty of measurement is stated as the standard uncertainty of Measurement multiplied by the coverage factor  $k=2$ , which for a normal distribution Corresponds to a coverage probability of approximately 95%.





Add: No.51 Xueyuan Road, Haidian District, Beijing, 100191, China  
Tel: +86-10-62304633-2079 Fax: +86-10-62304633-2504  
E-mail: cttl@chinattl.com http://www.chinattl.cn

### Measurement Conditions

DASY system configuration, as far as not given on page 1.

DASY Version	DASY52	52.10.1.1476
Extrapolation	Advanced Extrapolation	
Phantom	Triple Flat Phantom 5.1C	
Distance Dipole Center - TSL	10 mm	with Spacer
Zoom Scan Resolution	dx, dy, dz = 5 mm	
Frequency	2450 MHz $\pm$ 1 MHz	

### Head TSL parameters

The following parameters and calculations were applied.

	Temperature	Permittivity	Conductivity
Nominal Head TSL parameters	22.0 °C	39.2	1.80 mho/m
Measured Head TSL parameters	(22.0 $\pm$ 0.2) °C	40.4 $\pm$ 6 %	1.85 mho/m $\pm$ 6 %
Head TSL temperature change during test	<1.0 °C	---	---

### SAR result with Head TSL

SAR averaged over 1 cm <sup>3</sup> (1 g) of Head TSL	Condition	
SAR measured	250 mW input power	13.1 mW / g
SAR for nominal Head TSL parameters	normalized to 1W	52.1 mW / g $\pm$ 18.8 % (k=2)
SAR averaged over 10 cm <sup>3</sup> (10 g) of Head TSL	Condition	
SAR measured	250 mW input power	6.17 mW / g
SAR for nominal Head TSL parameters	normalized to 1W	24.6 mW / g $\pm$ 18.7 % (k=2)

### Body TSL parameters

The following parameters and calculations were applied.

	Temperature	Permittivity	Conductivity
Nominal Body TSL parameters	22.0 °C	52.7	1.95 mho/m
Measured Body TSL parameters	(22.0 $\pm$ 0.2) °C	54.1 $\pm$ 6 %	1.98 mho/m $\pm$ 6 %
Body TSL temperature change during test	<1.0 °C	---	---

### SAR result with Body TSL

SAR averaged over 1 cm <sup>3</sup> (1 g) of Body TSL	Condition	
SAR measured	250 mW input power	12.7 mW / g
SAR for nominal Body TSL parameters	normalized to 1W	50.8 mW / g $\pm$ 18.8 % (k=2)
SAR averaged over 10 cm <sup>3</sup> (10 g) of Body TSL	Condition	
SAR measured	250 mW input power	5.93 mW / g
SAR for nominal Body TSL parameters	normalized to 1W	23.7 mW / g $\pm$ 18.7 % (k=2)



In Collaboration with

**s p e a g**  
CALIBRATION LABORATORY

Add: No.51 Xueyuan Road, Haidian District, Beijing, 100191, China

Tel: +86-10-62304633-2079

Fax: +86-10-62304633-2504

E-mail: cttl@chinattl.com

http://www.chinattl.cn

## Appendix (Additional assessments outside the scope of CNAS L0570)

### Antenna Parameters with Head TSL

Impedance, transformed to feed point	53.0Ω+ 2.85jΩ
Return Loss	- 27.9dB

### Antenna Parameters with Body TSL

Impedance, transformed to feed point	49.9Ω+ 4.74jΩ
Return Loss	- 26.5dB

### General Antenna Parameters and Design

Electrical Delay (one direction)	1.022 ns
----------------------------------	----------

After long term use with 100W radiated power, only a slight warming of the dipole near the feedpoint can be measured.

The dipole is made of standard semirigid coaxial cable. The center conductor of the feeding line is directly connected to the second arm of the dipole. The antenna is therefore short-circuited for DC-signals. On some of the dipoles, small end caps are added to the dipole arms in order to improve matching when loaded according to the position as explained in the "Measurement Conditions" paragraph. The SAR data are not affected by this change. The overall dipole length is still according to the Standard.

No excessive force must be applied to the dipole arms, because they might bend or the soldered connections near the feedpoint may be damaged.

### Additional EUT Data

Manufactured by	SPEAG
-----------------	-------



In Collaboration with

**s p e a g**  
**CALIBRATION LABORATORY**

Add: No.51 Xueyuan Road, Haidian District, Beijing, 100191, China

Tel: +86-10-62304633-2079

Fax: +86-10-62304633-2504

E-mail: cttl@chinattl.com

http://www.chinattl.cn

## DASY5 Validation Report for Head TSL

Date: 06.11.2018

Test Laboratory: CTTL, Beijing, China

**DUT: Dipole 2450 MHz; Type: D2450V2; Serial: D2450V2 - SN: 919**

Communication System: UID 0, CW; Frequency: 2450 MHz; Duty Cycle: 1:1

Medium parameters used:  $f = 2450$  MHz;  $\sigma = 1.85$  S/m;  $\epsilon_r = 40.36$ ;  $\rho = 1000$  kg/m<sup>3</sup>

Phantom section: Center Section

DASY5 Configuration:

- Probe: EX3DV4 - SN7464; ConvF(7.89, 7.89, 7.89) @ 2450 MHz; Calibrated: 9/12/2017
- Sensor-Surface: 1.4mm (Mechanical Surface Detection)
- Electronics: DAE4 Sn1525; Calibrated: 10/2/2017
- Phantom: MFP\_V5.1C ; Type: QD 000 P51CA; Serial: 1062
- Measurement SW: DASY52, Version 52.10 (1); SEMCAD X Version 14.6.11 (7439)

**Dipole Calibration/Zoom Scan (7x7x7) (7x7x7)/Cube 0:** Measurement grid: dx=5mm, dy=5mm, dz=5mm

Reference Value = 102.2 V/m; Power Drift = -0.05 dB

Peak SAR (extrapolated) = 27.0 W/kg

**SAR(1 g) = 13.1 W/kg; SAR(10 g) = 6.17 W/kg**

Maximum value of SAR (measured) = 22.0 W/kg

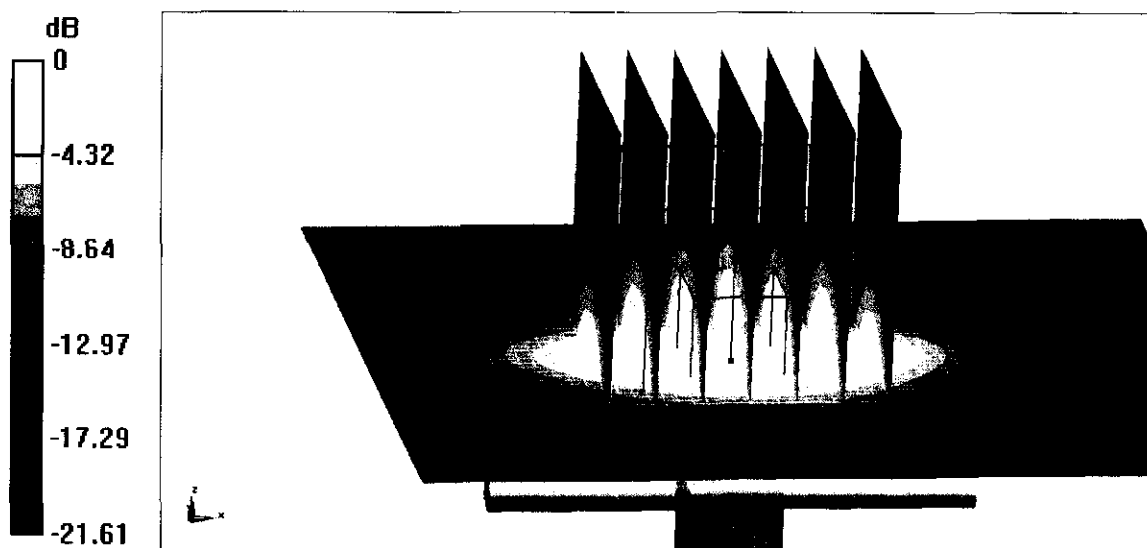

0 dB = 22.0 W/kg = 13.42 dBW/kg



Add: No.51 Xueyuan Road, Haidian District, Beijing, 100191, China  
Tel: +86-10-62304633-2079 Fax: +86-10-62304633-2504  
E-mail: cttl@chinattl.com http://www.chinattl.cn

### Impedance Measurement Plot for Head TSL

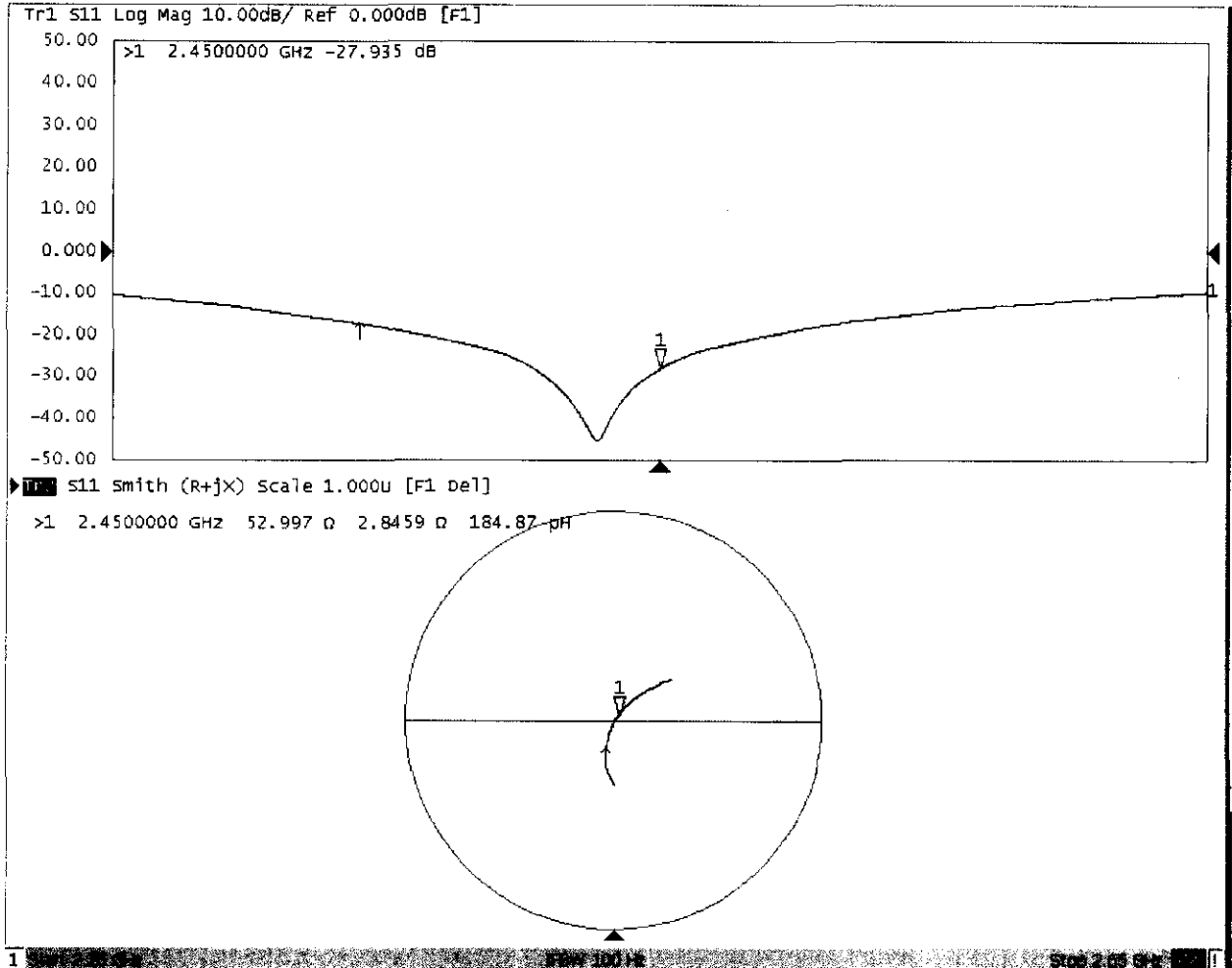



In Collaboration with

**s p e a g**

**CALIBRATION LABORATORY**

Add: No.51 Xueyuan Road, Haidian District, Beijing, 100191, China

Tel: +86-10-62304633-2079

Fax: +86-10-62304633-2504

E-mail: cttl@chinattl.com

http://www.chinattl.cn

## DASY5 Validation Report for Body TSL

Date: 06.08.2018

Test Laboratory: CTTL, Beijing, China

**DUT: Dipole 2450 MHz; Type: D2450V2; Serial: D2450V2 - SN: 919**

Communication System: UID 0, CW; Frequency: 2450 MHz; Duty Cycle: 1:1

Medium parameters used:  $f = 2450$  MHz;  $\sigma = 1.977$  S/m;  $\epsilon_r = 54.12$ ;  $\rho = 1000$  kg/m<sup>3</sup>

Phantom section: Right Section

DASY5 Configuration:

- Probe: EX3DV4 - SN7464; ConvF(8.09, 8.09, 8.09) @ 2450 MHz; Calibrated: 9/12/2017
- Sensor-Surface: 1.4mm (Mechanical Surface Detection)
- Electronics: DAE4 Sn1525; Calibrated: 10/2/2017
- Phantom: MFP\_V5.1C ; Type: QD 000 P51CA; Serial: 1062
- Measurement SW: DASY52, Version 52.10 (1); SEMCAD X Version 14.6.11 (7439)

**Dipole Calibration/Zoom Scan (7x7x7) (7x7x7)/Cube 0:** Measurement grid: dx=5mm, dy=5mm, dz=5mm

Reference Value = 81.30 V/m; Power Drift = 0.05 dB

Peak SAR (extrapolated) = 26.0 W/kg

**SAR(1 g) = 12.7 W/kg; SAR(10 g) = 5.93 W/kg**

Maximum value of SAR (measured) = 20.8 W/kg

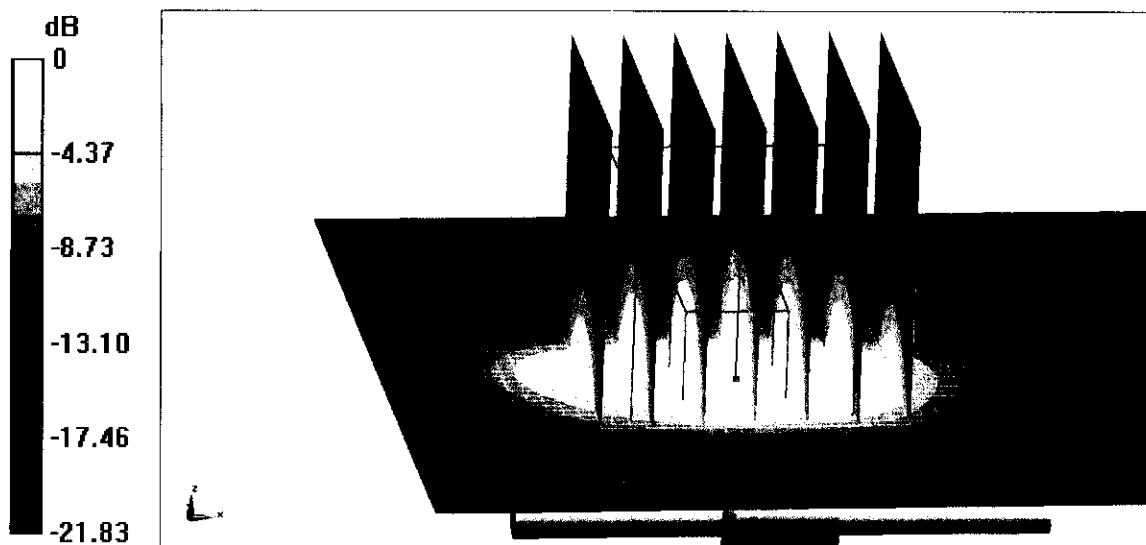

0 dB = 20.8 W/kg = 13.18 dBW/kg



Add: No.51 Xueyuan Road, Haidian District, Beijing, 100191, China  
Tel: +86-10-62304633-2079 Fax: +86-10-62304633-2504  
E-mail: cttl@chinattl.com http://www.chinattl.cn

### Impedance Measurement Plot for Body TSL

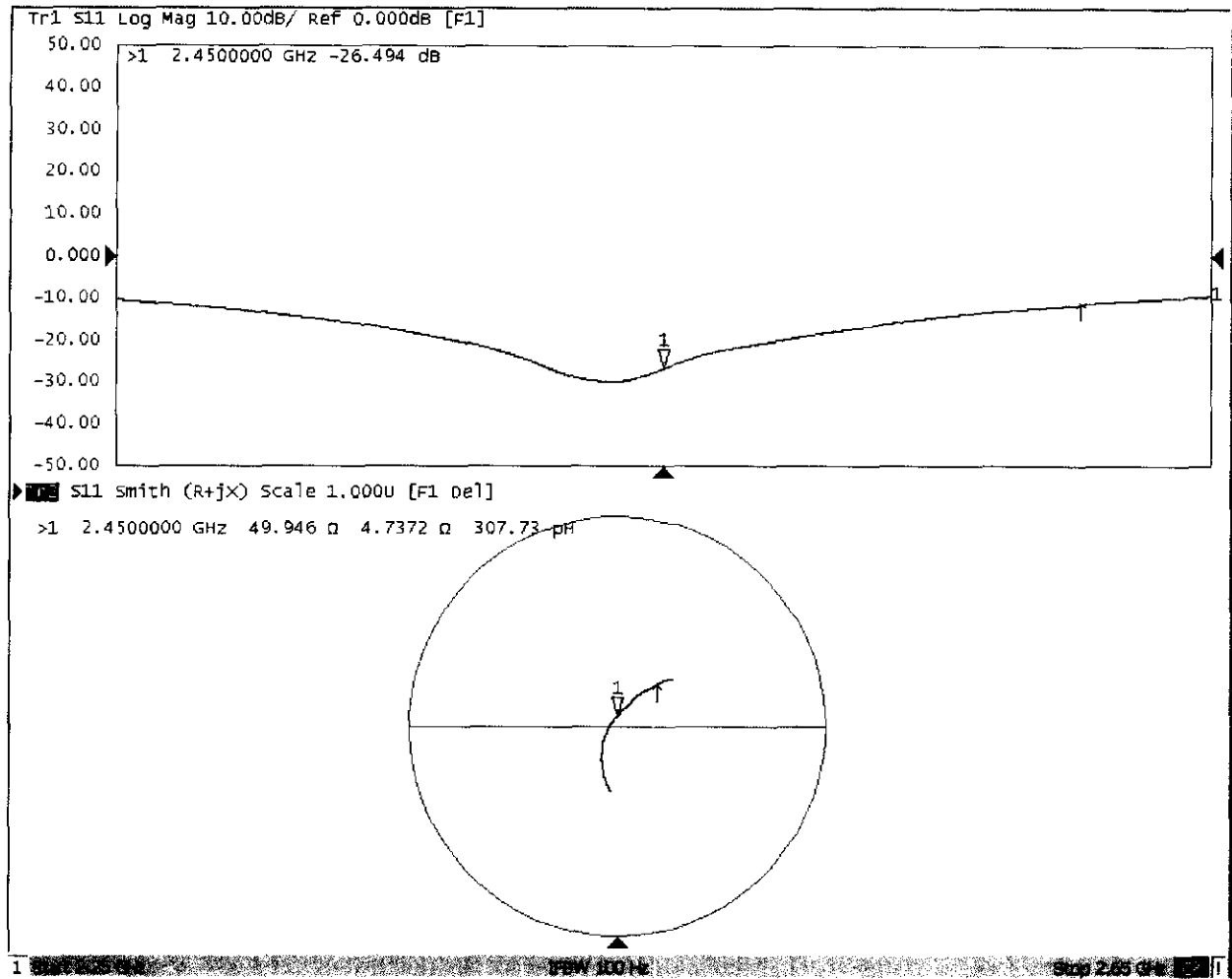



In Collaboration with  
**s p e a g**  
 CALIBRATION LABORATORY



中国认可  
 国际互认  
 校准  
 CALIBRATION  
 CNAS L0570

Add: No.51 Xueyuan Road, Haidian District, Beijing, 100191, China  
 Tel: +86-10-62304633-2079 Fax: +86-10-62304633-2504  
 E-mail: cttl@chinattl.com http://www.chinattl.cn

Client **BTL Inc .**

Certificate No: **Z18-60184**

## CALIBRATION CERTIFICATE

Object **D2600V2 - SN: 1067**

Calibration Procedure(s) **FF-Z11-003-01**  
**Calibration Procedures for dipole validation kits**

Calibration date: **June 11, 2018**

This calibration Certificate documents the traceability to national standards, which realize the physical units of measurements(SI). The measurements and the uncertainties with confidence probability are given on the following pages and are part of the certificate.

All calibrations have been conducted in the closed laboratory facility: environment temperature(22±3)°C and humidity<70%.

Calibration Equipment used (M&TE critical for calibration)

Primary Standards	ID #	Cal Date(Calibrated by, Certificate No.)	Scheduled Calibration
Power Meter NRVD	102083	01-Nov-17 (CTTL, No.J17X08756)	Oct-18
Power sensor NRV-Z5	100542	01-Nov-17 (CTTL, No.J17X08756)	Oct-18
Reference Probe EX3DV4	SN 7464	12-Sep-17(SPEAG,No.EX3-7464_Sep17)	Sep-18
DAE4	SN 1525	02-Oct-17(SPEAG,No.DAE4-1525_Oct17)	Oct-18
Secondary Standards	ID #	Cal Date(Calibrated by, Certificate No.)	Scheduled Calibration
Signal Generator E4438C	MY49071430	23-Jan-18 (CTTL, No.J18X00560)	Jan-19
Network Analyzer E5071C	MY46110673	24-Jan-18 (CTTL, No.J18X00561)	Jan-19

	Name	Function	Signature
Calibrated by:	Zhao Jing	SAR Test Engineer	
Reviewed by:	Lin Hao	SAR Test Engineer	
Approved by:	Qi Dianyuan	SAR Project Leader	

Issued: June 13, 2018

This calibration certificate shall not be reproduced except in full without written approval of the laboratory.



In Collaboration with

**s p e a g**  
**CALIBRATION LABORATORY**

Add: No.51 Xueyuan Road, Haidian District, Beijing, 100191, China  
Tel: +86-10-62304633-2079 Fax: +86-10-62304633-2504  
E-mail: cttl@chinattl.com http://www.chinattl.cn

### Glossary:

TSL	tissue simulating liquid
ConvF	sensitivity in TSL / NORM <sub>x,y,z</sub>
N/A	not applicable or not measured

### Calibration is Performed According to the Following Standards:

- IEEE Std 1528-2013, "IEEE Recommended Practice for Determining the Peak Spatial-Averaged Specific Absorption Rate (SAR) in the Human Head from Wireless Communications Devices: Measurement Techniques", June 2013
- IEC 62209-1, "Measurement procedure for assessment of specific absorption rate of human exposure to radio frequency fields from hand-held and body-mounted wireless communication devices- Part 1: Device used next to the ear (Frequency range of 300MHz to 6GHz)", July 2016
- IEC 62209-2, "Procedure to measure the Specific Absorption Rate (SAR) For wireless communication devices used in close proximity to the human body (frequency range of 30MHz to 6GHz)", March 2010
- KDB865664, SAR Measurement Requirements for 100 MHz to 6 GHz

### Additional Documentation:

- DASY4/5 System Handbook

### Methods Applied and Interpretation of Parameters:

- Measurement Conditions:** Further details are available from the Validation Report at the end of the certificate. All figures stated in the certificate are valid at the frequency indicated.
- Antenna Parameters with TSL:** The dipole is mounted with the spacer to position its feed point exactly below the center marking of the flat phantom section, with the arms oriented parallel to the body axis.
- Feed Point Impedance and Return Loss:** These parameters are measured with the dipole positioned under the liquid filled phantom. The impedance stated is transformed from the measurement at the SMA connector to the feed point. The Return Loss ensures low reflected power. No uncertainty required.
- Electrical Delay:** One-way delay between the SMA connector and the antenna feed point. No uncertainty required.
- SAR measured:** SAR measured at the stated antenna input power.
- SAR normalized:** SAR as measured, normalized to an input power of 1 W at the antenna connector.
- SAR for nominal TSL parameters:** The measured TSL parameters are used to calculate the nominal SAR result.

The reported uncertainty of measurement is stated as the standard uncertainty of Measurement multiplied by the coverage factor  $k=2$ , which for a normal distribution Corresponds to a coverage probability of approximately 95%.





Add: No.51 Xueyuan Road, Haidian District, Beijing, 100191, China  
 Tel: +86-10-62304633-2079 Fax: +86-10-62304633-2504  
 E-mail: cttl@chinattl.com http://www.chinattl.cn

### Measurement Conditions

DASY system configuration, as far as not given on page 1.

<b>DASY Version</b>	DASY52	52.10.1.1476
<b>Extrapolation</b>	Advanced Extrapolation	
<b>Phantom</b>	Triple Flat Phantom 5.1C	
<b>Distance Dipole Center - TSL</b>	10 mm	with Spacer
<b>Zoom Scan Resolution</b>	dx, dy, dz = 5 mm	
<b>Frequency</b>	2600 MHz ± 1 MHz	

### Head TSL parameters

The following parameters and calculations were applied.

	Temperature	Permittivity	Conductivity
<b>Nominal Head TSL parameters</b>	22.0 °C	39.0	1.96 mho/m
<b>Measured Head TSL parameters</b>	(22.0 ± 0.2) °C	39.9 ± 6 %	2.01 mho/m ± 6 %
<b>Head TSL temperature change during test</b>	<1.0 °C	----	----

### SAR result with Head TSL

<b>SAR averaged over 1 cm<sup>3</sup> (1 g) of Head TSL</b>	Condition	
SAR measured	250 mW input power	14.1 mW / g
SAR for nominal Head TSL parameters	normalized to 1W	<b>56.1 mW / g ± 18.8 % (k=2)</b>
<b>SAR averaged over 10 cm<sup>3</sup> (10 g) of Head TSL</b>	Condition	
SAR measured	250 mW input power	6.33 mW / g
SAR for nominal Head TSL parameters	normalized to 1W	<b>25.3 mW / g ± 18.7 % (k=2)</b>

### Body TSL parameters

The following parameters and calculations were applied.

	Temperature	Permittivity	Conductivity
<b>Nominal Body TSL parameters</b>	22.0 °C	52.5	2.16 mho/m
<b>Measured Body TSL parameters</b>	(22.0 ± 0.2) °C	54.0 ± 6 %	2.16 mho/m ± 6 %
<b>Body TSL temperature change during test</b>	<1.0 °C	----	----

### SAR result with Body TSL

<b>SAR averaged over 1 cm<sup>3</sup> (1 g) of Body TSL</b>	Condition	
SAR measured	250 mW input power	13.7 mW / g
SAR for nominal Body TSL parameters	normalized to 1W	<b>55.2 mW / g ± 18.8 % (k=2)</b>
<b>SAR averaged over 10 cm<sup>3</sup> (10 g) of Body TSL</b>	Condition	
SAR measured	250 mW input power	6.11 mW / g
SAR for nominal Body TSL parameters	normalized to 1W	<b>24.6 mW / g ± 18.7 % (k=2)</b>



In Collaboration with

**s p e a g**  
CALIBRATION LABORATORY

Add: No.51 Xueyuan Road, Haidian District, Beijing, 100191, China

Tel: +86-10-62304633-2079

Fax: +86-10-62304633-2504

E-mail: cttl@chinattl.com

http://www.chinattl.cn

## Appendix(Additional assessments outside the scope of CNAS L0570)

### Antenna Parameters with Head TSL

Impedance, transformed to feed point	47.5Ω- 6.92jΩ
Return Loss	- 22.5dB

### Antenna Parameters with Body TSL

Impedance, transformed to feed point	43.8Ω- 5.59jΩ
Return Loss	- 21.1dB

### General Antenna Parameters and Design

Electrical Delay (one direction)	1.012 ns
----------------------------------	----------

After long term use with 100W radiated power, only a slight warming of the dipole near the feedpoint can be measured.

The dipole is made of standard semirigid coaxial cable. The center conductor of the feeding line is directly connected to the second arm of the dipole. The antenna is therefore short-circuited for DC-signals. On some of the dipoles, small end caps are added to the dipole arms in order to improve matching when loaded according to the position as explained in the "Measurement Conditions" paragraph. The SAR data are not affected by this change. The overall dipole length is still according to the Standard.

No excessive force must be applied to the dipole arms, because they might bend or the soldered connections near the feedpoint may be damaged.

### Additional EUT Data

Manufactured by	SPEAG
-----------------	-------



In Collaboration with

**s p e a g**  
**CALIBRATION LABORATORY**

Add: No.51 Xueyuan Road, Haidian District, Beijing, 100191, China

Tel: +86-10-62304633-2079

Fax: +86-10-62304633-2504

E-mail: cttl@chinattl.com

http://www.chinattl.cn

## DASY5 Validation Report for Head TSL

Date: 06.11.2018

Test Laboratory: CTTL, Beijing, China

**DUT: Dipole 2600 MHz; Type: D2600V2; Serial: D2600V2 - SN: 1067**

Communication System: UID 0, CW; Frequency: 2600 MHz; Duty Cycle: 1:1

Medium parameters used:  $f = 2600$  MHz;  $\sigma = 2.01$  S/m;  $\epsilon_r = 39.93$ ;  $\rho = 1000$  kg/m<sup>3</sup>

Phantom section: Center Section

DASY5 Configuration:

- Probe: EX3DV4 - SN7464; ConvF(7.76, 7.76, 7.76) @ 2600 MHz; Calibrated: 9/12/2017
- Sensor-Surface: 1.4mm (Mechanical Surface Detection)
- Electronics: DAE4 Sn1525; Calibrated: 10/2/2017
- Phantom: MFP\_V5.1C ; Type: QD 000 P51CA; Serial: 1062
- Measurement SW: DASY52, Version 52.10 (1); SEMCAD X Version 14.6.11 (7439)

**Dipole Calibration/Zoom Scan (7x7x7) (7x7x7)/Cube 0:** Measurement grid: dx=5mm, dy=5mm, dz=5mm

Reference Value = 98.20 V/m; Power Drift = -0.02 dB

Peak SAR (extrapolated) = 30.3 W/kg

**SAR(1 g) = 14.1 W/kg; SAR(10 g) = 6.33 W/kg**

Maximum value of SAR (measured) = 24.2 W/kg

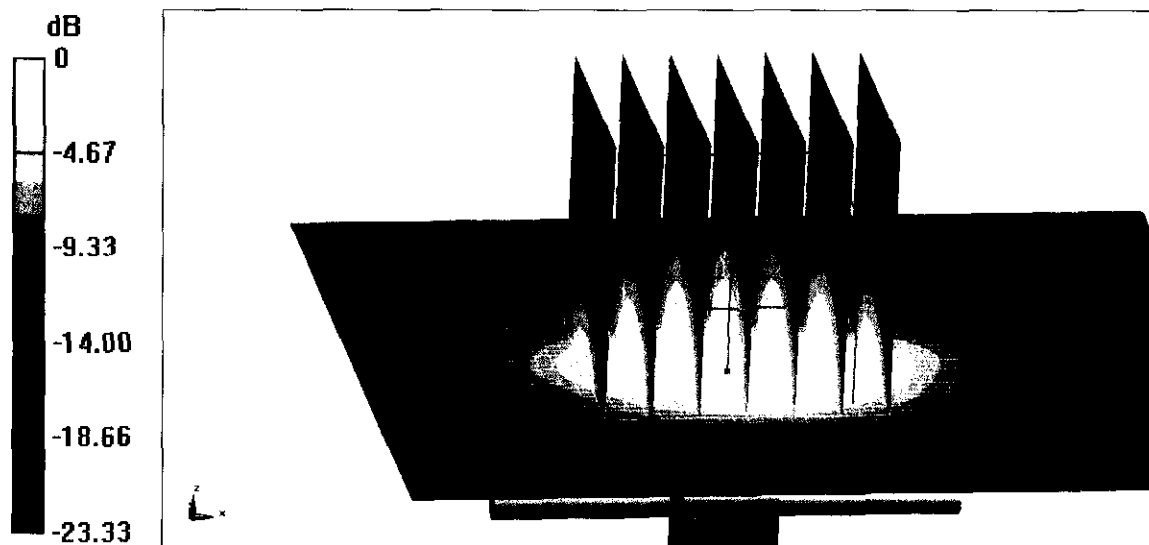

0 dB = 24.2 W/kg = 13.84 dBW/kg



Add: No.51 Xueyuan Road, Haidian District, Beijing, 100191, China  
Tel: +86-10-62304633-2079 Fax: +86-10-62304633-2504  
E-mail: cttl@chinattl.com http://www.chinattl.cn

### Impedance Measurement Plot for Head TSL

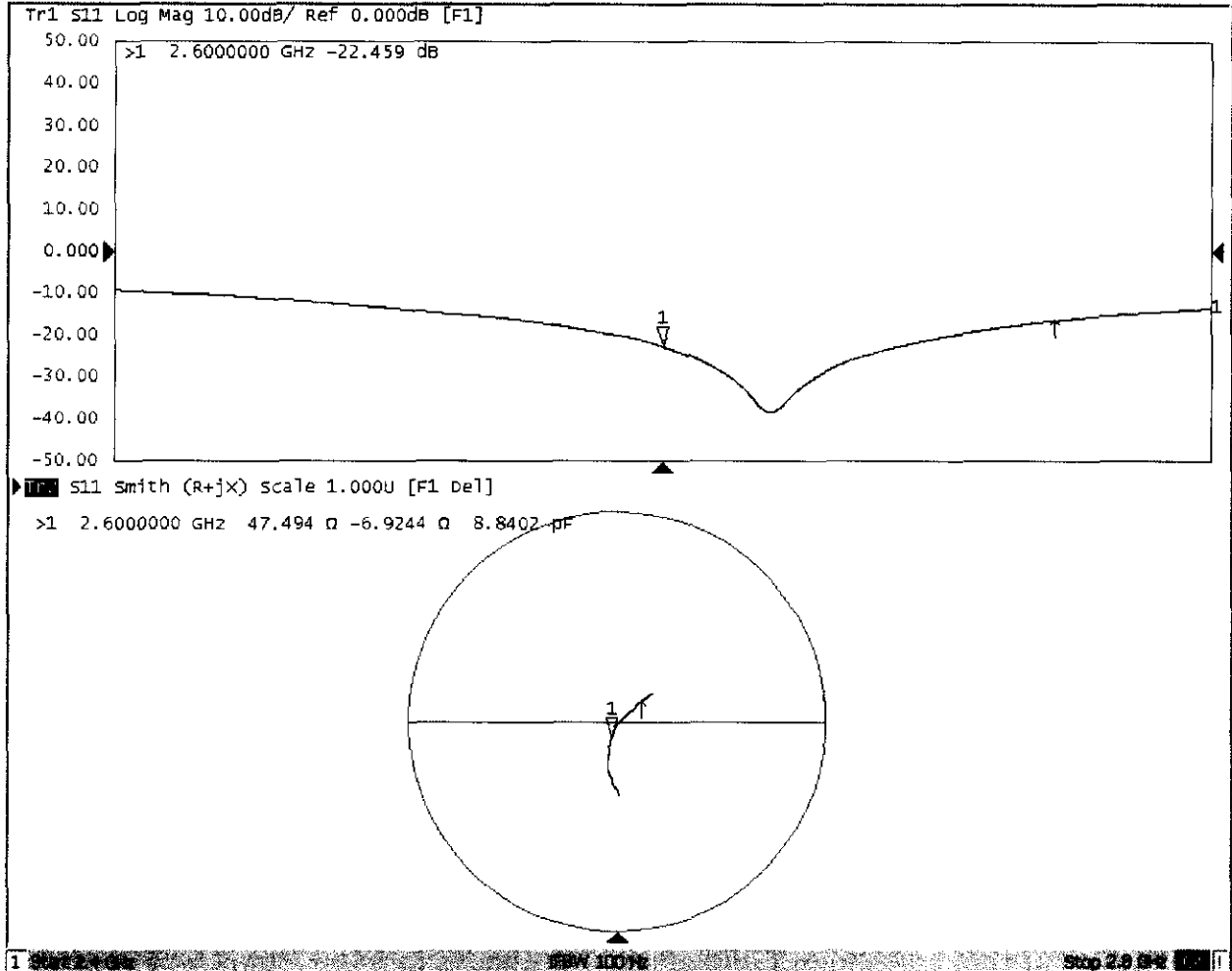



In Collaboration with

**s p e a g**

**CALIBRATION LABORATORY**

Add: No.51 Xueyuan Road, Haidian District, Beijing, 100191, China

Tel: +86-10-62304633-2079

Fax: +86-10-62304633-2504

E-mail: cttl@chinattl.com

http://www.chinattl.cn

## DASY5 Validation Report for Body TSL

Date: 06.08.2018

Test Laboratory: CTTL, Beijing, China

**DUT: Dipole 2600 MHz; Type: D2600V2; Serial: D2600V2 - SN: 1067**

Communication System: UID 0, CW; Frequency: 2600 MHz; Duty Cycle: 1:1

Medium parameters used:  $f = 2600$  MHz;  $\sigma = 2.157$  S/m;  $\epsilon_r = 54.01$ ;  $\rho = 1000$  kg/m<sup>3</sup>

Phantom section: Right Section

DASY5 Configuration:

- Probe: EX3DV4 - SN7464; ConvF(7.84, 7.84, 7.84) @ 2600 MHz; Calibrated: 9/12/2017
- Sensor-Surface: 1.4mm (Mechanical Surface Detection)
- Electronics: DAE4 Sn1525; Calibrated: 10/2/2017
- Phantom: MFP\_V5.1C ; Type: QD 000 P51CA; Serial: 1062
- Measurement SW: DASY52, Version 52.10 (1); SEMCAD X Version 14.6.11 (7439)

**Dipole Calibration/Zoom Scan (7x7x7) (7x7x7)/Cube 0:** Measurement grid: dx=5mm, dy=5mm, dz=5mm

Reference Value = 78.44 V/m; Power Drift = -0.05 dB

Peak SAR (extrapolated) = 29.5 W/kg

**SAR(1 g) = 13.7 W/kg; SAR(10 g) = 6.11 W/kg**

Maximum value of SAR (measured) = 23.5 W/kg

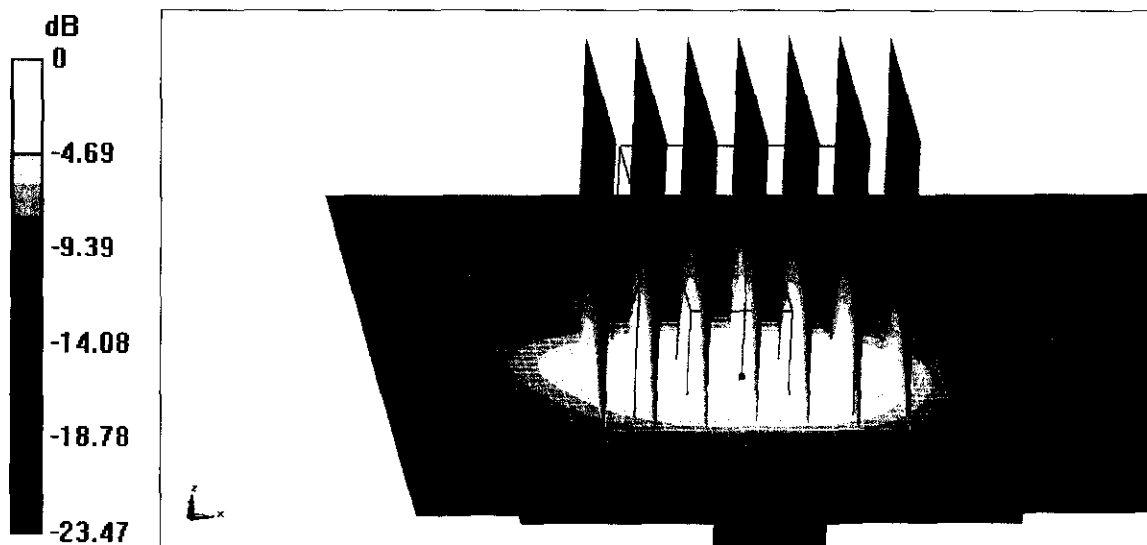

0 dB = 23.5 W/kg = 13.71 dBW/kg



Add: No.51 Xueyuan Road, Haidian District, Beijing, 100191, China  
Tel: +86-10-62304633-2079 Fax: +86-10-62304633-2504  
E-mail: cttl@chinattl.com http://www.chinattl.cn

### Impedance Measurement Plot for Body TSL

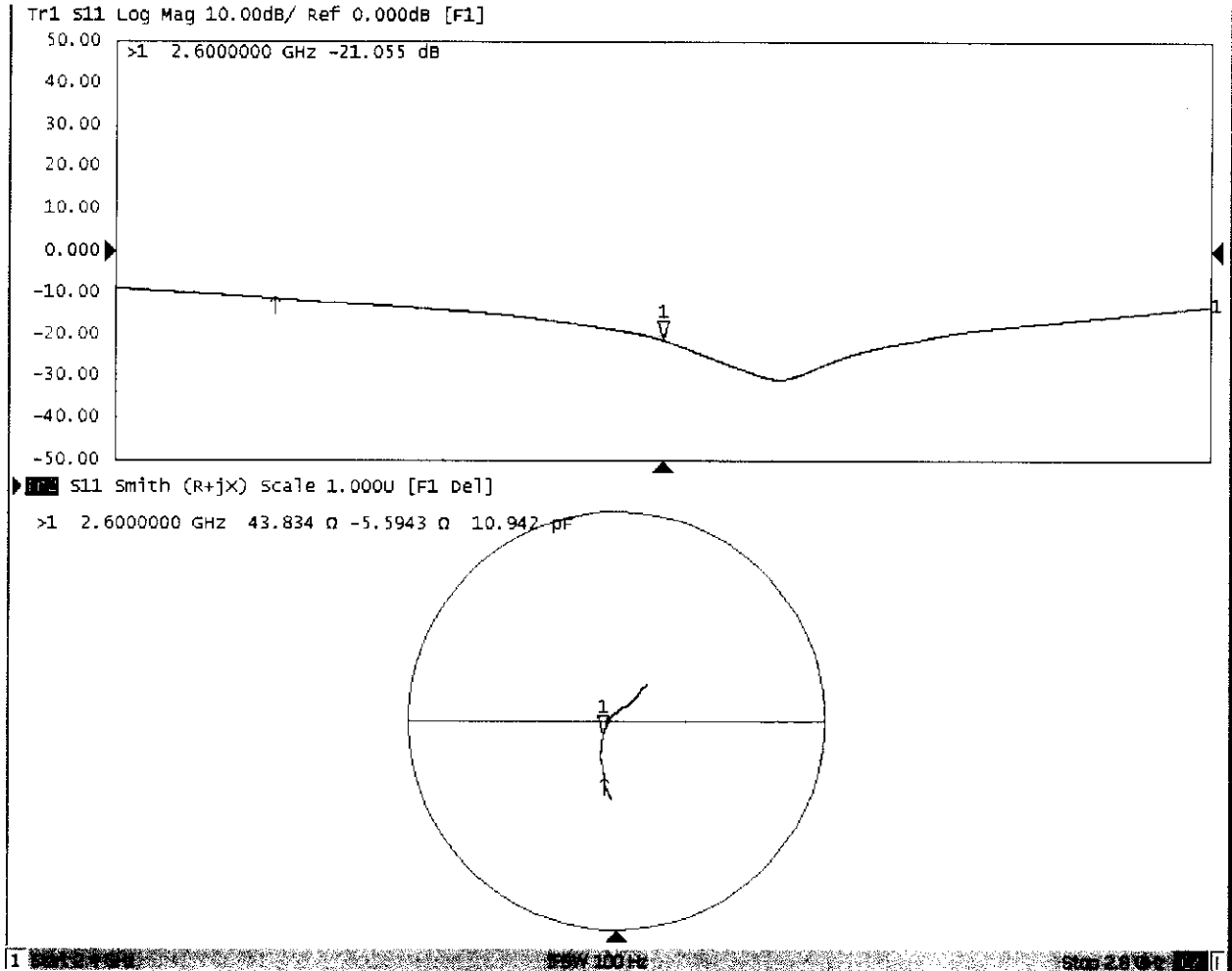



In Collaboration with  
**s p e a g**  
CALIBRATION LABORATORY



中国认可  
国际互认  
校准  
CALIBRATION  
CNAS L0570

Add: No.51 Xueyuan Road, Haidian District, Beijing, 100191, China  
Tel: +86-10-62304633-2512 Fax: +86-10-62304633-2504  
E-mail: cttl@chinattl.com http://www.chinattl.cn

Client **BTL Inc .**

Certificate No: **Z18-60185**

## CALIBRATION CERTIFICATE

Object **D5GHzV2 - SN: 1160**

Calibration Procedure(s) **FF-Z11-003-01**  
**Calibration Procedures for dipole validation kits**

Calibration date: **June 20, 2018**

This calibration Certificate documents the traceability to national standards, which realize the physical units of measurements(SI). The measurements and the uncertainties with confidence probability are given on the following pages and are part of the certificate.

All calibrations have been conducted in the closed laboratory facility: environment temperature(22±3)°C and humidity<70%.

Calibration Equipment used (M&TE critical for calibration)

Primary Standards	ID #	Cal Date(Calibrated by, Certificate No.)	Scheduled Calibration
Power Meter NRP2	102083	01-Nov-17 (CTTL, No.J17X08756)	Oct-18
Power sensor NRP-Z91	100542	01-Nov-17 (CTTL, No.J17X08756)	Oct-18
ReferenceProbe EX3DV4	SN 3846	25-Jan-18(SPEAG,No.EX3-3846_Jan18)	Jan-19
DAE4	SN 1525	02-Oct-17(SPEAG,No.DAE4-1525_Oct17)	Oct-18
DAE4	SN 777	15-Dec-17(SPEAG,No.DAE4-777_Dec17)	Dec-18

Secondary Standards	ID #	Cal Date(Calibrated by, Certificate No.)	Scheduled Calibration
Signal Generator E4438C	MY49071430	23-Jan-18 (CTTL, No.J18X00560)	Jan-19
NetworkAnalyzerE5071C	MY46110673	24-Jan-18 (CTTL, No.J18X00561)	Jan-19

	Name	Function	Signature
Calibrated by:	Zhao Jing	SAR Test Engineer	
Reviewed by:	Lin Hao	SAR Test Engineer	
Approved by:	Qi Dianyuan	SAR Project Leader	

Issued: June 23, 2018

This calibration certificate shall not be reproduced except in full without written approval of the laboratory.



In Collaboration with

**s p e a g**  
**CALIBRATION LABORATORY**

Add: No.51 Xueyuan Road, Haidian District, Beijing, 100191, China  
Tel: +86-10-62304633-2512 Fax: +86-10-62304633-2504  
E-mail: cttl@chinattl.com http://www.chinattl.cn

### Glossary:

TSL	tissue simulating liquid
ConvF	sensitivity in TSL / NORM <sub>x,y,z</sub>
N/A	not applicable or not measured

### Calibration is Performed According to the Following Standards:

- IEEE Std 1528-2013, "IEEE Recommended Practice for Determining the Peak Spatial-Averaged Specific Absorption Rate (SAR) in the Human Head from Wireless Communications Devices: Measurement Techniques", June 2013
- IEC 62209-1, "Measurement procedure for assessment of specific absorption rate of human exposure to radio frequency fields from hand-held and body-mounted wireless communication devices- Part 1: Device used next to the ear (Frequency range of 300MHz to 6GHz)", July 2016
- IEC 62209-2, "Procedure to measure the Specific Absorption Rate (SAR) For wireless communication devices used in close proximity to the human body (frequency range of 30MHz to 6GHz)", March 2010
- KDB865664, SAR Measurement Requirements for 100 MHz to 6 GHz

### Additional Documentation:

- DASY4/5 System Handbook

### Methods Applied and Interpretation of Parameters:

- Measurement Conditions:** Further details are available from the Validation Report at the end of the certificate. All figures stated in the certificate are valid at the frequency indicated.
- Antenna Parameters with TSL:** The dipole is mounted with the spacer to position its feed point exactly below the center marking of the flat phantom section, with the arms oriented parallel to the body axis.
- Feed Point Impedance and Return Loss:** These parameters are measured with the dipole positioned under the liquid filled phantom. The impedance stated is transformed from the measurement at the SMA connector to the feed point. The Return Loss ensures low reflected power. No uncertainty required.
- Electrical Delay:** One-way delay between the SMA connector and the antenna feed point. No uncertainty required.
- SAR measured:** SAR measured at the stated antenna input power.
- SAR normalized:** SAR as measured, normalized to an input power of 1 W at the antenna connector.
- SAR for nominal TSL parameters:** The measured TSL parameters are used to calculate the nominal SAR result.

The reported uncertainty of measurement is stated as the standard uncertainty of Measurement multiplied by the coverage factor  $k=2$ , which for a normal distribution Corresponds to a coverage probability of approximately 95%.





In Collaboration with

**s p e a g**  
CALIBRATION LABORATORY

Add: No.51 Xueyuan Road, Haidian District, Beijing, 100191, China  
Tel: +86-10-62304633-2512 Fax: +86-10-62304633-2504  
E-mail: cttl@chinattl.com http://www.chinattl.cn

**Measurement Conditions**

DASY system configuration, as far as not given on page 1.

DASY Version	DASY52	52.10.1.1476
Extrapolation	Advanced Extrapolation	
Phantom	Triple Flat Phantom 5.1C	
Distance Dipole Center - TSL	10 mm	with Spacer
Zoom Scan Resolution	dx, dy = 4 mm, dz = 1.4 mm	Graded Ratio = 1.4 (Z direction)
Frequency	5200 MHz ± 1 MHz 5300 MHz ± 1 MHz 5500 MHz ± 1 MHz 5600 MHz ± 1 MHz 5800 MHz ± 1 MHz	

**Head TSL parameters at 5200 MHz**

The following parameters and calculations were applied.

	Temperature	Permittivity	Conductivity
Nominal Head TSL parameters	22.0 °C	36.0	4.66 mho/m
Measured Head TSL parameters	(22.0 ± 0.2) °C	36.6 ± 6 %	4.63 mho/m ± 6 %
Head TSL temperature change during test	<1.0 °C	----	----

**SAR result with Head TSL at 5200 MHz**

SAR averaged over 1 cm <sup>3</sup> (1 g) of Head TSL	Condition	
SAR measured	100 mW input power	7.50 mW / g
SAR for nominal Head TSL parameters	normalized to 1W	75.3 mW / g ± 24.4 % (k=2)
SAR averaged over 10 cm <sup>3</sup> (10 g) of Head TSL	Condition	
SAR measured	100 mW input power	2.16 mW / g
SAR for nominal Head TSL parameters	normalized to 1W	21.7 mW / g ± 24.2 % (k=2)



Add: No.51 Xueyuan Road, Haidian District, Beijing, 100191, China  
Tel: +86-10-62304633-2512 Fax: +86-10-62304633-2504  
E-mail: cttl@chinattl.com http://www.chinattl.cn

### Head TSL parameters at 5300 MHz

The following parameters and calculations were applied.

	Temperature	Permittivity	Conductivity
Nominal Head TSL parameters	22.0 °C	35.9	4.76 mho/m
Measured Head TSL parameters	(22.0 ± 0.2) °C	36.3 ± 6 %	4.75 mho/m ± 6 %
Head TSL temperature change during test	<1.0 °C	----	----

### SAR result with Head TSL at 5300 MHz

SAR averaged over 1 cm <sup>3</sup> (1 g) of Head TSL	Condition	
SAR measured	100 mW input power	7.66 mW / g
SAR for nominal Head TSL parameters	normalized to 1W	76.8 mW / g ± 24.4 % (k=2)
SAR averaged over 10 cm <sup>3</sup> (10 g) of Head TSL	Condition	
SAR measured	100 mW input power	2.20 mW / g
SAR for nominal Head TSL parameters	normalized to 1W	22.1 mW / g ± 24.2 % (k=2)

### Head TSL parameters at 5500 MHz

The following parameters and calculations were applied.

	Temperature	Permittivity	Conductivity
Nominal Head TSL parameters	22.0 °C	35.6	4.96 mho/m
Measured Head TSL parameters	(22.0 ± 0.2) °C	35.6 ± 6 %	4.94 mho/m ± 6 %
Head TSL temperature change during test	<1.0 °C	----	----

### SAR result with Head TSL at 5500 MHz

SAR averaged over 1 cm <sup>3</sup> (1 g) of Head TSL	Condition	
SAR measured	100 mW input power	8.08 mW / g
SAR for nominal Head TSL parameters	normalized to 1W	80.8 mW / g ± 24.4 % (k=2)
SAR averaged over 10 cm <sup>3</sup> (10 g) of Head TSL	Condition	
SAR measured	100 mW input power	2.30 mW / g
SAR for nominal Head TSL parameters	normalized to 1W	23.0 mW / g ± 24.2 % (k=2)



In Collaboration with

**s p e a g**  
CALIBRATION LABORATORY

Add: No.51 Xueyuan Road, Haidian District, Beijing, 100191, China  
Tel: +86-10-62304633-2512 Fax: +86-10-62304633-2504  
E-mail: cttl@chinattl.com http://www.chinattl.cn

### Head TSL parameters at 5600 MHz

The following parameters and calculations were applied.

	Temperature	Permittivity	Conductivity
Nominal Head TSL parameters	22.0 °C	35.5	5.07 mho/m
Measured Head TSL parameters	(22.0 ± 0.2) °C	35.8 ± 6 %	4.98 mho/m ± 6 %
Head TSL temperature change during test	<1.0 °C	----	----

### SAR result with Head TSL at 5600 MHz

SAR averaged over 1 cm <sup>3</sup> (1 g) of Head TSL	Condition	
SAR measured	100 mW input power	7.85 mW / g
SAR for nominal Head TSL parameters	normalized to 1W	78.6 mW / g ± 24.4 % (k=2)
SAR averaged over 10 cm <sup>3</sup> (10 g) of Head TSL	Condition	
SAR measured	100 mW input power	2.25 mW / g
SAR for nominal Head TSL parameters	normalized to 1W	22.5 mW / g ± 24.2 % (k=2)

### Head TSL parameters at 5800 MHz

The following parameters and calculations were applied.

	Temperature	Permittivity	Conductivity
Nominal Head TSL parameters	22.0 °C	35.3	5.27 mho/m
Measured Head TSL parameters	(22.0 ± 0.2) °C	35.6 ± 6 %	5.24 mho/m ± 6 %
Head TSL temperature change during test	<1.0 °C	----	----

### SAR result with Head TSL at 5800 MHz

SAR averaged over 1 cm <sup>3</sup> (1 g) of Head TSL	Condition	
SAR measured	100 mW input power	7.78 mW / g
SAR for nominal Head TSL parameters	normalized to 1W	77.9 mW / g ± 24.4 % (k=2)
SAR averaged over 10 cm <sup>3</sup> (10 g) of Head TSL	Condition	
SAR measured	100 mW input power	2.21 mW / g
SAR for nominal Head TSL parameters	normalized to 1W	22.1 mW / g ± 24.2 % (k=2)



In Collaboration with

**s p e a g**  
CALIBRATION LABORATORY

Add: No.51 Xueyuan Road, Haidian District, Beijing, 100191, China

Tel: +86-10-62304633-2512

Fax: +86-10-62304633-2504

E-mail: cttl@chinattl.com

http://www.chinattl.cn

### Body TSL parameters at 5200 MHz

The following parameters and calculations were applied.

	Temperature	Permittivity	Conductivity
<b>Nominal Body TSL parameters</b>	22.0 °C	49.0	5.30 mho/m
<b>Measured Body TSL parameters</b>	(22.0 ± 0.2) °C	48.8 ± 6 %	5.32 mho/m ± 6 %
<b>Body TSL temperature change during test</b>	<1.0 °C	----	----

### SAR result with Body TSL at 5200 MHz

<b>SAR averaged over 1 cm<sup>3</sup> (1 g) of Body TSL</b>	Condition	
SAR measured	100 mW input power	6.99 mW / g
SAR for nominal Body TSL parameters	normalized to 1W	<b>69.8 mW / g ± 24.4 % (k=2)</b>
<b>SAR averaged over 10 cm<sup>3</sup> (10 g) of Body TSL</b>	Condition	
SAR measured	100 mW input power	1.92 mW / g
SAR for nominal Body TSL parameters	normalized to 1W	<b>19.2 mW / g ± 24.2 % (k=2)</b>

### Body TSL parameters at 5300 MHz

The following parameters and calculations were applied.

	Temperature	Permittivity	Conductivity
<b>Nominal Body TSL parameters</b>	22.0 °C	48.9	5.42 mho/m
<b>Measured Body TSL parameters</b>	(22.0 ± 0.2) °C	48.4 ± 6 %	5.38 mho/m ± 6 %
<b>Body TSL temperature change during test</b>	<1.0 °C	----	----

### SAR result with Body TSL at 5300 MHz

<b>SAR averaged over 1 cm<sup>3</sup> (1 g) of Body TSL</b>	Condition	
SAR measured	100 mW input power	7.25 mW / g
SAR for nominal Body TSL parameters	normalized to 1W	<b>72.3 mW / g ± 24.4 % (k=2)</b>
<b>SAR averaged over 10 cm<sup>3</sup> (10 g) of Body TSL</b>	Condition	
SAR measured	100 mW input power	2.04 mW / g
SAR for nominal Body TSL parameters	normalized to 1W	<b>20.3 mW / g ± 24.2 % (k=2)</b>



In Collaboration with

**s p e a g**  
CALIBRATION LABORATORY

Add: No.51 Xueyuan Road, Haidian District, Beijing, 100191, China

Tel: +86-10-62304633-2512

Fax: +86-10-62304633-2504

E-mail: cttl@chinattl.com

http://www.chinattl.cn

### Body TSL parameters at 5500 MHz

The following parameters and calculations were applied.

	Temperature	Permittivity	Conductivity
Nominal Body TSL parameters	22.0 °C	48.6	5.65 mho/m
Measured Body TSL parameters	(22.0 ± 0.2) °C	48.4 ± 6 %	5.56 mho/m ± 6 %
Body TSL temperature change during test	<1.0 °C	----	----

### SAR result with Body TSL at 5500 MHz

SAR averaged over 1 cm <sup>3</sup> (1 g) of Body TSL	Condition	
SAR measured	100 mW input power	7.63 mW / g
SAR for nominal Body TSL parameters	normalized to 1W	76.2 mW / g ± 24.4 % (k=2)
SAR averaged over 10 cm <sup>3</sup> (10 g) of Body TSL	Condition	
SAR measured	100 mW input power	2.13 mW / g
SAR for nominal Body TSL parameters	normalized to 1W	21.3 mW / g ± 24.2 % (k=2)

### Body TSL parameters at 5600 MHz

The following parameters and calculations were applied.

	Temperature	Permittivity	Conductivity
Nominal Body TSL parameters	22.0 °C	48.5	5.77 mho/m
Measured Body TSL parameters	(22.0 ± 0.2) °C	48.1 ± 6 %	5.80 mho/m ± 6 %
Body TSL temperature change during test	<1.0 °C	----	----

### SAR result with Body TSL at 5600 MHz

SAR averaged over 1 cm <sup>3</sup> (1 g) of Body TSL	Condition	
SAR measured	100 mW input power	7.78 mW / g
SAR for nominal Body TSL parameters	normalized to 1W	77.7 mW / g ± 24.4 % (k=2)
SAR averaged over 10 cm <sup>3</sup> (10 g) of Body TSL	Condition	
SAR measured	100 mW input power	2.14 mW / g
SAR for nominal Body TSL parameters	normalized to 1W	21.4 mW / g ± 24.2 % (k=2)



In Collaboration with

**s p e a g**  
**CALIBRATION LABORATORY**

Add: No.51 Xueyuan Road, Haidian District, Beijing, 100191, China  
Tel: +86-10-62304633-2512 Fax: +86-10-62304633-2504  
E-mail: cttl@chinattl.com http://www.chinattl.cn

### Body TSL parameters at 5800 MHz

The following parameters and calculations were applied.

	Temperature	Permittivity	Conductivity
Nominal Body TSL parameters	22.0 °C	48.2	6.00 mho/m
Measured Body TSL parameters	(22.0 ± 0.2) °C	48.0 ± 6 %	6.07 mho/m ± 6 %
Body TSL temperature change during test	<1.0 °C	----	----

### SAR result with Body TSL at 5800 MHz

SAR averaged over 1 cm <sup>3</sup> (1 g) of Body TSL	Condition	
SAR measured	100 mW input power	7.66 mW / g
SAR for nominal Body TSL parameters	normalized to 1W	76.6 mW /g ± 24.4 % (k=2)
SAR averaged over 10 cm <sup>3</sup> (10 g) of Body TSL	Condition	
SAR measured	100 mW input power	2.15 mW / g
SAR for nominal Body TSL parameters	normalized to 1W	21.5 mW /g ± 24.2 % (k=2)



In Collaboration with

**s p e a g**  
CALIBRATION LABORATORY

Add: No.51 Xueyuan Road, Haidian District, Beijing, 100191, China  
Tel: +86-10-62304633-2512 Fax: +86-10-62304633-2504  
E-mail: cttl@chinattl.com http://www.chinattl.cn

## Appendix (Additional assessments outside the scope of CNAS L0570)

### Antenna Parameters with Head TSL at 5200 MHz

Impedance, transformed to feed point	53.5Ω - 8.96jΩ
Return Loss	- 20.7dB

### Antenna Parameters with Head TSL at 5300 MHz

Impedance, transformed to feed point	50.1Ω - 3.00jΩ
Return Loss	- 30.5dB

### Antenna Parameters with Head TSL at 5500 MHz

Impedance, transformed to feed point	51.4Ω - 5.39jΩ
Return Loss	- 25.2dB

### Antenna Parameters with Head TSL at 5600 MHz

Impedance, transformed to feed point	57.5Ω - 2.95jΩ
Return Loss	- 22.5dB

### Antenna Parameters with Head TSL at 5800 MHz

Impedance, transformed to feed point	54.5Ω - 1.38jΩ
Return Loss	- 26.9dB

### Antenna Parameters with Body TSL at 5200 MHz

Impedance, transformed to feed point	53.1Ω - 7.52jΩ
Return Loss	- 22.1dB

### Antenna Parameters with Body TSL at 5300 MHz

Impedance, transformed to feed point	49.3Ω - 2.06jΩ
Return Loss	- 33.1dB



Add: No.51 Xueyuan Road, Haidian District, Beijing, 100191, China  
Tel: +86-10-62304633-2512 Fax: +86-10-62304633-2504  
E-mail: cttl@chinattl.com http://www.chinattl.cn

### Antenna Parameters with Body TSL at 5500 MHz

Impedance, transformed to feed point	50.9 $\Omega$ - 4.94j $\Omega$
Return Loss	- 26.1dB

### Antenna Parameters with Body TSL at 5600 MHz

Impedance, transformed to feed point	58.5 $\Omega$ - 0.79j $\Omega$
Return Loss	- 22.1dB

### Antenna Parameters with Body TSL at 5800 MHz

Impedance, transformed to feed point	54.3 $\Omega$ + 0.12j $\Omega$
Return Loss	- 27.6dB

### General Antenna Parameters and Design

Electrical Delay (one direction)	1.065 ns
----------------------------------	----------

After long term use with 100W radiated power, only a slight warming of the dipole near the feedpoint can be measured.

The dipole is made of standard semirigid coaxial cable. The center conductor of the feeding line is directly connected to the second arm of the dipole. The antenna is therefore short-circuited for DC-signals. On some of the dipoles, small end caps are added to the dipole arms in order to improve matching when loaded according to the position as explained in the "Measurement Conditions" paragraph. The SAR data are not affected by this change. The overall dipole length is still according to the Standard.

No excessive force must be applied to the dipole arms, because they might bend or the soldered connections near the feedpoint may be damaged.

### Additional EUT Data

Manufactured by	SPEAG
-----------------	-------





In Collaboration with

**s p e a g**  
**CALIBRATION LABORATORY**

Add: No.51 Xueyuan Road, Haidian District, Beijing, 100191, China  
Tel: +86-10-62304633-2512 Fax: +86-10-62304633-2504  
E-mail: cttl@chinattl.com http://www.chinattl.cn

## DASY5 Validation Report for Head TSL

Date: 06.20.2018

Test Laboratory: CTTL, Beijing, China

### DUT: Dipole 5GHz; Type: D5GHzV2; Serial: D5GHzV2 - SN: 1160

Communication System: CW; Frequency: 5200 MHz, Frequency: 5300 MHz,  
Frequency: 5500 MHz, Frequency: 5600 MHz, Frequency: 5800 MHz,

Medium parameters used:  $f = 5200$  MHz;  $\sigma = 4.633$  S/m;  $\epsilon_r = 36.62$ ;  $\rho = 1000$  kg/m<sup>3</sup>,  
Medium parameters used:  $f = 5300$  MHz;  $\sigma = 4.754$  S/m;  $\epsilon_r = 36.31$ ;  $\rho = 1000$  kg/m<sup>3</sup>,  
Medium parameters used:  $f = 5500$  MHz;  $\sigma = 4.942$  S/m;  $\epsilon_r = 35.58$ ;  $\rho = 1000$  kg/m<sup>3</sup>,  
Medium parameters used:  $f = 5600$  MHz;  $\sigma = 4.984$  S/m;  $\epsilon_r = 35.81$ ;  $\rho = 1000$  kg/m<sup>3</sup>,  
Medium parameters used:  $f = 5800$  MHz;  $\sigma = 5.241$  S/m;  $\epsilon_r = 35.58$ ;  $\rho = 1000$  kg/m<sup>3</sup>,

Phantom section: Right Section

### DASY5 Configuration:

- Probe: EX3DV4 - SN3846; ConvF(5.57, 5.57, 5.57) @ 5200 MHz; Calibrated: 1/25/2018, ConvF(5.34, 5.34, 5.34) @ 5300 MHz; Calibrated: 1/25/2018, ConvF(4.91, 4.91, 4.91) @ 5500 MHz; Calibrated: 1/25/2018, ConvF(4.73, 4.73, 4.73) @ 5600 MHz; Calibrated: 1/25/2018, ConvF(4.9, 4.9, 4.9) @ 5800 MHz; Calibrated: 1/25/2018,
- Sensor-Surface: 1.4mm (Mechanical Surface Detection)
- Electronics: DAE4 Sn777; Calibrated: 12/15/2017
- Phantom: Triple Flat Phantom 5.1C; Type: QD 000 P51 CA; Serial: 1161/3
- Measurement SW: DASY52, Version 52.10 (1); SEMCAD X Version 14.6.11 (7439)

### Dipole Calibration /Pin=100mW, d=10mm, f=5200 MHz/Zoom Scan,

dist=1.4mm (8x8x7)/Cube 0: Measurement grid: dx=4mm, dy=4mm, dz=1.4mm  
Reference Value = 67.38 V/m; Power Drift = 0.01 dB

Peak SAR (extrapolated) = 31.8 W/kg

**SAR(1 g) = 7.5 W/kg; SAR(10 g) = 2.16 W/kg**

Maximum value of SAR (measured) = 17.8 W/kg

### Dipole Calibration /Pin=100mW, d=10mm, f=5300 MHz/Zoom Scan,

dist=1.4mm (8x8x7)/Cube 0: Measurement grid: dx=4mm, dy=4mm, dz=1.4mm  
Reference Value = 62.70 V/m; Power Drift = -0.02 dB

Peak SAR (extrapolated) = 33.3 W/kg

**SAR(1 g) = 7.66 W/kg; SAR(10 g) = 2.2 W/kg**

Maximum value of SAR (measured) = 18.4 W/kg



In Collaboration with

**s p e a g**  
**CALIBRATION LABORATORY**

Add: No.51 Xueyuan Road, Haidian District, Beijing, 100191, China

Tel: +86-10-62304633-2512

Fax: +86-10-62304633-2504

E-mail: cttl@chinattl.com

http://www.chinattl.cn

**Dipole Calibration /Pin=100mW, d=10mm, f=5500 MHz/Zoom Scan,**  
**dist=1.4mm (8x8x7)/Cube 0:** Measurement grid: dx=4mm, dy=4mm, dz=1.4mm  
Reference Value = 66.94 V/m; Power Drift = 0.06 dB  
Peak SAR (extrapolated) = 36.4 W/kg  
**SAR(1 g) = 8.08 W/kg; SAR(10 g) = 2.3 W/kg**  
Maximum value of SAR (measured) = 19.4 W/kg

**Dipole Calibration /Pin=100mW, d=10mm, f=5600 MHz/Zoom Scan,**  
**dist=1.4mm (8x8x7)/Cube 0:** Measurement grid: dx=4mm, dy=4mm, dz=1.4mm  
Reference Value = 65.08 V/m; Power Drift = -0.01 dB  
Peak SAR (extrapolated) = 35.7 W/kg  
**SAR(1 g) = 7.85 W/kg; SAR(10 g) = 2.25 W/kg**  
Maximum value of SAR (measured) = 18.9 W/kg

**Dipole Calibration /Pin=100mW, d=10mm, f=5800 MHz/Zoom Scan,**  
**dist=1.4mm (8x8x7)/Cube 0:** Measurement grid: dx=4mm, dy=4mm, dz=1.4mm  
Reference Value = 62.16 V/m; Power Drift = -0.04 dB  
Peak SAR (extrapolated) = 37.2 W/kg  
**SAR(1 g) = 7.78 W/kg; SAR(10 g) = 2.21 W/kg**  
Maximum value of SAR (measured) = 19.1 W/kg

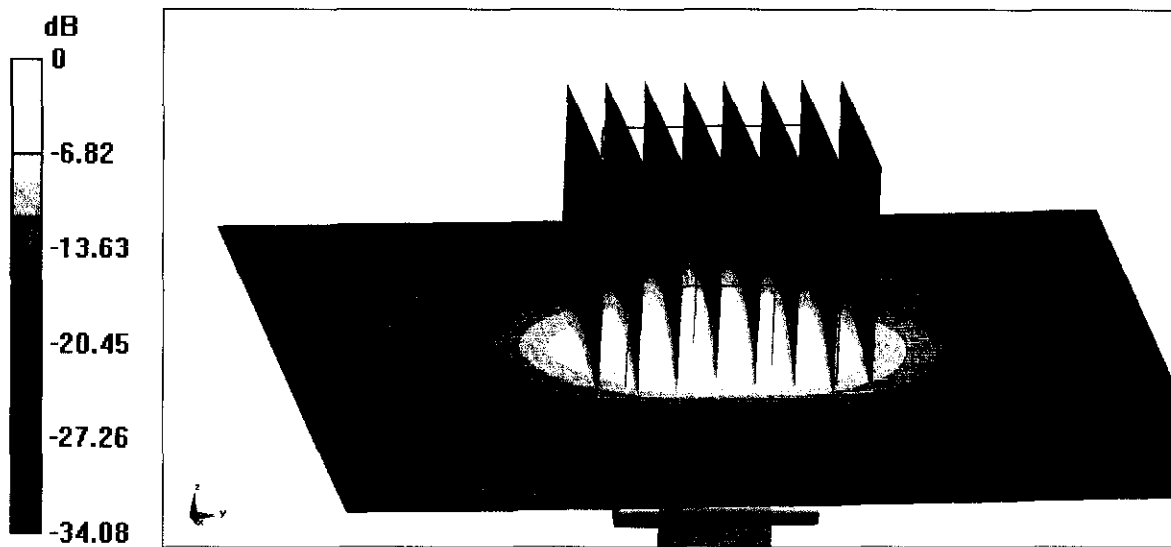

0 dB = 19.1 W/kg = 12.81 dBW/kg



Add: No.51 Xueyuan Road, Haidian District, Beijing, 100191, China  
Tel: +86-10-62304633-2512 Fax: +86-10-62304633-2504  
E-mail: cttl@chinattl.com http://www.chinattl.cn

### Impedance Measurement Plot for Head TSL

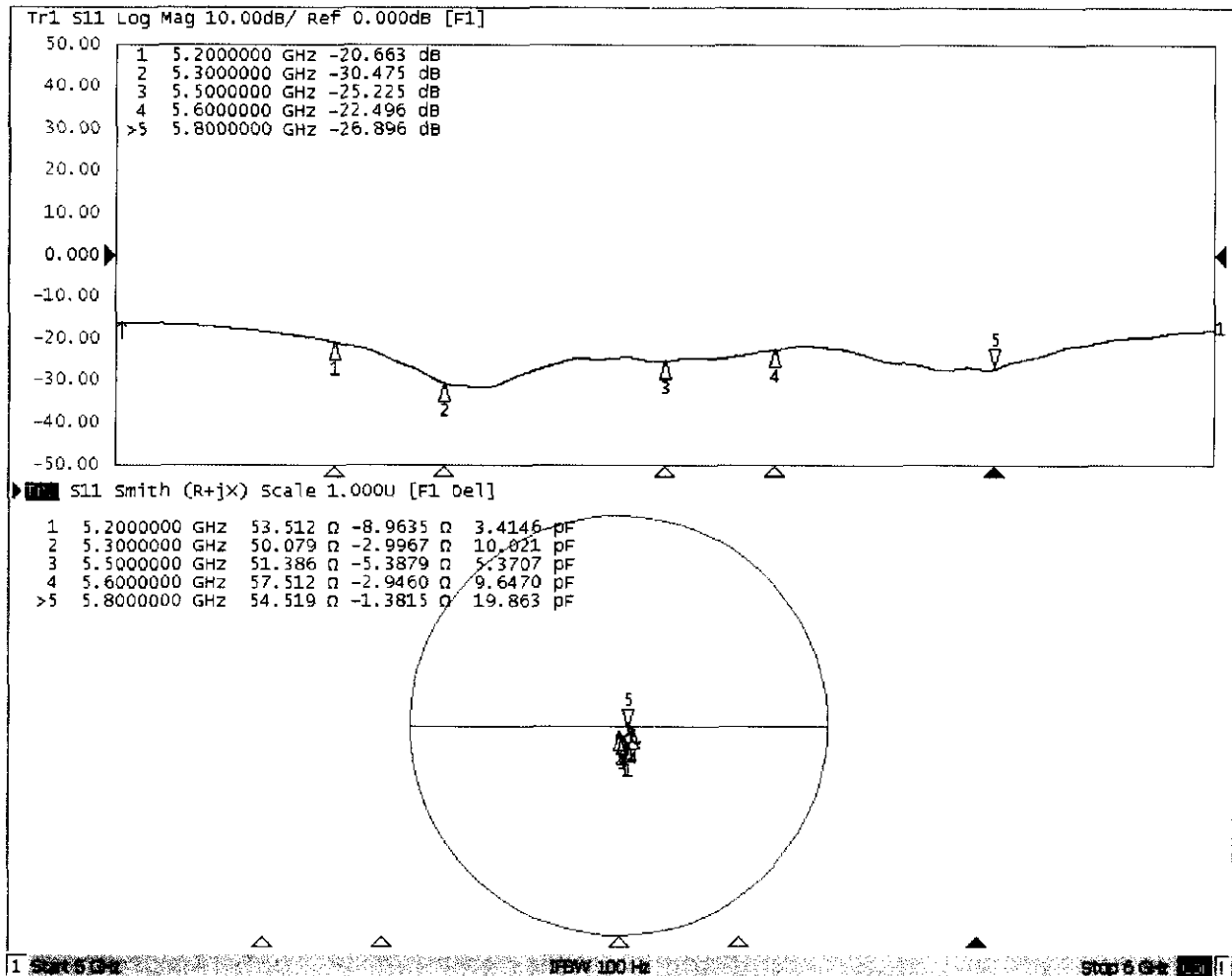



Add: No.51 Xueyuan Road, Haidian District, Beijing, 100191, China  
Tel: +86-10-62304633-2512 Fax: +86-10-62304633-2504  
E-mail: cttl@chinattl.com http://www.chinattl.cn

## DASY5 Validation Report for Body TSL

Date: 06.19.2018

Test Laboratory: CTTL, Beijing, China

**DUT: Dipole 5GHz; Type: D5GHzV2; Serial: D5GHzV2 - SN: 1160**

Communication System: CW; Frequency: 5200 MHz, Frequency: 5300 MHz,  
Frequency: 5500 MHz, Frequency: 5600 MHz, Frequency: 5800 MHz,

Medium parameters used:  $f = 5200$  MHz;  $\sigma = 5.317$  S/m;  $\epsilon_r = 48.78$ ;  $\rho = 1000$  kg/m<sup>3</sup>,  
Medium parameters used:  $f = 5300$  MHz;  $\sigma = 5.381$  S/m;  $\epsilon_r = 48.35$ ;  $\rho = 1000$  kg/m<sup>3</sup>,  
Medium parameters used:  $f = 5500$  MHz;  $\sigma = 5.56$  S/m;  $\epsilon_r = 48.36$ ;  $\rho = 1000$  kg/m<sup>3</sup>,  
Medium parameters used:  $f = 5600$  MHz;  $\sigma = 5.795$  S/m;  $\epsilon_r = 48.14$ ;  $\rho = 1000$  kg/m<sup>3</sup>,  
Medium parameters used:  $f = 5800$  MHz;  $\sigma = 6.065$  S/m;  $\epsilon_r = 48.03$ ;  $\rho = 1000$  kg/m<sup>3</sup>,

Phantom section: Left Section

### DASY5 Configuration:

- Probe: EX3DV4 - SN3846; ConvF(5.15, 5.15, 5.15) @ 5200 MHz; Calibrated: 1/25/2018, ConvF(5.04, 5.04, 5.04) @ 5300 MHz; Calibrated: 1/25/2018, ConvF(4.46, 4.46, 4.46) @ 5500 MHz; Calibrated: 1/25/2018, ConvF(4.36, 4.36, 4.36) @ 5600 MHz; Calibrated: 1/25/2018, ConvF(4.51, 4.51, 4.51) @ 5800 MHz; Calibrated: 1/25/2018,
- Sensor-Surface: 1.4mm (Mechanical Surface Detection)
- Electronics: DAE4 Sn1525; Calibrated: 10/2/2017
- Electronics: DAE4 Sn777; Calibrated: 12/15/2017
- Phantom: Triple Flat Phantom 5.1C; Type: QD 000 P51 CA; Serial: 1161/3
- Measurement SW: DASY52, Version 52.10 (1); SEMCAD X Version 14.6.11 (7439)

**Dipole Calibration /Pin=100mW, d=10mm, f=5200 MHz/Zoom Scan, dist=1.4mm (8x8x7)/Cube 0:** Measurement grid: dx=4mm, dy=4mm, dz=1.4mm

Reference Value = 62.32 V/m; Power Drift = 0.02 dB

Peak SAR (extrapolated) = 31.6 W/kg

**SAR(1 g) = 6.99 W/kg; SAR(10 g) = 1.92 W/kg**

Maximum value of SAR (measured) = 16.7 W/kg

**Dipole Calibration /Pin=100mW, d=10mm, f=5300 MHz/Zoom Scan,**

**dist=1.4mm (8x8x7)/Cube 0:** Measurement grid: dx=4mm, dy=4mm, dz=1.4mm

Reference Value = 56.59 V/m; Power Drift = -0.02 dB

Peak SAR (extrapolated) = 33.3 W/kg

**SAR(1 g) = 7.25 W/kg; SAR(10 g) = 2.04 W/kg**

Maximum value of SAR (measured) = 18.2 W/kg



In Collaboration with

**s p e a g**  
**CALIBRATION LABORATORY**

Add: No.51 Xueyuan Road, Haidian District, Beijing, 100191, China  
Tel: +86-10-62304633-2512 Fax: +86-10-62304633-2504  
E-mail: cttl@chinattl.com http://www.chinattl.cn

**Dipole Calibration /Pin=100mW, d=10mm, f=5500 MHz/Zoom Scan,**  
**dist=1.4mm (8x8x7)/Cube 0:** Measurement grid: dx=4mm, dy=4mm, dz=1.4mm  
Reference Value = 65.72 V/m; Power Drift = 0.00 dB  
Peak SAR (extrapolated) = 35.6 W/kg  
**SAR(1 g) = 7.63 W/kg; SAR(10 g) = 2.13 W/kg**  
Maximum value of SAR (measured) = 19.2 W/kg

**Dipole Calibration /Pin=100mW, d=10mm, f=5600 MHz/Zoom Scan,**  
**dist=1.4mm (8x8x7)/Cube 0:** Measurement grid: dx=4mm, dy=4mm, dz=1.4mm  
Reference Value = 57.49 V/m; Power Drift = -0.04 dB  
Peak SAR (extrapolated) = 37.4 W/kg  
**SAR(1 g) = 7.78 W/kg; SAR(10 g) = 2.14 W/kg**  
Maximum value of SAR (measured) = 19.3 W/kg

**Dipole Calibration /Pin=100mW, d=10mm, f=5800 MHz/Zoom Scan,**  
**dist=1.4mm (8x8x7)/Cube 0:** Measurement grid: dx=4mm, dy=4mm, dz=1.4mm  
Reference Value = 41.04 V/m; Power Drift = -0.04 dB  
Peak SAR (extrapolated) = 36.5 W/kg  
**SAR(1 g) = 7.66 W/kg; SAR(10 g) = 2.15 W/kg**  
Maximum value of SAR (measured) = 18.8 W/kg

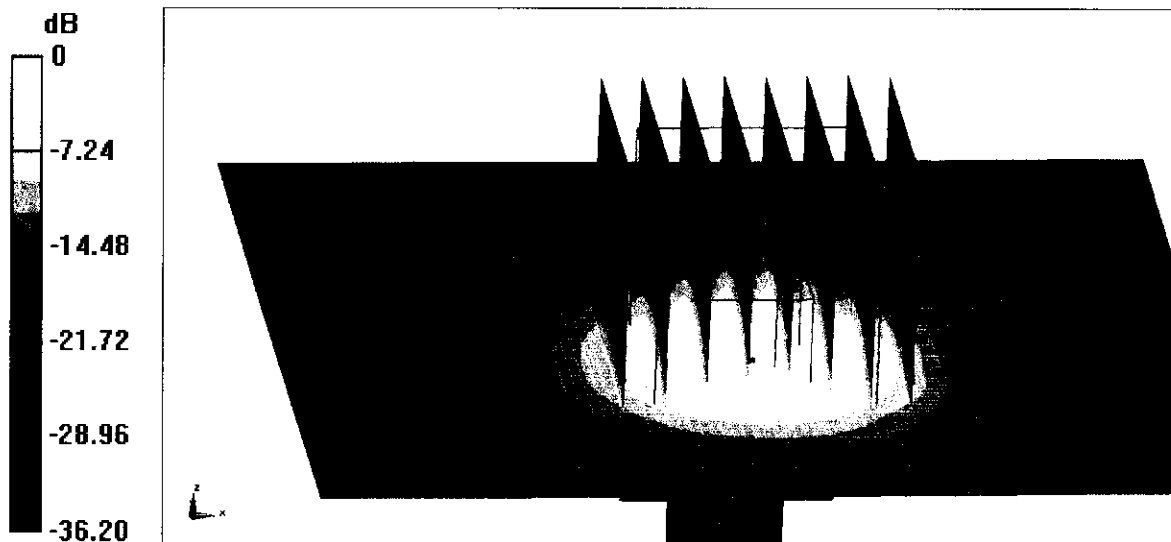

**0 dB = 18.8 W/kg = 12.74 dBW/kg**



Add: No.51 Xueyuan Road, Haidian District, Beijing, 100191, China  
Tel: +86-10-62304633-2512 Fax: +86-10-62304633-2504  
E-mail: cttl@chinattl.com http://www.chinattl.cn

### Impedance Measurement Plot for Body TSL

