

FCC Radio Test Report

FCC ID: QISAGS2-L03

This report concerns (check one): Original Grant Class I Change Class II Change

Project No. : 1808C216
Equipment : HUAWEI MediaPad T5
Test Model : AGS2-L03
Series Model : N/A
Applicant : Huawei Technologies Co., Ltd.
Address : Administration Building, Headquarters of Huawei Technologies Co., Ltd., Bantian, Longgang District, Shenzhen, 518129, P.R.C

Date of Receipt : Aug. 24, 2018
Date of Test : Aug. 27, 2018~Sep. 07, 2018
Issued Date : Sep. 12, 2018
Tested by : BTL Inc.

Testing Engineer : Paul Li
(Paul Li)

Technical Manager : David Mao
(David Mao)

Authorized Signatory : Steven Lu
(Steven Lu)

B T L I N C .

No.3, Jinshagang 1st Road, Shixia, Dalang Town, Dongguan, Guangdong, China.

TEL: +86-769-8318-3000 FAX: +86-769-8319-6000



Declaration

BTL represents to the client that testing is done in accordance with standard procedures as applicable and that test instruments used has been calibrated with standards traceable to international standard(s) and/or national standard(s).

BTL's reports apply only to the specific samples tested under conditions. It is manufacture's responsibility to ensure that additional production units of this model are manufactured with the identical electrical and mechanical components. **BTL** shall have no liability for any declarations, inferences or generalizations drawn by the client or others from **BTL** issued reports.

The report must not be used by the client to claim product certification, approval, or endorsement by NVLAP, NIST, or any agency of the U.S. Government.

This report is the confidential property of the client. As a mutual protection to the clients, the public and ourselves, the test report shall not be reproduced, except in full, without our written approval.

BTL's laboratory quality assurance procedures are in compliance with the **ISO Guide 17025** requirements, and accredited by the conformity assessment authorities listed in this test report.

BTL is not responsible for the sampling stage, so the results only apply to the sample as received.

The information, data and test plan are provided by manufacturer, so it is manufacturer's responsibility to ensure that the apparatus meets the essential requirements in all the possible configurations as representative of its intended use.

Limitation

For the use of the authority's logo is limited unless the Test Standard(s)/Scope(s)/Item(s) mentioned in this test report is (are) included in the conformity assessment authorities acceptance respective.

Table of Contents	Page
1 . CERTIFICATION	6
2 . SUMMARY OF TEST RESULTS	7
2.1 TEST FACILITY	8
2.2 MEASUREMENT UNCERTAINTY	8
3 . GENERAL INFORMATION	9
3.1 GENERAL DESCRIPTION OF EUT	9
3.2 DESCRIPTION OF TEST MODES	11
3.3 TABLE OF PARAMETERS OF TEXT SOFTWARE SETTING	13
3.4 BLOCK DIAGRAM SHOWING THE CONFIGURATION OF SYSTEM TESTED	14
3.5 DESCRIPTION OF SUPPORT UNITS	14
4 . EMC EMISSION TEST	15
4.1 CONDUCTED EMISSION MEASUREMENT	15
4.1.1 POWER LINE CONDUCTED EMISSION LIMITS	15
4.1.2 TEST PROCEDURE	15
4.1.3 DEVIATION FROM TEST STANDARD	15
4.1.4 TEST SETUP	16
4.1.5 EUT OPERATING CONDITIONS	16
4.1.6 EUT TEST CONDITIONS	16
4.1.7 TEST RESULTS	16
4.2 RADIATED EMISSION MEASUREMENT	17
4.2.1 RADIATED EMISSION LIMITS	17
4.2.2 TEST PROCEDURE	18
4.2.3 DEVIATION FROM TEST STANDARD	18
4.2.4 TEST SETUP	19
4.2.5 EUT OPERATING CONDITIONS	21
4.2.6 EUT TEST CONDITIONS	21
4.2.7 TEST RESULTS (9 KHZ TO 30 MHZ)	21
4.2.8 TEST RESULTS (30 MHZ TO 1000 MHZ)	21
4.2.9 TEST RESULTS (ABOVE 1000 MHZ)	21
5 . BANDWIDTH TEST	22
5.1 APPLIED PROCEDURES	22
5.1.1 TEST PROCEDURE	22
5.1.2 DEVIATION FROM STANDARD	22
5.1.3 TEST SETUP	22
5.1.4 EUT OPERATION CONDITIONS	22
5.1.5 EUT TEST CONDITIONS	22
5.1.6 TEST RESULTS	22
6 . MAXIMUM OUTPUT POWER TEST	23

Table of Contents	Page
6.1 APPLIED PROCEDURES / LIMIT	23
6.1.1 TEST PROCEDURE	23
6.1.2 DEVIATION FROM STANDARD	23
6.1.3 TEST SETUP	23
6.1.4 EUT OPERATION CONDITIONS	23
6.1.5 EUT TEST CONDITIONS	23
6.1.6 TEST RESULTS	23
7 . ANTENNA CONDUCTED SPURIOUS EMISSION	24
7.1 APPLIED PROCEDURES / LIMIT	24
7.1.1 TEST PROCEDURE	24
7.1.2 DEVIATION FROM STANDARD	24
7.1.3 TEST SETUP	24
7.1.4 EUT OPERATION CONDITIONS	24
7.1.5 EUT TEST CONDITIONS	24
7.1.6 TEST RESULTS	24
8 . POWER SPECTRAL DENSITY TEST	25
8.1 APPLIED PROCEDURES / LIMIT	25
8.1.1 TEST PROCEDURE	25
8.1.2 DEVIATION FROM STANDARD	25
8.1.3 TEST SETUP	25
8.1.4 EUT OPERATION CONDITIONS	25
8.1.5 EUT TEST CONDITIONS	25
8.1.6 TEST RESULTS	25
9 . MEASUREMENT INSTRUMENTS LIST	26
APPENDIX A - CONDUCTED EMISSION	28
APPENDIX B - RADIATED EMISSION (9 KHZ TO 30 MHZ)	35
APPENDIX C - RADIATED EMISSION (30 MHZ TO 1000 MHZ)	48
APPENDIX D - RADIATED EMISSION (ABOVE 1000 MHZ)	55
APPENDIX E - BANDWIDTH	96
APPENDIX F - MAXIMUM OUTPUT POWER	105
APPENDIX G - ANTENNA CONDUCTED SPURIOUS EMISSION	107
APPENDIX H - POWER SPECTRAL DENSITY	132

REPORT ISSUED HISTORY

Issued No.	Description	Issued Date
BTL-FCCP-3-1808C216	Original Issue.	Sep. 12, 2018

1. CERTIFICATION

Equipment : HUAWEI MediaPad T5
Brand Name : HUAWEI
Test Model : AGS2-L03
Series Model : N/A
Applicant : Huawei Technologies Co., Ltd.
Manufacturer : Huawei Technologies Co., Ltd.
Address : Administration Building, Headquarters of Huawei Technologies Co., Ltd.,
Bantian, Longgang District, Shenzhen, 518129, P.R.C
Factory : Huawei Technologies Co., Ltd.
Address : Building, Headquarters of Huawei Technologies Co., Ltd., Bantian, Longgang
District, Shenzhen, 518129, P.R.C
Date of Test : Aug. 27, 2018~Sep. 07, 2018
Test Sample : Engineering Sample No.: D180807232 for conducted, D180807229 for
radiated.
Standard(s) : FCC Part15, Subpart C (15.247) / ANSI C63.10-2013

The above equipment has been tested and found compliance with the requirement of the relative standards by BTL Inc.

The test data, data evaluation, and equipment configuration contained in our test report (Ref No. BTL-FCCP-3-1808C216) were obtained utilizing the test procedures, test instruments, test sites that has been accredited by the Authority of NVLAP according to the ISO-17025 quality assessment standard and technical standard(s).

Test results included in this report is only for the WLAN 2.4G part.

2. SUMMARY OF TEST RESULTS

Test procedures according to the technical standard(s):

Applied Standard(s): FCC Part15 (15.247) , Subpart C			
Standard(s) Section	Test Item	Judgment	Remark
15.207	Conducted Emission	PASS	
15.247(d)	Antenna conducted Spurious Emission	PASS	
15.247(a)(2)	6 dB Bandwidth	PASS	
15.247(b)(3)	Maximum output power	PASS	
15.247(e)	Power Spectral Density	PASS	
15.203	Antenna Requirement	PASS	
15.247(d)/ 15.205/ 15.209	Transmitter Radiated Emissions	PASS	

Note:

- (1) "N/A" denotes test is not applicable in this test report.

2.1 TEST FACILITY

The test facilities used to collect the test data in this report is at the location of No.3,Jinshagang 1st Road, Shixia, Dalang Town, Dongguan, Guangdong, China.

BTL's test firm number for FCC: 854385

BTL's designation number for FCC: CN5020

2.2 MEASUREMENT UNCERTAINTY

The measurement uncertainty figures shall be calculated according the methods described in the ETSI TR 100 028 and shall correspond to an expansion factor (coverage factor) $k=1.96$ or $k=2$ (which provide confidence levels of respectively 90% and 95.45% in the case where the distributions characterizing the actual measurement uncertainties are normal (Gaussian)). Measurement Uncertainty for a Level of Confidence of 95 %, $U=2xUc(y)$.

The BTL measurement uncertainty as below table:

A. Conducted Measurement:

Test Site	Method	Measurement Frequency Range	U, (dB)
DG-C02	CISPR	150 kHz ~ 30 MHz	2.32

B. Radiated Measurement:

Test Site	Method	Measurement Frequency Range	Ant. H / V	U, (dB)
DG-CB03	CISPR	9 KHz~30 MHz	V	3.79
		9 KHz~30 MHz	H	3.57
		30 MHz~200 MHz	V	3.82
		30 MH~200 MHz	H	3.78
		200 MHz~1,000 MHz	V	4.10
		200 MHz~1,000 MHz	H	4.06
		1 GHz~18 GHz	V	3.12
		1 GHz~18 GHz	H	3.68
		18 GHz~40 GHz	V	4.15
18 GHz~40 GHz	H	4.14		

Note: Unless specifically mentioned, the uncertainty of measurement has not been taken into account to declare the compliance or non-compliance to the specification.

3. GENERAL INFORMATION

3.1 GENERAL DESCRIPTION OF EUT

Equipment	HUAWEI MediaPad T5	
Brand Name	HUAWEI	
Test Model	AGS2-L03	
Series Model	N/A	
Model Difference(s)	N/A	
Software Version	A6t6e	
Hardware Version	AGS2-L03 8.0.0.20(C605)	
Product Description	Operation Frequency	2412 MHz ~2462 MHz
	Modulation Technology	802.11b:DSSS 802.11g:OFDM 802.11n:OFDM
	Bit Rate of Transmitter	802.11b: 11/5.5/2/1 Mbps 802.11g: 54/48/36/24/18/12/9/6 Mbps 802.11n up to 150 Mbps
	Output Power (Max.)	802.11b: 20.58 dBm 802.11g: 20.37 dBm 802.11n(20 MHz): 20.78 dBm 802.11n(40 MHz): 20.57 dBm
Power Source	1# DC voltage supplied from AC/DC adapter. Model: HW-050100U01 2# Supplied from battery. Model: HB2899C0ECW-C	
Power Rating	1# I/P: 100-240V~,50/60Hz,0.2A O/P: DC 5V, 1A 2# DC 3.82V, 4980mAh	

Note:

- For a more detailed features description, please refer to the manufacturer's specifications or the user's manual.
- Channel List:

CH01 - CH11 for 802.11b, 802.11g, 802.11n(20 MHz)							
CH03 - CH09 for 802.11n(40 MHz)							
Channel	Frequency (MHz)	Channel	Frequency (MHz)	Channel	Frequency (MHz)	Channel	Frequency (MHz)
01	2412	04	2427	07	2442	10	2457
02	2417	05	2432	08	2447	11	2462
03	2422	06	2437	09	2452		

3. Table for Filed Antenna

Ant.	Brand	Model Name	Antenna Type	Connector	Gain (dBi)
1	HUAWEI	N/A	Internal	N/A	0.1

4 The EUT contains following accessory devices.

Item	Manufacturer	Factory	Description
Adapter	Huawei Technologies Co., Ltd.	HUIZHOU BYD ELECTRONIC CO., LTD.	PDM Number: 02220780 Model Name: HW-050100U01 Input Voltage : 100-240V ~50/60Hz, 0.2A Output Voltage: DC 5V,1A (The EU and US adapter are the same PCB board of same factory)
		Shenzhen Huntkey Electric Co., Ltd.	
		DONG GUAN PHITEK ELECTRONICS CO., LTD.	
Battery	Huawei Technologies Co.,Ltd.	SCUD (FUJIAN) Electronics Co., Ltd	PDM Number: 24022744 Model Name: HB2899C0ECW-C Rated Voltage: DC 3.82V Rated Capacity: 4980mAh
USB Cable	Huawei Technologies Co.,Ltd.	FOXCONN INTERCONNECT TECHNOLOGY LIMITED	Model Name: 04071002
		HONGLIN TECHNOLOGY CO.,LTD	
		Luxshare Precision Industry Co., Ltd.	

3.2 DESCRIPTION OF TEST MODES

To investigate the maximum EMI emission characteristics generated from EUT, the test system was pre-scanning tested based on the consideration of following EUT operation mode or test configuration mode which possibly have effect on EMI emission level. Each of these EUT operation mode(s) or test configuration mode(s) mentioned above was evaluated respectively.

Pretest Mode	Description
Mode 1	TX B Mode Channel 01/06/11
Mode 2	TX G Mode Channel 01/06/11
Mode 3	TX N-20 MHz Mode Channel 01/06/11
Mode 4	TX N-40 MHz Mode Channel 03/06/09
Mode 5	TX Mode

The EUT system operated these modes were found to be the worst case during the pre-scanning test as following:

For Conducted Test	
Final Test Mode:	Description
Mode 5	TX Mode

For Radiated Test	
Final Test Mode:	Description
Mode 1	TX B Mode Channel 01/06/11
Mode 2	TX G Mode Channel 01/06/11
Mode 3	TX N-20 MHz Mode Channel 01/06/11
Mode 4	TX N-40 MHz Mode Channel 03/06/09

For Band Edge Test	
Final Test Mode:	Description
Mode 1	TX B Mode Channel 01/06/11
Mode 2	TX G Mode Channel 01/06/11
Mode 3	TX N-20 MHz Mode Channel 01/06/11
Mode 4	TX N-40 MHz Mode Channel 03/06/09

6 dB Spectrum Bandwidth	
Final Test Mode:	Description
Mode 1	TX B Mode Channel 01/06/11
Mode 2	TX G Mode Channel 01/06/11
Mode 3	TX N-20 MHz Mode Channel 01/06/11
Mode 4	TX N-40 MHz Mode Channel 03/06/09

Maximum Output Power	
Final Test Mode:	Description
Mode 1	TX B Mode Channel 01/06/11
Mode 2	TX G Mode Channel 01/06/11
Mode 3	TX N-20 MHz Mode Channel 01/06/11
Mode 4	TX N-40 MHz Mode Channel 03/06/09

Power Spectral Density	
Final Test Mode:	Description
Mode 1	TX B Mode Channel 01/06/11
Mode 2	TX G Mode Channel 01/06/11
Mode 3	TX N-20 MHz Mode Channel 01/06/11
Mode 4	TX N-40 MHz Mode Channel 03/06/09

Note:

- (1) Radiated Emissions of middle channel is performed and Band edge of high and low channels are performed.
- (2) 802.11b mode: DSSS (1 Mbps)
802.11g mode: OFDM (6 Mbps)
802.11n HT20 mode : OFDM (6.5 Mbps)
802.11n HT40 mode : OFDM (13.5 Mbps)
- (3) For radiated 30 MHz to 1000 MHz test, the 802.11b is found to be the worst case and recorded.

3.3 TABLE OF PARAMETERS OF TEXT SOFTWARE SETTING

During testing, channel & power controlling software provided by the customer was used to control the operating channel as well as the output power level. The RF output power selection is for the setting of RF output power expected by the customer and is going to be fixed on the firmware of the final end product power parameters of WLAN

Test software version	WiFiRFAuth.apk		
Frequency (MHz)	2412	2437	2462
802.11b	16	16	16
802.11g	9	9	9
802.11n (20 MHz)	9	9	9
Frequency (MHz)	2422	2437	2452
802.11n (40 MHz)	8	8	8

3.4 BLOCK DIAGRAM SHOWING THE CONFIGURATION OF SYSTEM TESTED

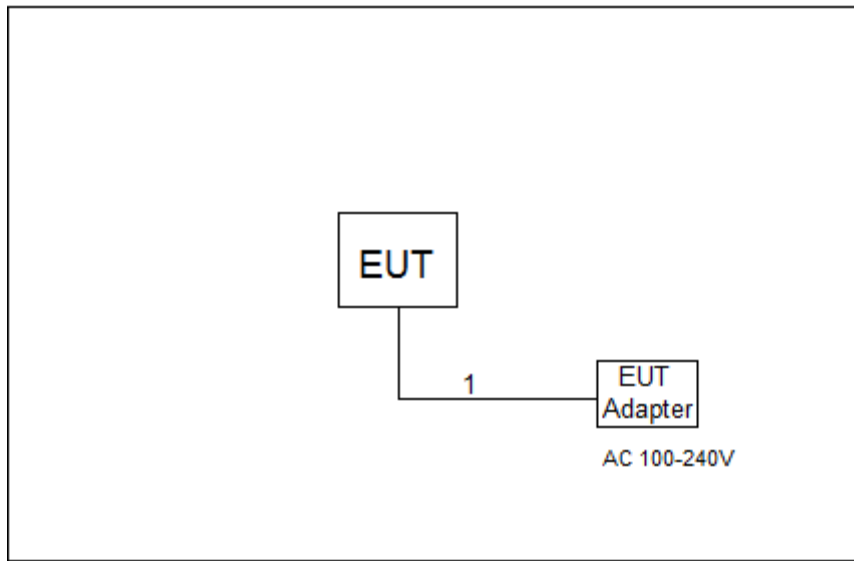

3.5 DESCRIPTION OF SUPPORT UNITS

The EUT has been tested as an independent unit together with other necessary accessories or support units. The following support units or accessories were used to form a representative test configuration during the tests.

Item	Equipment	Mfr/Brand	Model/Type No.	FCC ID	Series No.
-	-	-	-	-	-

Item	Shielded Type	Ferrite Core	Length	Note
1	NO	NO	1.2m	DC Cable

4. EMC EMISSION TEST

4.1 CONDUCTED EMISSION MEASUREMENT

4.1.1 POWER LINE CONDUCTED EMISSION LIMITS (Frequency Range 150 kHz-30 MHz)

Frequency of Emission (MHz)	Conducted Limit (dB μ V)	
	Quasi-peak	Average
0.15 - 0.50	66 to 56*	56 to 46*
0.50 - 5.0	56	46
5.0 - 30.0	60	50

Note:

- (1) The limit of " * " decreases with the logarithm of the frequency
- (2) The test result calculated as following:
 Measurement Value = Reading Level + Correct Factor
 Correct Factor = Insertion Loss + Cable Loss + Attenuator Factor(if use)
 Margin Level = Measurement Value - Limit Value

The following table is the setting of the receiver

Receiver Parameters	Setting
Attenuation	10 dB
Start Frequency	0.15 MHz
Stop Frequency	30 MHz
IF Bandwidth	9 kHz

4.1.2 TEST PROCEDURE

- a. The EUT was placed 0.8 meters from the horizontal ground plane with EUT being connected to the power mains through a line impedance stabilization network (LISN). All other support equipment powered from additional LISN(s). The LISN provide 50 Ohm/ 50uH of coupling impedance for the measuring instrument.
- b. Interconnecting cables that hang closer than 40 cm to the ground plane shall be folded back and forth in the center forming a bundle 30 to 40 cm long.
- c. I/O cables that are not connected to a peripheral shall be bundled in the center. The end of the cable may be terminated, if required, using the correct terminating impedance. The overall length shall not exceed 1 m.
- d. LISN at least 80 cm from nearest part of EUT chassis.
- e. For the actual test configuration, please refer to the related Item -EUT Test Photos.

4.1.3 DEVIATION FROM TEST STANDARD

No deviation

4.1.4 TEST SETUP

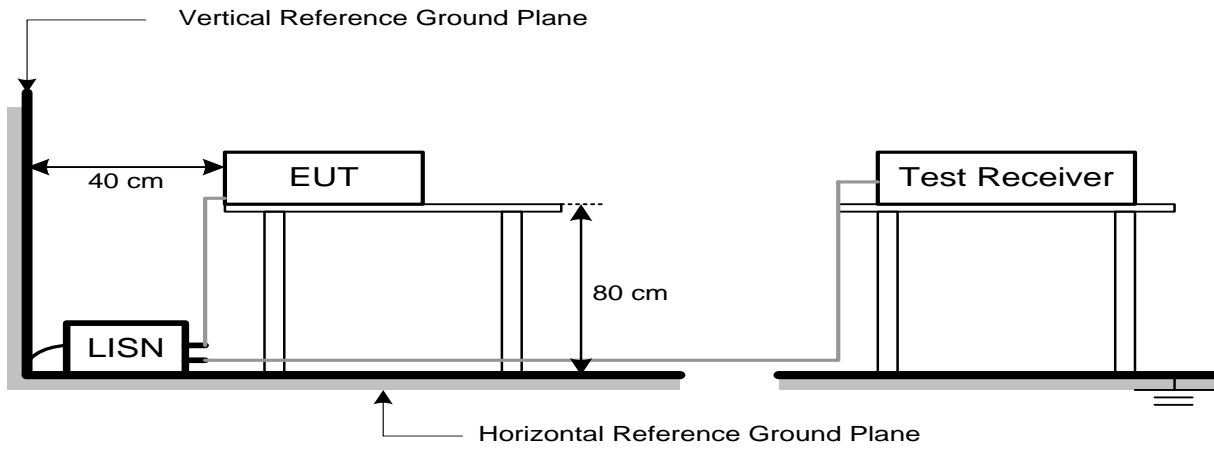

4.1.5 EUT OPERATING CONDITIONS

The EUT was placed on the test table and programmed in normal function.

4.1.6 EUT TEST CONDITIONS

Temperature: 25°C Relative Humidity: 55% Test Voltage: AC 120V/60Hz

4.1.7 TEST RESULTS

Please refer to the Appendix A.

4.2 RADIATED EMISSION MEASUREMENT

4.2.1 RADIATED EMISSION LIMITS

In case the emission fall within the restricted band specified on 15.205(a), then the 15.209(a) limit in the table below has to be followed.

LIMITS OF RADIATED EMISSION MEASUREMENT (9 kHz-1000 MHz)

Frequency (MHz)	Field Strength (microvolts/meter)	Measurement Distance (meters)
0.009~0.490	2400/F(kHz)	300
0.490~1.705	24000/F(kHz)	30
1.705~30.0	30	30
30~88	100	3
88~216	150	3
216~960	200	3
960~1000	500	3

LIMITS OF RADIATED EMISSION MEASUREMENT (Above 1000 MHz)

Frequency (MHz)	Band edge at 3m (dB μ V/m)		Harmonic at 1.5m (dB μ V/m)	
	Peak	Average	Peak	Average
Above 1000	74	54	80 (Note 5)	60(Note 5)

Note:

- (1) The limit for radiated test was performed according to FCC PART 15C.
- (2) The tighter limit applies at the band edges.
- (3) Emission level (dBuV/m)=20log Emission level (uV/m).
- (4) The test result calculated as following:
 Measurement Value = Reading Level + Correct Factor
 Correct Factor = Antenna Factor + Cable Loss - Amplifier Gain(if use)
 Margin Level = Measurement Value - Limit Value

(5)

$$FS_{\text{limit}} = FS_{\text{max}} - 20 \log \left(\frac{d_{\text{limit}}}{d_{\text{measure}}} \right)$$

$$20 \log d_{\text{limit}}/d_{\text{measure}} = 20 \log 3/1.5 = 6 \text{ dB.}$$

Spectrum Parameter	Setting
Attenuation	Auto
Start Frequency	1000 MHz
Stop Frequency	10th carrier harmonic
RBW / VBW (Emission in restricted band)	1 MHz / 3 MHz for Peak, 1 MHz / 1/T for Average

Receiver Parameter	Setting
Attenuation	Auto
Start ~ Stop Frequency	9 kHz~90 kHz for PK/AVG detector
Start ~ Stop Frequency	90 kHz~110 kHz for QP detector
Start ~ Stop Frequency	110 kHz~490 kHz for PK/AVG detector
Start ~ Stop Frequency	490 kHz~30 MHz for QP detector
Start ~ Stop Frequency	30 MHz~1000 MHz for QP detector

4.2.2 TEST PROCEDURE

- a. The measuring distance of 3 m shall be used for measurements. The EUT was placed on the top of a rotating table 0.8 meter above the ground at a 3 meter semi-anechoic chamber. The table was rotated 360 degrees to determine the position of the highest radiation.(below 1 GHz)
- b. The measuring distance of 3 m or 1.5m shall be used for measurements. The EUT was placed on the top of a rotating table 1.5 meter above the ground at a 3 meter semi-anechoic chamber. The table was rotated 360 degrees to determine the position of the highest radiation.(above 1GHz)
- c. The height of the equipment or of the substitution antenna shall be 0.8m or 1.5m; the height of the test antenna shall vary between 1 m to 4 m. Both horizontal and vertical polarizations of the antenna are set to make the measurement.
- d. For each suspected emission, the EUT was arranged to its worst case and then the antenna was tuned to heights find the maximum reading (used Bore sight function).
- e. The receiver system was set to peak and average detect function and specified bandwidth with maximum hold mode when the test frequency is above 1 GHz.
- f. The initial step in collecting radiated emission data is a receiver peak detector mode pre-scanning the measurement frequency range. Significant peaks are then marked and then Quasi Peak detector mode re-measured.
- g. All readings are Peak unless otherwise stated QP in column of Note. Peak denotes that the Peak reading compliance with the QP Limits and then QP Mode measurement didn't perform. (below 1 GHz)
- h. All readings are Peak Mode value unless otherwise stated AVG in column of Note. If the Peak Mode Measured value compliance with the Peak Limits and lower than AVG Limits, the EUT shall be deemed to meet both Peak & AVG Limits and then only Peak Mode was measured, but AVG Mode didn't perform. (above 1 GHz)
- i. For the actual test configuration, please refer to the related Item -EUT Test Photos.

4.2.3 DEVIATION FROM TEST STANDARD

No deviation

4.2.4 TEST SETUP

(A) Radiated Emission Test Set-Up Frequency 30 MHz-1000 MHz

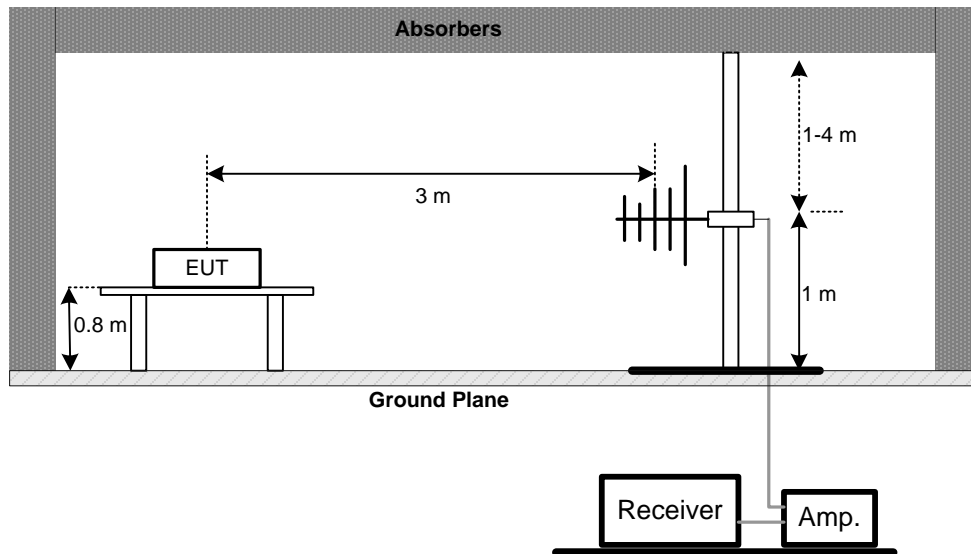

(B) Radiated Emission Test Set-Up Frequency Above 1 GHz
Band edge

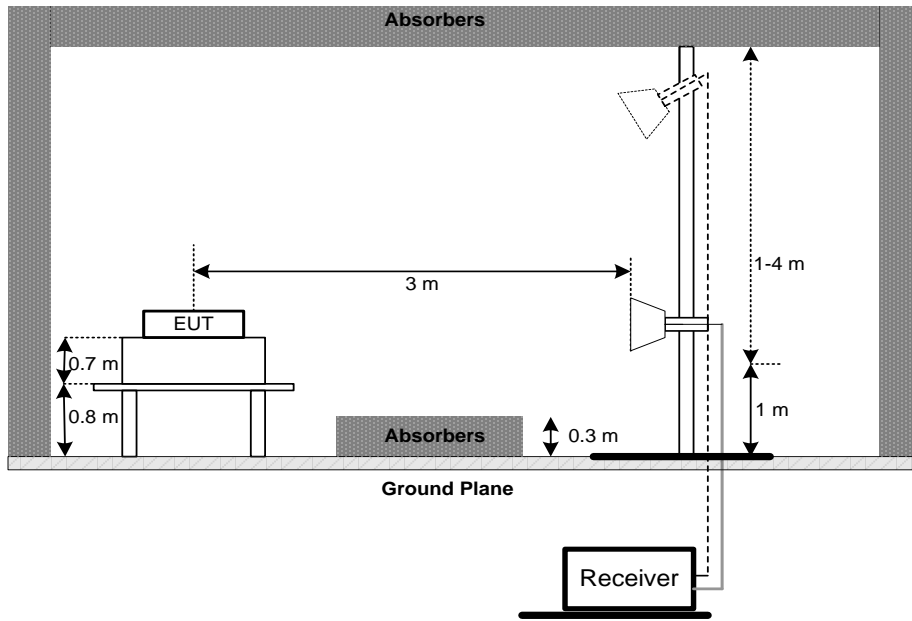

Harmonic

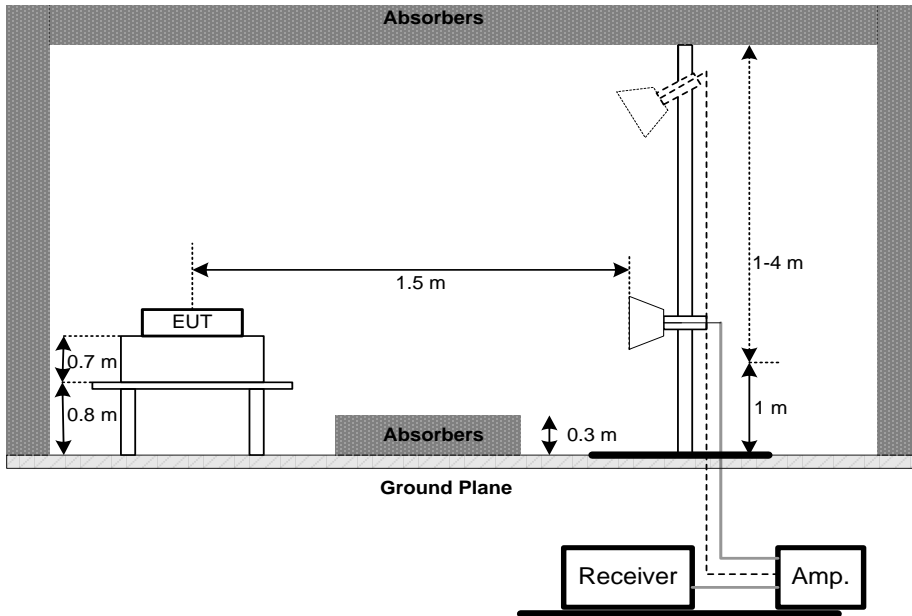

(C) For Radiated Emissions 9 kHz-30 MHz

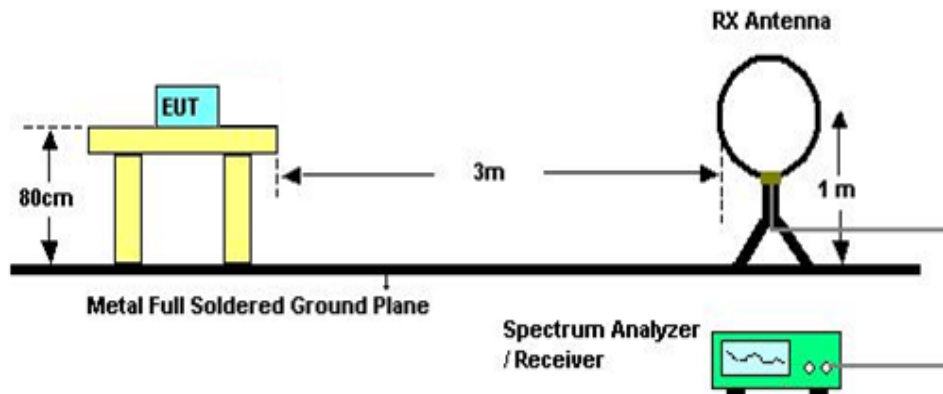

4.2.5 EUT OPERATING CONDITIONS

The EUT was programmed to be in continuously transmitting mode.

4.2.6 EUT TEST CONDITIONS

Temperature: 25°C Relative Humidity: 55% Test Voltage: AC 120V/60Hz

4.2.7 TEST RESULTS (9 kHz TO 30 MHz)

Please refer to the Appendix B

Remark:

- (1) The amplitude of spurious emissions which are attenuated by more than 20 dB below the permissible value has no need to be reported.
- (2) Distance extrapolation factor = $40 \log (\text{specific distance} / \text{test distance})$ (dB).
- (3) Limit line = specific limits (dBuV) + distance extrapolation factor.

4.2.8 TEST RESULTS (30 MHz TO 1000 MHz)

Please refer to the Appendix C.

4.2.9 TEST RESULTS (ABOVE 1000 MHz)

Please refer to the Appendix D.

Remark:

- (1) No limit: This is fundamental signal, the judgment is not applicable.
For fundamental signal judgment was referred to Peak output test.

5. BANDWIDTH TEST

5.1 APPLIED PROCEDURES

FCC Part15 (15.247) , Subpart C			
Section	Test Item	Frequency Range (MHz)	Result
15.247(a)(2)	Bandwidth	2400-2483.5	PASS

5.1.1 TEST PROCEDURE

- a. The EUT was directly connected to the spectrum analyzer and antenna output port as show in the block diagram below.
- b. Spectrum Setting: RBW= 100 kHz, VBW=300 kHz, Sweep time = 2.5 ms.

5.1.2 DEVIATION FROM STANDARD

No deviation.

5.1.3 TEST SETUP



5.1.4 EUT OPERATION CONDITIONS

The EUT was programmed to be in continuously transmitting mode.

5.1.5 EUT TEST CONDITIONS

Temperature: 25°C Relative Humidity: 55% Test Voltage: AC 120V/60Hz

5.1.6 TEST RESULTS

Please refer to the Appendix E.

6. MAXIMUM OUTPUT POWER TEST

6.1 APPLIED PROCEDURES / LIMIT

FCC Part15 (15.247) , Subpart C				
Section	Test Item	Limit	Frequency Range (MHz)	Result
15.247(b)(3)	Maximum Output Power	1 Watt or 30 dBm	2400-2483.5	PASS

6.1.1 TEST PROCEDURE

- a. The EUT was directly connected to the power meter and antenna output port as show in the block diagram below.
- b. The maximum peak conducted output power was performed in accordance with method 9.1.2 of FCC KDB 558074 D01 v04 DTS Meas Guidance.

6.1.2 DEVIATION FROM STANDARD

No deviation.

6.1.3 TEST SETUP

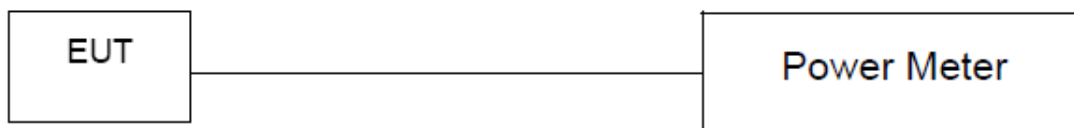

6.1.4 EUT OPERATION CONDITIONS

The EUT was programmed to be in continuously transmitting mode.

6.1.5 EUT TEST CONDITIONS

Temperature: 25°C Relative Humidity: 55% Test Voltage: AC 120V/60Hz

6.1.6 TEST RESULTS

Please refer to the Appendix F.

7. ANTENNA CONDUCTED SPURIOUS EMISSION

7.1 APPLIED PROCEDURES / LIMIT

In any 100 kHz bandwidth outside the frequency band in which the spread spectrum or digitally modulated intentional radiator is operating, the radio frequency power that is produced by the intentional radiator shall be at least 20 dB below that in the 100 kHz bandwidth within the band that contains the highest level of the desired power, based on either an RF conducted or a radiated measurement, provided the transmitter demonstrates compliance with the peak Output Power limits. If the transmitter complies with the Output Power limits based on the use of RMS averaging over a time interval, as permitted under paragraph (b)(3) of this section, the attenuation required under this paragraph shall be 30 dB instead of 20 dB. Attenuation below the general limits specified in Section 15.209(a) is not required. In addition, radiated emissions which fall in the restricted bands, as defined in Section 15.205(a), must also comply with the radiated emission limits specified in Section 15.209(a) (see Section 15.205(c)).

7.1.1 TEST PROCEDURE

- a. The EUT was directly connected to the spectrum analyzer and antenna output port as show in the block diagram below.
- b. Spectrum Setting: RBW= 100 kHz, VBW=300 kHz, Sweep time = Auto.
- c. Offset=antenna gain+cable loss

7.1.2 DEVIATION FROM STANDARD

No deviation.

7.1.3 TEST SETUP

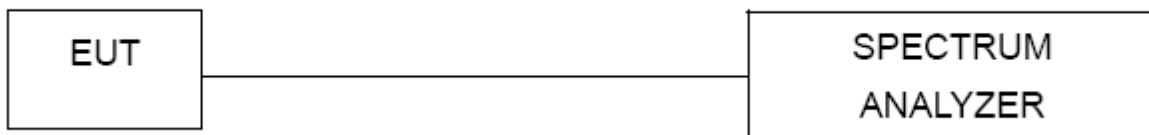

7.1.4 EUT OPERATION CONDITIONS

The EUT was programmed to be in continuously transmitting mode.

7.1.5 EUT TEST CONDITIONS

Temperature: 25°C Relative Humidity: 55% Test Voltage: AC 120V/60Hz

7.1.6 TEST RESULTS

Please refer to the Appendix G.

8. POWER SPECTRAL DENSITY TEST

8.1 APPLIED PROCEDURES / LIMIT

FCC Part15 (15.247) , Subpart C				
Section	Test Item	Limit	Frequency Range (MHz)	Result
15.247(e)	Power Spectral Density	8 dBm (in any 3 kHz)	2400-2483.5	PASS

8.1.1 TEST PROCEDURE

- a. The EUT was directly connected to the spectrum analyzer and antenna output port as show in the block diagram below.
- b. Spectrum Setting: RBW=3 kHz, VBW=10 kHz, Sweep time = Auto.

8.1.2 DEVIATION FROM STANDARD

No deviation.

8.1.3 TEST SETUP

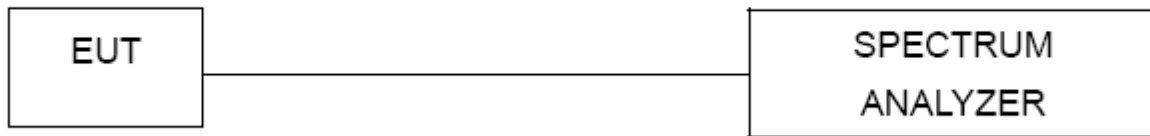

8.1.4 EUT OPERATION CONDITIONS

The EUT was programmed to be in continuously transmitting mode.

8.1.5 EUT TEST CONDITIONS

Temperature: 25°C Relative Humidity: 55% Test Voltage: AC 120V/60Hz

8.1.6 TEST RESULTS

Please refer to the Appendix H.

9. MEASUREMENT INSTRUMENTS LIST

Conducted Emission Measurement					
Item	Kind of Equipment	Manufacturer	Type No.	Serial No.	Calibrated until
1	EMI Test Receiver	R&S	ESCI	100382	Mar. 11, 2019
2	LISN	EMCO	3816/2	52765	Mar. 11, 2019
3	50Ω Terminator	SHX	TF2-3G-A	8122901	Mar. 11, 2019
4	TWO-LINE V-NETWORK	R&S	ENV216	101447	Mar. 11, 2019
5	Measurement Software	Farad	EZ-EMC Ver.NB-03A1-01	N/A	N/A
6	Cable	N/A	RG223	12m	Mar. 23, 2019

Radiated Emission Measurement - 9kHz TO 30 MHz					
Item	Kind of Equipment	Manufacturer	Type No.	Serial No.	Calibrated until
1	Loop Antenna	EM	EM-6876-1	230	Feb. 07, 2019
2	Cable	N/A	RG 213/U	C-102	Jun. 01, 2019
3	EMI Test Receiver	R&S	ESCI	100382	Mar. 11, 2019
4	Measurement Software	Farad	EZ-EMC Ver.NB-03A1-01	N/A	N/A

Radiated Emission Measurement – 30 MHz TO 1000 MHz					
Item	Kind of Equipment	Manufacturer	Type No.	Serial No.	Calibrated until
1	Antenna	Schwarbeck	VULB9160	9160-3232	Mar. 11, 2019
2	Amplifier	HP	8447D	2944A09673	Aug. 11, 2019
3	Receiver	Agilent	N9038A	MY52130039	Aug. 11, 2019
4	Cable	emci	LMR-400(30MHz-1 GHz)(8m+5m)	N/A	May 25, 2019
5	Controller	CT	SC100	N/A	N/A
6	Controller	MF	MF-7802	MF780208416	N/A
7	Measurement Software	Farad	EZ-EMC Ver.NB-03A1-01	N/A	N/A

Radiated Emission Measurement - Above 1GHz

Item	Kind of Equipment	Manufacturer	Type No.	Serial No.	Calibrated until
1	Double Ridged Guide Antenna	ETS	3115	75789	Mar. 11, 2019
2	Broad-Band Horn Antenna	Schwarzbeck	BBHA 9170	9170319	Jun. 30, 2019
3	Amplifier	Agilent	8449B	3008A02274	Mar. 11, 2019
4	Microwave Preamplifier With Adaptor	EMC INSTRUMENT	EMC2654045	980039 & HA01	Mar. 11, 2019
5	Receiver	Agilent	N9038A	MY52130039	Aug. 11, 2019
6	Controller	CT	SC100	N/A	N/A
7	Controller	MF	MF-7802	MF780208416	N/A
8	Cable	mitron	B10-01-01-12M	18072744	Jul. 30, 2019
9	Measurement Software	Farad	EZ-EMC Ver.NB-03A1-01	N/A	N/A

6 dB Bandwidth

Item	Kind of Equipment	Manufacturer	Type No.	Serial No.	Calibrated until
1	Spectrum Analyzer	R&S	FSP40	100185	Aug. 11, 2019

Maximum output power

Item	Kind of Equipment	Manufacturer	Type No.	Serial No.	Calibrated until
1	Power Meter	ANRITSU	ML2495A	1128009	Mar. 11, 2019
2	Pulse Power Sensor	ANRITSU	MA 2411B	1027500	Mar. 11, 2019

Antenna Conducted Spurious Emission

Item	Kind of Equipment	Manufacturer	Type No.	Serial No.	Calibrated until
1	Spectrum Analyzer	R&S	FSP40	100185	Aug. 11, 2019

Power Spectral Density

Item	Kind of Equipment	Manufacturer	Type No.	Serial No.	Calibrated until
1	Spectrum Analyzer	R&S	FSP40	100185	Aug. 11, 2019

Remark: "N/A" denotes no model name, serial no. or calibration specified.
 All calibration period of equipment list is one year.

APPENDIX A - CONDUCTED EMISSION

Test Mode: TX Mode _Adapter: Huntkey

Line

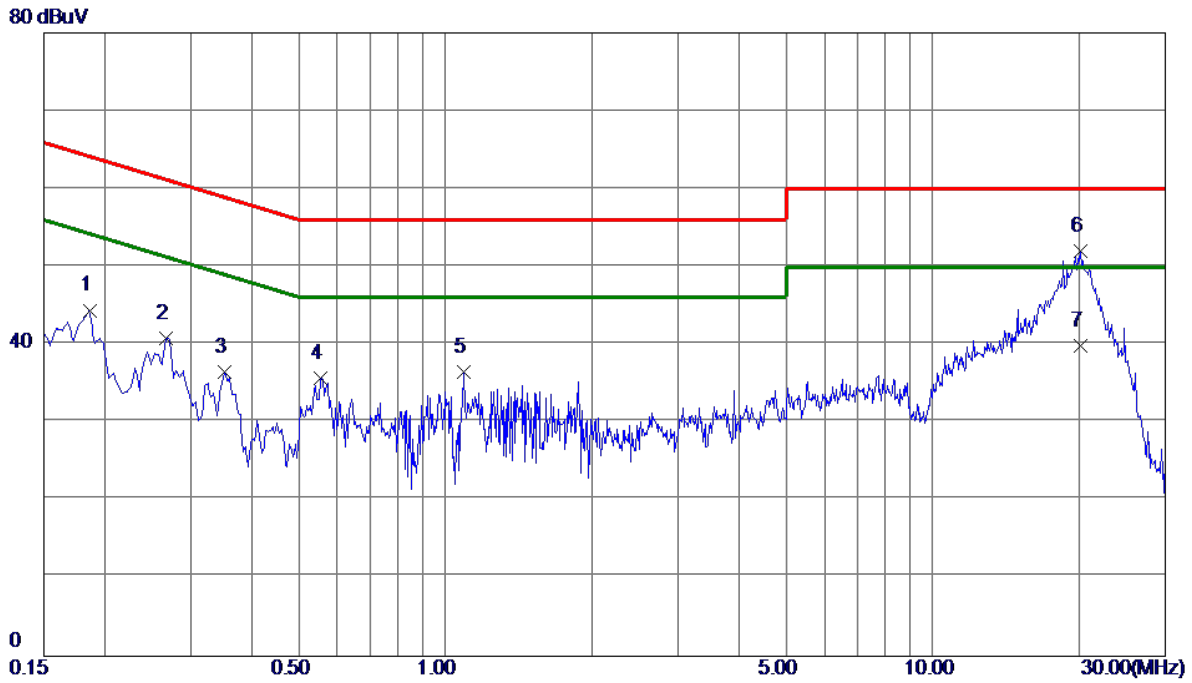

No.	Freq. MHz	Reading Level dBuV	Correct Factor dB	Measure ment dBuV	Limit dBuV	Margin dB	Detector	Comment
1	0.1860	34.58	9.82	44.40	64.21	-19.81	Peak	
2	0.2670	31.03	9.82	40.85	61.21	-20.36	Peak	
3	0.3525	26.73	9.81	36.54	58.90	-22.36	Peak	
4	0.5550	25.85	9.81	35.66	56.00	-20.34	Peak	
5	1.0905	26.53	9.93	36.46	56.00	-19.54	Peak	
6 *	20.0715	40.75	11.19	51.94	60.00	-8.06	Peak	
7	20.0715	28.60	11.19	39.79	50.00	-10.21	AVG	

Test Mode: TX Mode _Adapter: Huntkey

Neutral

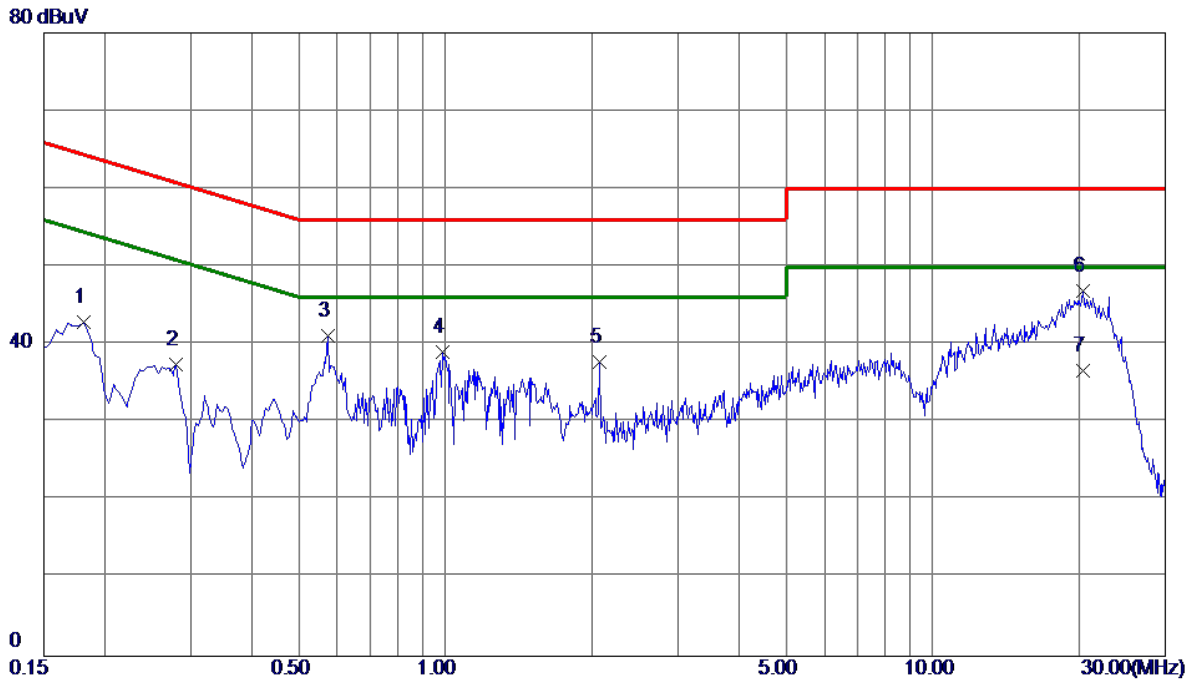

No.	Freq. MHz	Reading Level dBuV	Correct Factor dB	Measure ment dBuV	Limit dBuV	Margin dB	Detector	Comment
1	0.1815	33.01	9.91	42.92	64.42	-21.50	Peak	
2	0.2805	27.48	9.93	37.41	60.80	-23.39	Peak	
3	0.5730	31.19	9.97	41.16	56.00	-14.84	Peak	
4	0.9870	28.91	10.12	39.03	56.00	-16.97	Peak	
5	2.0715	27.57	10.19	37.76	56.00	-18.24	Peak	
6 *	20.3190	35.34	11.48	46.82	60.00	-13.18	Peak	
7	20.3190	25.11	11.48	36.59	50.00	-13.41	AVG	

Test Mode: TX Mode _Adapter: PHITEK

Line

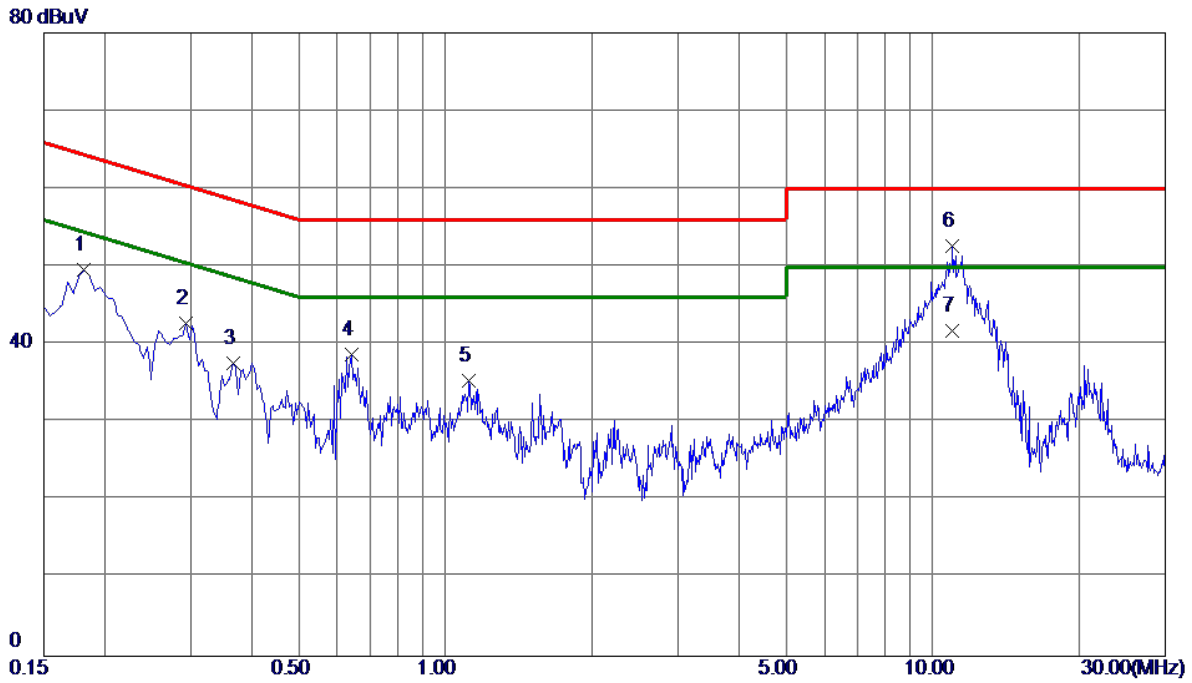

No.	Freq. MHz	Reading Level dBuV	Correct Factor dB	Measure ment dBuV	Limit dBuV	Margin dB	Detector	Comment
1	0.1815	39.84	9.82	49.66	64.42	-14.76	Peak	
2	0.2940	32.84	9.82	42.66	60.41	-17.75	Peak	
3	0.3660	27.76	9.81	37.57	58.59	-21.02	Peak	
4	0.6405	28.85	9.85	38.70	56.00	-17.30	Peak	
5	1.1174	25.43	9.93	35.36	56.00	-20.64	Peak	
6 *	10.9950	42.13	10.54	52.67	60.00	-7.33	Peak	
7	10.9950	31.20	10.54	41.74	50.00	-8.26	AVG	

Test Mode: TX Mode_Adapter: PHITEK

Neutral

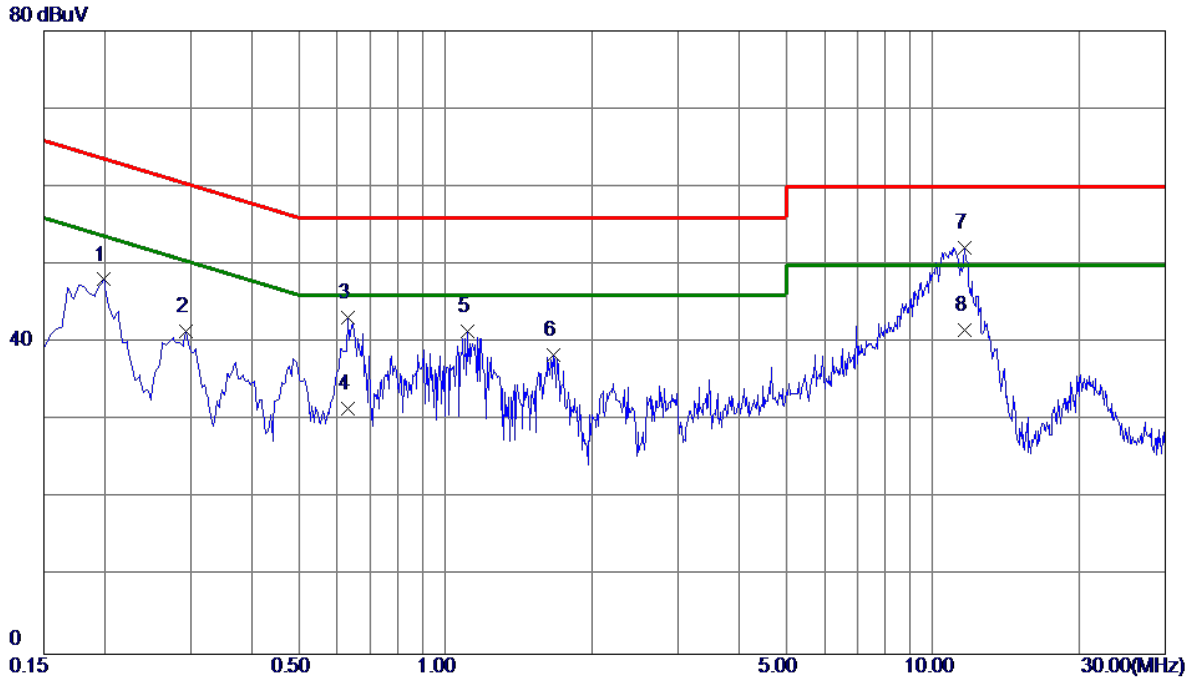

No.	Freq. MHz	Reading Level dBuV	Correct Factor dB	Measure ment dBuV	Limit dBuV	Margin dB	Detector	Comment
1	0.1995	38.17	9.91	48.08	63.63	-15.55	Peak	
2	0.2940	31.50	9.93	41.43	60.41	-18.98	Peak	
3	0.6315	33.22	10.00	43.22	56.00	-12.78	Peak	
4	0.6315	21.50	10.00	31.50	46.00	-14.50	AVG	
5	1.1085	31.36	10.13	41.49	56.00	-14.51	Peak	
6	1.6710	28.23	10.17	38.40	56.00	-17.60	Peak	
7 *	11.6520	41.35	10.86	52.21	60.00	-7.79	Peak	
8	11.6520	30.80	10.86	41.66	50.00	-8.34	AVG	

Test Mode: TX Mode _Adapter: BYD

Line

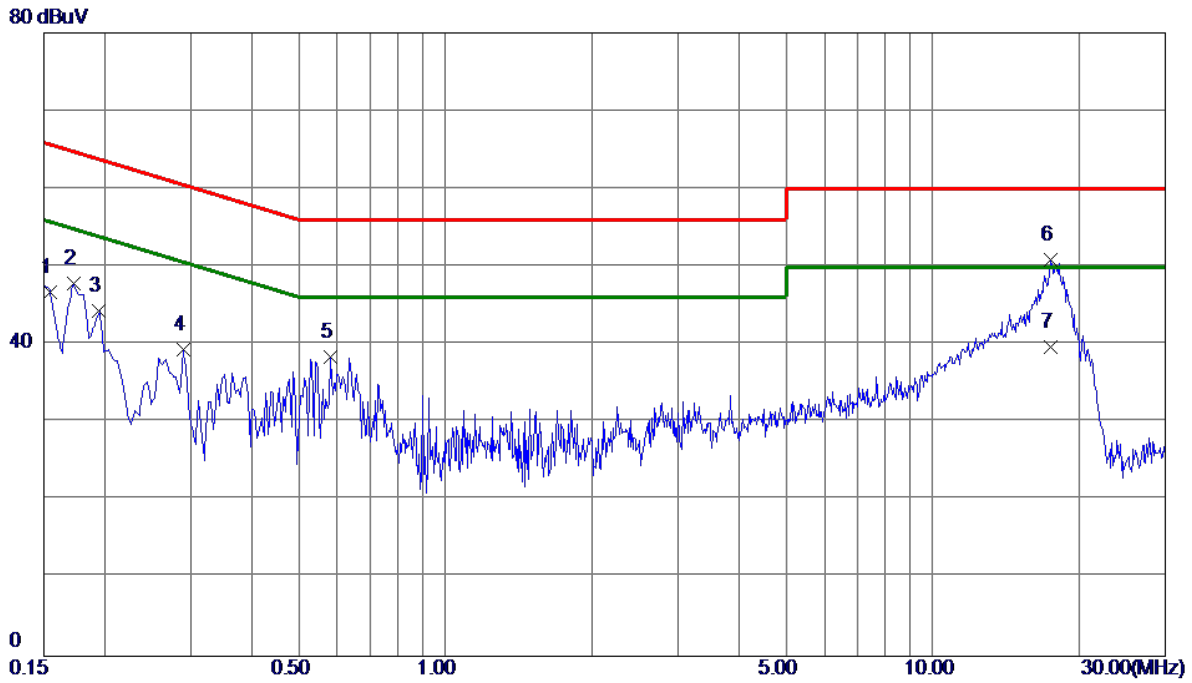

No.	Freq. MHz	Reading Level dBuV	Correct Factor dB	Measure ment dBuV	Limit dBuV	Margin dB	Detector	Comment
1	0.1548	36.92	9.82	46.74	65.74	-19.00	Peak	
2	0.1725	38.07	9.82	47.89	64.84	-16.95	Peak	
3	0.1949	34.45	9.82	44.27	63.83	-19.56	Peak	
4	0.2895	29.53	9.82	39.35	60.54	-21.19	Peak	
5	0.5820	28.53	9.82	38.35	56.00	-17.65	Peak	
6 *	17.4480	39.87	10.97	50.84	60.00	-9.16	Peak	
7	17.4480	28.70	10.97	39.67	50.00	-10.33	AVG	

Test Mode: TX Mode _Adapter: BYD

Neutral

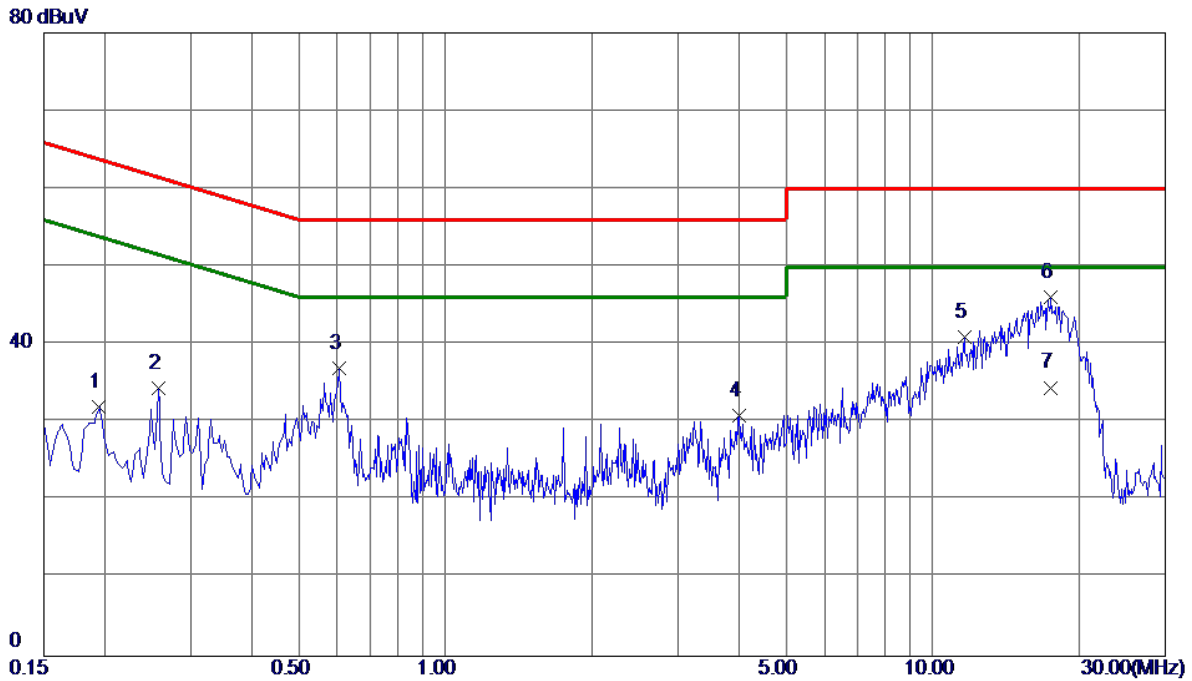

No.	Freq. MHz	Reading Level dBuV	Correct Factor dB	Measure ment dBuV	Limit dBuV	Margin dB	Detector	Comment
1	0.1949	22.09	9.91	32.00	63.83	-31.83	Peak	
2	0.2580	24.44	9.92	34.36	61.50	-27.14	Peak	
3	0.6045	26.91	9.98	36.89	56.00	-19.11	Peak	
4	4.0109	20.50	10.32	30.82	56.00	-25.18	Peak	
5	11.5980	30.13	10.85	40.98	60.00	-19.02	Peak	
6 *	17.4794	34.73	11.28	46.01	60.00	-13.99	Peak	
7	17.4794	23.20	11.28	34.48	50.00	-15.52	AVG	

APPENDIX B - RADIATED EMISSION (9 KHZ TO 30 MHZ)

Test Mode: TX Mode _Adapter: Huntkey

Ant 0°

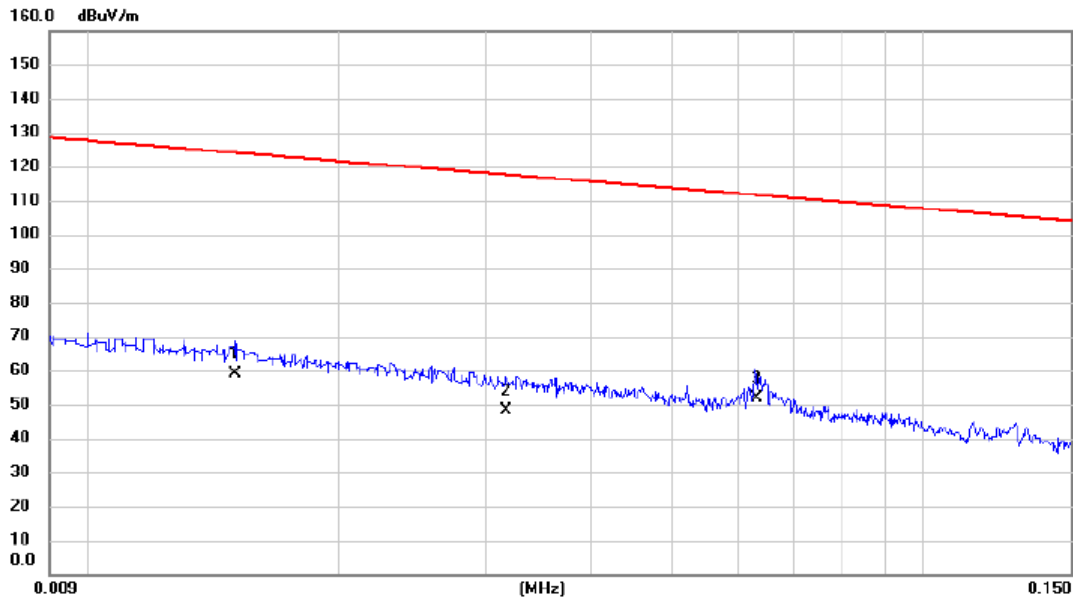

No.	Mk.	Freq.	Reading Level	Correct Factor	Measurement	Limit	Margin	Detector	Comment
		MHz	dBuV	dB	dBuV/m	dBuV/m	dB		
1		0.0150	38.10	20.72	58.82	124.08	-65.26	AVG	
2		0.0317	28.30	19.82	48.12	117.58	-69.46	AVG	
3	*	0.0631	32.50	19.27	51.77	111.60	-59.83	AVG	

Test Mode: TX Mode_Adapter: Huntkey

Ant 0°

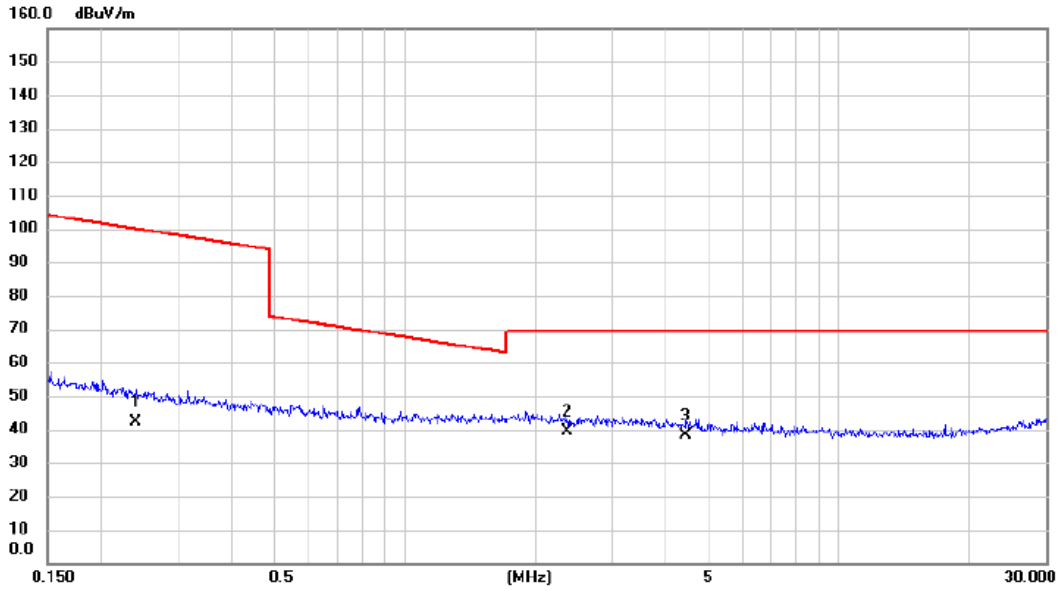

No.	Mk.	Freq. MHz	Reading Level dBuV	Correct Factor dB	Measure- ment dBuV/m	Limit dBuV/m	Margin dB	Detector	Comment
1		0.2404	25.10	17.08	42.18	99.99	-57.81	AVG	
2	*	2.3585	22.70	16.90	39.60	69.54	-29.94	QP	
3		4.4540	22.80	15.49	38.29	69.54	-31.25	QP	

Test Mode: TX Mode_Adapter: Huntkey

Ant 90°

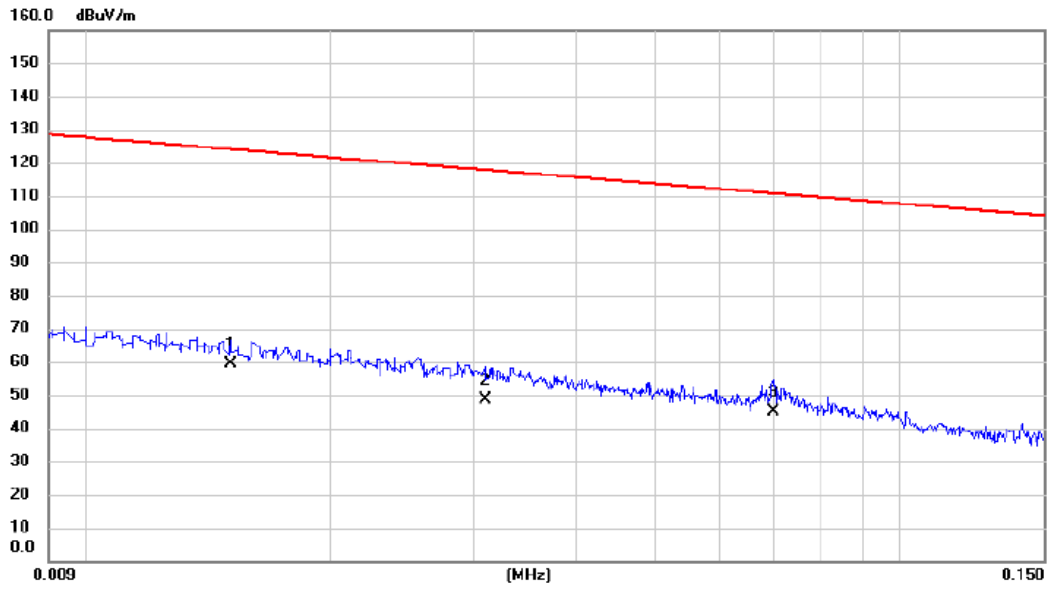

No.	Mk.	Freq. MHz	Reading Level dBuV	Correct Factor dB	Measure- ment dBuV/m	Limit dBuV/m	Margin dB	Detector	Comment
1	*	0.0151	38.50	20.71	59.21	124.03	-64.82	AVG	
2		0.0310	28.80	19.84	48.64	117.78	-69.14	AVG	
3		0.0700	25.70	19.13	44.83	110.70	-65.87	AVG	

Test Mode: TX Mode_Adapter: Huntkey

Ant 90°

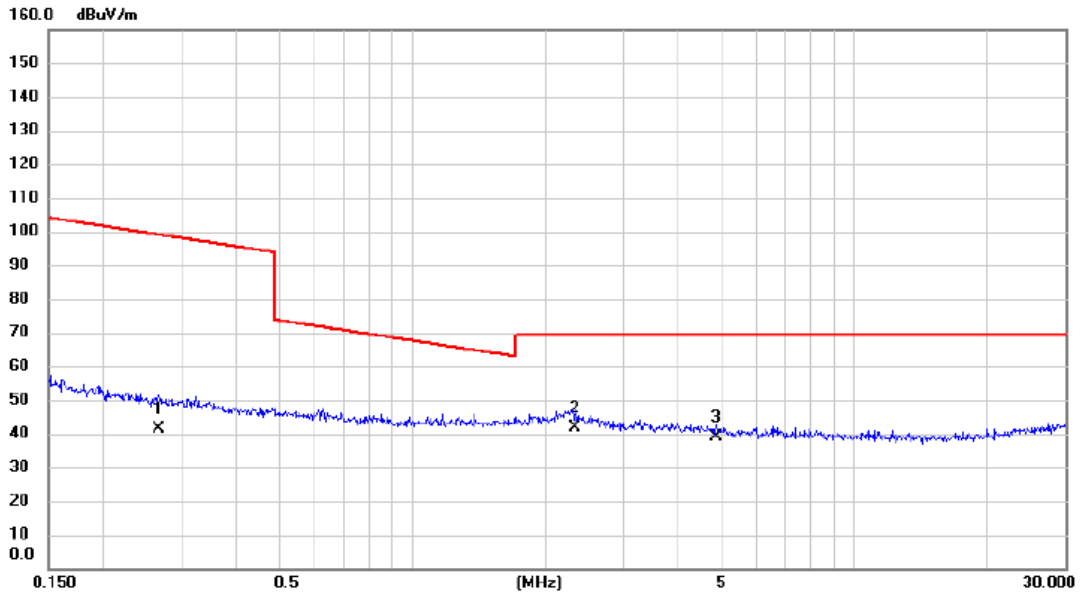

No.	Mk.	Freq. MHz	Reading Level dBuV	Correct Factor dB	Measure- ment dBuV/m	Limit dBuV/m	Margin dB	Detector	Comment
1		0.2672	24.30	17.05	41.35	99.07	-57.72	AVG	
2	*	2.3336	24.70	16.92	41.62	69.54	-27.92	QP	
3		4.8738	23.60	15.25	38.85	69.54	-30.69	QP	

Test Mode: TX Mode _Adapter: PHITEK

Ant 0°

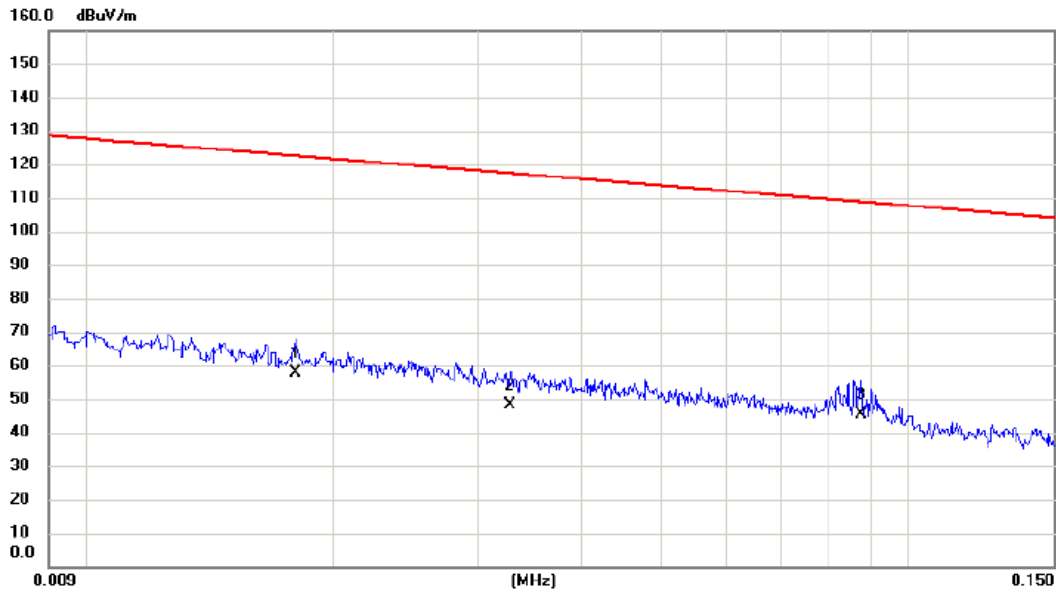

No.	Mk.	Freq. MHz	Reading Level dBuV	Correct Factor dB	Measure- ment dBuV/m	Limit dBuV/m	Margin dB	Detector	Comment
1		0.0180	37.60	20.30	57.90	122.50	-64.60	AVG	
2		0.0328	28.50	19.81	48.31	117.29	-68.98	AVG	
3	*	0.0875	26.80	18.73	45.53	108.76	-63.23	AVG	

Test Mode: TX Mode_Adapter: PHITEK

Ant 0°

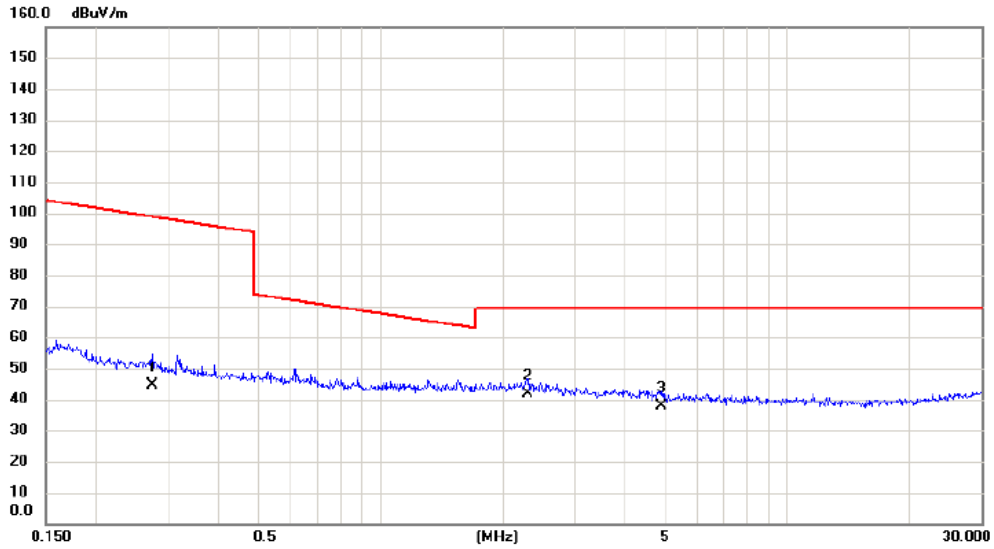

No.	Mk.	Freq. MHz	Reading Level dBuV	Correct Factor dB	Measure- ment dBuV/m	Limit dBuV/m	Margin dB	Detector	Comment
1		0.2744	27.50	17.05	44.55	98.84	-54.29	AVG	
2	*	2.2968	24.80	16.94	41.74	69.54	-27.80	QP	
3		4.8997	22.40	15.23	37.63	69.54	-31.91	QP	

Test Mode: TX Mode_Adapter: PHITEK

Ant 90°

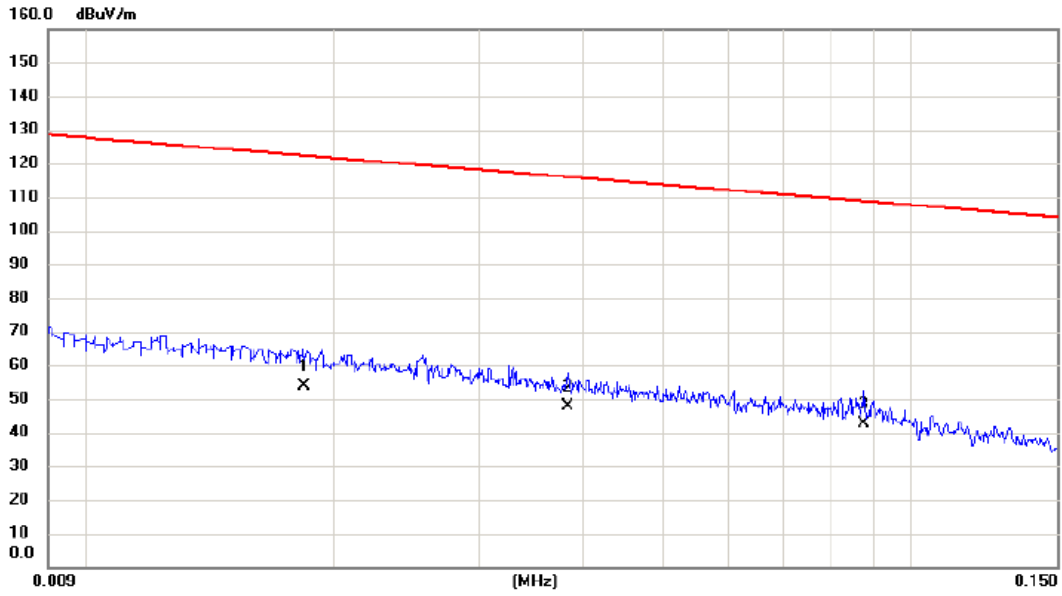

No.	Mk.	Freq. MHz	Reading Level dBuV	Correct Factor dB	Measure- ment dBuV/m	Limit dBuV/m	Margin dB	Detector	Comment
1		0.0184	33.60	20.24	53.84	122.31	-68.47	AVG	
2		0.0383	28.10	19.72	47.82	115.94	-68.12	AVG	
3	*	0.0875	23.70	18.73	42.43	108.76	-66.33	AVG	

Test Mode: TX Mode_Adapter: PHITEK

Ant 90°

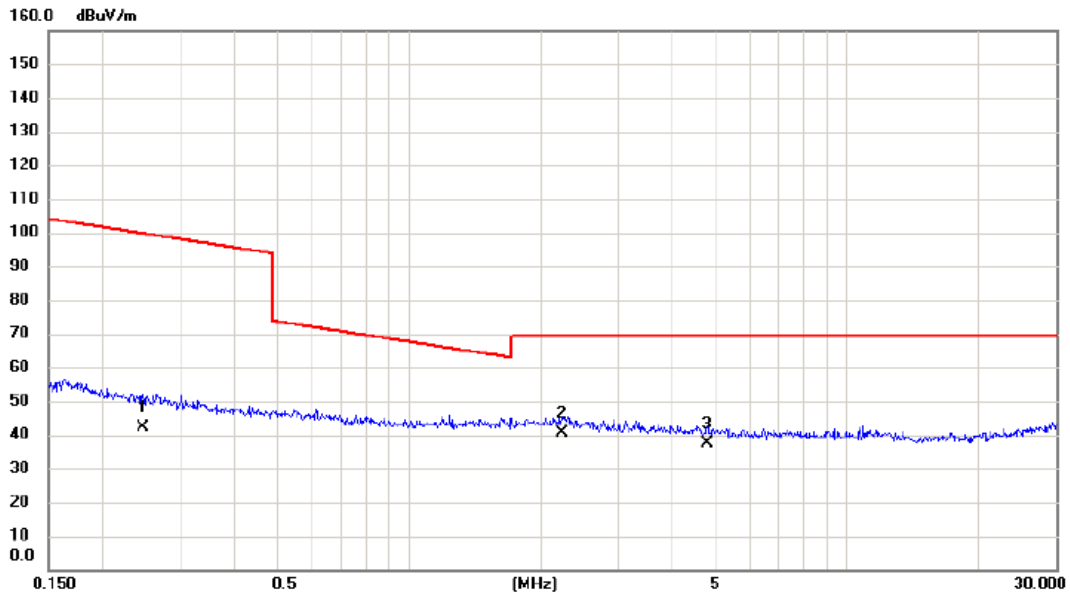

No.	Mk.	Freq. MHz	Reading Level dBuV	Correct Factor dB	Measure- ment dBuV/m	Limit dBuV/m	Margin dB	Detector	Comment
1		0.2468	25.20	17.07	42.27	99.76	-57.49	AVG	
2	*	2.2367	23.60	16.97	40.57	69.54	-28.97	QP	
3		4.7970	22.20	15.29	37.49	69.54	-32.05	QP	

Test Mode: TX Mode _Adapter: BYD

Ant 0°

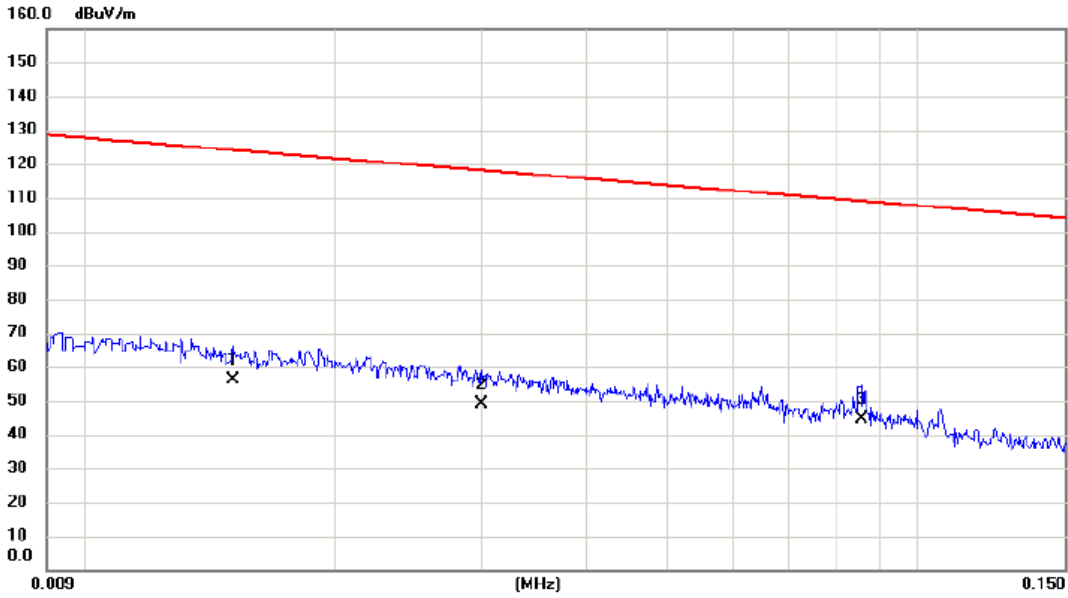

No.	Mk.	Freq. MHz	Reading Level dBuV	Correct Factor dB	Measure- ment dBuV/m	Limit dBuV/m	Margin dB	Detector	Comment
1		0.0151	35.60	20.71	56.31	124.03	-67.72	AVG	
2		0.0300	29.21	19.85	49.06	118.06	-69.00	AVG	
3	*	0.0857	25.90	18.77	44.67	108.95	-64.28	AVG	

Test Mode: TX Mode_Adapter: BYD

Ant 0°

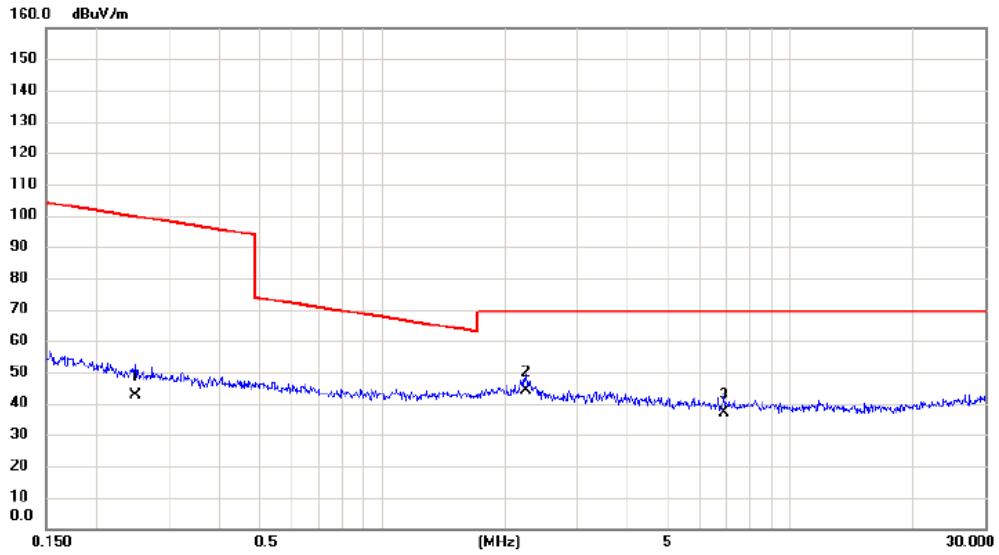

No.	Mk.	Freq. MHz	Reading Level dBuV	Correct Factor dB	Measure- ment dBuV/m	Limit dBuV/m	Margin dB	Detector	Comment
1		0.2481	25.40	17.06	42.46	99.71	-57.25	AVG	
2	*	2.2486	27.30	16.96	44.26	69.54	-25.28	QP	
3		6.8776	22.10	14.86	36.96	69.54	-32.58	QP	

Test Mode: TX Mode_Adapter: BYD

Ant 90°

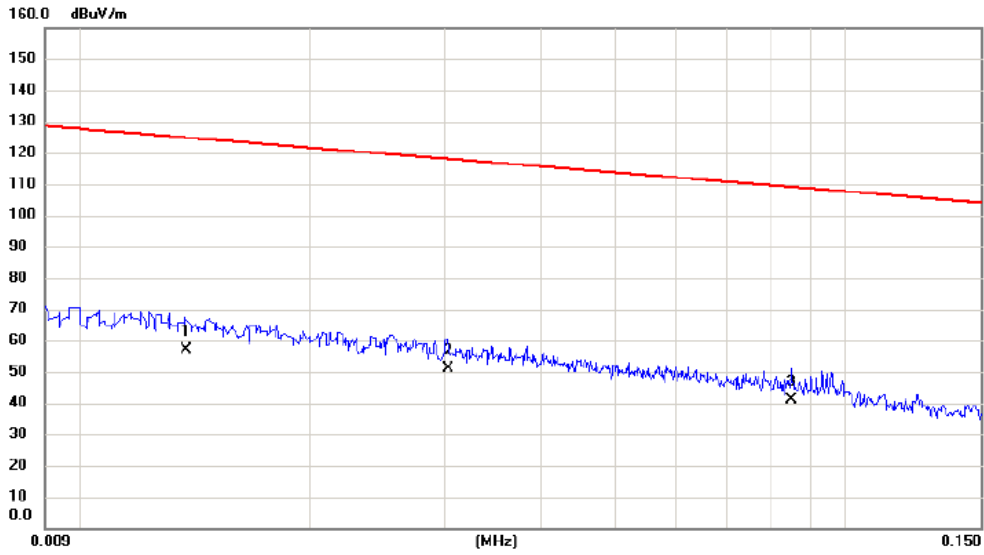

No. Mk.	Freq. MHz	Reading Level dBuV	Correct Factor dB	Measurement dBuV/m	Limit dBuV/m	Margin dB	Detector	Comment
1	0.0138	36.30	20.89	57.19	124.81	-67.62	AVG	
2 *	0.0303	31.10	19.85	50.95	117.98	-67.03	AVG	
3	0.0850	22.40	18.79	41.19	109.02	-67.83	AVG	

Test Mode: TX Mode_Adapter: BYD

Ant 90°

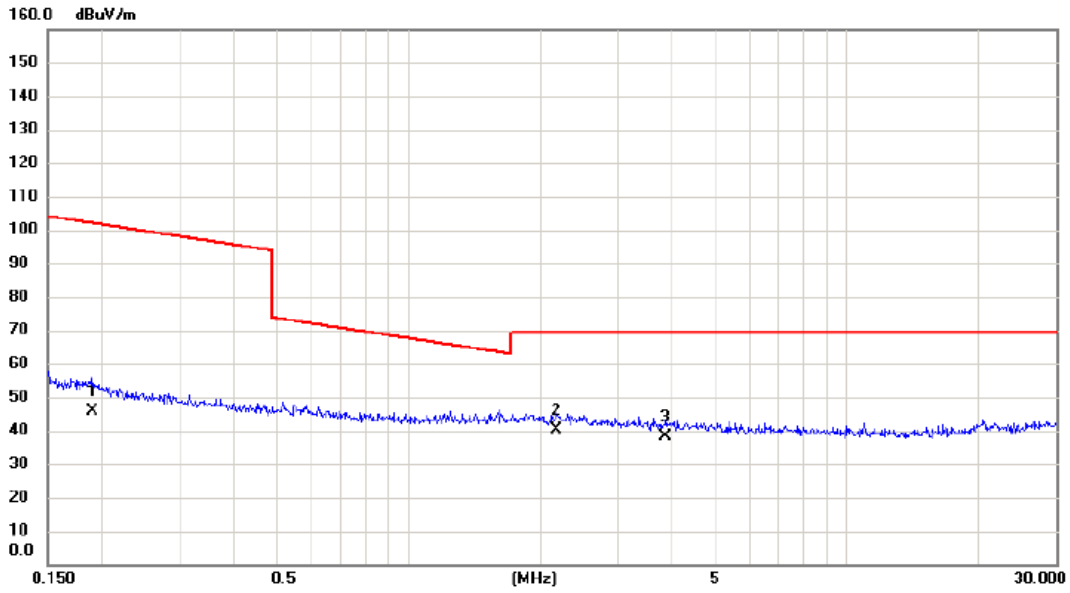

No.	Mk.	Freq. MHz	Reading Level dBuV	Correct Factor dB	Measure- ment dBuV/m	Limit dBuV/m	Margin dB	Detector	Comment
1		0.1894	28.50	17.17	45.67	102.06	-56.39	AVG	
2	*	2.1783	23.40	17.00	40.40	69.54	-29.14	QP	
3		3.8603	22.30	15.86	38.16	69.54	-31.38	QP	

APPENDIX C - RADIATED EMISSION (30 MHZ TO 1000 MHZ)

Test Mode: TX B Mode Channel 06_Adapter: Huntkey

Vertical

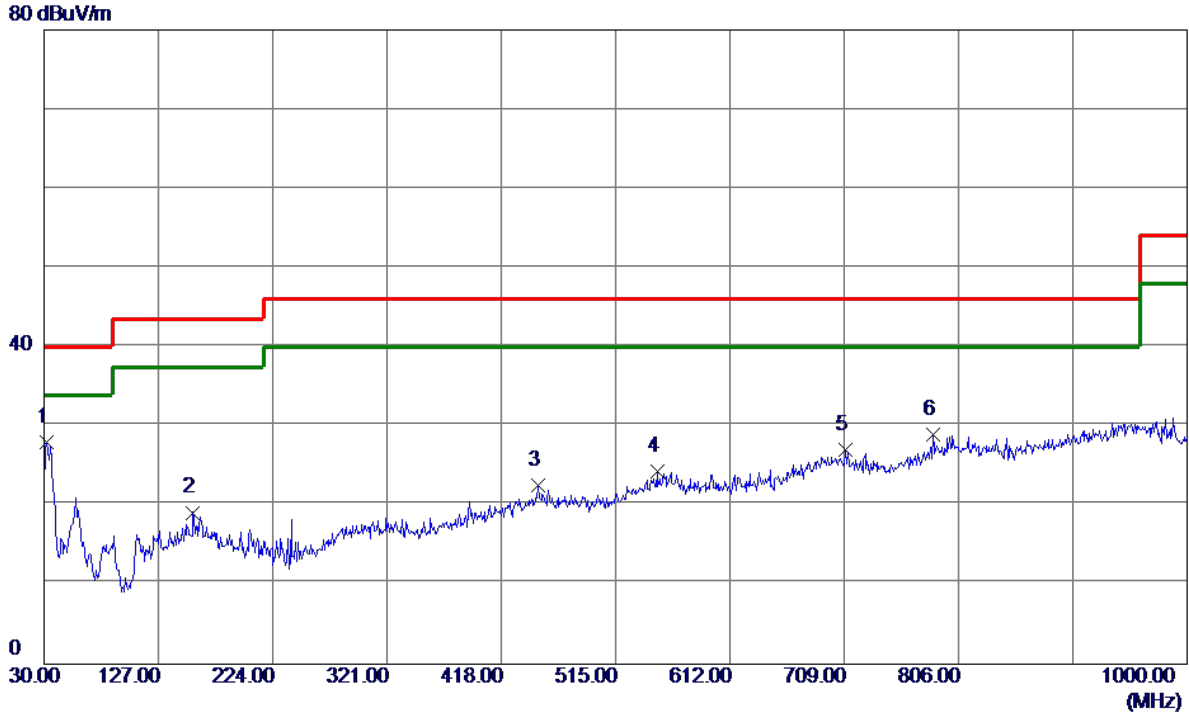

No.	Freq. MHz	Reading Level dBuV/m	Correct Factor dB	Measure ment dBuV/m	Limit dBuV/m	Margin dB	Detector	Comment
1 *	32.4250	43.04	-14.99	28.05	40.00	-11.95	Peak	
2	156.5850	30.02	-10.90	19.12	43.50	-24.38	Peak	
3	449.5250	29.95	-7.42	22.53	46.00	-23.47	Peak	
4	550.4050	29.86	-5.47	24.39	46.00	-21.61	Peak	
5	709.9699	30.11	-3.00	27.11	46.00	-18.89	Peak	
6	784.1750	30.94	-1.99	28.95	46.00	-17.05	Peak	

Test Mode: TX B Mode Channel 06_Adapter: Huntkey

Horizontal

80 dBuV/m

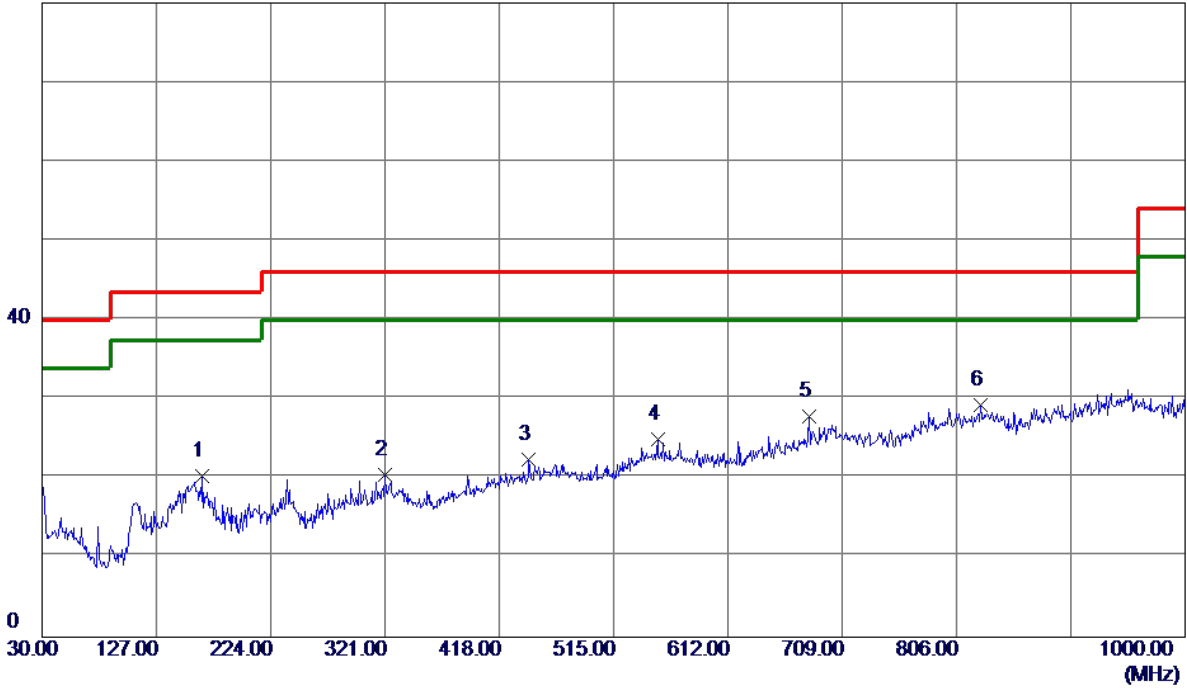

No.	Freq. MHz	Reading Level dBuV/m	Correct Factor dB	Measure ment dBuV/m	Limit dBuV/m	Margin dB	Detector	Comment
1	165.8000	31.21	-10.95	20.26	43.50	-23.24	Peak	
2	321.0000	31.19	-10.67	20.52	46.00	-25.48	Peak	
3	443.2200	30.05	-7.67	22.38	46.00	-23.62	Peak	
4	552.3449	30.45	-5.50	24.95	46.00	-21.05	Peak	
5	681.3550	31.43	-3.65	27.78	46.00	-18.22	Peak	
6 *	826.3700	30.69	-1.45	29.24	46.00	-16.76	Peak	

Test Mode: TX B Mode Channel 06_Adapter: PHITEK

Vertical

80 dBuV/m



No.	Freq. MHz	Reading Level dBuV/m	Correct Factor dB	Measure ment dBuV/m	Limit dBuV/m	Margin dB	Detector	Comment
1	36.7900	43.26	-14.86	28.40	40.00	-11.60	Peak	
2 *	53.7650	43.65	-14.94	28.71	40.00	-11.29	Peak	
3	167.7400	33.44	-11.06	22.38	43.50	-21.12	Peak	
4	680.3850	30.62	-3.70	26.92	46.00	-19.08	Peak	
5	813.7600	29.64	-1.25	28.39	46.00	-17.61	Peak	
6	951.5000	29.86	1.37	31.23	46.00	-14.77	Peak	

Test Mode: TX B Mode Channel 06_Adapter: PHITEK

Horizontal

80 dBuV/m

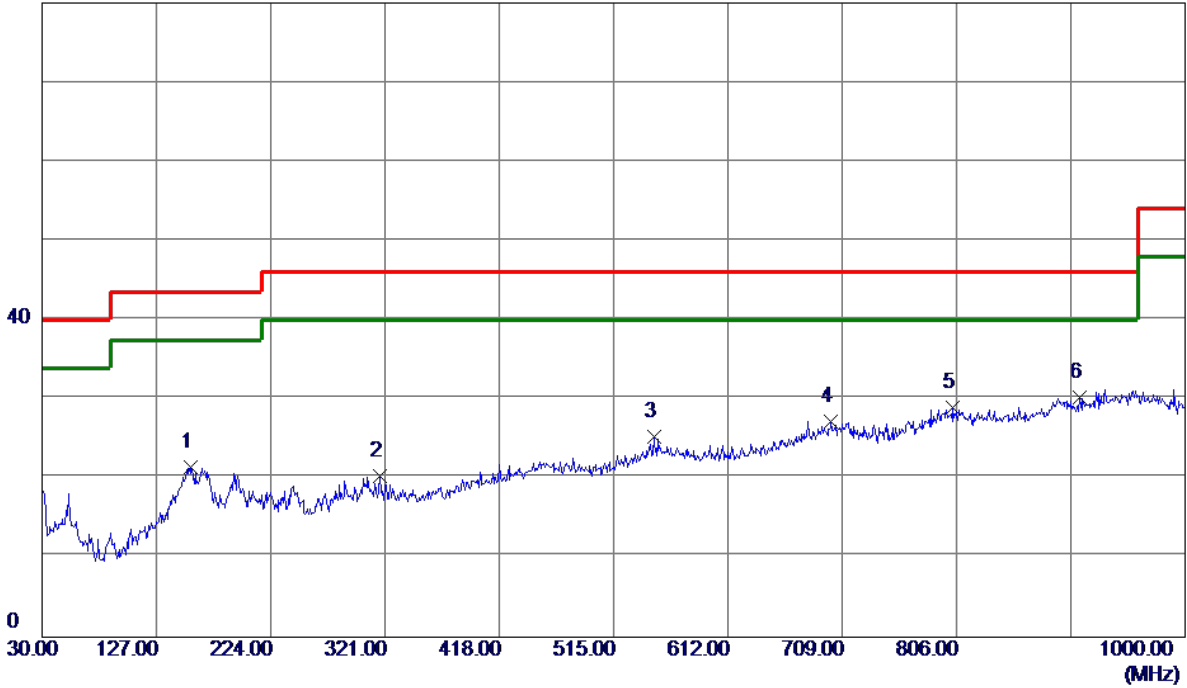

No.	Freq. MHz	Reading Level dBuV/m	Correct Factor dB	Measure ment dBuV/m	Limit dBuV/m	Margin dB	Detector	Comment
1	155.6150	32.37	-10.99	21.38	43.50	-22.12	Peak	
2	316.6350	30.90	-10.61	20.29	46.00	-25.71	Peak	
3	549.4350	30.84	-5.50	25.34	46.00	-20.66	Peak	
4	699.3000	30.03	-2.78	27.25	46.00	-18.75	Peak	
5	803.0900	30.07	-1.09	28.98	46.00	-17.02	Peak	
6 *	910.2750	30.36	-0.19	30.17	46.00	-15.83	Peak	

Test Mode: TX B Mode Channel 06_Adapter: BYD

Vertical

80 dBuV/m

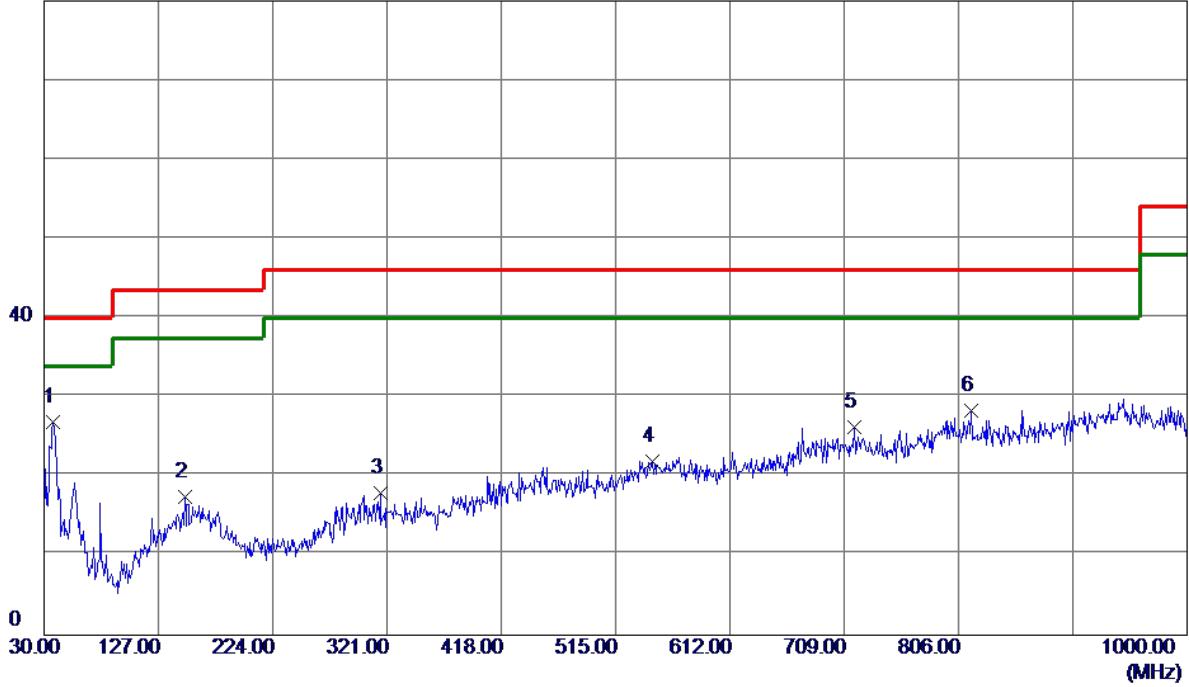

No.	Freq. MHz	Reading Level dBuV/m	Correct Factor dB	Measure ment dBuV/m	Limit dBuV/m	Margin dB	Detector	Comment
1 *	37.7599	41.57	-14.70	26.87	40.00	-13.13	Peak	
2	149.3100	28.92	-11.54	17.38	43.50	-26.12	Peak	
3	315.6650	28.52	-10.59	17.93	46.00	-28.07	Peak	
4	546.0400	27.60	-5.71	21.89	46.00	-24.11	Peak	
5	717.7300	29.44	-3.21	26.23	46.00	-19.77	Peak	
6	817.1550	29.69	-1.31	28.38	46.00	-17.62	Peak	

Test Mode: TX B Mode Channel 06_Adapter: BYD

Horizontal

80 dBuV/m

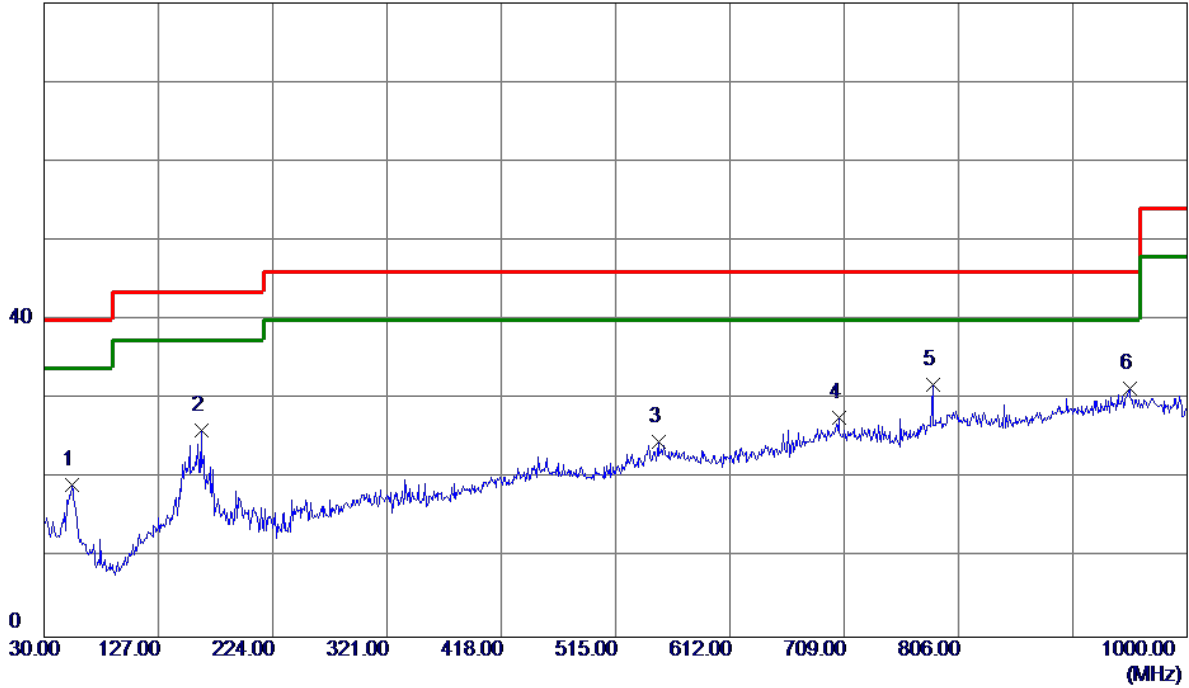

No.	Freq. MHz	Reading Level dBuV/m	Correct Factor dB	Measure ment dBuV/m	Limit dBuV/m	Margin dB	Detector	Comment
1	53.7650	34.07	-14.94	19.13	40.00	-20.87	Peak	
2	163.3750	36.83	-10.80	26.03	43.50	-17.47	Peak	
3	551.3750	30.08	-5.49	24.59	46.00	-21.41	Peak	
4	704.6350	30.56	-2.87	27.69	46.00	-18.31	Peak	
5 *	784.1750	33.76	-1.99	31.77	46.00	-14.23	Peak	
6	951.0150	29.93	1.39	31.32	46.00	-14.68	Peak	

APPENDIX D - RADIATED EMISSION (ABOVE 1000 MHZ)

Orthogonal Axis	X
Test Mode:	TX B Mode 2412 MHz

Vertical

130 dBuV/m

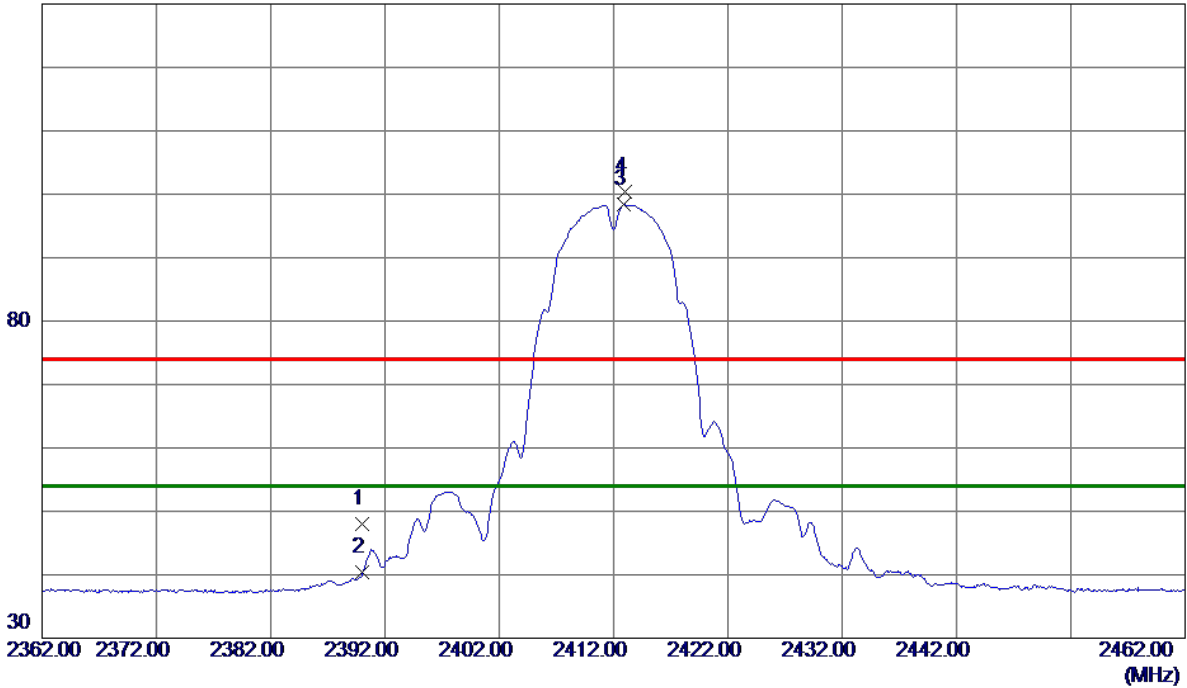

No.	Freq. MHz	Reading Level dBuV/m	Correct Factor dB	Measure ment dBuV/m	Limit dBuV/m	Margin dB	Detector	Comment
1	2390.0000	40.54	7.39	47.93	74.00	-26.07	Peak	
2	2390.0000	32.92	7.39	40.31	54.00	-13.69	AVG	
3 *	2412.8500	91.06	7.37	98.43	54.00	44.43	AVG	No Limit
4	2412.9500	93.06	7.37	100.43	74.00	26.43	Peak	No Limit

Orthogonal Axis	X
Test Mode:	TX B Mode 2412 MHz

Horizontal

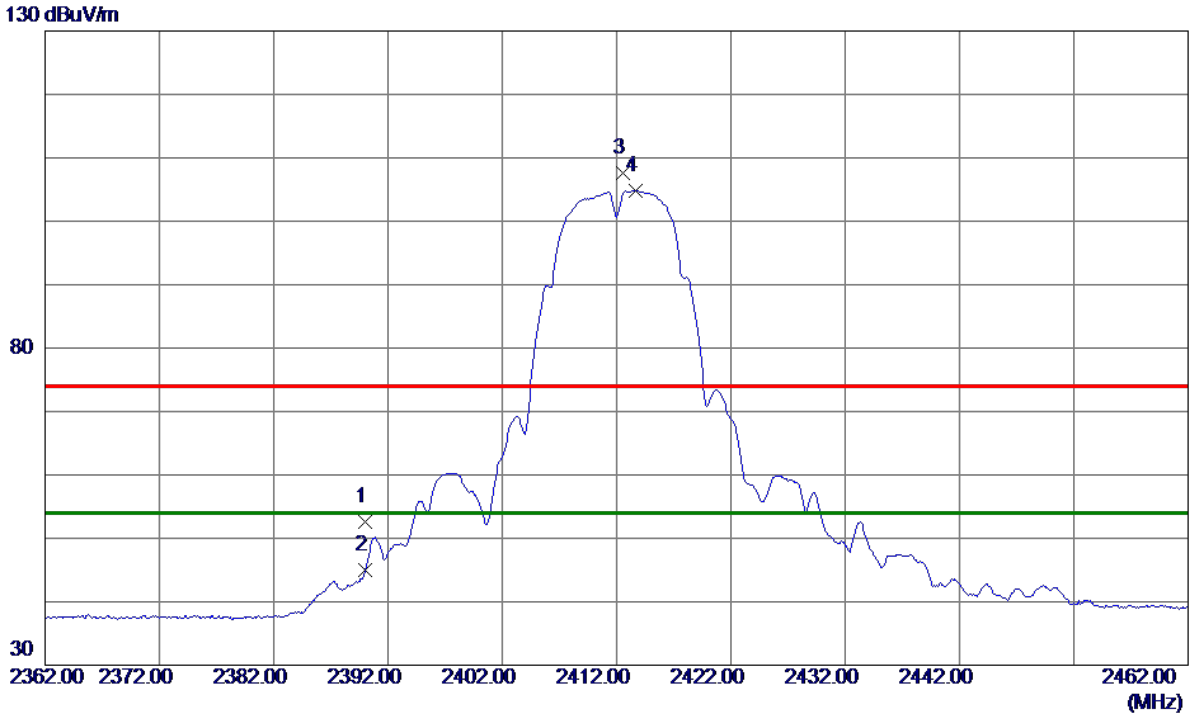

No.	Freq. MHz	Reading Level dBuV/m	Correct Factor dB	Measure ment dBuV/m	Limit dBuV/m	Margin dB	Detector	Comment
1	2390.0000	45.30	7.39	52.69	74.00	-21.31	Peak	
2	2390.0000	37.62	7.39	45.01	54.00	-8.99	AVG	
3	2412.6000	100.24	7.37	107.61	74.00	33.61	Peak	No Limit
4 *	2413.7000	97.40	7.37	104.77	54.00	50.77	AVG	No Limit

Orthogonal Axis	X
Test Mode:	TX B Mode 2437 MHz

Vertical

130 dBuV/m

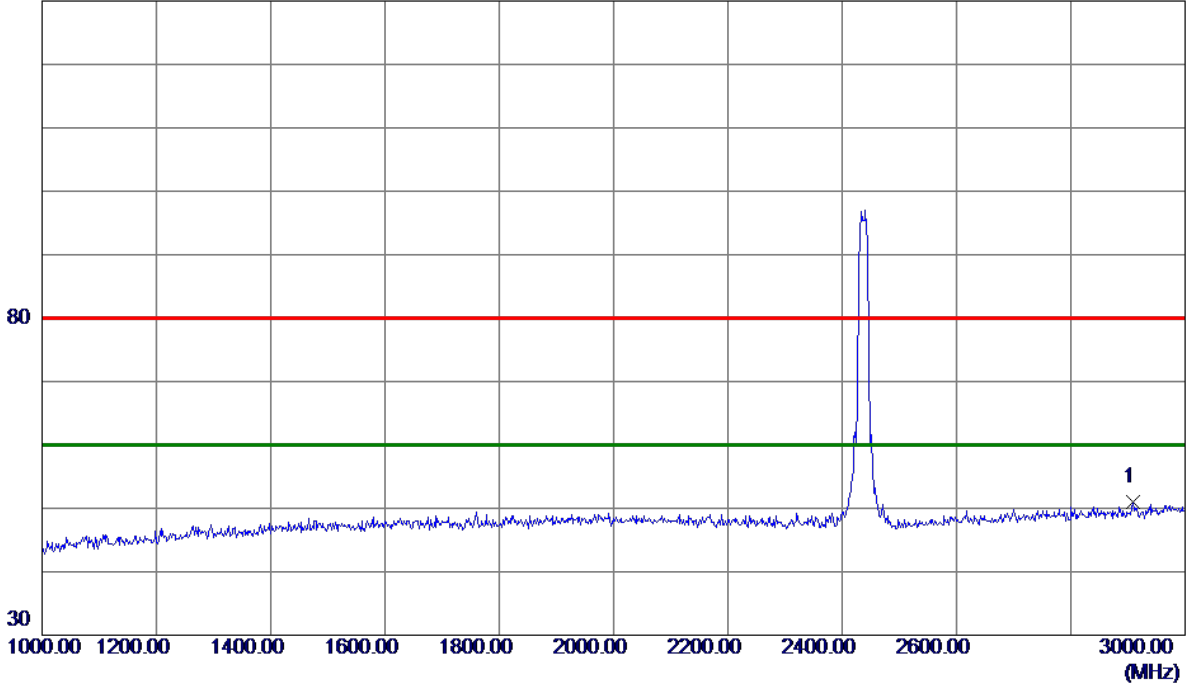

No.	Freq. MHz	Reading Level dBuV/m	Correct Factor dB	Measure ment dBuV/m	Limit dBuV/m	Margin dB	Detector	Comment
1 *	2909.0000	41.16	9.80	50.96	80.00	-29.04	Peak	

Orthogonal Axis	X
Test Mode:	TX B Mode 2437 MHz

Vertical

130 dBuV/m

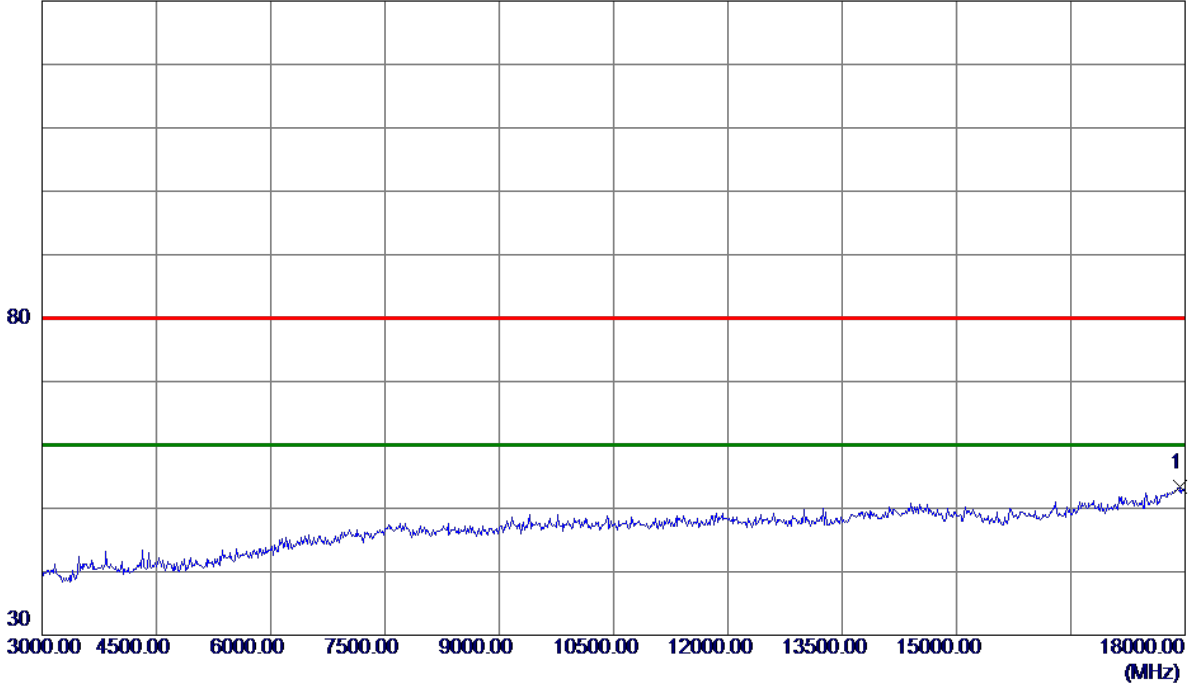

No.	Freq. MHz	Reading Level dBuV/m	Correct Factor dB	Measure ment dBuV/m	Limit dBuV/m	Margin dB	Detector	Comment
1 *	17940.0000	35.71	17.59	53.30	80.00	-26.70	Peak	

Orthogonal Axis	X
Test Mode:	TX B Mode 2437 MHz

Vertical

130 dBuV/m

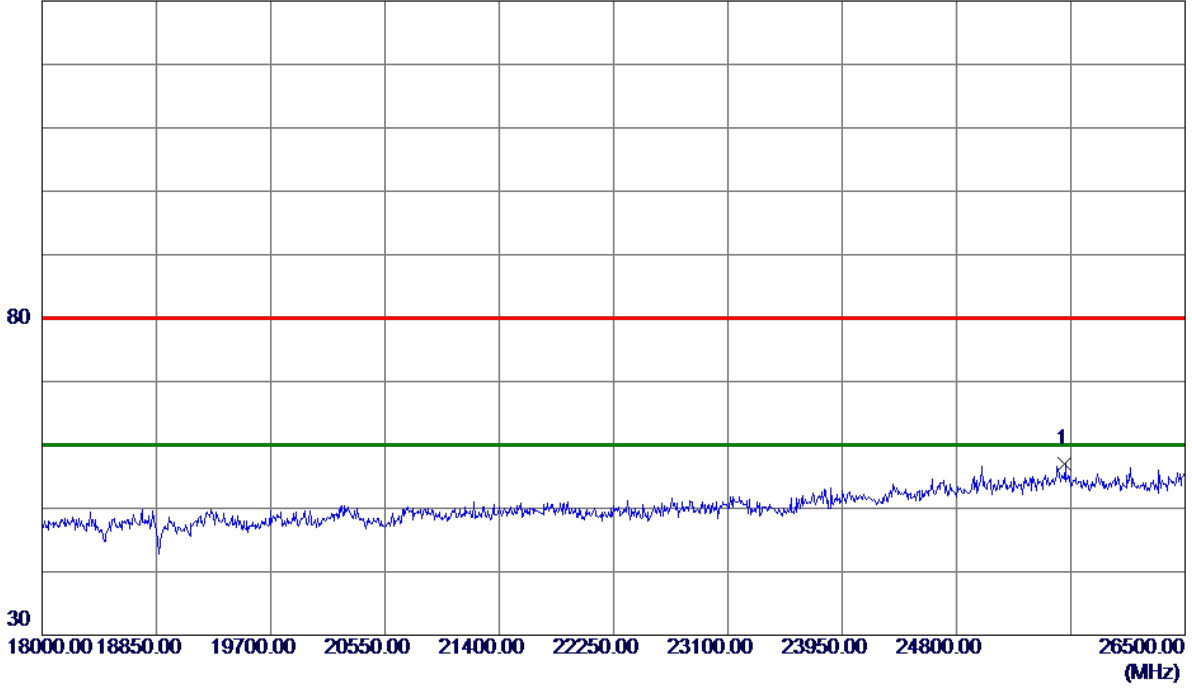

No.	Freq. MHz	Reading Level dBuV/m	Correct Factor dB	Measure ment dBuV/m	Limit dBuV/m	Margin dB	Detector	Comment
1 *	25607.5000	39.85	17.20	57.05	80.00	-22.95	Peak	

Orthogonal Axis	X
Test Mode:	TX B Mode 2437 MHz

Horizontal

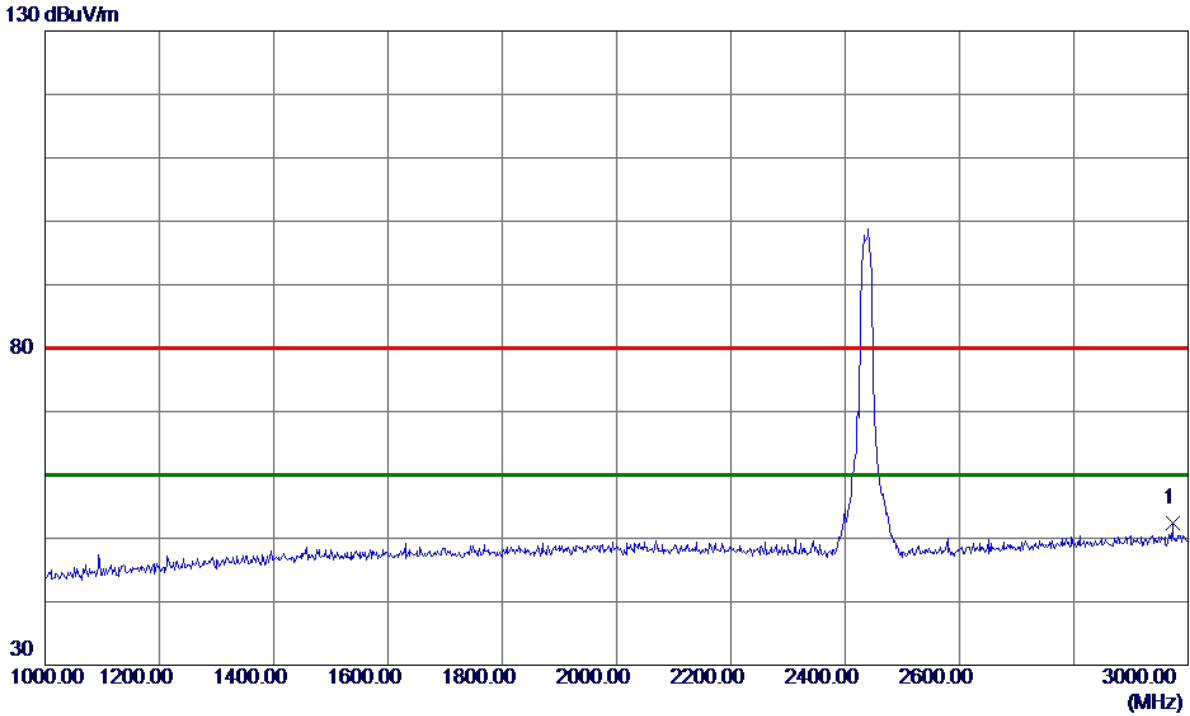

No.	Freq. MHz	Reading Level dBuV/m	Correct Factor dB	Measure ment dBuV/m	Limit dBuV/m	Margin dB	Detector	Comment
1 *	2973.0000	42.14	10.20	52.34	80.00	-27.66	Peak	

Orthogonal Axis	X
Test Mode:	TX B Mode 2437 MHz

Horizontal

130 dBuV/m

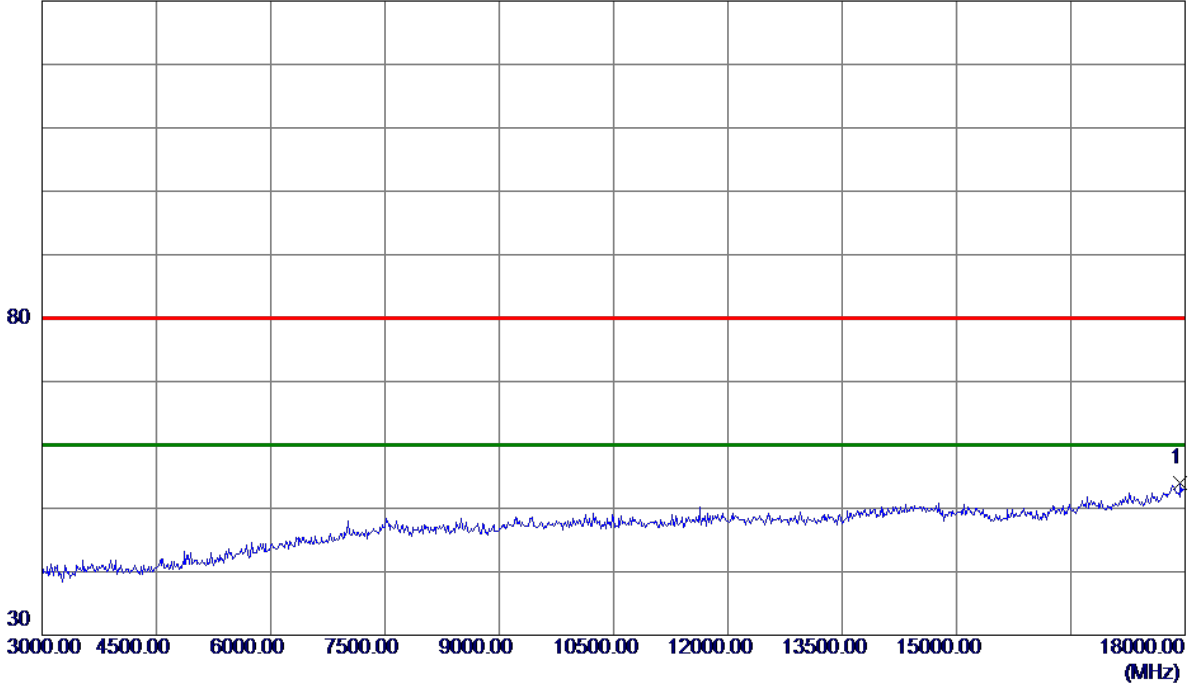

No.	Freq. MHz	Reading Level dBuV/m	Correct Factor dB	Measure ment dBuV/m	Limit dBuV/m	Margin dB	Detector	Comment
1 *	17940.0000	36.49	17.59	54.08	80.00	-25.92	Peak	

Orthogonal Axis	X
Test Mode:	TX B Mode 2437 MHz

Horizontal

130 dBuV/m

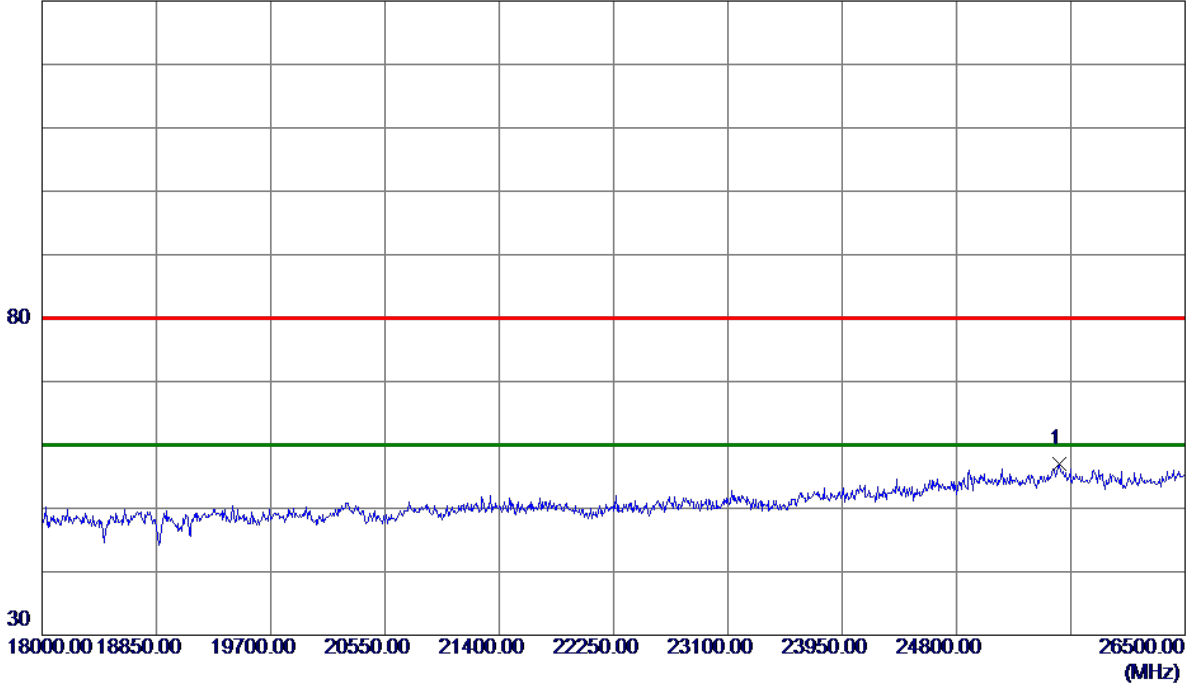

No.	Freq. MHz	Reading Level dBuV/m	Correct Factor dB	Measure ment dBuV/m	Limit dBuV/m	Margin dB	Detector	Comment
1 *	25569.2500	39.82	17.25	57.07	80.00	-22.93	Peak	

Orthogonal Axis	X
Test Mode:	TX B Mode 2462 MHz

Vertical

130 dBuV/m

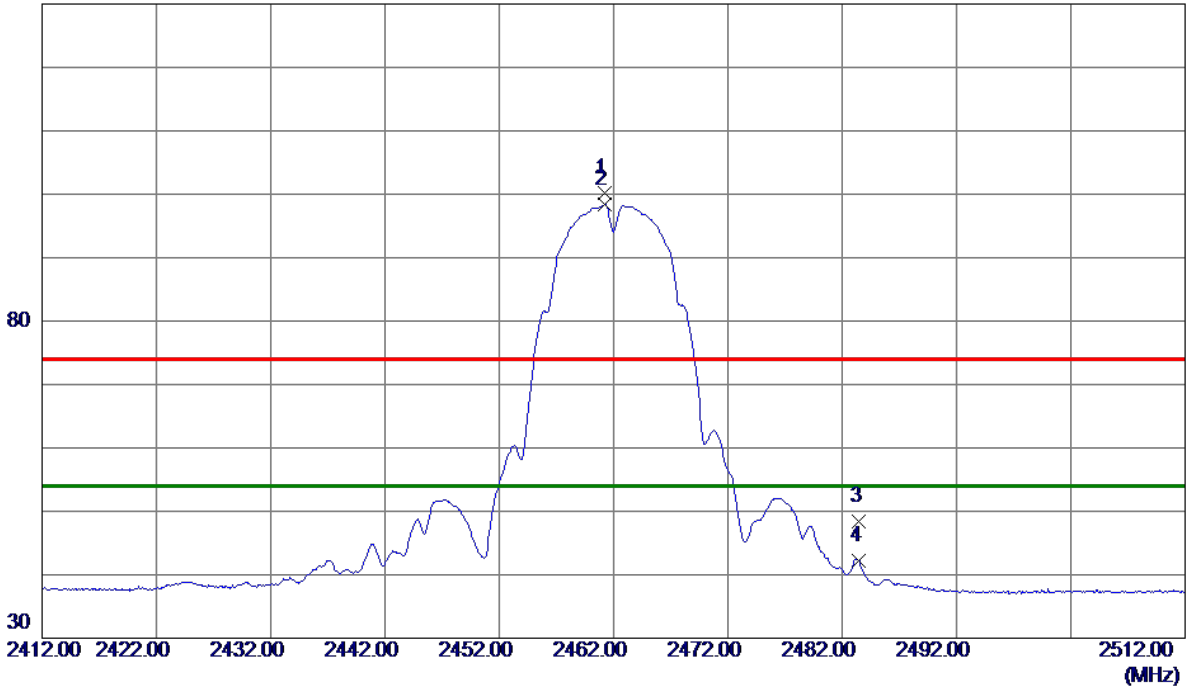

No.	Freq. MHz	Reading Level dBuV/m	Correct Factor dB	Measure ment dBuV/m	Limit dBuV/m	Margin dB	Detector	Comment
1	2461.2000	92.95	7.33	100.28	74.00	26.28	Peak	No Limit
2 *	2461.2500	91.00	7.33	98.33	54.00	44.33	AVG	No Limit
3	2483.5000	41.02	7.32	48.34	74.00	-25.66	Peak	
4	2483.5000	34.83	7.32	42.15	54.00	-11.85	AVG	

Orthogonal Axis	X
Test Mode:	TX B Mode 2462 MHz

Horizontal

130 dBuV/m

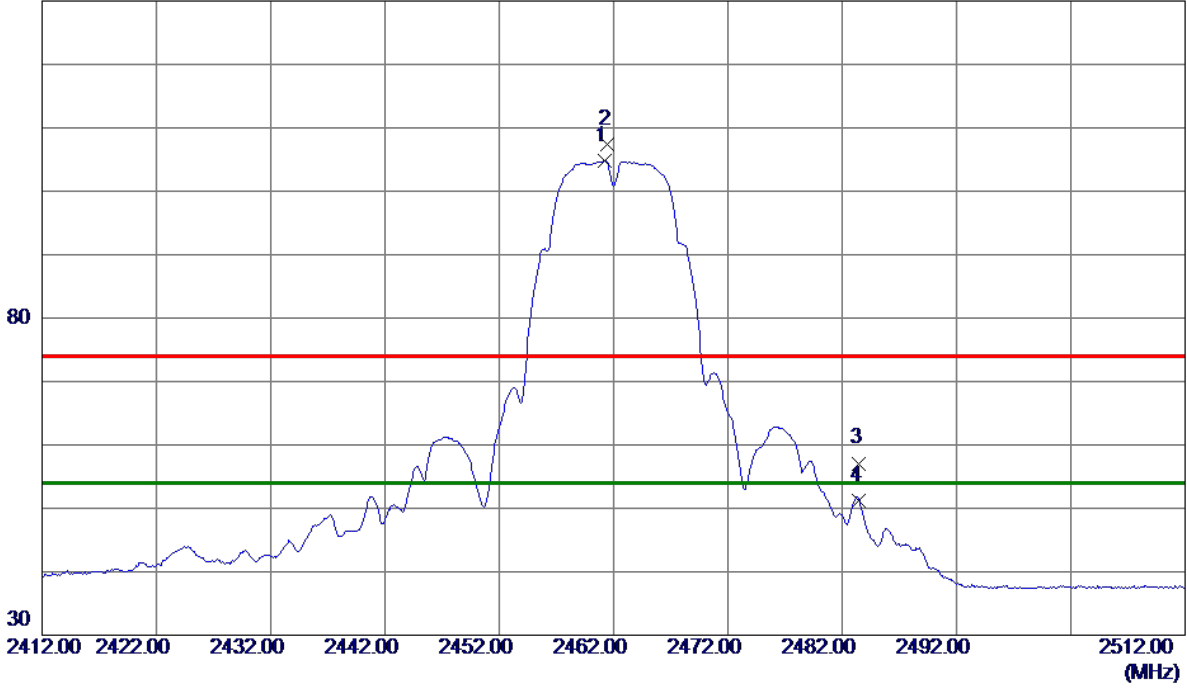

No.	Freq. MHz	Reading Level dBuV/m	Correct Factor dB	Measure ment dBuV/m	Limit dBuV/m	Margin dB	Detector	Comment
1 *	2461.2000	97.44	7.33	104.77	54.00	50.77	AVG	No Limit
2	2461.5000	100.15	7.33	107.48	74.00	33.48	Peak	No Limit
3	2483.5000	49.78	7.32	57.10	74.00	-16.90	Peak	
4	2483.5000	43.86	7.32	51.18	54.00	-2.82	AVG	

Orthogonal Axis	X
Test Mode:	TX G Mode 2412 MHz

Vertical

130 dBuV/m

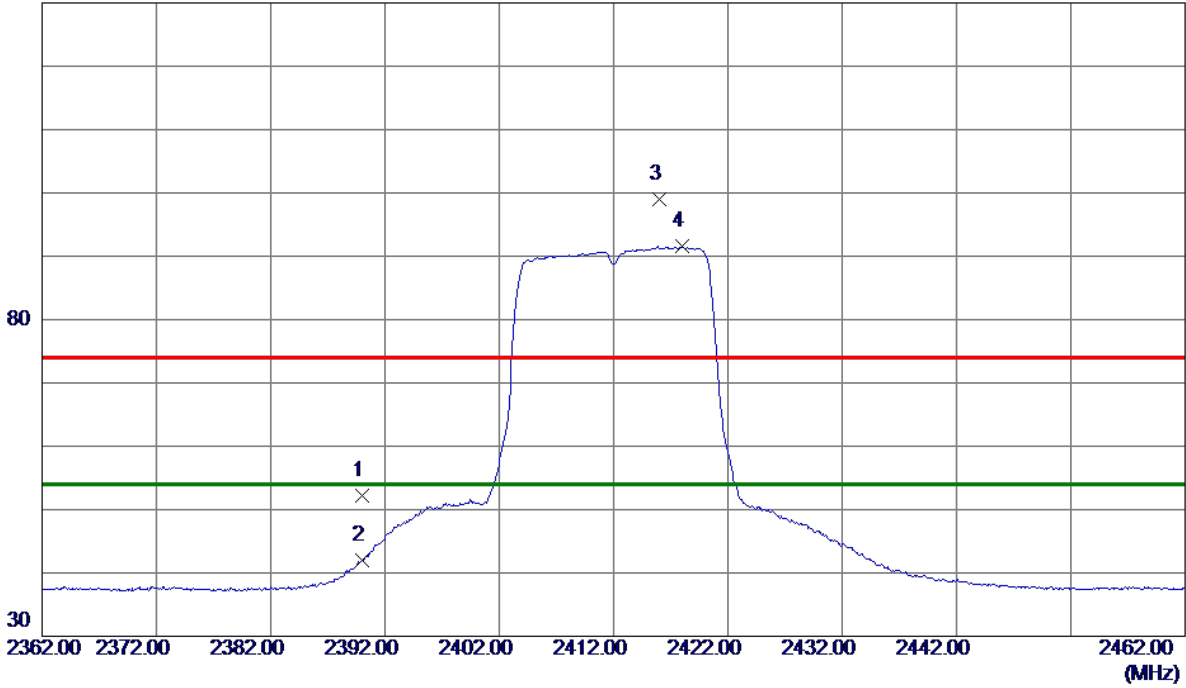

No.	Freq. MHz	Reading Level dBuV/m	Correct Factor dB	Measure ment dBuV/m	Limit dBuV/m	Margin dB	Detector	Comment
1	2390.0000	44.90	7.39	52.29	74.00	-21.71	Peak	
2	2390.0000	34.69	7.39	42.08	54.00	-11.92	AVG	
3	2416.0500	91.67	7.37	99.04	74.00	25.04	Peak	No Limit
4 *	2418.0500	84.15	7.37	91.52	54.00	37.52	AVG	No Limit

Orthogonal Axis	X
Test Mode:	TX G Mode 2412 MHz

Horizontal

130 dBuV/m

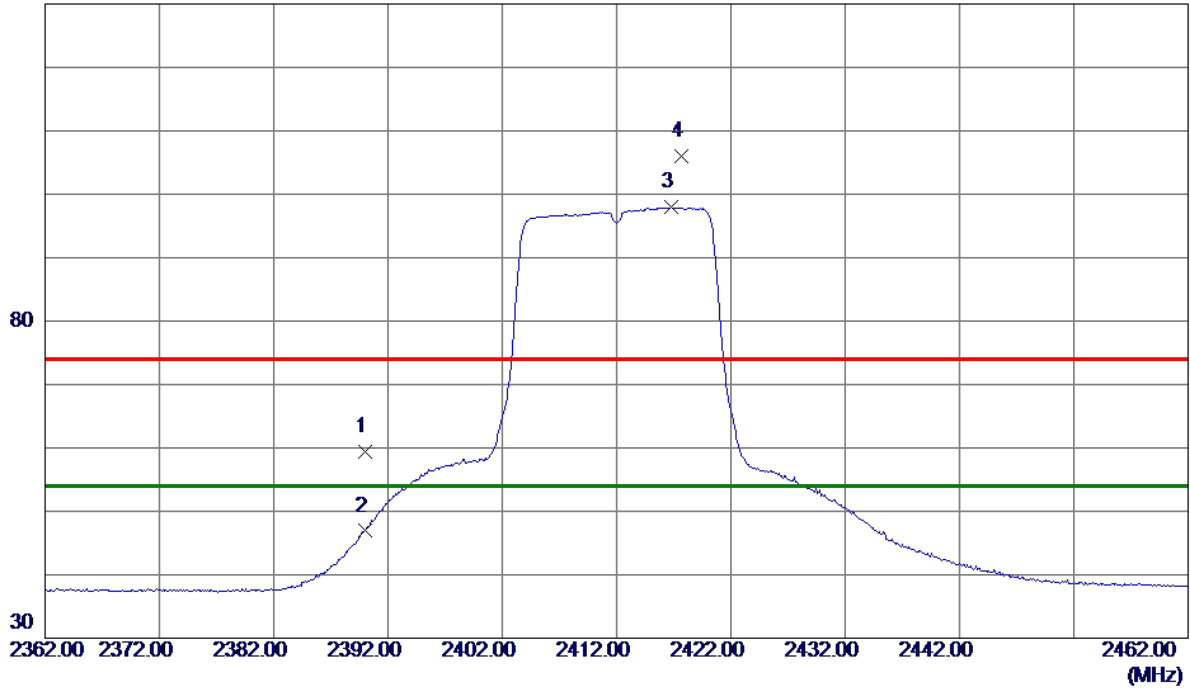

No.	Freq. MHz	Reading Level dBuV/m	Correct Factor dB	Measure ment dBuV/m	Limit dBuV/m	Margin dB	Detector	Comment
1	2390.0000	52.00	7.39	59.39	74.00	-14.61	Peak	
2	2390.0000	39.51	7.39	46.90	54.00	-7.10	AVG	
3 *	2416.8000	90.58	7.37	97.95	54.00	43.95	AVG	No Limit
4	2417.7000	98.53	7.37	105.90	74.00	31.90	Peak	No Limit

Orthogonal Axis	X
Test Mode:	TX G Mode 2437 MHz

Vertical

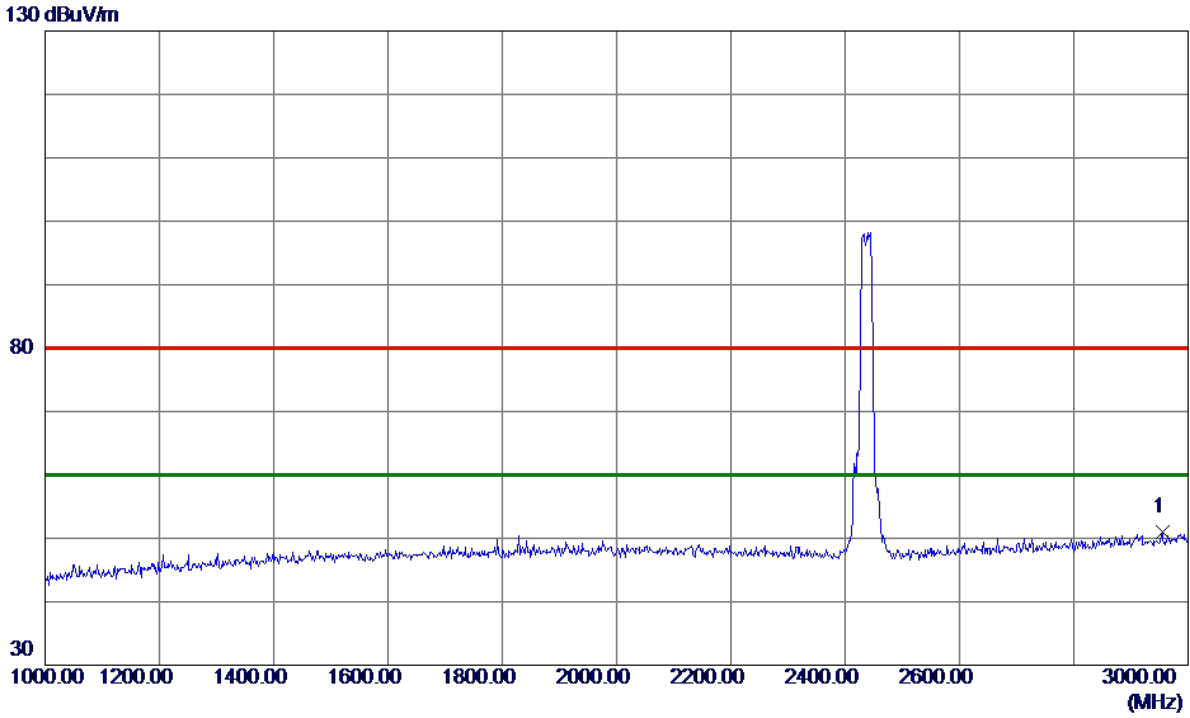

No.	Freq. MHz	Reading Level dBuV/m	Correct Factor dB	Measure ment dBuV/m	Limit dBuV/m	Margin dB	Detector	Comment
1 *	2955.0000	40.83	10.09	50.92	80.00	-29.08	Peak	

Orthogonal Axis	X
Test Mode:	TX G Mode 2437 MHz

Vertical

130 dBuV/m

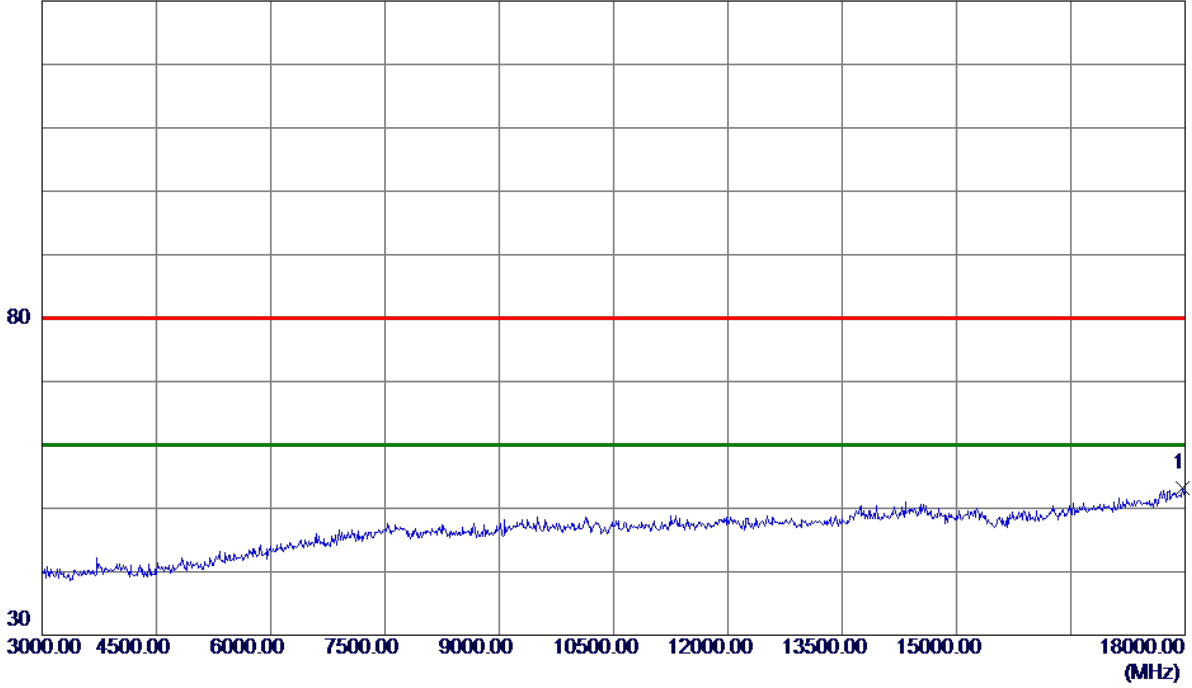

No.	Freq. MHz	Reading Level dBuV/m	Correct Factor dB	Measure ment dBuV/m	Limit dBuV/m	Margin dB	Detector	Comment
1 *	17970.0000	35.45	17.68	53.13	80.00	-26.87	Peak	

Orthogonal Axis	X
Test Mode:	TX G Mode 2437 MHz

Vertical

130 dBuV/m

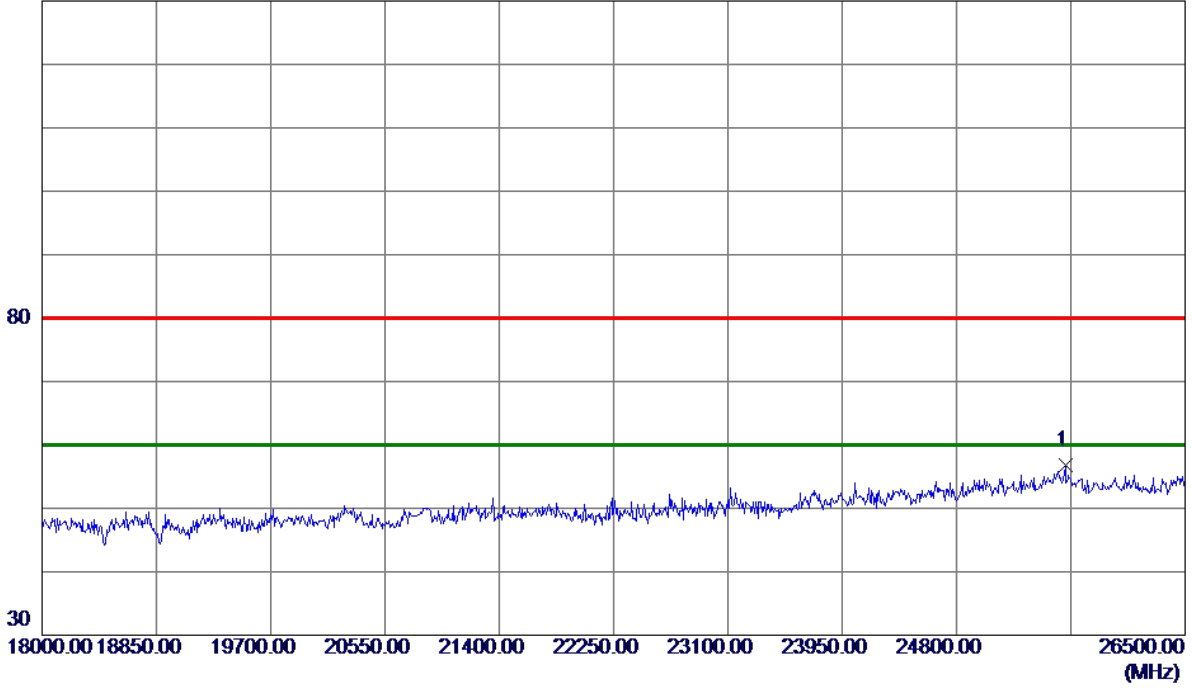

No.	Freq. MHz	Reading Level dBuV/m	Correct Factor dB	Measure ment dBuV/m	Limit dBuV/m	Margin dB	Detector	Comment
1 *	25611.7500	39.61	17.20	56.81	80.00	-23.19	Peak	

Orthogonal Axis	X
Test Mode:	TX G Mode 2437 MHz

Horizontal

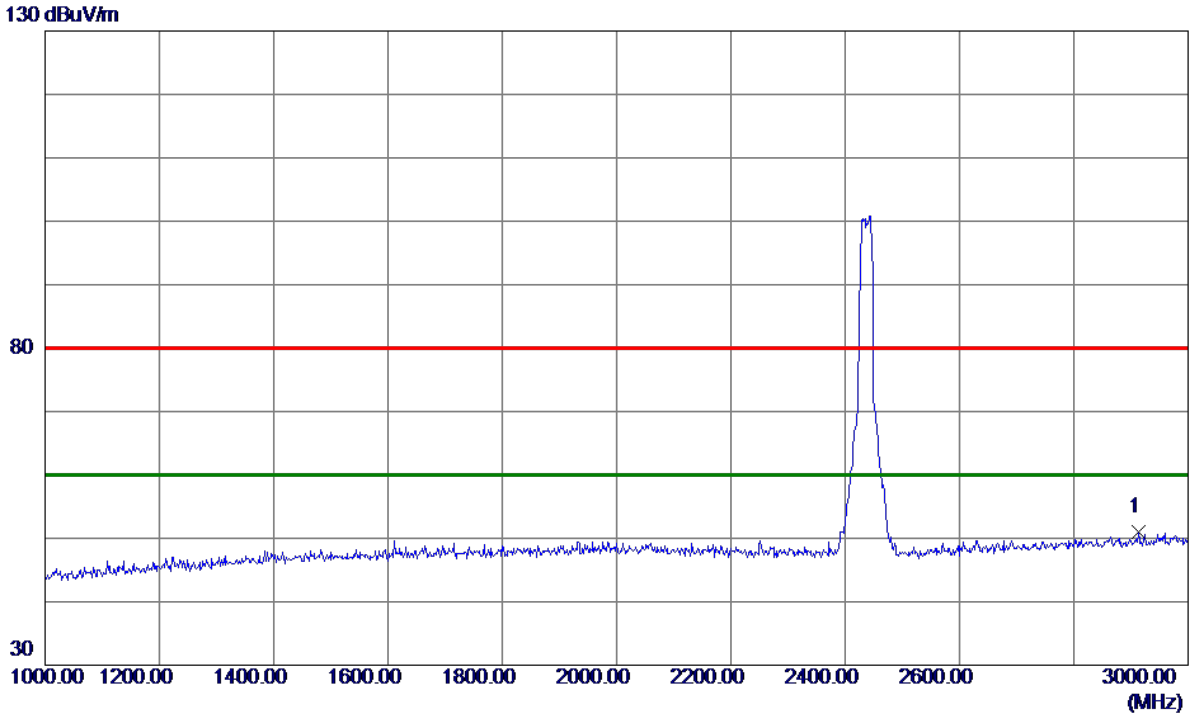

No.	Freq. MHz	Reading Level dBuV/m	Correct Factor dB	Measure ment dBuV/m	Limit dBuV/m	Margin dB	Detector	Comment
1 *	2913.0000	41.16	9.83	50.99	80.00	-29.01	Peak	

Orthogonal Axis	X
Test Mode:	TX G Mode 2437 MHz

Horizontal

130 dBuV/m

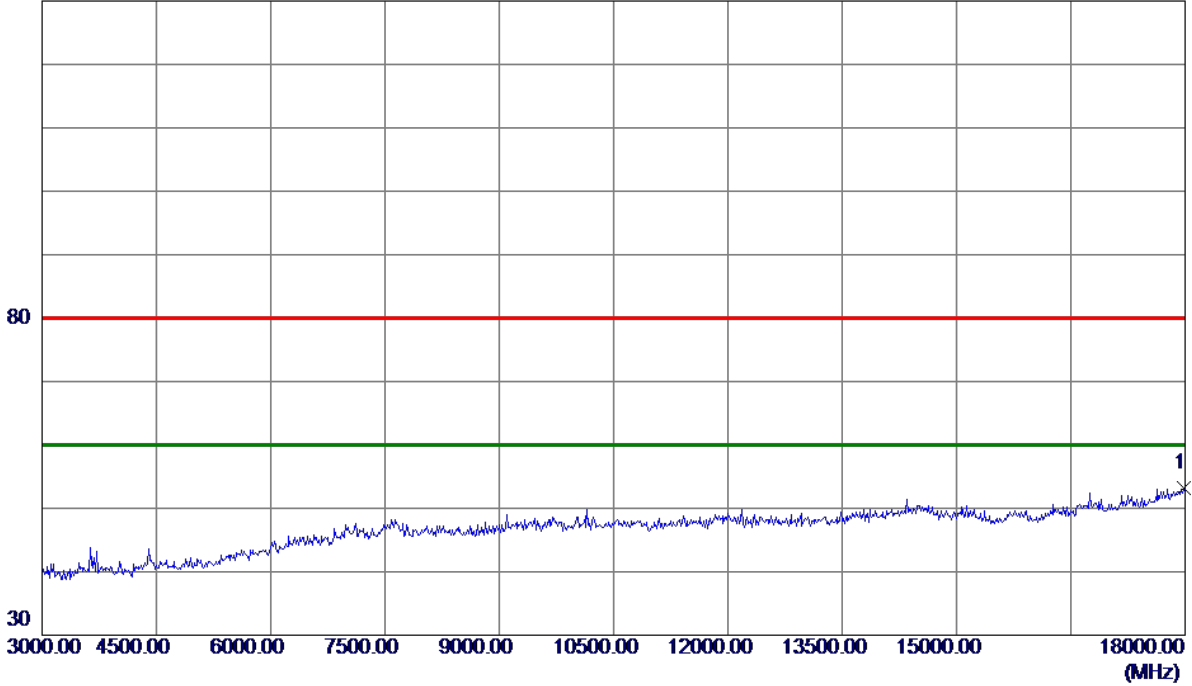

No.	Freq. MHz	Reading Level dBuV/m	Correct Factor dB	Measure ment dBuV/m	Limit dBuV/m	Margin dB	Detector	Comment
1 *	17985.0000	35.45	17.72	53.17	80.00	-26.83	Peak	

Orthogonal Axis	X
Test Mode:	TX G Mode 2437 MHz

Horizontal

130 dBuV/m

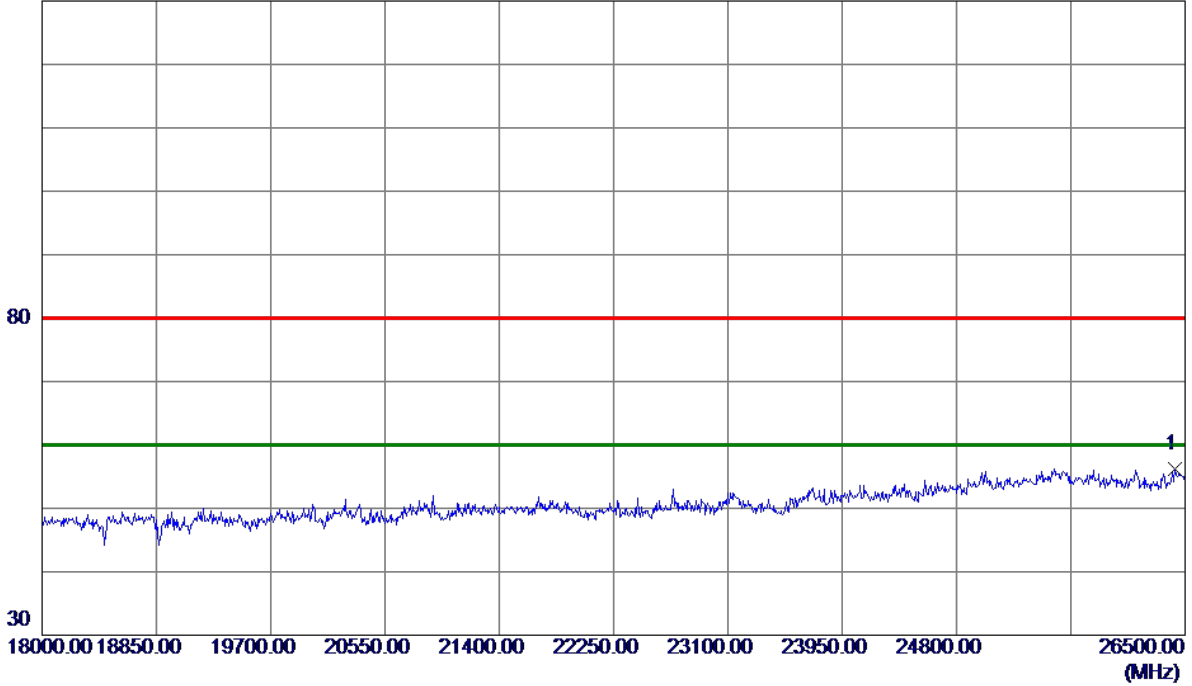

No.	Freq. MHz	Reading Level dBuV/m	Correct Factor dB	Measure ment dBuV/m	Limit dBuV/m	Margin dB	Detector	Comment
1 *	26427.7500	38.41	17.84	56.25	80.00	-23.75	Peak	

Orthogonal Axis	X
Test Mode:	TX G Mode 2462 MHz

Vertical

130 dBuV/m

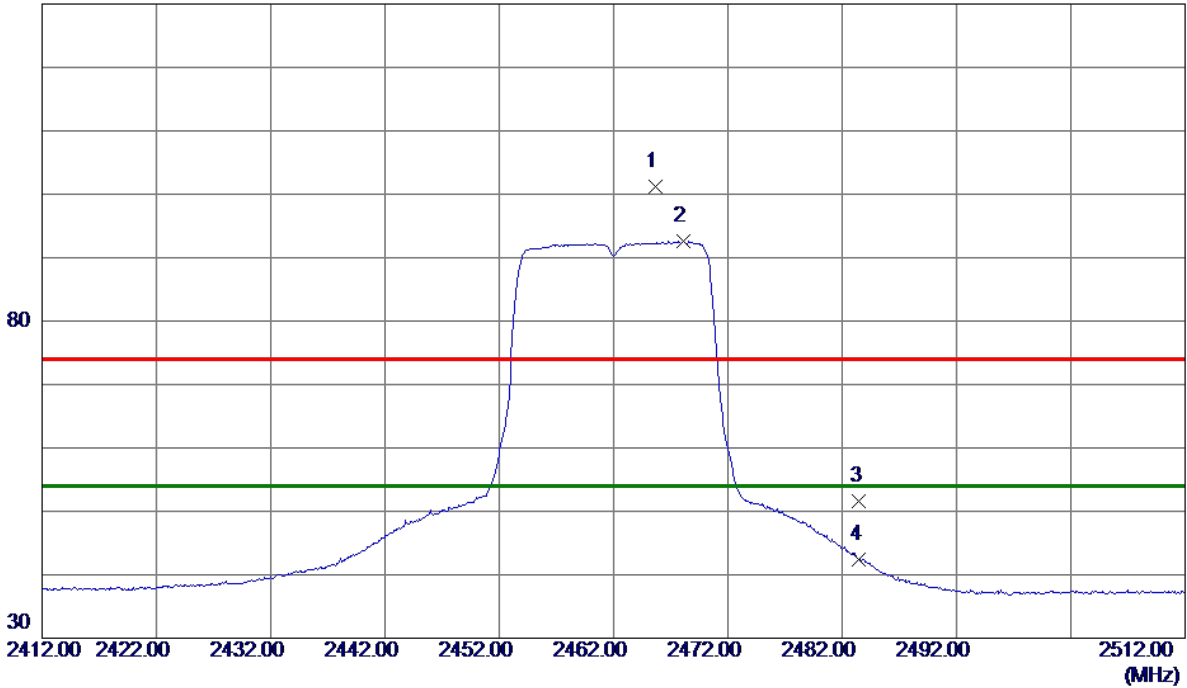

No.	Freq. MHz	Reading Level dBuV/m	Correct Factor dB	Measure ment dBuV/m	Limit dBuV/m	Margin dB	Detector	Comment
1	2465.6500	93.86	7.33	101.19	74.00	27.19	Peak	No Limit
2 *	2468.1500	85.23	7.33	92.56	54.00	38.56	AVG	No Limit
3	2483.5000	44.23	7.32	51.55	74.00	-22.45	Peak	
4	2483.5000	35.03	7.32	42.35	54.00	-11.65	AVG	

Orthogonal Axis	X
Test Mode:	TX G Mode 2462 MHz

Horizontal

130 dBuV/m

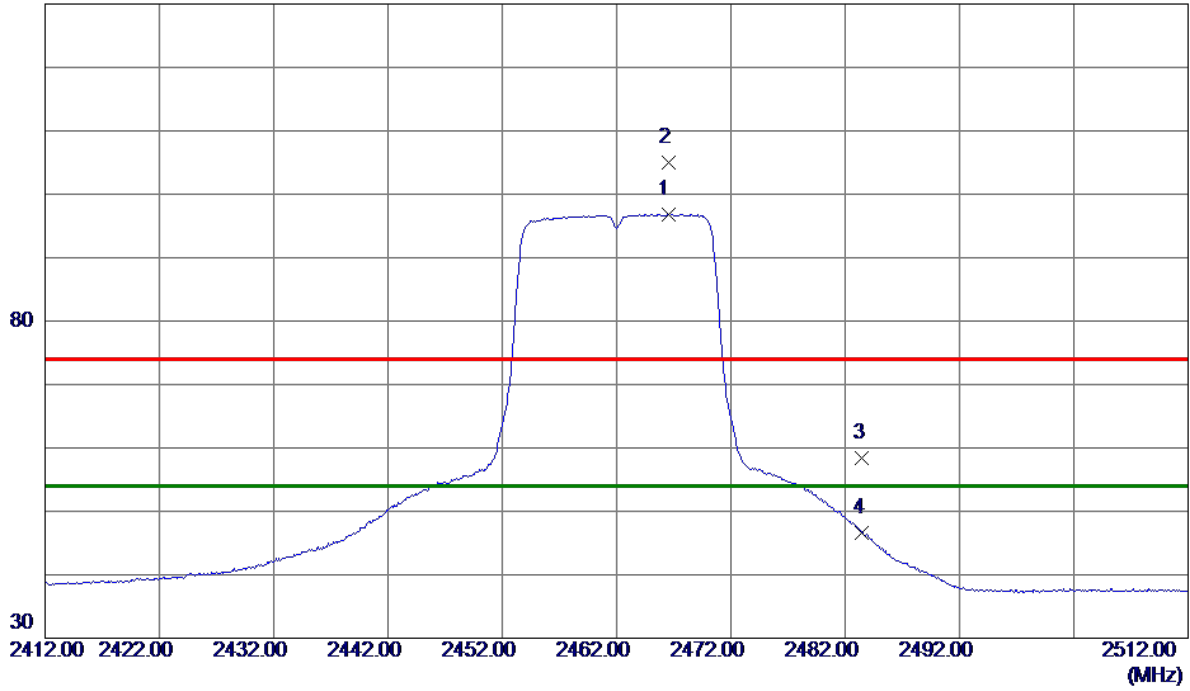

No.	Freq. MHz	Reading Level dBuV/m	Correct Factor dB	Measure ment dBuV/m	Limit dBuV/m	Margin dB	Detector	Comment
1 *	2466.5000	89.49	7.33	96.82	54.00	42.82	AVG	No Limit
2	2466.6000	97.64	7.33	104.97	74.00	30.97	Peak	No Limit
3	2483.5000	51.02	7.32	58.34	74.00	-15.66	Peak	
4	2483.5000	39.35	7.32	46.67	54.00	-7.33	AVG	

Orthogonal Axis	X
Test Mode:	TX N-20M Mode 2412 MHz

Vertical

130 dBuV/m

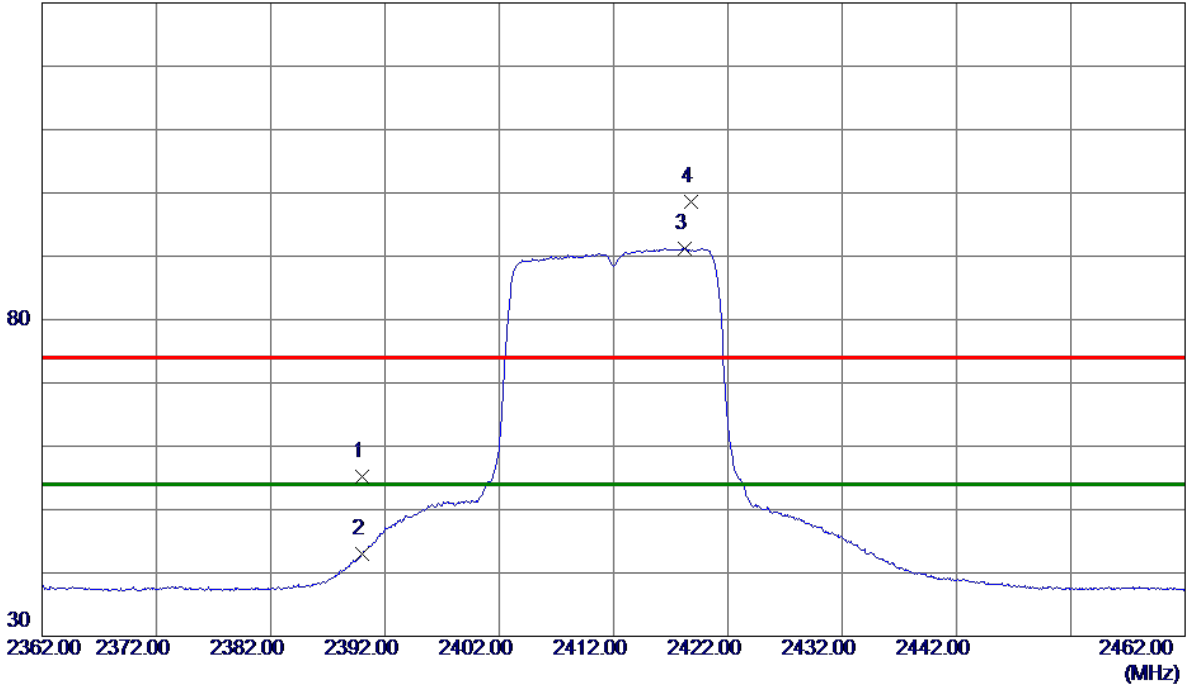

No.	Freq. MHz	Reading Level dBuV/m	Correct Factor dB	Measure ment dBuV/m	Limit dBuV/m	Margin dB	Detector	Comment
1	2390.0000	47.87	7.39	55.26	74.00	-18.74	Peak	
2	2390.0000	35.64	7.39	43.03	54.00	-10.97	AVG	
3 *	2418.2000	83.90	7.37	91.27	54.00	37.27	AVG	No Limit
4	2418.8000	91.27	7.37	98.64	74.00	24.64	Peak	No Limit

Orthogonal Axis	X
Test Mode:	TX N-20M Mode 2412 MHz

Horizontal

130 dBuV/m

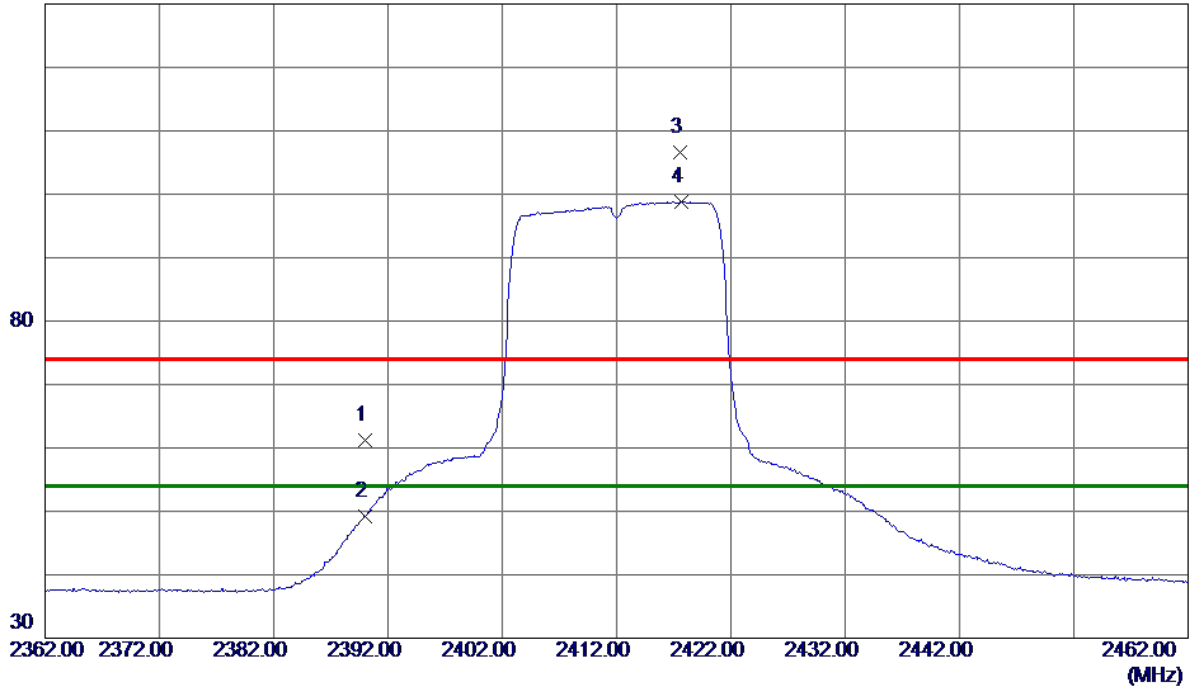

No.	Freq. MHz	Reading Level dBuV/m	Correct Factor dB	Measure ment dBuV/m	Limit dBuV/m	Margin dB	Detector	Comment
1	2390.0000	53.83	7.39	61.22	74.00	-12.78	Peak	
2	2390.0000	41.79	7.39	49.18	54.00	-4.82	AVG	
3	2417.6000	99.15	7.37	106.52	74.00	32.52	Peak	No Limit
4 *	2417.7000	91.45	7.37	98.82	54.00	44.82	AVG	No Limit

Orthogonal Axis	X
Test Mode:	TX N-20M Mode 2437 MHz

Vertical

130 dBuV/m

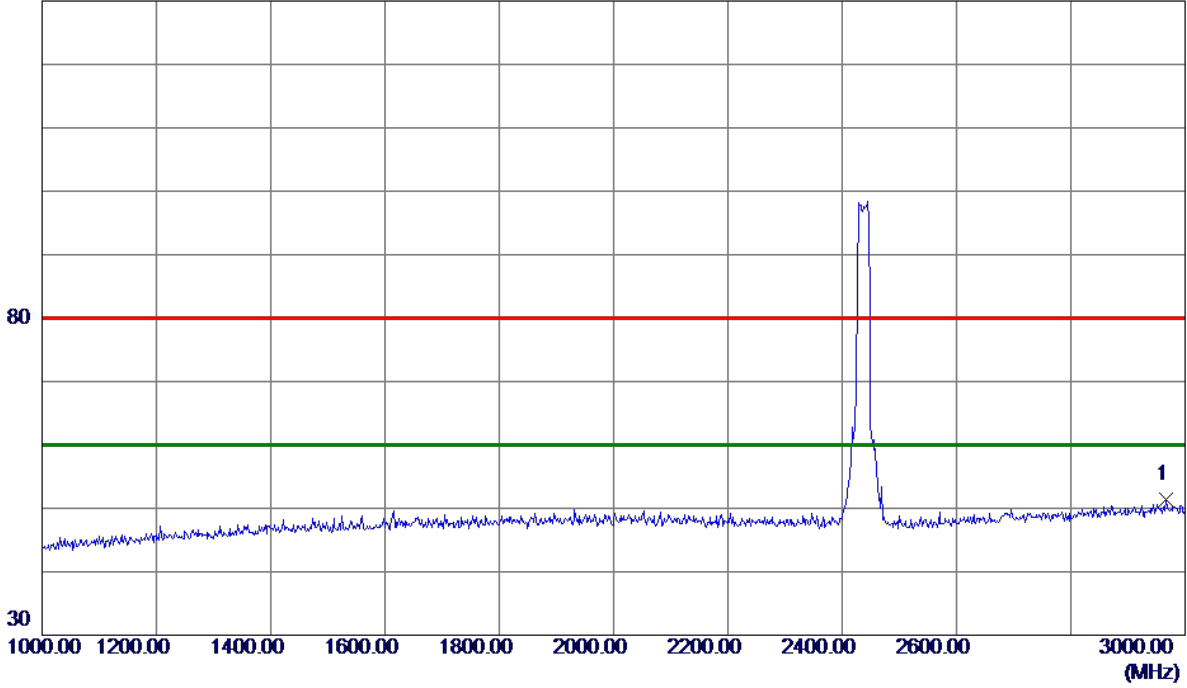

No.	Freq. MHz	Reading Level dBuV/m	Correct Factor dB	Measure ment dBuV/m	Limit dBuV/m	Margin dB	Detector	Comment
1 *	2967.0000	41.28	10.16	51.44	80.00	-28.56	Peak	

Orthogonal Axis	X
Test Mode:	TX N-20M Mode 2437 MHz

Vertical

130 dBuV/m

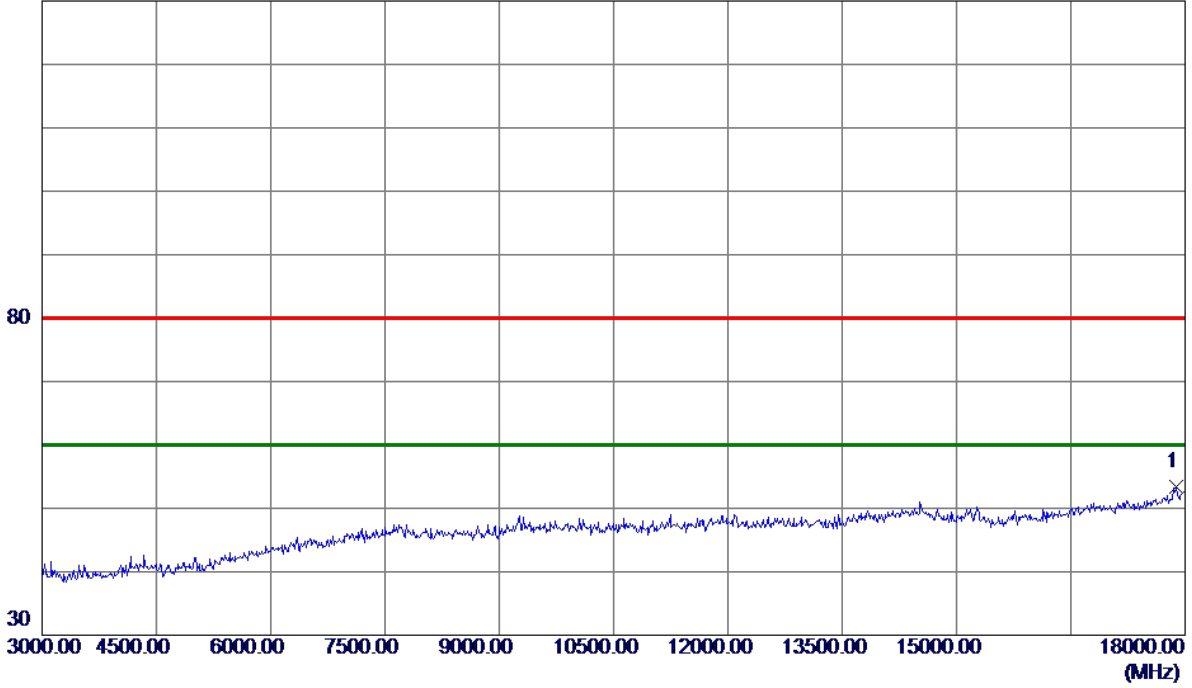

No.	Freq. MHz	Reading Level dBuV/m	Correct Factor dB	Measure ment dBuV/m	Limit dBuV/m	Margin dB	Detector	Comment
1 *	17880.0000	36.07	17.41	53.48	80.00	-26.52	Peak	

Orthogonal Axis	X
Test Mode:	TX N-20M Mode 2437 MHz

Vertical

130 dBuV/m

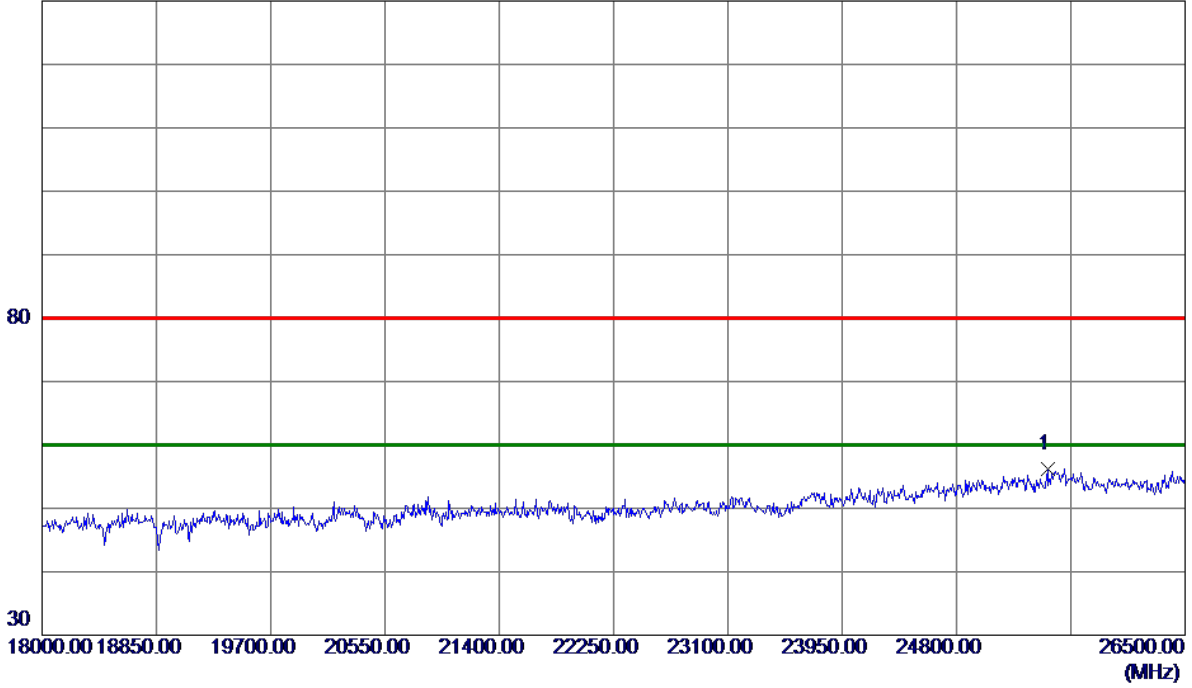

No.	Freq. MHz	Reading Level dBuV/m	Correct Factor dB	Measure ment dBuV/m	Limit dBuV/m	Margin dB	Detector	Comment
1 *	25475.7500	38.93	17.31	56.24	80.00	-23.76	Peak	

Orthogonal Axis	X
Test Mode:	TX N-20M Mode 2437 MHz

Horizontal

130 dBuV/m

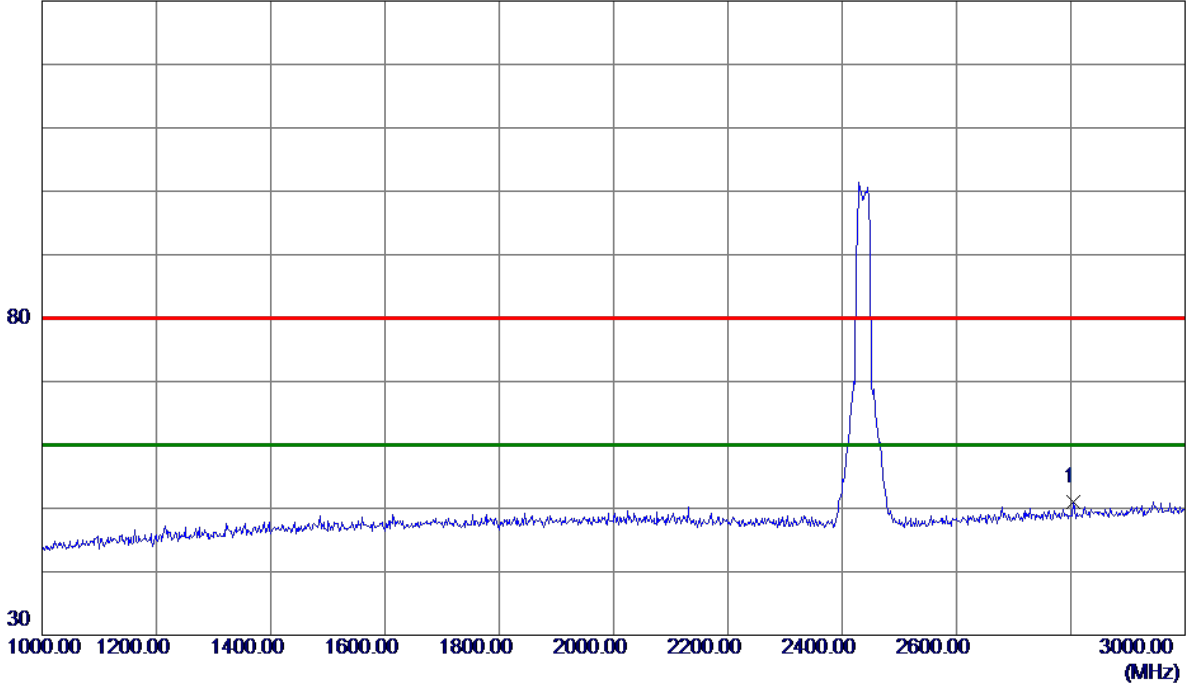

No.	Freq. MHz	Reading Level dBuV/m	Correct Factor dB	Measure ment dBuV/m	Limit dBuV/m	Margin dB	Detector	Comment
1 *	2805.0000	41.92	9.17	51.09	80.00	-28.91	Peak	

Orthogonal Axis	X
Test Mode:	TX N-20M Mode 2437 MHz

Horizontal

130 dBuV/m

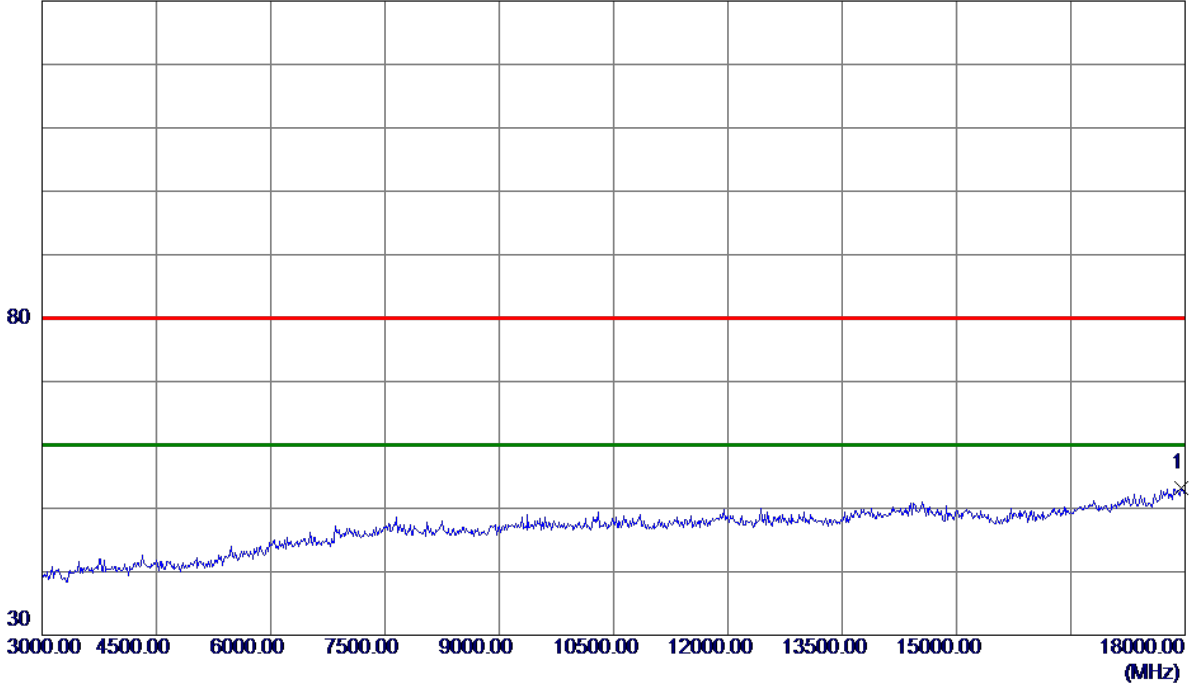

No.	Freq. MHz	Reading Level dBuV/m	Correct Factor dB	Measure ment dBuV/m	Limit dBuV/m	Margin dB	Detector	Comment
1 *	17955.0000	35.64	17.63	53.27	80.00	-26.73	Peak	

Orthogonal Axis	X
Test Mode:	TX N-20M Mode 2437 MHz

Horizontal

130 dBuV/m

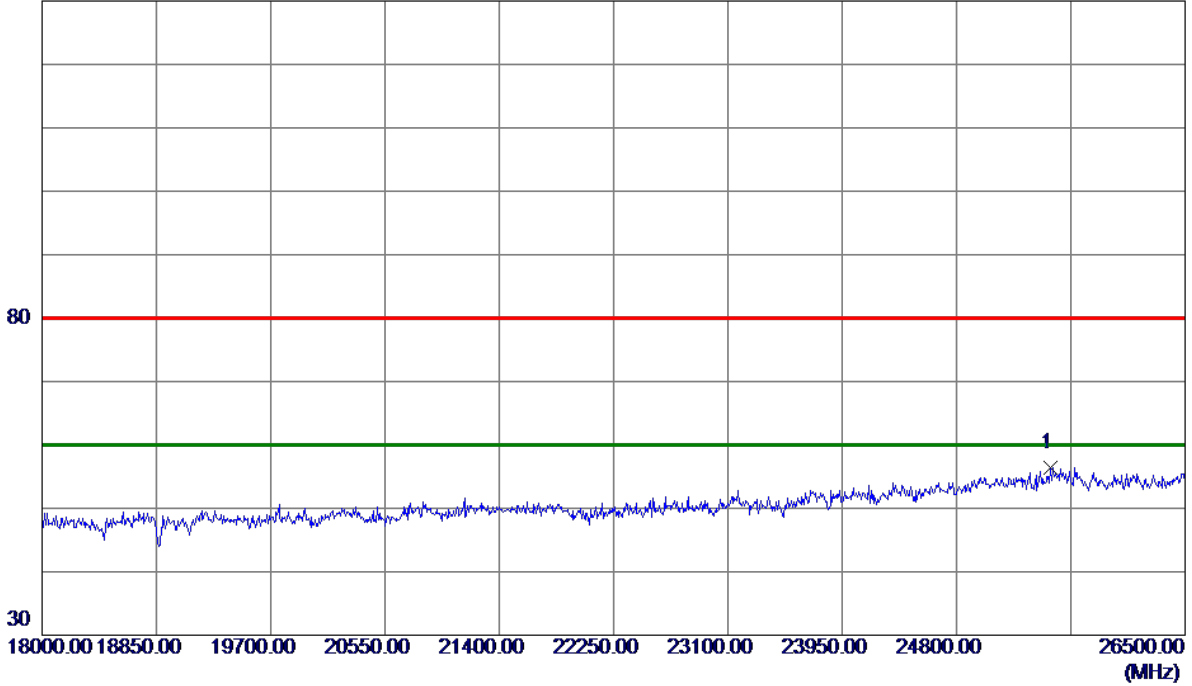

No.	Freq. MHz	Reading Level dBuV/m	Correct Factor dB	Measure ment dBuV/m	Limit dBuV/m	Margin dB	Detector	Comment
1 *	25497.0000	39.16	17.32	56.48	80.00	-23.52	Peak	

Orthogonal Axis	X
Test Mode:	TX N-20M Mode 2462 MHz

Vertical

130 dBuV/m

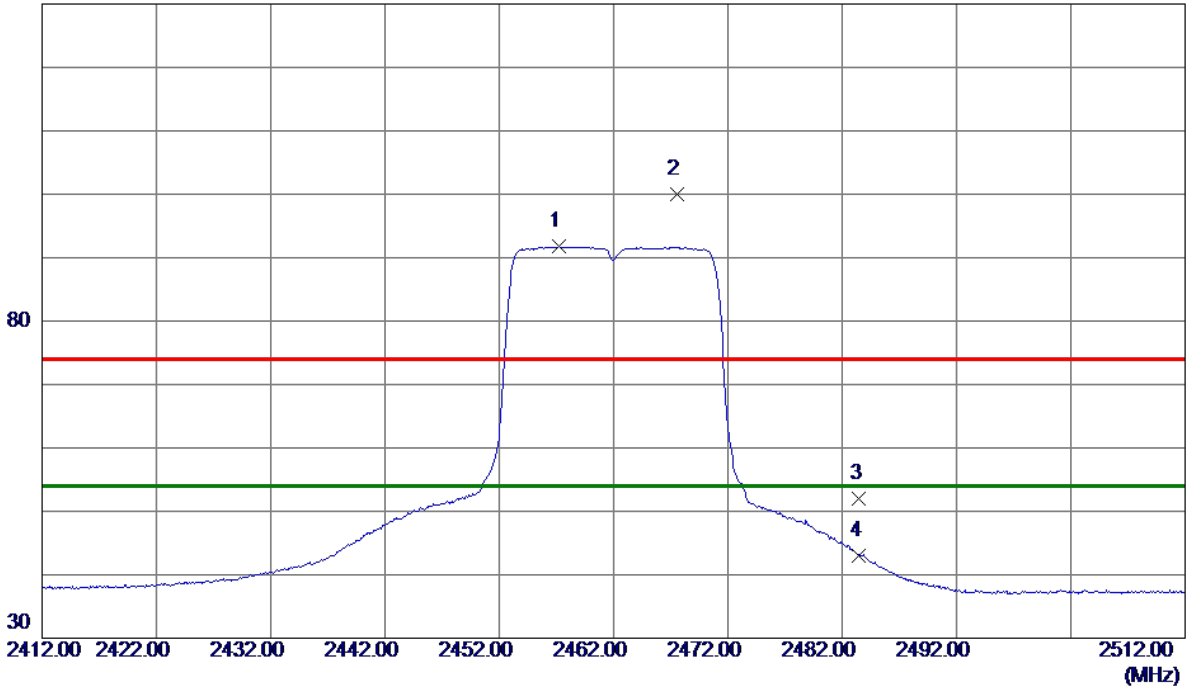

No.	Freq. MHz	Reading Level dBuV/m	Correct Factor dB	Measure ment dBuV/m	Limit dBuV/m	Margin dB	Detector	Comment
1 *	2457.2500	84.45	7.34	91.79	54.00	37.79	AVG	No Limit
2	2467.5500	92.69	7.33	100.02	74.00	26.02	Peak	No Limit
3	2483.5000	44.60	7.32	51.92	74.00	-22.08	Peak	
4	2483.5000	35.60	7.32	42.92	54.00	-11.08	AVG	

Orthogonal Axis	X
Test Mode:	TX N-20M Mode 2462 MHz

Horizontal

130 dBuV/m

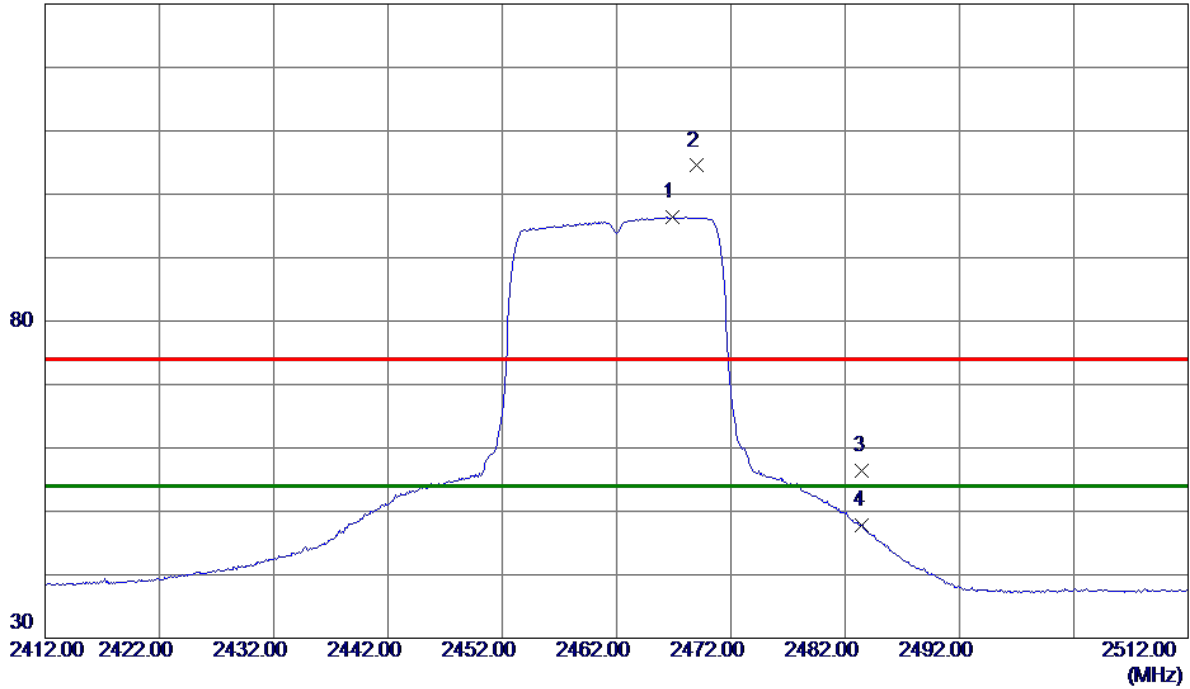

No.	Freq. MHz	Reading Level dBuV/m	Correct Factor dB	Measure ment dBuV/m	Limit dBuV/m	Margin dB	Detector	Comment
1 *	2466.9000	89.06	7.33	96.39	54.00	42.39	AVG	No Limit
2	2469.0000	97.17	7.33	104.50	74.00	30.50	Peak	No Limit
3	2483.5000	49.17	7.32	56.49	74.00	-17.51	Peak	
4	2483.5000	40.52	7.32	47.84	54.00	-6.16	AVG	

Orthogonal Axis	X
Test Mode:	TX N-40M Mode 2422MHz

Vertical

130 dBuV/m

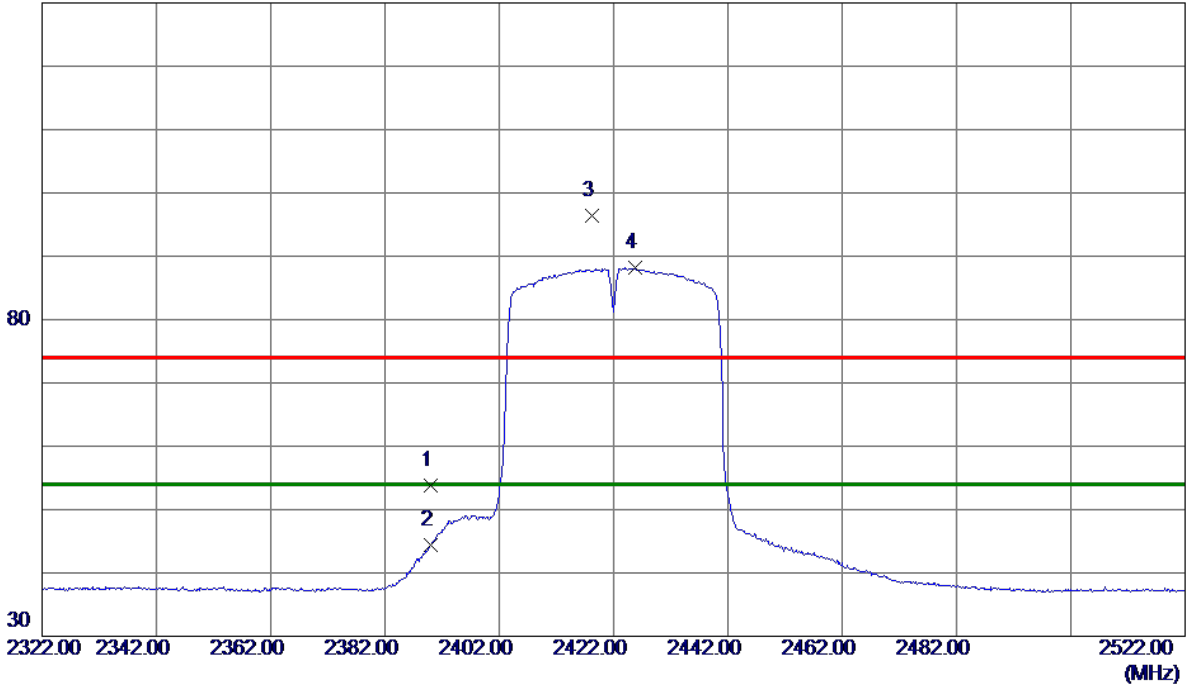

No.	Freq. MHz	Reading Level dBuV/m	Correct Factor dB	Measure ment dBuV/m	Limit dBuV/m	Margin dB	Detector	Comment
1	2390.0000	46.37	7.39	53.76	74.00	-20.24	Peak	
2	2390.0000	36.98	7.39	44.37	54.00	-9.63	AVG	
3	2418.2000	88.95	7.37	96.32	74.00	22.32	Peak	No Limit
4 *	2425.7000	80.86	7.36	88.22	54.00	34.22	AVG	No Limit

Orthogonal Axis	X
Test Mode:	TX N-40M Mode 2422MHz

Horizontal

130 dBuV/m

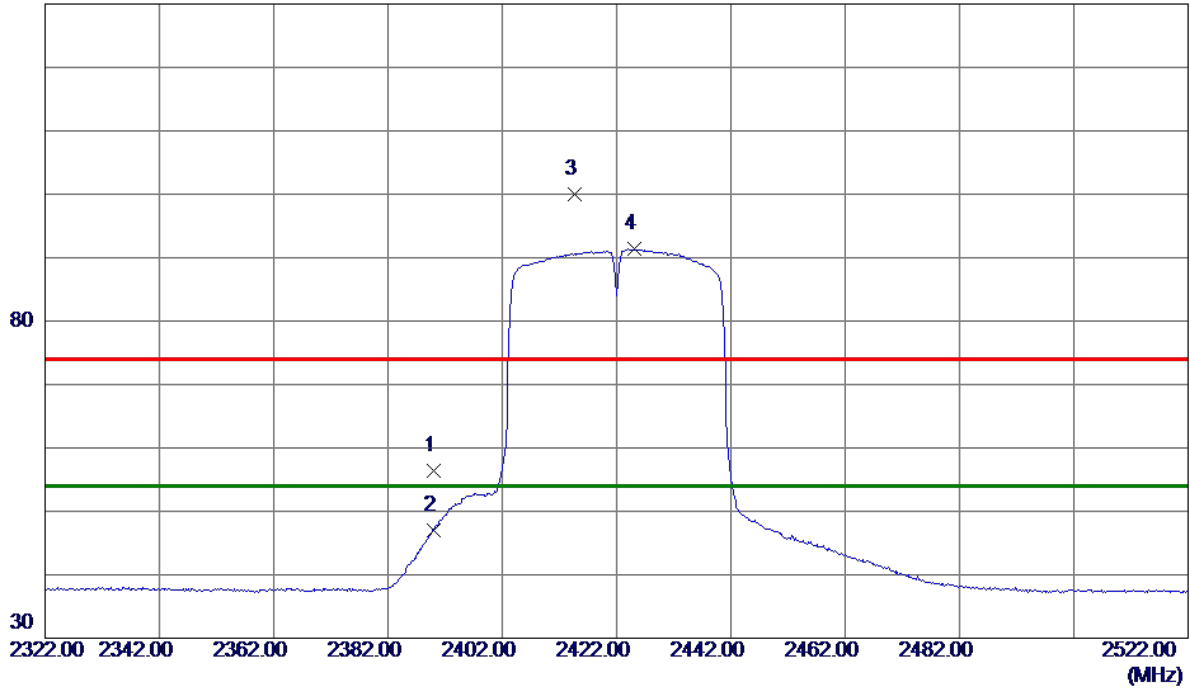

No.	Freq. MHz	Reading Level dBuV/m	Correct Factor dB	Measure ment dBuV/m	Limit dBuV/m	Margin dB	Detector	Comment
1	2390.0000	48.96	7.39	56.35	74.00	-17.65	Peak	
2	2390.0000	39.68	7.39	47.07	54.00	-6.93	AVG	
3	2414.6000	92.65	7.37	100.02	74.00	26.02	Peak	No Limit
4 *	2425.2000	83.95	7.36	91.31	54.00	37.31	AVG	No Limit

Orthogonal Axis	X
Test Mode:	TX N-40M Mode 2437 MHz

Vertical

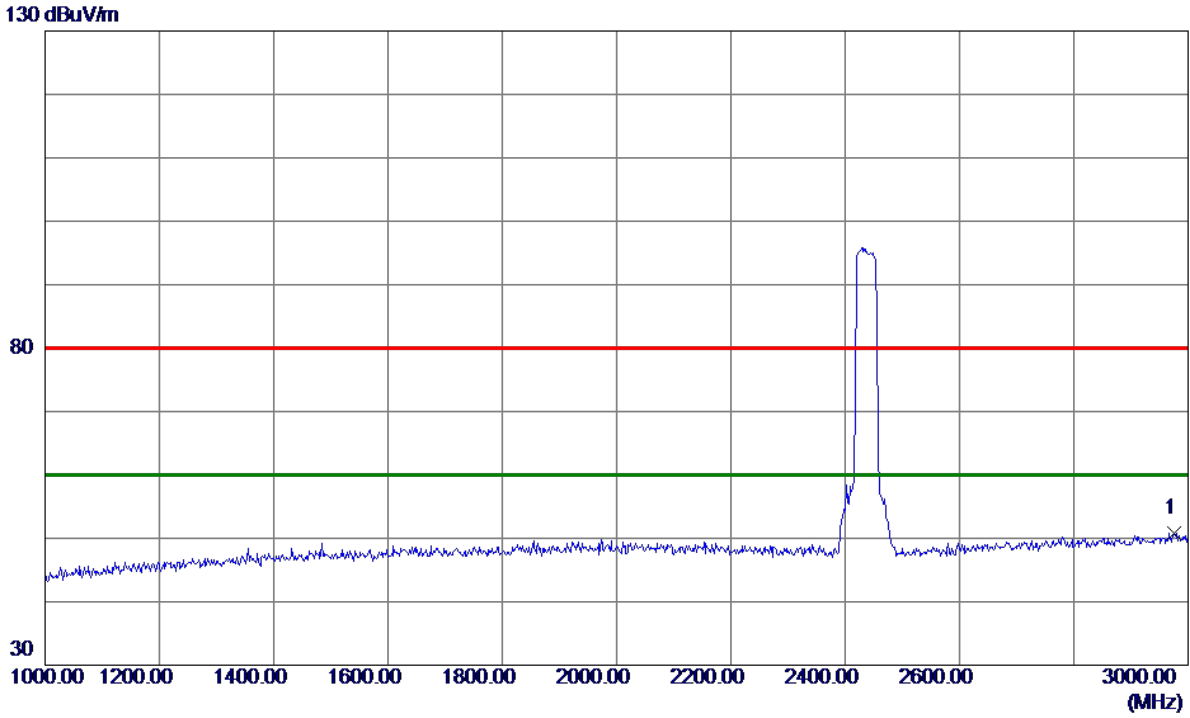

No.	Freq. MHz	Reading Level dBuV/m	Correct Factor dB	Measure ment dBuV/m	Limit dBuV/m	Margin dB	Detector	Comment
1 *	2975.0000	40.57	10.21	50.78	80.00	-29.22	Peak	

Orthogonal Axis	X
Test Mode:	TX N-40M Mode 2437 MHz

Vertical

130 dBuV/m

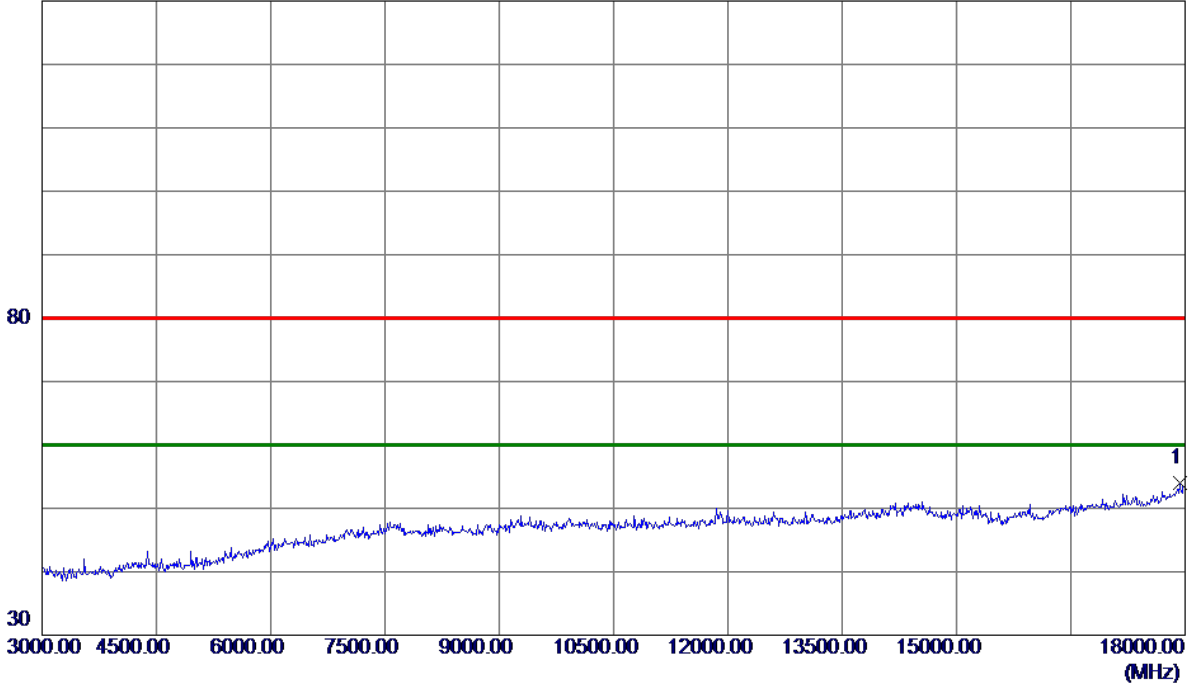

No.	Freq. MHz	Reading Level dBuV/m	Correct Factor dB	Measure ment dBuV/m	Limit dBuV/m	Margin dB	Detector	Comment
1 *	17932.5000	36.48	17.57	54.05	80.00	-25.95	Peak	

Orthogonal Axis	X
Test Mode:	TX N-40M Mode 2437 MHz

Vertical

130 dBuV/m

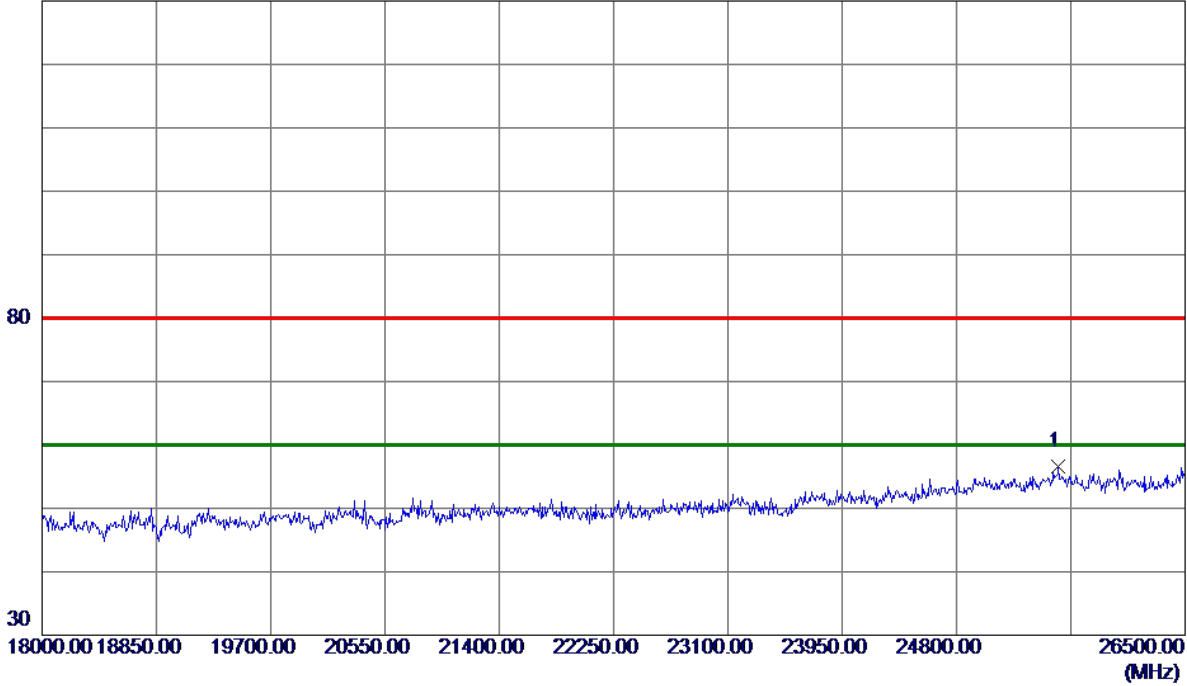

No.	Freq. MHz	Reading Level dBuV/m	Correct Factor dB	Measure ment dBuV/m	Limit dBuV/m	Margin dB	Detector	Comment
1 *	25556.5000	39.26	17.26	56.52	80.00	-23.48	Peak	

Orthogonal Axis	X
Test Mode:	TX N-40M Mode 2437 MHz

Horizontal

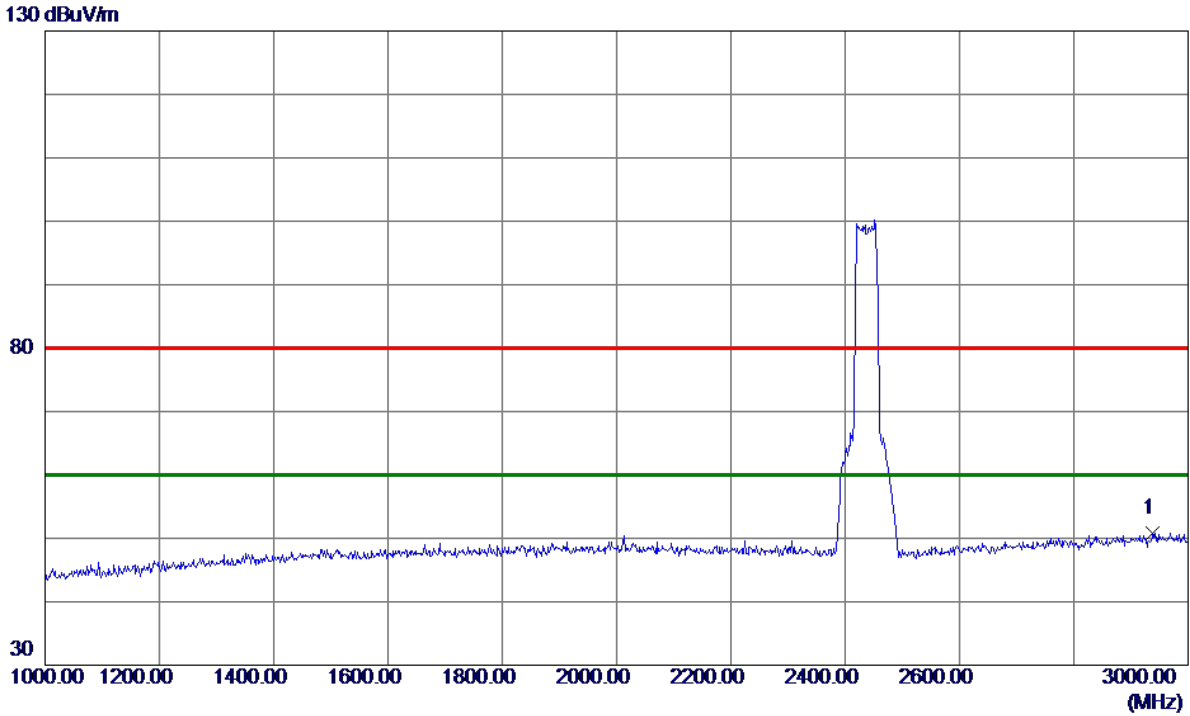

No.	Freq. MHz	Reading Level dBuV/m	Correct Factor dB	Measure ment dBuV/m	Limit dBuV/m	Margin dB	Detector	Comment
1 *	2938.0000	40.86	9.98	50.84	80.00	-29.16	Peak	

Orthogonal Axis	X
Test Mode:	TX N-40M Mode 2437 MHz

Horizontal

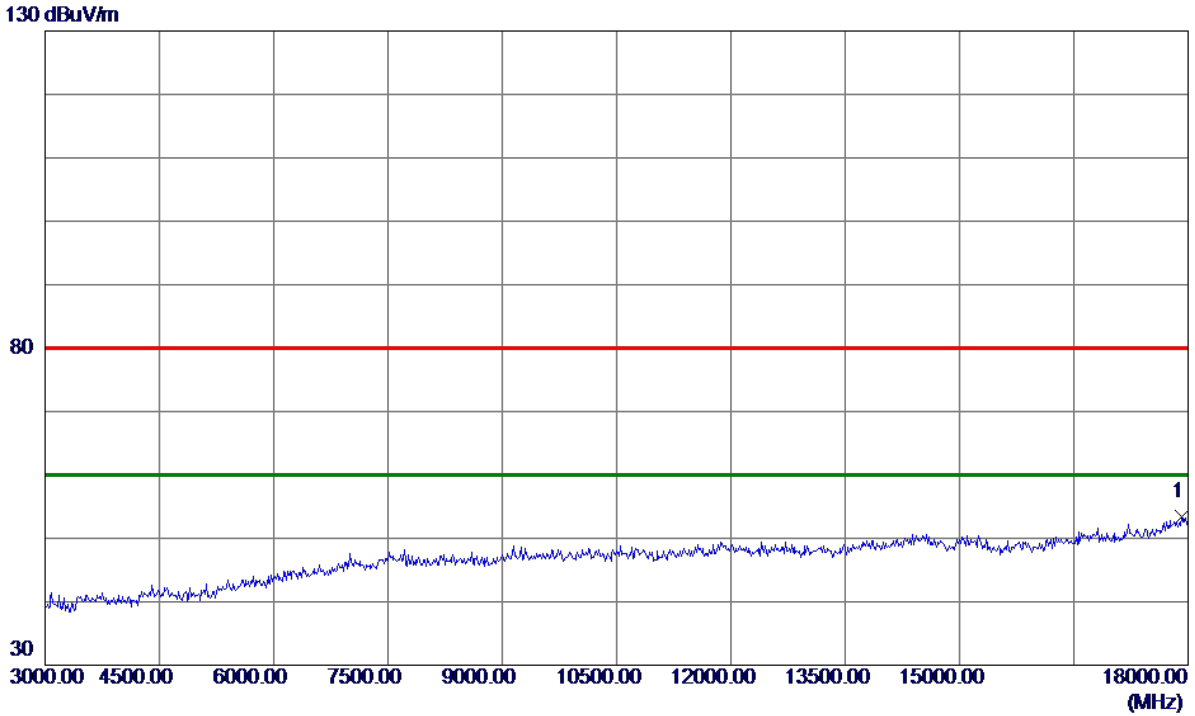

No.	Freq. MHz	Reading Level dBuV/m	Correct Factor dB	Measure ment dBuV/m	Limit dBuV/m	Margin dB	Detector	Comment
1 *	17910.0000	35.88	17.50	53.38	80.00	-26.62	Peak	

Orthogonal Axis	X
Test Mode:	TX N-40M Mode 2437 MHz

Horizontal

130 dBuV/m

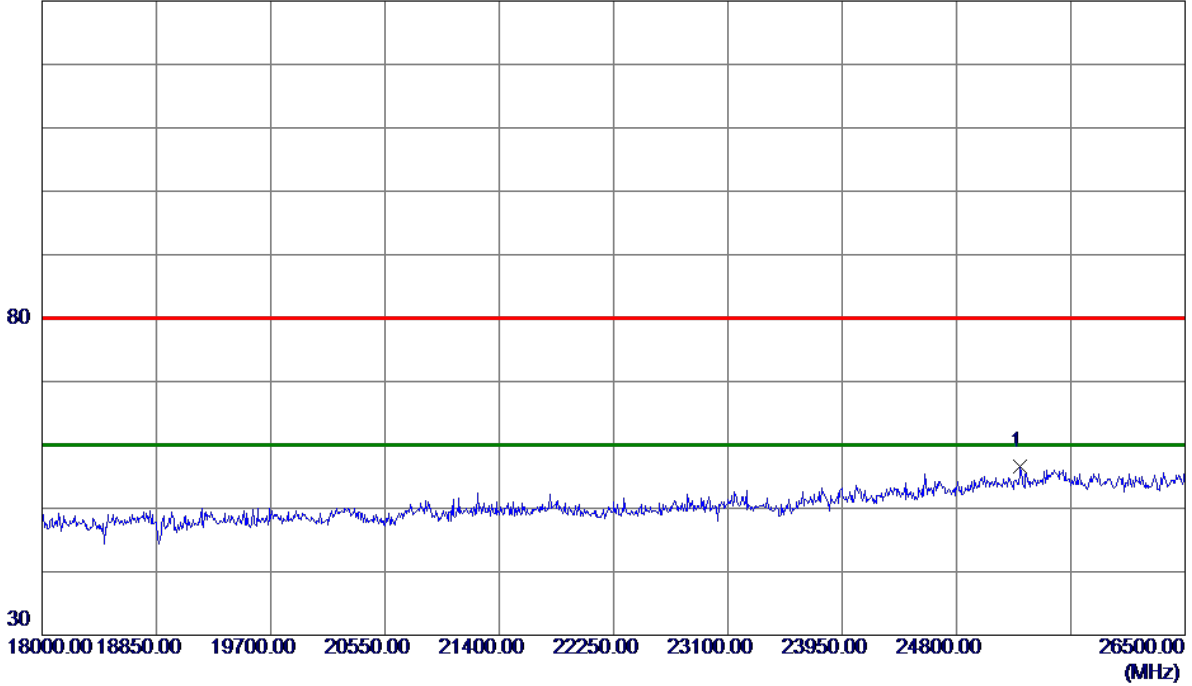

No.	Freq. MHz	Reading Level dBuV/m	Correct Factor dB	Measure ment dBuV/m	Limit dBuV/m	Margin dB	Detector	Comment
1 *	25276.0000	39.48	17.19	56.67	80.00	-23.33	Peak	

Orthogonal Axis	X
Test Mode:	TX N-40M Mode 2452MHz

Vertical

130 dBuV/m

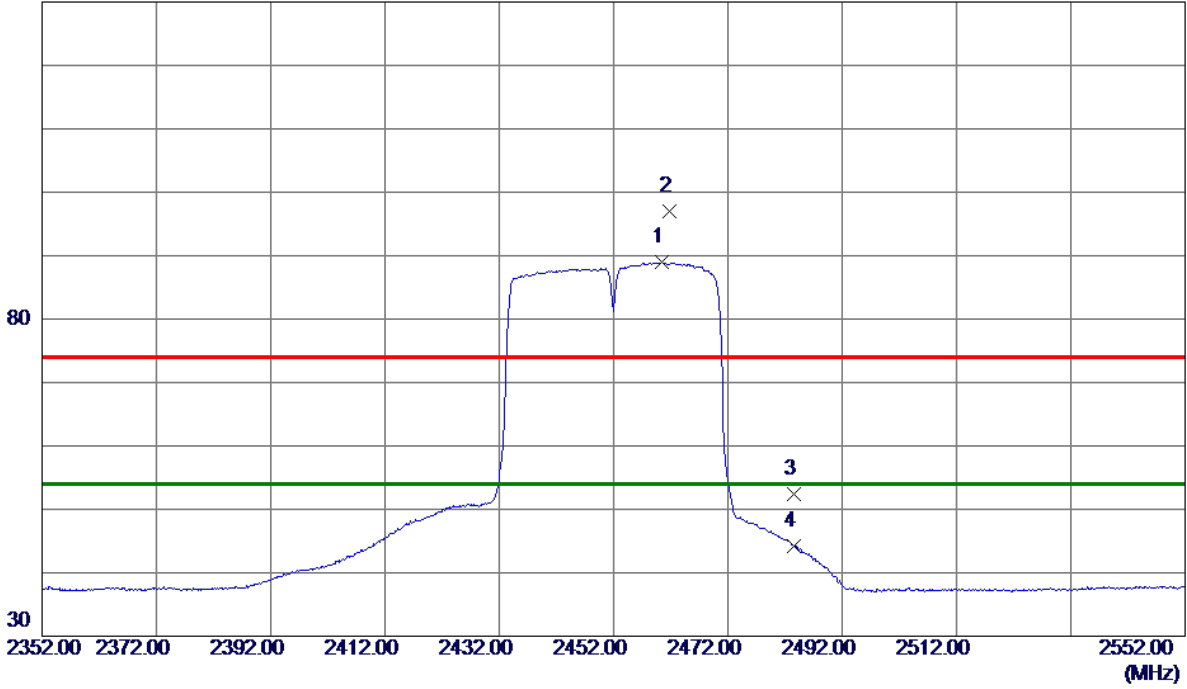

No.	Freq. MHz	Reading Level dBuV/m	Correct Factor dB	Measure ment dBuV/m	Limit dBuV/m	Margin dB	Detector	Comment
1 *	2460.5000	81.57	7.33	88.90	54.00	34.90	AVG	No Limit
2	2461.7000	89.70	7.33	97.03	74.00	23.03	Peak	No Limit
3	2483.5000	45.09	7.32	52.41	74.00	-21.59	Peak	
4	2483.5000	36.95	7.32	44.27	54.00	-9.73	AVG	

Orthogonal Axis	X
Test Mode:	TX N-40M Mode 2452MHz

Horizontal

130 dBuV/m

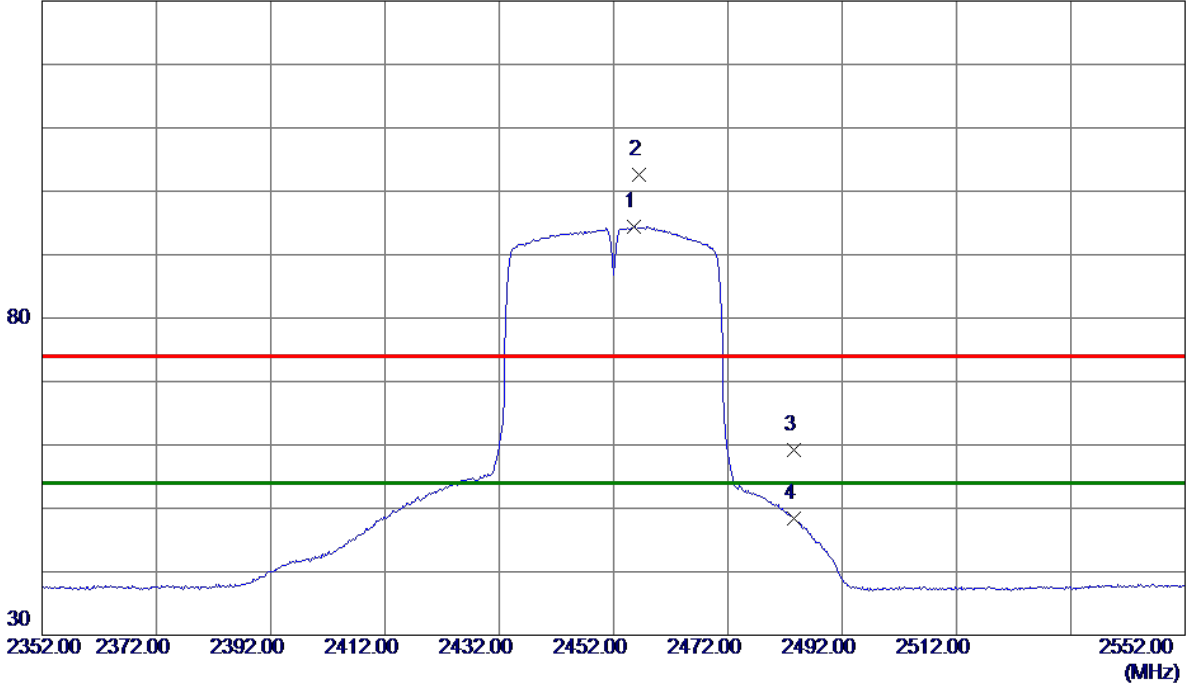

No.	Freq. MHz	Reading Level dBuV/m	Correct Factor dB	Measure ment dBuV/m	Limit dBuV/m	Margin dB	Detector	Comment
1 *	2455.6000	87.07	7.34	94.41	54.00	40.41	AVG	No Limit
2	2456.4000	95.29	7.34	102.63	74.00	28.63	Peak	No Limit
3	2483.5000	51.83	7.32	59.15	74.00	-14.85	Peak	
4	2483.5000	41.04	7.32	48.36	54.00	-5.64	AVG	

APPENDIX E - BANDWIDTH

Test Mode: TX B Mode_CH01/06/11

Frequency (MHz)	6 dB Bandwidth (MHz)	99% Occupied BW (MHz)	Min. Limit (kHz)	Test Result
2412	8.59	10.72	500	Complies
2437	8.59	10.64	500	Complies
2462	8.62	10.64	500	Complies

TX CH01

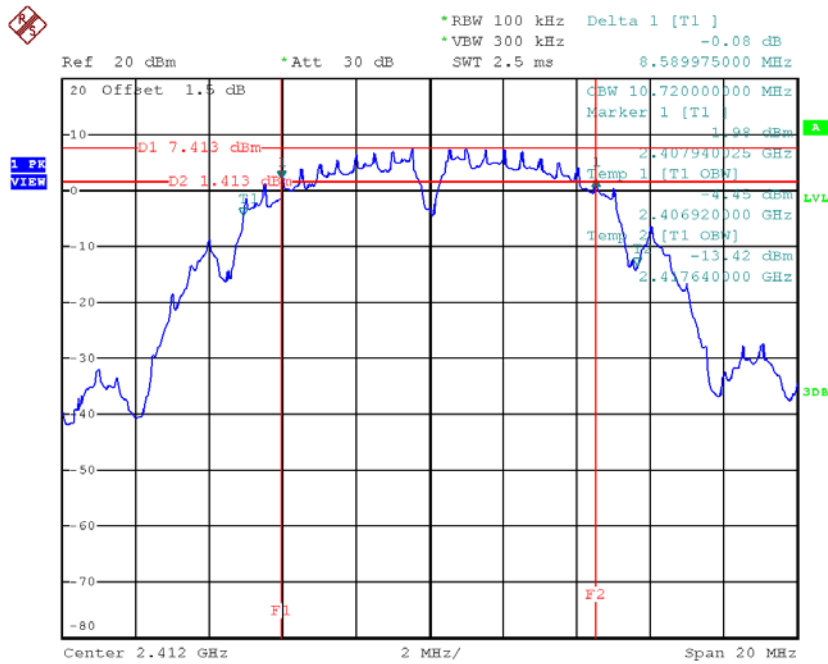

Date: 30.AUG.2018 10:14:40

TX CH06

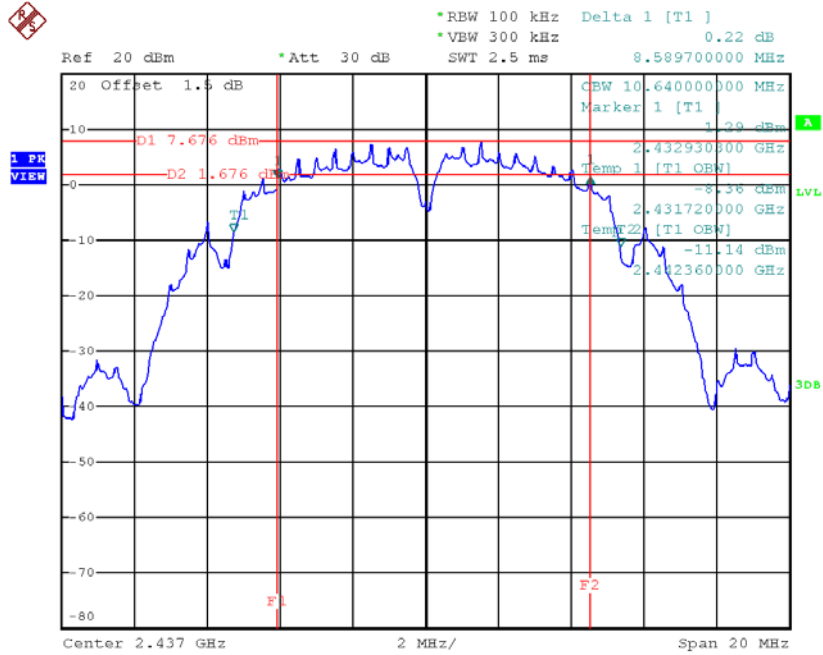

Date: 30.AUG.2018 09:53:34

TX CH11

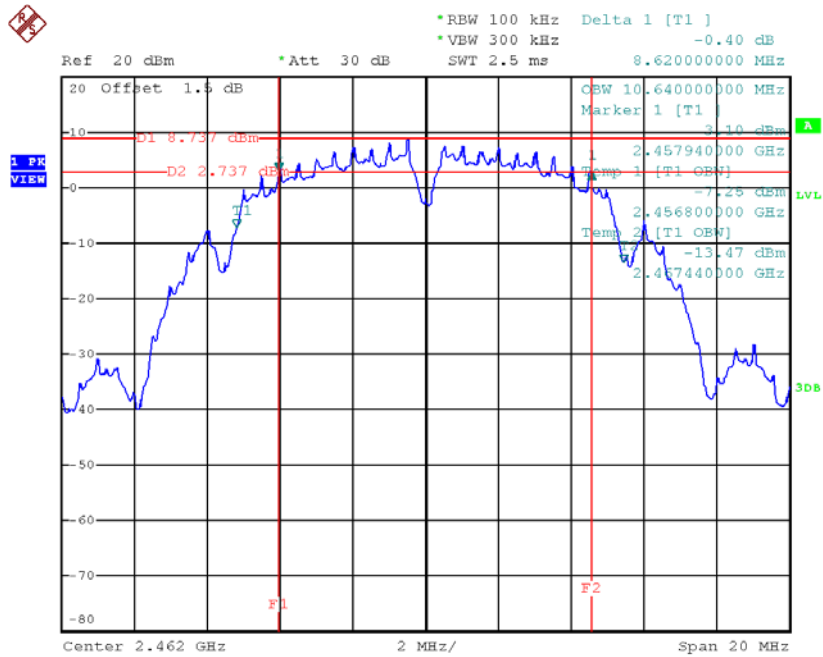

Date: 30.AUG.2018 09:55:08

Test Mode: TX G Mode_CH01/06/11

Frequency (MHz)	6 dB Bandwidth (MHz)	99% Occupied BW (MHz)	Min. Limit (kHz)	Test Result
2412	15.78	16.44	500	Complies
2437	16.45	16.44	500	Complies
2462	16.44	16.44	500	Complies

TX CH01

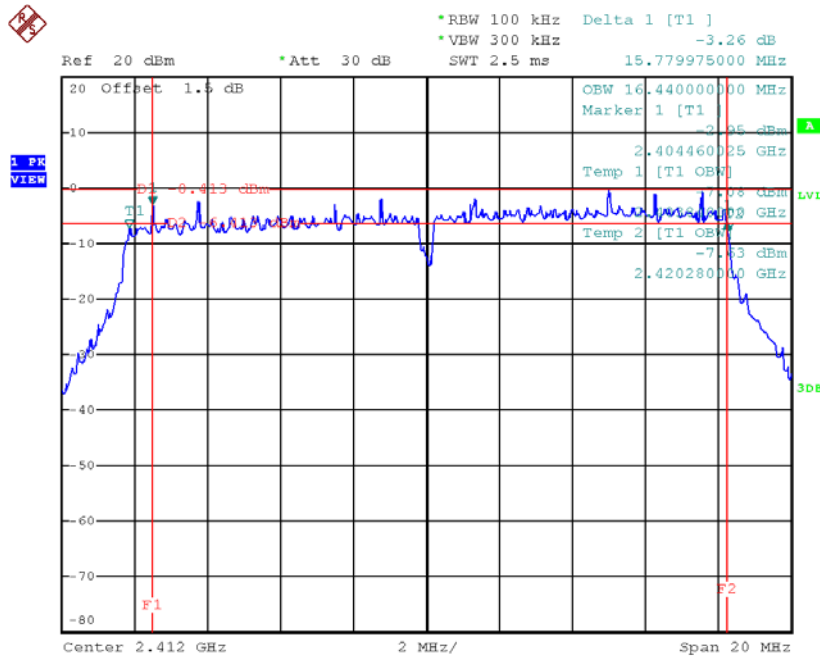

Date: 30.AUG.2018 09:57:20

TX CH06

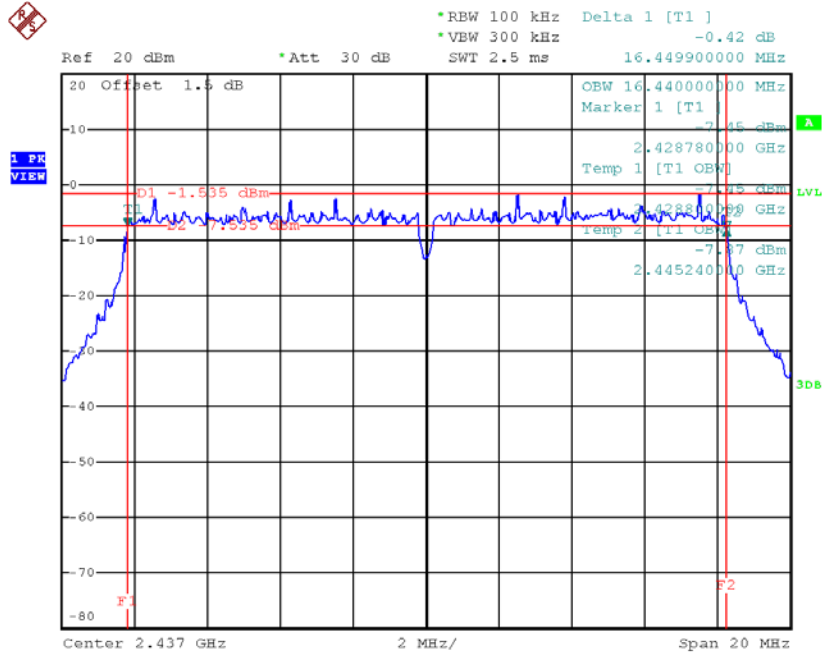

Date: 30.AUG.2018 09:58:37

TX CH11

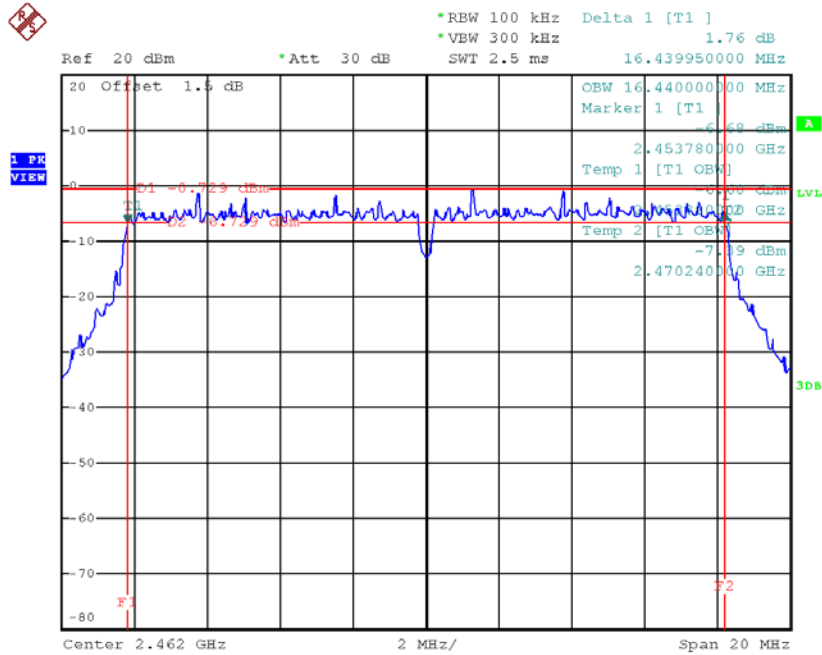

Date: 30.AUG.2018 10:00:48

Test Mode: TX N-20MHz Mode_CH01/06/11

Frequency (MHz)	6 dB Bandwidth (MHz)	99% Occupied BW (MHz)	Min. Limit (kHz)	Test Result
2412	16.98	17.60	500	Complies
2437	17.65	17.64	500	Complies
2462	17.66	17.64	500	Complies

TX CH01

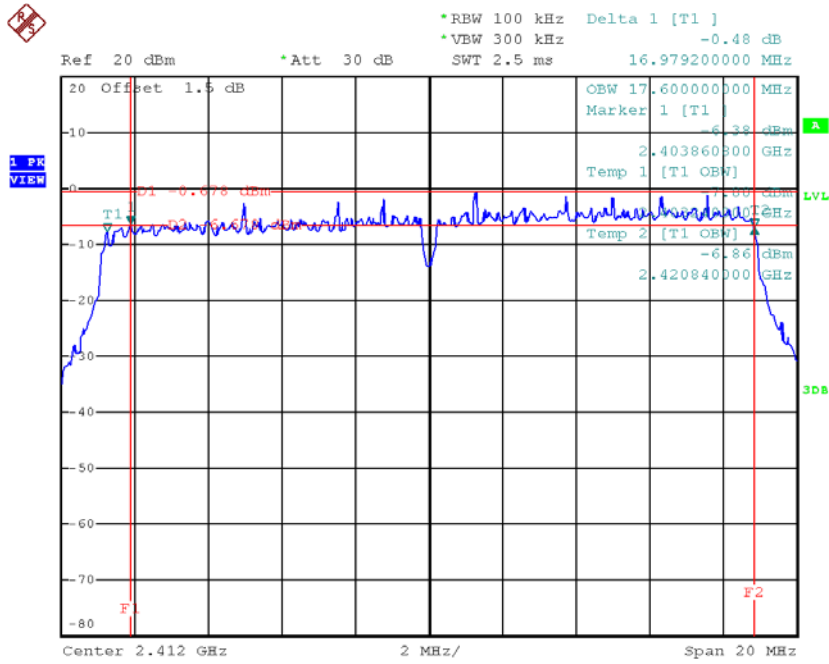

Date: 30.AUG.2018 10:02:19

TX CH06

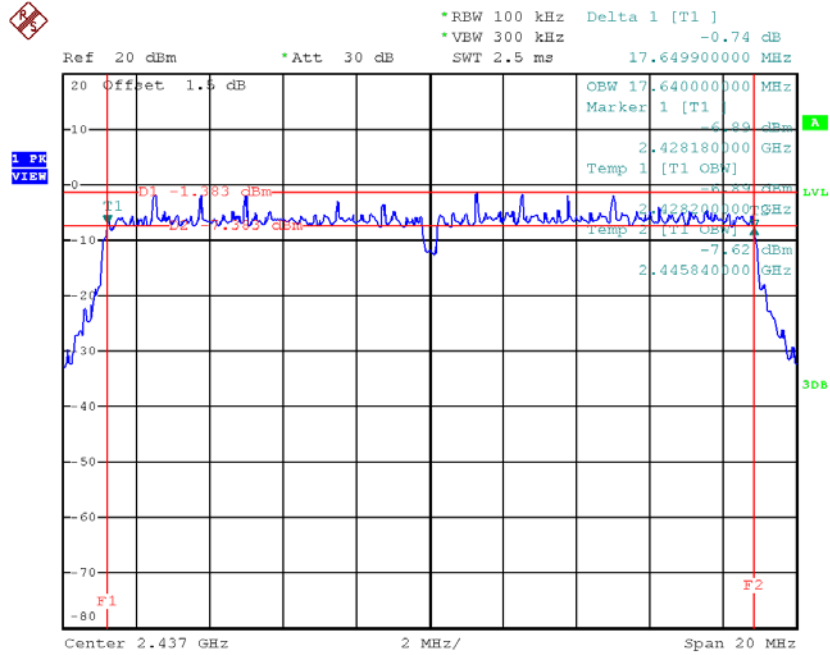

Date: 30.AUG.2018 10:03:33

TX CH11

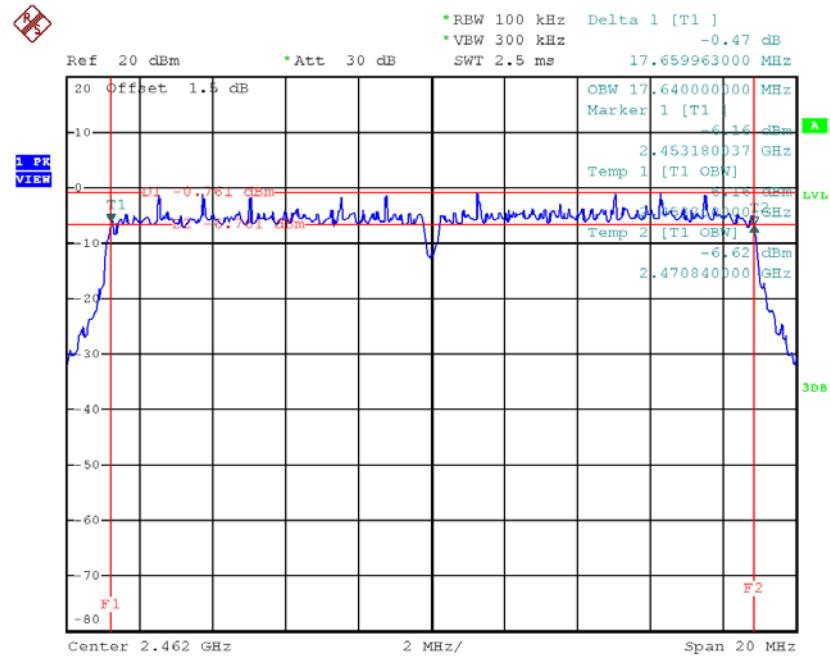

Date: 30.AUG.2018 10:05:32

Test Mode: TX N-40MHz Mode_CH03/06/09

Frequency (MHz)	6 dB Bandwidth (MHz)	99% Occupied BW (MHz)	Min. Limit (kHz)	Test Result
2422	35.20	35.76	500	Complies
2437	35.83	36.00	500	Complies
2452	35.59	35.92	500	Complies

TX CH03

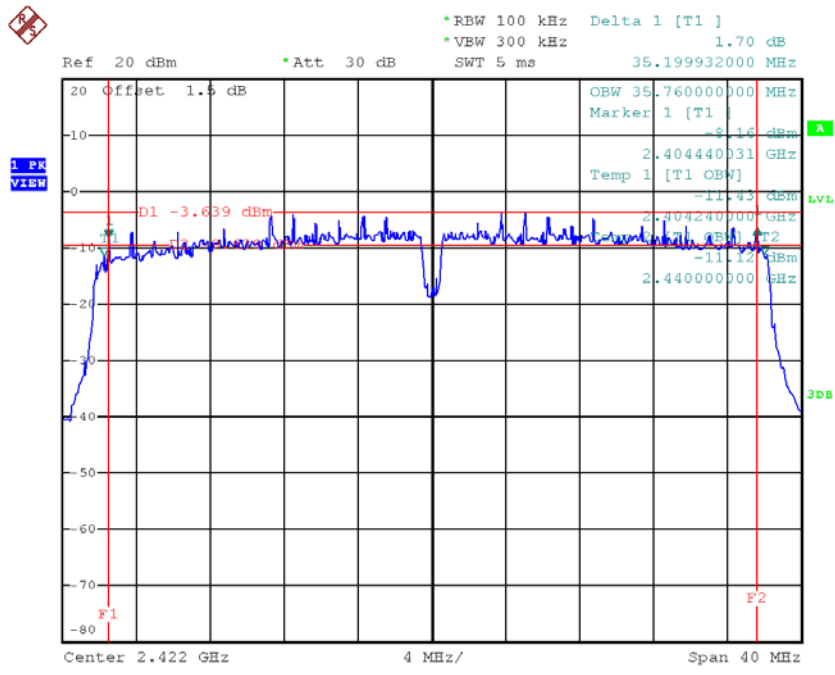

Date: 30.AUG.2018 10:08:12

TX CH06

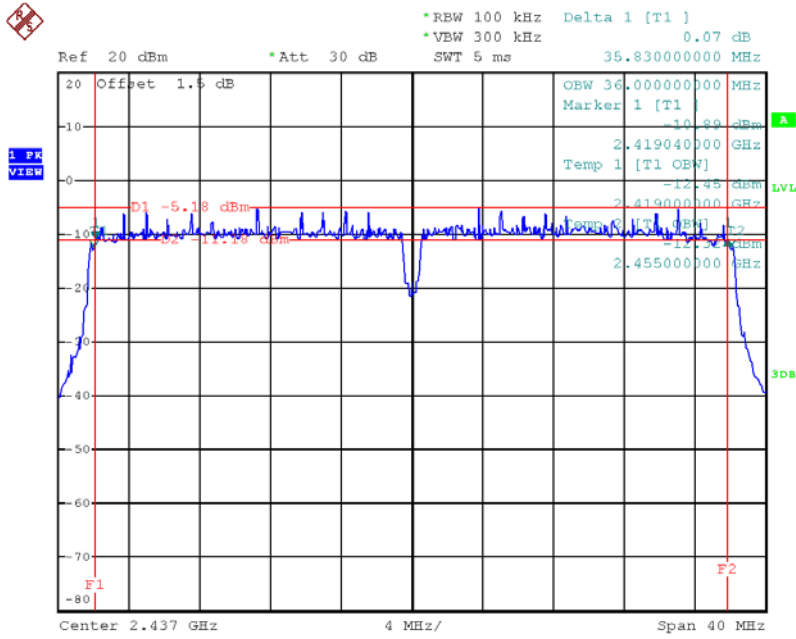

Date: 30.AUG.2018 10:09:38

TX CH09

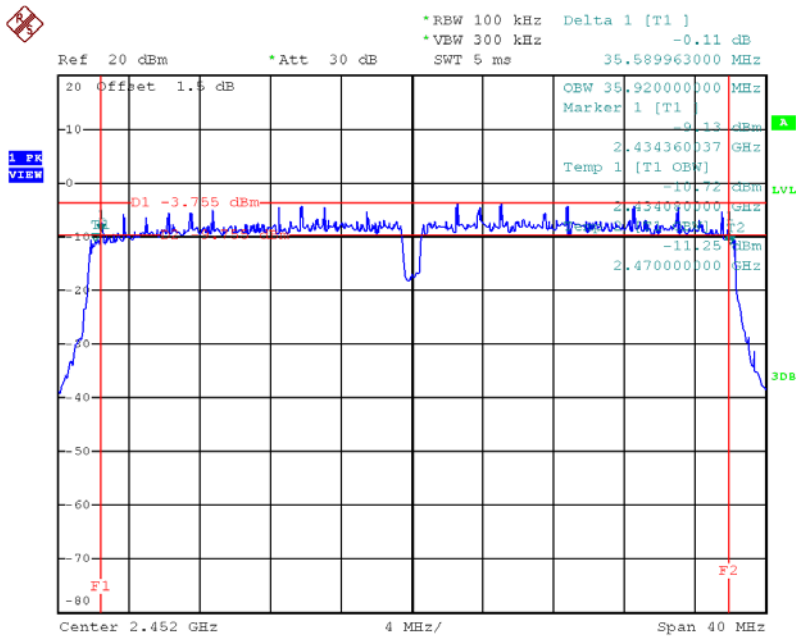

Date: 30.AUG.2018 10:11:18

APPENDIX F - MAXIMUM OUTPUT POWER

Test Mode: TX B Mode_CH01/06/11					
Frequency (MHz)	Output Power (dBm)	Output Power (W)	Max. Limit (dBm)	Max. Limit (W)	Result
2412	20.58	0.11	30.00	1.00	Complies
2437	20.27	0.11	30.00	1.00	Complies
2462	20.21	0.10	30.00	1.00	Complies

Test Mode: TX G Mode_CH01/06/11					
Frequency (MHz)	Output Power (dBm)	Output Power (W)	Max. Limit (dBm)	Max. Limit (W)	Result
2412	20.37	0.11	30.00	1.00	Complies
2437	19.96	0.10	30.00	1.00	Complies
2462	19.94	0.10	30.00	1.00	Complies

Test Mode: TX N20 Mode_CH01/06/11					
Frequency (MHz)	Output Power (dBm)	Output Power (W)	Max. Limit (dBm)	Max. Limit (W)	Result
2412	20.68	0.12	30.00	1.00	Complies
2437	20.78	0.12	30.00	1.00	Complies
2462	20.37	0.11	30.00	1.00	Complies

Test Mode: TX N40 Mode_CH03/06/09					
Frequency (MHz)	Output Power (dBm)	Output Power (W)	Max. Limit (dBm)	Max. Limit (W)	Result
2422	19.58	0.09	30.00	1.00	Complies
2437	20.57	0.11	30.00	1.00	Complies
2452	20.27	0.11	30.00	1.00	Complies

APPENDIX G - ANTENNA CONDUCTED SPURIOUS EMISSION

Test Mode: TX B Mode

TX B mode CH01

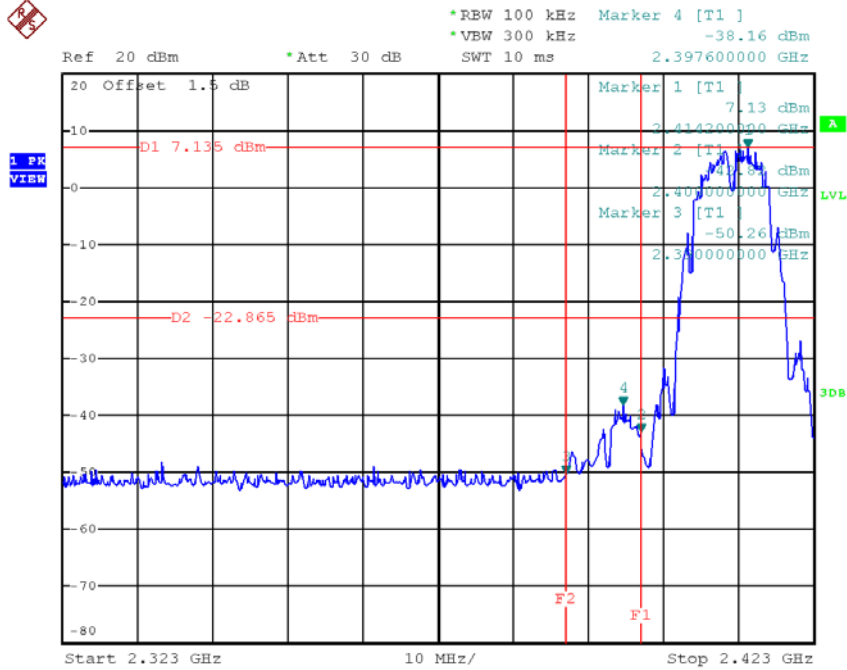

Date: 30.AUG.2018 09:50:44

TX B mode CH11

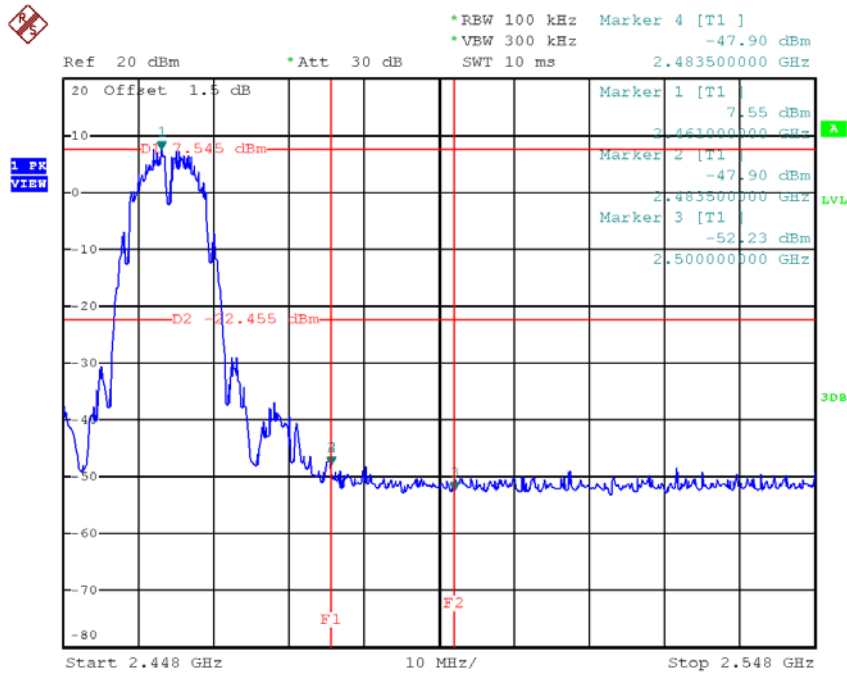

Date: 30.AUG.2018 09:55:15

TX B mode CH01 (10th Harmonic of the frequency)

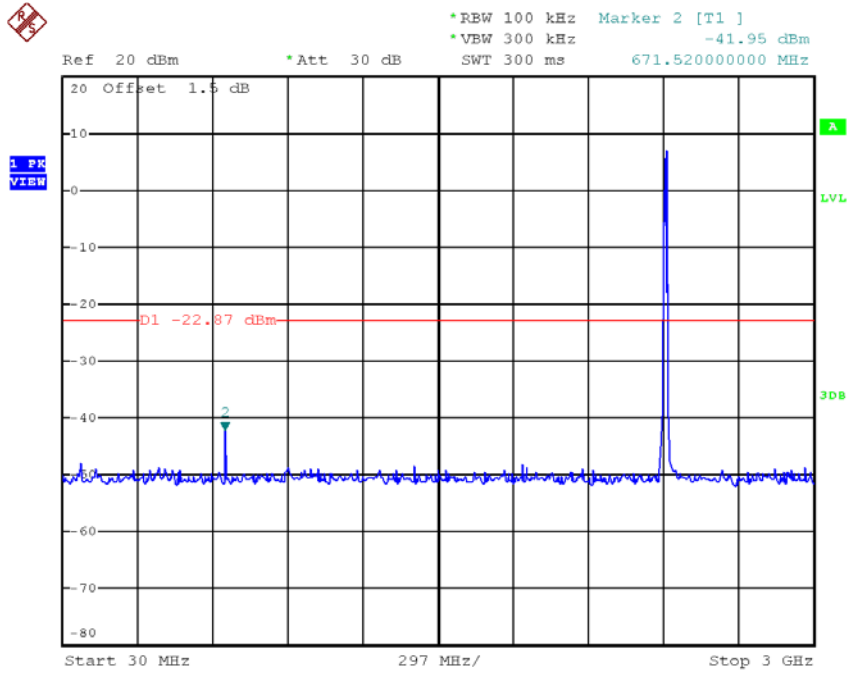

Date: 30.AUG.2018 09:50:57

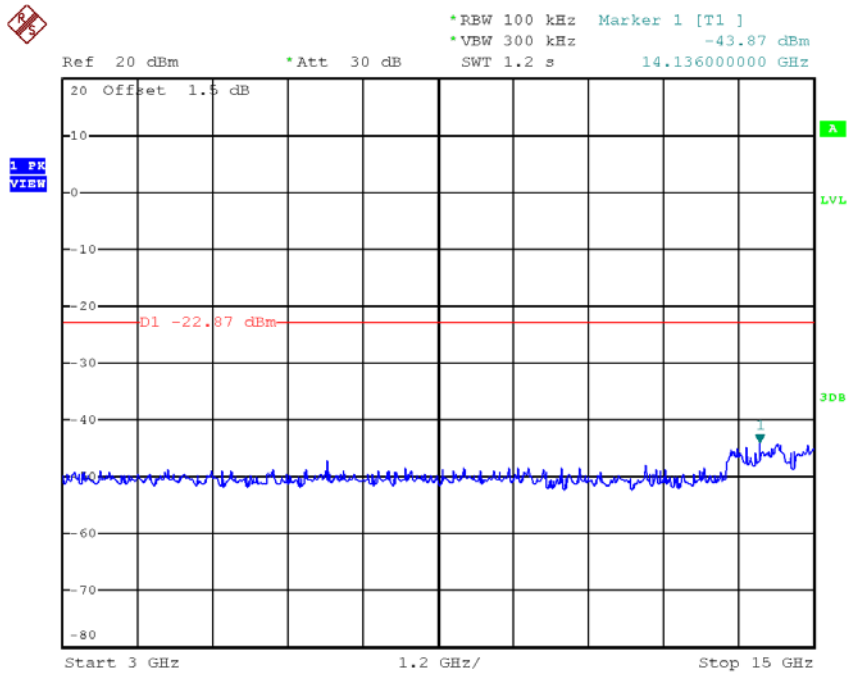

Date: 30.AUG.2018 09:51:04

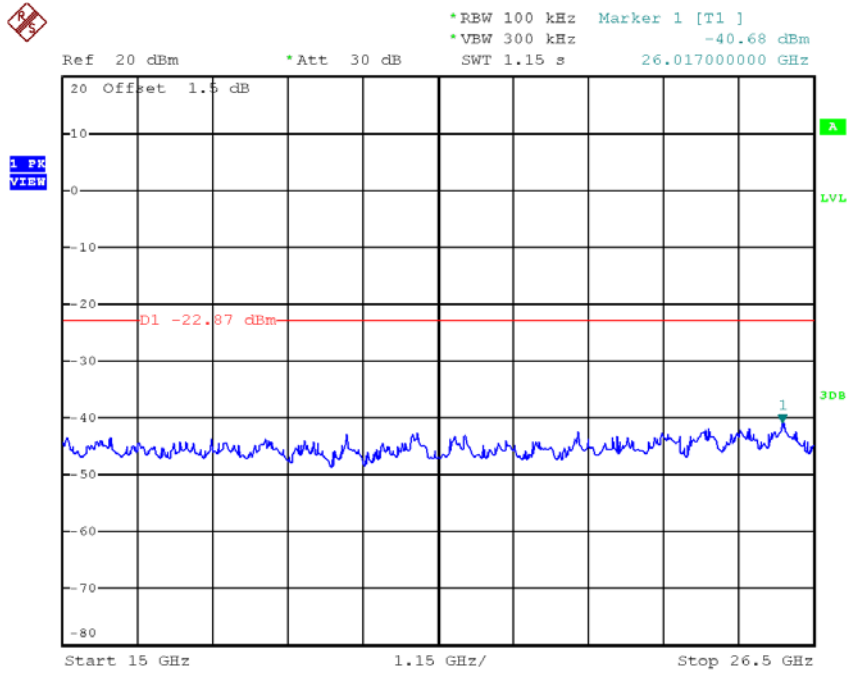

Date: 30.AUG.2018 09:51:11

TX B mode CH06 (10th Harmonic of the frequency)

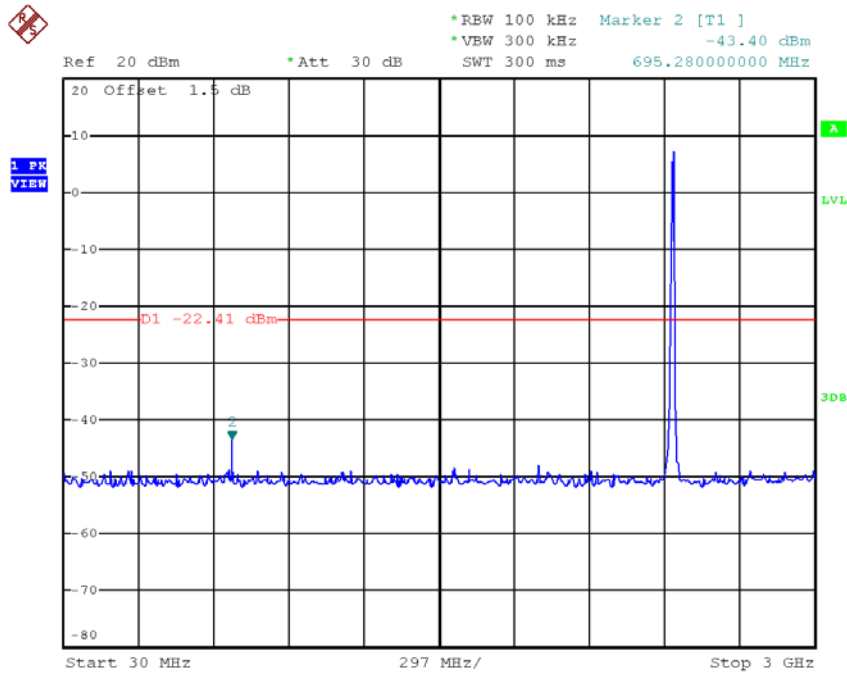

Date: 30.AUG.2018 09:53:54

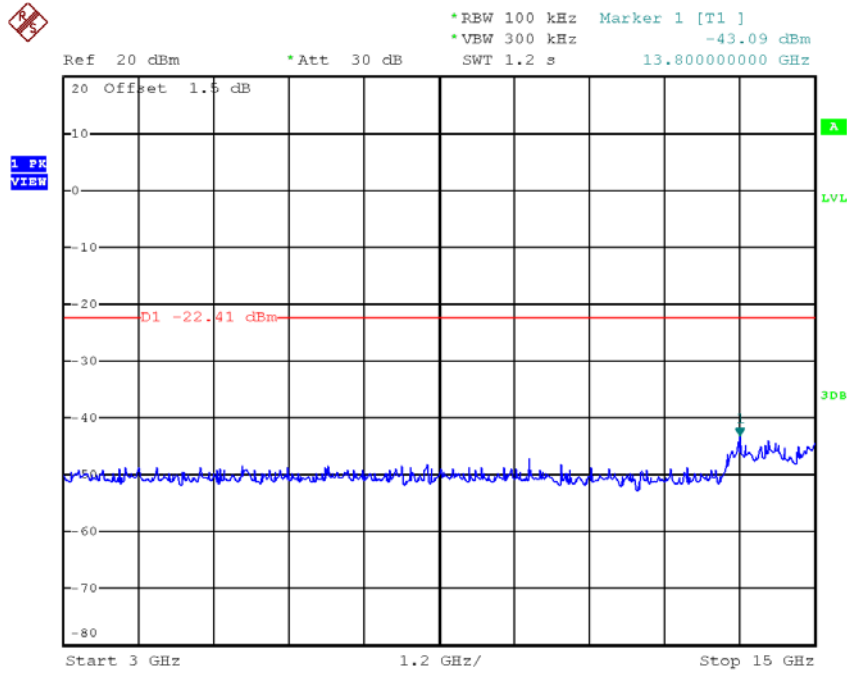

Date: 30.AUG.2018 09:54:01

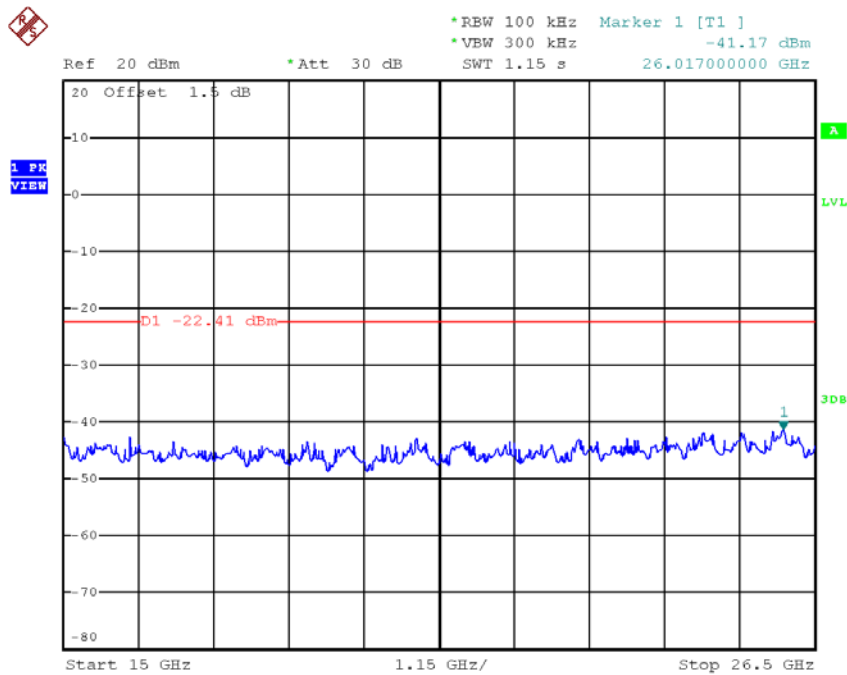

Date: 30.AUG.2018 09:54:09

TX B mode CH11 (10th Harmonic of the frequency)

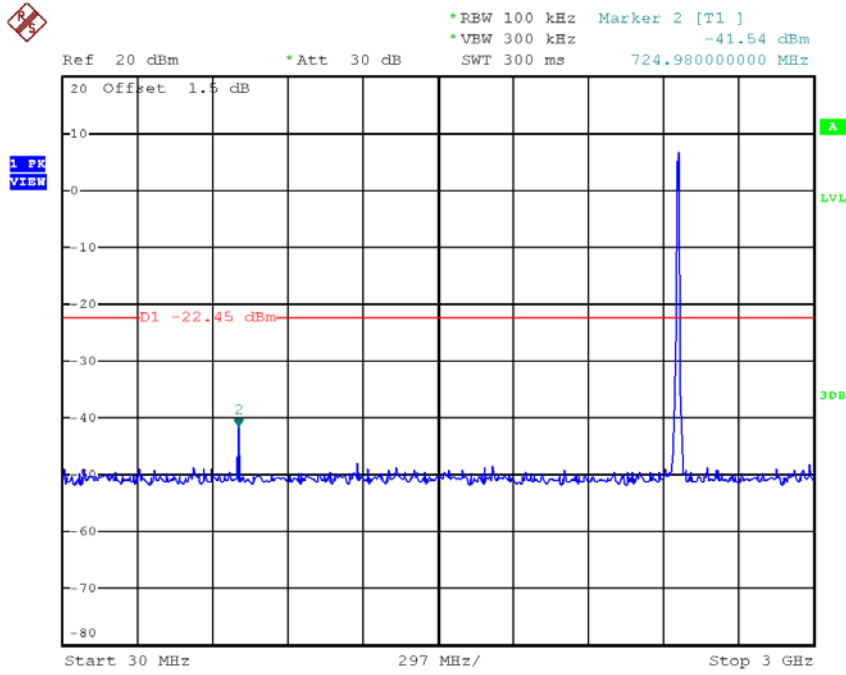

Date: 30.AUG.2018 09:55:28

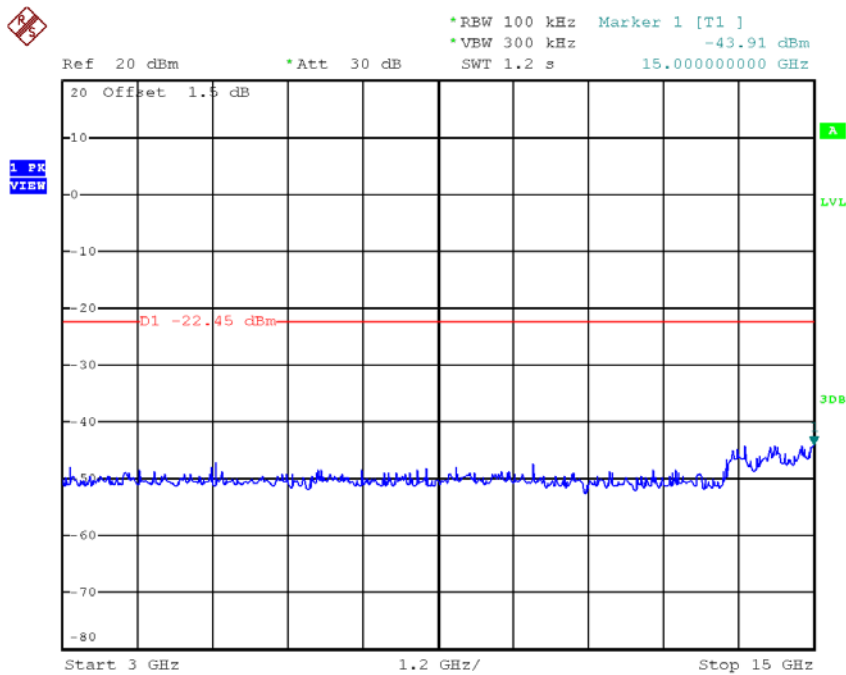

Date: 30.AUG.2018 09:55:35

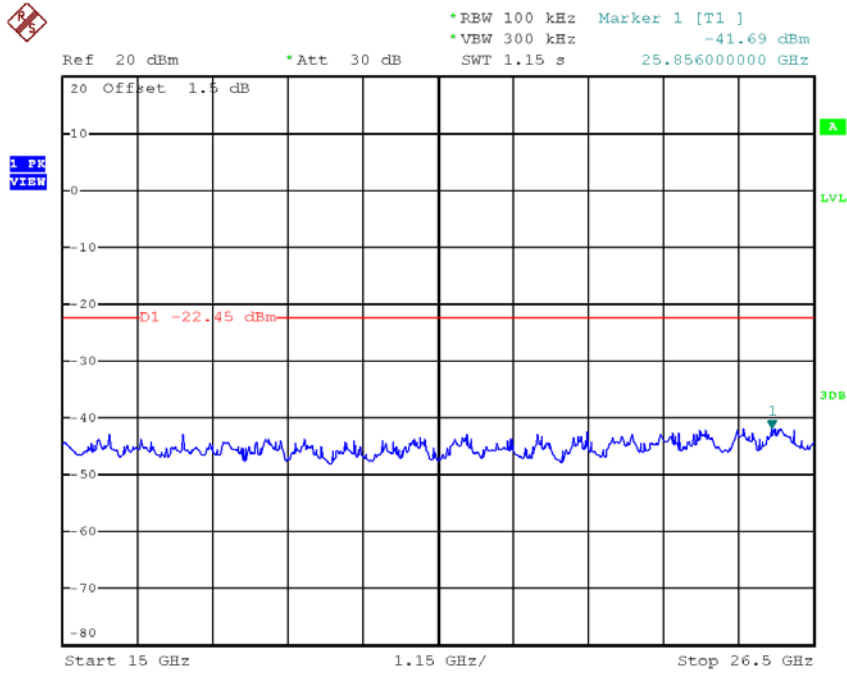

Date: 30.AUG.2018 09:55:42

Test Mode: TX G Mode

TX G mode CH01

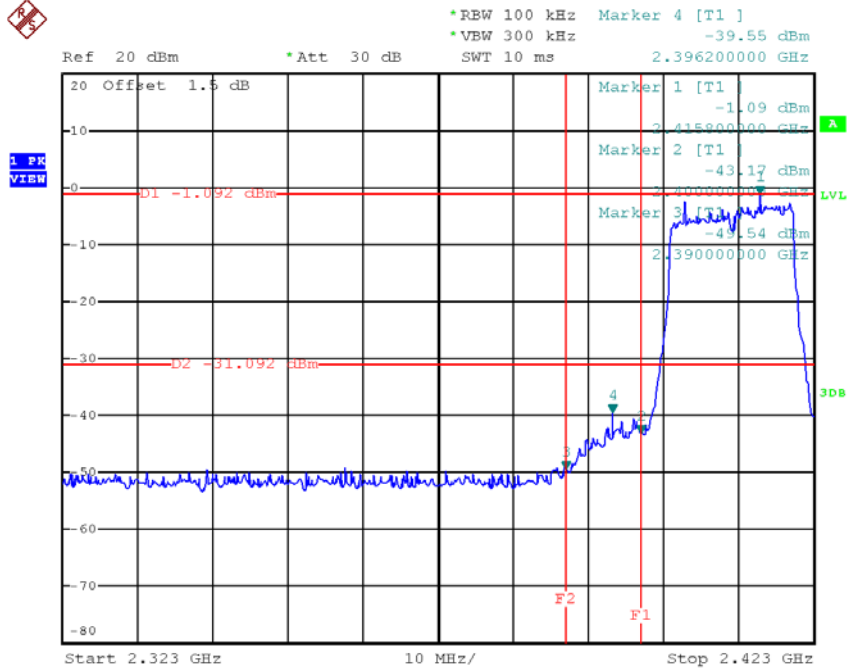

Date: 30.AUG.2018 09:57:27

TX G mode CH11

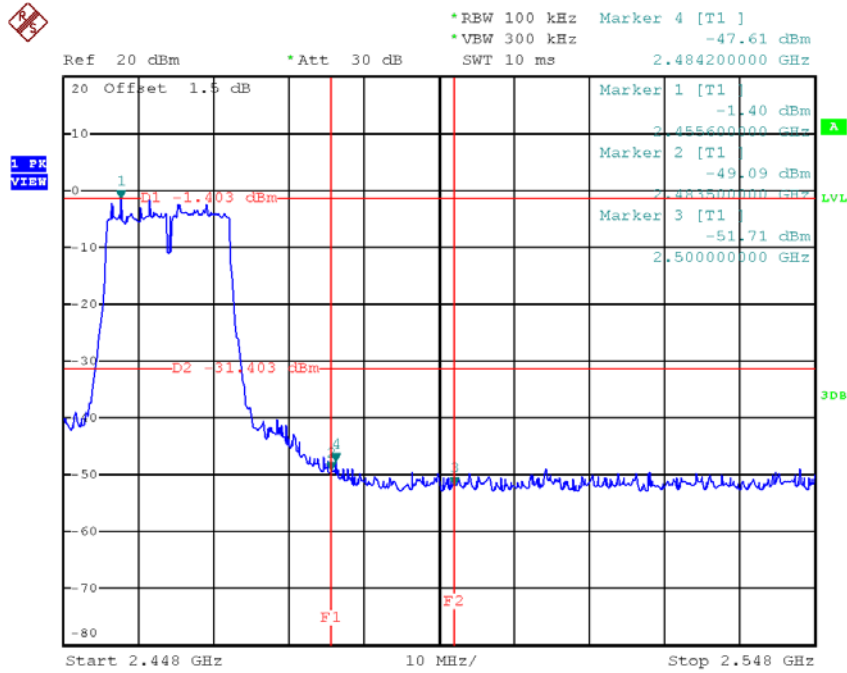

Date: 30.AUG.2018 10:00:55

TX G mode CH01 (10th Harmonic of the frequency)

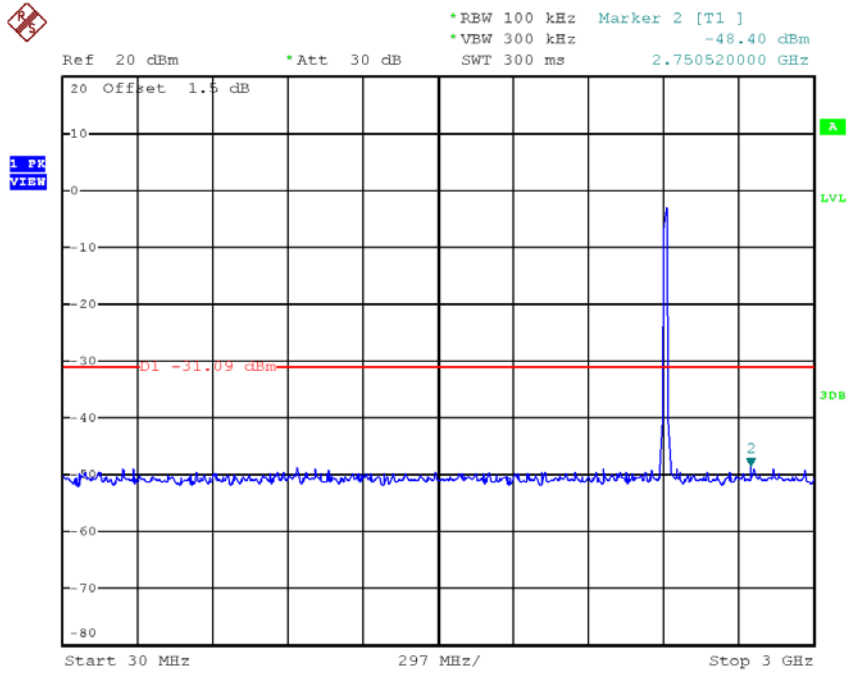

Date: 30.AUG.2018 09:57:40

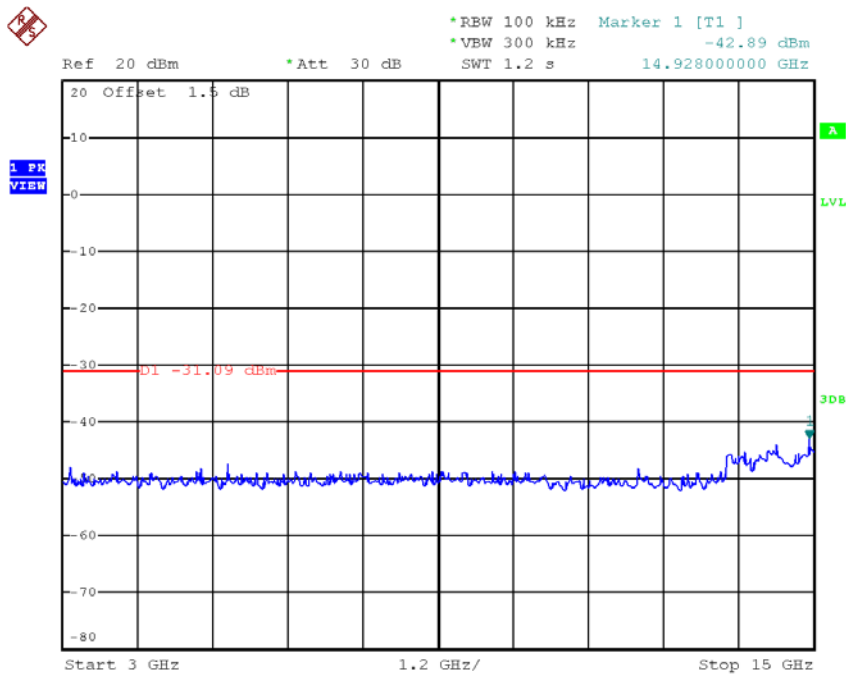

Date: 30.AUG.2018 09:57:47

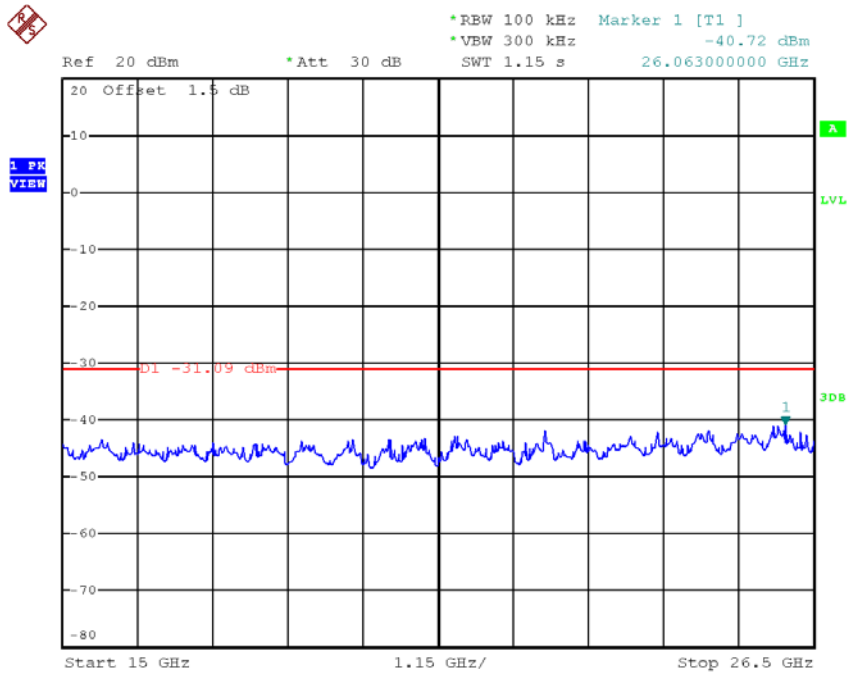

Date: 30.AUG.2018 09:57:54

TX G mode CH06 (10th Harmonic of the frequency)

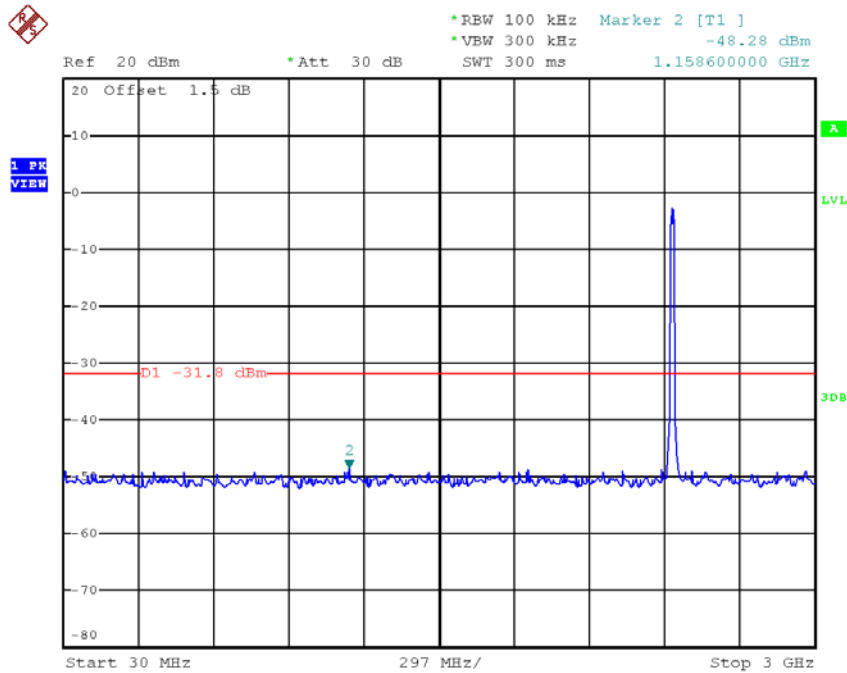

Date: 30.AUG.2018 09:58:57

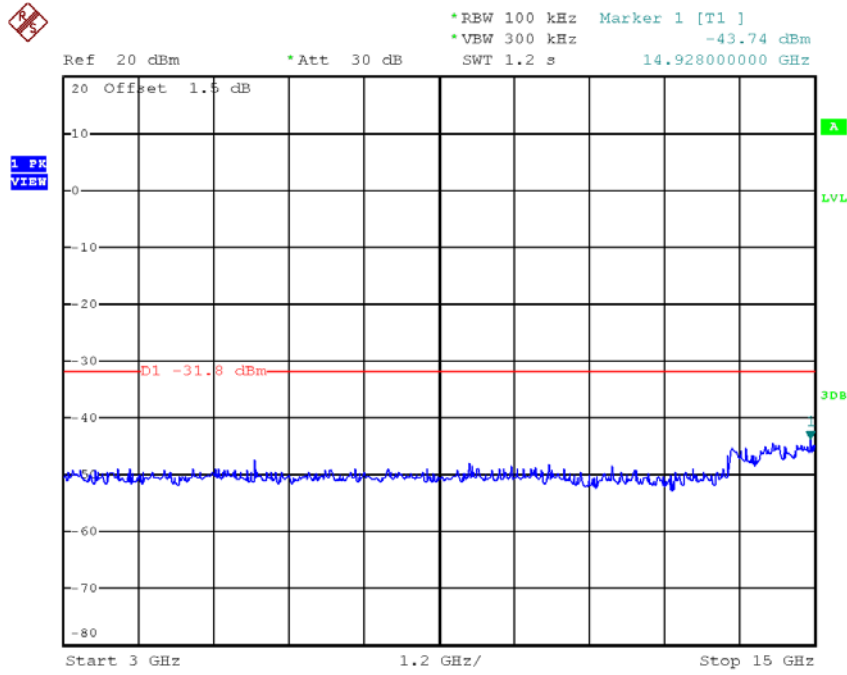

Date: 30.AUG.2018 09:59:04

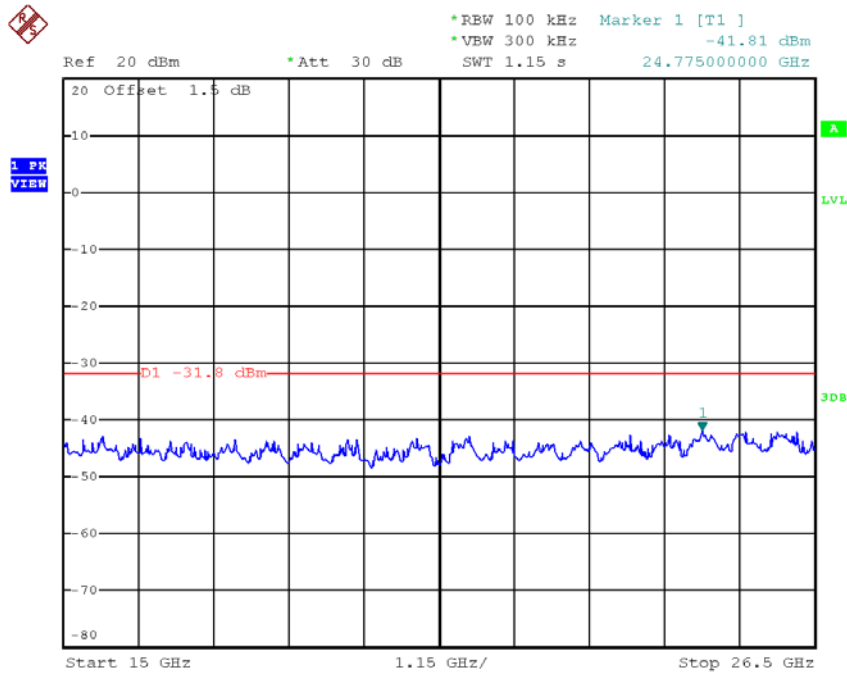

Date: 30.AUG.2018 09:59:12

TX G mode CH11 (10th Harmonic of the frequency)

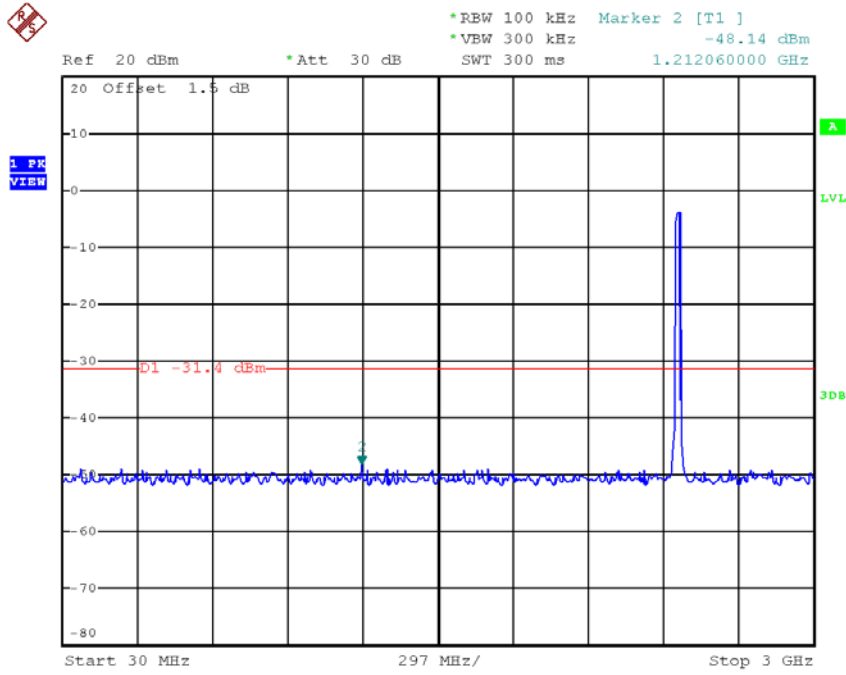

Date: 30.AUG.2018 10:01:08

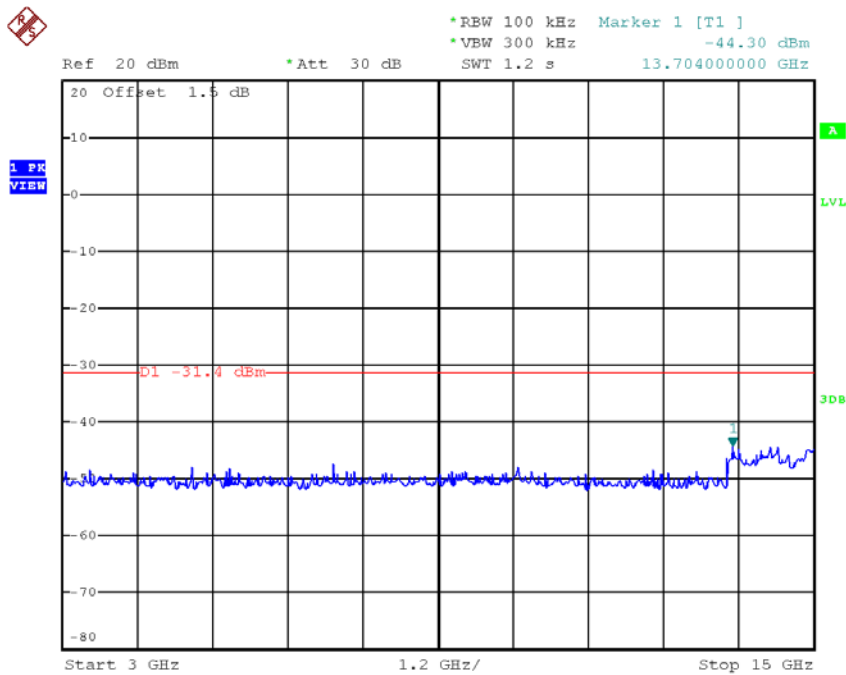

Date: 30.AUG.2018 10:01:15

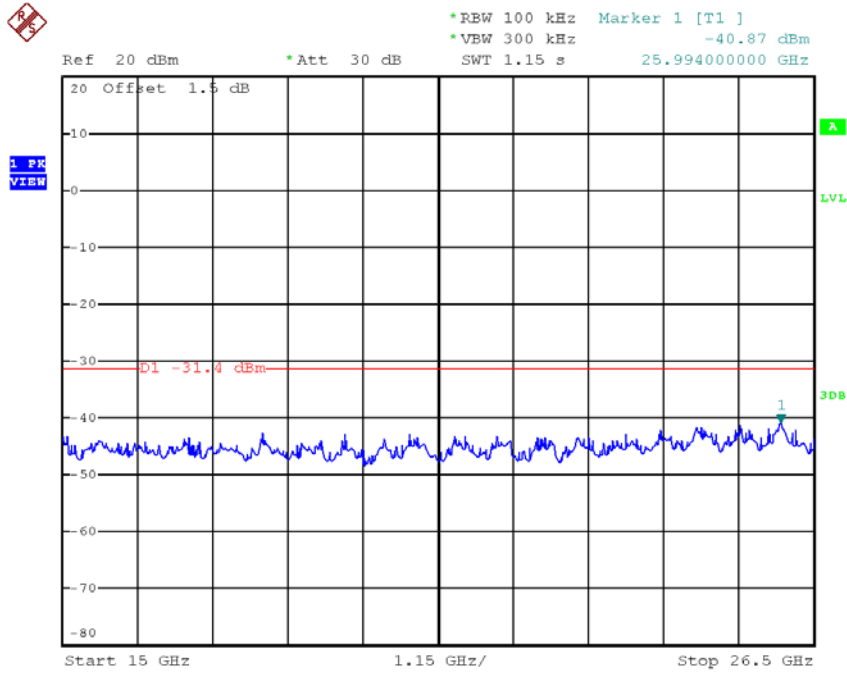

Date: 30.AUG.2018 10:01:22

Test Mode: TX N-20M Mode

TX HT20 mode CH01

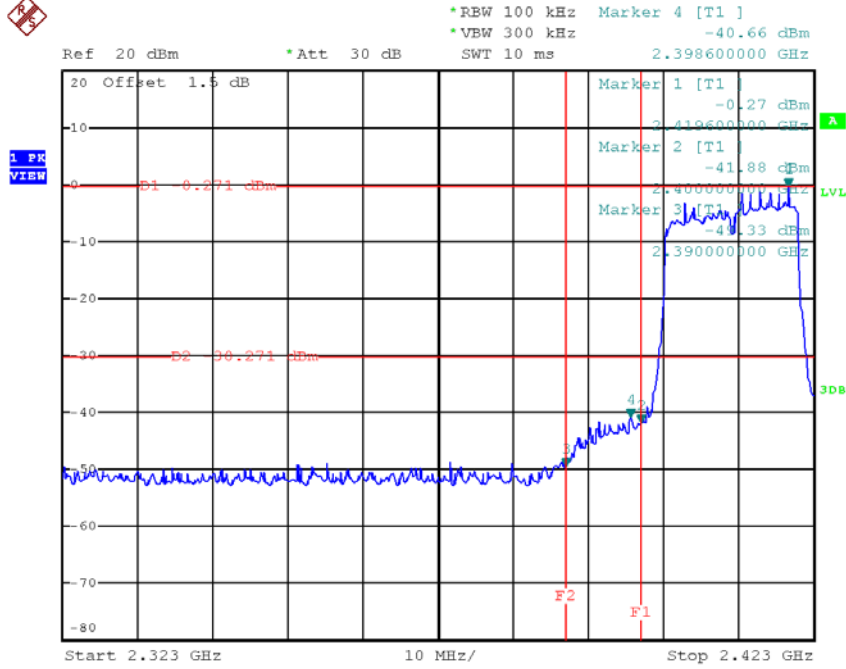

Date: 30.AUG.2018 10:02:27

TX HT20 mode CH11

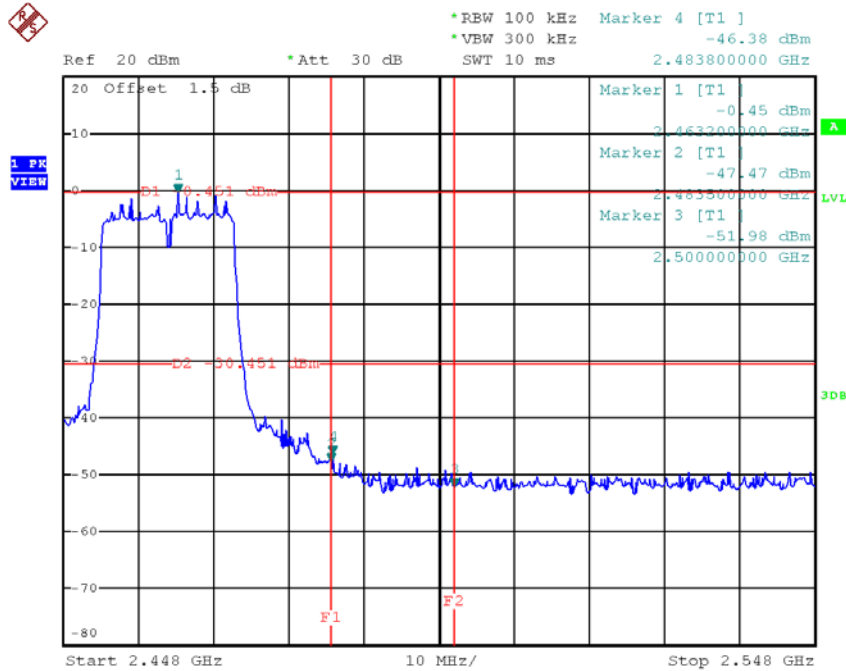

Date: 30.AUG.2018 10:05:40

TX HT20 mode CH01 (10th Harmonic of the frequency)

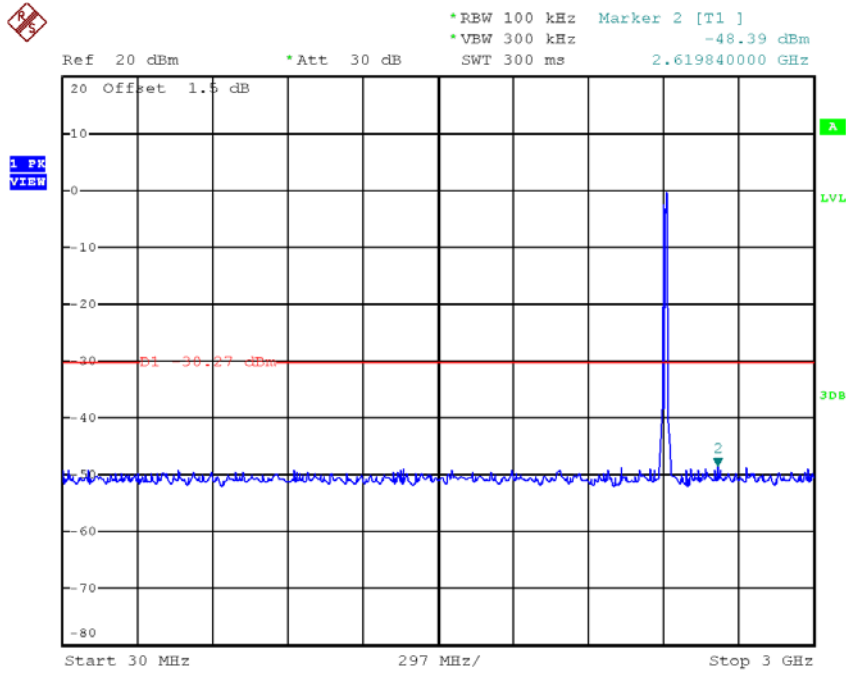

Date: 30.AUG.2018 10:02:40

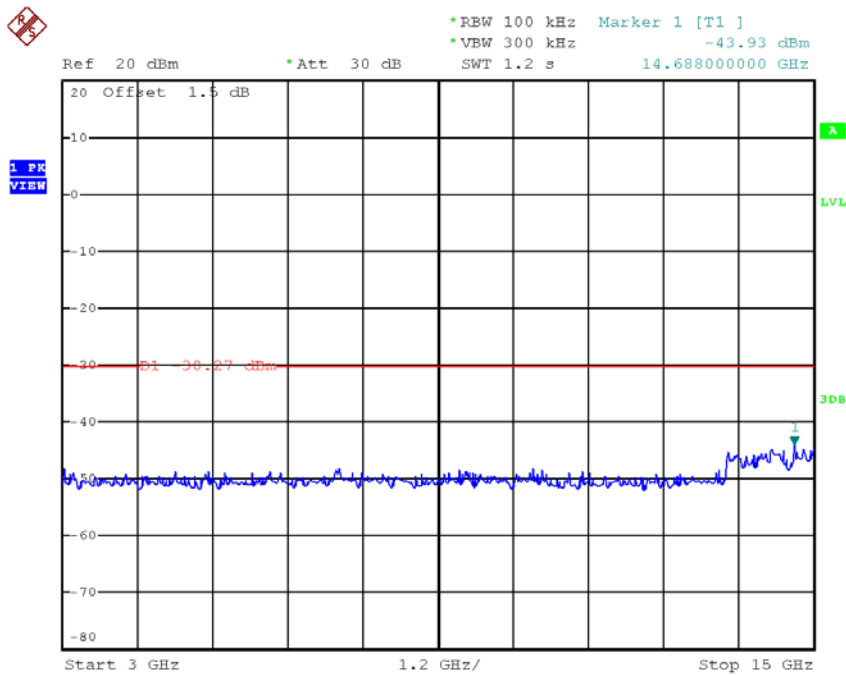

Date: 30.AUG.2018 10:02:47

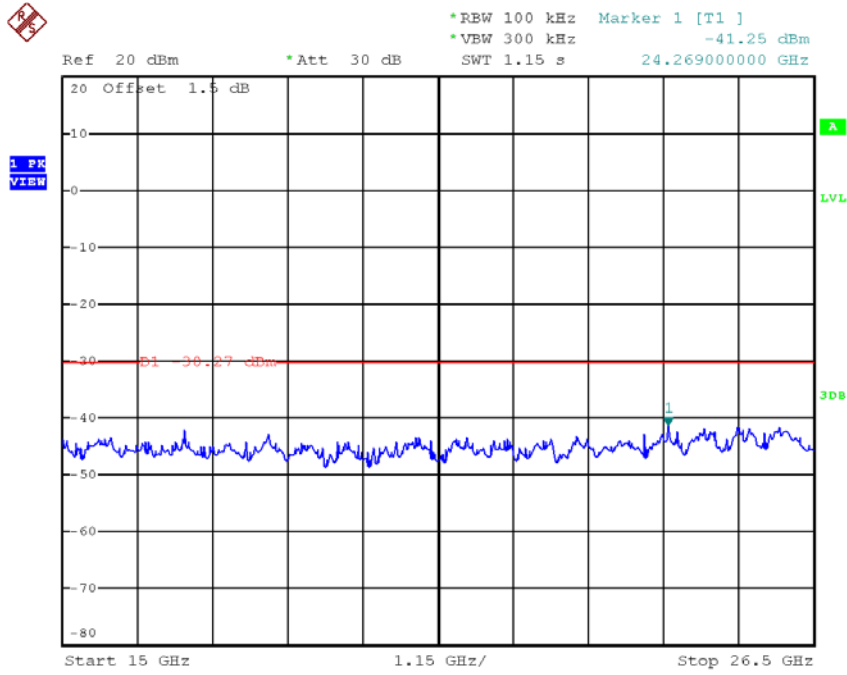

Date: 30.AUG.2018 10:02:54

TX HT20 mode CH06 (10th Harmonic of the frequency)

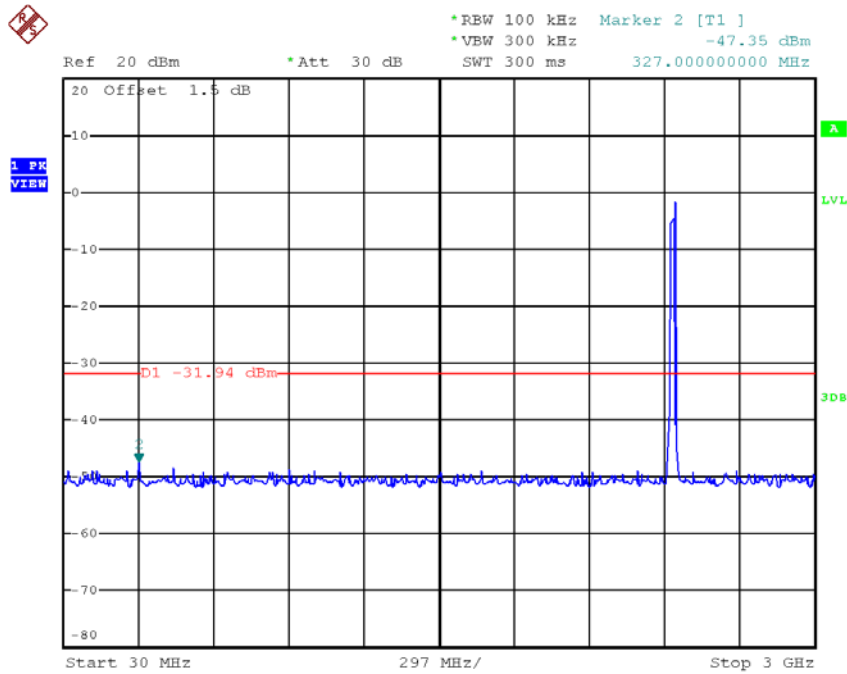

Date: 30.AUG.2018 10:03:54

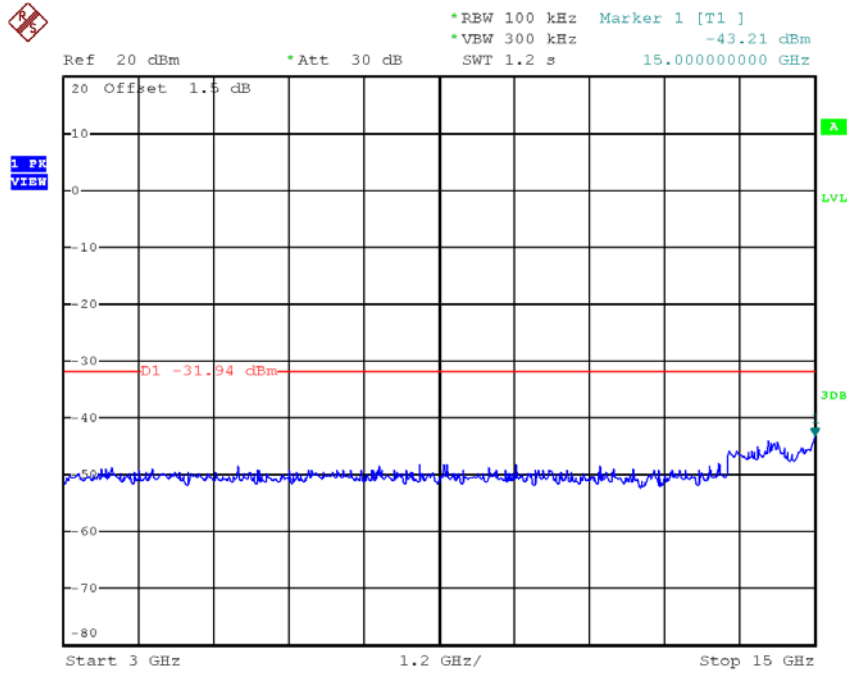

Date: 30.AUG.2018 10:04:01

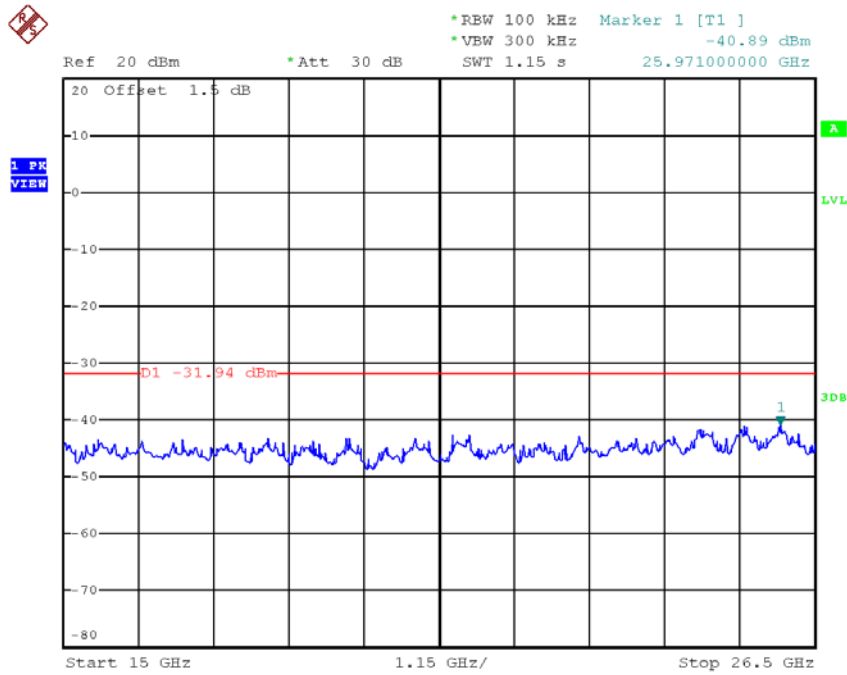

Date: 30.AUG.2018 10:04:08

TX HT20 mode CH11 (10th Harmonic of the frequency)

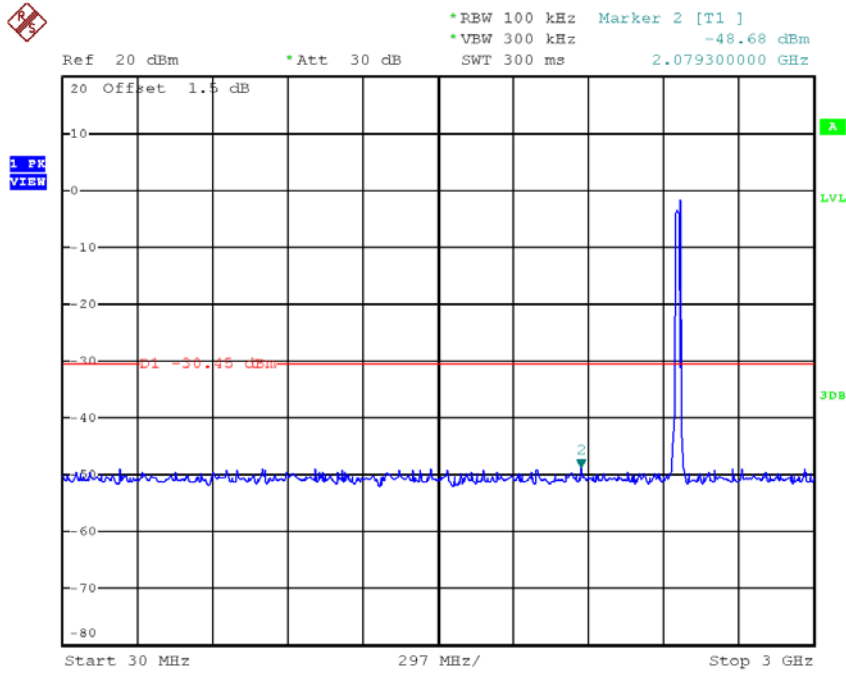

Date: 30.AUG.2018 10:05:53

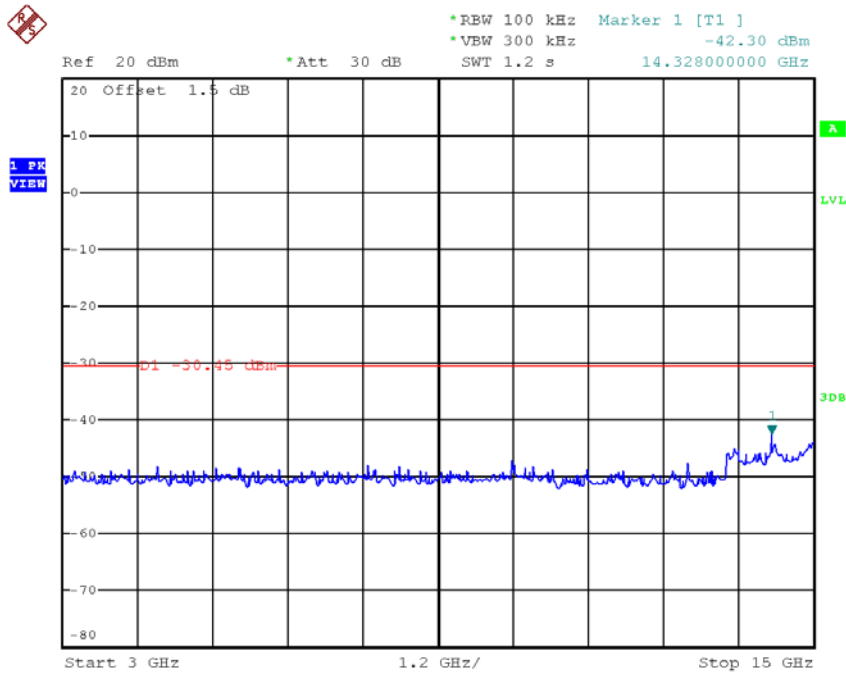

Date: 30.AUG.2018 10:06:00

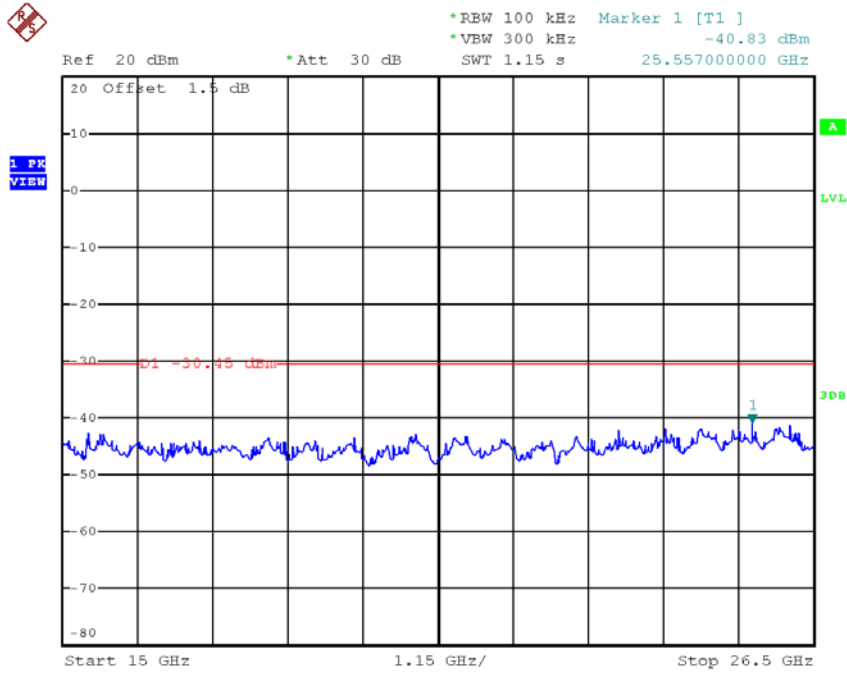

Date: 30.AUG.2018 10:06:07

Test Mode: TX N-40M Mode

TX HT40 mode CH03

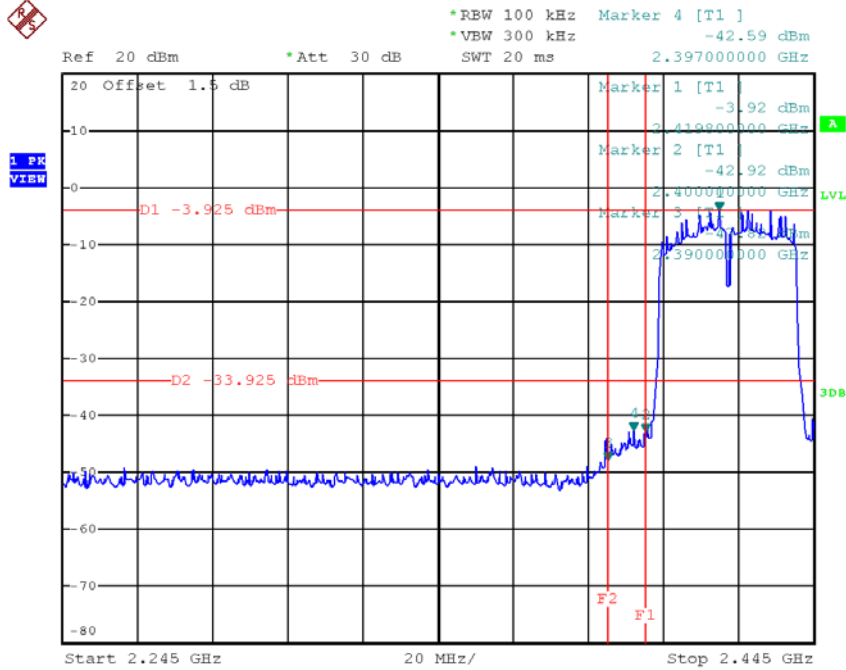

Date: 30.AUG.2018 10:08:19

TX HT40 mode CH09

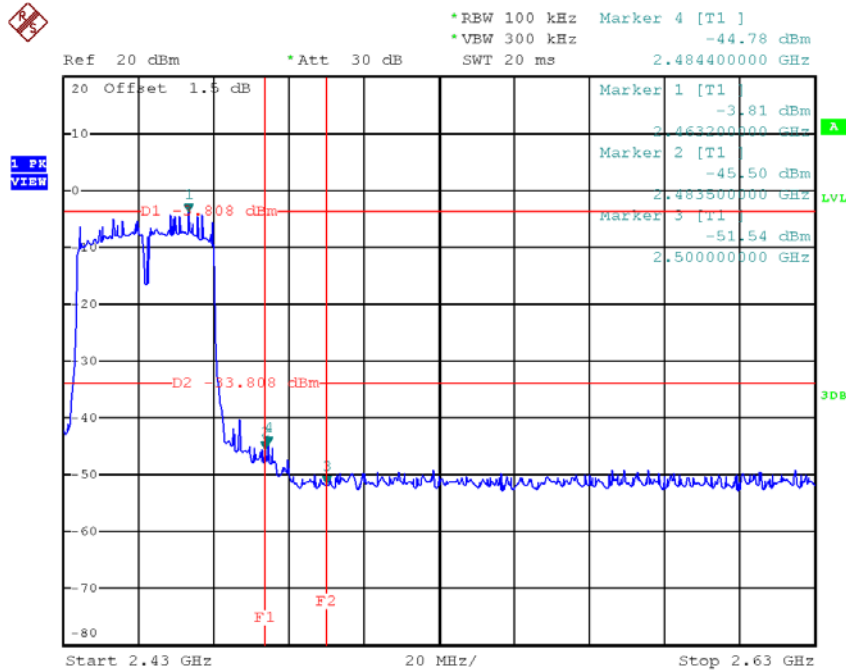

Date: 30.AUG.2018 10:11:25

TX HT40 mode CH03 (10th Harmonic of the frequency)

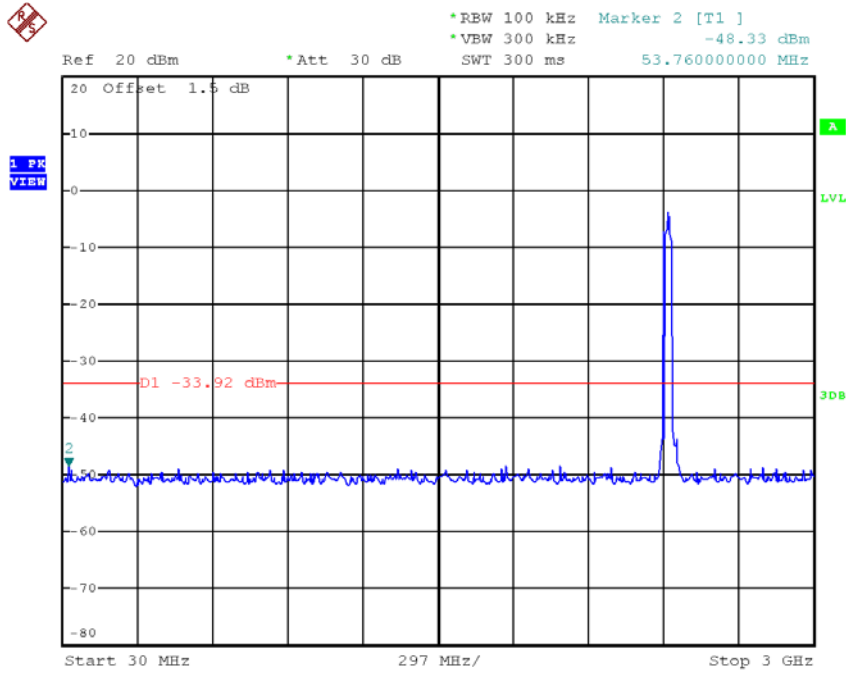

Date: 30.AUG.2018 10:08:32

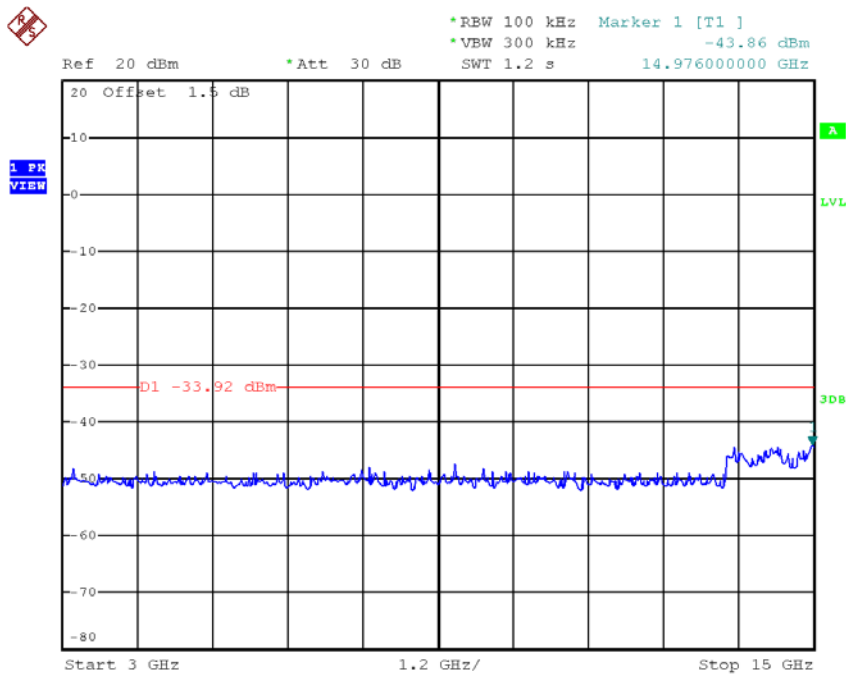

Date: 30.AUG.2018 10:08:39

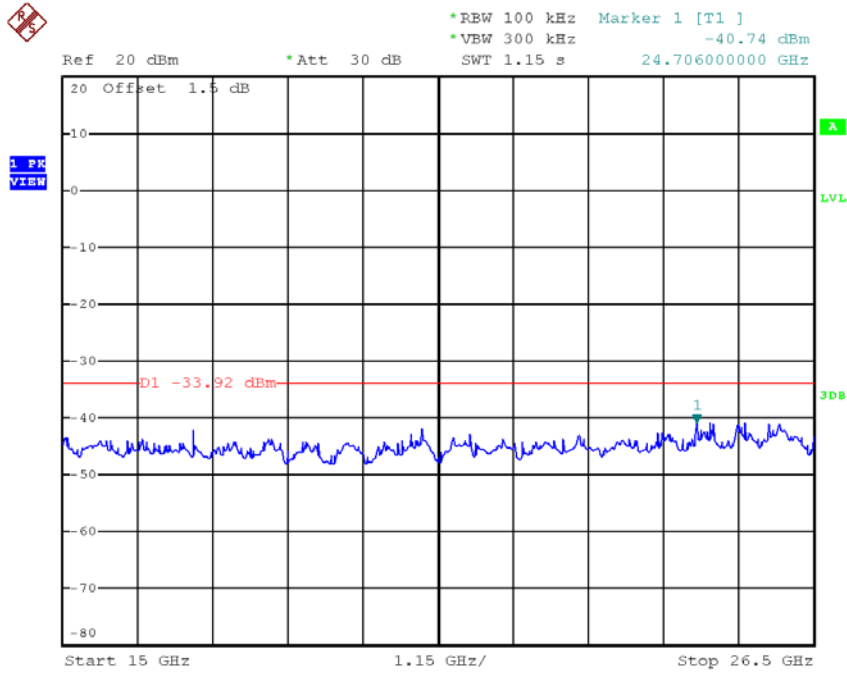

Date: 30.AUG.2018 10:08:46

TX HT40 mode CH06 (10th Harmonic of the frequency)

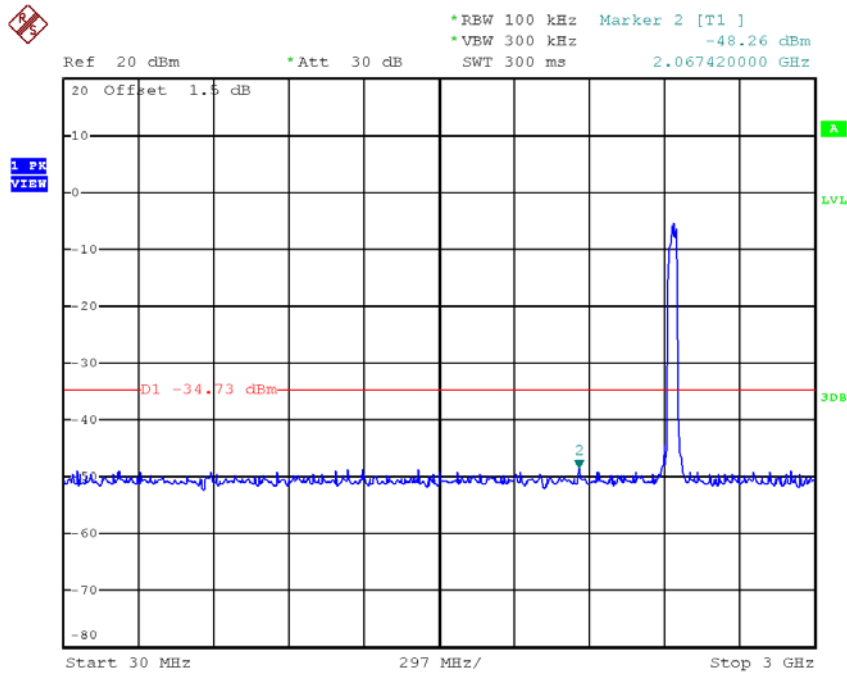

Date: 30.AUG.2018 10:09:58

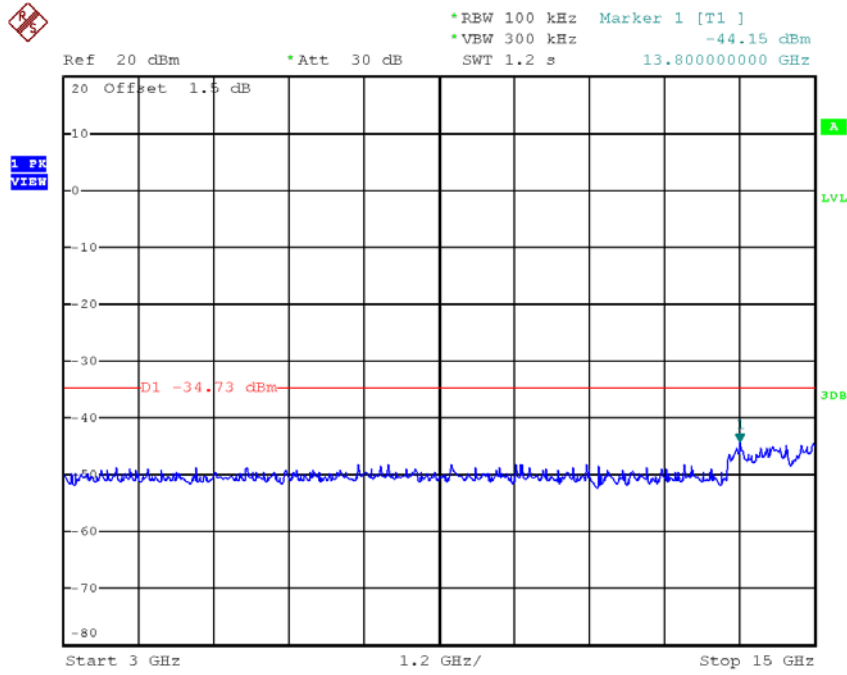

Date: 30.AUG.2018 10:10:06

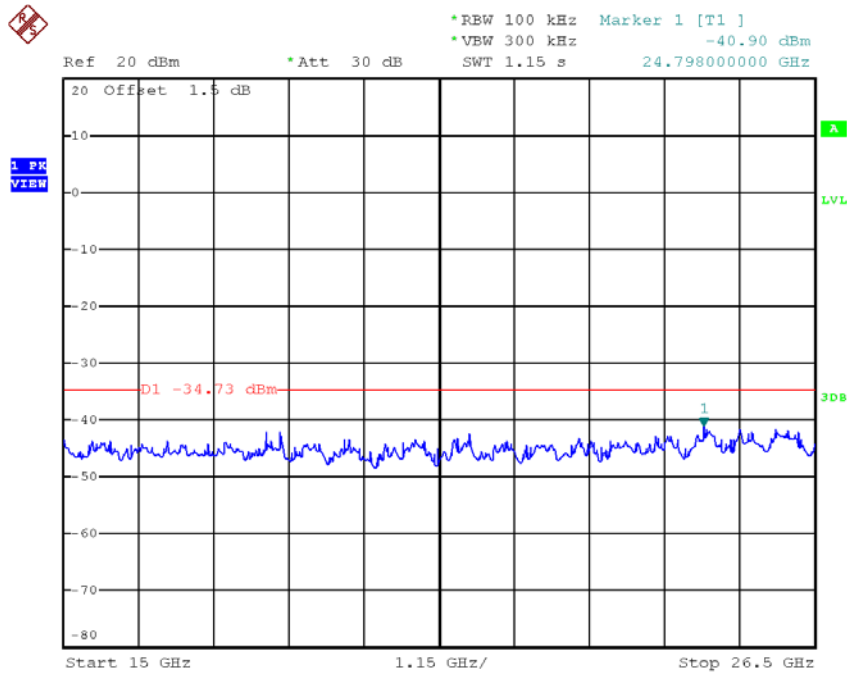

Date: 30.AUG.2018 10:10:13

TX HT40 mode CH09 (10th Harmonic of the frequency)

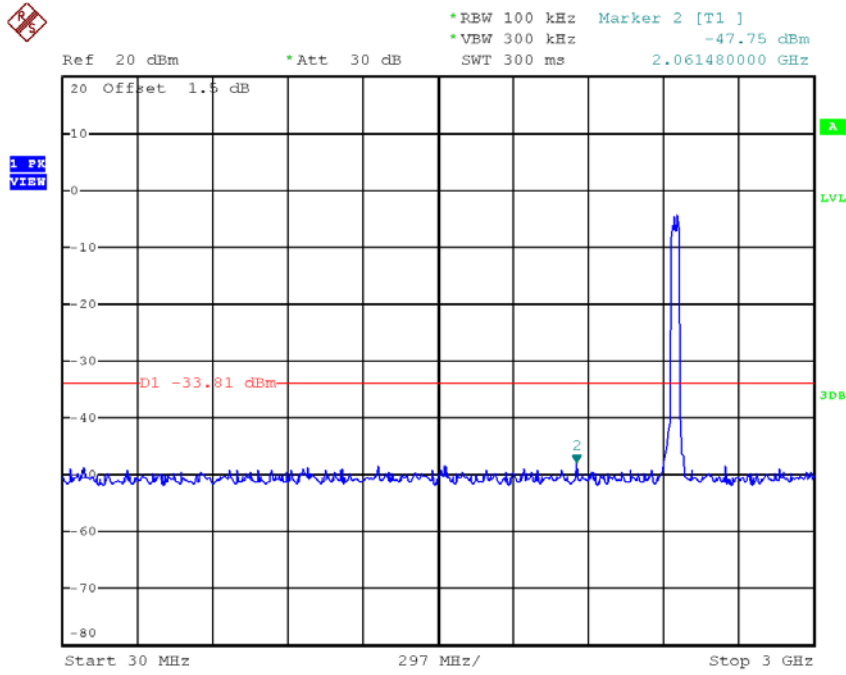

Date: 30.AUG.2018 10:11:38

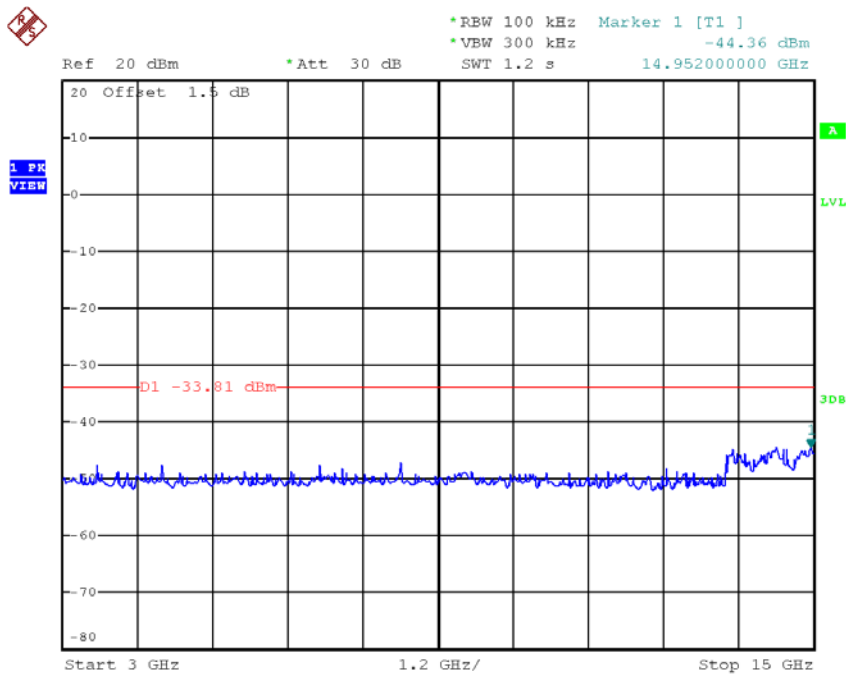

Date: 30.AUG.2018 10:11:45

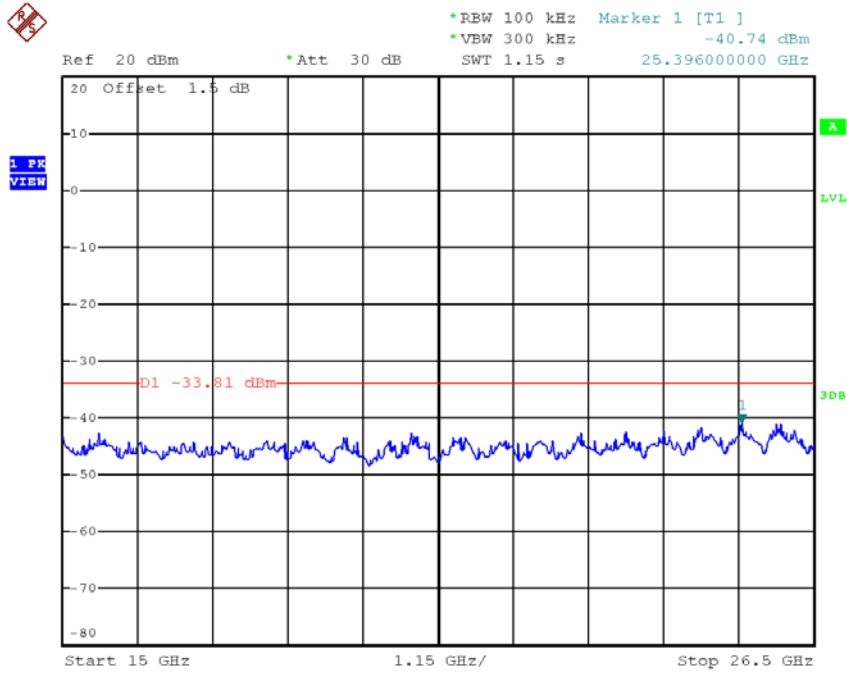

Date: 30.AUG.2018 10:11:53

APPENDIX H - POWER SPECTRAL DENSITY

Test Mode: TX B Mode_CH01/06/11

Frequency (MHz)	Power Density (dBm/3 kHz)	Power Density (mW/3 kHz)	Max. Limit (dBm/3 kHz)	Result
2412	-6.93	0.2028	8.00	Complies
2437	-6.62	0.2178	8.00	Complies
2462	-6.66	0.2158	8.00	Complies

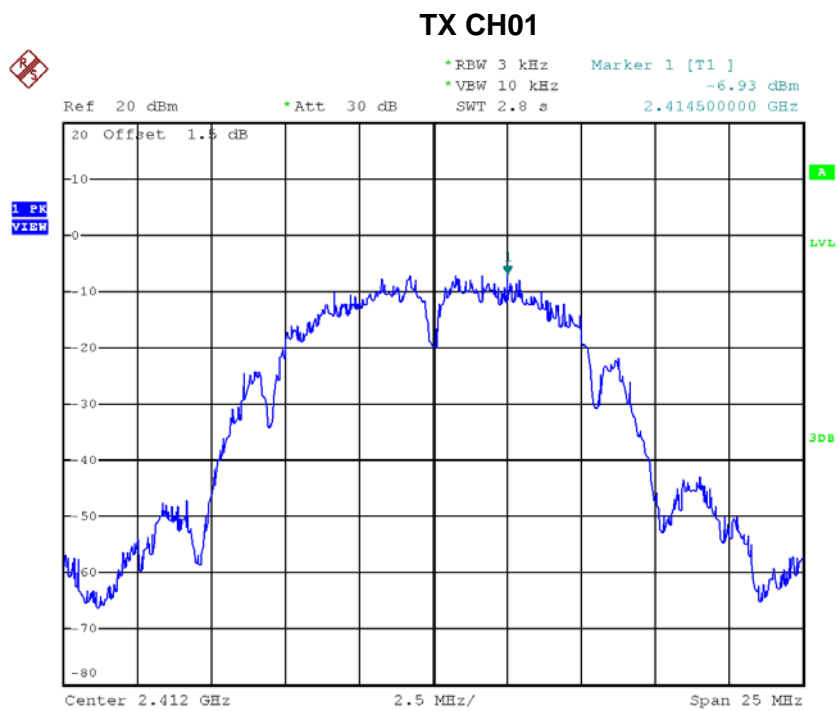

Date: 30.AUG.2018 09:51:20

TX CH06

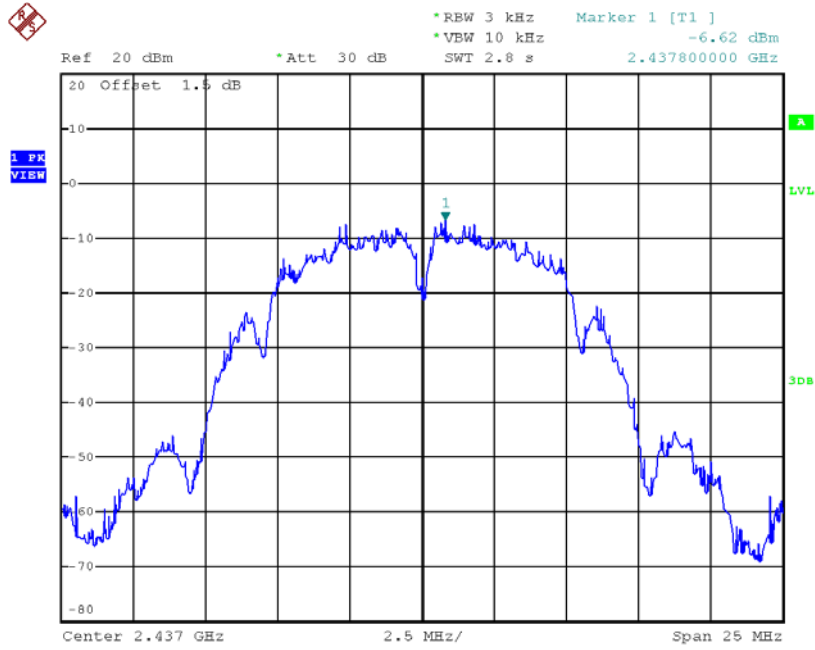

Date: 30.AUG.2018 09:54:17

TX CH11

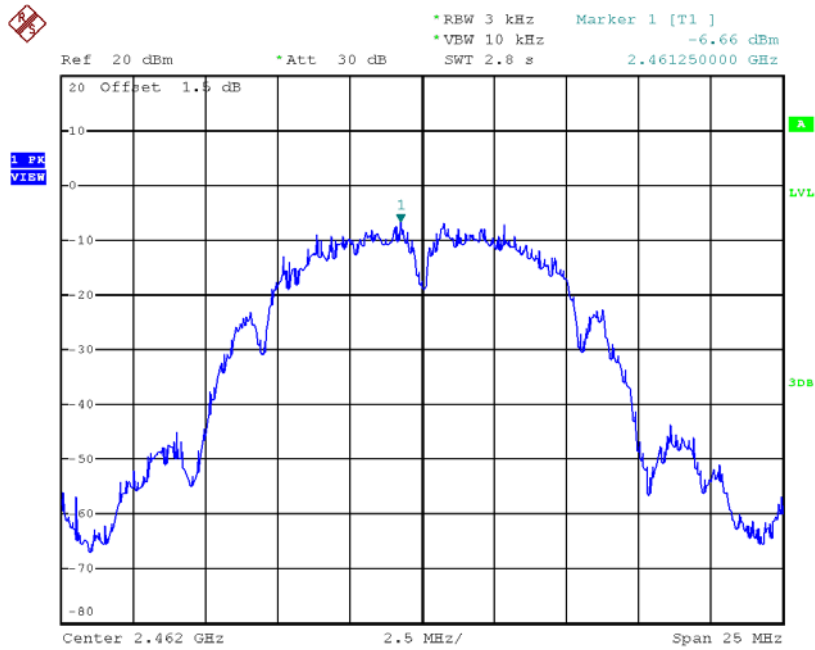

Date: 30.AUG.2018 09:55:51

Test Mode: TX G Mode_CH01/06/11

Frequency (MHz)	Power Density (dBm/3 kHz)	Power Density (mW/3 kHz)	Max. Limit (dBm/3 kHz)	Result
2412	-14.53	0.0352	8.00	Complies
2437	-15.82	0.0262	8.00	Complies
2462	-15.41	0.0288	8.00	Complies

TX CH01

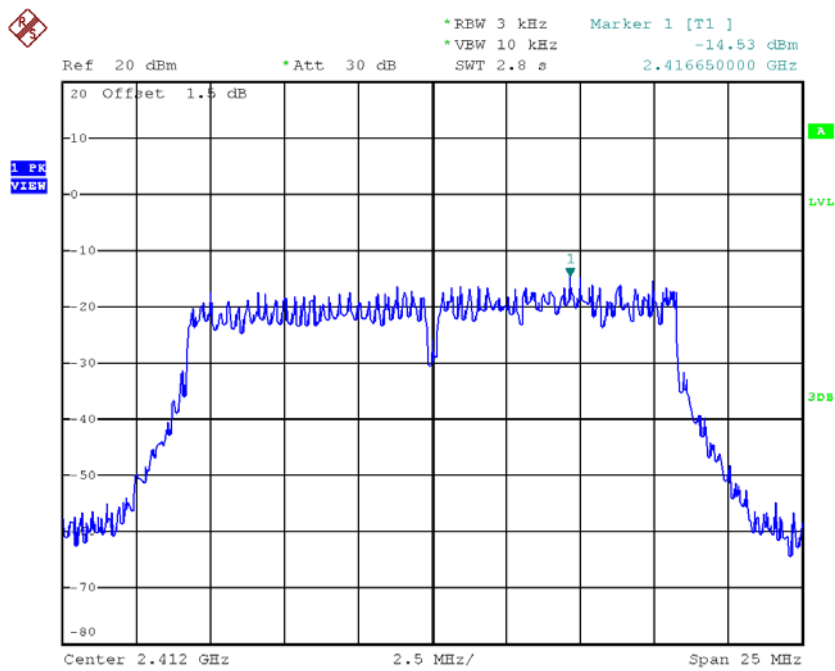

Date: 30.AUG.2018 09:58:03

TX CH06

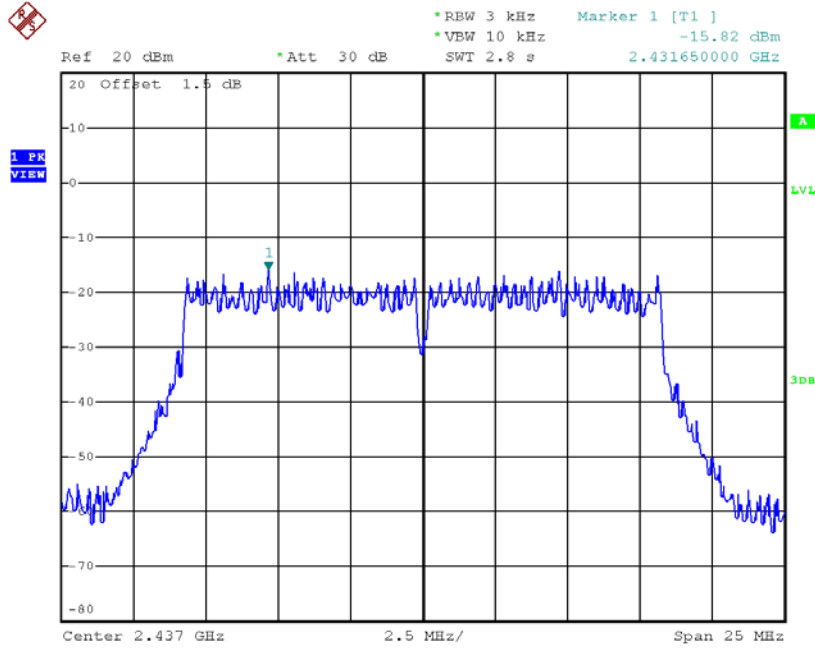

Date: 30.AUG.2018 09:59:20

TX CH11

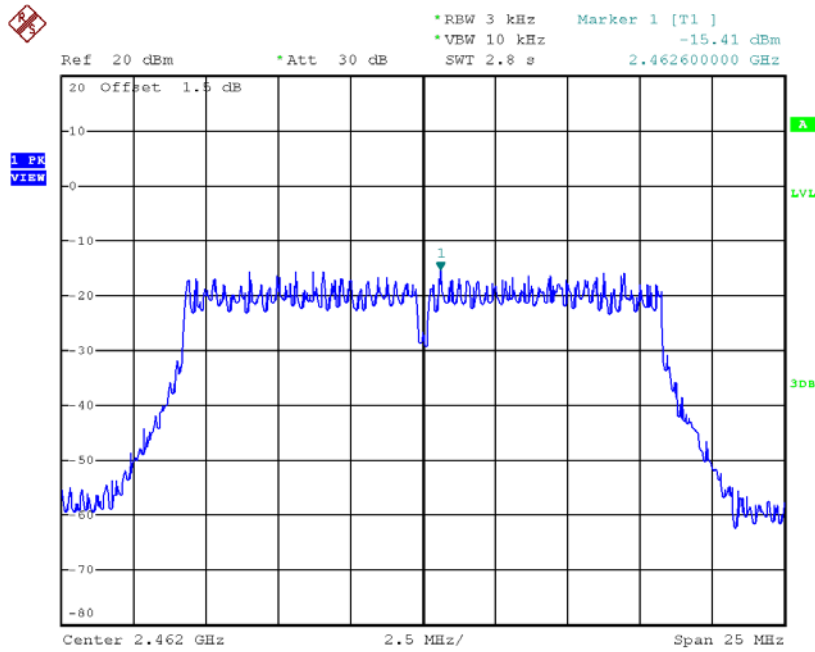

Date: 30.AUG.2018 10:01:31

Test Mode: TX N-20M Mode_CH01/06/11

Frequency (MHz)	Power Density (dBm/3 kHz)	Power Density (mW/3 kHz)	Max. Limit (dBm/3 kHz)	Result
2412	-14.74	0.0336	8.00	Complies
2437	-16.00	0.0251	8.00	Complies
2462	-13.42	0.0455	8.00	Complies

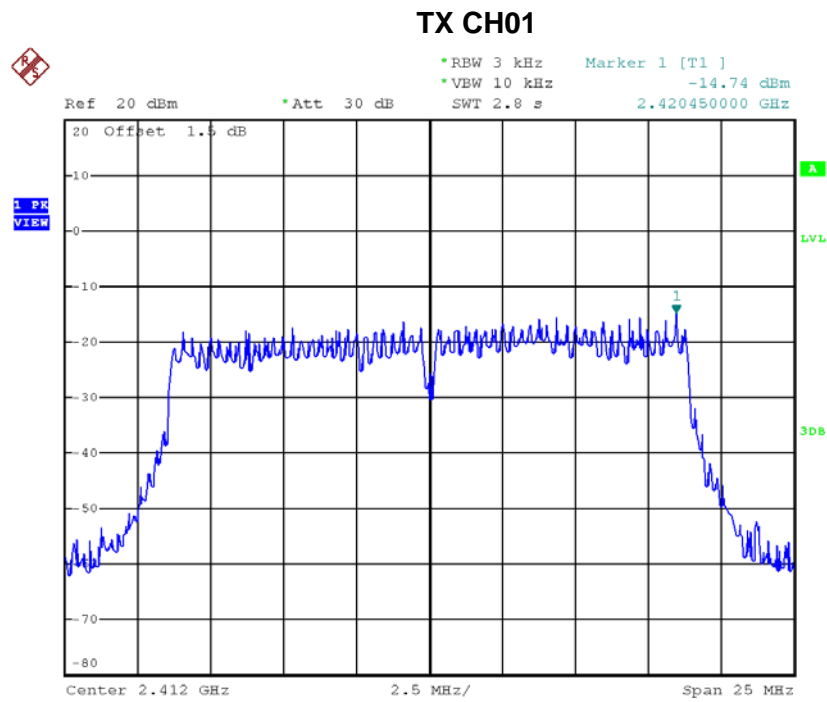

Date: 30.AUG.2018 10:03:02

TX CH06

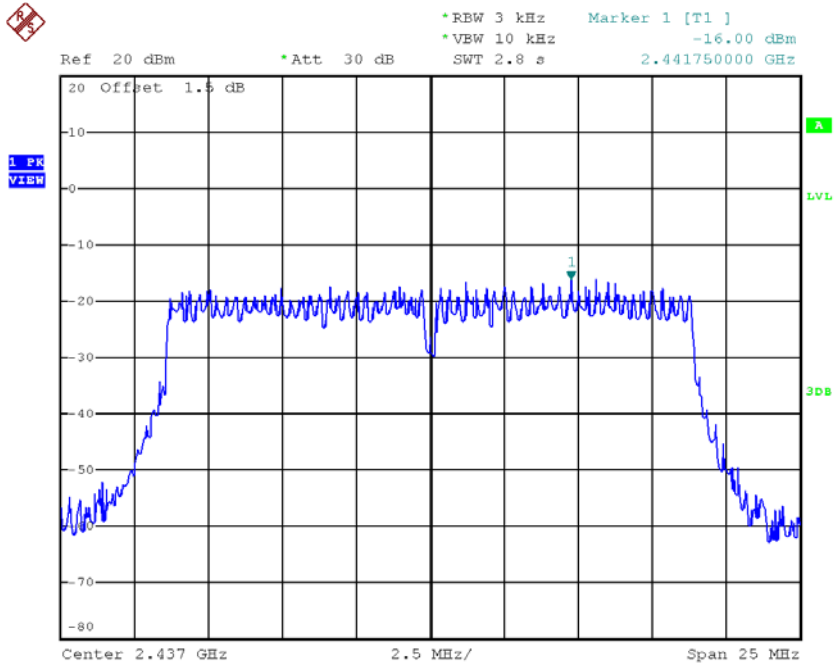

Date: 30.AUG.2018 10:04:16

TX CH11

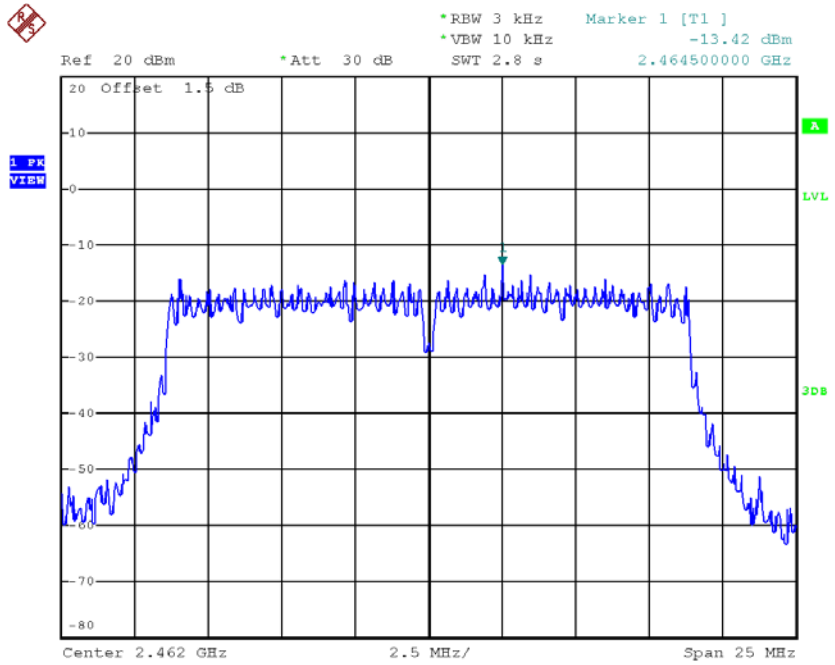

Date: 30.AUG.2018 10:06:15

Test Mode: TX N-40M Mode_CH03/06/09

Frequency (MHz)	Power Density (dBm/3 kHz)	Power Density (mW/3 kHz)	Max. Limit (dBm/3 kHz)	Result
2422	-18.46	0.0143	8.00	Complies
2437	-19.31	0.0117	8.00	Complies
2452	-18.85	0.0130	8.00	Complies

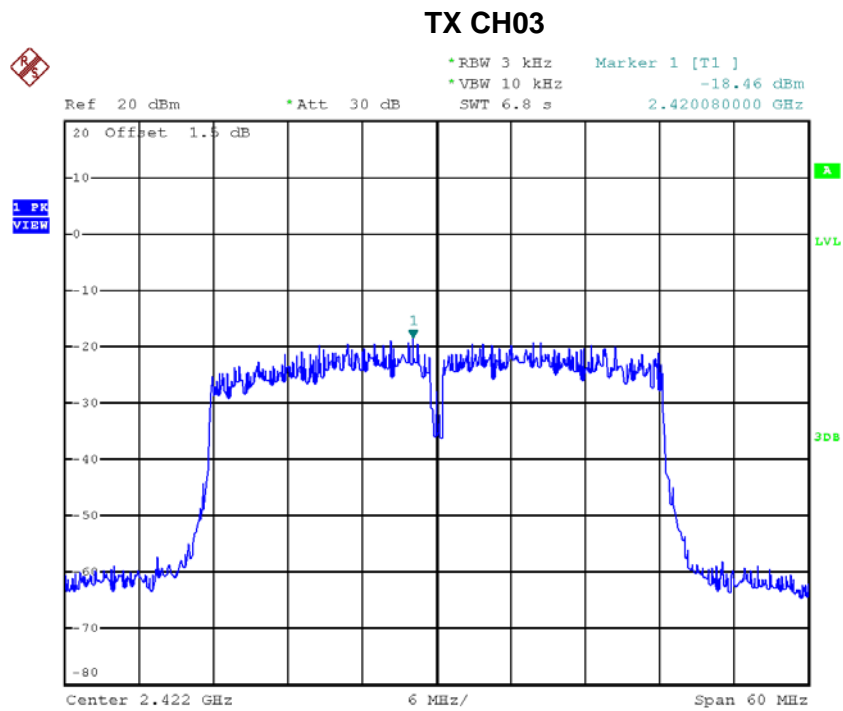

Date: 30.AUG.2018 10:08:58

TX CH06

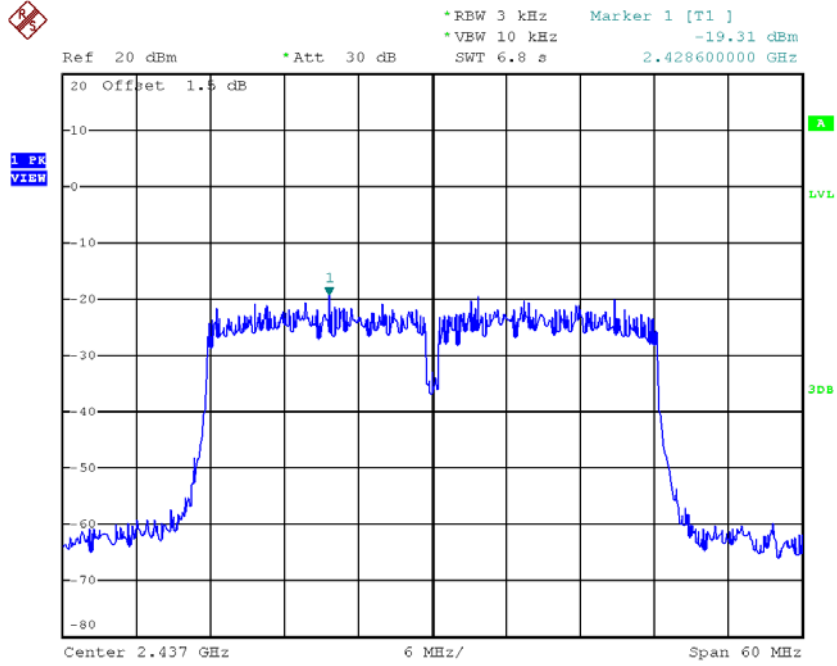

Date: 30.AUG.2018 10:10:24

TX CH09

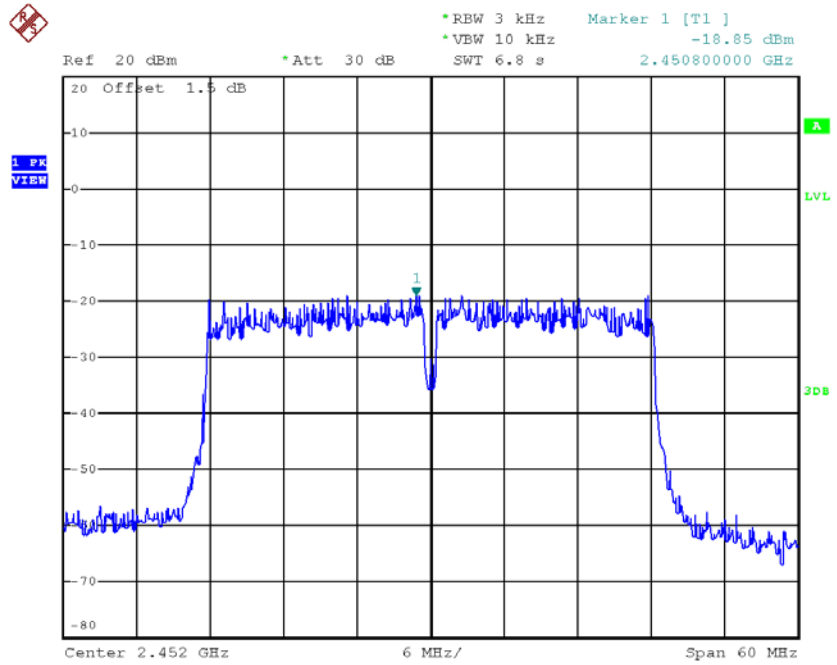

Date: 30.AUG.2018 10:12:04