

# FCC Radio Test Report

## FCC ID: QISAGS-L03

This report concerns (check one): Original Grant Class I Change Class II Change

**Project No.** : 1705C003  
**Equipment** : Huawei MediaPad T3 10 (MediaPad T3 10 for short)  
**Model Name** : AGS-L03  
**Applicant** : Huawei Technologies Co., Ltd.  
**Address** : Administration Building, Headquarters of Huawei Technologies Co., Ltd., Bantian, Longgang District, Shenzhen, 518129, P.R.C

**Date of Receipt** : May 02, 2017  
**Date of Test** : May 02, 2017 ~ May 19, 2017  
**Issued Date** : May 22, 2017  
**Tested by** : BTL Inc.

**Testing Engineer** : Shawn Xiao  
(Shawn Xiao)

**Technical Manager** : David Mao  
(David Mao)

**Authorized Signatory** : Steven Lu  
(Steven Lu)

# **B T L I N C .**

No.3, Jinshagang 1st Road, Shixia, Dalang Town, Dongguan, Guangdong, China.

TEL: +86-769-8318-3000 FAX: +86-769-8319-6000

**Declaration**

**BTL** represents to the client that testing is done in accordance with standard procedures as applicable and that test instruments used has been calibrated with standards traceable to international standard(s) and/or national standard(s).

**BTL's** reports apply only to the specific samples tested under conditions. It is manufacture's responsibility to ensure that additional production units of this model are manufactured with the identical electrical and mechanical components. **BTL** shall have no liability for any declarations, inferences or generalizations drawn by the client or others from **BTL** issued reports.

**BTL's** report must not be used by the client to claim product certification, approval, or endorsement by NVLAP, NIST, or any agency of the Federal Government.

This report is the confidential property of the client. As a mutual protection to the clients, the public and **BTL-self**, extracts from the test report shall not be reproduced except in full with **BTL's** authorized written approval.

**BTL's** laboratory quality assurance procedures are in compliance with the **ISO Guide 17025** requirements, and accredited by the conformity assessment authorities listed in this test report.

**Limitation**

For the use of the authority's logo is limited unless the Test Standard(s)/Scope(s)/Item(s) mentioned in this test report is (are) included in the conformity assessment authorities acceptance respective.

Table of Contents	Page
<b>1 . CERTIFICATION</b>	<b>6</b>
<b>2 . SUMMARY OF TEST RESULTS</b>	<b>7</b>
2.1 TEST FACILITY	8
2.2 MEASUREMENT UNCERTAINTY	8
<b>3 . GENERAL INFORMATION</b>	<b>9</b>
3.1 GENERAL DESCRIPTION OF EUT	9
3.2 DESCRIPTION OF TEST MODES	11
3.3 TABLE OF PARAMETERS OF TEXT SOFTWARE SETTING	13
3.4 BLOCK DIAGRAM SHOWING THE CONFIGURATION OF SYSTEM TESTED	14
3.5 DESCRIPTION OF SUPPORT UNITS	14
<b>4 . EMC EMISSION TEST</b>	<b>15</b>
4.1 CONDUCTED EMISSION MEASUREMENT	15
4.1.1 POWER LINE CONDUCTED EMISSION LIMITS	15
4.1.2 TEST PROCEDURE	15
4.1.3 DEVIATION FROM TEST STANDARD	15
4.1.4 TEST SETUP	16
4.1.5 EUT OPERATING CONDITIONS	16
4.1.6 EUT TEST CONDITIONS	16
4.1.7 TEST RESULTS	16
4.2 RADIATED EMISSION MEASUREMENT	17
4.2.1 RADIATED EMISSION LIMITS	17
4.2.2 TEST PROCEDURE	18
4.2.3 DEVIATION FROM TEST STANDARD	18
4.2.4 TEST SETUP	19
4.2.5 EUT OPERATING CONDITIONS	20
4.2.6 EUT TEST CONDITIONS	20
4.2.7 TEST RESULTS (9KHZ TO 30MHZ)	21
4.2.8 TEST RESULTS (30MHZ TO 1000 MHZ)	21
4.2.9 TEST RESULTS (ABOVE 1000 MHZ)	21
<b>5 . BANDWIDTH TEST</b>	<b>22</b>
5.1 APPLIED PROCEDURES	22
5.1.1 TEST PROCEDURE	22
5.1.2 DEVIATION FROM STANDARD	22
5.1.3 TEST SETUP	22
5.1.4 EUT OPERATION CONDITIONS	22
5.1.5 EUT TEST CONDITIONS	22
5.1.6 TEST RESULTS	22
<b>6 . MAXIMUM PEAK CONDUCTED OUTPUT POWER TEST</b>	<b>23</b>

<b>Table of Contents</b>	<b>Page</b>
<b>6.1 APPLIED PROCEDURES / LIMIT</b>	<b>23</b>
6.1.1 TEST PROCEDURE	23
6.1.2 DEVIATION FROM STANDARD	23
6.1.3 TEST SETUP	23
6.1.4 EUT OPERATION CONDITIONS	23
6.1.5 EUT TEST CONDITIONS	23
6.1.6 TEST RESULTS	23
<b>7 . ANTENNA CONDUCTED SPURIOUS EMISSION</b>	<b>24</b>
7.1 APPLIED PROCEDURES / LIMIT	24
7.1.1 TEST PROCEDURE	24
7.1.2 DEVIATION FROM STANDARD	24
7.1.3 TEST SETUP	24
7.1.4 EUT OPERATION CONDITIONS	24
7.1.5 EUT TEST CONDITIONS	24
7.1.6 TEST RESULTS	24
<b>8 . POWER SPECTRAL DENSITY TEST</b>	<b>25</b>
8.1 APPLIED PROCEDURES / LIMIT	25
8.1.1 TEST PROCEDURE	25
8.1.2 DEVIATION FROM STANDARD	25
8.1.3 TEST SETUP	25
8.1.4 EUT OPERATION CONDITIONS	25
8.1.5 EUT TEST CONDITIONS	25
8.1.6 TEST RESULTS	25
<b>9 . MEASUREMENT INSTRUMENTS LIST</b>	<b>26</b>
<b>ATTACHMENT A - CONDUCTED EMISSION</b>	<b>28</b>
<b>ATTACHMENT B - RADIATED EMISSION (9KHZ TO 30MHZ)</b>	<b>35</b>
<b>ATTACHMENT C - RADIATED EMISSION (30MHZ TO 1000MHZ)</b>	<b>48</b>
<b>ATTACHMENT D - RADIATED EMISSION (ABOVE 1000MHZ)</b>	<b>61</b>
<b>ATTACHMENT E - BANDWIDTH</b>	<b>108</b>
<b>ATTACHMENT F – MAXIMUM PEAK CONDUCTED OUTPUT POWER</b>	<b>115</b>
<b>ATTACHMENT G - ANTENNA CONDUCTED SPURIOUS EMISSION</b>	<b>117</b>
<b>ATTACHMENT H - POWER SPECTRAL DENSITY</b>	<b>136</b>

### REPORT ISSUED HISTORY

Issued No.	Description	Issued Date
BTL-FCCP-3-1705C003	Original Issue.	May 22, 2017

## 1. CERTIFICATION

Equipment : Huawei MediaPad T3 10 (MediaPad T3 10 for short)  
Brand Name : HUAWEI  
Model Name : AGS-L03  
Applicant : Huawei Technologies Co., Ltd.  
Manufacturer : Huawei Technologies Co., Ltd.  
Address : Administration Building, Headquarters of Huawei Technologies Co., Ltd.,  
Bantian, Longgang District, Shenzhen, 518129, P.R.C  
Factory : Huawei Technologies Co., Ltd.  
Address : Administration Building, Headquarters of Huawei Technologies Co., Ltd.,  
Bantian, Longgang District, Shenzhen, 518129, P.R.C  
Date of Test : May 02, 2017 ~ May 19, 2017  
Test Sample : Engineering Sample  
Standard(s) : FCC Part15, Subpart C:(15.247) / ANSI C63.10-2013

The above equipment has been tested and found compliance with the requirement of the relative standards by BTL Inc.

The test data, data evaluation, and equipment configuration contained in our test report (Ref No. BTL-FCCP-3-1705C003) were obtained utilizing the test procedures, test instruments, test sites that has been accredited by the Authority of TAF according to the ISO-17025 quality assessment standard and technical standard(s).

**Test result included in this report is only for the WLAN 2.4G part.**

## 2. SUMMARY OF TEST RESULTS

Test procedures according to the technical standard(s):

Applied Standard(s): FCC Part15 (15.247) , Subpart C				
Standard(s)	Section	Test Item	Judgment	Remark
	15.207	Conducted Emission	PASS	
	15.247(d)	Antenna conducted Spurious Emission	PASS	
	15.247(a)(2)	6dB Bandwidth	PASS	
	15.247(b)(3)	Peak Output Power	PASS	
	15.247(e)	Power Spectral Density	PASS	
	15.203	Antenna Requirement	PASS	
	15.247(d)/ 15.205/ 15.209	Transmitter Radiated Emissions	PASS	

Note:

(1) "N/A" denotes test is not applicable in this test report.

## 2.1 TEST FACILITY

The test facilities used to collect the test data in this report is at the location of No.3, Jinshagang 1st Road, Shixia, Dalang Town, Dongguan, Guangdong, China.  
 BTL's test firm number for FCC: 319330

## 2.2 MEASUREMENT UNCERTAINTY

Where relevant, the following measurement uncertainty levels have been estimated for tests performed on the EUT as specified in CISPR 16-4-2. The BTL measurement uncertainty is less than the CISPR 16-4-2  $U_{\text{CISPR}}$  requirement.

The reported uncertainty of measurement  $y \pm U$ , where expanded uncertainty  $U$  is based on a standard uncertainty multiplied by a coverage factor of  $k=2$ , providing a level of confidence of approximately 95 %.

### A. Conducted Measurement:

Test Site	Method	Measurement Frequency Range	U, (dB)
DG-C02	CISPR	150 KHz ~ 30MHz	2.32

### B. Radiated Measurement:

Test Site	Method	Measurement Frequency Range	Ant. H / V	U, (dB)
DG-CB03	CISPR	9KHz~30MHz	V	3.79
		9KHz~30MHz	H	3.57
		30MHz ~ 200MHz	V	3.82
		30MHz ~ 200MHz	H	3.78
		200MHz ~ 1,000MHz	V	4.10
		200MHz ~ 1,000MHz	H	4.06
		1GHz~18GHz	V	3.12
		1GHz~18GHz	H	3.68
		18GHz~40GHz	V	4.15
		18GHz~40GHz	H	4.14

Note: Unless specifically mentioned, the uncertainty of measurement has not been taken into account to declare the compliance or non-compliance to the specification.



### 3. GENERAL INFORMATION

#### 3.1 GENERAL DESCRIPTION OF EUT

Equipment	Huawei MediaPad T3 10 (MediaPad T3 10 for short)	
Brand Name	HUAWEI	
Model Name	AGS-L03	
Model Difference	N/A	
Product Description	Operation Frequency	2412~2462 MHz
	Modulation Technology	802.11b:DSSS 802.11g:OFDM 802.11n:OFDM
	Bit Rate of Transmitter	802.11b: 11/5.5/2/1 Mbps 802.11g: 54/48/36/24/18/12/9/6 Mbps 802.11n up to 150 Mbps
	Output Power (Max.)	802.11b: 19.12dBm 802.11g: 18.74dBm 802.11n(20MHz): 18.81dBm
Power Source	#1 DC voltage supplied from adapter. #2 Supplied from battery. #3 Supplied from USB port.	
Power Rating	#1 100-240V~ 50/60Hz 0.2A #2 DC 3.8V 4650mAh #2 DC 5V 1A	
HW Version	SH1AGSL09M	
SW Version	AGS-L03C331B005-log	

Note:

1. For a more detailed features description, please refer to the manufacturer's specifications or the user's manual.

2. Channel List:

CH01 – CH11 for 802.11b, 802.11g, 802.11n(20MHz)							
Channel	Frequency (MHz)	Channel	Frequency (MHz)	Channel	Frequency (MHz)	Channel	Frequency (MHz)
01	2412	04	2427	07	2442	10	2457
02	2417	05	2432	08	2447	11	2462
03	2422	06	2437	09	2452		

3. The EUT contains following accessory devices:

Item	Mfr/Brand	Model.
Battery	Sunwoda Electronic Co., LTD	HB3080G1EBC/
	Harbin Coslight Power Co.,Ltd.	HB3080G1EBW
Earphone	JIANGXI LIANCHUANG HONGSHENG ELECTRONIC CO., LTD	22040150
	BOLUO COUNTY QUANCHENG ELECTRONIC CO., LTD	22040150
	Goer Tek Inc	22040150
USB Cable	Shenzhen Luxshare Precision Industry Co.,Ltd.	L99U2017-CS-H
	FOXCONN INTERCONNECT TECHNOLOGY LIMITED	CUBB01M-HC304-DH
	HONGLIN TECHNOLOGY CO.,LTD	130-26988
Adapter	DONGGUAN PHITEK ELECTRONICS CO.,LTD.	HW-050100U01
	SHENZHEN HUNTKEY ELECTRONIC CO.,LTD.	HW-050100A01 HW-050100E01
	HUIZHOU BYD ELECTRONIC CO., LTD.	HW-050100B01

4. Table for Filed Antenna

Ant.	Brand	Model Name	Antenna Type	Connector	Gain (dBi)
1	N/A	N/A	Internal	N/A	-1

### 3.2 DESCRIPTION OF TEST MODES

To investigate the maximum EMI emission characteristics generates from EUT, the test system was pre-scanning tested base on the consideration of following EUT operation mode or test configuration mode which possible have effect on EMI emission level. Each of these EUT operation mode(s) or test configuration mode(s) mentioned above was evaluated respectively.

Pretest Mode	Description
Mode 1	TX B MODE CHANNEL 01/06/11
Mode 2	TX G MODE CHANNEL 01/06/11
Mode 3	TX N-20MHZ MODE CHANNEL 01/06/11
Mode 4	TX Mode

The EUT system operated these modes were found to be the worst case during the pre-scanning test as following:

For Conducted Test	
Final Test Mode	Description
Mode 5	TX Mode

For Radiated Test	
Final Test Mode	Description
Mode 1	TX B MODE CHANNEL 01/06/11
Mode 2	TX G MODE CHANNEL 01/06/11
Mode 3	TX N-20MHZ MODE CHANNEL 01/06/11

For Band Edge Test	
Final Test Mode	Description
Mode 1	TX B MODE CHANNEL 01/06/11
Mode 2	TX G MODE CHANNEL 01/06/11
Mode 3	TX N-20MHZ MODE CHANNEL 01/06/11

6dB Spectrum Bandwidth	
Final Test Mode	Description
Mode 1	TX B MODE CHANNEL 01/06/11
Mode 2	TX G MODE CHANNEL 01/06/11
Mode 3	TX N-20MHZ MODE CHANNEL 01/06/11

Maximum Conducted Output Power	
Final Test Mode	Description
Mode 1	TX B MODE CHANNEL 01/06/11
Mode 2	TX G MODE CHANNEL 01/06/11
Mode 3	TX N-20MHZ MODE CHANNEL 01/06/11

Power Spectral Density	
Final Test Mode	Description
Mode 1	TX B MODE CHANNEL 01/06/11
Mode 2	TX G MODE CHANNEL 01/06/11
Mode 3	TX N-20MHZ MODE CHANNEL 01/06/11

Note:

- (1) The measurements are performed at the high, middle, low available channels.
- (2) 802.11b mode: DBPSK (1Mbps)  
 802.11g mode: OFDM (6Mbps)  
 802.11n HT20 mode : BPSK (6.5Mbps)  
 For radiated emission tests, the highest output powers were set for final test.
- (3) For radiated below 1G test, the 802.11b is found to be the worst case and recorded.
- (4) The EUT was programmed to be in continuously transmitting mode and the transmit duty cycle is not less than 98%.

### 3.3 TABLE OF PARAMETERS OF TEXT SOFTWARE SETTING

During testing, channel & power controlling software provided by the customer was used to control the operating channel as well as the output power level. The RF output power selection is for the setting of RF output power expected by the customer and is going to be fixed on the firmware of the final end product power parameters of WLAN

Test software version	QRCT		
Frequency (MHz)	2412	2437	2462
802.11b	12	18	12
802.11g	12	18	12
802.11n (20MHz)	12	18	12

**3.4 BLOCK DIAGRAM SHOWING THE CONFIGURATION OF SYSTEM TESTED**

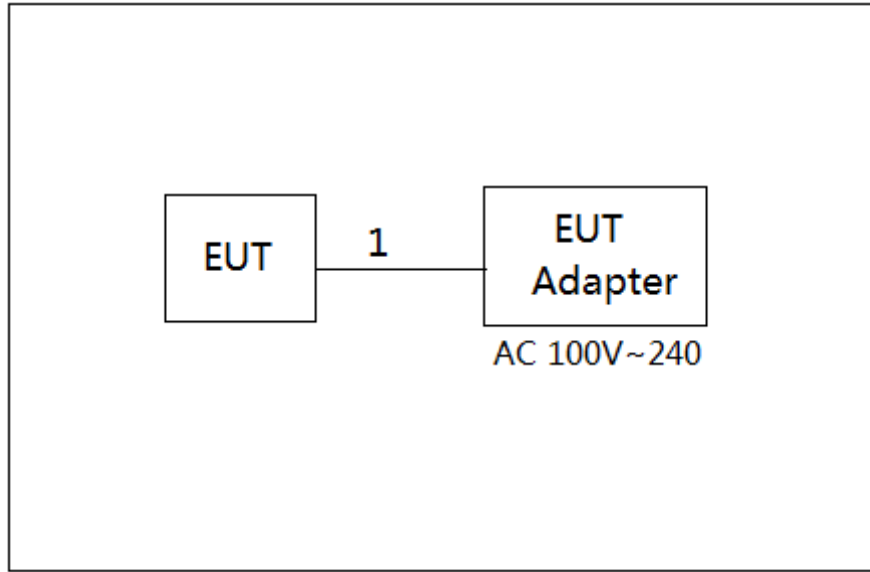

**3.5 DESCRIPTION OF SUPPORT UNITS**

The EUT has been tested as an independent unit together with other necessary accessories or support units. The following support units or accessories were used to form a representative test configuration during the tests.

Item	Equipment	Mfr/Brand	Model/Type No.	FCC ID	Series No.
-	-	-	-	-	-

Item	Shielded Type	Ferrite Core	Length	Note
1	NO	NO	1m	USB Cable

## 4. EMC EMISSION TEST

### 4.1 CONDUCTED EMISSION MEASUREMENT

#### 4.1.1 POWER LINE CONDUCTED EMISSION LIMITS (Frequency Range 150KHz-30MHz)

Frequency of Emission (MHz)	Conducted Limit (dBµV)	
	Quasi-peak	Average
0.15 -0.50	66 to 56*	56 to 46*
0.50 -5.0	56	46
5.0 -30.0	60	50

Note:

- (1) The limit of " \* " decreases with the logarithm of the frequency
- (2) The test result calculated as following:  
 Measurement Value = Reading Level + Correct Factor  
 Correct Factor = Insertion Loss + Cable Loss + Attenuator Factor(if use)  
 Margin Level = Measurement Value - Limit Value

The following table is the setting of the receiver

Receiver Parameters	Setting
Attenuation	10 dB
Start Frequency	0.15 MHz
Stop Frequency	30 MHz
IF Bandwidth	9 KHz

#### 4.1.2 TEST PROCEDURE

- a. The EUT was placed 0.8 meters from the horizontal ground plane with EUT being connected to the power mains through a line impedance stabilization network (LISN). All other support equipments powered from additional LISN(s). The LISN provide 50 Ohm/ 50uH of coupling impedance for the measuring instrument.
- b. Interconnecting cables that hang closer than 40 cm to the ground plane shall be folded back and forth in the center forming a bundle 30 to 40 cm long.
- c. I/O cables that are not connected to a peripheral shall be bundled in the center. The end of the cable may be terminated, if required, using the correct terminating impedance. The overall length shall not exceed 1 m.
- d. LISN at least 80 cm from nearest part of EUT chassis.
- e. For the actual test configuration, please refer to the related Item –EUT Test Photos.

#### 4.1.3 DEVIATION FROM TEST STANDARD

No deviation

**4.1.4 TEST SETUP**

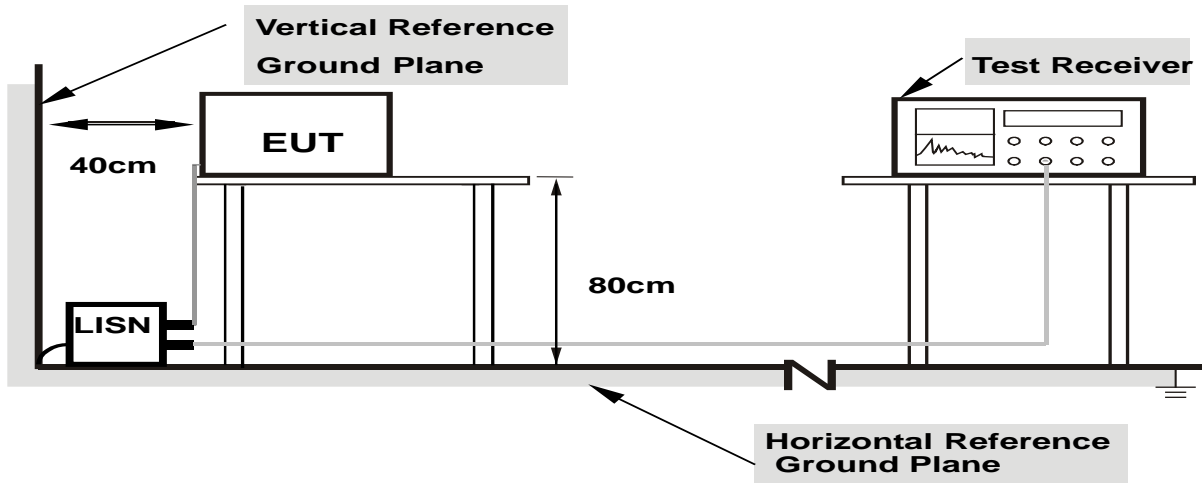

- Note:**
1. Support units were connected to second LISN.
  2. Both of LISNs (AMN) are 80 cm from EUT and at least 80 from other units and other metal planes

**4.1.5 EUT OPERATING CONDITIONS**

The EUT was placed on the test table and programmed in normal function.

**4.1.6 EUT TEST CONDITIONS**

Temperature: 25°C    Relative Humidity: 55%    Test Voltage: AC 120V/60Hz

**4.1.7 TEST RESULTS**

Please refer to the Attachment A.



## 4.2 RADIATED EMISSION MEASUREMENT

### 4.2.1 RADIATED EMISSION LIMITS

In case the emission fall within the restricted band specified on 15.205(a), then the 15.209(a) limit in the table below has to be followed.

#### LIMITS OF RADIATED EMISSION MEASUREMENT (9KHz-1000MHz)

Frequency (MHz)	Field Strength (microvolts/meter)	Measurement Distance (meters)
0.009~0.490	2400/F(KHz)	300
0.490~1.705	24000/F(KHz)	30
1.705~30.0	30	30
30~88	100	3
88~216	150	3
216~960	200	3
960~1000	500	3

#### LIMITS OF RADIATED EMISSION MEASUREMENT (Above 1000MHz)

Frequency (MHz)	Band edge at 3m (dBµV/m)		Harmonic at 1.5m (dBµV/m)	
	Peak	Average	Peak	Average
Above 1000	74	54	80 (Note 5)	60(Note 5)

#### Notes:

- (1) The limit for radiated test was performed according to FCC PART 15C.
- (2) The tighter limit applies at the band edges.
- (3) Emission level (dBuV/m)=20log Emission level (uV/m).
- (4) The test result calculated as following:  
 Measurement Value = Reading Level + Correct Factor  
 Correct Factor = Antenna Factor + Cable Loss - Amplifier Gain(if use)  
 Margin Level = Measurement Value - Limit Value

(5)

$$FS_{\text{limit}} = FS_{\text{max}} - 20 \log \left( \frac{d_{\text{limit}}}{d_{\text{measure}}} \right)$$

$$20 \log d_{\text{limit}}/d_{\text{measure}} = 20 \log 3/1.5 = 6 \text{dB.}$$

Spectrum Parameter	Setting
Attenuation	Auto
Start Frequency	1000 MHz
Stop Frequency	10th carrier harmonic
RBW / VBW (Emission in restricted band)	1MHz / 3MHz for Peak, 1MHz / 1/T for Average

Receiver Parameter	Setting
Attenuation	Auto
Start ~ Stop Frequency	9KHz~90KHz for PK/AVG detector
Start ~ Stop Frequency	90KHz~110KHz for QP detector
Start ~ Stop Frequency	110KHz~490KHz for PK/AVG detector
Start ~ Stop Frequency	490KHz~30MHz for QP detector
Start ~ Stop Frequency	30MHz~1000MHz for QP detector

**4.2.2 TEST PROCEDURE**

- a. The measuring distance of 3 m shall be used for measurements. The EUT was placed on the top of a rotating table 0.8 meter above the ground at a 3 meter semi-anechoic chamber. The table was rotated 360 degrees to determine the position of the highest radiation.(below 1GHz)
- b. The measuring distance of 3 m or 1.5m shall be used for measurements. The EUT was placed on the top of a rotating table 1.5 meter above the ground at a 3 meter semi-anechoic chamber. The table was rotated 360 degrees to determine the position of the highest radiation.(above 1GHz)
- c. The height of the equipment or of the substitution antenna shall be 0.8m or 1.5m; the height of the test antenna shall vary between 1 m to 4 m. Both horizontal and vertical polarizations of the antenna are set to make the measurement.
- d. For each suspected emission, the EUT was arranged to its worst case and then the antenna was tuned to heights find the maximum reading (used Bore sight function).
- e. The receiver system was set to peak and average detect function and specified bandwidth with maximum hold mode when the test frequency is above 1GHz.
- f. The initial step in collecting radiated emission data is a receiver peak detector mode pre-scanning the measurement frequency range. Significant peaks are then marked and then Quasi Peak detector mode re-measured.
- g. All readings are Peak unless otherwise stated QP in column of Note. Peak denotes that the Peak reading compliance with the QP Limits and then QP Mode measurement didn't perform. (below 1GHz)
- h. All readings are Peak Mode value unless otherwise stated AVG in column of Note. If the Peak Mode Measured value compliance with the Peak Limits and lower than AVG Limits, the EUT shall be deemed to meet both Peak & AVG Limits and then only Peak Mode was measured, but AVG Mode didn't perform. (above 1GHz)
- i. For the actual test configuration, please refer to the related Item –EUT Test Photos.

**4.2.3 DEVIATION FROM TEST STANDARD**

No deviation

**4.2.4 TEST SETUP**

(A) Radiated Emission Test Set-Up Frequency Below 1 GHz

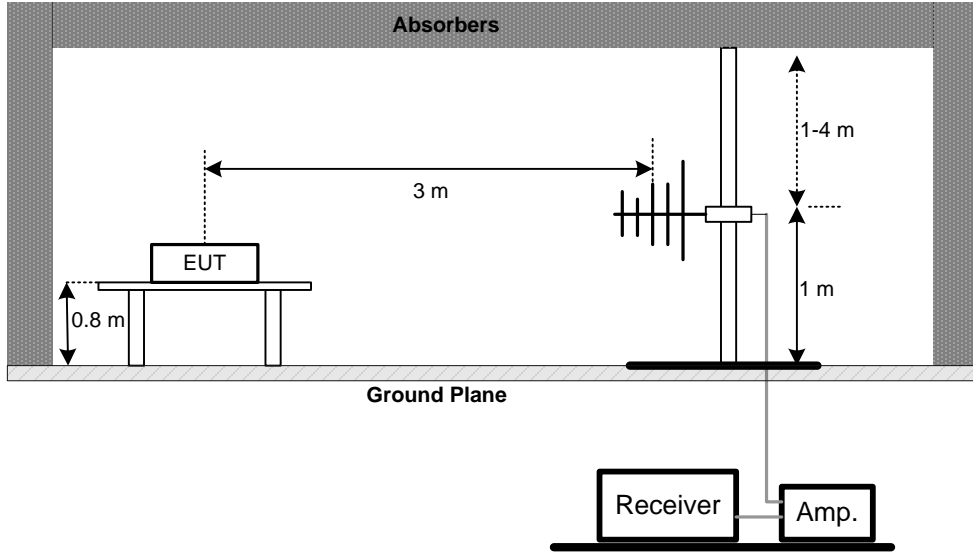

(B) Radiated Emission Test Set-Up Frequency Above 1 GHz  
Band edge

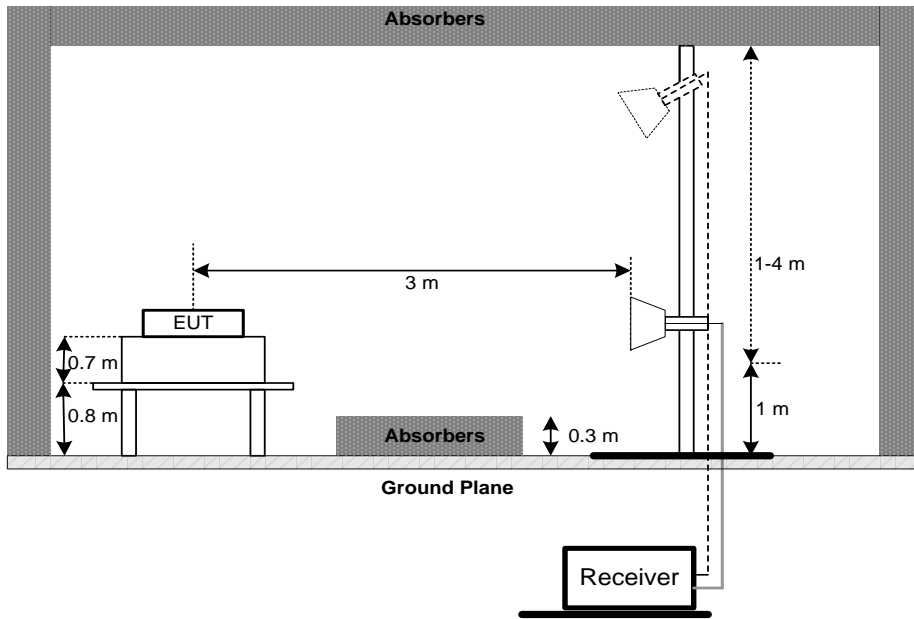

Harmonic

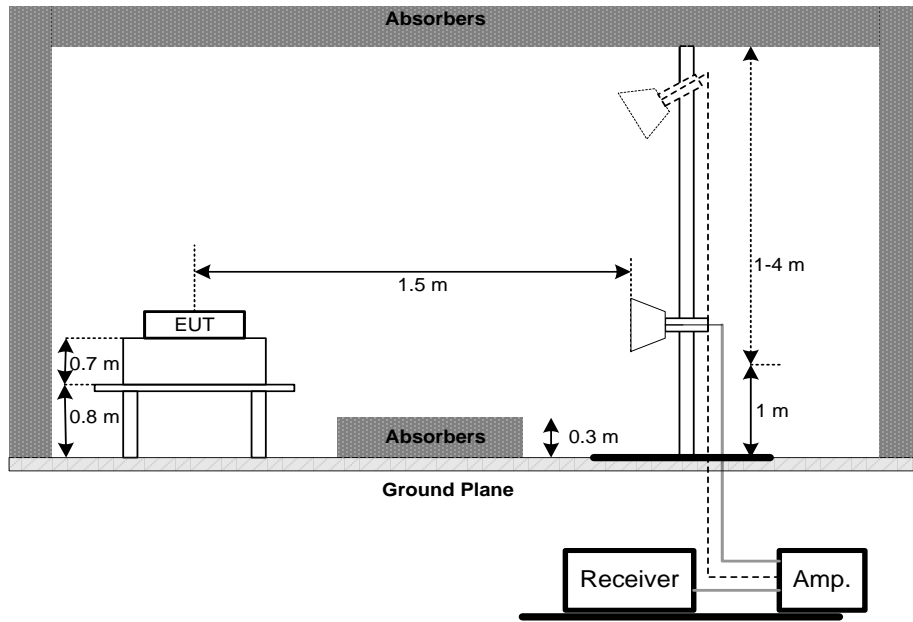

(C) For Radiated Emissions Below 30MHz

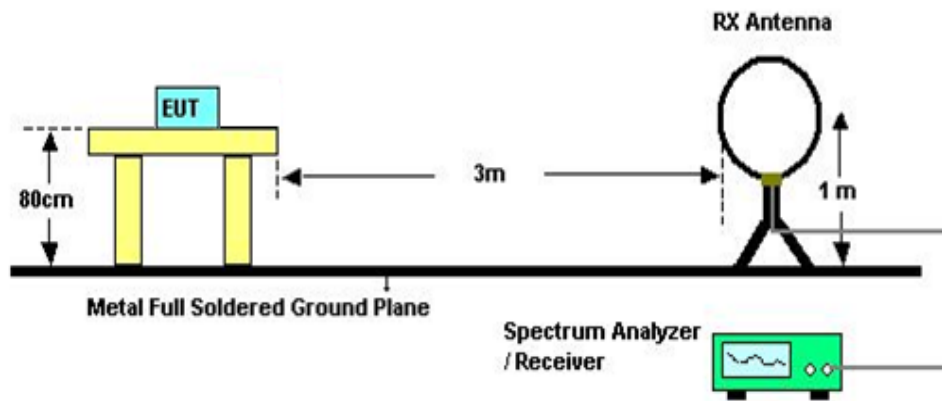

**4.2.5 EUT OPERATING CONDITIONS**

The EUT was programmed to be in continuously transmitting mode.

**4.2.6 EUT TEST CONDITIONS**

Temperature: 25°C    Relative Humidity: 55%    Test Voltage: AC 120V/60Hz

#### **4.2.7 TEST RESULTS (9KHZ TO 30MHZ)**

Please refer to the Attachment B

Remark:

- (1) The amplitude of spurious emissions which are attenuated by more than 20 dB below the permissible value has no need to be reported.
- (2) Distance extrapolation factor =  $40 \log(\text{specific distance} / \text{test distance})$  (dB).
- (3) Limit line = specific limits (dBuV) + distance extrapolation factor.

#### **4.2.8 TEST RESULTS (30MHZ TO 1000 MHZ)**

Please refer to the Attachment C.

#### **4.2.9 TEST RESULTS (ABOVE 1000 MHZ)**

Please refer to the Attachment D.

Remark:

- (1) No limit: This is fundamental signal, the judgment is not applicable.  
For fundamental signal judgment was referred to Peak output test.

**5. BANDWIDTH TEST**

**5.1 APPLIED PROCEDURES**

FCC Part15 (15.247) , Subpart C			
Section	Test Item	Frequency Range (MHz)	Result
15.247(a)(2)	Bandwidth	2400-2483.5	PASS

**5.1.1 TEST PROCEDURE**

- a. The EUT was directly connected to the spectrum analyzer and antenna output port as show in the block diagram below,
- b. Spectrum Setting: RBW= 100KHz, VBW=300KHz, Sweep time = 2.5 ms.

**5.1.2 DEVIATION FROM STANDARD**

No deviation.

**5.1.3 TEST SETUP**

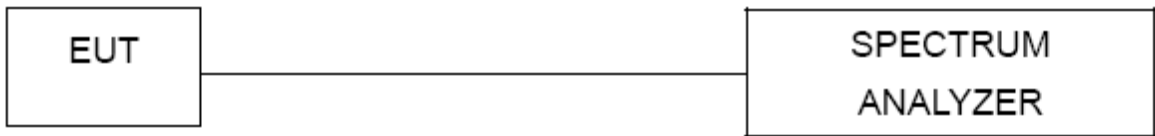

**5.1.4 EUT OPERATION CONDITIONS**

The EUT was programmed to be in continuously transmitting mode.

**5.1.5 EUT TEST CONDITIONS**

Temperature: 25°C    Relative Humidity: 55%    Test Voltage: AC 120V/60Hz

**5.1.6 TEST RESULTS**

Please refer to the Attachment E.

**6. MAXIMUM PEAK CONDUCTED OUTPUT POWER TEST**

**6.1 APPLIED PROCEDURES / LIMIT**

FCC Part15 (15.247) , Subpart C				
Section	Test Item	Limit	Frequency Range (MHz)	Result
15.247(b)(3)	Maximum Output Power	1 Watt or 30dBm	2400-2483.5	PASS

**6.1.1 TEST PROCEDURE**

- a. The EUT was directly connected to the power meter and antenna output port as show in the block diagram below,
- b. The maximum peak conducted output power was performed in accordance with method 9.1.2 of FCC KDB 558074 D01 DTS Meas Guidance.

**6.1.2 DEVIATION FROM STANDARD**

No deviation.

**6.1.3 TEST SETUP**



**6.1.4 EUT OPERATION CONDITIONS**

The EUT was programmed to be in continuously transmitting mode.

**6.1.5 EUT TEST CONDITIONS**

Temperature: 25°C    Relative Humidity: 55%    Test Voltage: AC 120V/60Hz

**6.1.6 TEST RESULTS**

Please refer to the Attachment F.

**7. ANTENNA CONDUCTED SPURIOUS EMISSION**

**7.1 APPLIED PROCEDURES / LIMIT**

In any 100 kHz bandwidth outside the frequency band in which the spread spectrum or digitally modulated device is operating, the RF power that is produced shall be at least 20 dB below that in the 100 kHz bandwidth within the band that contains the highest level of the desired power, based on either an RF conducted or a radiated measurement, provided that the transmitter demonstrates compliance with the peak conducted power limits.

**7.1.1 TEST PROCEDURE**

- a. The EUT was directly connected to the spectrum analyzer and antenna output port as show in the block diagram below,
- b. Spectrum Setting: RBW= 100KHz, VBW=300KHz, Sweep time = Auto.
- c. Offset=antenna gain+cable loss

**7.1.2 DEVIATION FROM STANDARD**

No deviation.

**7.1.3 TEST SETUP**

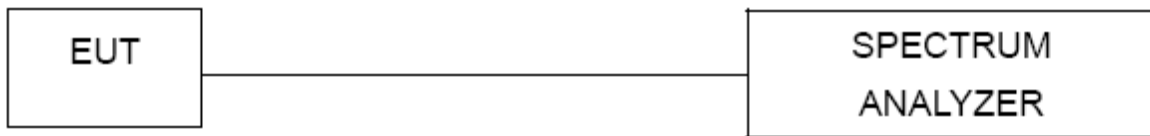

**7.1.4 EUT OPERATION CONDITIONS**

The EUT was programmed to be in continuously transmitting mode.

**7.1.5 EUT TEST CONDITIONS**

Temperature: 25°C    Relative Humidity: 55%    Test Voltage: AC 120V/60Hz

**7.1.6 TEST RESULTS**

Please refer to the Attachment G.



## 8. POWER SPECTRAL DENSITY TEST

### 8.1 APPLIED PROCEDURES / LIMIT

FCC Part15 (15.247) , Subpart C				
Section	Test Item	Limit	Frequency Range (MHz)	Result
15.247(e)	Power Spectral Density	8 dBm (in any 3KHz)	2400-2483.5	PASS

#### 8.1.1 TEST PROCEDURE

- a. The EUT was directly connected to the spectrum analyzer and antenna output port as show in the block diagram below,
- b. Spectrum Setting: RBW=3KHz, VBW=10KHz, Sweep time = Auto.

#### 8.1.2 DEVIATION FROM STANDARD

No deviation.

#### 8.1.3 TEST SETUP

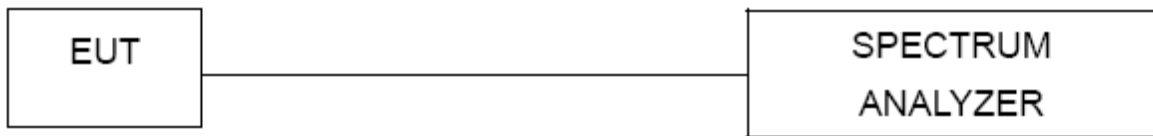

#### 8.1.4 EUT OPERATION CONDITIONS

The EUT was programmed to be in continuously transmitting mode.

#### 8.1.5 EUT TEST CONDITIONS

Temperature: 25°C    Relative Humidity: 55%    Test Voltage: AC 120V/60Hz

#### 8.1.6 TEST RESULTS

Please refer to the Attachment H.

## 9. MEASUREMENT INSTRUMENTS LIST

Conducted Emission Measurement					
Item	Kind of Equipment	Manufacturer	Type No.	Serial No.	Calibrated until
1	EMI Test Receiver	R&S	ESCI	100382	Mar. 26, 2018
2	LISN	EMCO	3816/2	52765	Mar. 26, 2018
3	50Ω Terminator	SHX	TF2-3G-A	8122901	Mar. 26, 2018
4	TWO-LINE V-NETWORK	R&S	ENV216	101447	Mar. 26, 2018
5	Cable	emci	RG223(9KHz-30MHz)(5m)	N/A	Mar. 07, 2018
6	Measurement Software	Farad	EZ-EMC Ver.NB-03A1-01	N/A	N/A

Radiated Emission Measurement					
Item	Kind of Equipment	Manufacturer	Type No.	Serial No.	Calibrated until
1	Antenna	Schwarbeck	VULB9160	9160-3232	Mar. 26, 2018
2	Amplifier	HP	8447D	2944A09673	Oct. 20, 2017
3	Receiver	AGILENT	N9038A	MY52130039	Sep. 04, 2017
4	Cable	emci	LMR-400(30MHz-1GHz)(8m+5m)	N/A	Jun. 27, 2017
5	Control	CT	SC100	N/A	N/A
6	Position Control	MF	MF-7802	MF780208416	N/A
7	Antenna	ETS	3115	00075789	Mar. 26, 2018
8	Amplifier	Agilent	8449B	3008A02274	Feb. 22, 2018
9	Receiver	AGILENT	N9038A	MY52130039	Sep. 04, 2017
10	Test Cable	emci	EMC104-SM-SM-10000(1GHz-26.5GHz)	C-68	Jun. 26, 2017
11	Controller	CT	SC100	N/A	N/A
12	Broad-Band Horn Antenna	Schwarzbeck	BBHA 9170	9170319	Apr. 22, 2018
13	Microwave Preamplifier With Adaptor	EMC INSTRUMENT	EMC2654045	980039 & HA01	Mar. 26, 2018
14	Active Loop Antenna	R&S	HFH2-Z2	830749/020	Sep. 06, 2017
15	Measurement Software	Farad	EZ-EMC Ver.NB-03A1-01	N/A	N/A

6dB Bandwidth Measurement					
Item	Kind of Equipment	Manufacturer	Type No.	Serial No.	Calibrated until
1	Spectrum Analyzer	R&S	FSP 40	100185	Sep. 04, 2017

Peak Output Power Measurement					
Item	Kind of Equipment	Manufacturer	Type No.	Serial No.	Calibrated until
1	P-series Power meter	Agilent	N1911A	MY45100473	Mar. 26, 2018
2	Wireband Power sensor	Agilent	N1921A	MY51100041	Mar. 26, 2018

Antenna Conducted Spurious Emission Measurement					
Item	Kind of Equipment	Manufacturer	Type No.	Serial No.	Calibrated until
1	Spectrum Analyzer	R&S	FSP 40	100185	Sep. 04, 2017

Power Spectral Density Measurement					
Item	Kind of Equipment	Manufacturer	Type No.	Serial No.	Calibrated until
1	Spectrum Analyzer	R&S	FSP 40	100185	Sep. 04, 2017

Remark: "N/A" denotes no model name, serial no. or calibration specified.  
 All calibration period of equipment list is one year.

## ATTACHMENT A - CONDUCTED EMISSION

Test Mode : TX Mode (Adapter: PHITEK)

**Line**

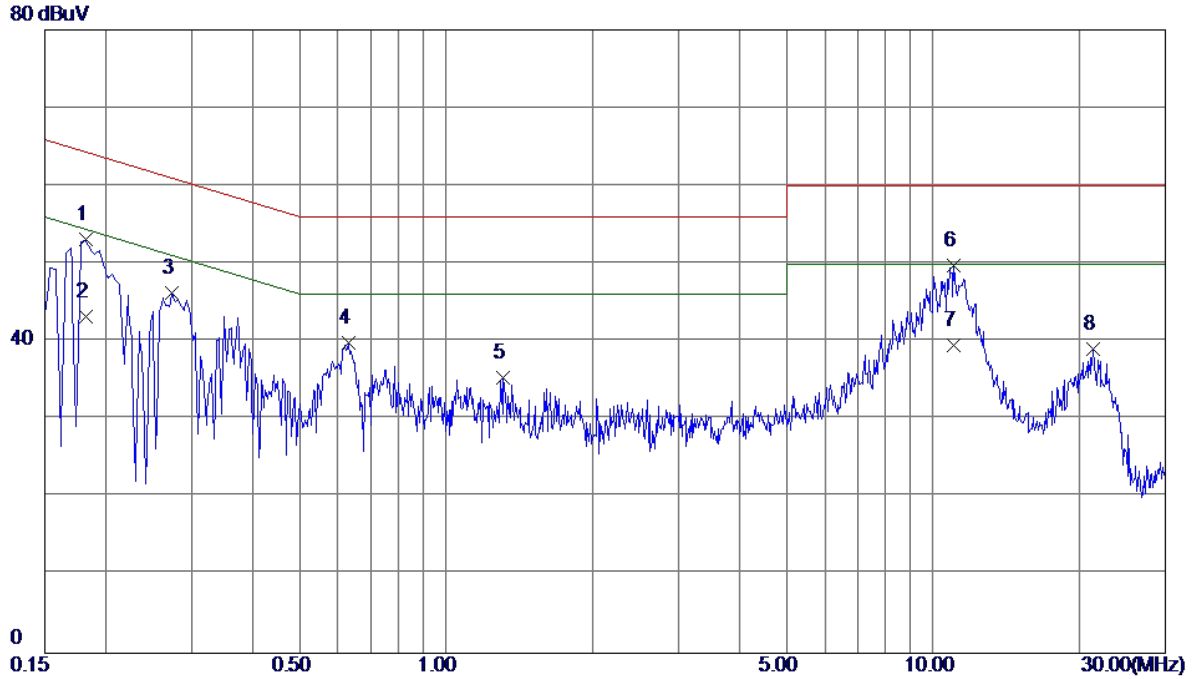

No.	Freq. MHz	Reading Level dBuV	Correct Factor dB	Measure ment dBuV	Limit dBuV	Margin dB	Detector	Comment
1	0.1819	43.38	9.73	53.11	64.40	-11.29	Peak	
2	0.1819	33.50	9.73	43.23	54.40	-11.17	AVG	
3	0.2740	36.52	9.72	46.24	61.00	-14.76	Peak	
4	0.6300	30.15	9.76	39.91	56.00	-16.09	Peak	
5	1.3099	25.63	9.80	35.43	56.00	-20.57	Peak	
6 *	11.0420	39.61	10.09	49.70	60.00	-10.30	Peak	
7	11.0420	29.40	10.09	39.49	50.00	-10.51	AVG	
8	21.3460	28.72	10.29	39.01	60.00	-20.99	Peak	

Test Mode : TX Mode (Adapter: PHITEK)

**Neutral**

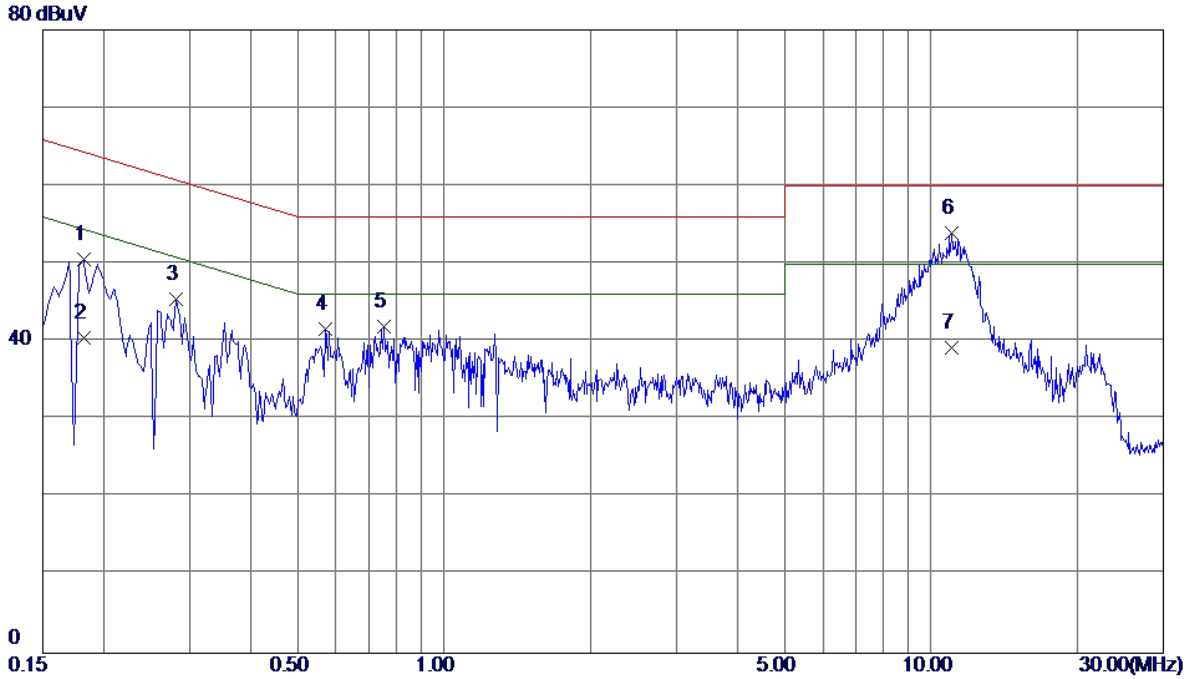

No.	Freq. MHz	Reading Level dBuV	Correct Factor dB	Measure ment dBuV	Limit dBuV	Margin dB	Detector	Comment
1	0.1819	40.92	9.65	50.57	64.40	-13.83	Peak	
2	0.1819	30.89	9.65	40.54	54.40	-13.86	AVG	
3	0.2819	35.74	9.64	45.38	60.76	-15.38	Peak	
4	0.5700	31.95	9.66	41.61	56.00	-14.39	Peak	
5	0.7539	32.20	9.66	41.86	56.00	-14.14	Peak	
6 *	11.0500	43.88	10.05	53.93	60.00	-6.07	Peak	
7	11.0500	29.10	10.05	39.15	50.00	-10.85	AVG	

Test Mode : TX Mode (Adapter: HUNTKEY)

**Line**

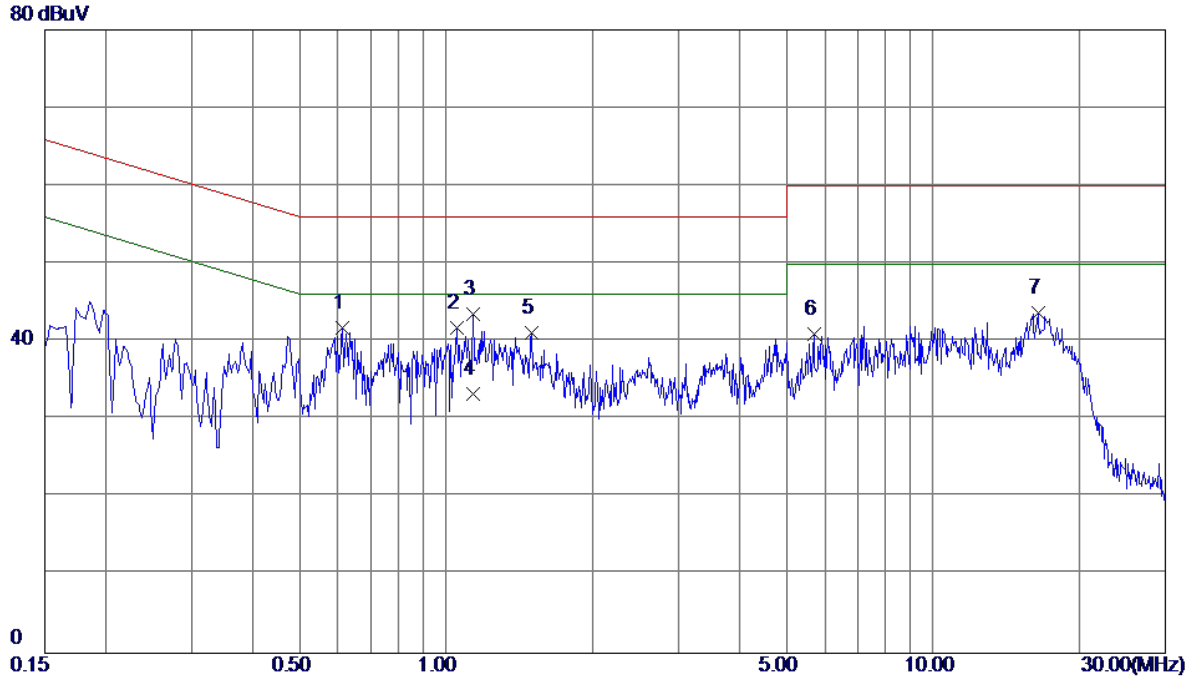

No.	Freq. MHz	Reading Level dBuV	Correct Factor dB	Measure ment dBuV	Limit dBuV	Margin dB	Detector	Comment
1	0.6140	31.99	9.76	41.75	56.00	-14.25	Peak	
2	1.0500	31.96	9.78	41.74	56.00	-14.26	Peak	
3 *	1.1380	33.74	9.79	43.53	56.00	-12.47	Peak	
4	1.1380	23.49	9.79	33.28	46.00	-12.72	AVG	
5	1.5020	31.38	9.81	41.19	56.00	-14.81	Peak	
6	5.7100	31.12	9.91	41.03	60.00	-18.97	Peak	
7	16.4580	33.41	10.26	43.67	60.00	-16.33	Peak	

Test Mode : TX Mode (Adapter: HUNTKEY)

**Neutral**

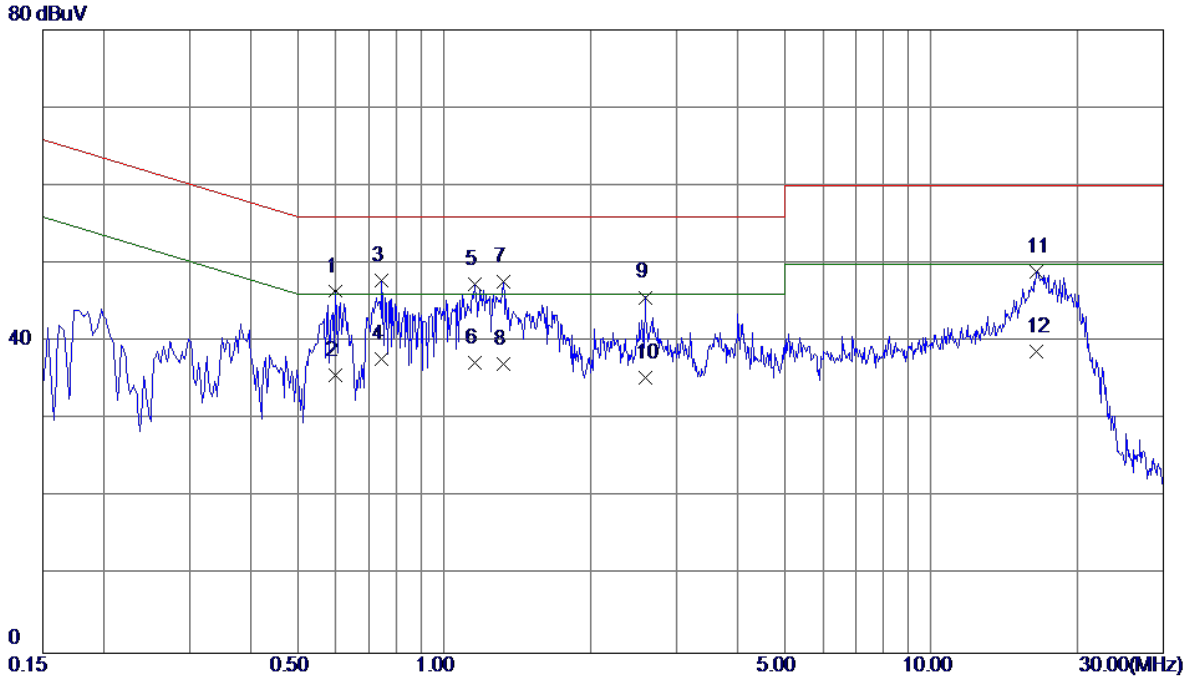

No.	Freq. MHz	Reading Level dBuV	Correct Factor dB	Measure ment dBuV	Limit dBuV	Margin dB	Detector	Comment
1	0.5980	36.82	9.66	46.48	56.00	-9.52	Peak	
2	0.5980	26.10	9.66	35.76	46.00	-10.24	AVG	
3 *	0.7460	38.15	9.66	47.81	56.00	-8.19	Peak	
4	0.7460	28.11	9.66	37.77	46.00	-8.23	AVG	
5	1.1580	37.66	9.68	47.34	56.00	-8.66	Peak	
6	1.1580	27.59	9.68	37.27	46.00	-8.73	AVG	
7	1.3220	37.98	9.68	47.66	56.00	-8.34	Peak	
8	1.3220	27.40	9.68	37.08	46.00	-8.92	AVG	
9	2.5900	35.94	9.74	45.68	56.00	-10.32	Peak	
10	2.5900	25.60	9.74	35.34	46.00	-10.66	AVG	
11	16.4780	38.66	10.31	48.97	60.00	-11.03	Peak	
12	16.4780	28.40	10.31	38.71	50.00	-11.29	AVG	



Test Mode : TX Mode (Adapter: BYD)

**Line**

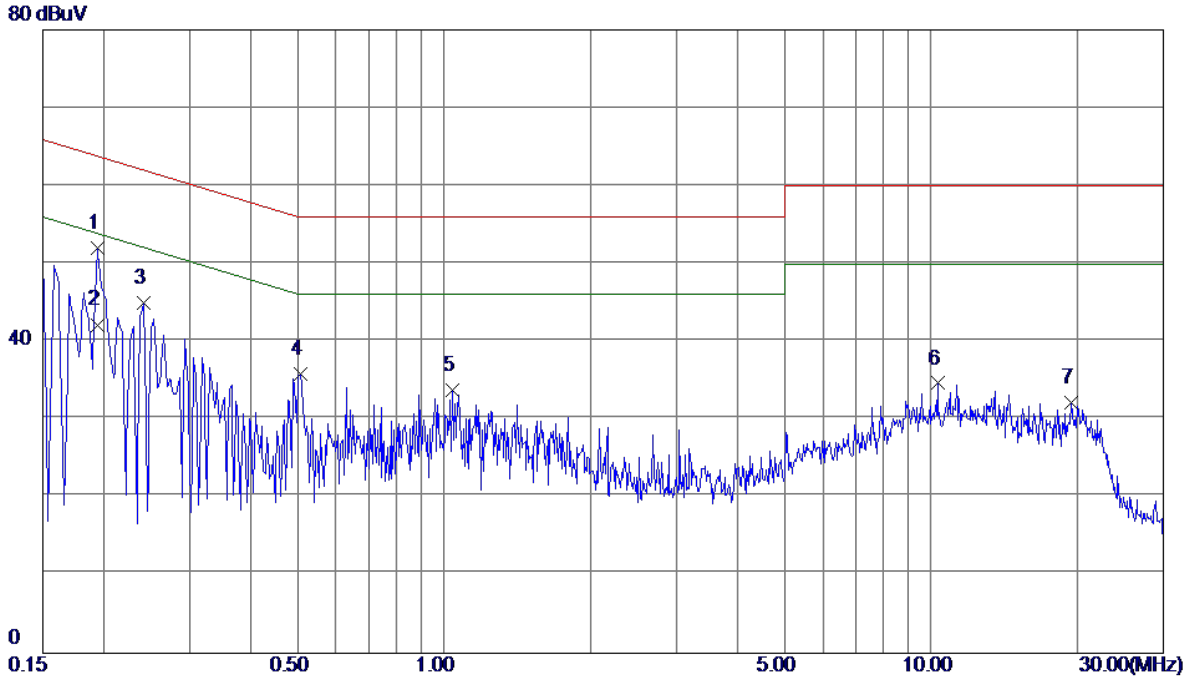

No.	Freq. MHz	Reading Level dBuV	Correct Factor dB	Measure ment dBuV	Limit dBuV	Margin dB	Detector	Comment
1	0.1940	42.20	9.73	51.93	63.86	-11.93	Peak	
2 *	0.1940	32.43	9.73	42.16	53.86	-11.70	AVG	
3	0.2420	35.20	9.73	44.93	62.03	-17.10	Peak	
4	0.5060	26.15	9.76	35.91	56.00	-20.09	Peak	
5	1.0380	24.00	9.77	33.77	56.00	-22.23	Peak	
6	10.3060	24.59	10.05	34.64	60.00	-25.36	Peak	
7	19.4340	21.89	10.26	32.15	60.00	-27.85	Peak	

Test Mode : TX Mode (Adapter: BYD)

**Neutral**

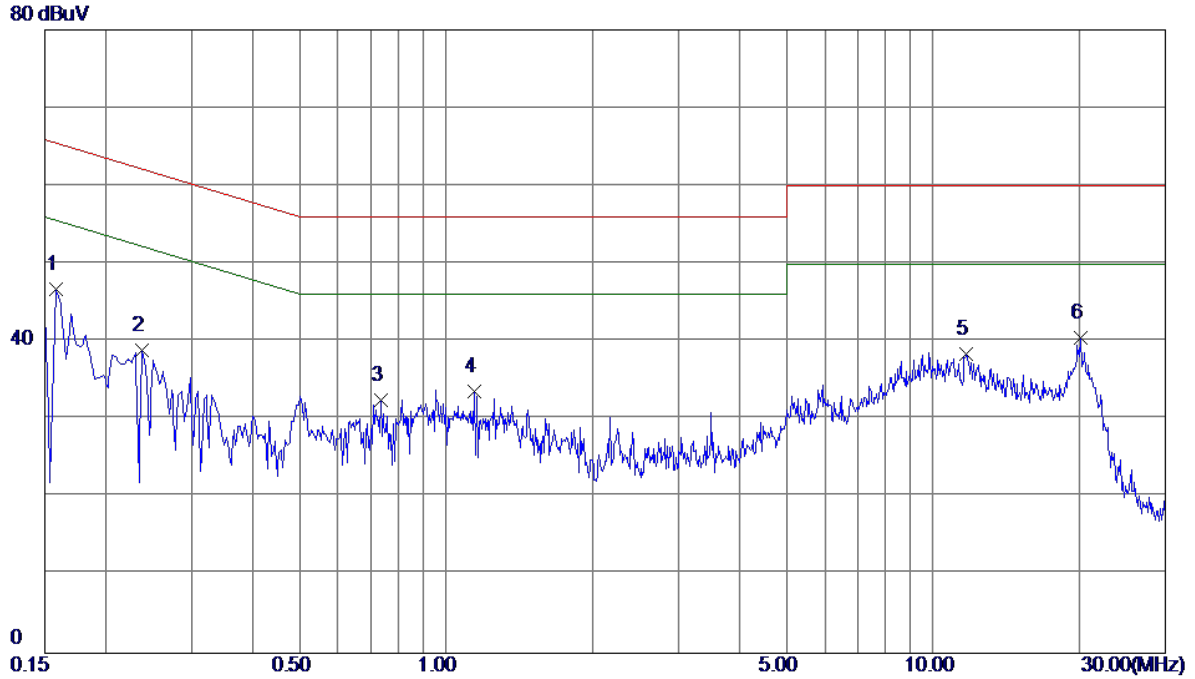

No.	Freq. MHz	Reading Level dBuV	Correct Factor dB	Measure ment dBuV	Limit dBuV	Margin dB	Detector	Comment
1 *	0.1580	37.01	9.64	46.65	65.57	-18.92	Peak	
2	0.2380	29.17	9.64	38.81	62.17	-23.36	Peak	
3	0.7340	22.87	9.66	32.53	56.00	-23.47	Peak	
4	1.1460	23.91	9.68	33.59	56.00	-22.41	Peak	
5	11.7260	28.34	10.09	38.43	60.00	-21.57	Peak	
6	20.0740	30.09	10.36	40.45	60.00	-19.55	Peak	

**ATTACHMENT B - RADIATED EMISSION (9KHZ TO 30MHZ)**

Test Mode: TX B MODE CHANNEL 01 (Adapter: PHITEK)

Ant 0°

160 dBuV/m

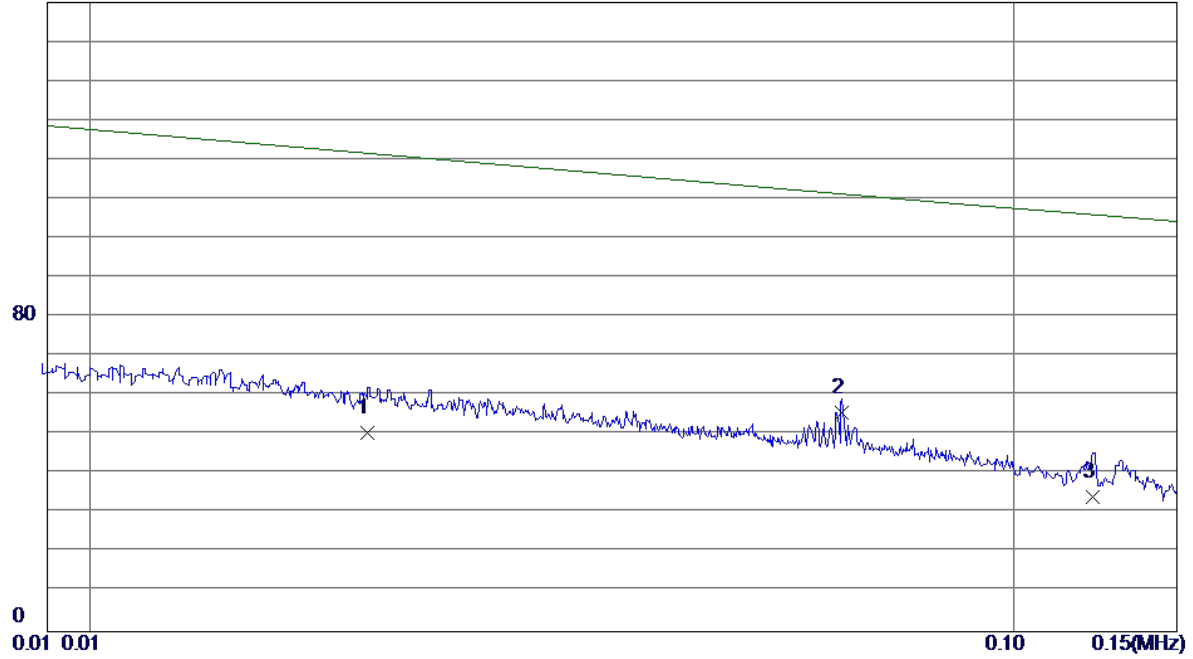

No.	Freq. MHz	Reading Level dBuV/m	Correct Factor dB	Measure ment dBuV/m	Limit dBuV/m	Margin dB	Detector	Comment
1	0.0200	30.80	19.62	50.42	125.78	-75.36	AVG	
2 *	0.0652	37.31	18.42	55.73	114.62	-58.89	AVG	
3	0.1218	16.79	17.33	34.12	106.38	-72.26	AVG	

Test Mode: TX B MODE CHANNEL 01 (Adapter: PHITEK)

Ant 0°

160 dBuV/m

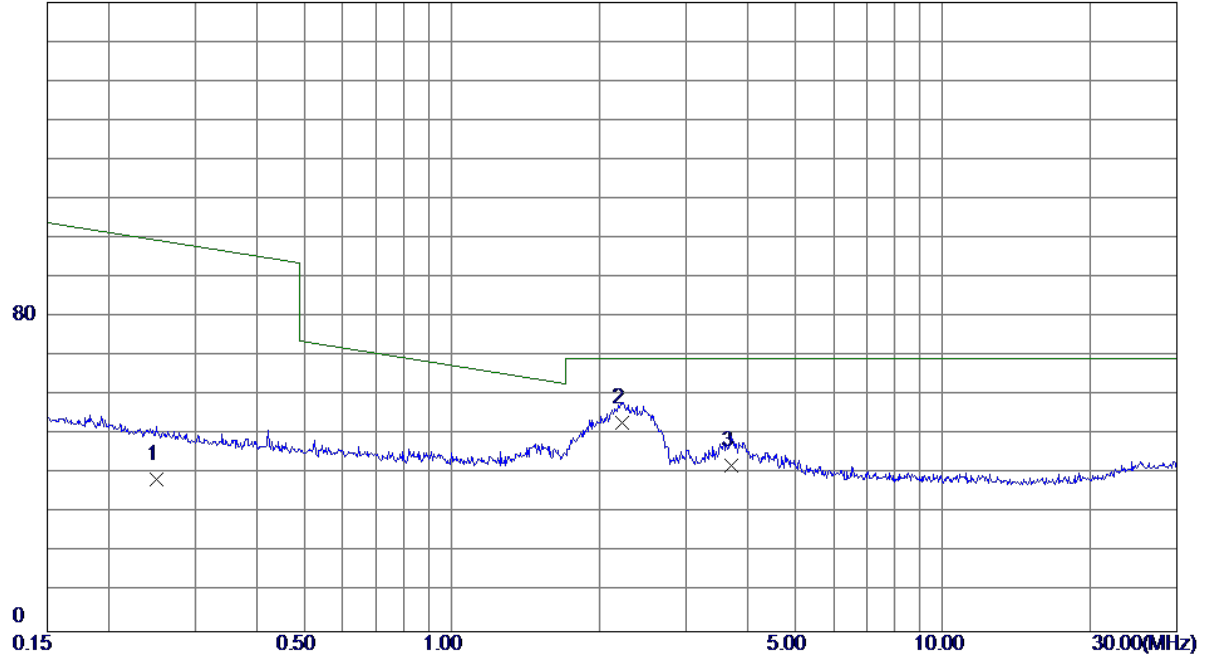

No.	Freq. MHz	Reading Level dBuV/m	Correct Factor dB	Measure ment dBuV/m	Limit dBuV/m	Margin dB	Detector	Comment
1	0.2508	22.10	16.65	38.75	101.97	-63.22	AVG	
2 *	2.2249	37.70	15.44	53.14	69.54	-16.40	QP	
3	3.7198	27.30	15.03	42.33	69.54	-27.21	QP	

Test Mode: TX B MODE CHANNEL 01 (Adapter: PHITEK)

Ant 90°

160 dBuV/m

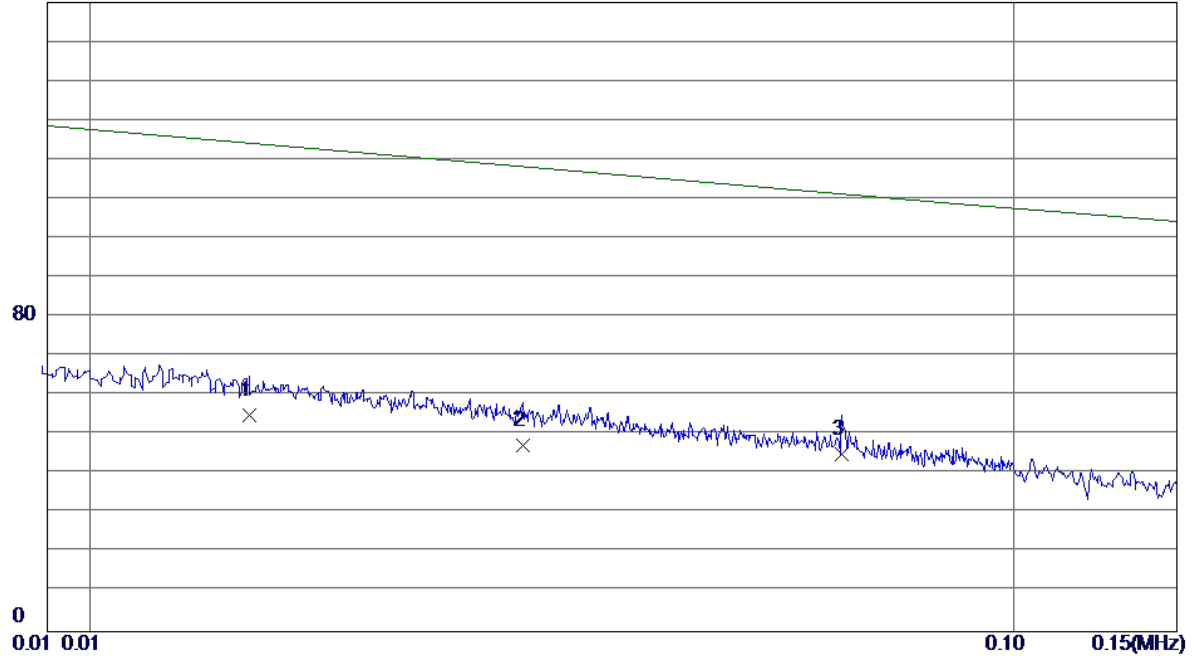

No.	Freq. MHz	Reading Level dBuV/m	Correct Factor dB	Measure ment dBuV/m	Limit dBuV/m	Margin dB	Detector	Comment
1	0.0149	34.64	20.28	54.92	127.04	-72.12	AVG	
2	0.0294	28.03	19.34	47.37	123.46	-76.09	AVG	
3 *	0.0652	26.78	18.42	45.20	114.62	-69.42	AVG	

Test Mode: TX B MODE CHANNEL 01 (Adapter: PHITEK)

Ant 90°

160 dBuV/m

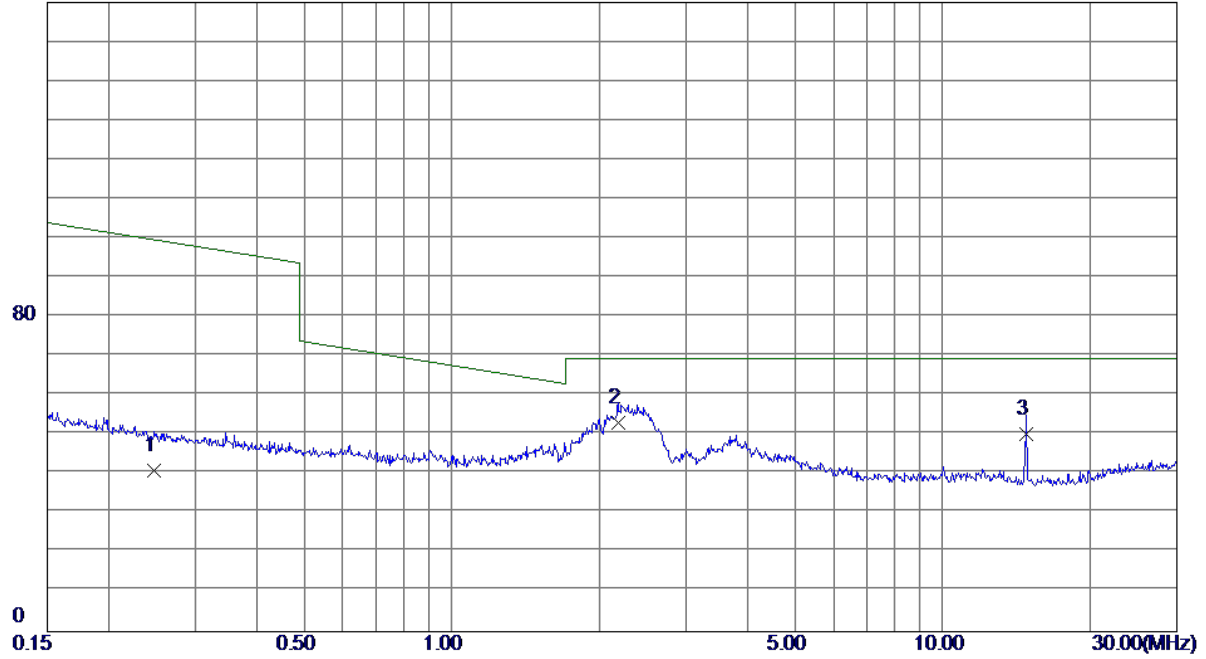

No.	Freq. MHz	Reading Level dBuV/m	Correct Factor dB	Measure ment dBuV/m	Limit dBuV/m	Margin dB	Detector	Comment
1	0.2481	24.37	16.65	41.02	102.06	-61.04	AVG	
2 *	2.1783	37.73	15.46	53.19	69.54	-16.35	QP	
3	14.8281	36.10	14.08	50.18	69.54	-19.36	QP	

Test Mode: TX B MODE CHANNEL 01 (Adapter: HUNTKEY)

Ant 0°

160 dBuV/m

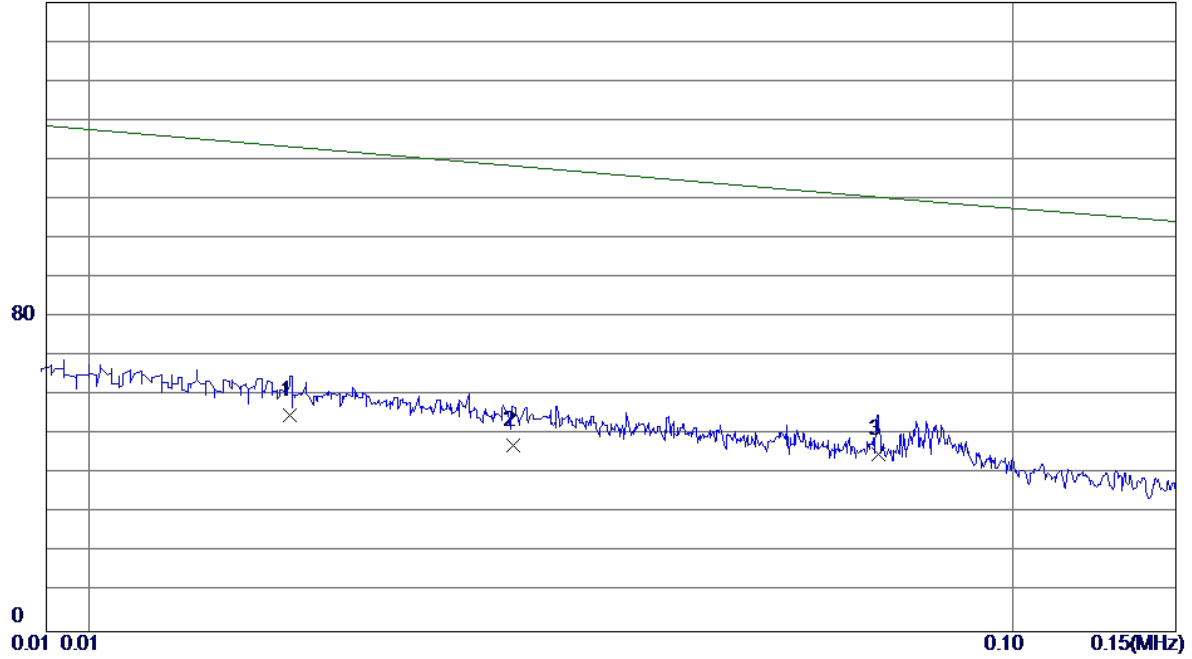

No.	Freq. MHz	Reading Level dBuV/m	Correct Factor dB	Measure ment dBuV/m	Limit dBuV/m	Margin dB	Detector	Comment
1	0.0165	35.02	20.08	55.10	126.64	-71.54	AVG	
2	0.0288	27.98	19.36	47.34	123.61	-76.27	AVG	
3 *	0.0716	26.84	18.29	45.13	113.04	-67.91	AVG	



Test Mode: TX B MODE CHANNEL 01 (Adapter: HUNTKEY)

Ant 0°

160 dBuV/m

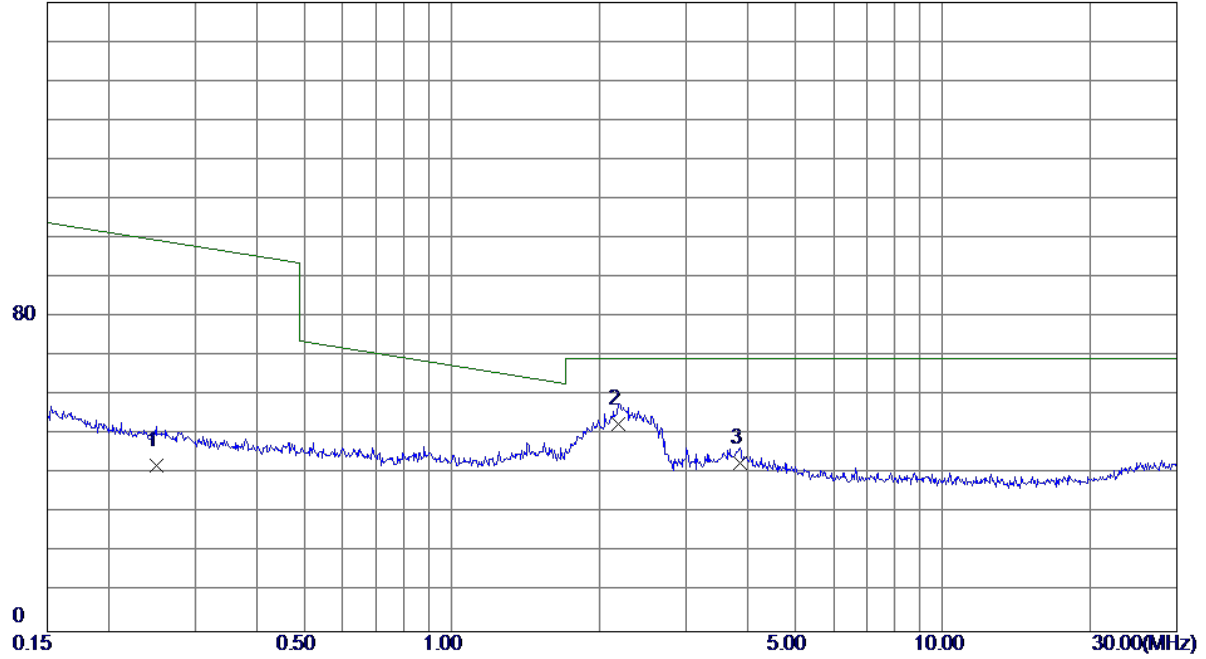

No.	Freq. MHz	Reading Level dBuV/m	Correct Factor dB	Measure ment dBuV/m	Limit dBuV/m	Margin dB	Detector	Comment
1	0.2508	25.48	16.65	42.13	101.97	-59.84	AVG	
2 *	2.1898	37.36	15.45	52.81	69.54	-16.73	QP	
3	3.8603	27.87	14.99	42.86	69.54	-26.68	QP	

Test Mode: TX B MODE CHANNEL 01 (Adapter: HUNTKEY)

Ant 90°

160 dBuV/m

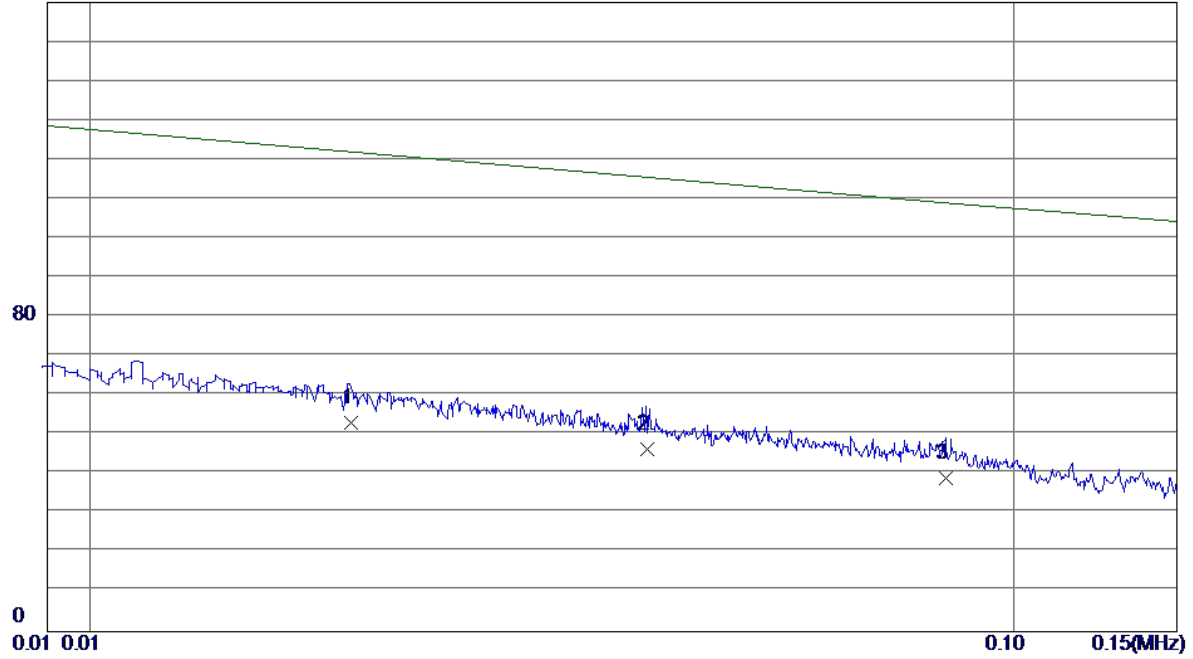

No.	Freq. MHz	Reading Level dBuV/m	Correct Factor dB	Measure ment dBuV/m	Limit dBuV/m	Margin dB	Detector	Comment
1	0.0192	33.40	19.73	53.13	125.98	-72.85	AVG	
2	0.0401	27.41	19.02	46.43	120.82	-74.39	AVG	
3 *	0.0844	21.18	18.00	39.18	109.88	-70.70	AVG	

Test Mode: TX B MODE CHANNEL 01 (Adapter: HUNTKEY)

Ant 90°

160 dBuV/m

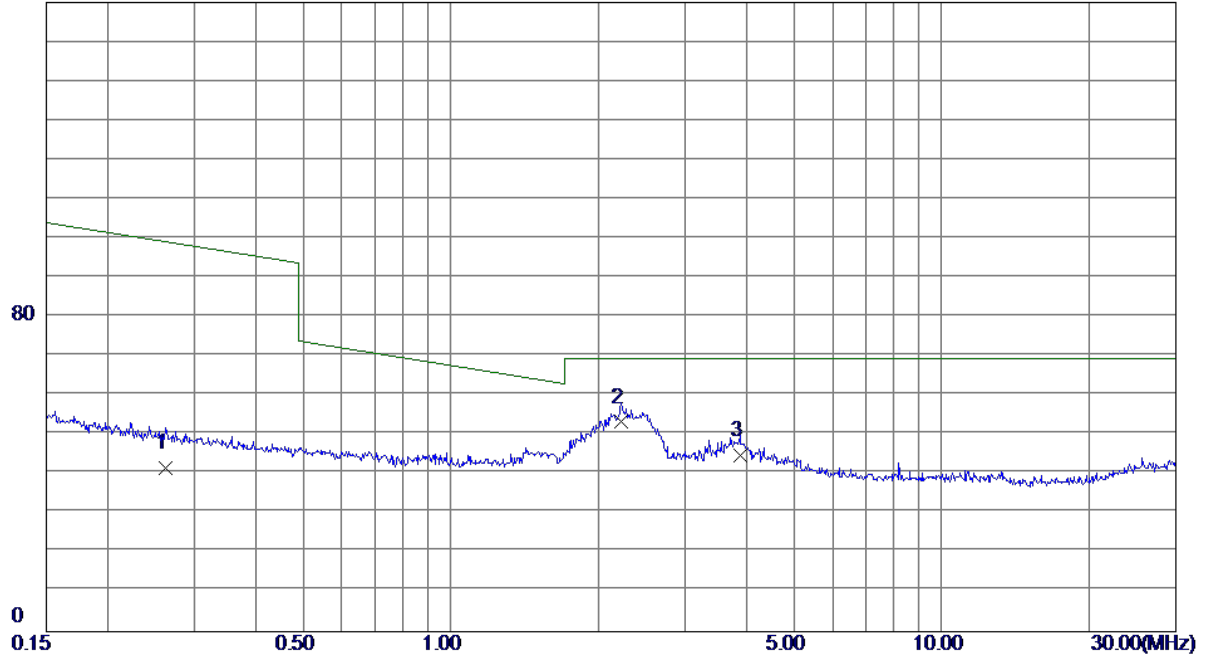

No.	Freq. MHz	Reading Level dBuV/m	Correct Factor dB	Measure ment dBuV/m	Limit dBuV/m	Margin dB	Detector	Comment
1	0.2630	25.09	16.64	41.73	101.55	-59.82	AVG	
2 *	2.2250	37.84	15.44	53.28	69.54	-16.26	QP	
3	3.8808	29.90	14.99	44.89	69.54	-24.65	QP	

Test Mode: TX B MODE CHANNEL 01 (Adapter: BYD)

Ant 0°

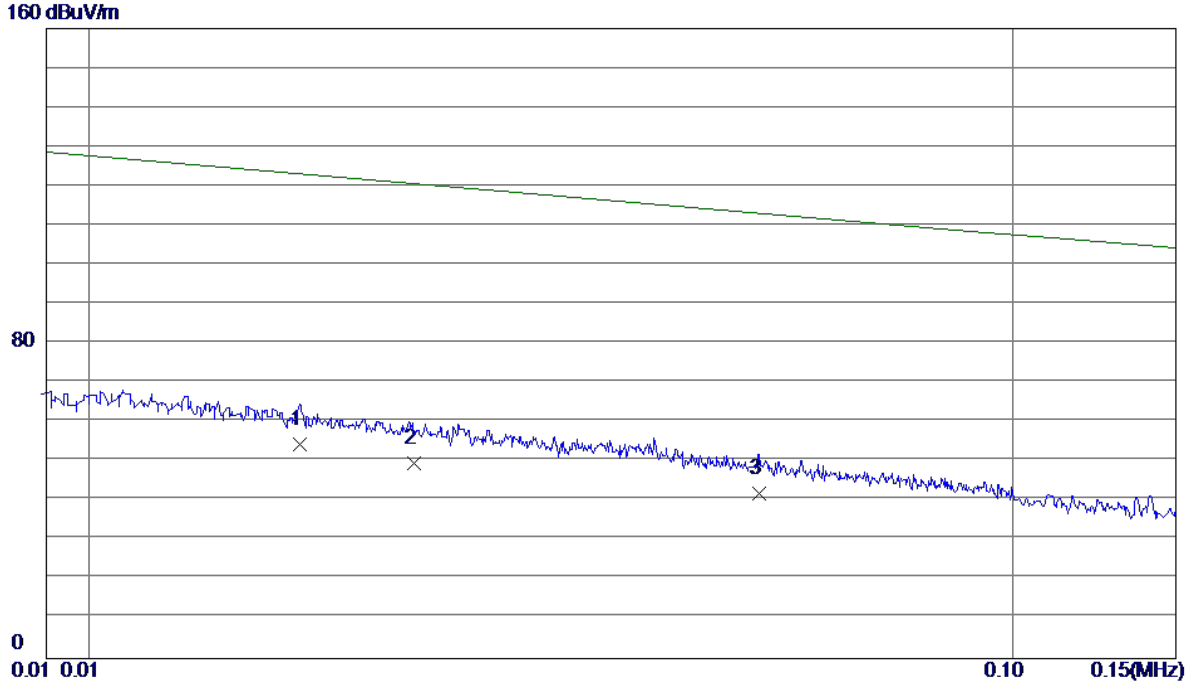

No.	Freq. MHz	Reading Level dBuV/m	Correct Factor dB	Measure ment dBuV/m	Limit dBuV/m	Margin dB	Detector	Comment
1 *	0.0169	34.53	20.02	54.55	126.54	-71.99	AVG	
2	0.0225	30.18	19.55	49.73	125.16	-75.43	AVG	
3	0.0531	23.18	18.66	41.84	117.61	-75.77	AVG	

Test Mode: TX B MODE CHANNEL 01 (Adapter: BYD)

Ant 0°

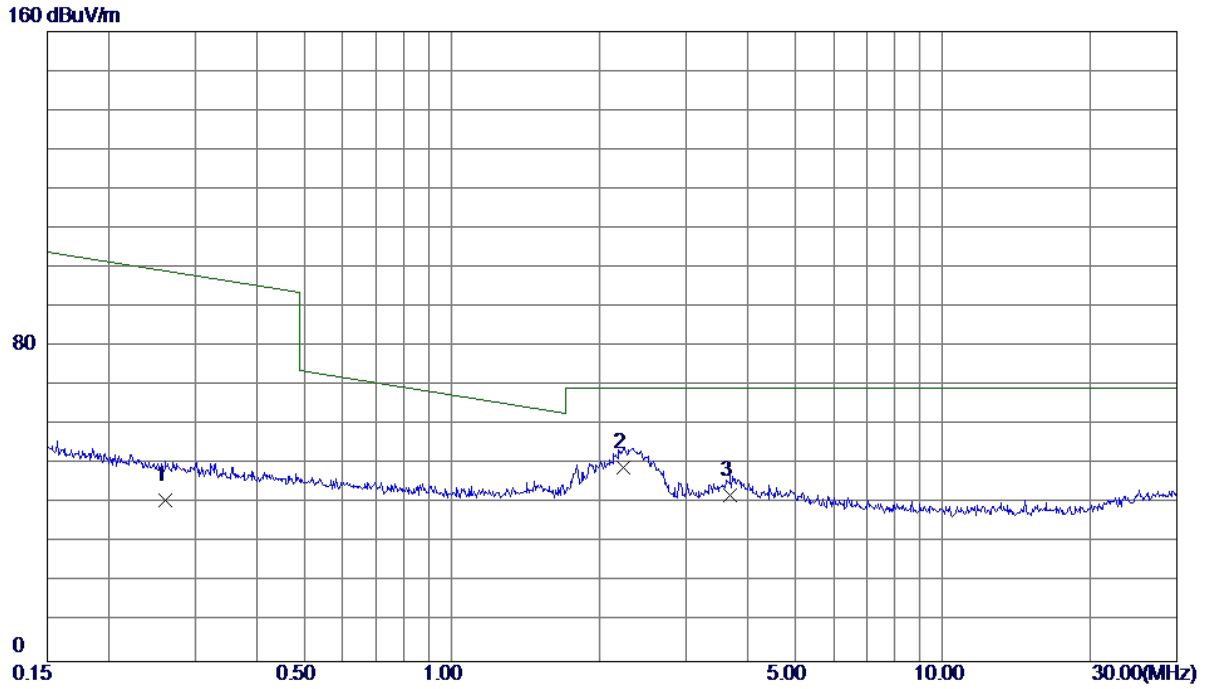

No.	Freq. MHz	Reading Level dBuV/m	Correct Factor dB	Measure ment dBuV/m	Limit dBuV/m	Margin dB	Detector	Comment
1	0.2603	24.23	16.64	40.87	101.64	-60.77	AVG	
2 *	2.2367	33.93	15.44	49.37	69.54	-20.17	QP	
3	3.6806	27.26	15.04	42.30	69.54	-27.24	QP	

Test Mode: TX B MODE CHANNEL 01 (Adapter: BYD)

Ant 90°

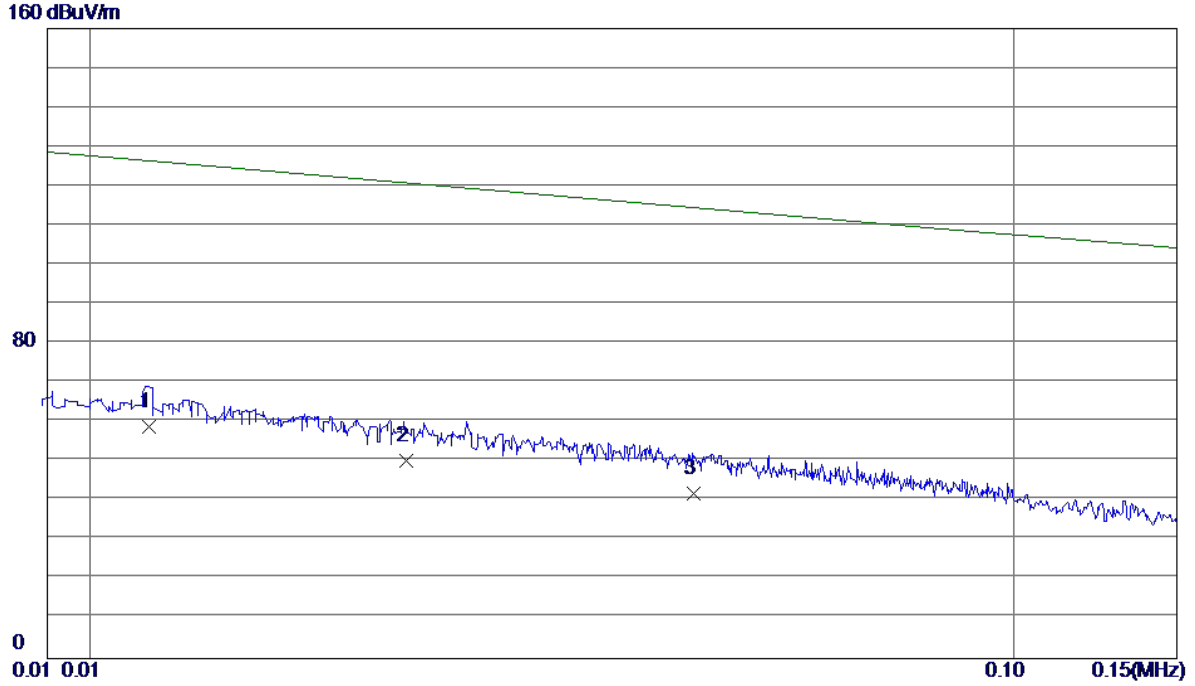

No.	Freq. MHz	Reading Level dBuV/m	Correct Factor dB	Measure ment dBuV/m	Limit dBuV/m	Margin dB	Detector	Comment
1 *	0.0116	38.26	20.71	58.97	127.85	-68.88	AVG	
2	0.0220	30.55	19.56	50.11	125.29	-75.18	AVG	
3	0.0450	23.15	18.87	42.02	119.61	-77.59	AVG	

Test Mode: TX B MODE CHANNEL 01 (Adapter: BYD)

Ant 90°

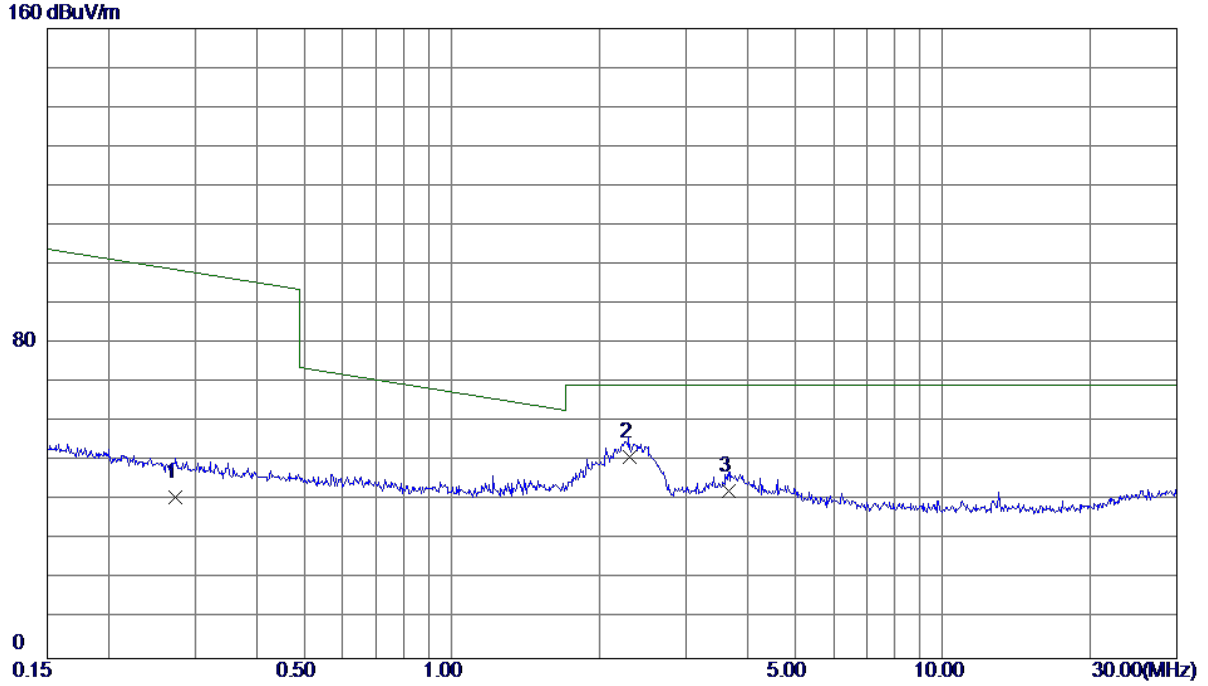

No.	Freq. MHz	Reading Level dBuV/m	Correct Factor dB	Measure ment dBuV/m	Limit dBuV/m	Margin dB	Detector	Comment
1	0.2730	24.40	16.63	41.03	101.21	-60.18	AVG	
2 *	2.2968	35.66	15.42	51.08	69.54	-18.46	QP	
3	3.6611	27.46	15.05	42.51	69.54	-27.03	QP	

**ATTACHMENT C - RADIATED EMISSION (30MHZ TO 1000MHZ)**



Test Mode: TX B MODE CHANNEL 01 (Adapter: PHITEK)

**Vertical**

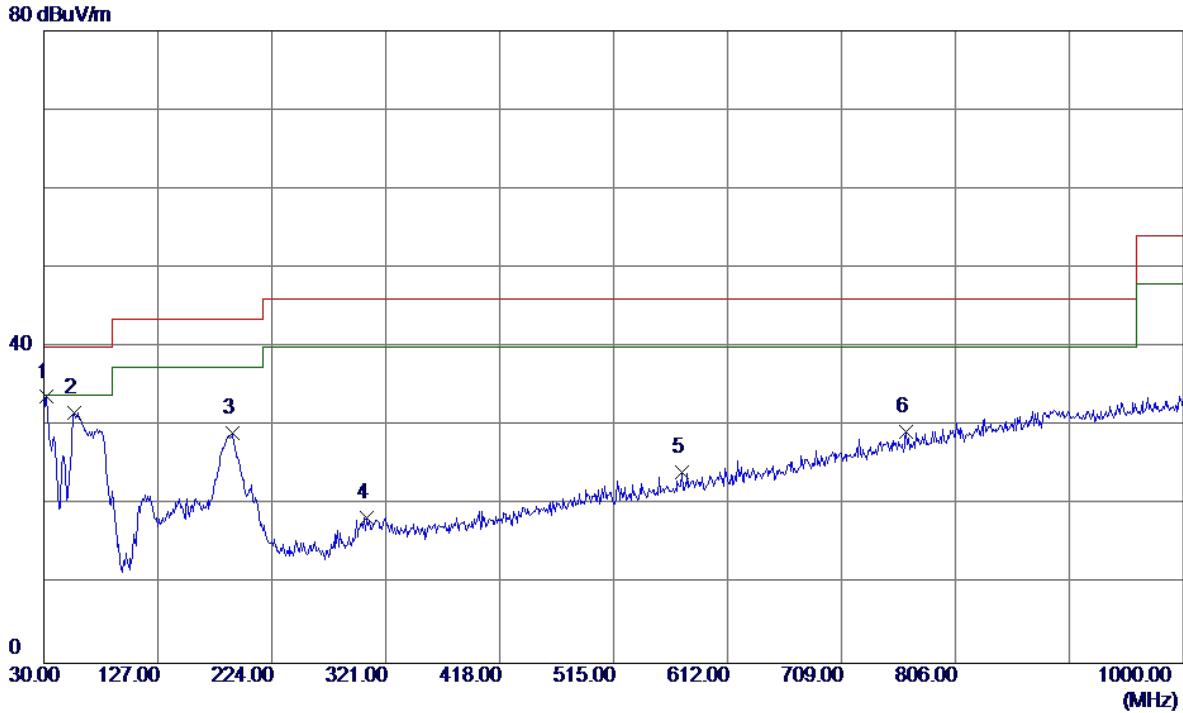

No.	Freq. MHz	Reading Level dBuV/m	Correct Factor dB	Measure ment dBuV/m	Limit dBuV/m	Margin dB	Detector	Comment
1 *	31.9400	48.50	-14.82	33.68	40.00	-6.32	Peak	
2	56.1900	45.41	-13.68	31.73	40.00	-8.27	Peak	
3	191.0200	41.61	-12.53	29.08	43.50	-14.42	Peak	
4	304.5100	30.65	-12.20	18.45	46.00	-27.55	Peak	
5	573.2000	30.33	-6.22	24.11	46.00	-21.89	Peak	
6	764.2900	30.33	-1.07	29.26	46.00	-16.74	Peak	

Test Mode: TX B MODE CHANNEL 01 (Adapter: PHITEK)

**Horizontal**

80 dBuV/m

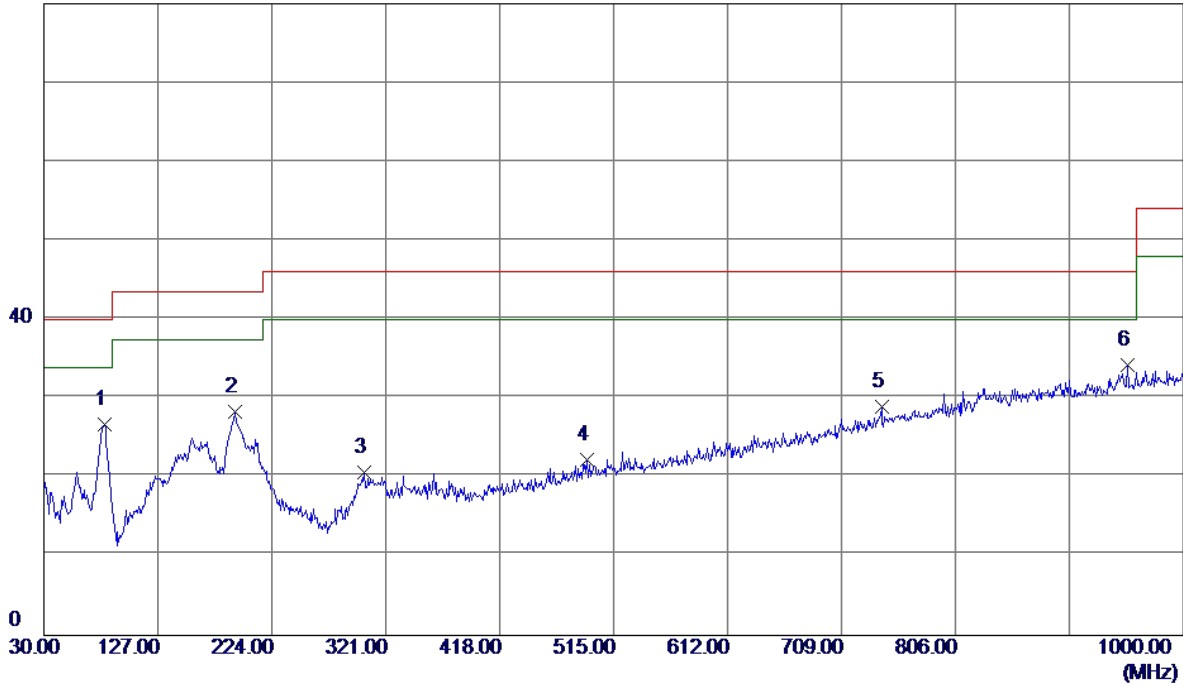

No.	Freq. MHz	Reading Level dBuV/m	Correct Factor dB	Measure ment dBuV/m	Limit dBuV/m	Margin dB	Detector	Comment
1	81.4100	44.65	-17.99	26.66	40.00	-13.34	Peak	
2	192.9600	40.99	-12.71	28.28	43.50	-15.22	Peak	
3	302.5700	32.91	-12.23	20.68	46.00	-25.32	Peak	
4	492.6900	30.30	-8.12	22.18	46.00	-23.82	Peak	
5	742.9500	30.63	-1.61	29.02	46.00	-16.98	Peak	
6 *	952.4700	30.99	3.26	34.25	46.00	-11.75	Peak	

Test Mode: TX B MODE CHANNEL 11 (Adapter: PHITEK)

**Vertical**

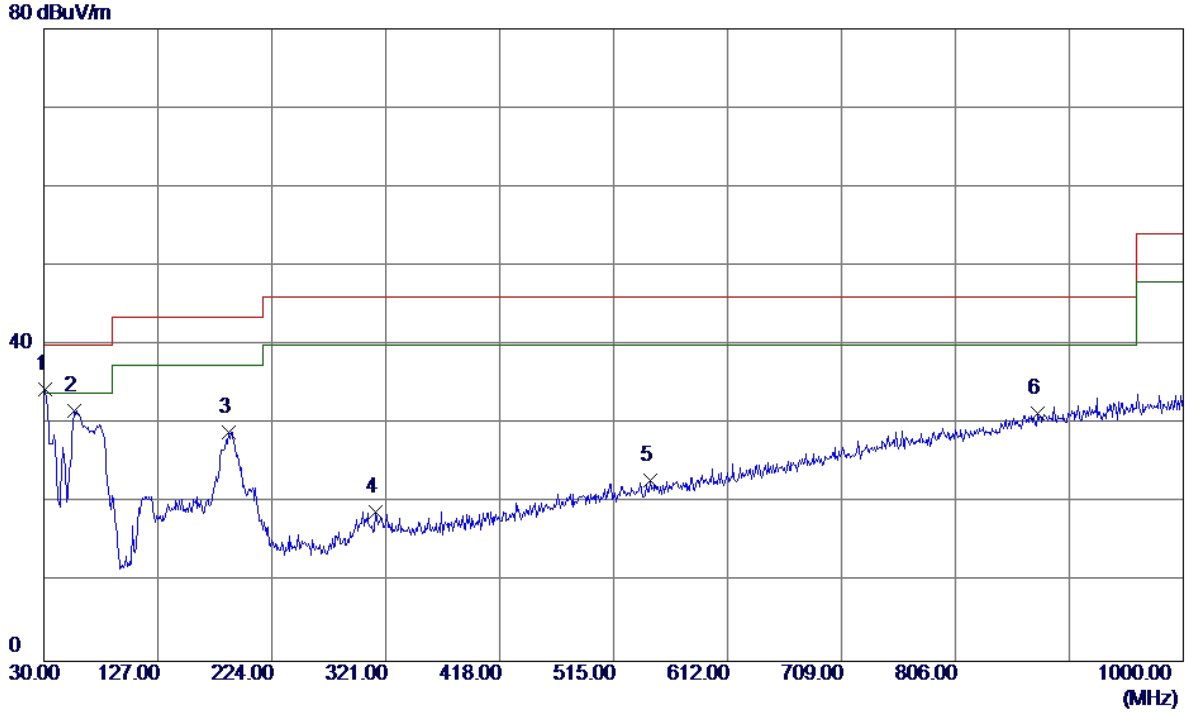

No.	Freq. MHz	Reading Level dBuV/m	Correct Factor dB	Measure ment dBuV/m	Limit dBuV/m	Margin dB	Detector	Comment
1 *	30.9700	49.27	-14.93	34.34	40.00	-5.66	Peak	
2	56.1900	45.42	-13.68	31.74	40.00	-8.26	Peak	
3	187.1400	41.22	-12.22	29.00	43.50	-14.50	Peak	
4	312.2700	31.00	-12.05	18.95	46.00	-27.05	Peak	
5	546.0400	29.87	-6.94	22.93	46.00	-23.07	Peak	
6	875.8400	29.66	1.68	31.34	46.00	-14.66	Peak	

Test Mode: TX B MODE CHANNEL 11 (Adapter: PHITEK)

**Horizontal**

80 dBuV/m

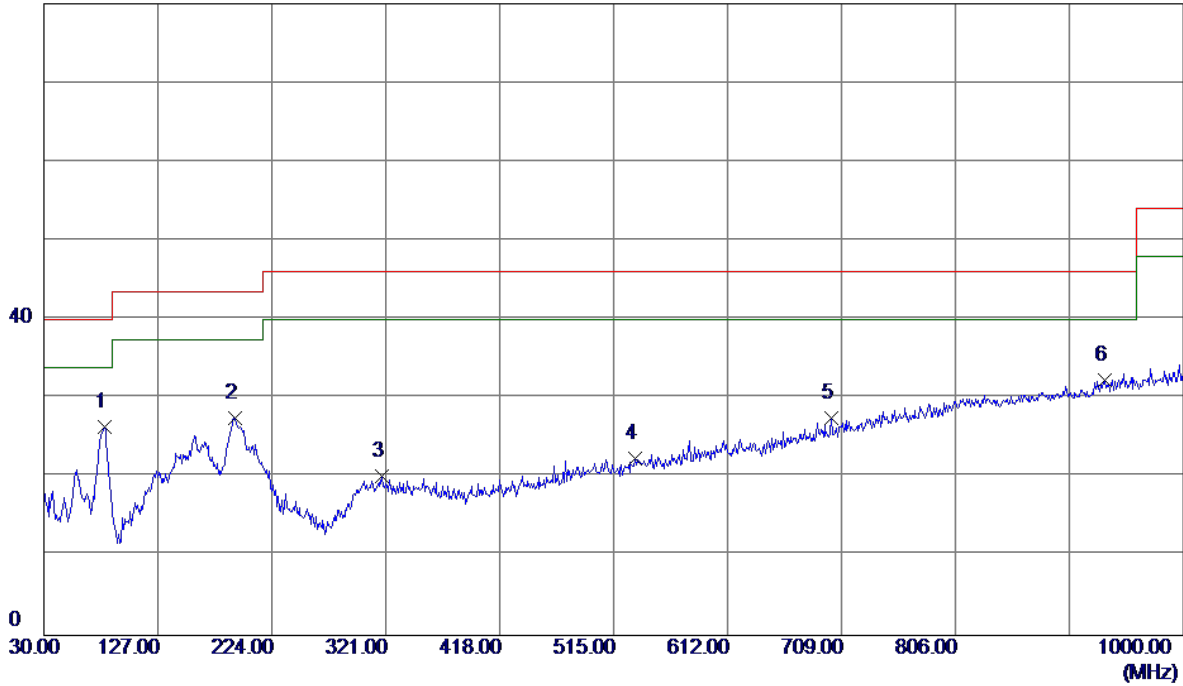

No.	Freq. MHz	Reading Level dBuV/m	Correct Factor dB	Measure ment dBuV/m	Limit dBuV/m	Margin dB	Detector	Comment
1 *	81.4100	44.46	-17.99	26.47	40.00	-13.53	Peak	
2	192.9600	40.24	-12.71	27.53	43.50	-15.97	Peak	
3	318.0900	32.10	-11.94	20.16	46.00	-25.84	Peak	
4	533.4300	29.63	-7.21	22.42	46.00	-23.58	Peak	
5	700.2700	30.49	-2.91	27.58	46.00	-18.42	Peak	
6	933.0700	29.44	2.87	32.31	46.00	-13.69	Peak	

Test Mode: TX B MODE CHANNEL 01 (Adapter: HUNTKEY)

**Vertical**

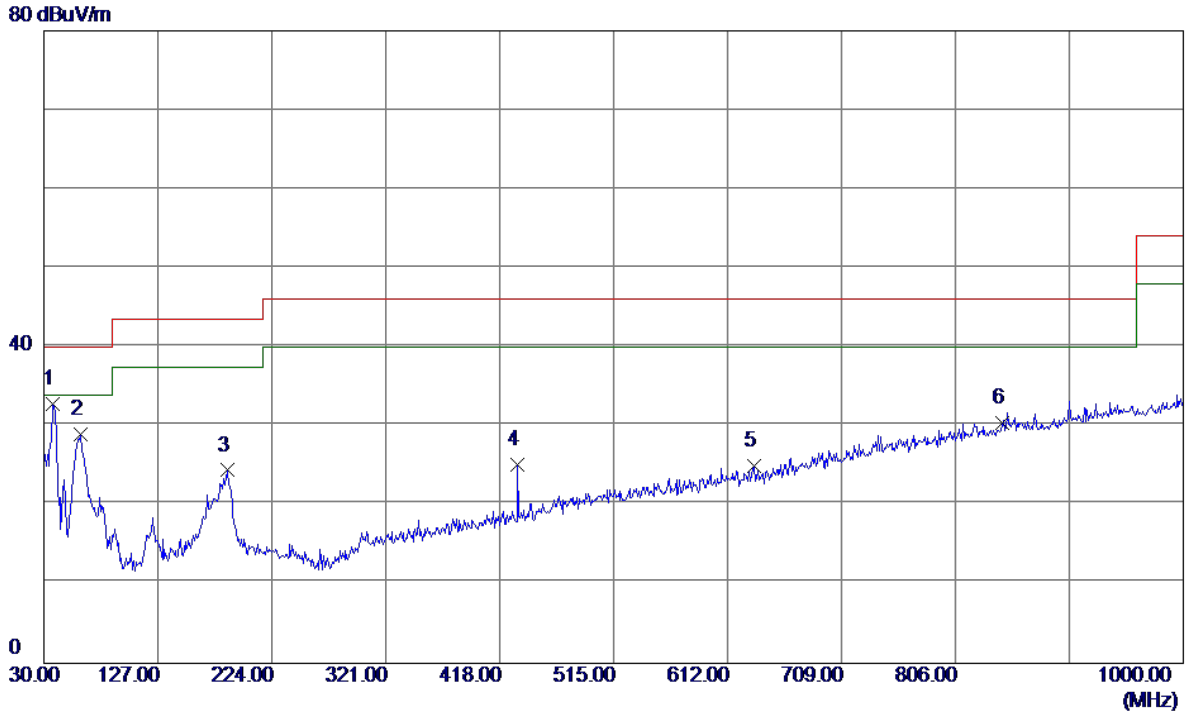

No.	Freq. MHz	Reading Level dBuV/m	Correct Factor dB	Measure ment dBuV/m	Limit dBuV/m	Margin dB	Detector	Comment
1 *	37.7599	46.89	-14.07	32.82	40.00	-7.18	Peak	
2	61.0400	43.13	-14.20	28.93	40.00	-11.07	Peak	
3	186.1700	36.54	-12.14	24.40	43.50	-19.10	Peak	
4	433.5200	34.84	-9.70	25.14	46.00	-20.86	Peak	
5	634.3100	29.71	-4.81	24.90	46.00	-21.10	Peak	
6	845.7700	29.40	1.00	30.40	46.00	-15.60	Peak	

Test Mode: TX B MODE CHANNEL 01 (Adapter: HUNTKEY)

**Horizontal**

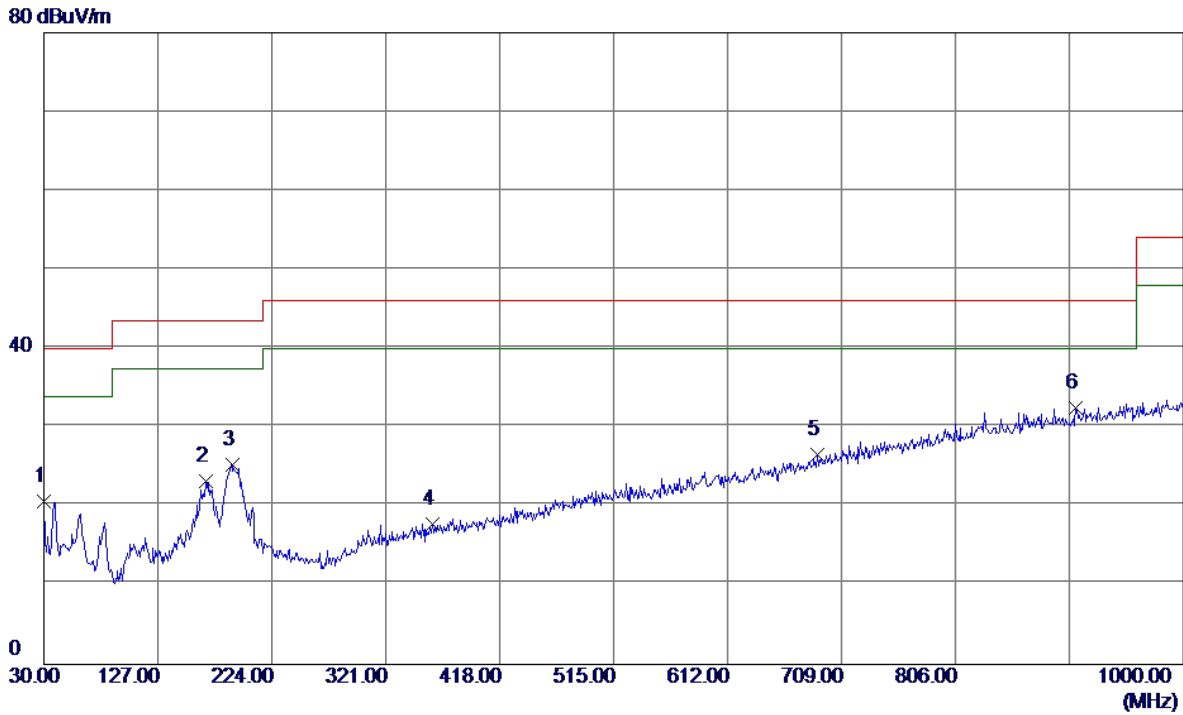

No.	Freq. MHz	Reading Level dBuV/m	Correct Factor dB	Measure ment dBuV/m	Limit dBuV/m	Margin dB	Detector	Comment
1	30.0000	35.64	-15.04	20.60	40.00	-19.40	Peak	
2	167.7400	35.26	-12.09	23.17	43.50	-20.33	Peak	
3	191.0200	37.81	-12.53	25.28	43.50	-18.22	Peak	
4	360.7700	29.01	-11.20	17.81	46.00	-28.19	Peak	
5	688.6300	29.84	-3.28	26.56	46.00	-19.44	Peak	
6 *	908.8200	30.13	2.39	32.52	46.00	-13.48	Peak	

Test Mode: TX B MODE CHANNEL 11 (Adapter: HUNTKEY)

**Vertical**

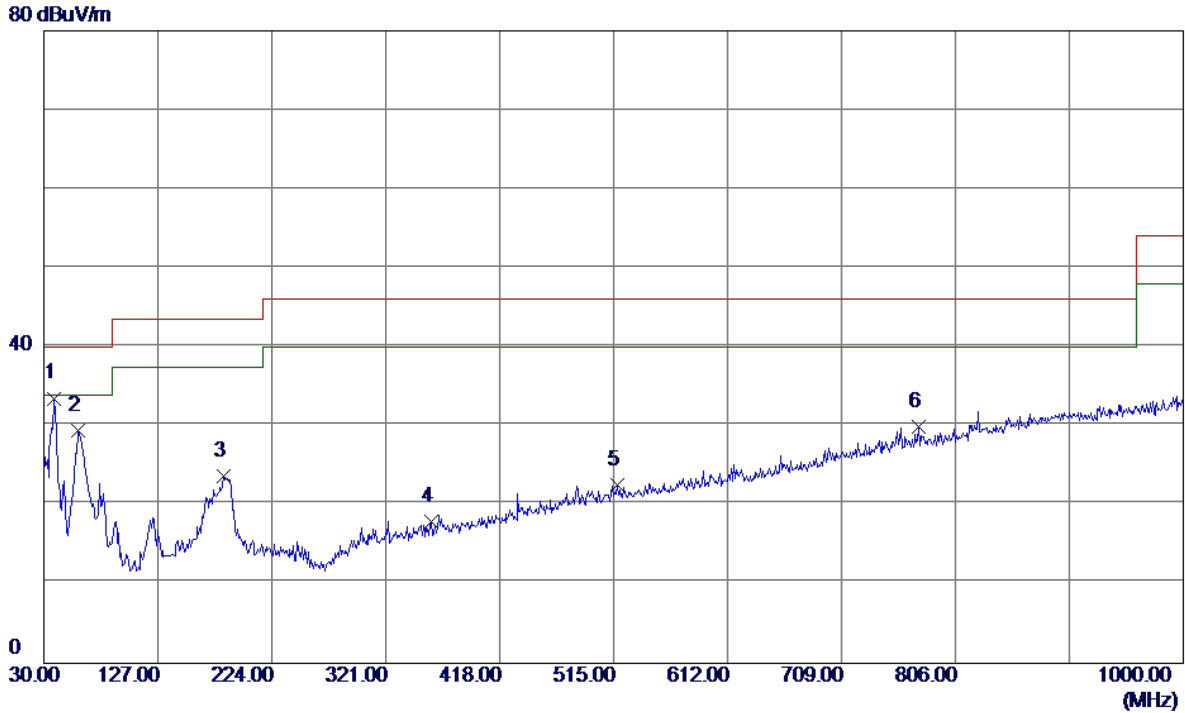

No.	Freq. MHz	Reading Level dBuV/m	Correct Factor dB	Measure ment dBuV/m	Limit dBuV/m	Margin dB	Detector	Comment
1 *	38.7300	47.45	-13.93	33.52	40.00	-6.48	Peak	
2	59.1000	43.38	-13.94	29.44	40.00	-10.56	Peak	
3	183.2600	35.59	-11.91	23.68	43.50	-19.82	Peak	
4	359.8000	29.19	-11.21	17.98	46.00	-28.02	Peak	
5	517.9099	30.07	-7.55	22.52	46.00	-23.48	Peak	
6	774.9600	30.75	-0.83	29.92	46.00	-16.08	Peak	

Test Mode: TX B MODE CHANNEL 11 (Adapter: HUNTKEY)

**Horizontal**

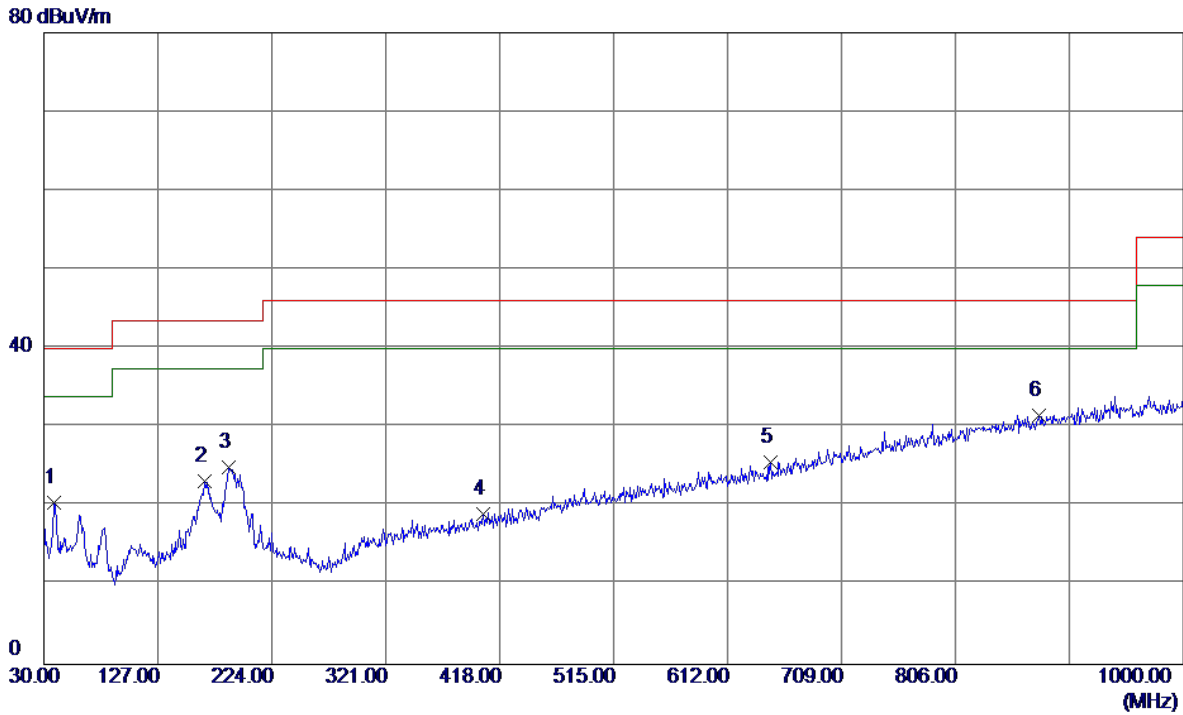

No.	Freq. MHz	Reading Level dBuV/m	Correct Factor dB	Measure ment dBuV/m	Limit dBuV/m	Margin dB	Detector	Comment
1	38.7300	34.35	-13.93	20.42	40.00	-19.58	Peak	
2	166.7700	35.27	-12.14	23.13	43.50	-20.37	Peak	
3	187.1400	37.15	-12.22	24.93	43.50	-18.57	Peak	
4	404.4200	29.60	-10.57	19.03	46.00	-26.97	Peak	
5	648.8600	30.15	-4.53	25.62	46.00	-20.38	Peak	
6 *	876.8100	29.80	1.70	31.50	46.00	-14.50	Peak	



Test Mode: TX B MODE CHANNEL 01 (Adapter: BYD)

**Vertical**

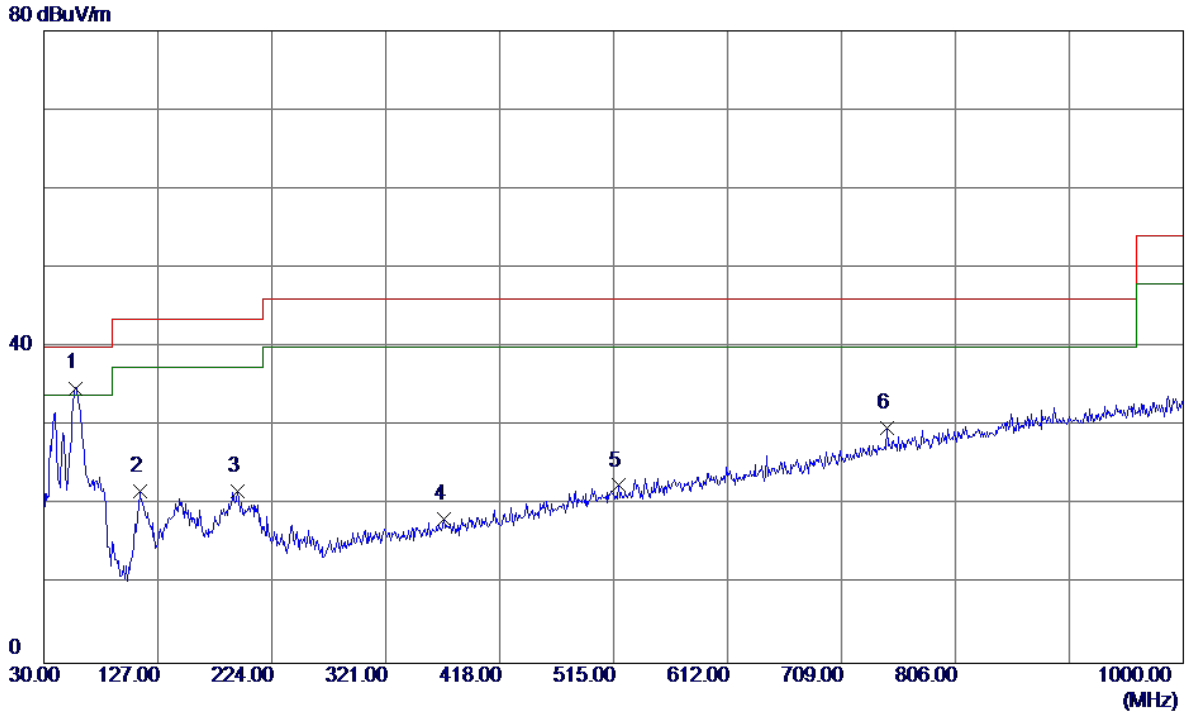

No.	Freq. MHz	Reading Level dBuV/m	Correct Factor dB	Measure ment dBuV/m	Limit dBuV/m	Margin dB	Detector	Comment
1 *	57.1600	48.57	-13.77	34.80	40.00	-5.20	Peak	
2	111.4800	37.45	-15.74	21.71	43.50	-21.79	Peak	
3	194.9000	34.63	-12.88	21.75	43.50	-21.75	Peak	
4	370.4700	29.36	-11.08	18.28	46.00	-27.72	Peak	
5	518.8800	30.01	-7.53	22.48	46.00	-23.52	Peak	
6	747.8000	31.28	-1.46	29.82	46.00	-16.18	Peak	

Test Mode: TX B MODE CHANNEL 01 (Adapter: BYD)

**Horizontal**

80 dBuV/m

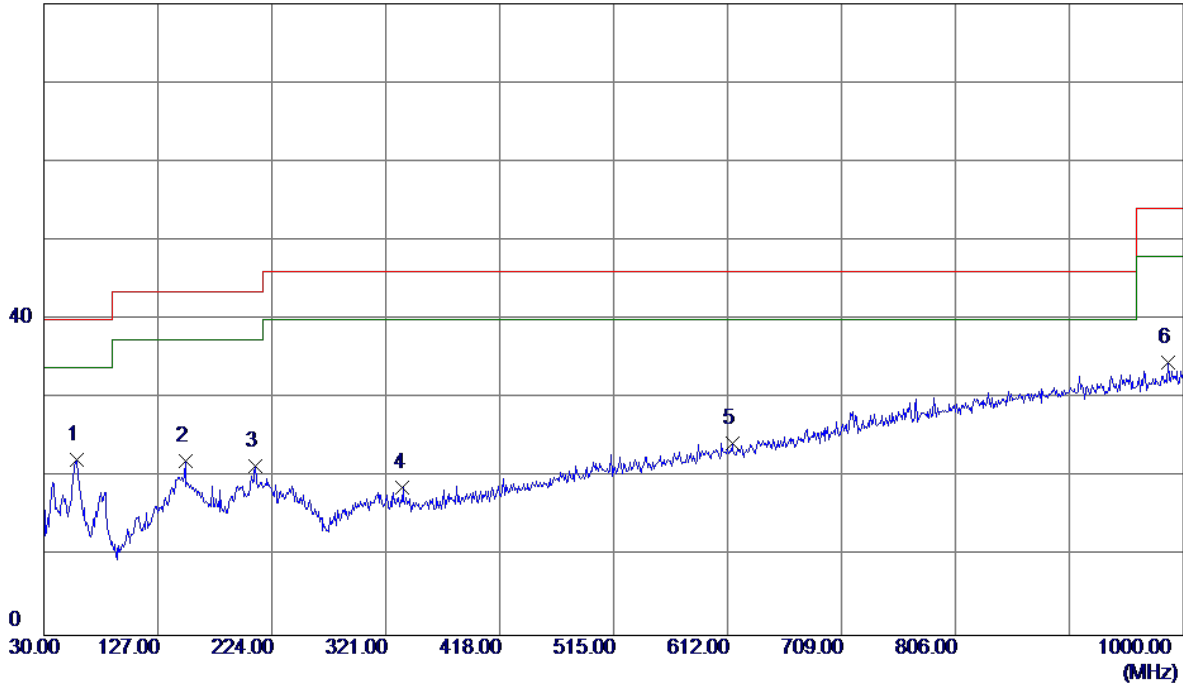

No.	Freq. MHz	Reading Level dBuV/m	Correct Factor dB	Measure ment dBuV/m	Limit dBuV/m	Margin dB	Detector	Comment
1 *	58.1300	36.15	-13.86	22.29	40.00	-17.71	Peak	
2	150.2800	35.15	-13.14	22.01	43.50	-21.49	Peak	
3	210.4200	34.98	-13.55	21.43	43.50	-22.07	Peak	
4	335.5500	30.33	-11.61	18.72	46.00	-27.28	Peak	
5	615.8800	29.46	-5.18	24.28	46.00	-21.72	Peak	
6	987.3900	30.66	3.96	34.62	54.00	-19.38	Peak	

Test Mode: TX B MODE CHANNEL 11 (Adapter: BYD)

**Vertical**

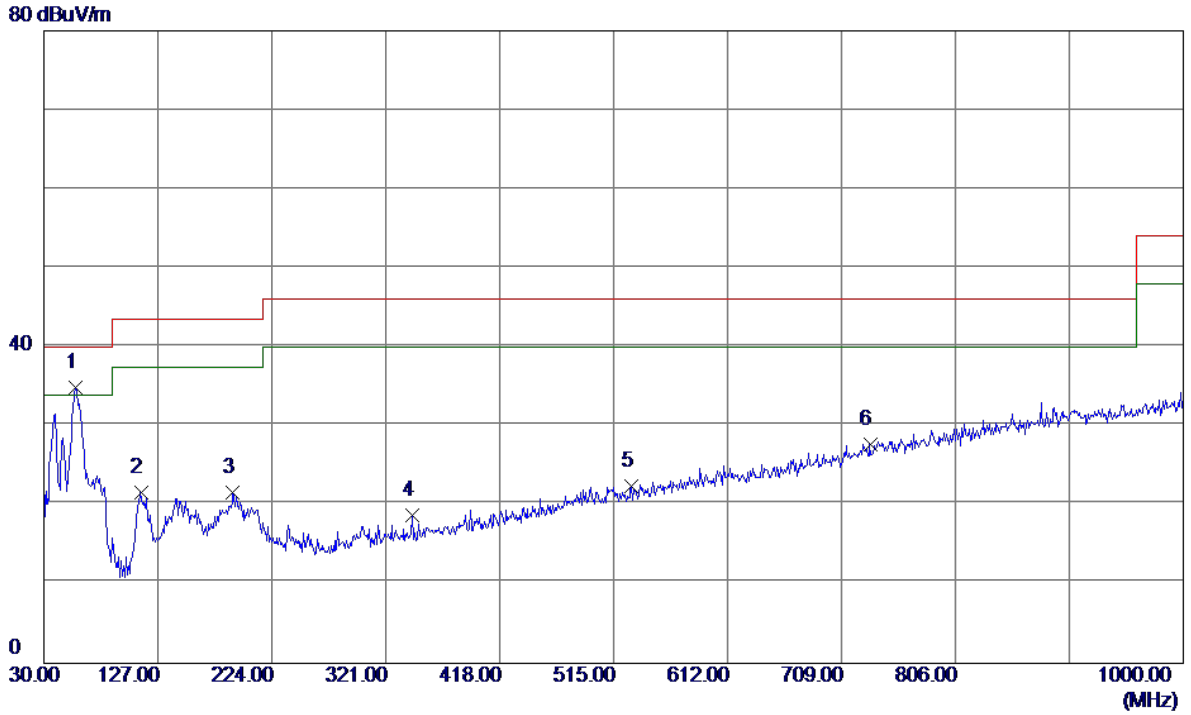

No.	Freq. MHz	Reading Level dBuV/m	Correct Factor dB	Measure ment dBuV/m	Limit dBuV/m	Margin dB	Detector	Comment
1 *	57.1600	48.67	-13.77	34.90	40.00	-5.10	Peak	
2	112.4500	37.21	-15.66	21.55	43.50	-21.95	Peak	
3	191.0200	34.16	-12.53	21.63	43.50	-21.87	Peak	
4	343.3100	30.18	-11.47	18.71	46.00	-27.29	Peak	
5	530.5200	29.66	-7.28	22.38	46.00	-23.62	Peak	
6	733.2500	29.65	-1.91	27.74	46.00	-18.26	Peak	

Test Mode: TX B MODE CHANNEL 11 (Adapter: BYD)

**Horizontal**

80 dBuV/m

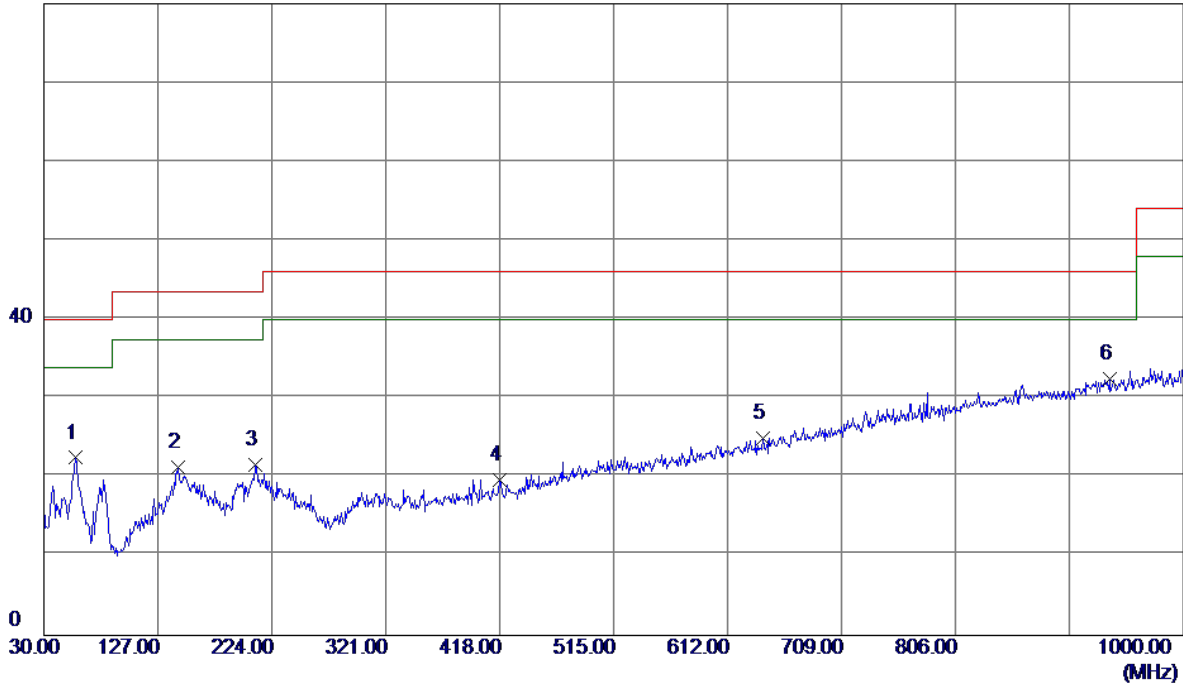

No.	Freq. MHz	Reading Level dBuV/m	Correct Factor dB	Measure ment dBuV/m	Limit dBuV/m	Margin dB	Detector	Comment
1	57.1600	36.25	-13.77	22.48	40.00	-17.52	Peak	
2	144.4600	34.75	-13.54	21.21	43.50	-22.29	Peak	
3	210.4200	35.08	-13.55	21.53	43.50	-21.97	Peak	
4	418.0000	29.91	-10.17	19.74	46.00	-26.26	Peak	
5	642.0700	29.64	-4.66	24.98	46.00	-21.02	Peak	
6 *	936.9500	29.46	2.95	32.41	46.00	-13.59	Peak	

# ATTACHMENT D - RADIATED EMISSION (ABOVE 1000MHZ)

Orthogonal Axis :	X
Test Mode :	TX B MODE 2412MHz

**Vertical**

120 dBuV/m

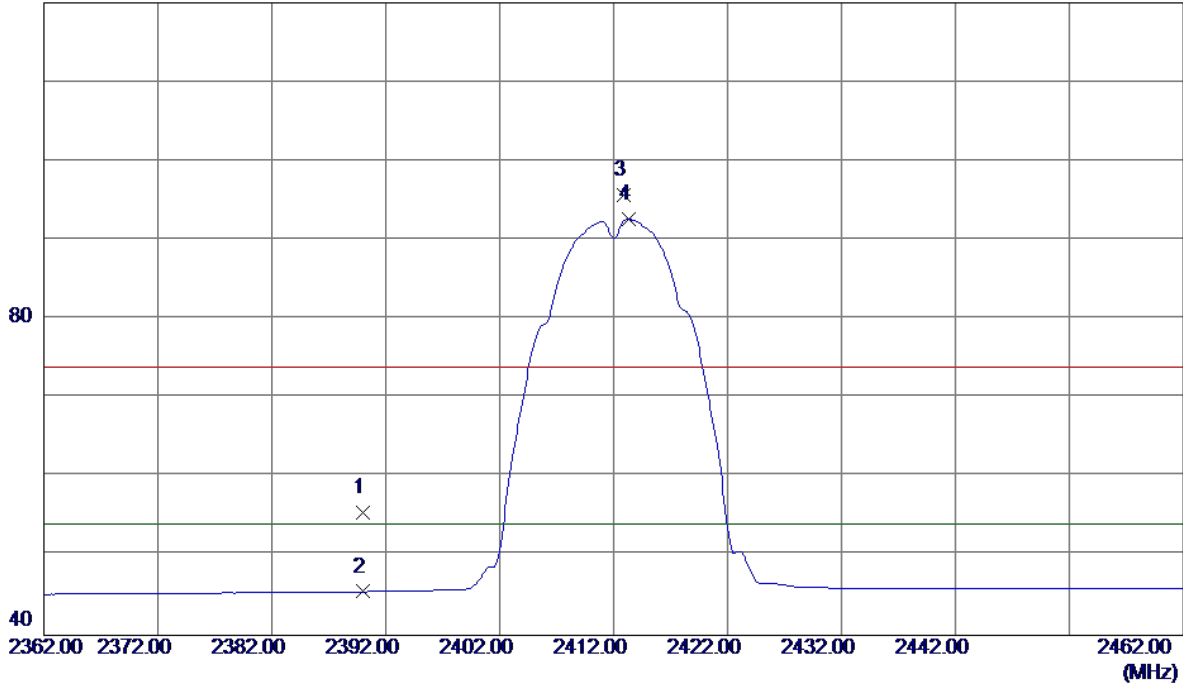

No.	Freq. MHz	Reading Level dBuV/m	Correct Factor dB	Measure ment dBuV/m	Limit dBuV/m	Margin dB	Detector	Comment
1	2390.0000	23.12	32.38	55.50	74.00	-18.50	Peak	
2	2390.0000	13.14	32.38	45.52	54.00	-8.48	AVG	
3	2412.9000	63.21	32.46	95.67	74.00	21.67	Peak	No Limit
4 *	2413.3000	60.19	32.46	92.65	54.00	38.65	AVG	No Limit

Orthogonal Axis :	X
Test Mode :	TX B MODE 2412MHz

**Vertical**

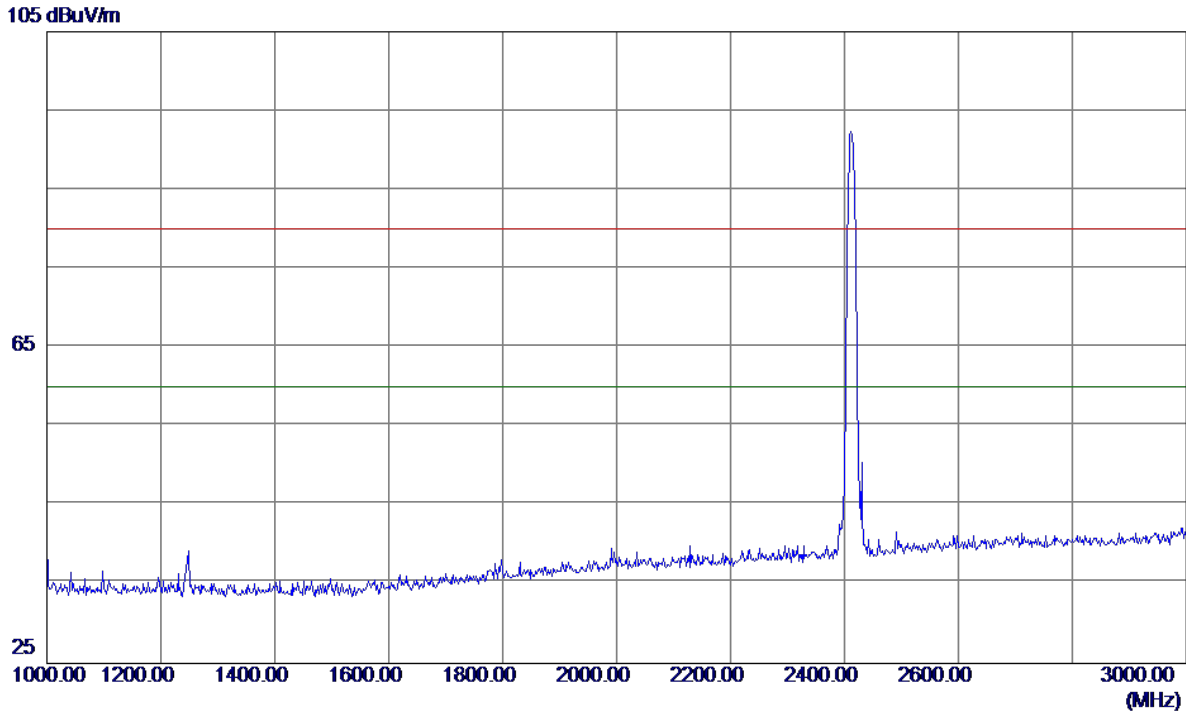

No.	Freq. MHz	Reading Level dBuV/m	Correct Factor dB	Measure ment dBuV/m	Limit dBuV/m	Margin dB	Detector	Comment
	2412	105		105	75	30		

Orthogonal Axis :	X
Test Mode :	TX B MODE 2412MHz

**Vertical**

100 dBuV/m

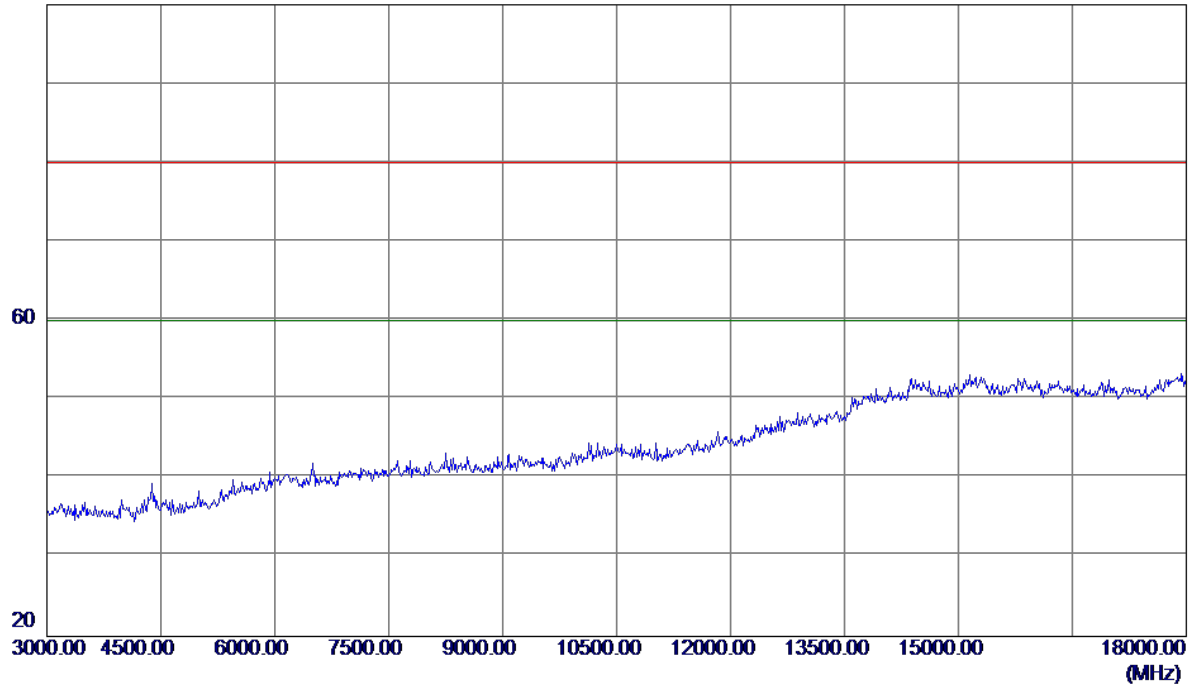

No.	Freq. MHz	Reading Level dBuV/m	Correct Factor dB	Measure ment dBuV/m	Limit dBuV/m	Margin dB	Detector	Comment



Orthogonal Axis :	X
Test Mode :	TX B MODE 2412MHz

**Vertical**

100 dBuV/m

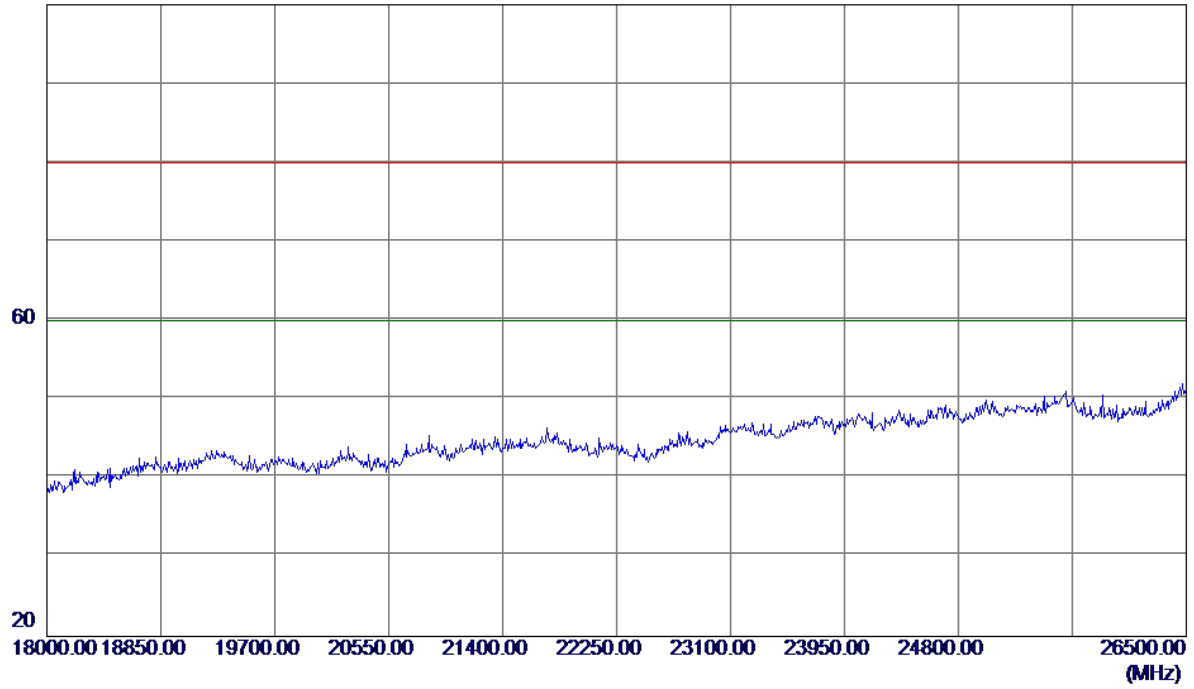

No.	Freq. MHz	Reading Level dBuV/m	Correct Factor dB	Measure ment dBuV/m	Limit dBuV/m	Margin dB	Detector	Comment

Orthogonal Axis :	X
Test Mode :	TX B MODE 2412MHz

**Horizontal**

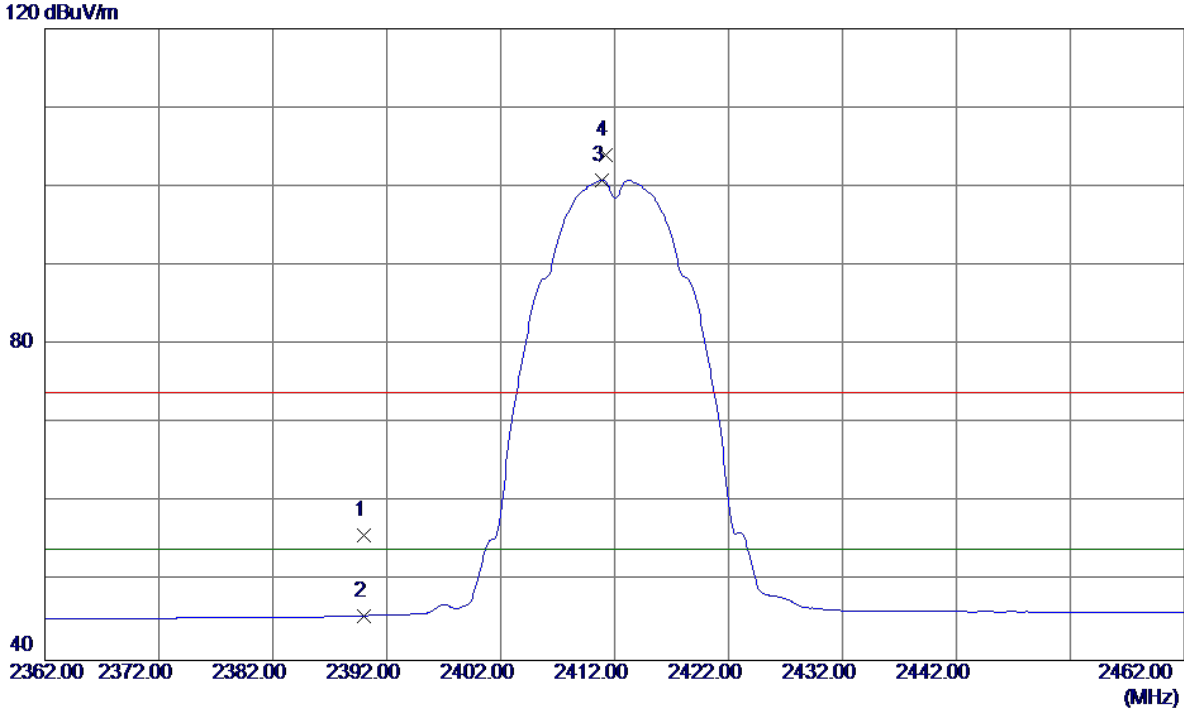

No.	Freq. MHz	Reading Level dBuV/m	Correct Factor dB	Measure ment dBuV/m	Limit dBuV/m	Margin dB	Detector	Comment
1	2390.0000	23.51	32.38	55.89	74.00	-18.11	Peak	
2	2390.0000	13.29	32.38	45.67	54.00	-8.33	AVG	
3 *	2410.9000	68.37	32.45	100.82	54.00	46.82	AVG	No Limit
4	2411.2000	71.51	32.45	103.96	74.00	29.96	Peak	No Limit

Orthogonal Axis :	X
Test Mode :	TX B MODE 2412MHz

**Horizontal**

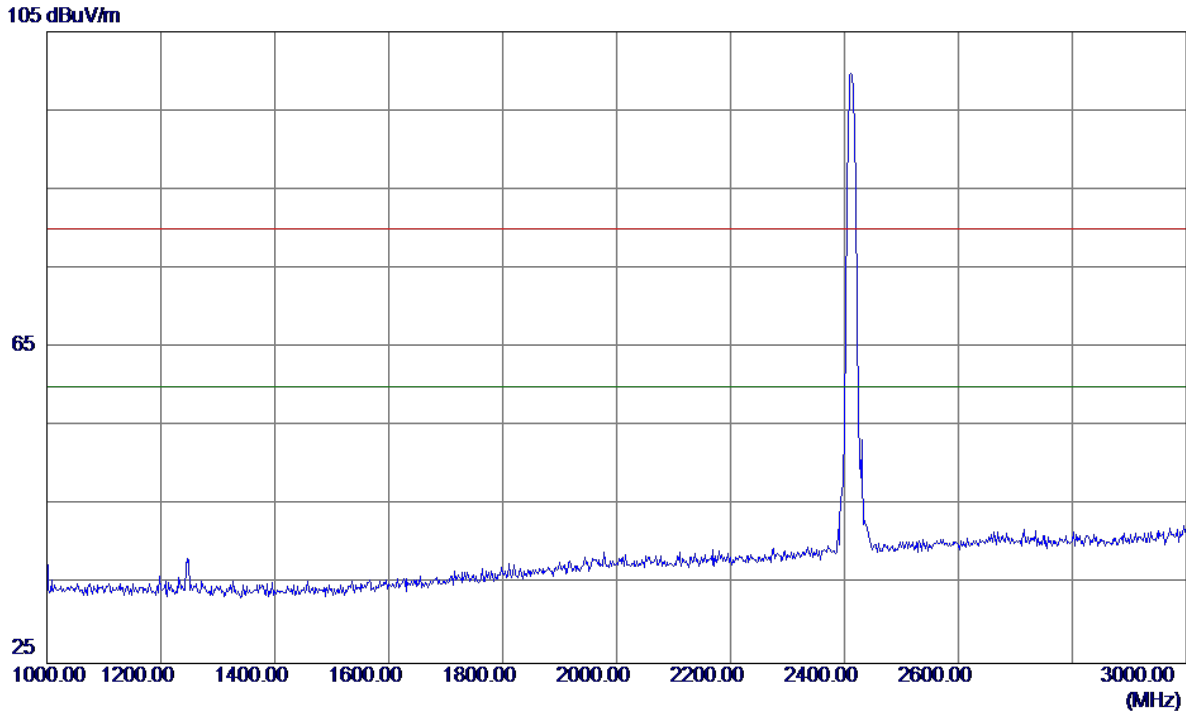

No.	Freq. MHz	Reading Level dBuV/m	Correct Factor dB	Measure ment dBuV/m	Limit dBuV/m	Margin dB	Detector	Comment

Orthogonal Axis :	X
Test Mode :	TX B MODE 2412MHz

**Horizontal**

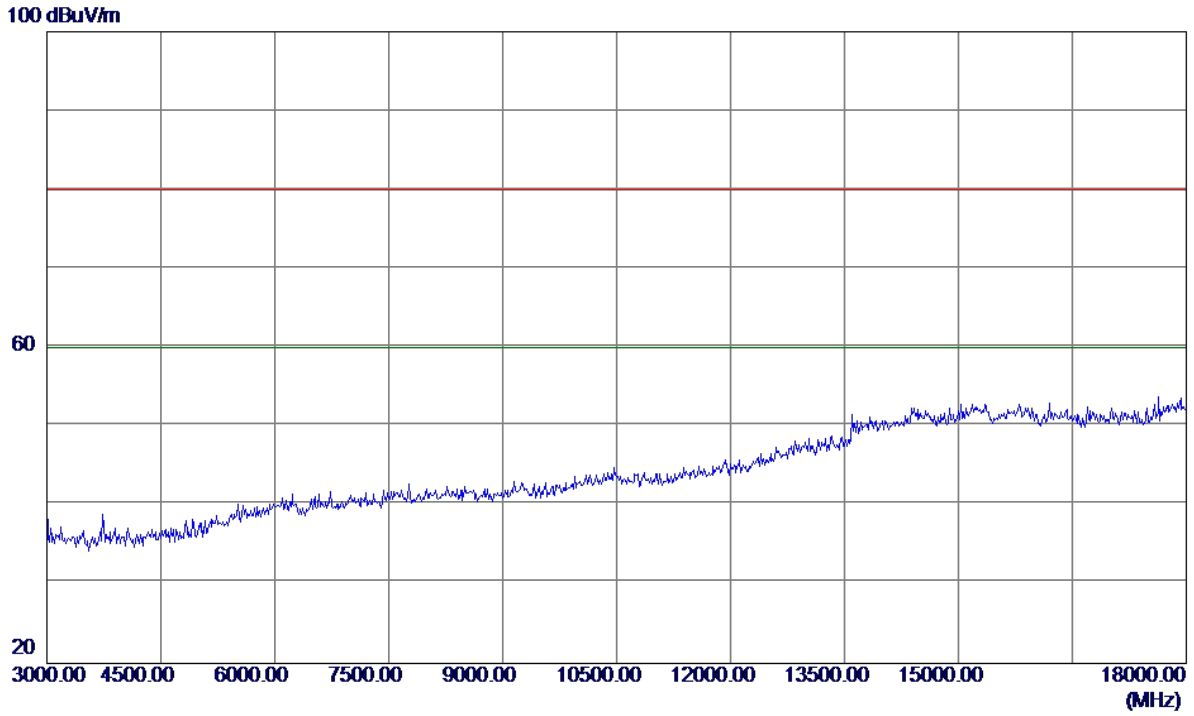

No.	Freq. MHz	Reading Level dBuV/m	Correct Factor dB	Measure ment dBuV/m	Limit dBuV/m	Margin dB	Detector	Comment

Orthogonal Axis :	X
Test Mode :	TX B MODE 2412MHz

**Horizontal**

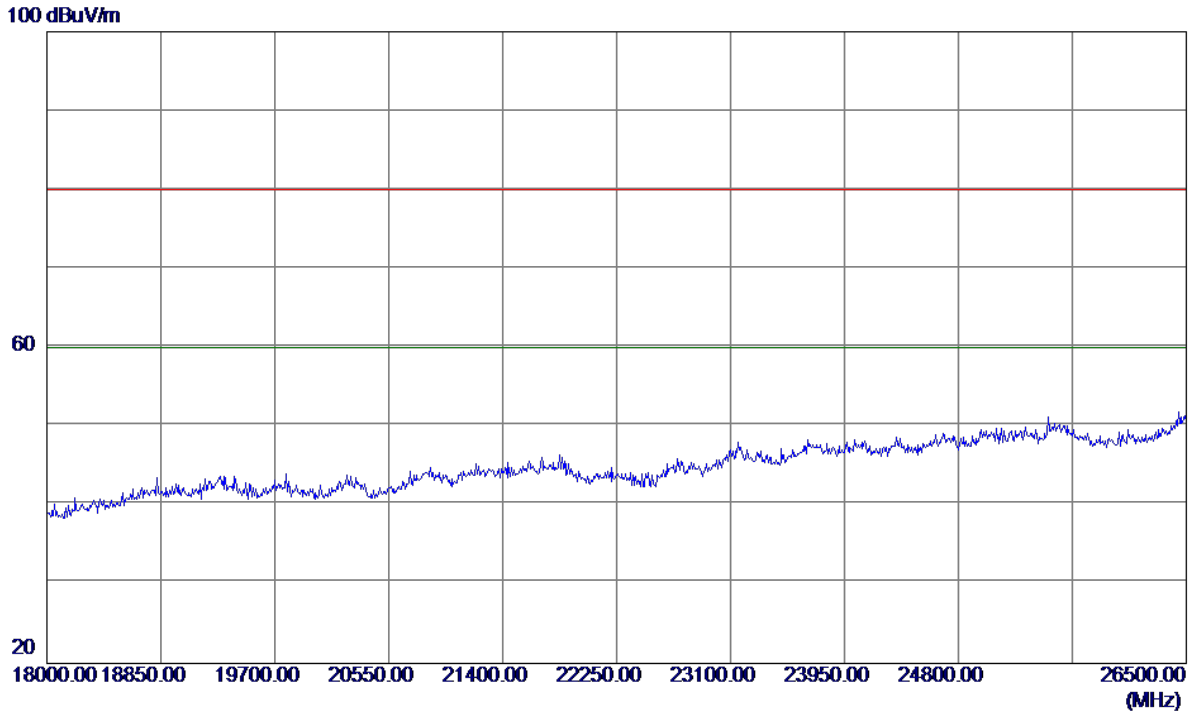

No.	Freq. MHz	Reading Level dBuV/m	Correct Factor dB	Measure ment dBuV/m	Limit dBuV/m	Margin dB	Detector	Comment
-----	--------------	----------------------------	-------------------------	---------------------------	-----------------	--------------	----------	---------

Orthogonal Axis :	X
Test Mode :	TX B MODE 2462MHz

**Vertical**

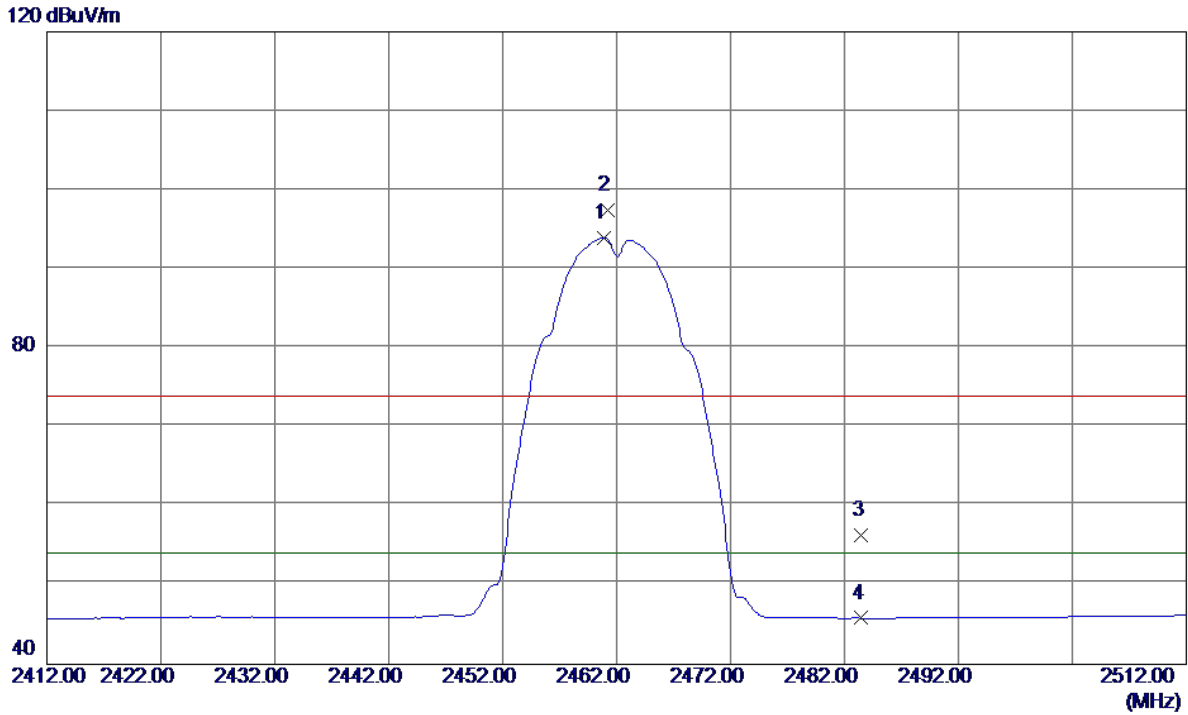

No.	Freq. MHz	Reading Level dBuV/m	Correct Factor dB	Measure ment dBuV/m	Limit dBuV/m	Margin dB	Detector	Comment
1 *	2460.9000	61.34	32.63	93.97	54.00	39.97	AVG	No Limit
2	2461.2000	64.78	32.63	97.41	74.00	23.41	Peak	No Limit
3	2483.5000	23.65	32.71	56.36	74.00	-17.64	Peak	
4	2483.5000	13.13	32.71	45.84	54.00	-8.16	AVG	

Orthogonal Axis :	X
Test Mode :	TX B MODE 2462MHz

**Vertical**

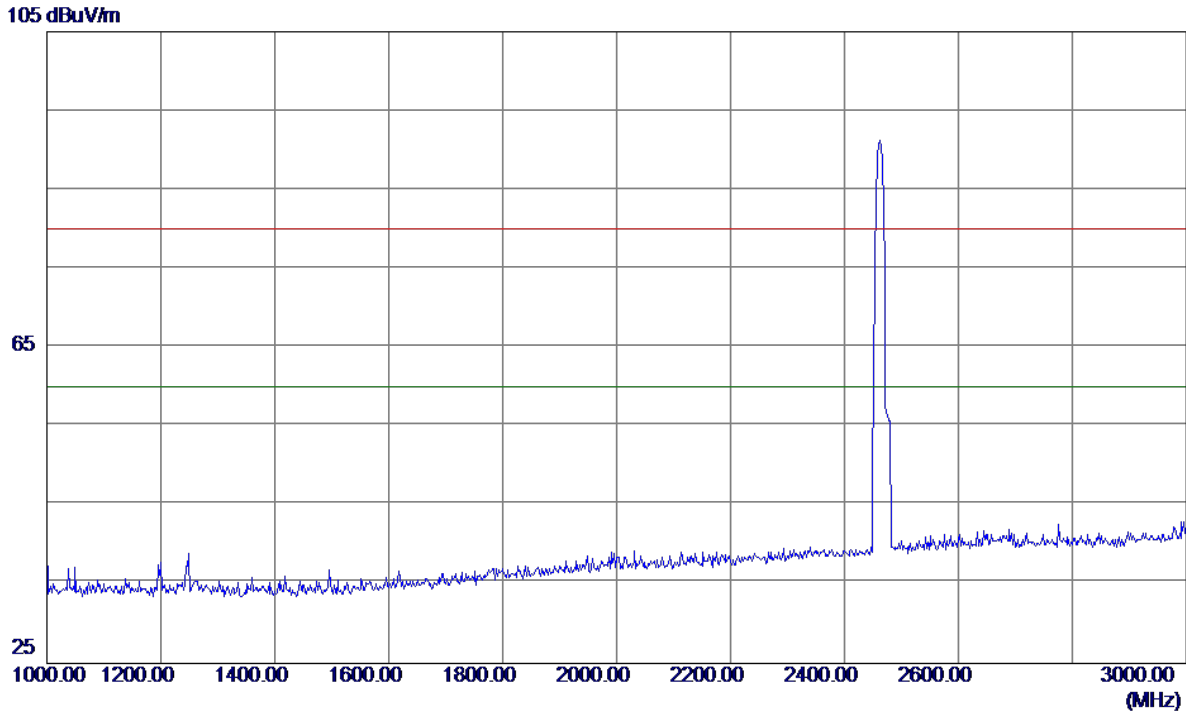

No.	Freq. MHz	Reading Level dBuV/m	Correct Factor dB	Measure ment dBuV/m	Limit dBuV/m	Margin dB	Detector	Comment
-----	--------------	----------------------------	-------------------------	---------------------------	-----------------	--------------	----------	---------

Orthogonal Axis :	X
Test Mode :	TX B MODE 2462MHz

**Vertical**

100 dBuV/m

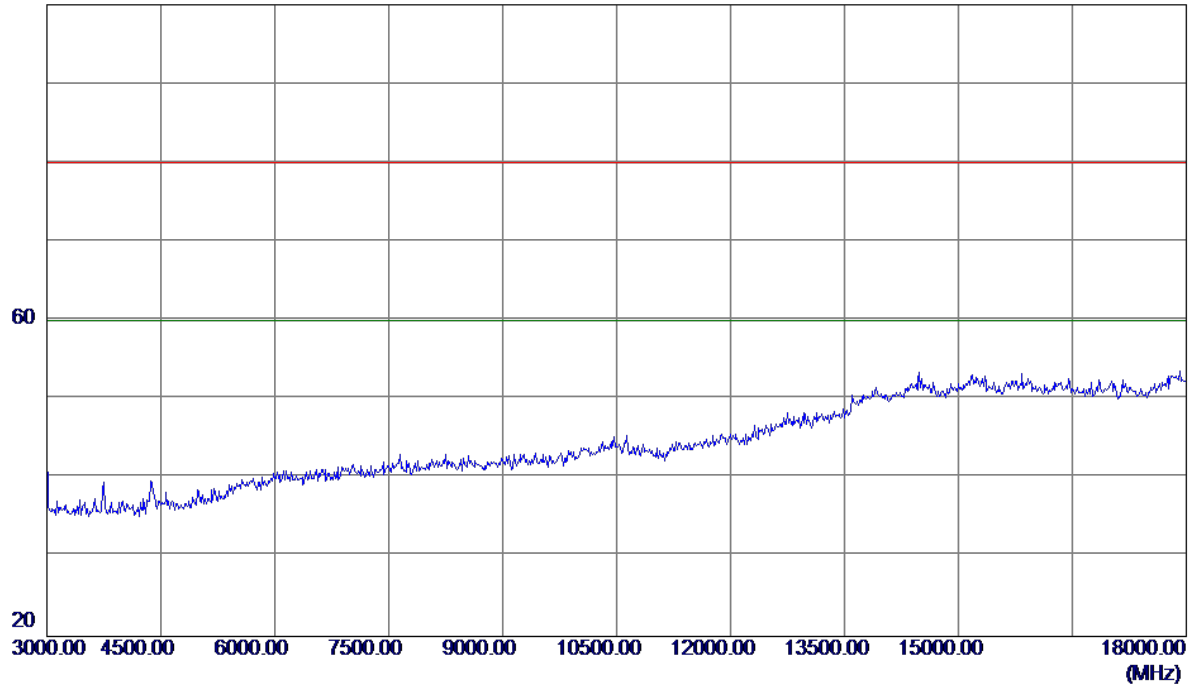

No.	Freq. MHz	Reading Level dBuV/m	Correct Factor dB	Measure ment dBuV/m	Limit dBuV/m	Margin dB	Detector	Comment



Orthogonal Axis :	X
Test Mode :	TX B MODE 2462MHz

**Vertical**

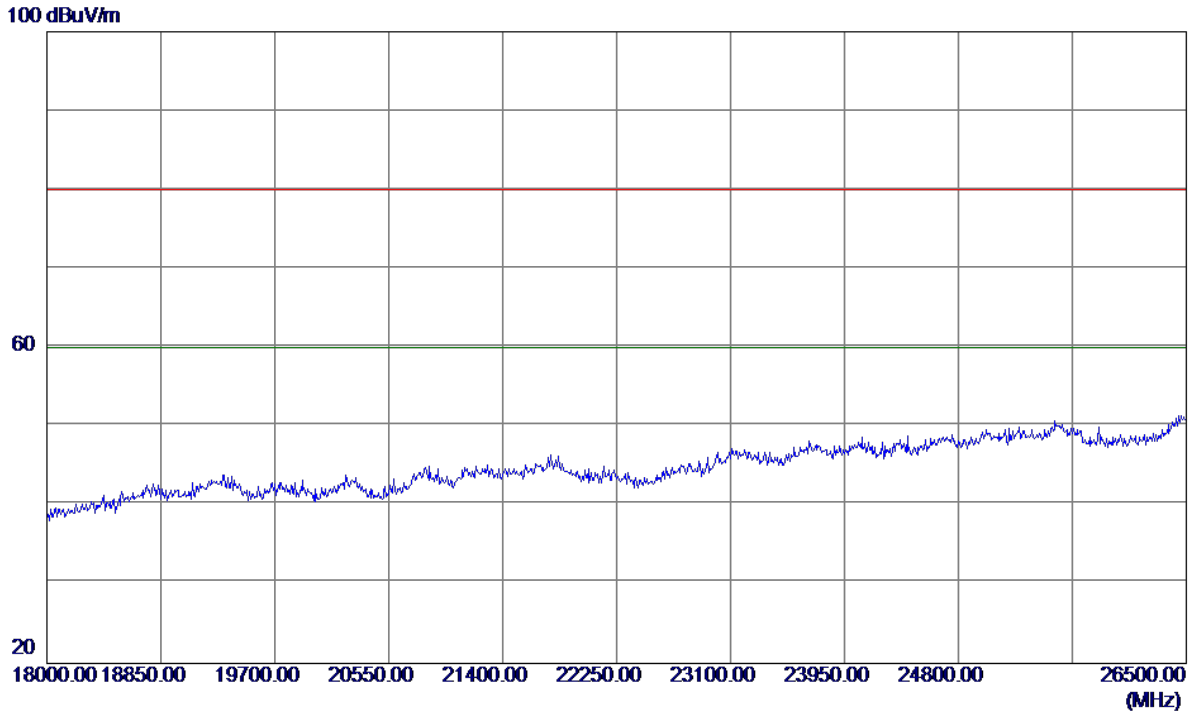

No.	Freq. MHz	Reading Level dBuV/m	Correct Factor dB	Measure ment dBuV/m	Limit dBuV/m	Margin dB	Detector	Comment

Orthogonal Axis :	X
Test Mode :	TX B MODE 2462MHz

**Horizontal**

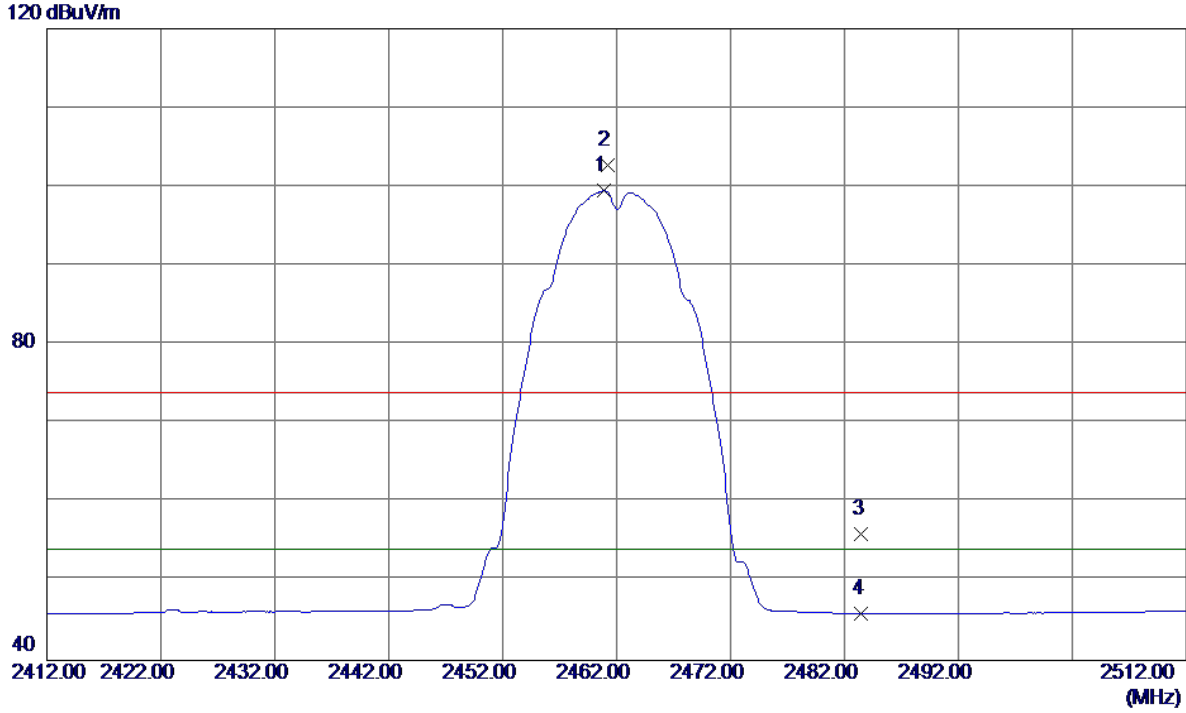

No.	Freq. MHz	Reading Level dBuV/m	Correct Factor dB	Measure ment dBuV/m	Limit dBuV/m	Margin dB	Detector	Comment
1 *	2460.9000	66.86	32.63	99.49	54.00	45.49	AVG	No Limit
2	2461.2000	70.11	32.63	102.74	74.00	28.74	Peak	No Limit
3	2483.5000	23.30	32.71	56.01	74.00	-17.99	Peak	
4	2483.5000	13.27	32.71	45.98	54.00	-8.02	AVG	

Orthogonal Axis :	X
Test Mode :	TX B MODE 2462MHz

**Horizontal**

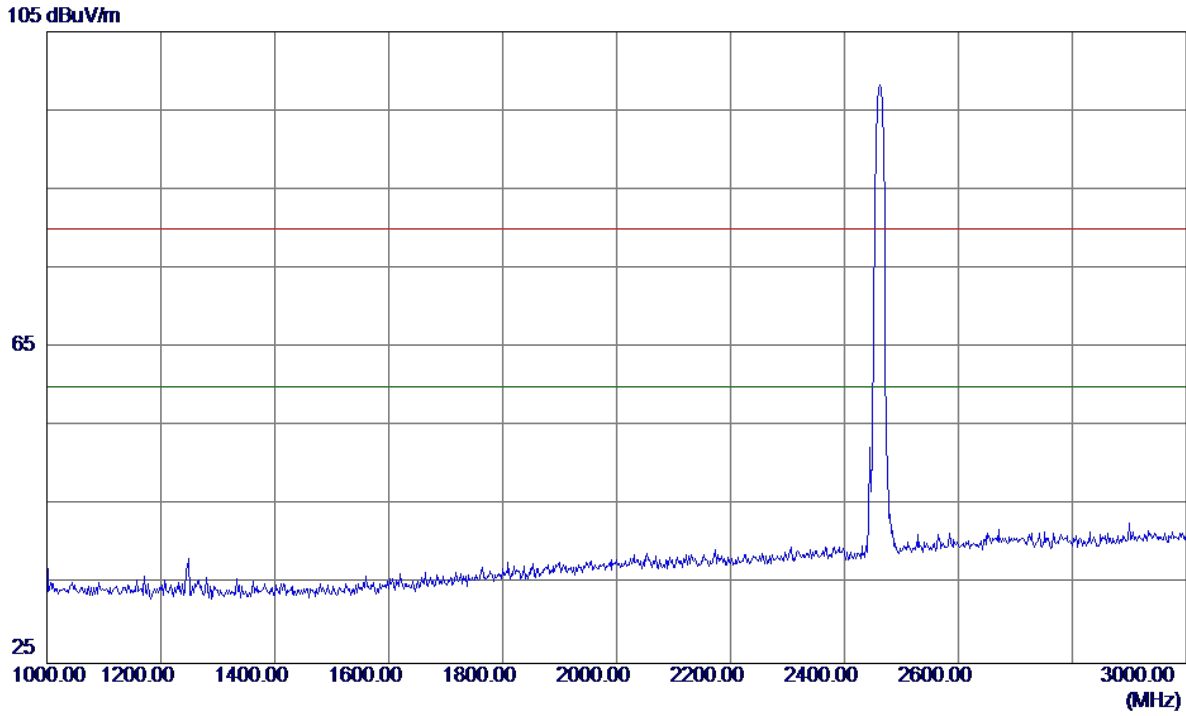

No.	Freq. MHz	Reading Level dBuV/m	Correct Factor dB	Measure ment dBuV/m	Limit dBuV/m	Margin dB	Detector	Comment

Orthogonal Axis :	X
Test Mode :	TX B MODE 2462MHz

**Horizontal**

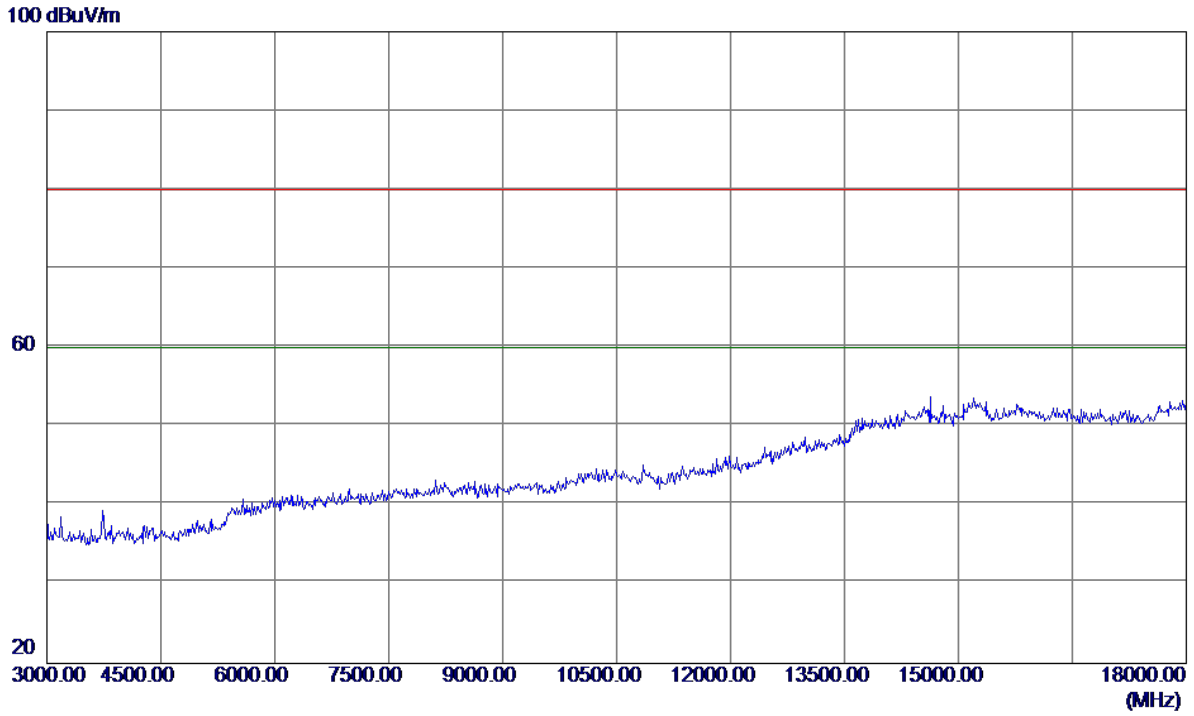

No.	Freq. MHz	Reading Level dBuV/m	Correct Factor dB	Measure ment dBuV/m	Limit dBuV/m	Margin dB	Detector	Comment
-----	--------------	----------------------------	-------------------------	---------------------------	-----------------	--------------	----------	---------

Orthogonal Axis :	X
Test Mode :	TX B MODE 2462MHz

**Horizontal**

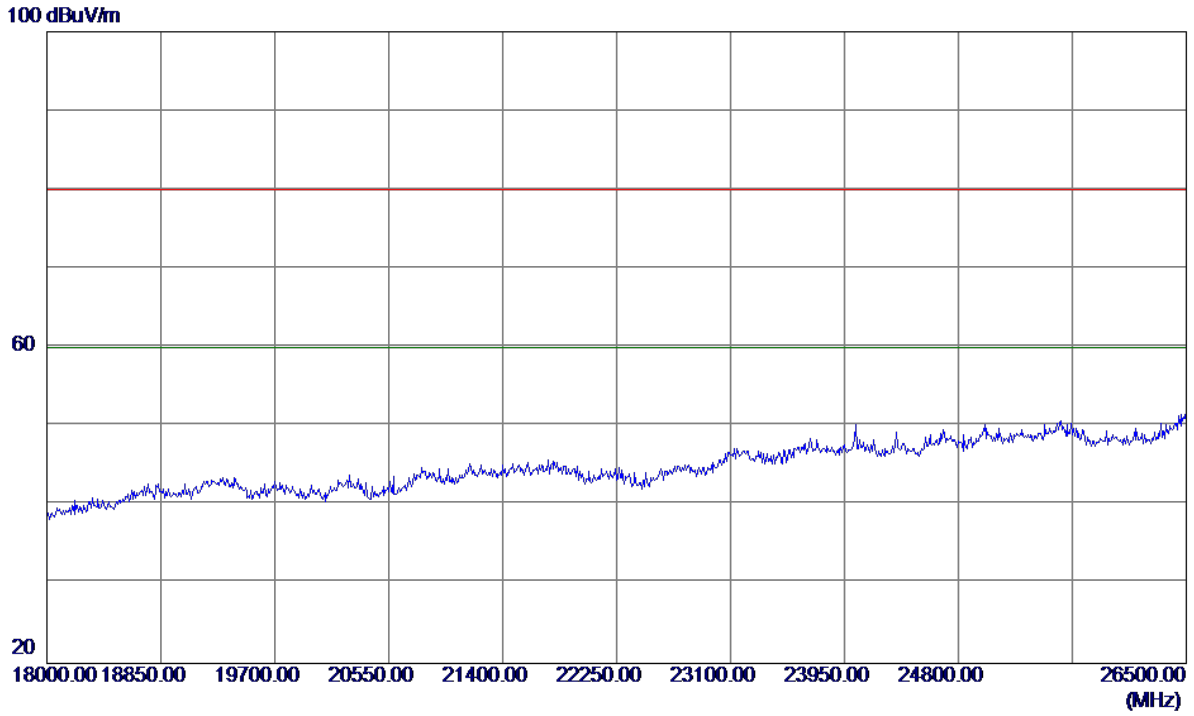

No.	Freq. MHz	Reading Level dBuV/m	Correct Factor dB	Measure ment dBuV/m	Limit dBuV/m	Margin dB	Detector	Comment
-----	--------------	----------------------------	-------------------------	---------------------------	-----------------	--------------	----------	---------

Orthogonal Axis :	X
Test Mode :	TX G MODE 2412MHz

**Vertical**

120 dBuV/m

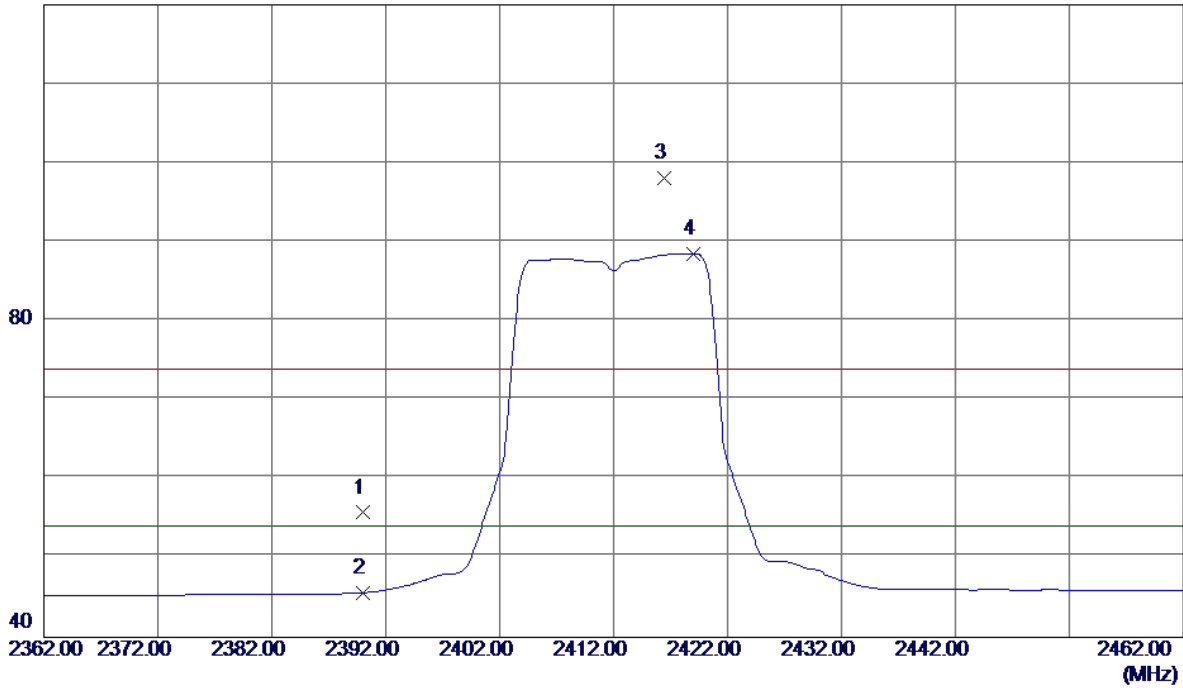

No.	Freq. MHz	Reading Level dBuV/m	Correct Factor dB	Measure ment dBuV/m	Limit dBuV/m	Margin dB	Detector	Comment
1	2390.0000	23.38	32.38	55.76	74.00	-18.24	Peak	
2	2390.0000	13.26	32.38	45.64	54.00	-8.36	AVG	
3	2416.4000	65.64	32.47	98.11	74.00	24.11	Peak	No Limit
4 *	2419.0000	56.01	32.48	88.49	54.00	34.49	AVG	No Limit

Orthogonal Axis :	X
Test Mode :	TX G MODE 2412MHz

**Vertical**

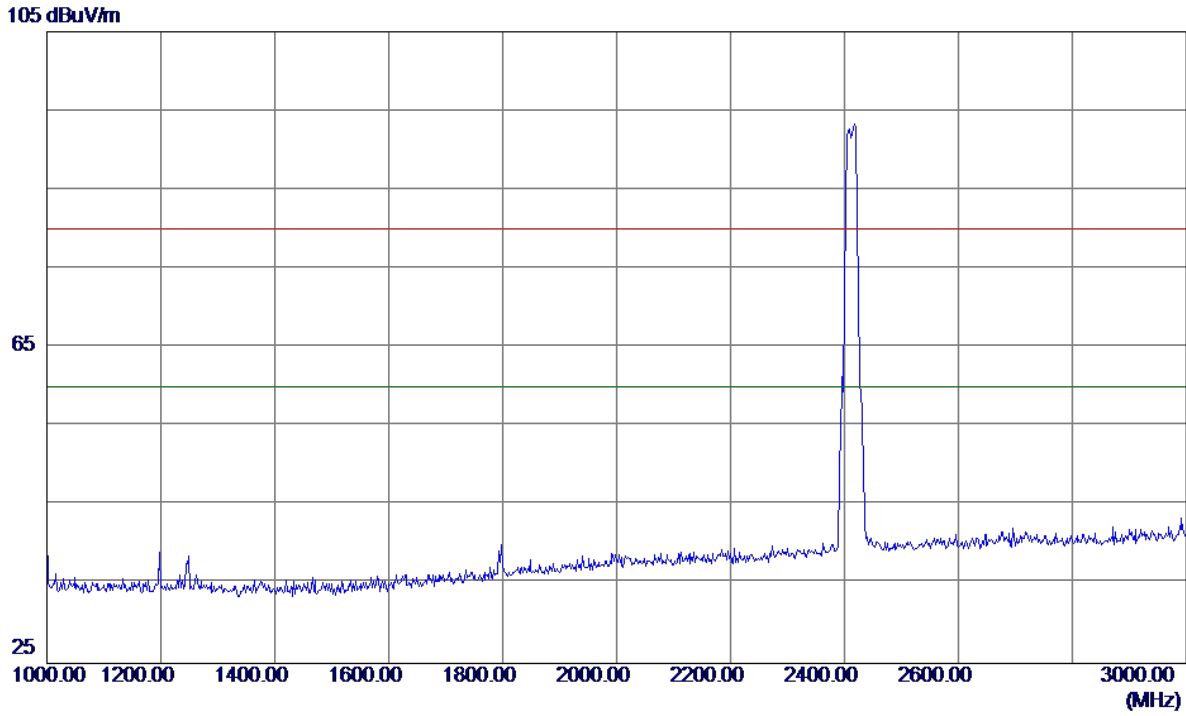

No.	Freq. MHz	Reading Level dBuV/m	Correct Factor dB	Measure ment dBuV/m	Limit dBuV/m	Margin dB	Detector	Comment
-----	--------------	----------------------------	-------------------------	---------------------------	-----------------	--------------	----------	---------

Orthogonal Axis :	X
Test Mode :	TX G MODE 2412MHz

**Vertical**

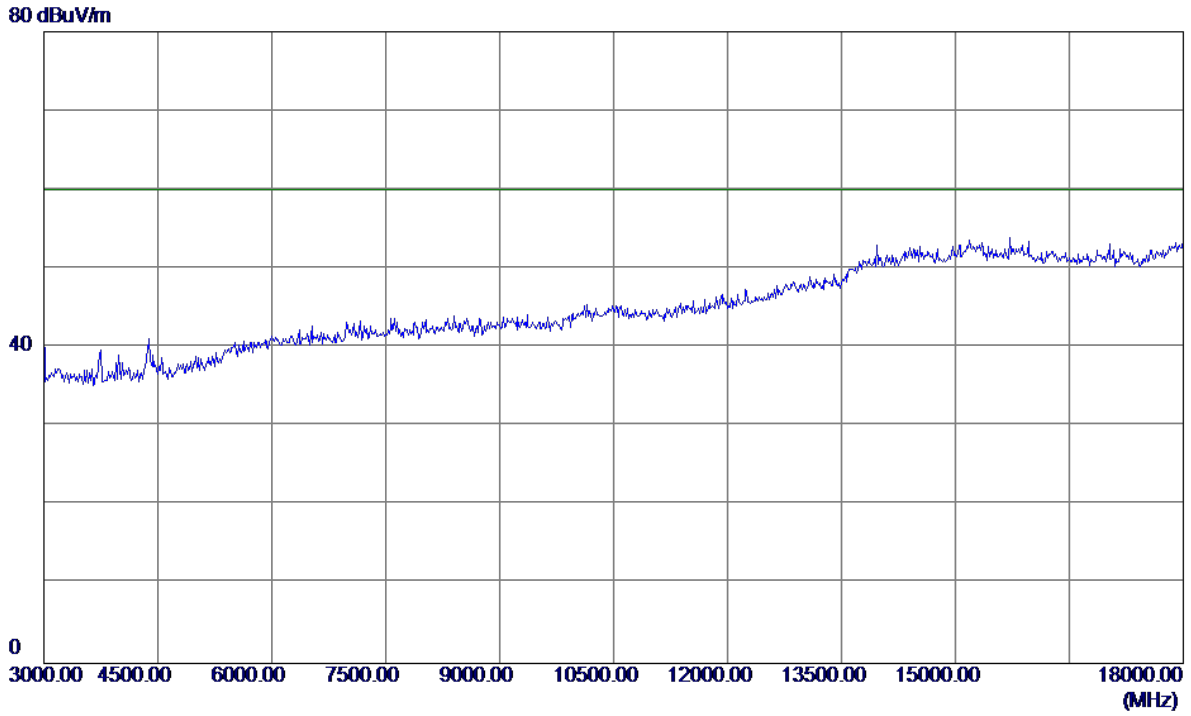

No.	Freq. MHz	Reading Level dBuV/m	Correct Factor dB	Measure ment dBuV/m	Limit dBuV/m	Margin dB	Detector	Comment



Orthogonal Axis :	X
Test Mode :	TX G MODE 2412MHz

**Vertical**

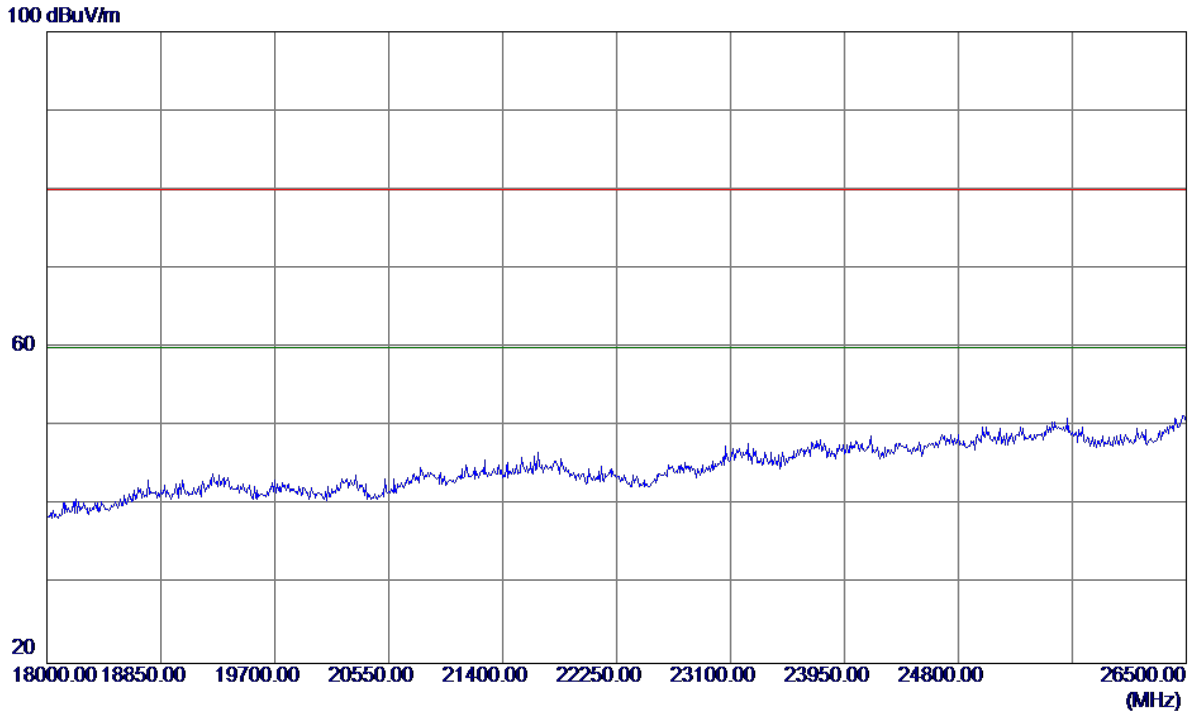

No.	Freq. MHz	Reading Level dBuV/m	Correct Factor dB	Measure ment dBuV/m	Limit dBuV/m	Margin dB	Detector	Comment

Orthogonal Axis :	X
Test Mode :	TX G MODE 2412MHz

**Horizontal**

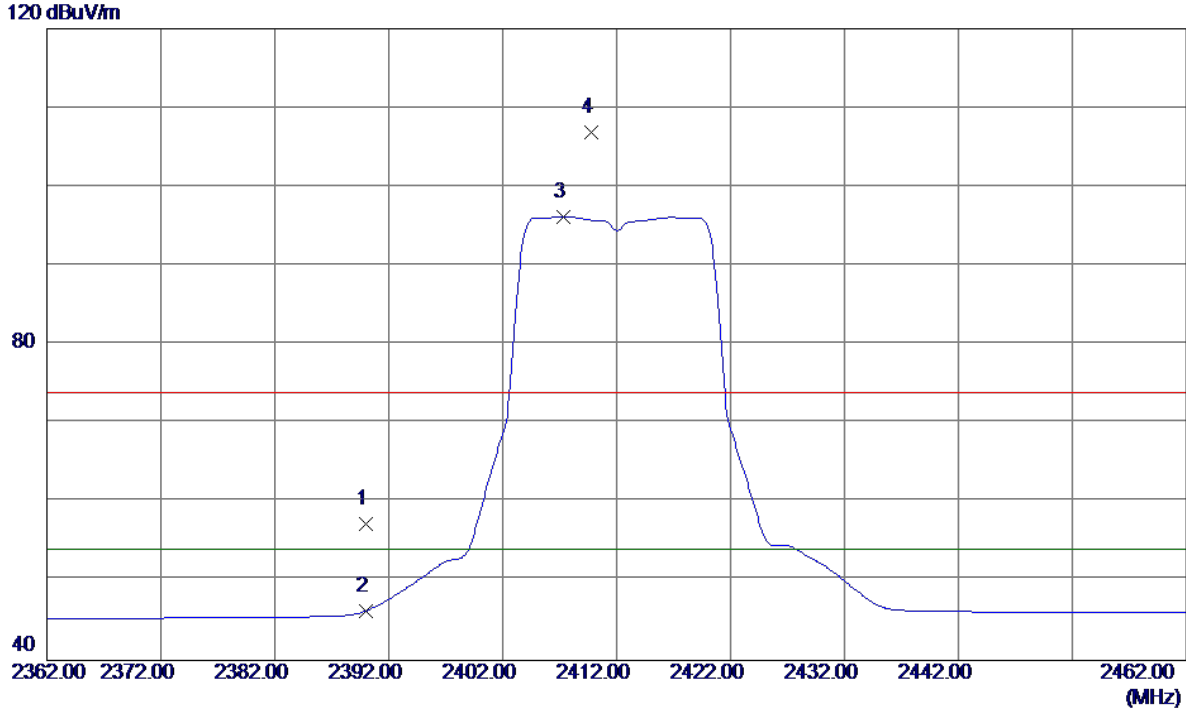

No.	Freq. MHz	Reading Level dBuV/m	Correct Factor dB	Measure ment dBuV/m	Limit dBuV/m	Margin dB	Detector	Comment
1	2390.0000	24.94	32.38	57.32	74.00	-16.68	Peak	
2	2390.0000	13.89	32.38	46.27	54.00	-7.73	AVG	
3 *	2407.3000	63.71	32.44	96.15	54.00	42.15	AVG	No Limit
4	2409.8000	74.44	32.45	106.89	74.00	32.89	Peak	No Limit

Orthogonal Axis :	X
Test Mode :	TX G MODE 2412MHz

**Horizontal**

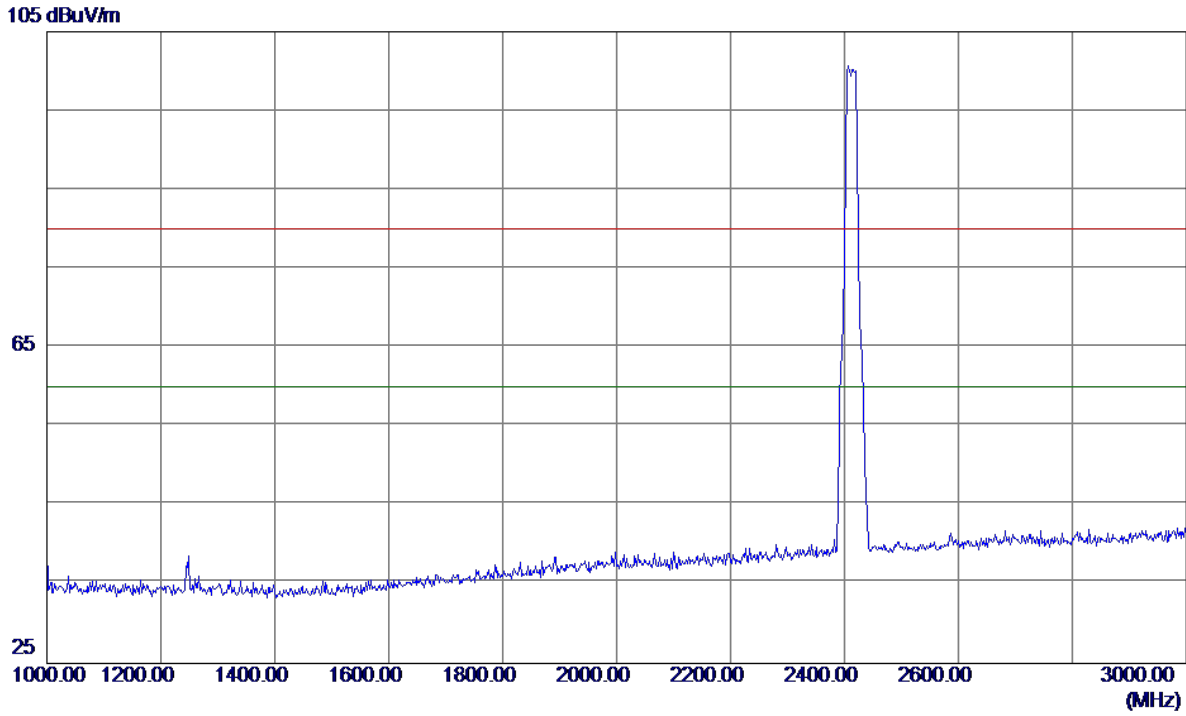

No.	Freq. MHz	Reading Level dBuV/m	Correct Factor dB	Measure ment dBuV/m	Limit dBuV/m	Margin dB	Detector	Comment
	2412	105		105	75	30		

Orthogonal Axis :	X
Test Mode :	TX G MODE 2412MHz

**Horizontal**

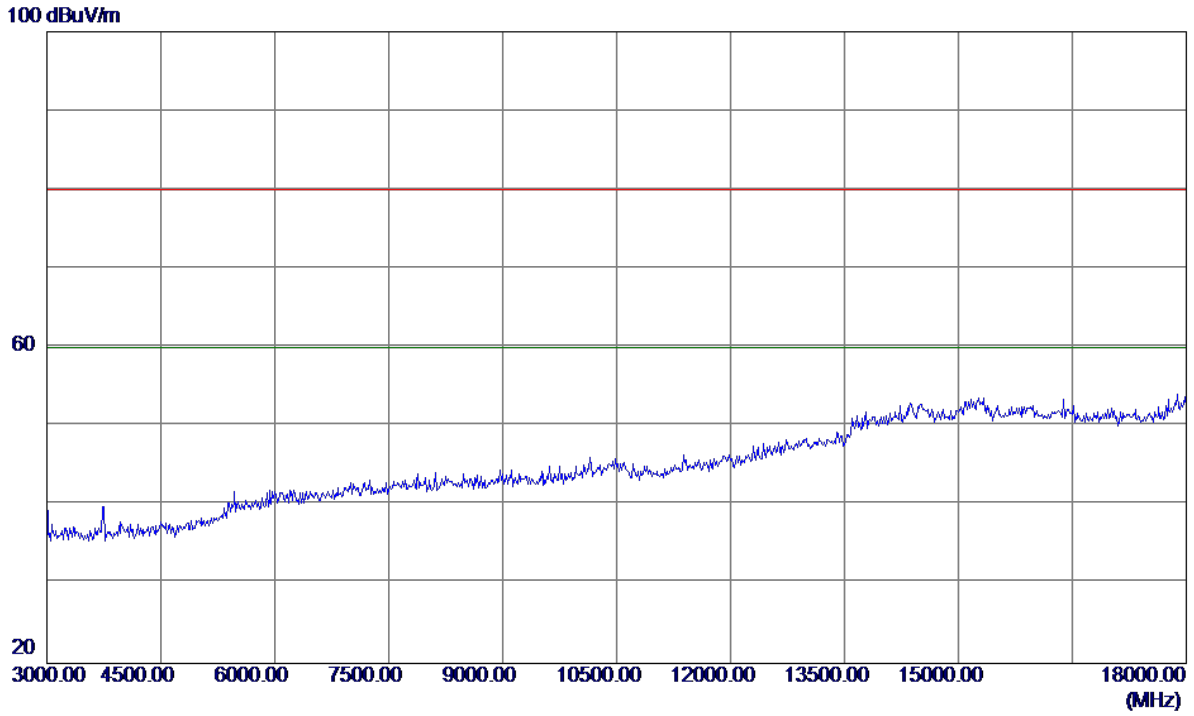

No.	Freq. MHz	Reading Level dBuV/m	Correct Factor dB	Measure ment dBuV/m	Limit dBuV/m	Margin dB	Detector	Comment
-----	--------------	----------------------------	-------------------------	---------------------------	-----------------	--------------	----------	---------

Orthogonal Axis :	X
Test Mode :	TX G MODE 2412MHz

**Horizontal**

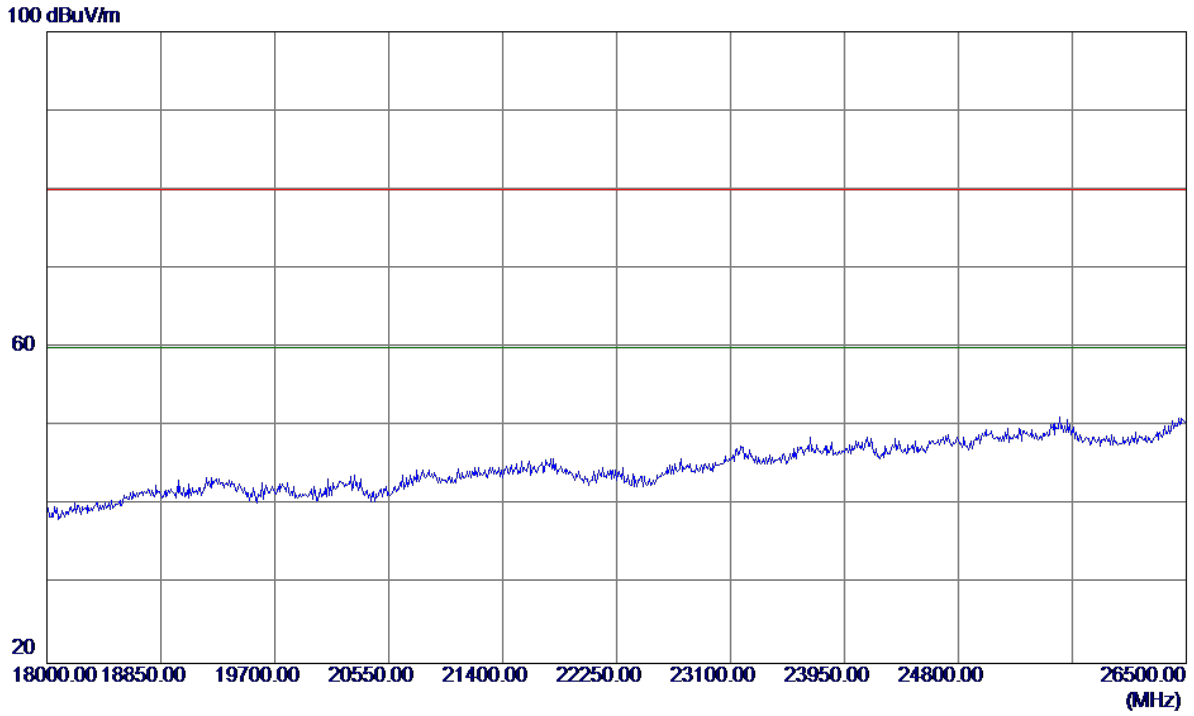

No.	Freq. MHz	Reading Level dBuV/m	Correct Factor dB	Measure ment dBuV/m	Limit dBuV/m	Margin dB	Detector	Comment
-----	--------------	----------------------------	-------------------------	---------------------------	-----------------	--------------	----------	---------

Orthogonal Axis :	X
Test Mode :	TX G MODE 2462MHz

**Vertical**

120 dBuV/m

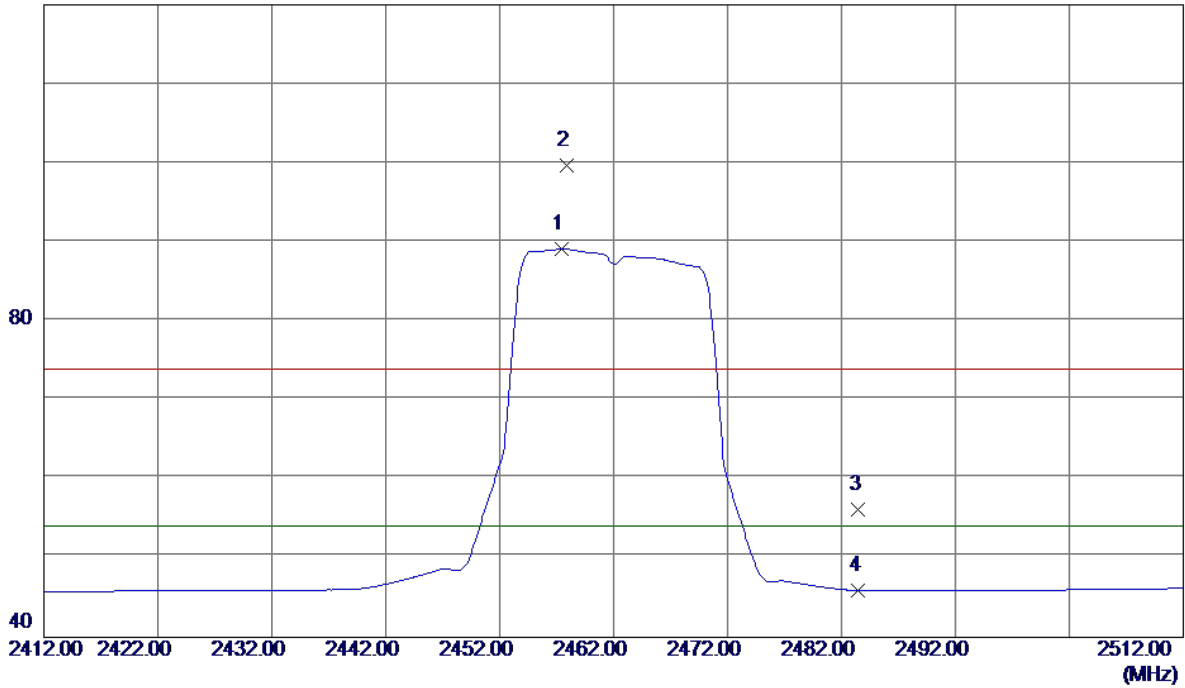

No.	Freq. MHz	Reading Level dBuV/m	Correct Factor dB	Measure ment dBuV/m	Limit dBuV/m	Margin dB	Detector	Comment
1 *	2457.4000	56.45	32.62	89.07	54.00	35.07	AVG	No Limit
2	2457.9000	67.10	32.62	99.72	74.00	25.72	Peak	No Limit
3	2483.5000	23.52	32.71	56.23	74.00	-17.77	Peak	
4	2483.5000	13.20	32.71	45.91	54.00	-8.09	AVG	

Orthogonal Axis :	X
Test Mode :	TX G MODE 2462MHz

**Vertical**

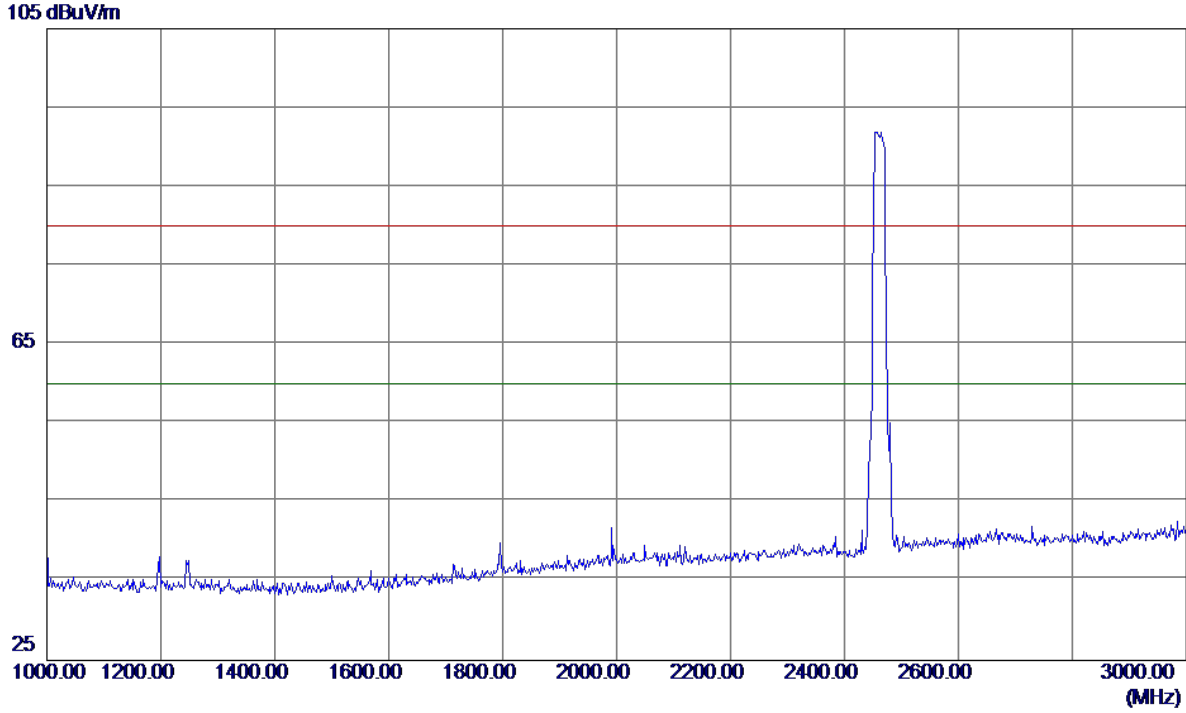

No.	Freq. MHz	Reading Level dBuV/m	Correct Factor dB	Measure ment dBuV/m	Limit dBuV/m	Margin dB	Detector	Comment

Orthogonal Axis :	X
Test Mode :	TX G MODE 2462MHz

**Vertical**

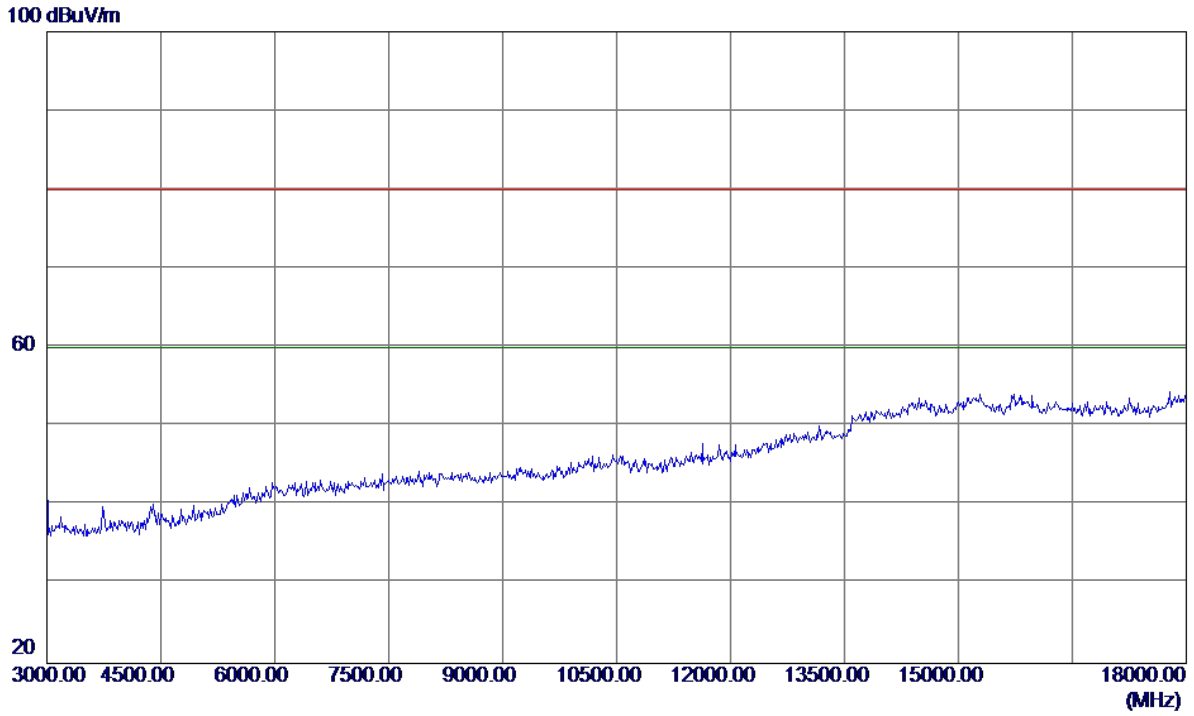

No.	Freq. MHz	Reading Level dBuV/m	Correct Factor dB	Measure ment dBuV/m	Limit dBuV/m	Margin dB	Detector	Comment



Orthogonal Axis :	X
Test Mode :	TX G MODE 2462MHz

**Vertical**

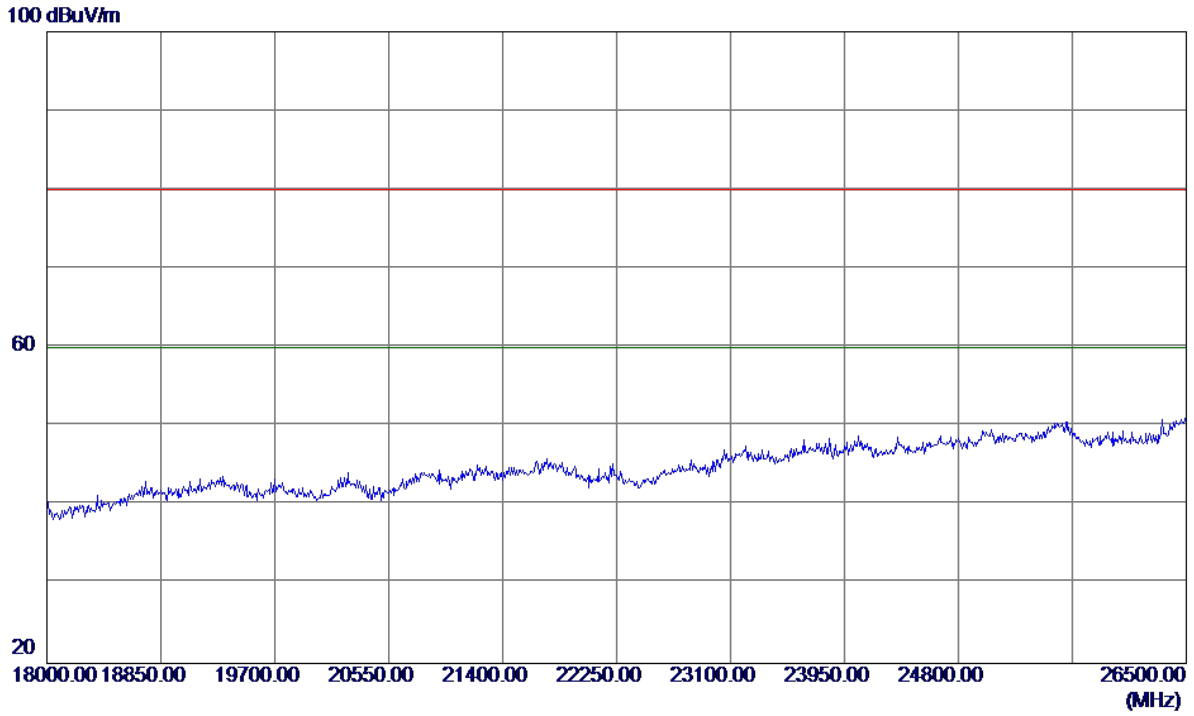

No.	Freq. MHz	Reading Level dBuV/m	Correct Factor dB	Measure ment dBuV/m	Limit dBuV/m	Margin dB	Detector	Comment

Orthogonal Axis :	X
Test Mode :	TX G MODE 2462MHz

**Horizontal**

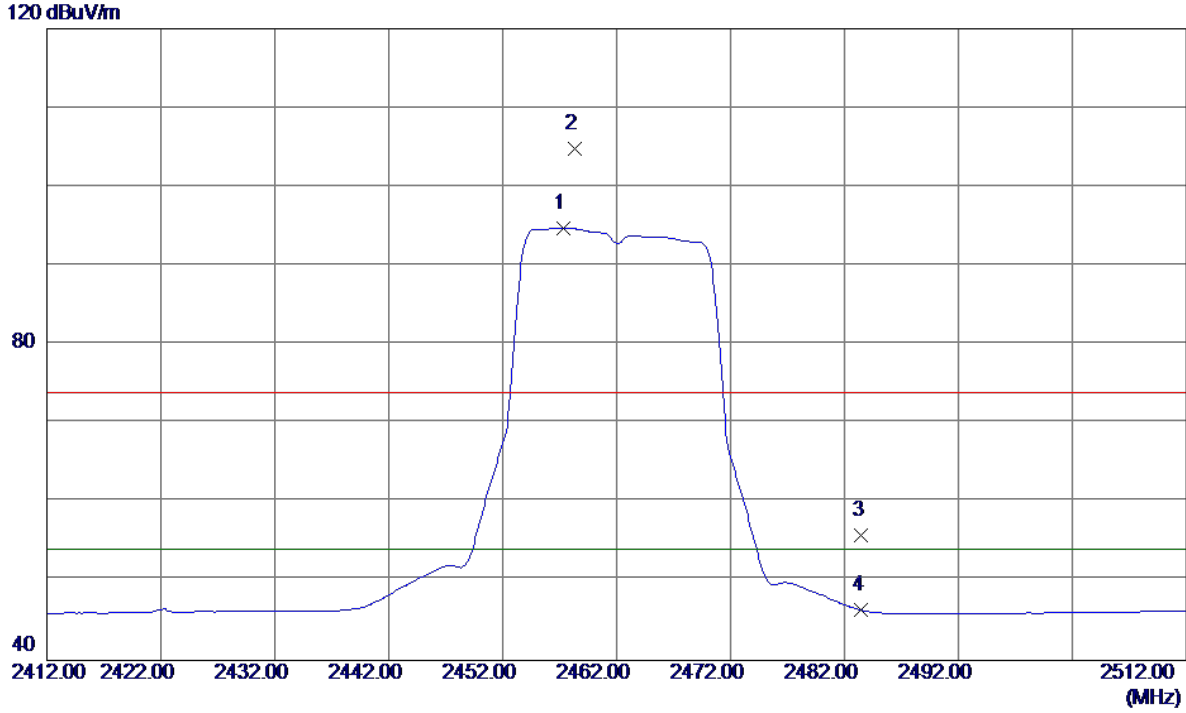

No.	Freq. MHz	Reading Level dBuV/m	Correct Factor dB	Measure ment dBuV/m	Limit dBuV/m	Margin dB	Detector	Comment
1 *	2457.3000	62.12	32.62	94.74	54.00	40.74	AVG	No Limit
2	2458.3000	72.25	32.62	104.87	74.00	30.87	Peak	No Limit
3	2483.5000	23.18	32.71	55.89	74.00	-18.11	Peak	
4	2483.5000	13.67	32.71	46.38	54.00	-7.62	AVG	

Orthogonal Axis :	X
Test Mode :	TX G MODE 2462MHz

**Horizontal**

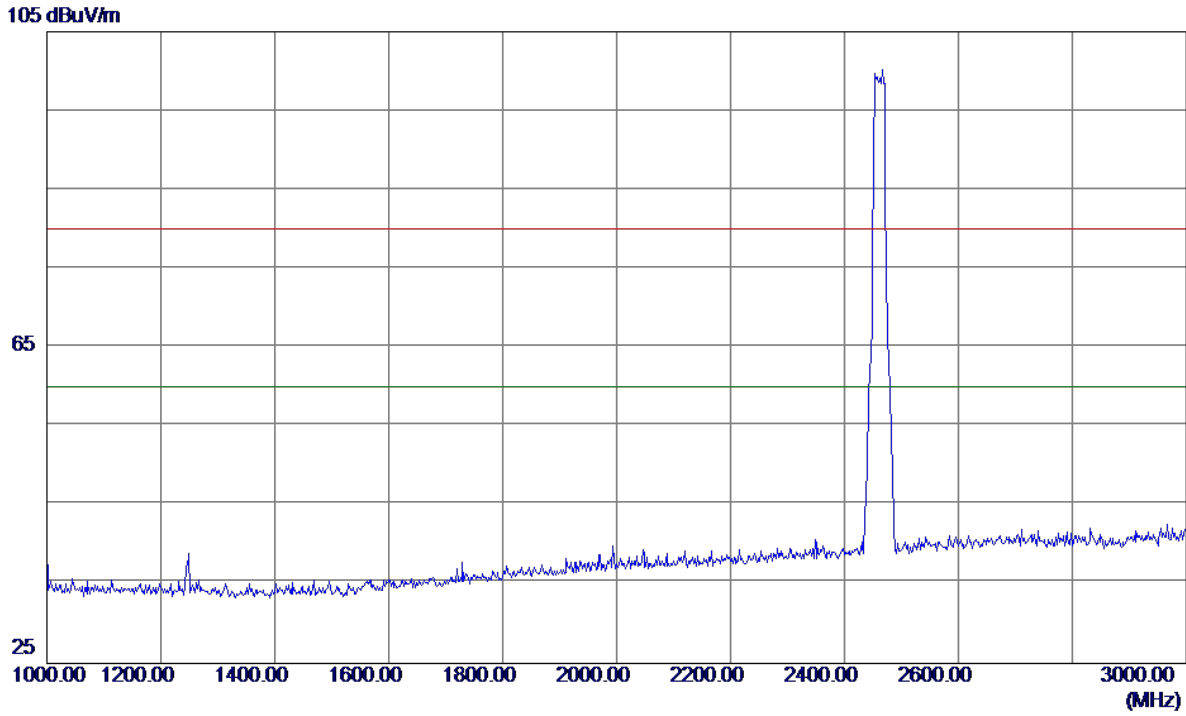

No.	Freq. MHz	Reading Level dBuV/m	Correct Factor dB	Measure ment dBuV/m	Limit dBuV/m	Margin dB	Detector	Comment
-----	--------------	----------------------------	-------------------------	---------------------------	-----------------	--------------	----------	---------

Orthogonal Axis :	X
Test Mode :	TX G MODE 2462MHz

**Horizontal**

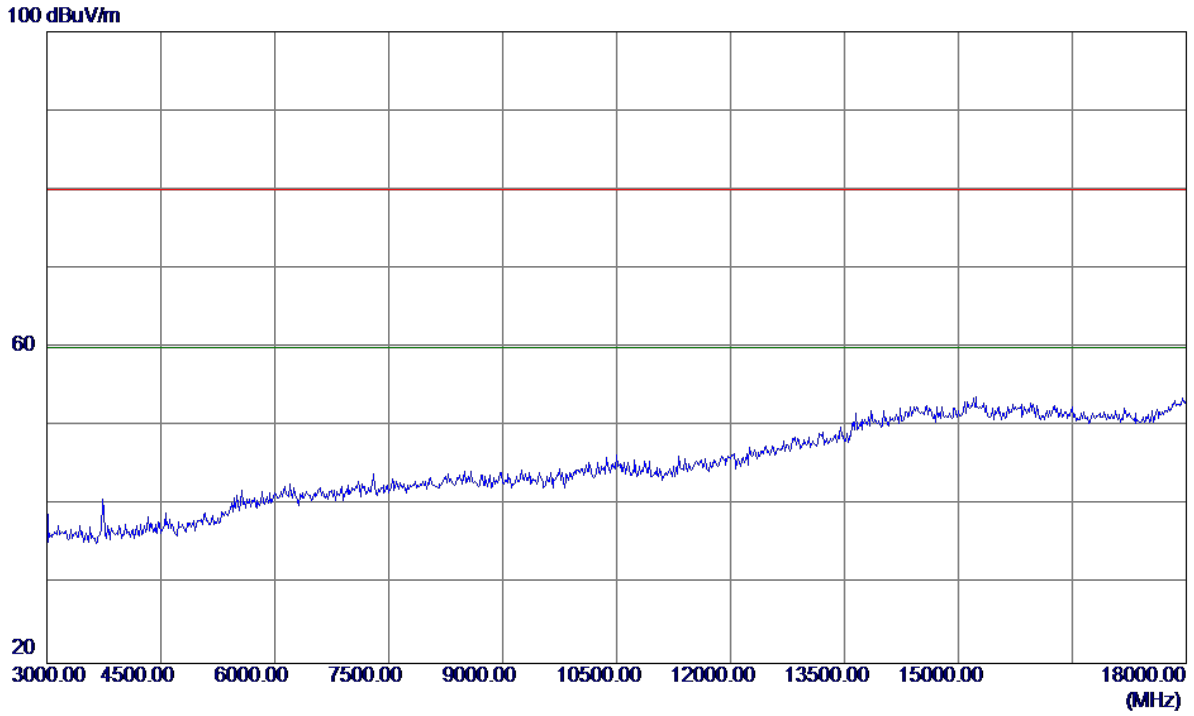

No.	Freq. MHz	Reading Level dBuV/m	Correct Factor dB	Measure ment dBuV/m	Limit dBuV/m	Margin dB	Detector	Comment

Orthogonal Axis :	X
Test Mode :	TX G MODE 2462MHz

**Horizontal**

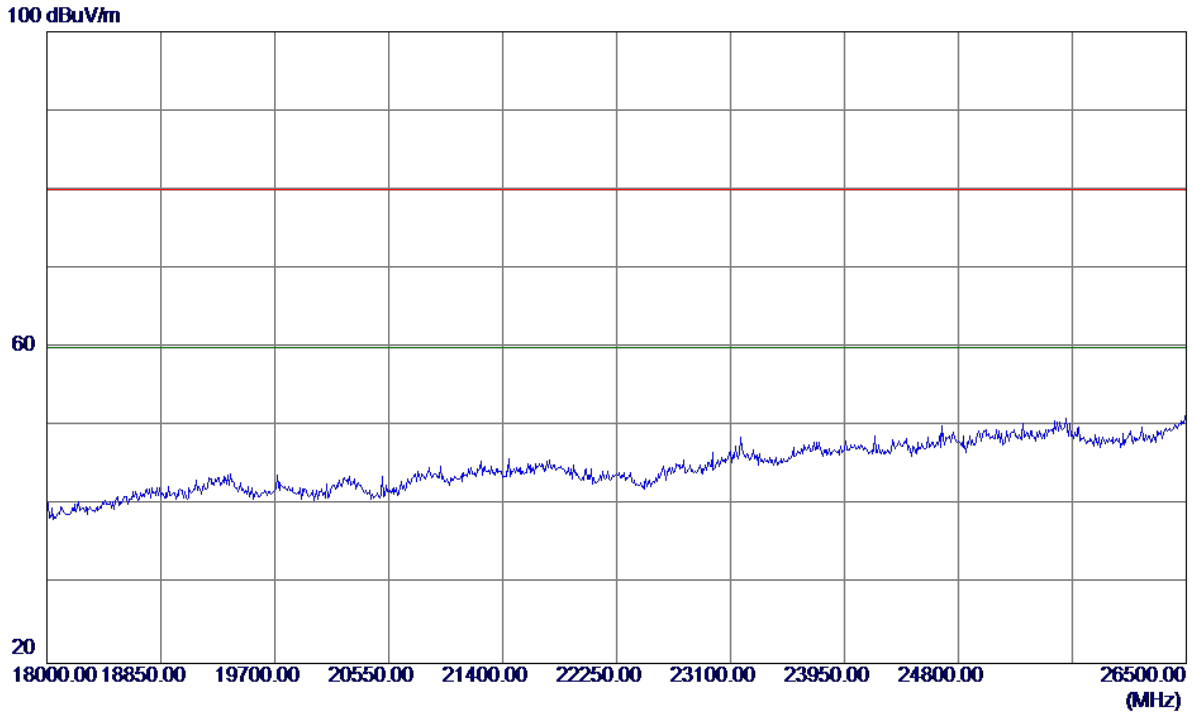

No.	Freq. MHz	Reading Level dBuV/m	Correct Factor dB	Measure ment dBuV/m	Limit dBuV/m	Margin dB	Detector	Comment

Orthogonal Axis :	X
Test Mode :	TX N-20M MODE 2412MHz

**Vertical**

120 dBuV/m

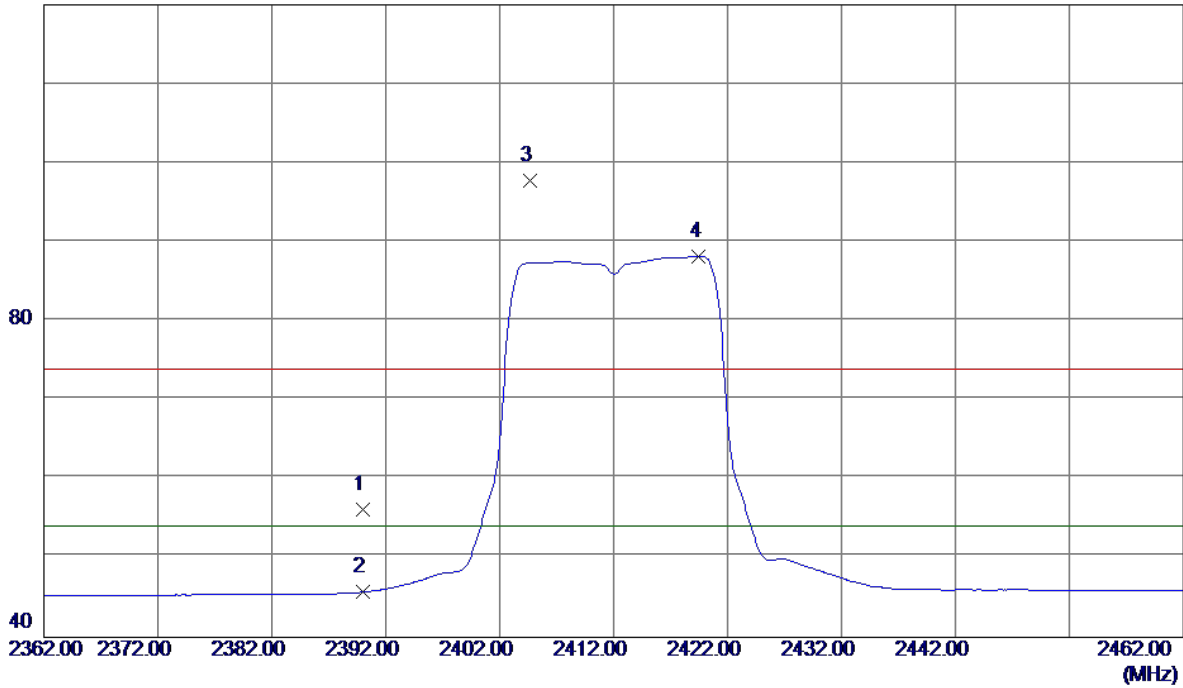

No.	Freq. MHz	Reading Level dBuV/m	Correct Factor dB	Measure ment dBuV/m	Limit dBuV/m	Margin dB	Detector	Comment
1	2390.0000	23.78	32.38	56.16	74.00	-17.84	Peak	
2	2390.0000	13.33	32.38	45.71	54.00	-8.29	AVG	
3	2404.7000	65.27	32.43	97.70	74.00	23.70	Peak	No Limit
4 *	2419.5000	55.71	32.48	88.19	54.00	34.19	AVG	No Limit

Orthogonal Axis :	X
Test Mode :	TX N-20M MODE 2412MHz

**Vertical**

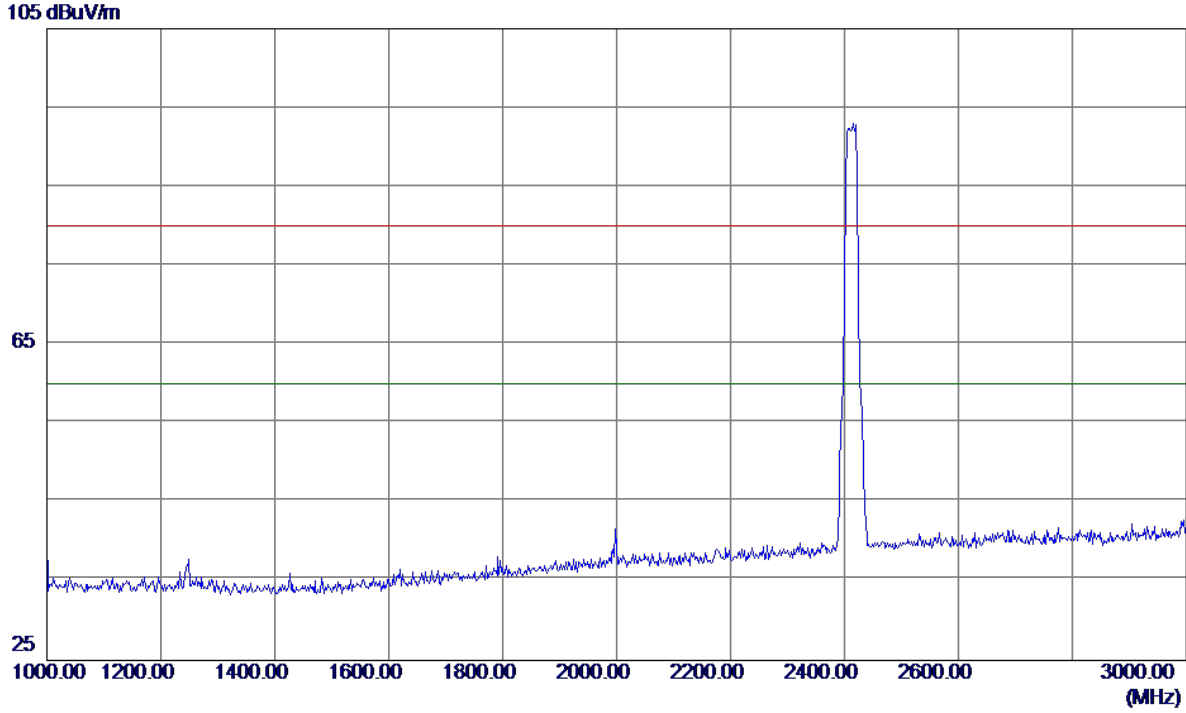

No.	Freq. MHz	Reading Level dBuV/m	Correct Factor dB	Measure ment dBuV/m	Limit dBuV/m	Margin dB	Detector	Comment
-----	--------------	----------------------------	-------------------------	---------------------------	-----------------	--------------	----------	---------

Orthogonal Axis :	X
Test Mode :	TX N-20M MODE 2412MHz

**Vertical**

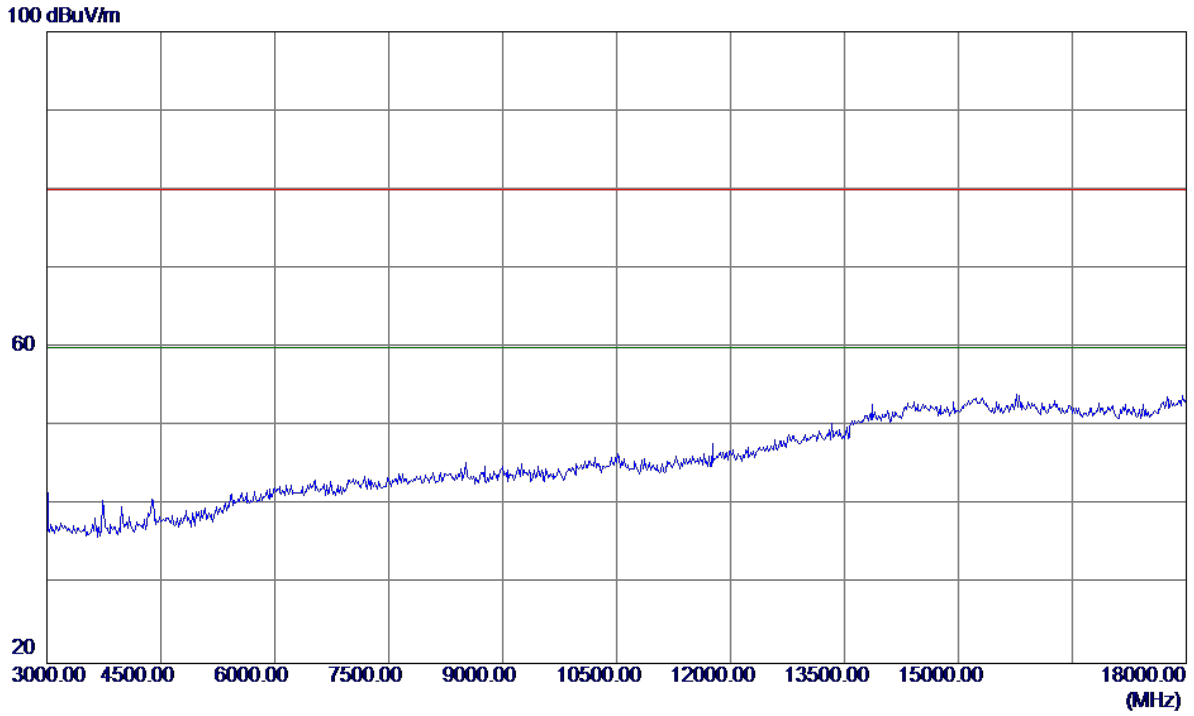

No.	Freq. MHz	Reading Level dBuV/m	Correct Factor dB	Measure ment dBuV/m	Limit dBuV/m	Margin dB	Detector	Comment
-----	--------------	----------------------------	-------------------------	---------------------------	-----------------	--------------	----------	---------



Orthogonal Axis :	X
Test Mode :	TX N-20M MODE 2412MHz

**Vertical**

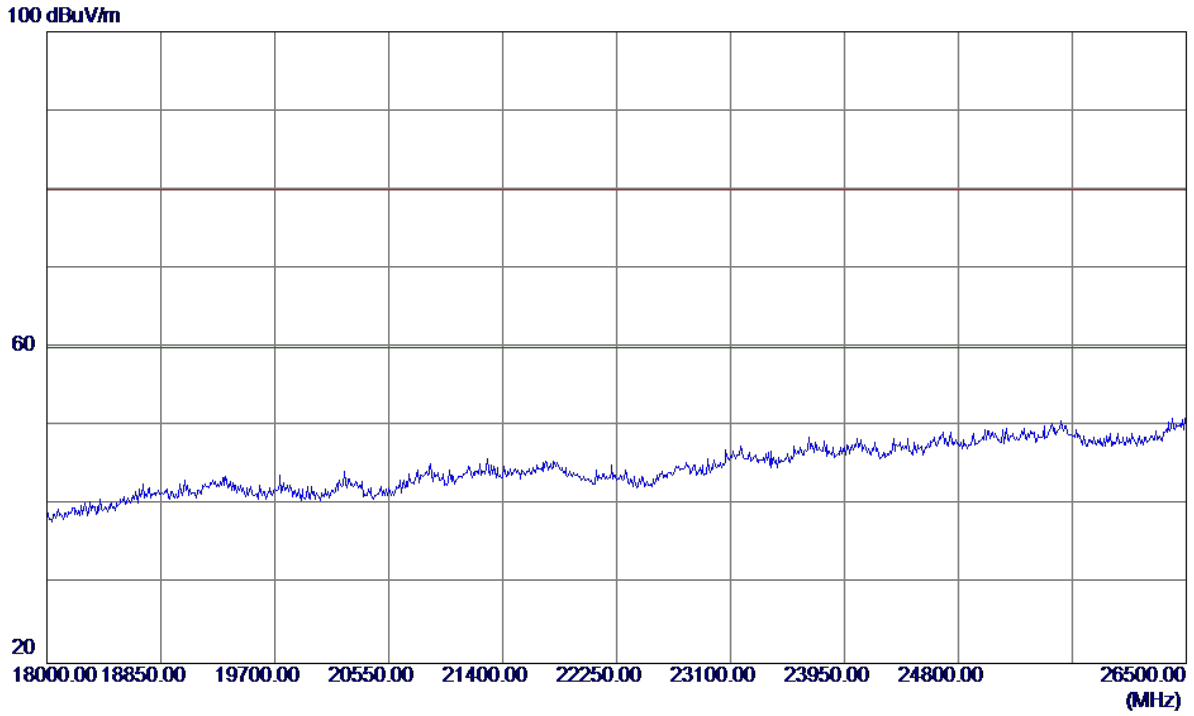

No.	Freq. MHz	Reading Level dBuV/m	Correct Factor dB	Measure ment dBuV/m	Limit dBuV/m	Margin dB	Detector	Comment

Orthogonal Axis :	X
Test Mode :	TX N-20M MODE 2412MHZ

**Horizontal**

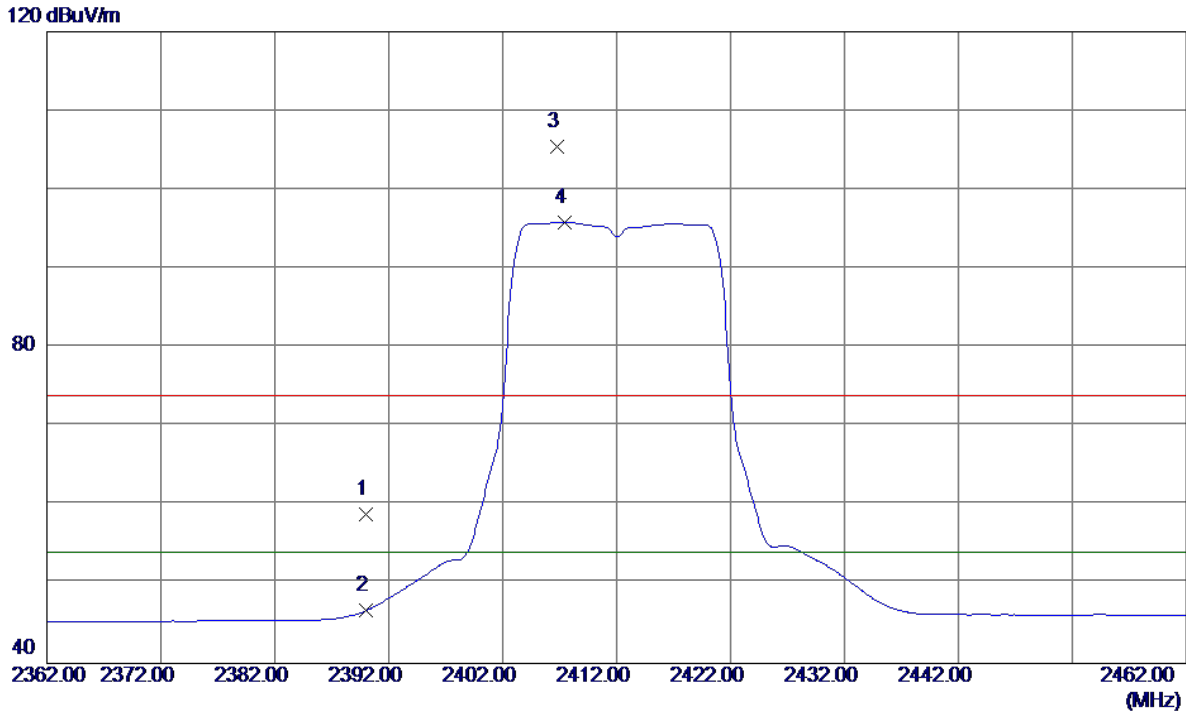

No.	Freq. MHz	Reading Level dBuV/m	Correct Factor dB	Measure ment dBuV/m	Limit dBuV/m	Margin dB	Detector	Comment
1	2390.0000	26.46	32.38	58.84	74.00	-15.16	Peak	
2	2390.0000	14.28	32.38	46.66	54.00	-7.34	AVG	
3	2406.8000	73.06	32.44	105.50	74.00	31.50	Peak	No Limit
4 *	2407.4000	63.40	32.44	95.84	54.00	41.84	AVG	No Limit

Orthogonal Axis :	X
Test Mode :	TX N-20M MODE 2412MHz

**Horizontal**

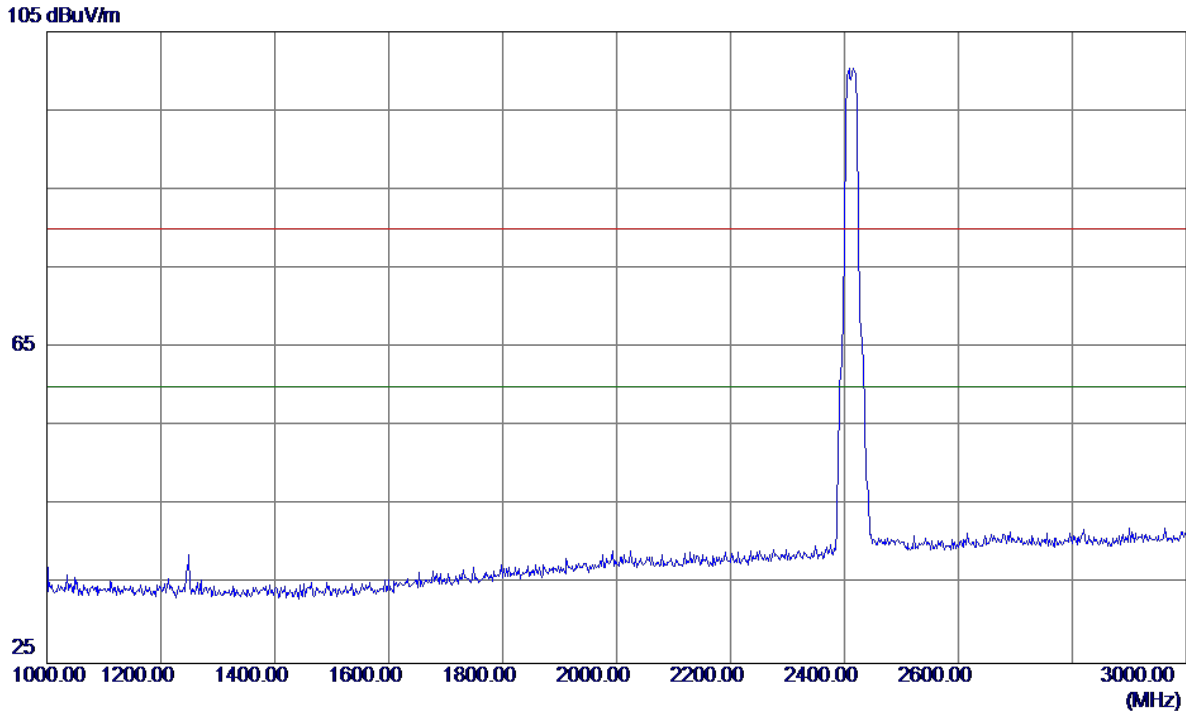

No.	Freq. MHz	Reading Level dBuV/m	Correct Factor dB	Measure ment dBuV/m	Limit dBuV/m	Margin dB	Detector	Comment
-----	--------------	----------------------------	-------------------------	---------------------------	-----------------	--------------	----------	---------

Orthogonal Axis :	X
Test Mode :	TX N-20M MODE 2412MHz

**Horizontal**

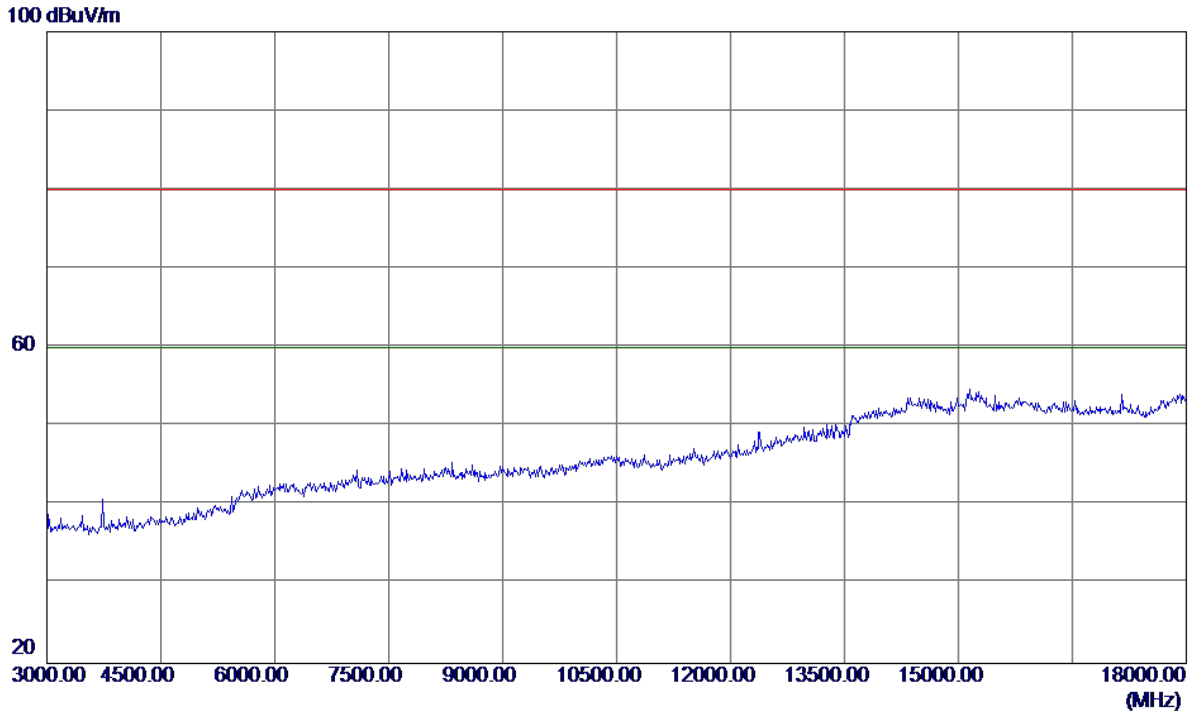

No.	Freq. MHz	Reading Level dBuV/m	Correct Factor dB	Measure ment dBuV/m	Limit dBuV/m	Margin dB	Detector	Comment
-----	--------------	----------------------------	-------------------------	---------------------------	-----------------	--------------	----------	---------

Orthogonal Axis :	X
Test Mode :	TX N-20M MODE 2412MHz

**Horizontal**

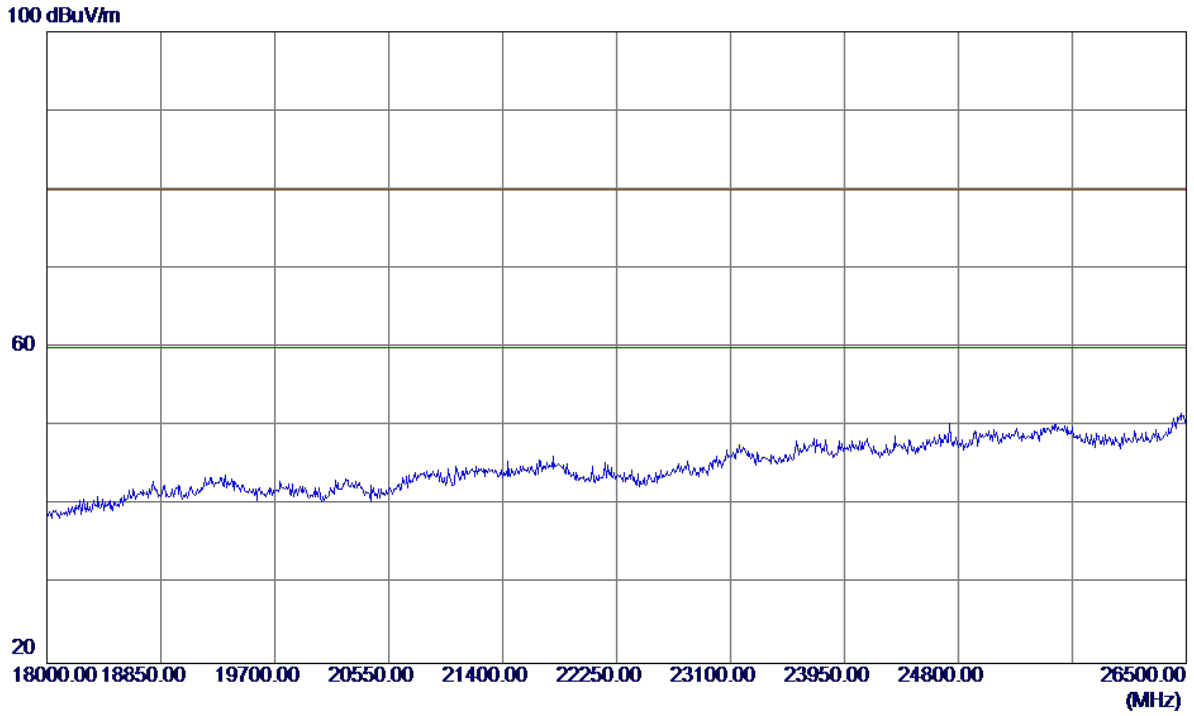

No.	Freq. MHz	Reading Level dBuV/m	Correct Factor dB	Measure ment dBuV/m	Limit dBuV/m	Margin dB	Detector	Comment

Orthogonal Axis :	X
Test Mode :	TX N-20M MODE 2462MHz

**Vertical**

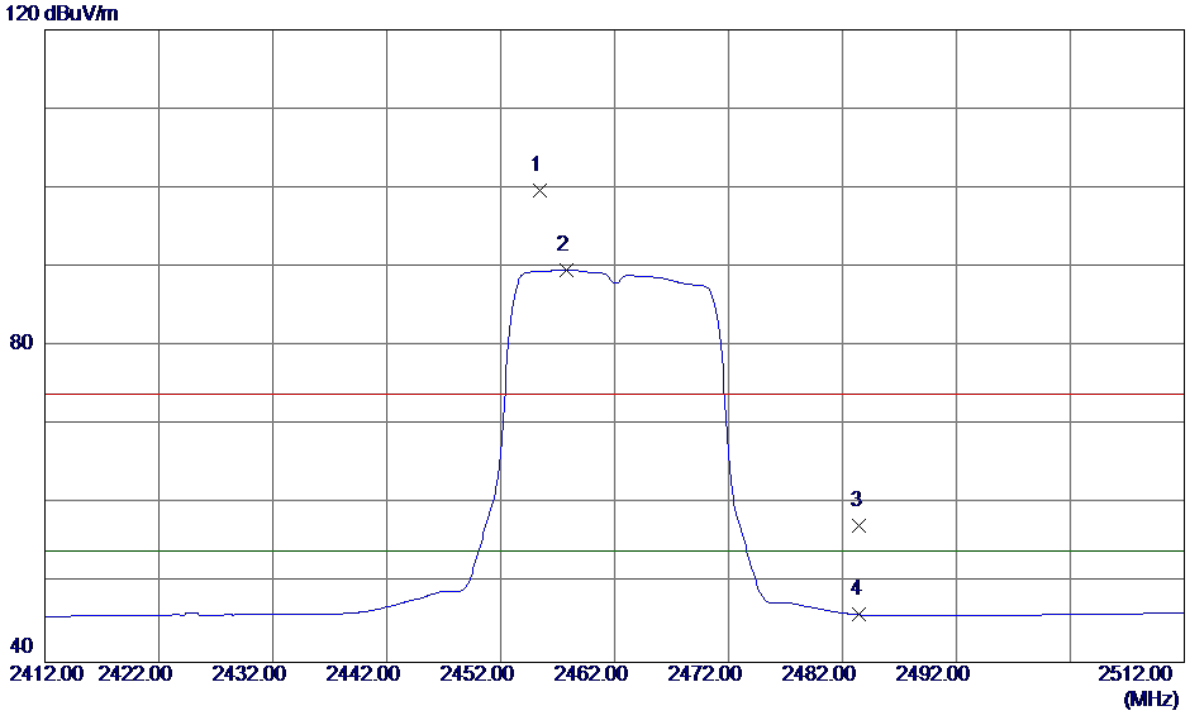

No.	Freq. MHz	Reading Level dBuV/m	Correct Factor dB	Measure ment dBuV/m	Limit dBuV/m	Margin dB	Detector	Comment
1	2455.4000	67.11	32.61	99.72	74.00	25.72	Peak	No Limit
2 *	2457.8000	57.04	32.62	89.66	54.00	35.66	AVG	No Limit
3	2483.5000	24.58	32.71	57.29	74.00	-16.71	Peak	
4	2483.5000	13.32	32.71	46.03	54.00	-7.97	AVG	

Orthogonal Axis :	X
Test Mode :	TX N-20M MODE 2462MHz

**Vertical**

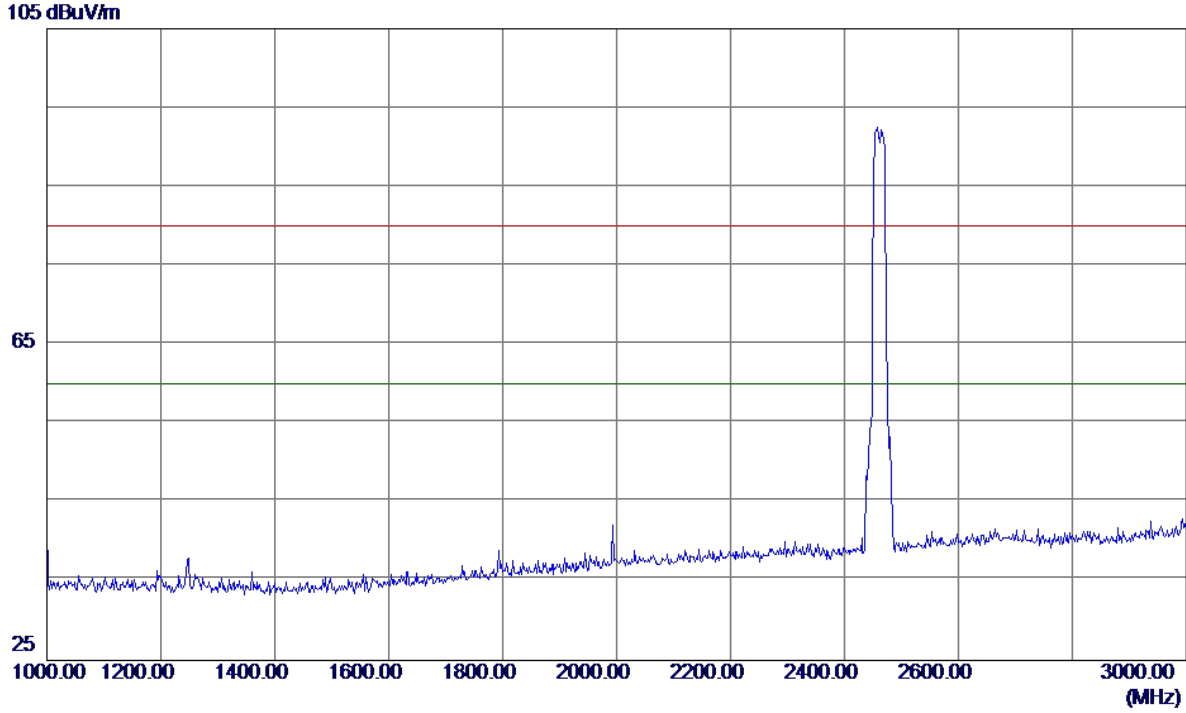

No.	Freq. MHz	Reading Level dBuV/m	Correct Factor dB	Measure ment dBuV/m	Limit dBuV/m	Margin dB	Detector	Comment

Orthogonal Axis :	X
Test Mode :	TX N-20M MODE 2462MHz

**Vertical**

100 dBuV/m

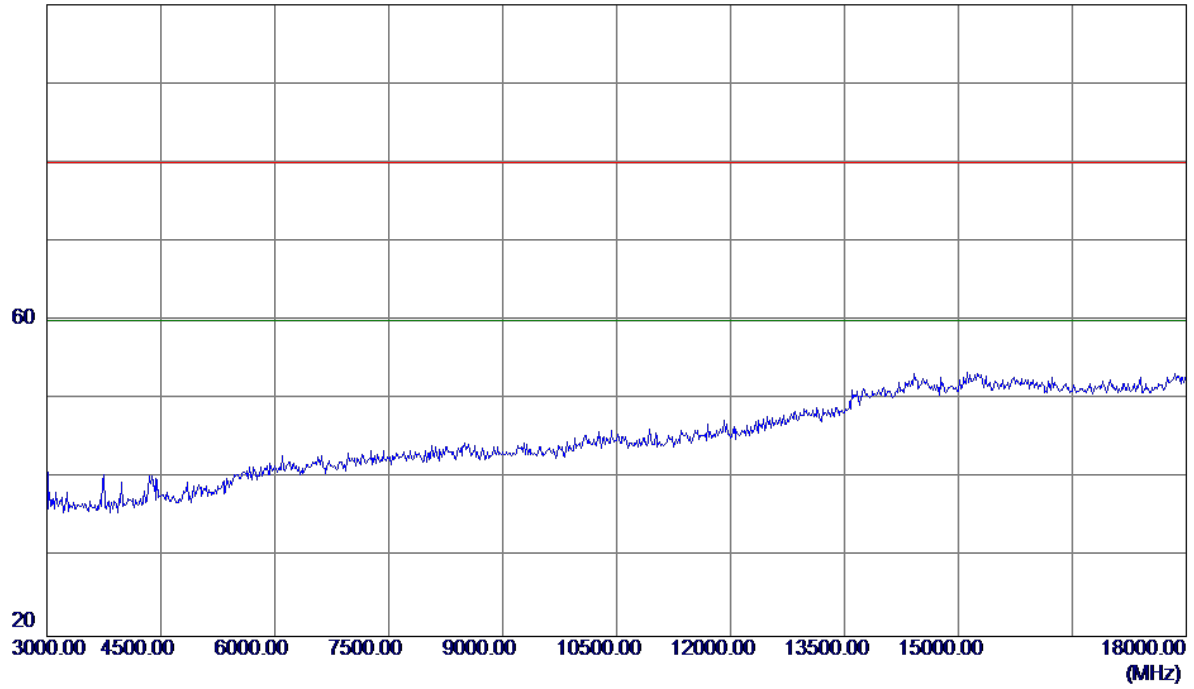

No.	Freq. MHz	Reading Level dBuV/m	Correct Factor dB	Measure ment dBuV/m	Limit dBuV/m	Margin dB	Detector	Comment



Orthogonal Axis :	X
Test Mode :	TX N-20M MODE 2462MHz

**Vertical**

100 dBuV/m

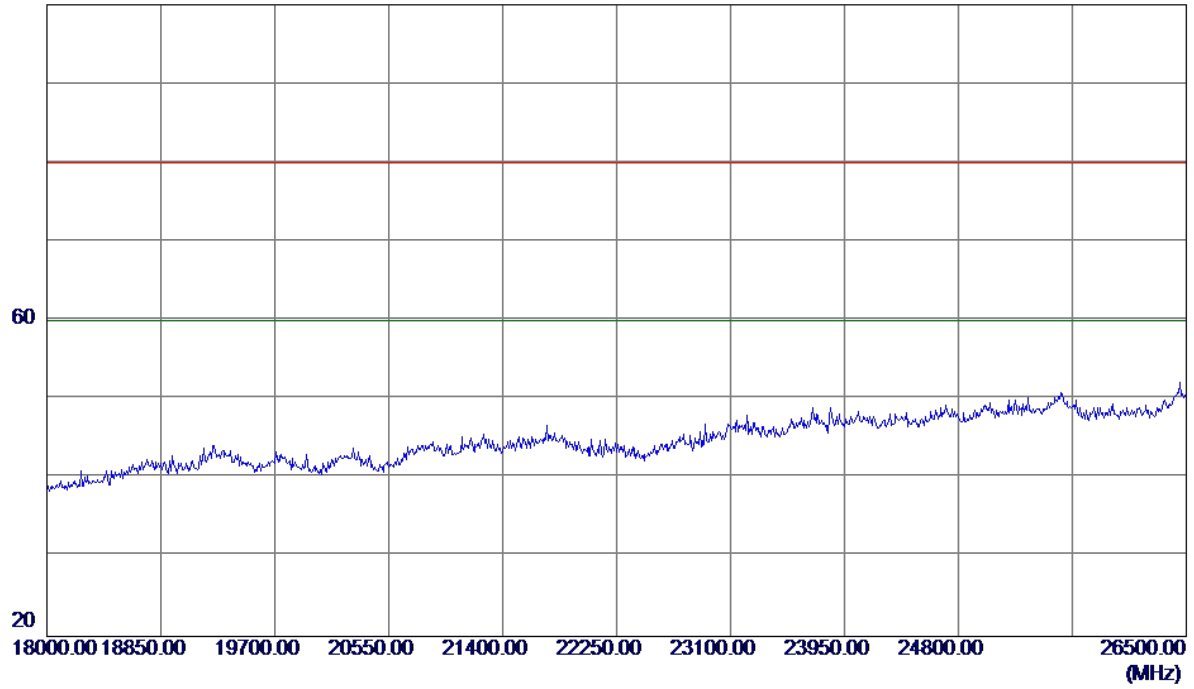

No.	Freq. MHz	Reading Level dBuV/m	Correct Factor dB	Measure ment dBuV/m	Limit dBuV/m	Margin dB	Detector	Comment

Orthogonal Axis :	X
Test Mode :	TX N-20M MODE 2462MHz

**Horizontal**

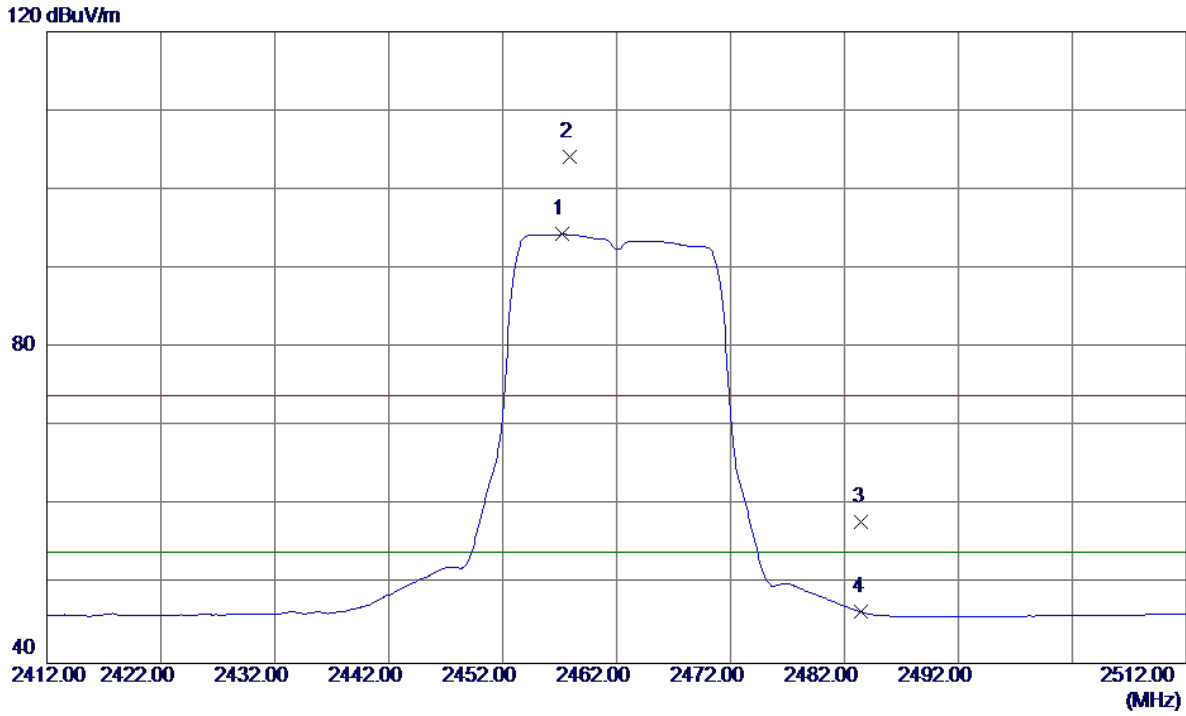

No.	Freq. MHz	Reading Level dBuV/m	Correct Factor dB	Measure ment dBuV/m	Limit dBuV/m	Margin dB	Detector	Comment
1 *	2457.2000	61.71	32.62	94.33	54.00	40.33	AVG	No Limit
2	2457.9000	71.61	32.62	104.23	74.00	30.23	Peak	No Limit
3	2483.5000	25.23	32.71	57.94	74.00	-16.06	Peak	
4	2483.5000	13.81	32.71	46.52	54.00	-7.48	AVG	

Orthogonal Axis :	X
Test Mode :	TX N-20M MODE 2462MHz

**Horizontal**

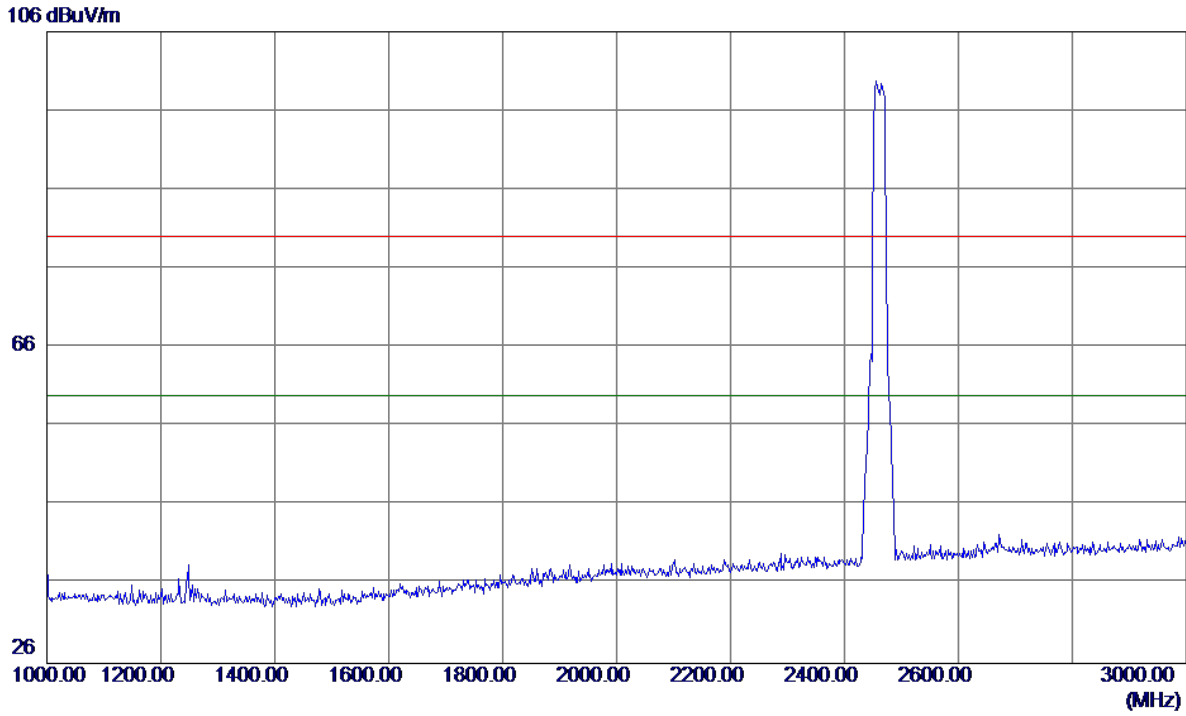

No.	Freq. MHz	Reading Level dBuV/m	Correct Factor dB	Measure ment dBuV/m	Limit dBuV/m	Margin dB	Detector	Comment

## ATTACHMENT E - BANDWIDTH

**Test Mode : TX B Mode\_CH01/06/11**

Frequency (MHz)	6dB Bandwidth (MHz)	99% Occupied BW (MHz)	Min. Limit (kHz)	Test Result
2412	8.56	13.08	500	Complies
2437	8.59	13.08	500	Complies
2462	8.07	13.12	500	Complies

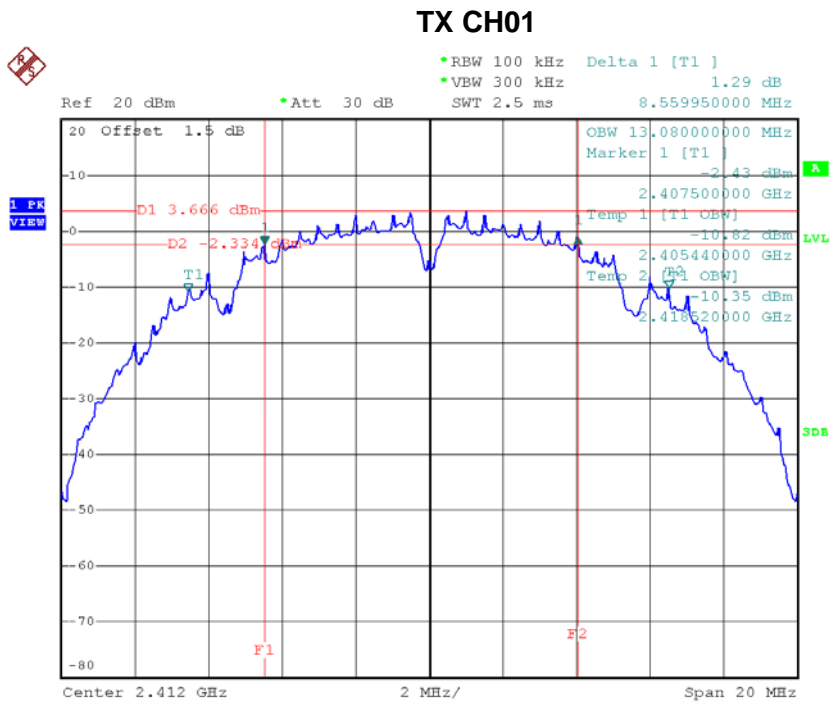

Date: 9.MAY.2017 19:51:38

**TX CH06**

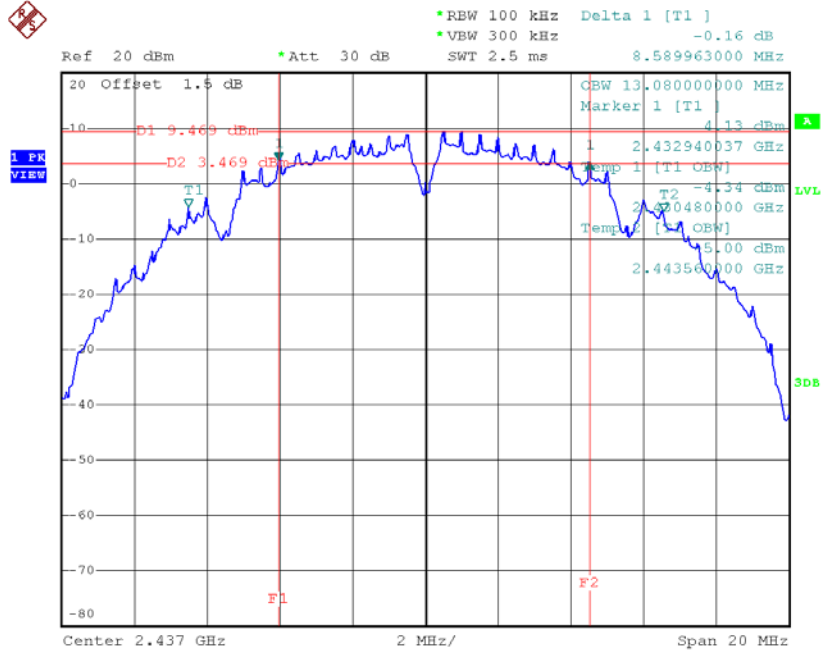

Date: 9.MAY.2017 19:53:55

**TX CH11**

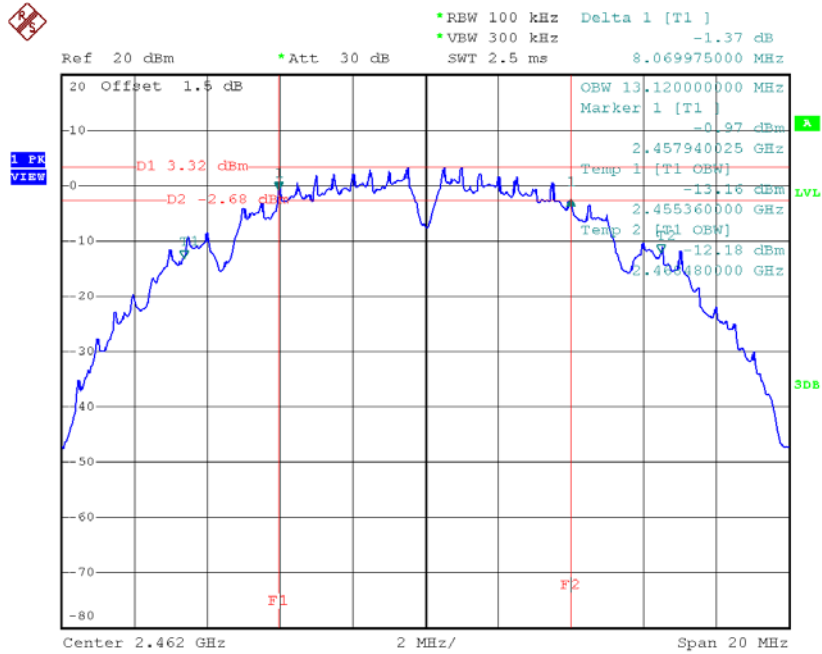

Date: 9.MAY.2017 19:55:27

**Test Mode: TX G Mode\_CH01/06/11**

Frequency (MHz)	6dB Bandwidth (MHz)	99% Occupied BW (MHz)	Min. Limit (kHz)	Test Result
2412	16.44	16.48	500	Complies
2437	16.4	16.52	500	Complies
2462	16.45	16.52	500	Complies

**TX CH01**

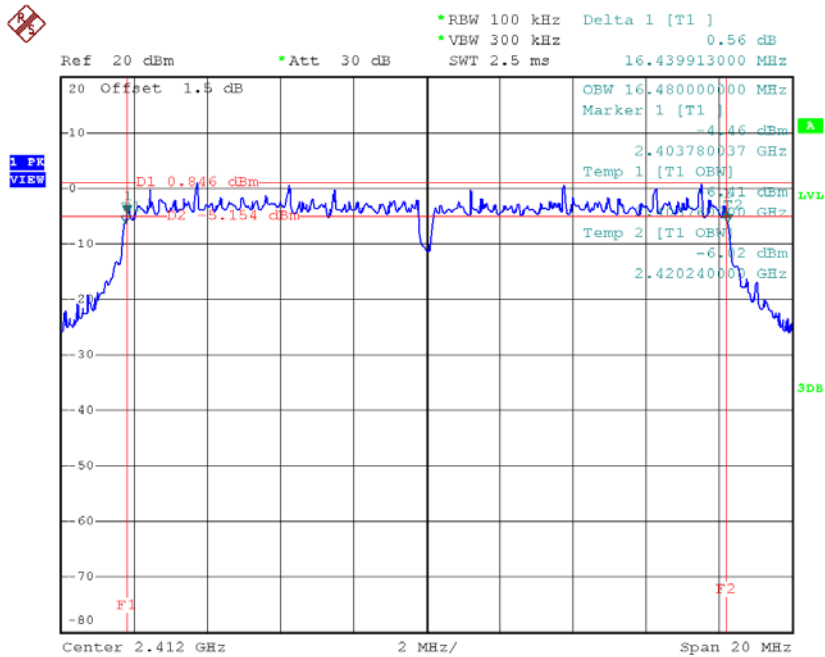

Date: 9.MAY.2017 19:56:58

**TX CH06**

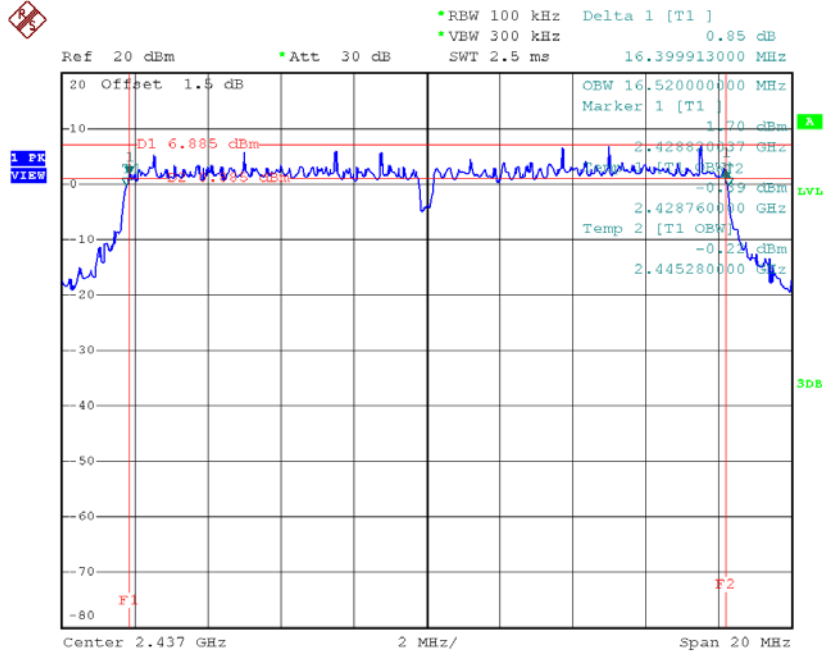

Date: 9.MAY.2017 19:58:43

**TX CH11**

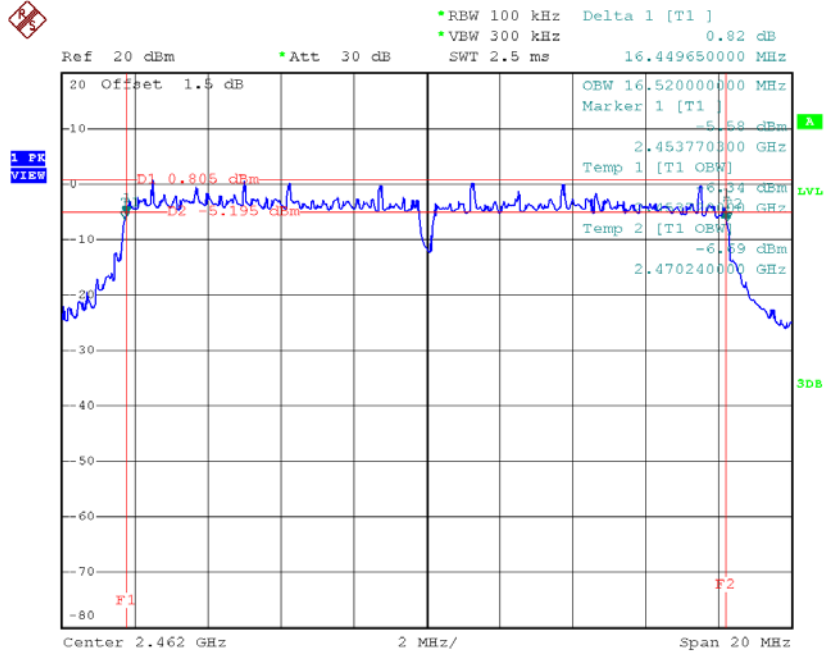

Date: 9.MAY.2017 20:00:24



**Test Mode : TX N-20MHz Mode\_CH01/06/11**

Frequency (MHz)	6dB Bandwidth (MHz)	99% Occupied BW (MHz)	Min. Limit (kHz)	Test Result
2412	17.64	17.68	500	Complies
2437	17.62	17.68	500	Complies
2462	17.62	17.64	500	Complies

**TX CH01**

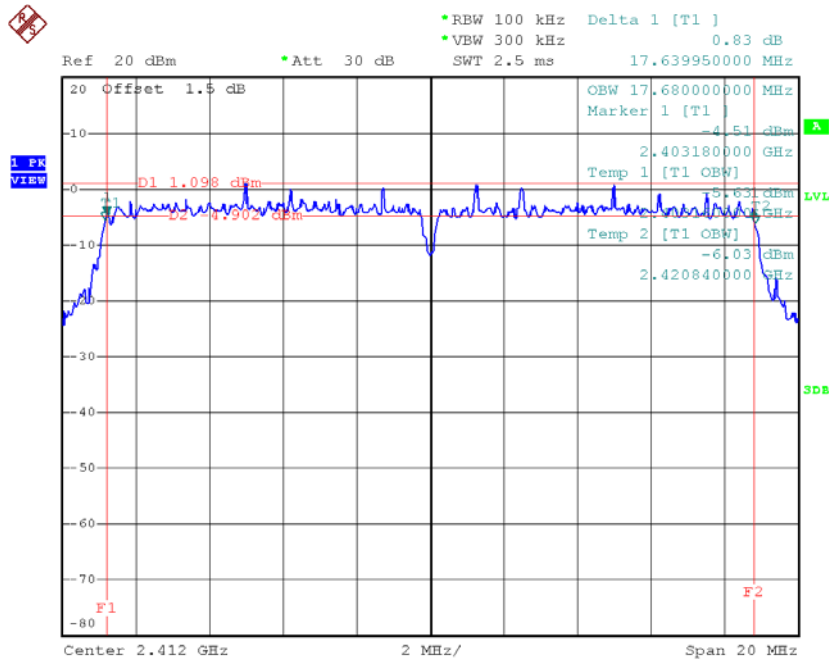

Date: 9.MAY.2017 20:01:43

TX CH06

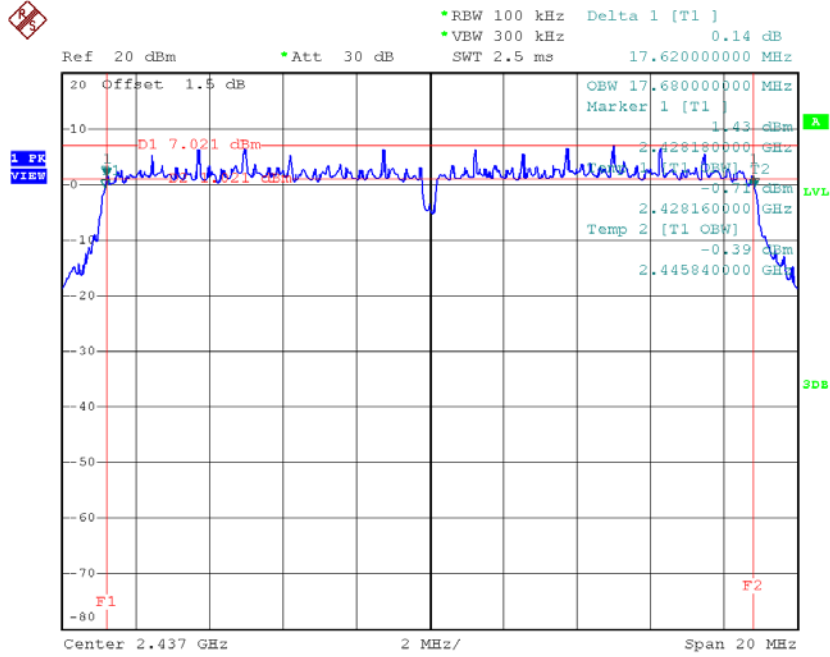

Date: 9.MAY.2017 20:03:04

TX CH11

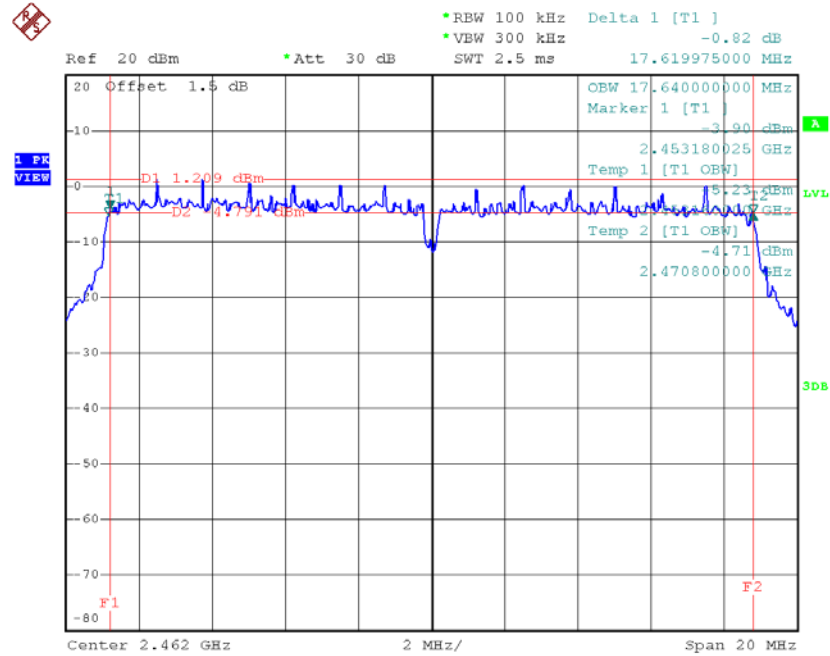

Date: 9.MAY.2017 20:04:15

# ATTACHMENT F – MAXIMUM PEAK CONDUCTED OUTPUT POWER

Test Mode :TX B Mode_CH01/06/11					
Frequency (MHz)	Conducted Power (dBm)	Conducted Power (W)	Max. Limit (dBm)	Max. Limit (W)	Result
2412	13.31	0.02	30.00	1.00	Complies
2437	19.12	0.08	30.00	1.00	Complies
2462	13.24	0.02	30.00	1.00	Complies

Test Mode :TX G Mode_CH01/06/11					
Frequency (MHz)	Conducted Power (dBm)	Conducted Power (W)	Max. Limit (dBm)	Max. Limit (W)	Result
2412	12.89	0.02	30.00	1.00	Complies
2437	18.74	0.07	30.00	1.00	Complies
2462	13.02	0.02	30.00	1.00	Complies

Test Mode :TX N20 Mode_CH01/06/11					
Frequency (MHz)	Conducted Power (dBm)	Conducted Power (W)	Max. Limit (dBm)	Max. Limit (W)	Result
2412	12.78	0.02	30.00	1.00	Complies
2437	18.81	0.08	30.00	1.00	Complies
2462	12.89	0.02	30.00	1.00	Complies

**ATTACHMENT G - ANTENNA CONDUCTED SPURIOUS EMISSION**

Test Mode : TX B Mode

**TX B mode CH01**

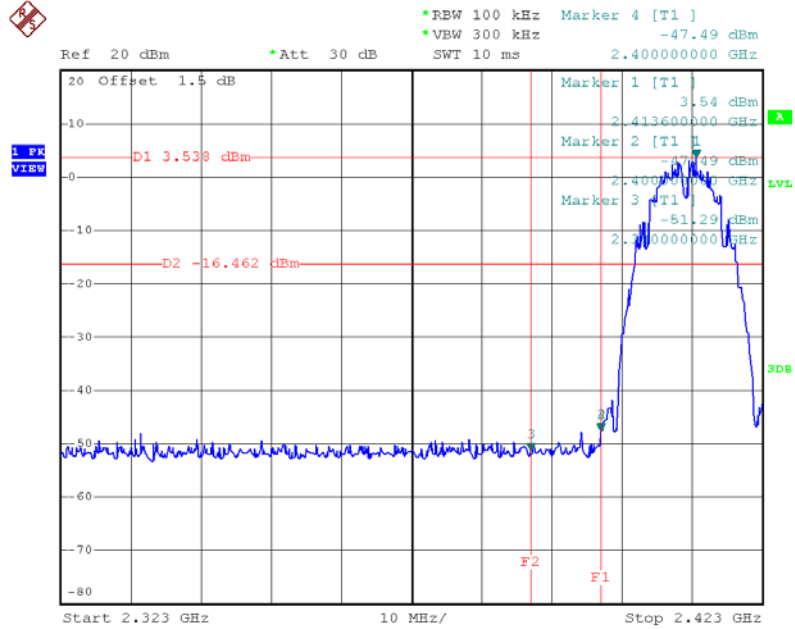

Date: 9.MAY.2017 19:52:16

**TX B mode CH11**

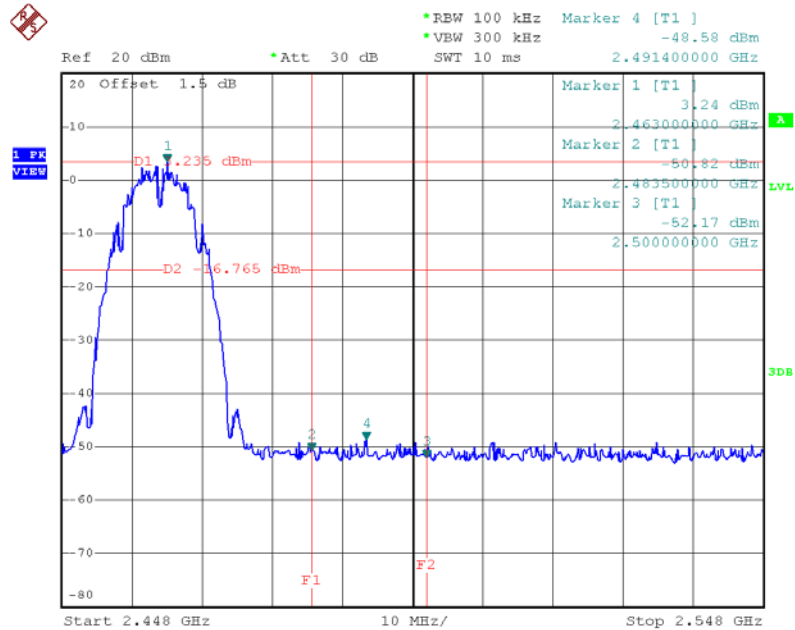

Date: 9.MAY.2017 19:56:06

**TX B mode CH01 (10 Harmonic of the frequency)**

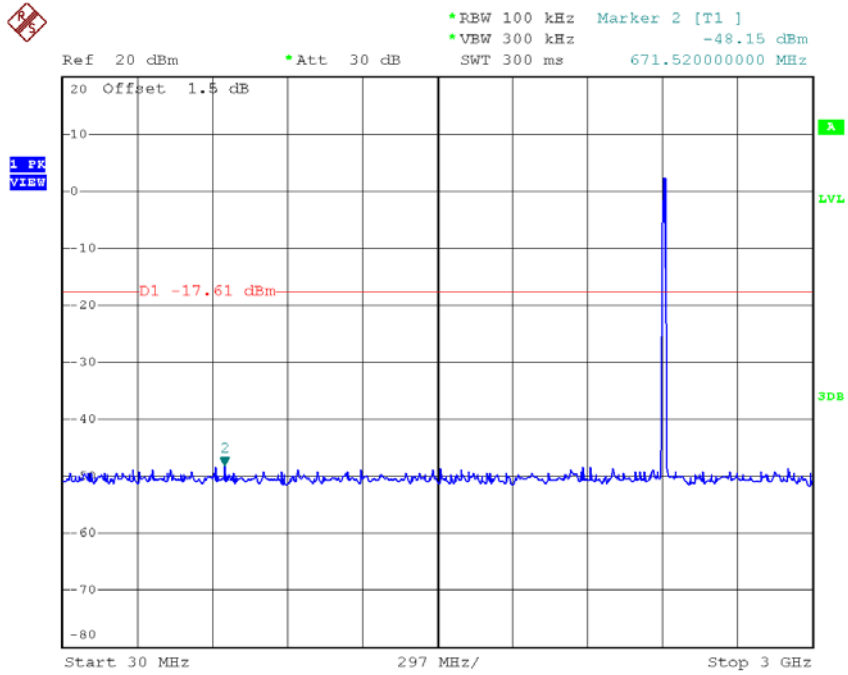

Date: 9.MAY.2017 19:51:52

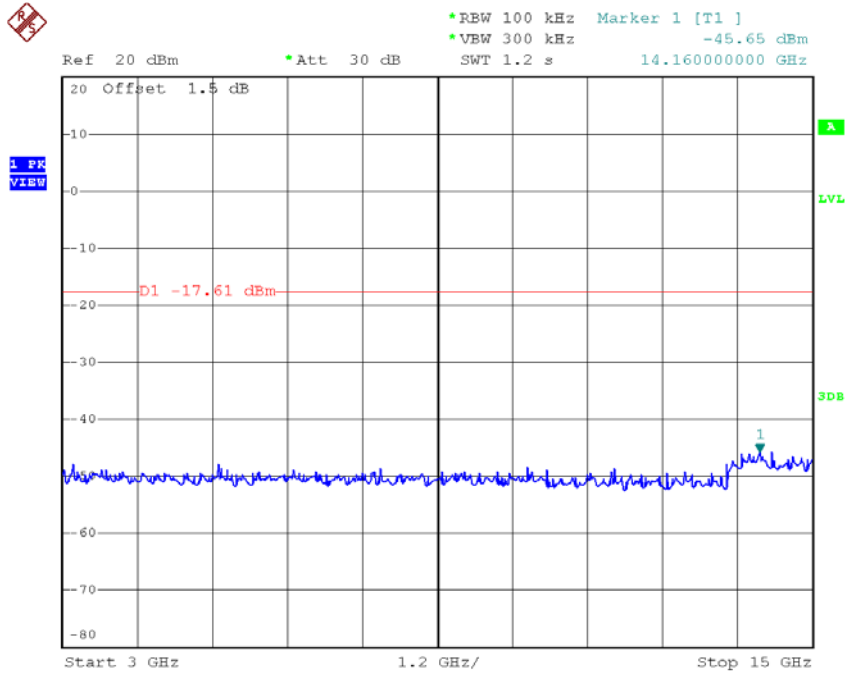

Date: 9.MAY.2017 19:52:00

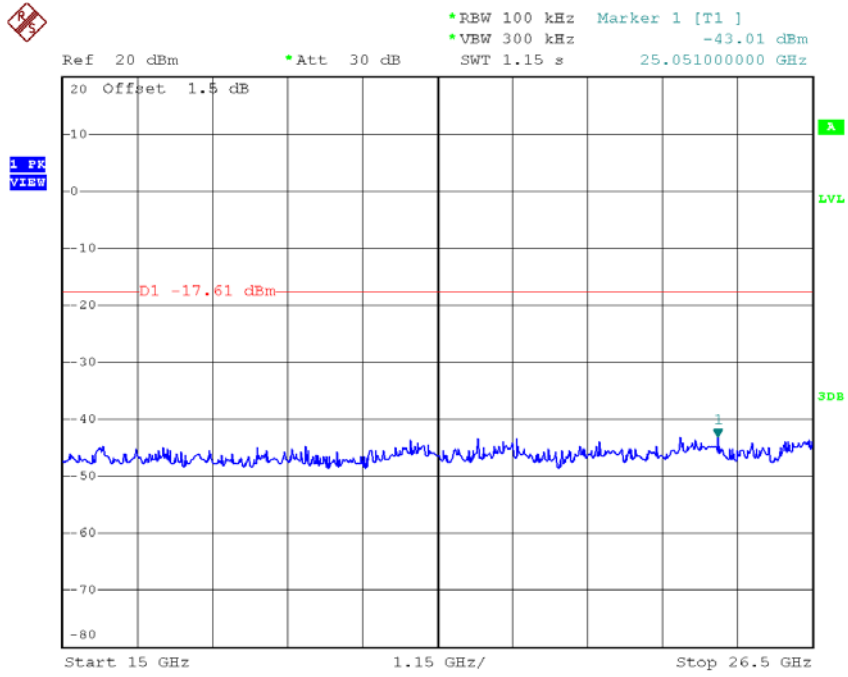

Date: 9.MAY.2017 19:52:09

**TX B mode CH06 (10 Harmonic of the frequency)**

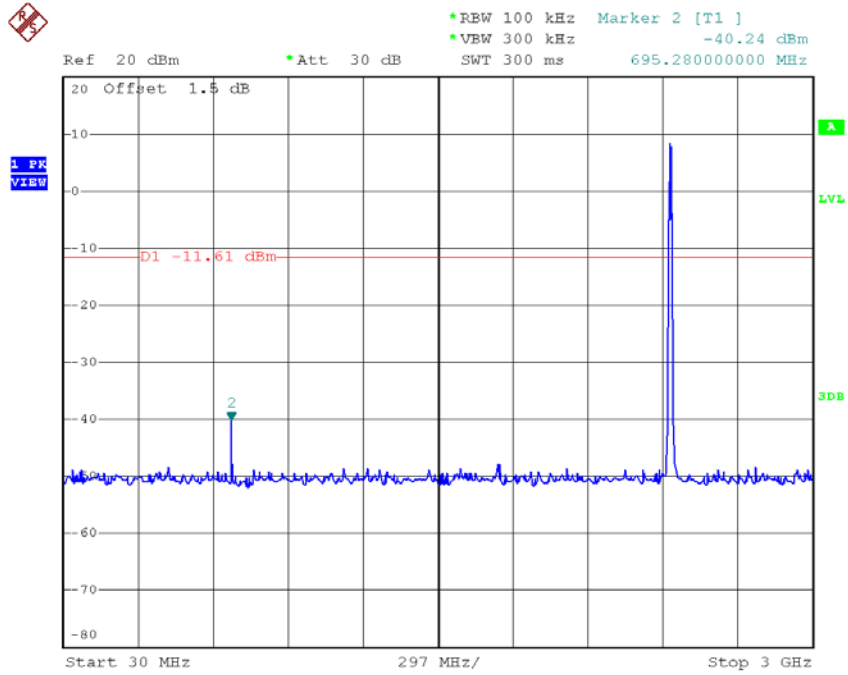

Date: 9.MAY.2017 19:54:09



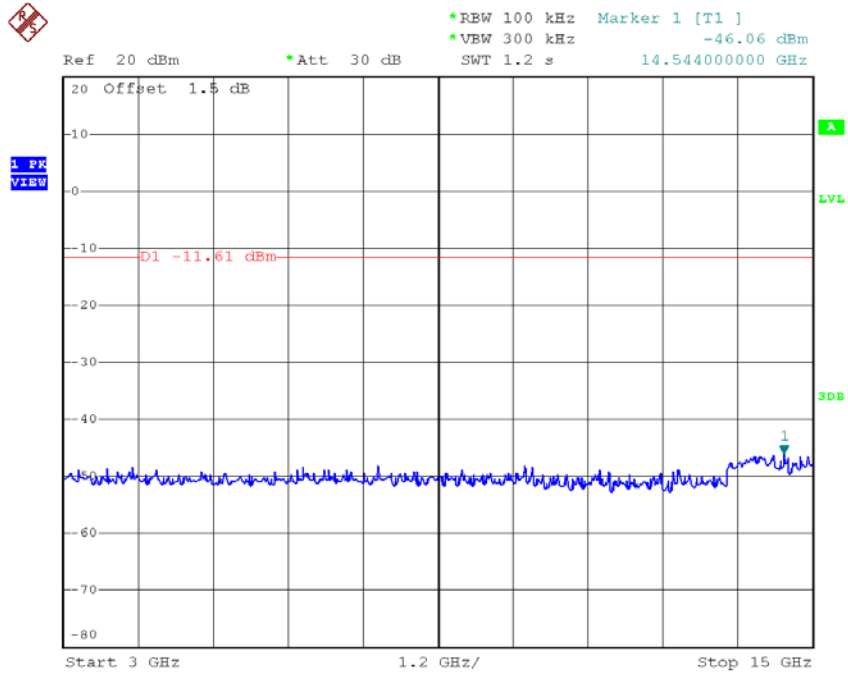

Date: 9.MAY.2017 19:54:17

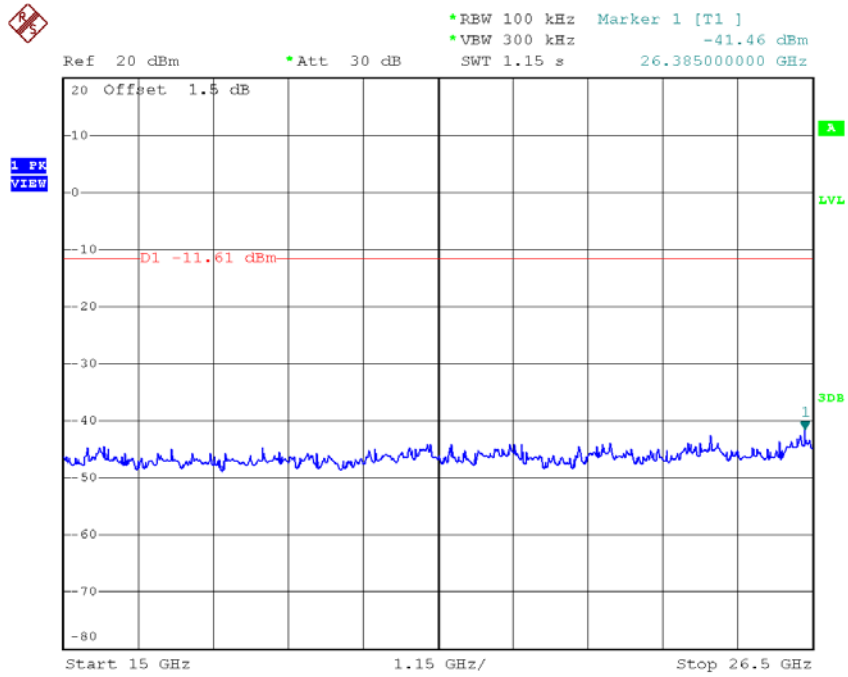

Date: 9.MAY.2017 19:54:26

**TX B mode CH11 (10 Harmonic of the frequency)**

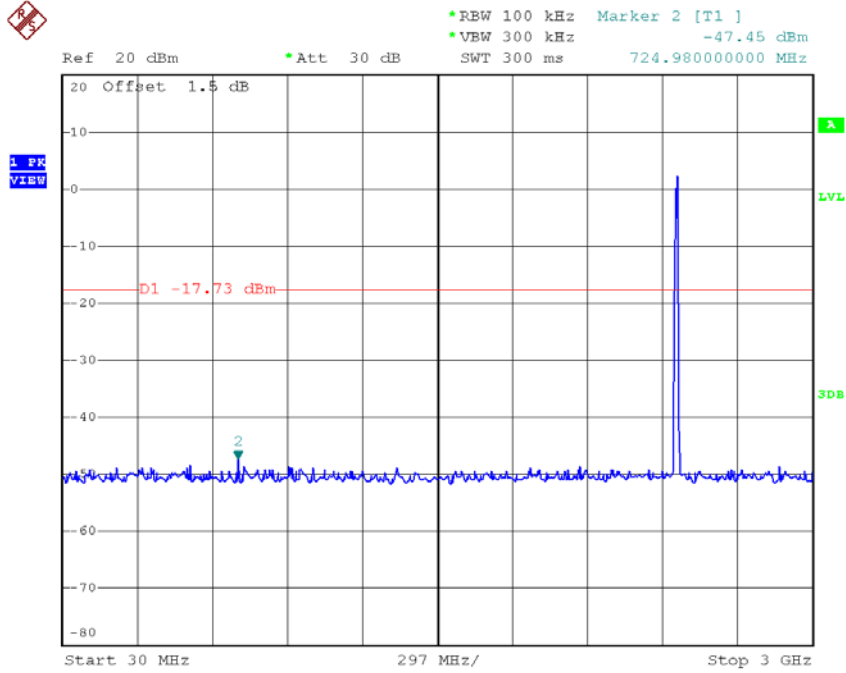

Date: 9.MAY.2017 19:55:41

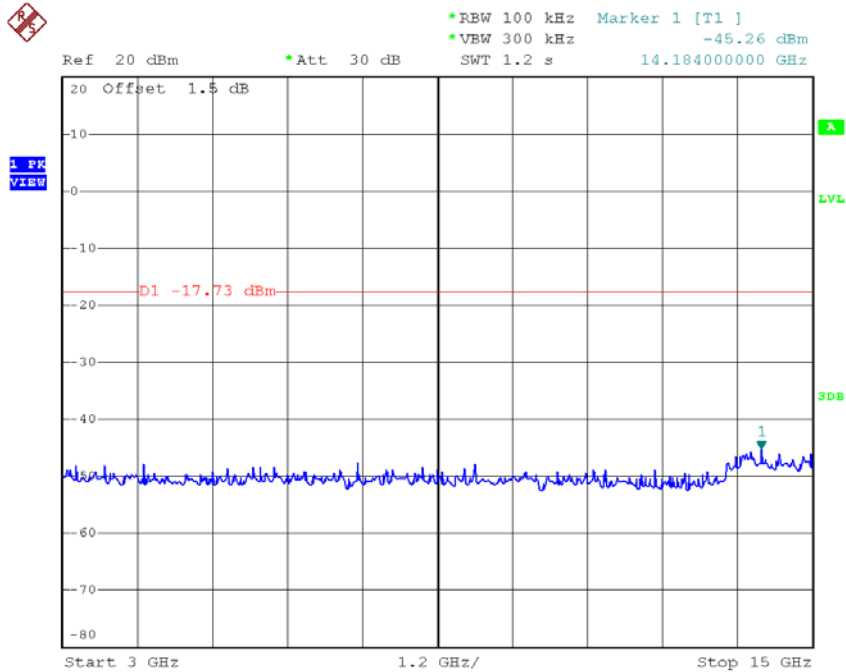

Date: 9.MAY.2017 19:55:49

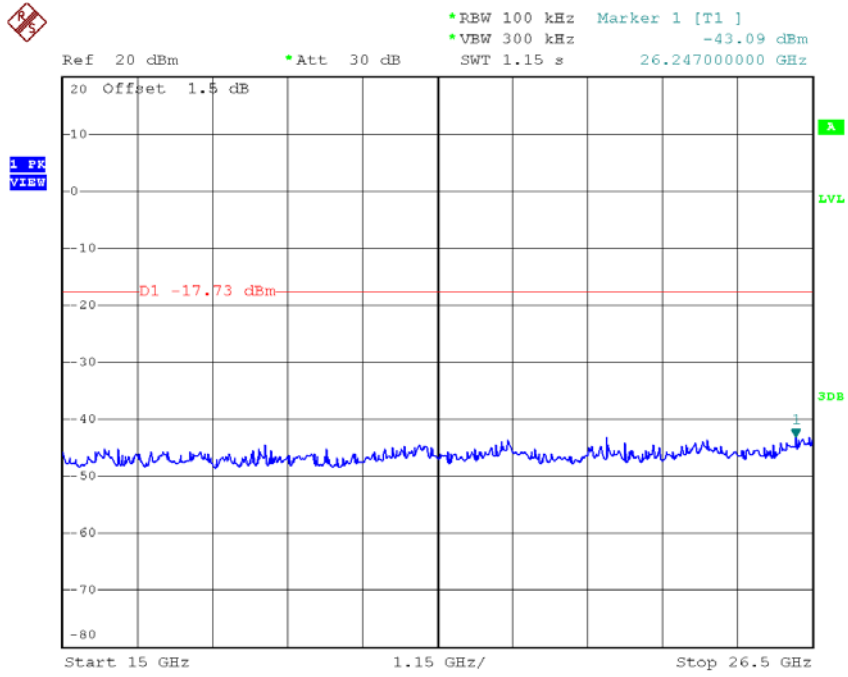

Date: 9.MAY.2017 19:55:58

Test Mode : TX G Mode

**TX G mode CH01**

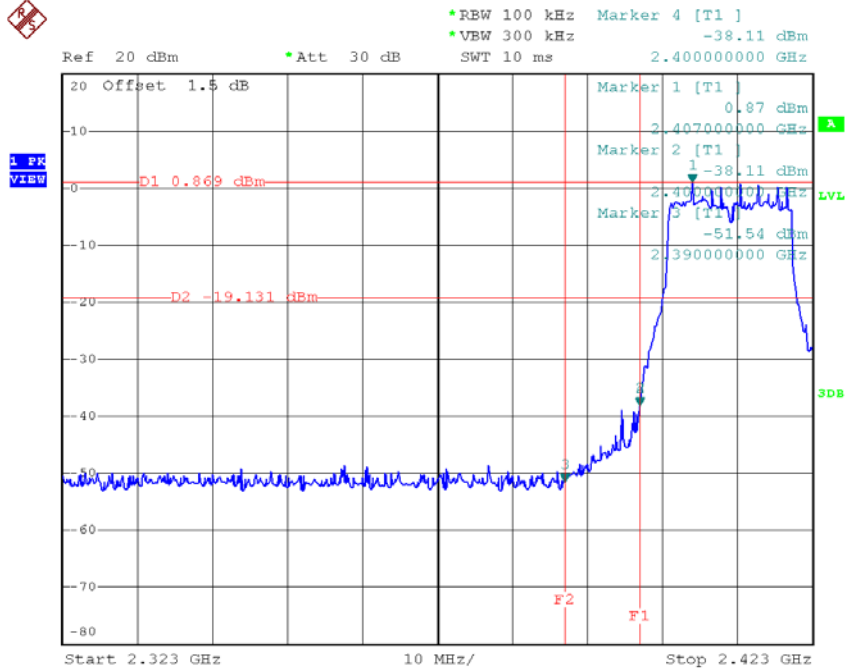

Date: 9.MAY.2017 19:57:37

**TX G mode CH11**

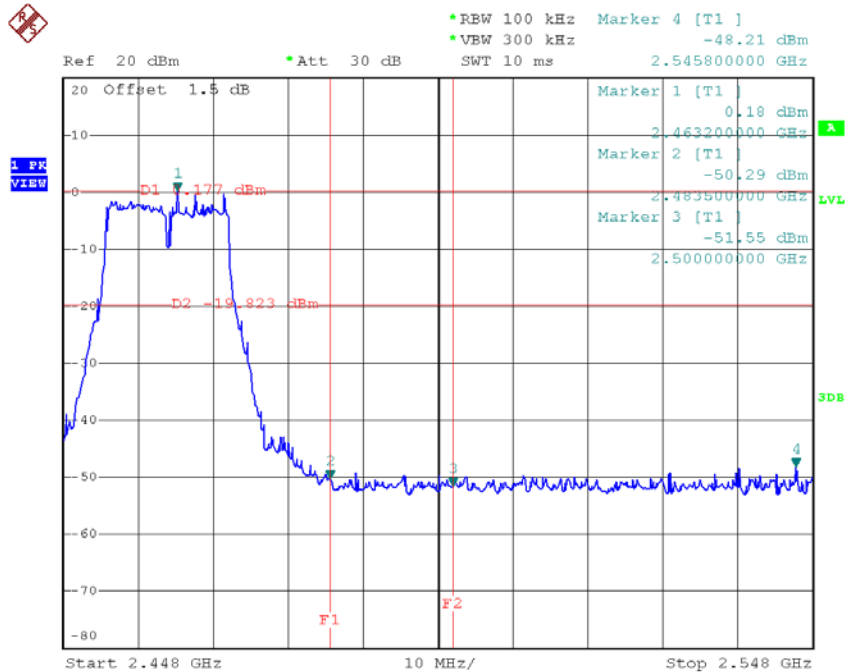

Date: 9.MAY.2017 20:01:03

### TX G mode CH01 (10 Harmonic of the frequency)

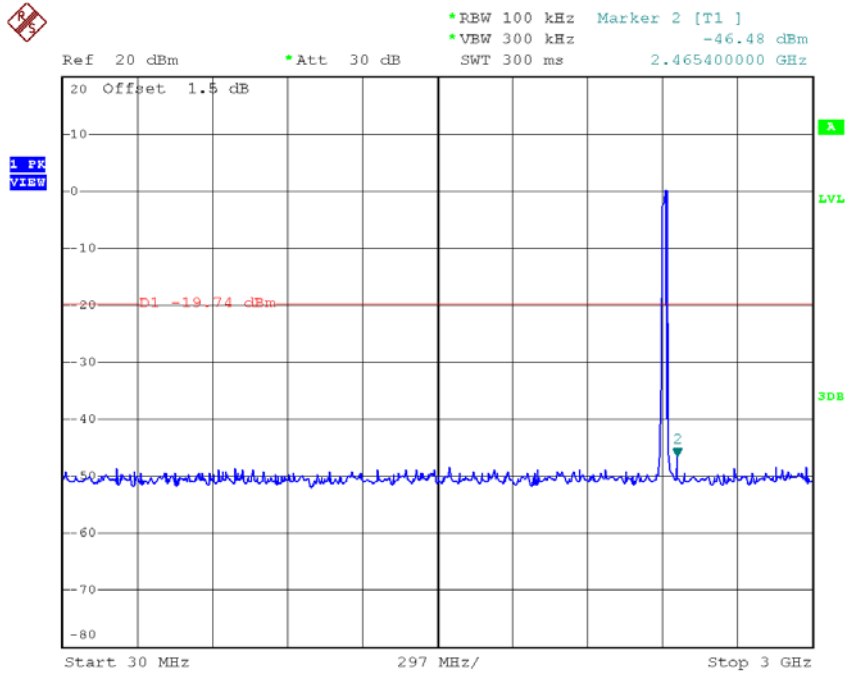

Date: 9.MAY.2017 19:57:12

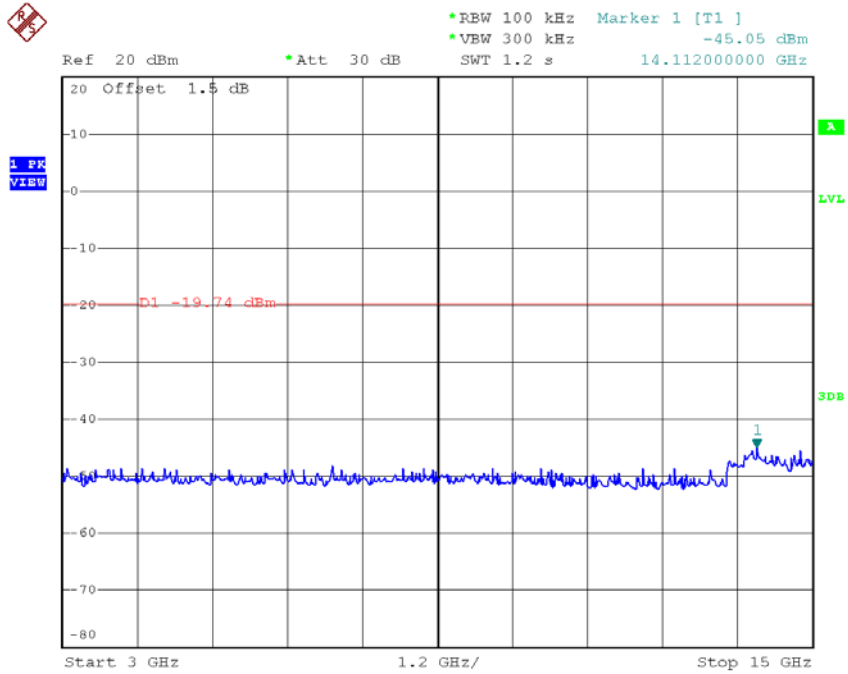

Date: 9.MAY.2017 19:57:21

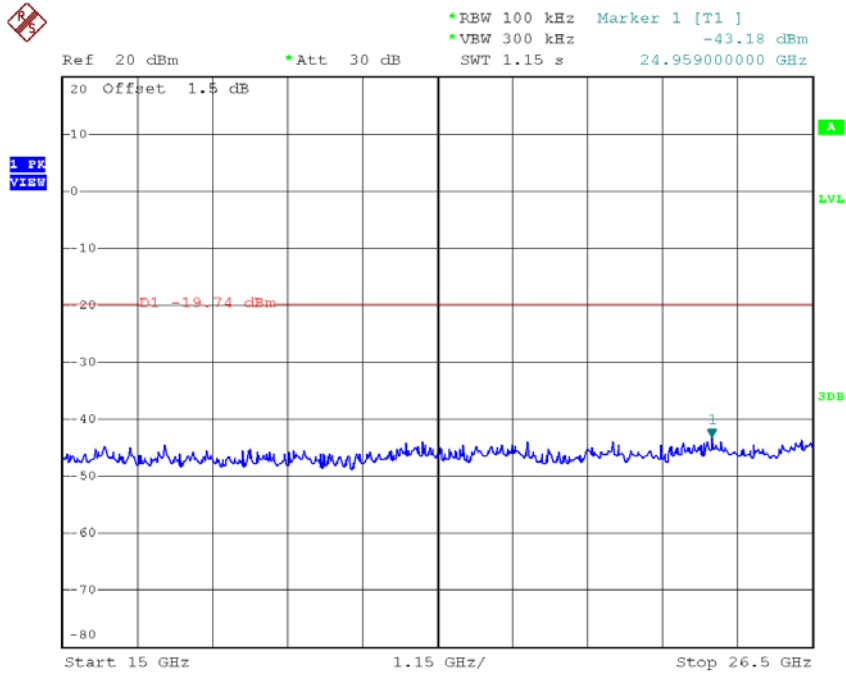

Date: 9.MAY.2017 19:57:29

**TX G mode CH06 (10 Harmonic of the frequency)**

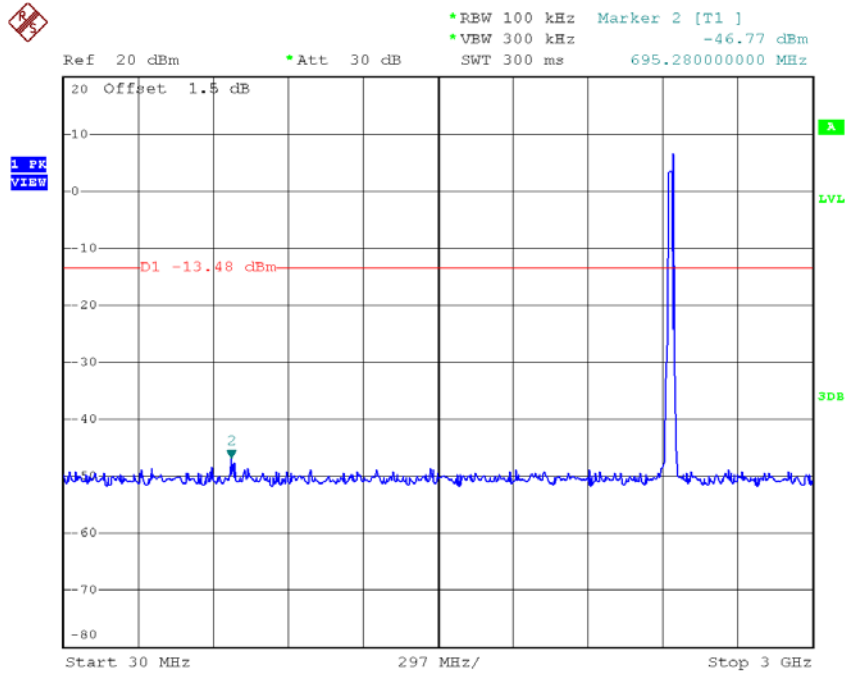

Date: 9.MAY.2017 19:58:57

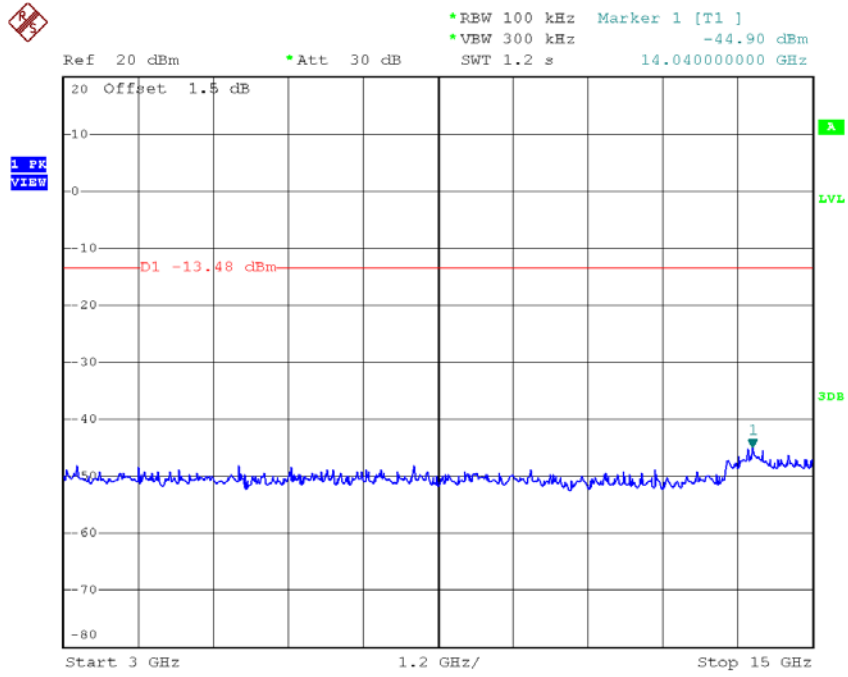

Date: 9.MAY.2017 19:59:05

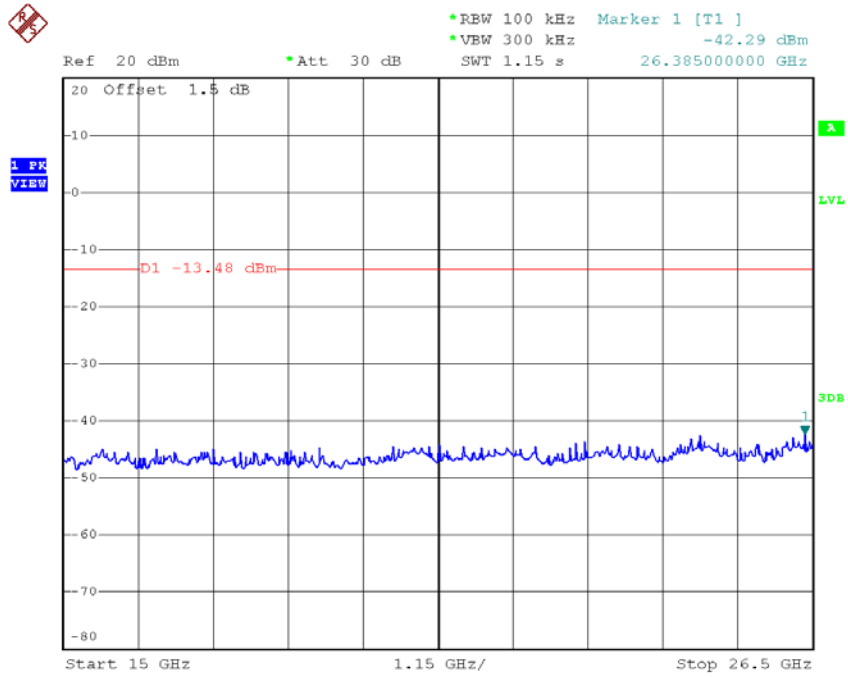

Date: 9.MAY.2017 19:59:14

### TX G mode CH11 (10 Harmonic of the frequency)

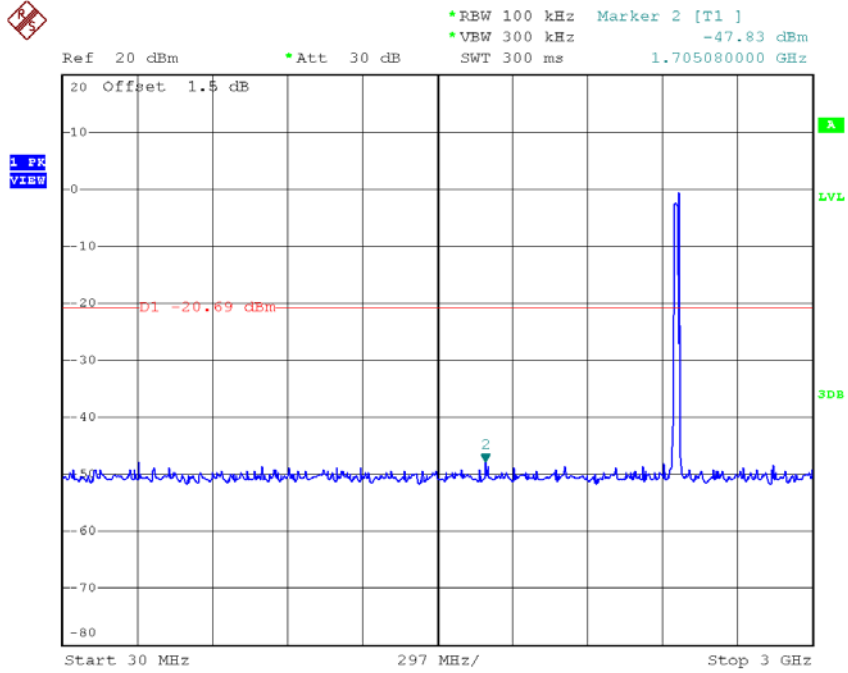

Date: 9.MAY.2017 20:00:38

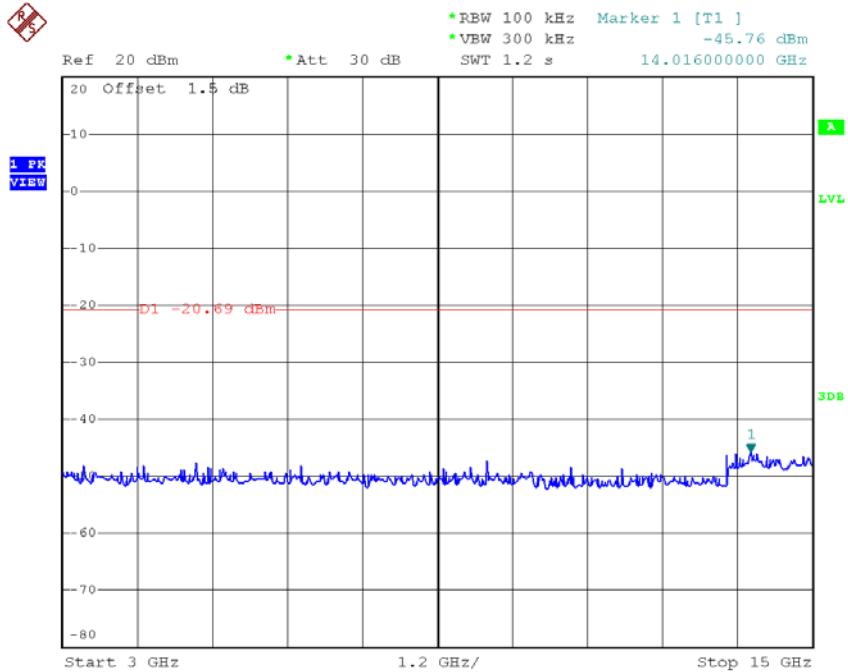

Date: 9.MAY.2017 20:00:47



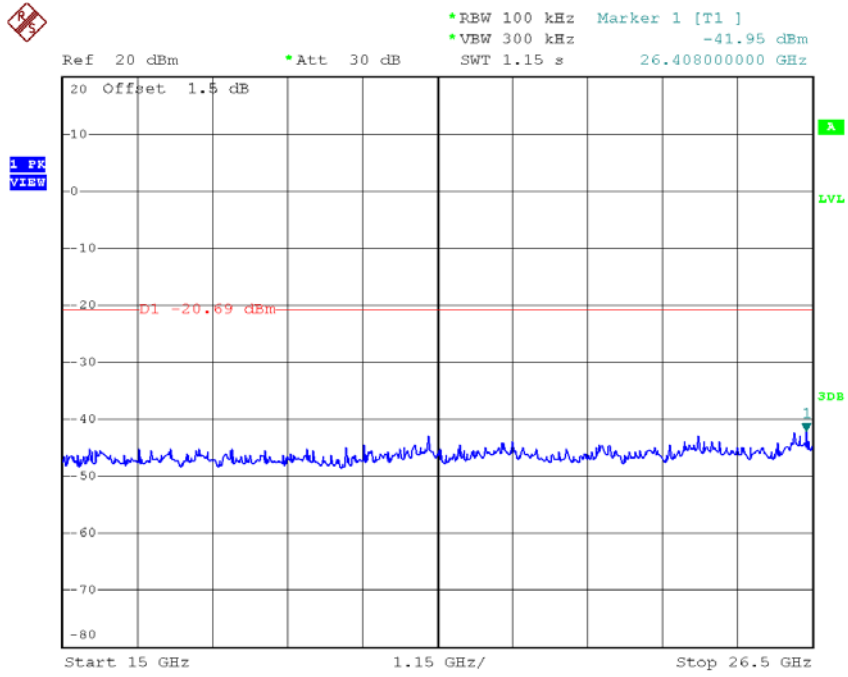

Date: 9.MAY.2017 20:00:55

**Test Mode : TX N-20M Mode**

**TX HT20 mode CH01**

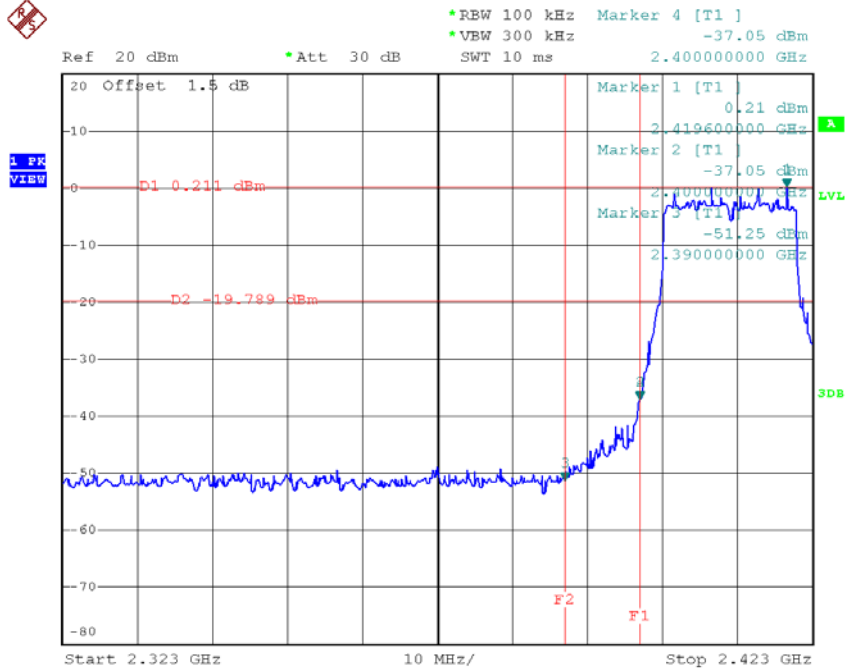

Date: 9.MAY.2017 20:02:21

**TX HT20 mode CH11**

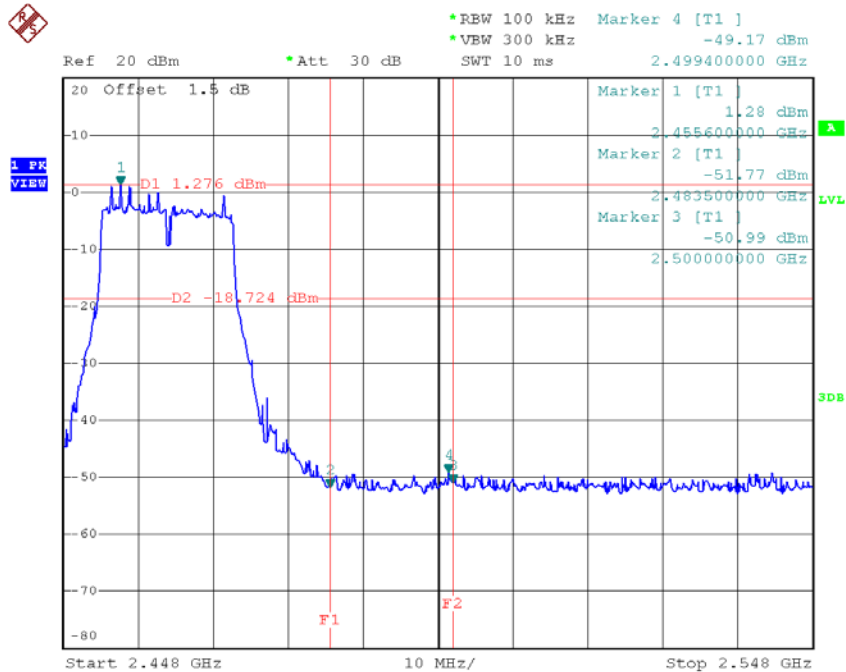

Date: 9.MAY.2017 20:04:54

**TX HT20 mode CH01 (10 Harmonic of the frequency)**

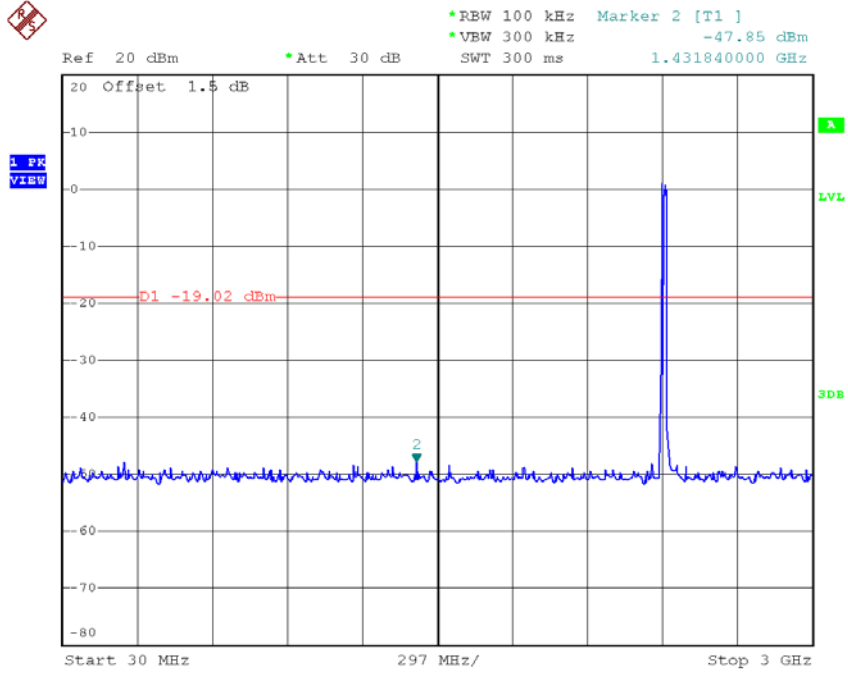

Date: 9.MAY.2017 20:01:57

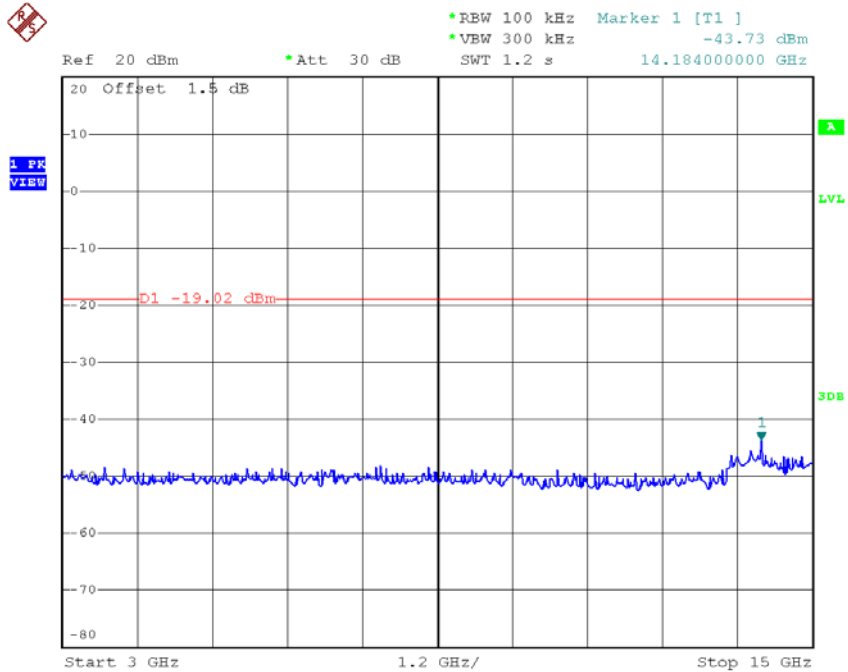

Date: 9.MAY.2017 20:02:05

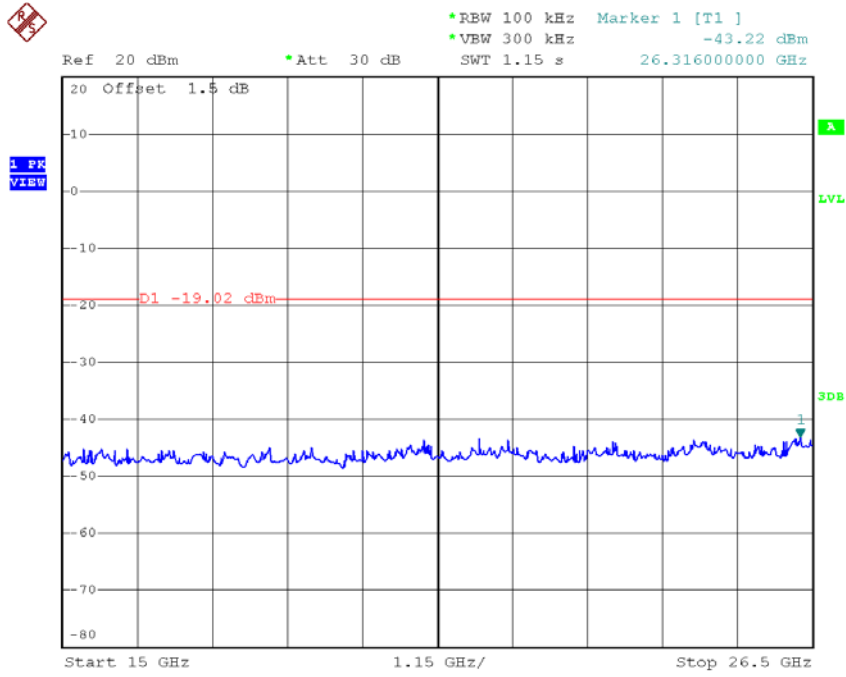

Date: 9.MAY.2017 20:02:14

### TX HT20 mode CH06 (10 Harmonic of the frequency)

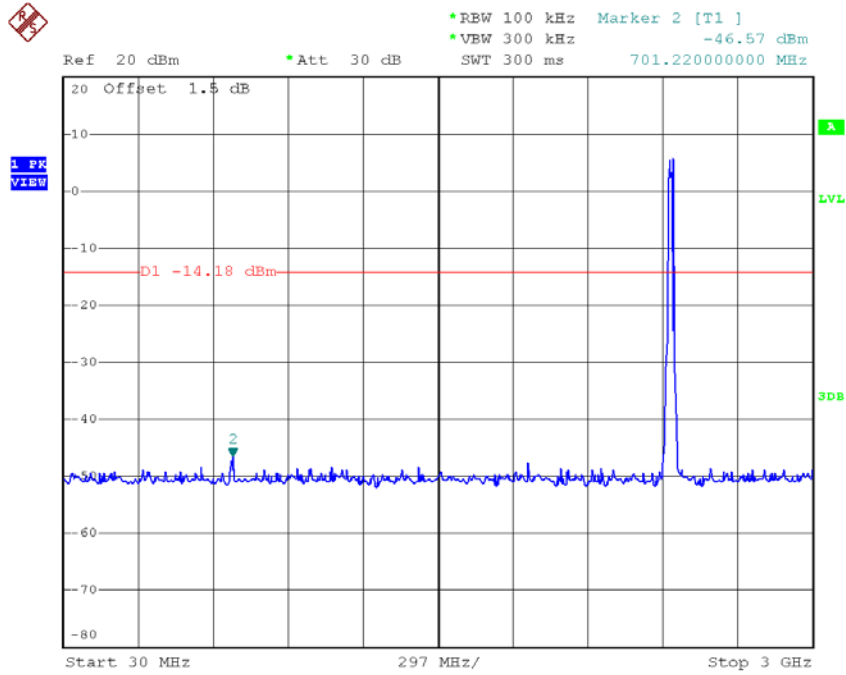

Date: 9.MAY.2017 20:03:18

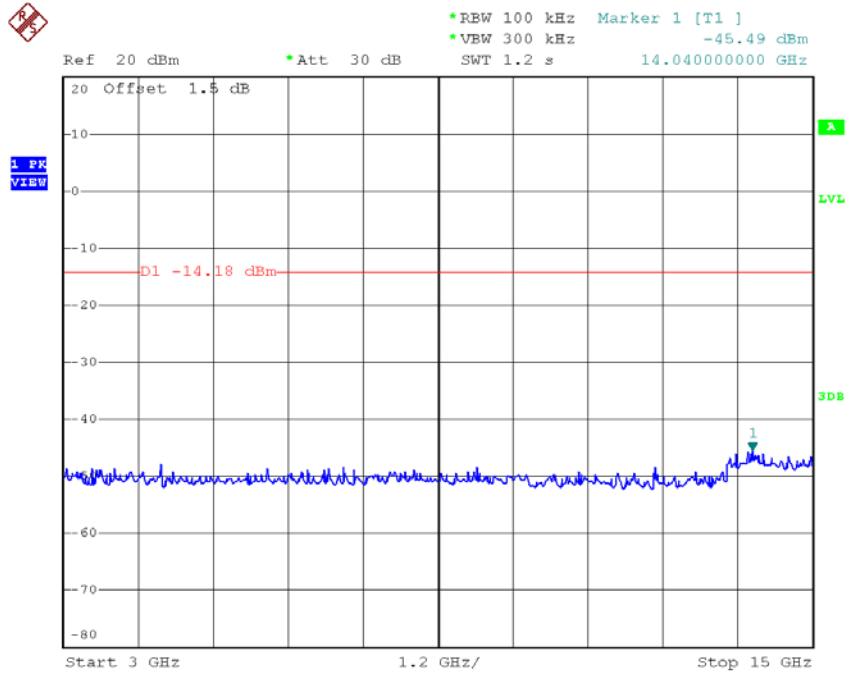

Date: 9.MAY.2017 20:03:26

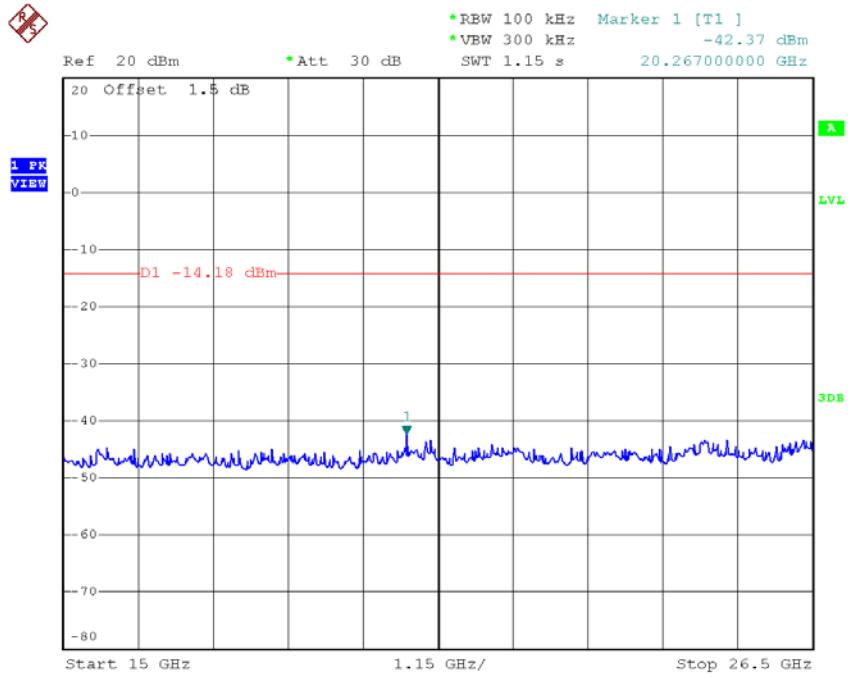

Date: 9.MAY.2017 20:03:35

**TX HT20 mode CH11 (10 Harmonic of the frequency)**

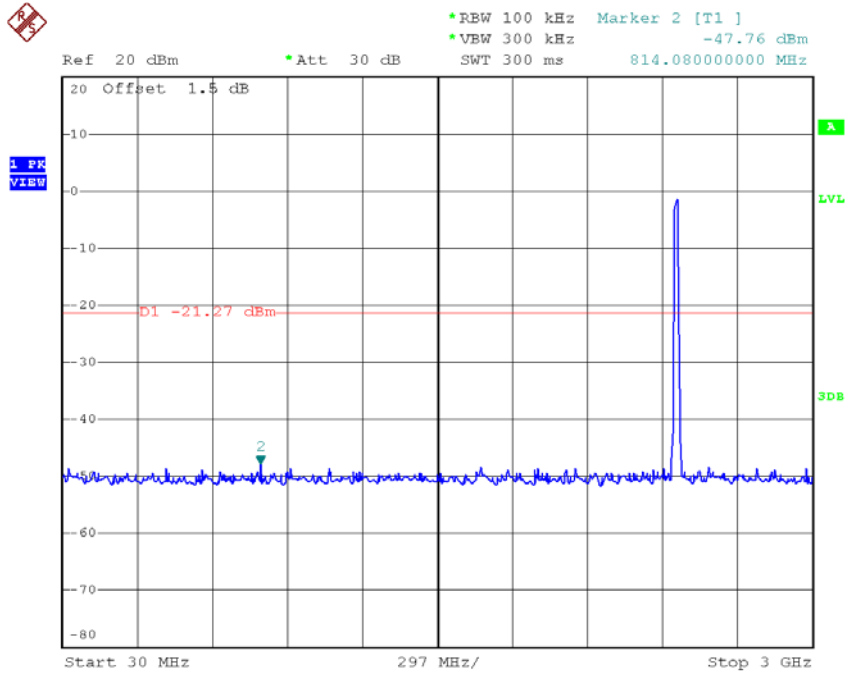

Date: 9.MAY.2017 20:04:29

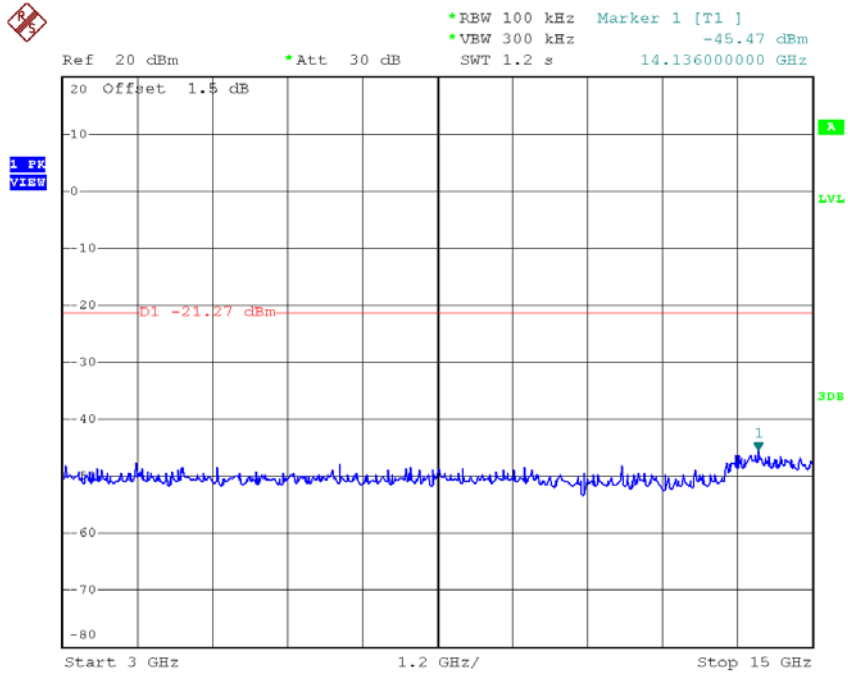

Date: 9.MAY.2017 20:04:38



\*REW 100 kHz Marker 1 [T1 ]  
\*VBW 300 kHz -42.60 dBm  
SWT 1.15 s 26.431000000 GHz

Ref 20 dBm \*Att 30 dB

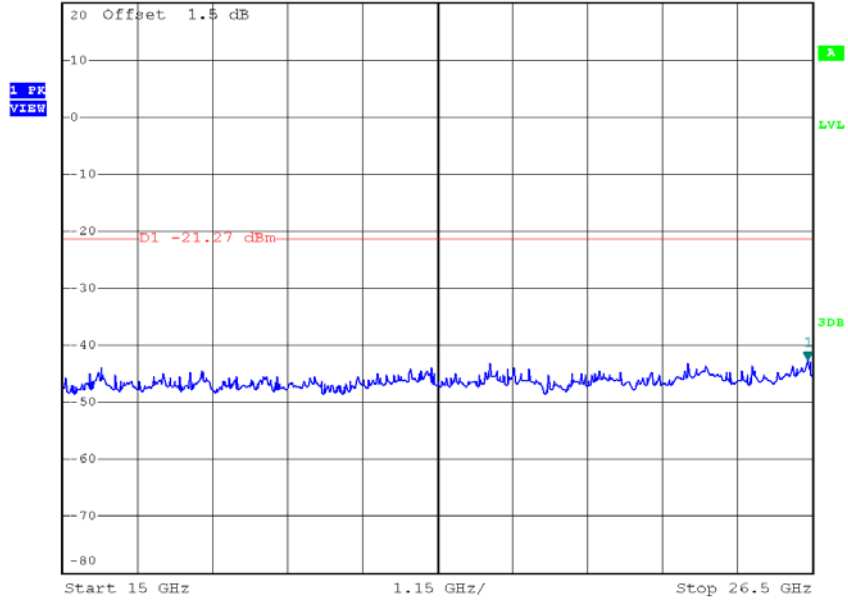

Date: 9.MAY.2017 20:04:46

## ATTACHMENT H - POWER SPECTRAL DENSITY



Test Mode :TX B Mode\_CH01/06/11

Frequency (MHz)	Power Density (dBm/3kHz)	Power Density (mW/3kHz)	Max. Limit (dBm/3kHz)	Result
2412	-9.82	0.1042	8.00	Complies
2437	-4.39	0.3639	8.00	Complies
2462	-10.51	0.0889	8.00	Complies

TX CH01

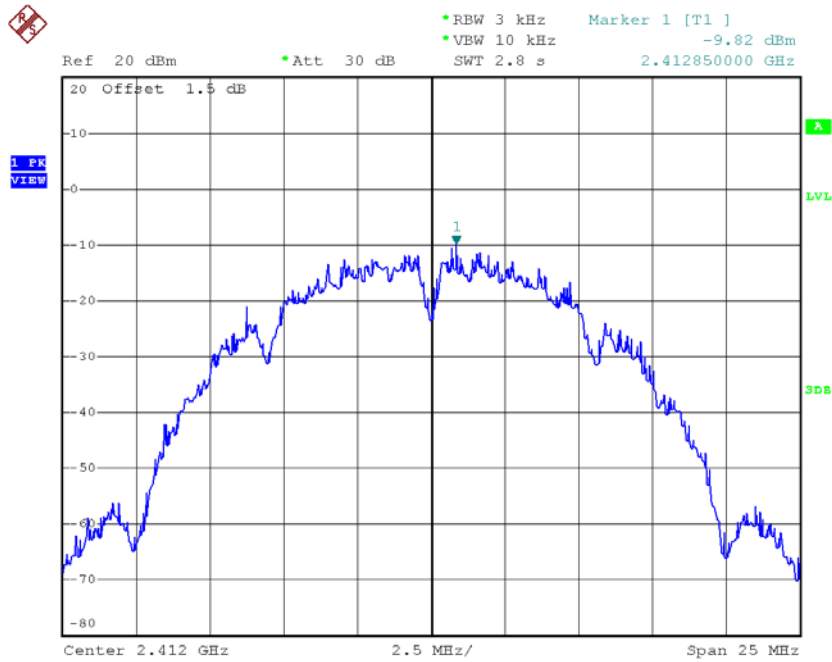

Date: 9.MAY.2017 19:52:26

### TX CH06

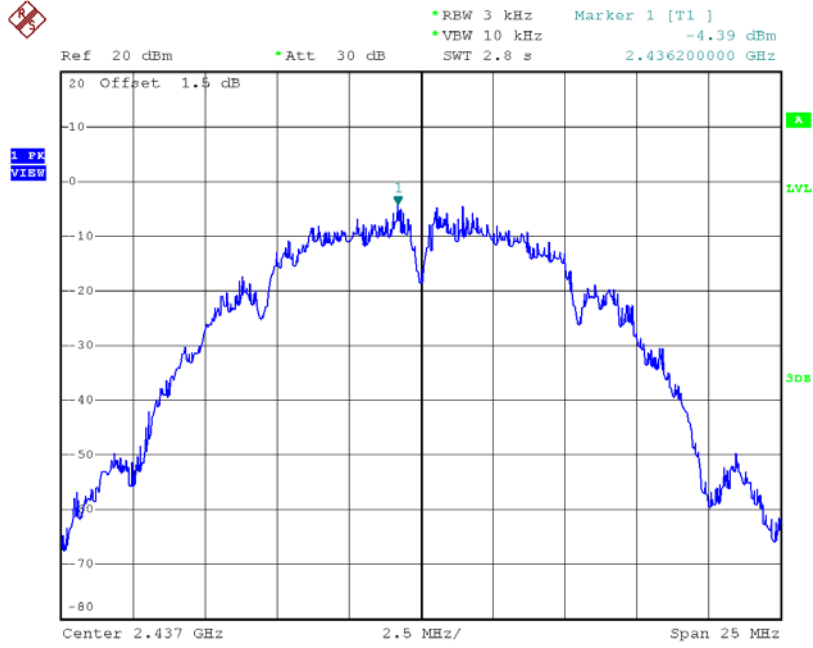

Date: 9.MAY.2017 19:54:35

### TX CH11

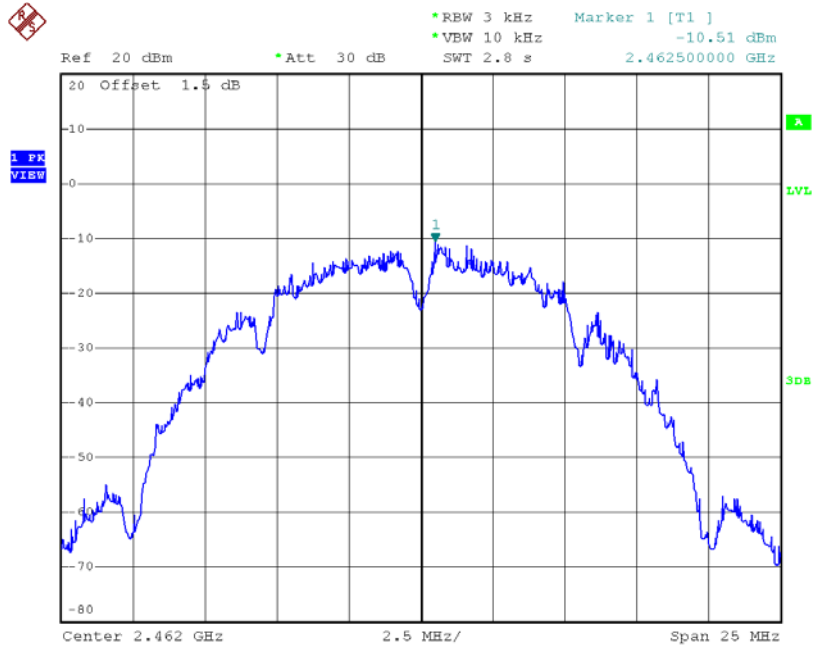

Date: 9.MAY.2017 19:56:15

**Test Mode :TX G Mode\_CH01/06/11**

Frequency (MHz)	Power Density (dBm/3kHz)	Power Density (mW/3kHz)	Max. Limit (dBm/3kHz)	Result
2412	-12.47	0.0566	8.00	Complies
2437	-7.52	0.1770	8.00	Complies
2462	-13.10	0.0490	8.00	Complies

**TX CH01**

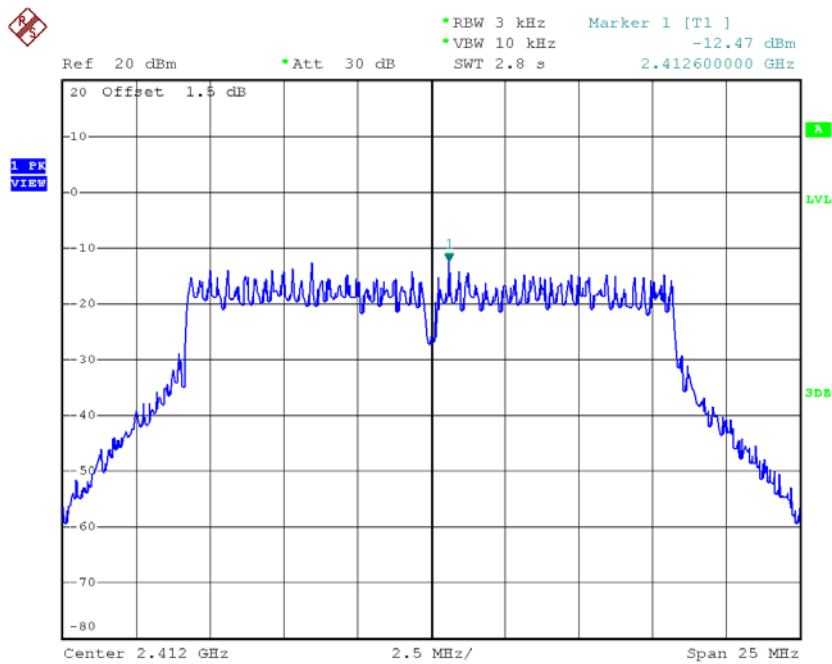

Date: 9.MAY.2017 19:57:46

### TX CH06

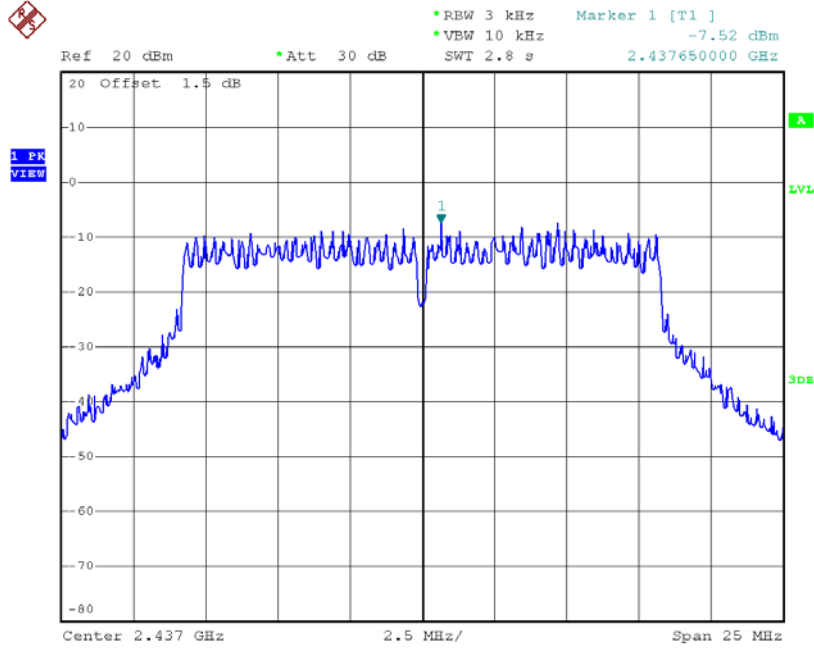

Date: 9.MAY.2017 19:59:23

### TX CH11

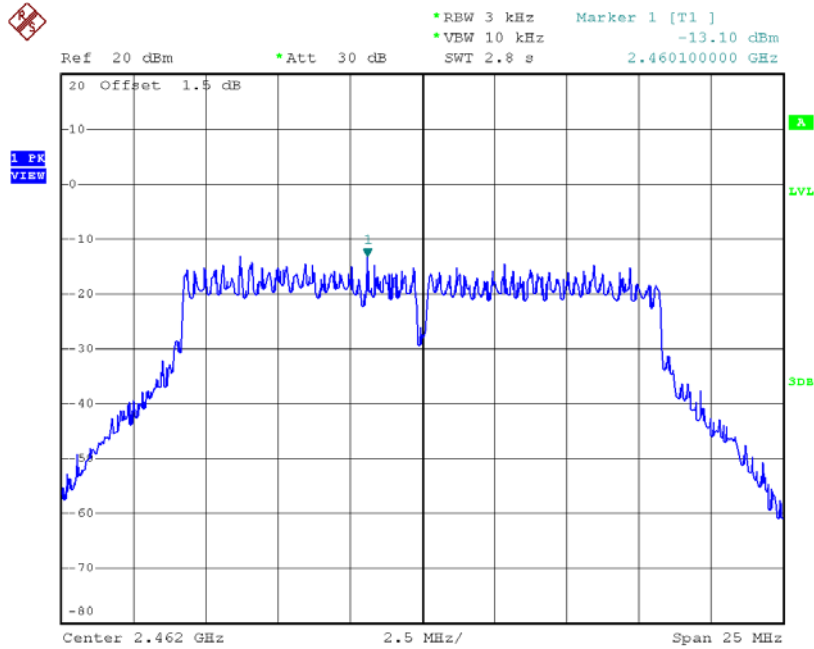

Date: 9.MAY.2017 20:01:12

**Test Mode : TX N-20M Mode\_CH01/06/11**

Frequency (MHz)	Power Density (dBm/3kHz)	Power Density (mW/3kHz)	Max. Limit (dBm/3kHz)	Result
2412	-13.68	0.0429	8.00	Complies
2437	-7.30	0.1862	8.00	Complies
2462	-14.19	0.0381	8.00	Complies

**TX CH01**

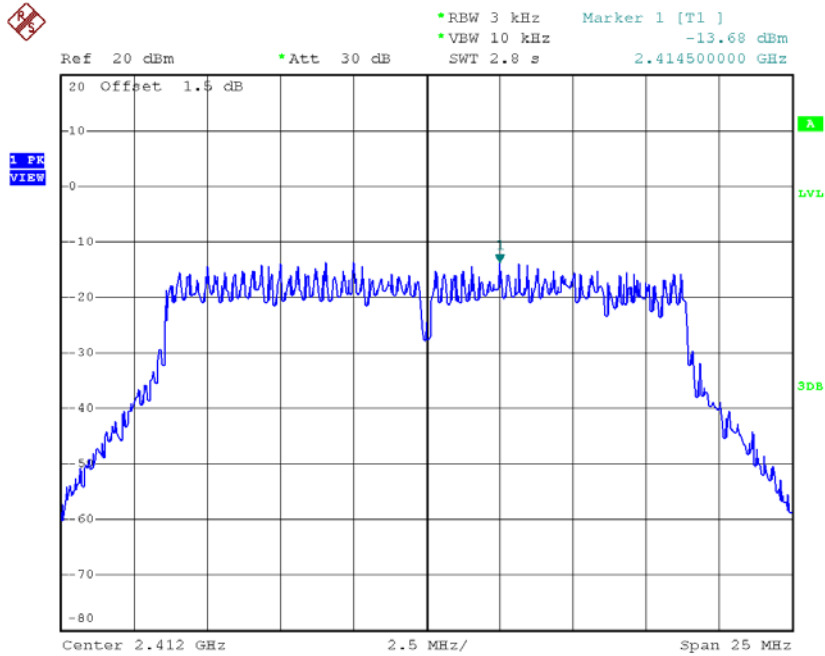

Date: 9.MAY.2017 20:02:30

### TX CH06

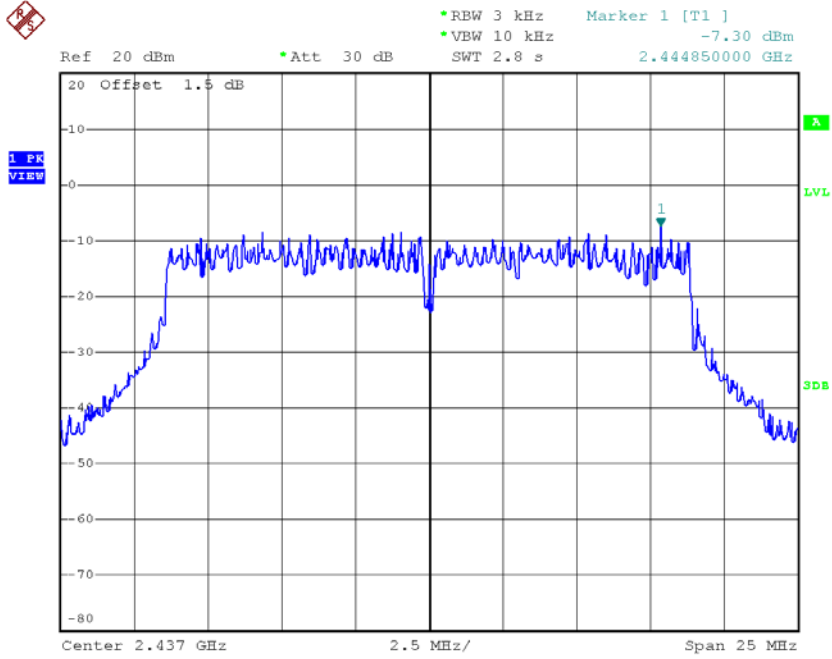

Date: 9.MAY.2017 20:03:44

### TX CH11

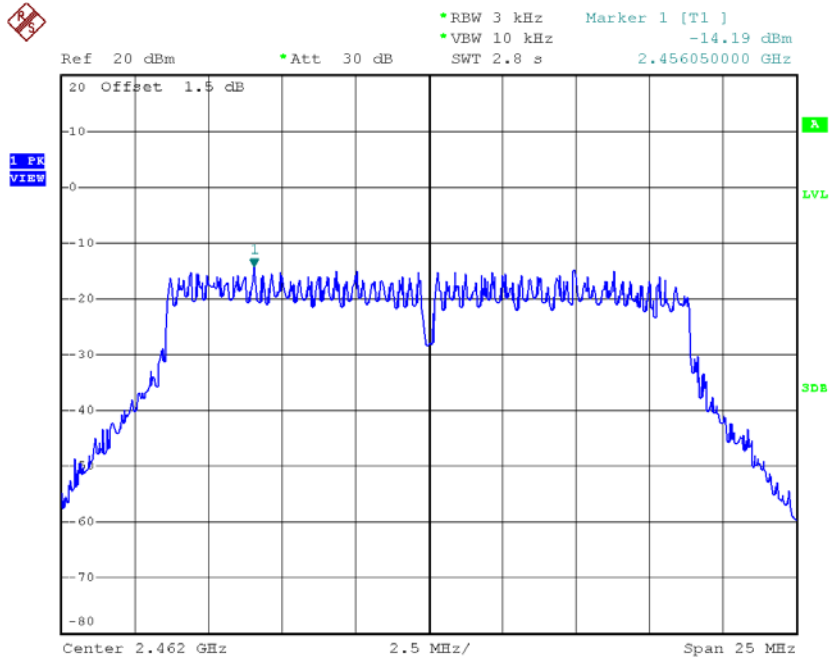

Date: 9.MAY.2017 20:05:03