

FCC Radio Test Report

FCC ID: QISAGS-L03

This report concerns (check one): Original Grant Class II Change

Project No. : 1705C003
Equipment : Huawei MediaPad T3 10 (MediaPad T3 10 for short)
Model Name : AGS-L03
Applicant : Huawei Technologies Co., Ltd.
Address : Administration Building, Headquarters of Huawei Technologies Co., Ltd., Bantian, Longgang District, Shenzhen, 518129, P.R.C

Date of Receipt : May 02, 2017
Date of Test : May 02, 2017 ~ May 19, 2017
Issued Date : May 22, 2017
Tested by : BTL Inc.

Technical Engineer :

shawn xiao
(Shawn Xiao)

Authorized Signatory :

Steven Lu
(Steven Lu)

B T L I N C .

No.3, Jinshagang 1st Road, Shixia, Dalang Town, Dongguan, Guangdong, China.

TEL: +86-769-8318-3000 FAX: +86-769-8319-6000

Declaration

BTL represents to the client that testing is done in accordance with standard procedures as applicable and that test instruments used has been calibrated with standards traceable to international standard(s) and/or national standard(s).

BTL's reports apply only to the specific samples tested under conditions. It is manufacture's responsibility to ensure that additional production units of this model are manufactured with the identical electrical and mechanical components. **BTL** shall have no liability for any declarations, inferences or generalizations drawn by the client or others from **BTL** issued reports.

BTL's report must not be used by the client to claim product certification, approval, or endorsement by NVLAP, NIST, or any agency of the Federal Government.

This report is the confidential property of the client. As a mutual protection to the clients, the public and **BTL-self**, extracts from the test report shall not be reproduced except in full with **BTL's** authorized written approval.

BTL's laboratory quality assurance procedures are in compliance with the **ISO Guide17025** requirements, and accredited by the conformity assessment authorities listed in this test report.

Limitation

For the use of the authority's logo is limited unless the Test Standard(s)/Scope(s)/Item(s) mentioned in this test report is (are) included in the conformity assessment authorities acceptance respective.

Table of Contents**Page**

REPORT ISSUED HISTORY	5
1 . CERTIFICATION	6
2 . SUMMARY OF TEST RESULTS	7
2.1 TEST FACILITY	8
2.2 MEASUREMENT UNCERTAINTY	8
3 . GENERAL INFORMATION	9
3.1 GENERAL DESCRIPTION OF EUT	9
3.2 DESCRIPTION OF TEST MODES AND TEST CONDITION	12
3.3 BLOCKDIAGRAMSHOWINGTHECONFIGURATIONOFSYSTEMTESTED	17
3.4 DESCRIPTION OF SUPPORT UNITS	17
4 . TEST RESULT	18
4.1 OUTPUT POWER MEASUREMENT	18
4.1.1 LIMIT	18
4.1.2 TEST PROCEDURE	18
4.1.3 TESTSETUP LAYOUT	18
4.1.4 TEST DEVIATION	18
4.1.5 TEST RESULTS	18
4.2 OCCUPIED BANDWIDTH MEASUREMENT	19
4.2.1 TEST PROCEDURE	19
4.2.2 TEST SETUP LAYOUT	19
4.2.3 TEST DEVIATION	19
4.2.4 TEST RESULTS	19
4.3 CONDUCTED EMISSIONS MEASUREMENT	20
4.3.1 LIMIT	20
4.3.2 TEST PROCEDURES	20
4.3.3 TESTSETUP LAYOUT	20
4.3.4 TESTDEVIATION	20
4.3.5 TEST RESULTS	20
4.4 RADIATED EMISSIONS MEASUREMENT	21
4.4.1 LIMIT	21
4.4.2 TEST PROCEDURES	21
4.4.3 TESTSETUP LAYOUT	21
4.4.4 TESTDEVIATION	21
4.4.5 TEST RESULTS	21
4.5 BAND EDGE MEASUREMENT	22
4.5.1 LIMIT	22
4.5.2 TEST PROCEDURES	22

Table of Contents	Page
4.5.3 TESTSETUP LAYOUT	22
4.5.4 TESTDEVIATION	22
4.5.5 TEST RESULTS	22
4.6 PEAK TO AVERAGE RATIO MEASUREMENT	23
4.6.1 LIMIT	23
4.6.2 TEST PROCEDURES	23
4.6.3 TESTSETUP LAYOUT	23
4.6.4 TESTDEVIATION	23
4.6.5 TEST RESULTS	23
4.7 FREQUENCY STABILITY MEASUREMENT	24
4.7.1 LIMIT	24
4.7.2 TEST PROCEDURES	24
4.7.3 TESTSETUP LAYOUT	24
4.7.4 TESTDEVIATION	24
4.7.5 TEST RESULTS	24
5. LIST OF MEASUREMENT EQUIPMENTS	25
ATTACHMENT A - OUTPUT POWER	27
ATTACHMENT B - OCCUPIED BANDWIDTH	38
ATTACHMENT C - CONDUCTED EMISSIONS	68
ATTACHMENT D - RADIATED EMISSION	85
ATTACHMENT E - BAND EDGE	170
ATTACHMENT F - PEAK TO AVERAGE RATIO	185
ATTACHMENT G - FREQUENCY STABILITY	202

REPORT ISSUED HISTORY

Issued No.	Description	Issued Date
BTL-FCCP-7-1705C003	Original Issue.	May 22, 2017

1. CERTIFICATION

Equipment : Huawei MediaPad T3 10 (MediaPad T3 10 for short)
Brand Name : HUAWEI
Model Name : AGS-L03
Applicant : Huawei Technologies Co., Ltd
Manufacturer : Huawei Technologies Co., Ltd
Address : Administration Building, Headquarters of Huawei Technologies Co., Ltd.,
Bantian, Longgang District Shenzhen China
Factory : Huawei Technologies Co., Ltd
Address : Administration Building, Headquarters of Huawei Technologies Co., Ltd.,
Bantian, Longgang District Shenzhen China
Date of Test : May 02, 2017 ~ May 19, 2017
Test Sample : Engineering Sample
Standard(s) : 47 CFR FCC Part 24 Subpart E
47 CFR FCC Part 2
ANSI/TIA-603-D-2010
KDB 971168 D01 Power Meas License Digital Systems v02r02

The above equipment has been tested and found compliance with the requirement of the relative standards by BTL Inc.

The test data, data evaluation, and equipment configuration contained in our test report (Ref No. BTL-FCCP-7-1705C003) were obtained utilizing the test procedures, test instruments, test sites that has been accredited by the Authority of TAF according to the ISO-17025 quality assessment standard and technical standard(s).

Test results included in this report is only for the DCS1900, WCDMA Band 2, LTE Band 2 and Band 25 part.

2. SUMMARY OF TEST RESULTS

Test procedures according to the technical standard(s):

FCC Part 24 Subpart H& Part 2			
Standard(s) Section	Test Item	Judgment	Tested By
2.1046 24.232(c)	Radiated power	PASS	Paul Li
2.1046 24.232(c)	Conducted Output Power	PASS	Paul Li
2.1049 24.238(a)	Occupied Bandwidth	PASS	Paul Li
2.1051 24.238(a)	Conducted Spurious Emissions	PASS	Paul Li
2.1053 24.238(a)	Radiated Spurious Emissions	PASS	Paul Li
24.238(a)	Band Edge Measurements	PASS	Paul Li
24.232(d)	Peak To Average Ratio	PASS	Paul Li
2.1055 24.235	Frequency Stability	PASS	Paul Li

Note:

(1) "N/A" denotes test is not applicable to this device.

2.1 TEST FACILITY

The test facilities used to collect the test data in this report is at the location of No.3, Jinshagang 1st Road, Shixia, Dalang Town, Dongguan, Guangdong, China.
BTL's test firm number for FCC: 319330

2.2 MEASUREMENT UNCERTAINTY

Where relevant, the following measurement uncertainty levels have been estimated for tests performed on the EUT as specified in CISPR 16-4-2. The BTL measurement uncertainty is less than the CISPR 16-4-2 U_{CISPR} requirement.

The reported uncertainty of measurement $y \pm U$, where expanded uncertainty U is based on a standard uncertainty multiplied by a coverage factor of $k=2$, providing a level of confidence of approximately **95%**.

A. Radiated Measurement :

Test Site	Method	Measurement Frequency Range	Ant. H / V	U,(dB)
DG-CB03 (3m)	CISPR	9KHz ~ 30MHz	V	3.79
		9KHz ~ 30MHz	H	3.57
		30MHz ~ 200MHz	V	3.82
		30MHz ~ 200MHz	H	3.78
		200MHz ~ 1,000MHz	V	4.10
		200MHz ~ 1,000MHz	H	4.06

Test Site	Method	Measurement Frequency Range	Ant. H / V	U,(dB)
DG-CB03 (3m)	CISPR	1GHz ~ 18GHz	V	3.12
		1GHz ~ 18GHz	H	3.68

Test Site	Method	Measurement Frequency Range	Ant. H / V	U,(dB)
DG-CB03 (1m)	CISPR	18GHz ~ 40GHz	V	4.15
		18GHz ~ 40GHz	H	4.14

Note: Unless specifically mentioned, the uncertainty of measurement has not been taken into account to declare the compliance or non-compliance to the specification.

3. GENERAL INFORMATION

3.1 GENERAL DESCRIPTION OF EUT

Equipment	Huawei MediaPad T3 10 (MediaPad T3 10 for short)	
Brand Name	HUAWEI	
Model Name	AGS-L03	
Model Difference	N/A	
Modulation Type	GSM/GPRS	GMSK
	EDGE	GMSK, 8PSK
	WCDMA	UP: QPSK DP: QPSK,16QAM,64AQM
	LTE	UP: QPSK,16QAM DP: QPSK,16QAM,64AQM
Operation Frequency	GSM /EDGE/GPRS	1850.2 ~ 1909.8 MHz
	WCDMA Band 2	1852.4 ~ 1907.6 MHz
	LTE 2 (Channel Bandwidth: 1.4MHz)	1850.7 ~ 1909.3 MHz
	LTE 2 (Channel Bandwidth: 3MHz)	1851.5 ~ 1908.5 MHz
	LTE 2 (Channel Bandwidth: 5MHz)	1852.5 ~ 1907.5 MHz
	LTE 2 (Channel Bandwidth: 10MHz)	1855.0 ~ 1905.0 MHz
	LTE 2 (Channel Bandwidth: 15MHz)	1857.5 ~ 1902.5 MHz
	LTE 2 (Channel Bandwidth: 20MHz)	1860.0 ~ 1900.0 MHz
	LTE 25 (Channel Bandwidth: 1.4MHz)	1850.7 ~ 1914.3 MHz
	LTE 25 (Channel Bandwidth: 3MHz)	1851.5 ~ 1913.5 MHz
	LTE 25 (Channel Bandwidth: 5MHz)	1852.5 ~ 1912.5 MHz
	LTE 25 (Channel Bandwidth: 10MHz)	1855.0 ~ 1910.0 MHz
	LTE 25 (Channel Bandwidth: 15MHz)	1857.5 ~ 1907.5 MHz
LTE 25 (Channel Bandwidth: 20MHz)	1860.0 ~ 1905.0 MHz	

Max. EIRP Power	GSM/GPRS		GMSK	31.25	dBm
	EDGE		8PSK	27.92	dBm
	WCDMA		BPSK	24.98	dBm
	WCDMA_HSDPA		16QAM	23.95	dBm
	WCDMA_HSUPA		16QAM	23.99	dBm
	WCDMA_DC-HSDPA		16QAM	23.95	dBm
	LTE 2 (Channel Bandwidth: 1.4MHz)		QPSK	24.50	dBm
			16QAM	23.46	dBm
	LTE 2 (Channel Bandwidth: 3MHz)		QPSK	24.35	dBm
			16QAM	23.59	dBm
	LTE 2 (Channel Bandwidth: 5MHz)		QPSK	24.43	dBm
			16QAM	22.84	dBm
	LTE 2 (Channel Bandwidth: 10MHz)		QPSK	24.46	dBm
			16QAM	23.66	dBm
	LTE 2 (Channel Bandwidth: 15MHz)		QPSK	24.71	dBm
			16QAM	24.23	dBm
	LTE 2 (Channel Bandwidth: 20MHz)		QPSK	24.46	dBm
			16QAM	23.76	dBm
	LTE 25 (Channel Bandwidth: 1.4MHz)		QPSK	24.09	dBm
			16QAM	23.25	dBm
	LTE 25 (Channel Bandwidth: 3MHz)		QPSK	24.08	dBm
			16QAM	23.30	dBm
	LTE 25 (Channel Bandwidth: 5MHz)		QPSK	23.99	dBm
			16QAM	23.25	dBm
	LTE 25 (Channel Bandwidth: 10MHz)		QPSK	24.21	dBm
			16QAM	23.16	dBm
	LTE 25 (Channel Bandwidth: 15MHz)		QPSK	24.17	dBm
			16QAM	23.94	dBm
LTE 25 (Channel Bandwidth: 20MHz)		QPSK	24.35	dBm	
		16QAM	23.47	dBm	
Antenna Type	Fixed Internal Antenna				
Antenna Gain	1.5 dBi				
Hardware Version	SH1AGSL09M				
Software Version	AGS-L03C331B005-log				
IMEI No.	Radiated	864273030006025			
	Conducted	864273030006389			
Power Source	#1 DC voltage supplied from adapter. #2 Supplied from battery. #3 Supplied from USB port.				
Power Rating	#1 100-240V~ 50/60Hz 0.2A #2 DC 3.8V 4650mAh #2 DC 5V 1A				

Note:

1. For a more detailed features description, please refer to the manufacturer's specifications or the user's manual.
2. The EUT contains following accessory devices.

Item	Mfr/Brand	Model.
Battery	Sunwoda Electronic Co., LTD	HB3080G1EBC/
	Harbin Coslight Power Co.,Ltd.	HB3080G1EBW
Earphone	JIANGXI LIANCHUANG HONGSHENG ELECTRONIC CO., LTD	22040150
	BOLUO COUNTY QUANCHENG ELECTRONIC CO., LTD	22040150
	Goer Tek Inc	22040150
USB Cable	Shenzhen Luxshare Precision Industry Co.,Ltd.	L99U2017-CS-H
	FOXCONN INTERCONNECT TECHNOLOGY LIMITED	CUBB01M-HC304-DH
	HONGLIN TECHNOLOGY CO.,LTD	130-26988
Adapter	DONGGUAN PHITEK ELECTRONICS CO.,LTD.	HW-050100U01
	SHENZHEN HUNTKEY ELECTRONIC CO.,LTD.	HW-050100A01 HW-050100E01
	HUIZHOU BYD ELECTRONIC CO., LTD.	HW-050100B01

3.2 DESCRIPTION OF TEST MODES AND TEST CONDITION

Pre-Scan has been conducted to determine the worst-case mode from all possible combinations between available modulations, data rates, XYZ axis and antenna ports
 The worst case was found when positioned on X-plane for EIRP and X-axis for radiated emission.
 Following channel(s) was (were) selected for the final test as listed below:

GSM MODE			
Test Item	Available Channel	Tested Channel	Mode
EIRP	512 to 810	512, 661, 810	GSM, EDGE
Conducted Output Power	512 to 810	512, 661, 810	GSM, EDGE
Occupied Bandwidth	512 to 810	512, 661, 810	GSM, EDGE
Condcudeted Emission	512 to 810	661	GSM, EDGE
Radiated Emission	512 to 810	661	GSM, EDGE
Band Edge	512 to 810	512, 810	GSM, EDGE
Peak to Average Ratio	512 to 810	512, 661, 810	GSM, EDGE
Frequency Stability	512 to 810	661	GSM

WCDMA MODE			
Test Item	Available Channel	Tested Channel	Mode
EIRP	9262 to 9538	9262, 9400, 9538	WCDMA, HSDPA, HSUPA, DC-HSDPA
Conducted Output Power	9262 to 9538	9262, 9400, 9538	WCDMA, HSDPA, HSUPA, DC-HSDPA
Condcudeted Emission	9262 to 9538	9400	WCDMA, HSDPA, HSUPA
Radiated Emission	9262 to 9538	9400	WCDMA, HSDPA, HSUPA
Band Edge	9262 to 9538	9262, 9538	WCDMA, HSDPA, HSUPA
Peak to Average Ratio	9262 to 9538	9262, 9400, 9538	WCDMA, HSDPA, HSUPA
Frequency Stability	9262 to 9538	9262	WCDMA

Note: This device was tested under all bandwidths, RB configurations and modulations. The worst case was found in **QPSK** modulation.

LTE BAND 2					
Test Item	Available Channel	Tested Channel	Channel Bandwidth	Modulation	Mode
EIRP	18607 to 19193	18607, 18900, 19193	1.4MHz	QPSK, 16QAM	1RB/3RB/6RB
	18615 to 19185	18615, 18900, 19185	3MHz	QPSK, 16QAM	1RB/8RB/15RB
	18625 to 19175	18625, 18900, 19175	5MHz	QPSK, 16QAM	1RB/12RB/25RB
	18650 to 19150	18650, 18900, 19150	10MHz	QPSK, 16QAM	1RB/25RB/50RB
	18675 to 19125	18675, 18900, 19125	15MHz	QPSK, 16QAM	1RB/36RB/75RB
	18700 to 19100	18700, 18900, 19100	20MHz	QPSK, 16QAM	1RB/50RB/100RB
Occupied Bandwidth	18607 to 19193	18607, 18900, 19193	1.4MHz	QPSK, 16QAM	6RB
	18615 to 19185	18615, 18900, 19185	3MHz	QPSK, 16QAM	15RB
	18625 to 19175	18625, 18900, 19175	5MHz	QPSK, 16QAM	25RB
	18650 to 19150	18650, 18900, 19150	10MHz	QPSK, 16QAM	50RB
	18675 to 19125	18675, 18900, 19125	15MHz	QPSK, 16QAM	75 RB
	18700 to 19100	18700, 18900, 19100	20MHz	QPSK, 16QAM	100RB
Conducted Emission	18607 to 19193	18900	1.4MHz	QPSK	1 RB
	18615 to 19185	18900	3MHz	QPSK	1 RB
	18625 to 19175	18900	5MHz	QPSK	1 RB
	18650 to 19150	18900	10MHz	QPSK	1 RB
	18675 to 19125	18900	15MHz	QPSK	1 RB
	18700 to 19100	18900	20MHz	QPSK	1 RB
Radiated Emission	18607 to 19193	18900	1.4MHz	QPSK	1 RB
	18700 to 19100	18900	20MHz	QPSK	1 RB

LTE BAND 2						
Test Item	Available Channel	Tested Channel	Channel Bandwidth	Modulation	Mode	
Band Edge	18607 to 19193	18607	1.4MHz	QPSK	1RB/6RB	
		19193	1.4MHz	QPSK		
	18615 to 19185	18615	3MHz	QPSK	1RB/15RB	
		19185	3MHz	QPSK		
	18625 to 19175	18625	5MHz	QPSK	1RB/25RB	
		19175	5MHz	QPSK		
	18650 to 19150	18650	10MHz	QPSK	1RB/50RB	
		19150	10MHz	QPSK		
	18675 to 19125	18675	15MHz	QPSK	1RB/75RB	
		19125	15MHz	QPSK		
	18700 to 19100	18700	20MHz	QPSK	1RB/100RB	
		19100	20MHz	QPSK		
	Peak To Average Ratio	18607 to 19193	18607, 18900, 19193	1.4MHz	QPSK, 16QAM	1RB
		18615 to 19185	18615, 18900, 19185	3MHz	QPSK, 16QAM	1RB
18625 to 19175		18625, 18900, 19175	5MHz	QPSK, 16QAM	1RB	
18650 to 19150		18650, 18900, 19150	10MHz	QPSK, 16QAM	1RB	
18675 to 19125		18675, 18900, 19125	15MHz	QPSK, 16QAM	1RB	
18700 to 19100		18700, 18900, 19100	20MHz	QPSK, 16QAM	1RB	
Frequency Stability	18607 to 19193	18900	1.4MHz	QPSK	1RB	
	18615 to 19185	18900	3MHz	QPSK	1RB	
	18625 to 19175	18900	5MHz	QPSK	1RB	
	18650 to 19150	18900	10MHz	QPSK	1RB	
	18675 to 19125	18900	15MHz	QPSK	1RB	
	18700 to 19100	18900	20MHz	QPSK	1RB	

LTE BAND 25					
Test Item	Available Channel	Tested Channel	Channel Bandwidth	Modulation	Mode
EIRP	26047 to 26683	26047, 26365, 26683	1.4MHz	QPSK,16QAM	1RB/3RB/6RB
	26055 to 26675	26055, 26365, 26675	3MHz	QPSK,16QAM	1RB/8RB/15RB
	26065 to 26665	26065, 26365, 26665	5MHz	QPSK,16QAM	1RB/12RB/25RB
	26090 to 26640	26090, 26365, 26640	10MHz	QPSK,16QAM	1RB/25RB/50RB
	26115 to 26615	26115, 26365, 26615	15MHz	QPSK,16QAM	1RB/36RB/75RB
	26140 to 26590	26140, 26365, 26590	20MHz	QPSK,16QAM	1RB/50RB/100RB
Frequency Stability	26047 to 26683	26365	1.4MHz	QPSK	1RB
	26055 to 26675	26365	3MHz	QPSK	1RB
	26065 to 26665	26365	5MHz	QPSK	1RB
	26090 to 26640	26365	10MHz	QPSK	1RB
	26115 to 26615	26365	15MHz	QPSK	1RB
	26140 to 26590	26365	20MHz	QPSK	1RB
Occupied Bandwidth	26047 to 26683	26047, 26365, 26683	1.4MHz	QPSK,16QAM	6RB
	26055 to 26675	26055, 26365, 26675	3MHz	QPSK,16QAM	15RB
	26065 to 26665	26065, 26365, 26665	5MHz	QPSK,16QAM	25RB
	26090 to 26640	26090, 26365, 26640	10MHz	QPSK,16QAM	50RB
	26115 to 26615	26115, 26365, 26615	15MHz	QPSK,16QAM	75RB
	26140 to 26590	26140, 26365, 26590	20MHz	QPSK,16QAM	100RB
Peak to Average Ratio	26047 to 26683	26047, 26365, 26683	1.4MHz	QPSK,16QAM	1RB
	26055 to 26675	26055, 26365, 26675	3MHz	QPSK,16QAM	1RB
	26065 to 26665	26065, 26365, 26665	5MHz	QPSK,16QAM	1RB
	26090 to 26640	26090, 26365, 26640	10MHz	QPSK,16QAM	1RB
	26115 to 26615	26115, 26365, 26615	15MHz	QPSK,16QAM	1RB
	26140 to 26590	26140, 26365, 26590	20MHz	QPSK,16QAM	1RB

LTE BAND 25						
Test Item	Available Channel	Tested Channel	Channel Bandwidth	Modulation	Mode	
Band Edge	26047 to 26683	26047	1.4MHz	QPSK	1RB/6RB	
		26683	1.4MHz	QPSK		
	26055 to 26675	26055	3MHz	QPSK	1RB/15RB	
		26675	3MHz	QPSK		
	26065 to 26665	26065	5MHz	QPSK	1RB/25RB	
		26665	5MHz	QPSK		
	26090 to 26640	26090	10MHz	QPSK	1RB/50RB	
		26640	10MHz	QPSK		
	26115 to 26615	26115	15MHz	QPSK	1RB/75RB	
		26615	15MHz	QPSK		
	26140 to 26590	26140	20MHz	QPSK	1RB/100RB	
		26590	20MHz	QPSK		
	Conducted Emission	26047 to 26683	26365	1.4MHz	QPSK	1RB
		26055 to 26675	26365	3MHz	QPSK	1RB
26065 to 26665		26365	5MHz	QPSK	1RB	
26090 to 26640		26365	10MHz	QPSK	1RB	
26115 to 26615		26365	15MHz	QPSK	1RB	
26140 to 26590		26365	20MHz	QPSK	1RB	
Radiated Emission	26047 to 26683	26365	1.4MHz	QPSK	1RB	
	26055 to 26675	26365	3MHz	QPSK	1RB	
	26065 to 26665	26365	5MHz	QPSK	1RB	
	26090 to 26640	26365	10MHz	QPSK	1RB	
	26115 to 26615	26365	15MHz	QPSK	1RB	
	26140 to 26590	26365	20MHz	QPSK	1RB	

EUT TEST CONDITIONS:

Test Item	Environmental Conditions	Test Voltage
EIRP	25°C, 60%RH	AC 120V/60Hz
Conducted Output Power	25°C, 65%RH	AC 120V/60Hz
Occupied Bandwidth	25°C, 65%RH	AC 120V/60Hz
Conducted Emission	25°C, 65%RH	AC 120V/60Hz
Radiated Emission	25°C, 60%RH	AC 120V/60Hz
Band Edge	25°C, 65%RH	AC 120V/60Hz
Peak to Average Ratio	25°C, 65%RH	AC 120V/60Hz
Frequency Stability	25°C, 65%RH	AC 120V/60Hz

3.3 BLOCK DIAGRAM SHOWING THE CONFIGURATION OF SYSTEM TESTED

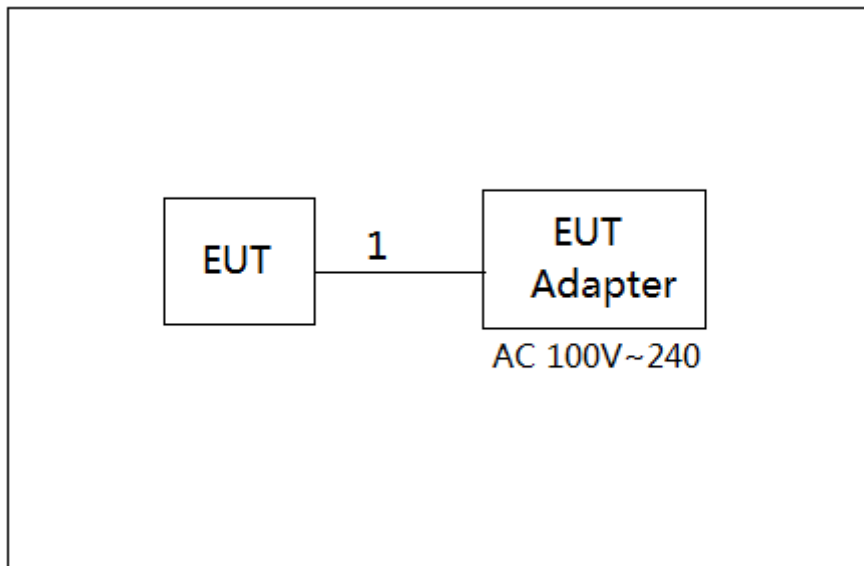

3.4 DESCRIPTION OF SUPPORT UNITS

The EUT has been tested as an independent unit together with other necessary accessories or support units. The following support units or accessories were used to form a representative test configuration during the tests.

Item	Equipment	Mfr/Brand	Model/Type No.	FCC ID	Series No.
-	-	-	-	-	-

Item	Shielded Type	Ferrite Core	Length	Note
1	YES	NO	1m	USB cable

4. TEST RESULT

4.1 OUTPUT POWER MEASUREMENT

4.1.1 LIMIT

Mobile / Portable station are limited to 2 watts e.i.r.p.

4.1.2 TEST PROCEDURE

EIRP/ERP:

EIRP= Conducted Power +Antenan gain

ERP power=EIPR power-2.15dBi.

Conducted Power:

The EUT was set up for the maximum power with GSM, GPRS, EDGE, WCDMA, CDMA, and LTE link data modulation and link up with simulator. Set the EUT to transmit under low, middle and high channel and record the power level shown on simulator.

4.1.3 TESTSETUP LAYOUT

Conducted Power Measurement

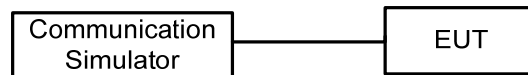

4.1.4 TEST DEVIATION

No deviation

4.1.5 TEST RESULTS

Please refer to the Attachment A.

4.2 OCCUPIED BANDWIDTH MEASUREMENT

4.2.1 TEST PROCEDURE

The EUT makes a call to the communication simulator. All measurements were done at low, middle and high operational frequency range. The communication simulator station system controlled a EUT to export maximum output power under transmission mode and specific channel frequency. Use OBW measurement function of Spectrum analyzer to measure 99 % occupied bandwidth and 26dB bandwidth.

4.2.2 TEST SETUP LAYOUT

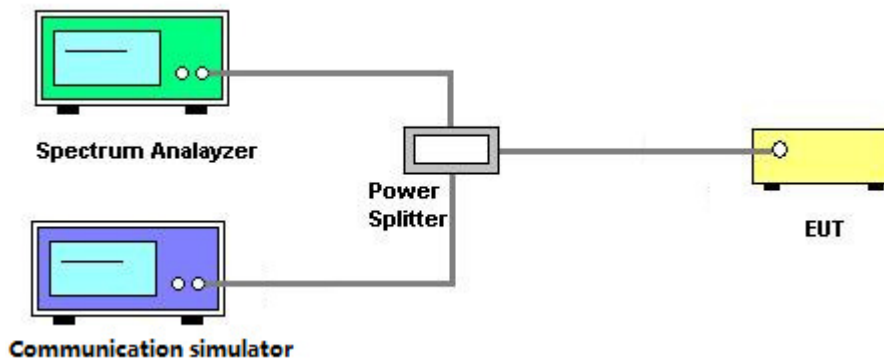

4.2.3 TEST DEVIATION

No deviation

4.2.4 TEST RESULTS

Please refer to the Attachment B.

4.3 CONDUCTED EMISSIONS MEASUREMENT

4.3.1 LIMIT

The power of any emission outside of the authorized operating frequency ranges must be attenuated below the transmitting power (P) by a factor of at least $43 + 10 \log(P)$ dB. The emission limit equal to -13dBm .

4.3.2 TEST PROCEDURES

1. The testing follows FCC KDB 971168 v02r02 Section 6.0.
2. The EUT was connected to spectrum analyzer and system simulator via a power divider.
3. The band edges of low and high channels for the highest RF powers were measured. Set $\text{RBW} \geq 1\%$ EBW in the 1MHz band immediately outside and adjacent to the band edge.
4. Set spectrum analyzer with RMS detector.
5. The RF fundamental frequency should be excluded against the limit line in the operating frequency band.
6. The limit line is derived from $43+10\log(P)\text{dB}$ below the transmitter power P(Watts)

$$= P(\text{W}) - [43 + 10\log(P)](\text{dB})$$

$$= [30 + 10\log(P)](\text{dBm}) - [43 + 10\log(P)](\text{dB})$$

$$= -13\text{dBm}$$

4.3.3 TESTSETUP LAYOUT

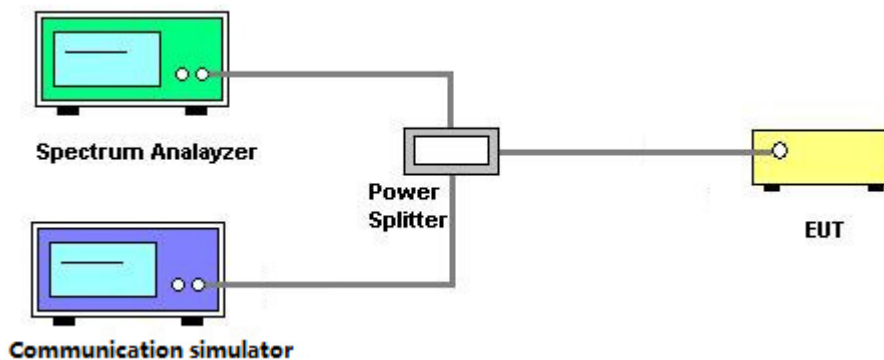

4.3.4 TESTDEVIATION

No deviation

4.3.5 TEST RESULTS

Please refer to the Attachment C.

4.4 RADIATED EMISSIONS MEASUREMENT

4.4.1 LIMIT

The power of any emission outside of the authorized operating frequency ranges must be attenuated below the transmitting power (P) by a factor of at least $43 + 10 \log(P)$ dB. The emission limit equal to -13dBm.

4.4.2 TEST PROCEDURES

1. Substitution method is used for E.I.R.P measurement. In the semi-anechoic chamber, EUT placed on the 0.8m height of Turn Table, rotated the table around 360 degrees to search the maximum radiation power and receiver antenna shall be rotated vertical and horizontal polarization and moved height from 1m to 4m to find the maximum polar radiated power. The "Read Value" is the spectrum reading the maximum power value.
2. The substitution horn antenna is substituted for EUT at the same position and signals generator export the CW signal to the substitution antenna via a TX cable. Rotated the Turn Table and moved receiving antenna to find the maximum radiation power. Adjust output power level of S.G to get a Value of spectrum reading equal to "Read Value " of step a. Record the power level of S.G
3. EIRP = Output power level of S.G – TX cable loss + Antenna gain of substitution horn.
4. E.R.P power can be calculated form E.I.R.P power by subtracting the gain of dipole, E.R.P power = E.I.P.R power - 2.15dBi.
5. The resolution bandwidth and video bandwidth of test receiver/spectrum analyzer is 1MHz/3MHz.

4.4.3 TESTSETUP LAYOUT

This test setup layout is the same as that shown in **section 4.1.3**.

4.4.4 TESTDEVIATION

No deviation

4.4.5 TEST RESULTS

Please refer to the Attachment D.

4.5 BAND EDGE MEASUREMENT

4.5.1 LIMIT

A Power of any emission outside of the authorized operating frequency ranges must be attenuated below the transmitting power (P) by a factor of at least $43 + 10 \log(P)$ dB. In the 1 MHz bands immediately outside and adjacent to the frequency block a resolution bandwidth of at least one percent of the emission bandwidth of the fundamental emission of the transmitter may be employed.

4.5.2 TEST PROCEDURES

1. All measurements were done at low and high operational frequency range.
2. The center frequency of spectrum is the band edge frequency and span is 1MHz. RB of the spectrum is 3kHz and VB of the spectrum is 10kHz (GSM/GPRS/EDGE).
3. The center frequency of spectrum is the band edge frequency and span is 5MHz. RB of the spectrum is 100kHz and VB of the spectrum is 300kHz (WCDMA).
4. The center frequency of spectrum is the band edge frequency and span is 1MHz. RB of the spectrum is 13kHz and VB of the spectrum is 51kHz (LTE Bandwidth 1.4MHz).
5. The center frequency of spectrum is the band edge frequency and span is 1MHz. RB of the spectrum is 30kHz and VB of the spectrum is 100kHz (LTE Bandwidth 3MHz).
6. The center frequency of spectrum is the band edge frequency and span is 1MHz. RB of the spectrum is 100kHz and VB of the spectrum is 300kHz (LTE Bandwidth 5MHz/10MHz).
7. Record the max trace plot into the test report.

4.5.3 TESTSETUP LAYOUT

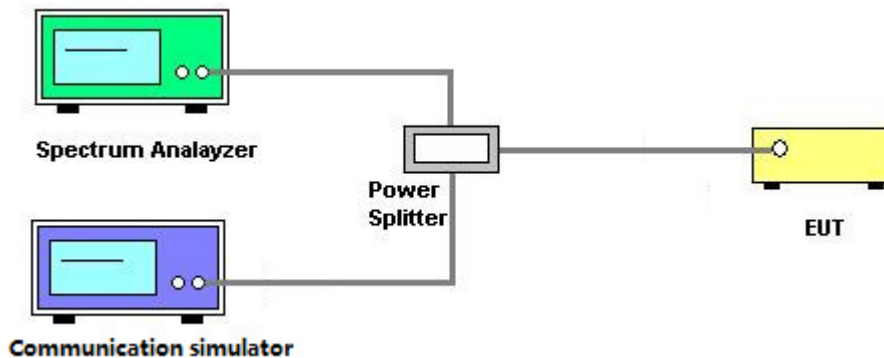

4.5.4 TESTDEVIATION

No deviation

4.5.5 TEST RESULTS

Please refer to the Attachment E.

4.6 PEAK TO AVERAGE RATIO MEASUREMENT

4.6.1 LIMIT

In measuring transmissions in this band using an average power technique, the peak to-average ratio (PAR) of the transmission may not exceed 13 dB.

4.6.2 TEST PROCEDURES

1. Set resolution/measurement bandwidth \geq signal's occupied bandwidth;
2. Set the number of counts to a value that stabilizes the measured CCDF curve;
3. Record the maximum PAPR level associated with a probability of 0.1%.

4.6.3 TESTSETUP LAYOUT

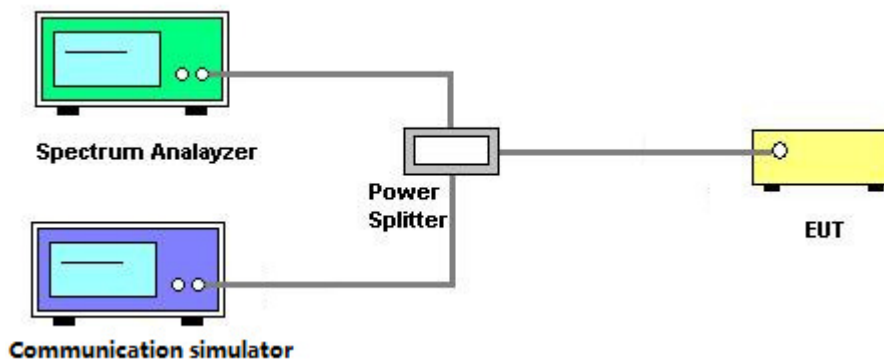

4.6.4 TESTDEVIATION

No deviation

4.6.5 TEST RESULTS

Please refer to the Attachment F.

4.7 FREQUENCY STABILITY MEASUREMENT

4.7.1 LIMIT

1.5 ppm is for base and fixed station. 2.5 ppm is for mobile station.

4.7.2 TEST PROCEDURES

1. Device is placed at the oven room. The oven room could control the temperatures and humidity. Power warm up is at least 15 min and power applied should perform before recording frequency error.
2. EUT is connected the external power supply to control the DC input power. The test voltage range is from minimum to maximum working voltage. Each step shall be record the frequency error rate.
3. The temperature range step is 10 degrees in this test items. All temperature levels shall be hold the $\pm 0.5^{\circ}\text{C}$ during the measurement testing. The each temperature step shall be at least 0.5 hours, consider the EUT could be test under the stability condition.
4. The frequency error was recorded frequency error from the communication simulator.

4.7.3 TESTSETUP LAYOUT

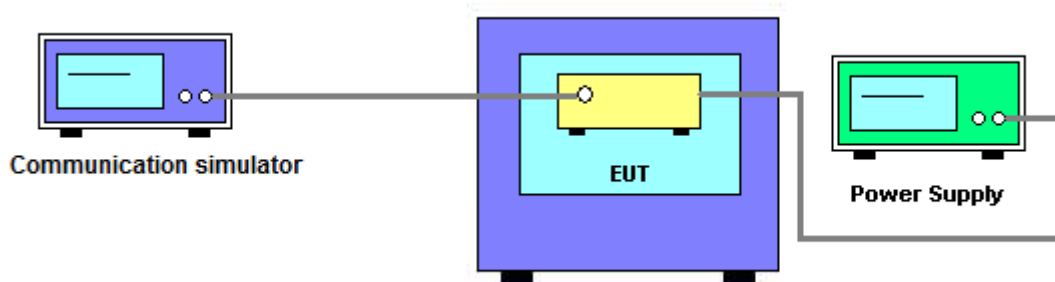

4.7.4 TESTDEVIATION

No deviation

4.7.5 TEST RESULTS

Please refer to the Attachment G.

5. LIST OF MEASUREMENT EQUIPMENTS

Radiated Emission & ERP or EIRP Measurement					
Item	Kind of Equipment	Manufacturer	Type No.	Serial No.	Calibrated until
1	Antenna	Schwarbeck	VULB9160	9160-3232	Mar. 26, 2018
2	Double Ridged Guide Antenna	ETS	3115	75789	Mar. 26, 2018
3	Broad-Band Horn Antenna	Schwarzbeck	BBHA 9170	9170319	Apr. 22, 2018
4	Amplifier	Agilent	8449B	3008A02274	Mar. 09, 2018
5	Amplifier	HP	8447D	2944A09673	Oct. 20, 2017
6	HighPass Filter	Wairwright Instruments Gmbh	WHK 1.5/15G-10ST	11	Mar. 09, 2018
7	Band Reject Filter	Wairwright Instruments Gmbh	WRCG 1710/1785-1690/180 5-60/12SS	38	Feb. 22, 2018
8	Band Reject Filter	Wairwright Instruments Gmbh	WRCG 824/849-810/863-60/ 9SS	7	Feb. 22, 2018
9	Band Reject Filter	Wairwright Instruments Gmbh	WRCG 880/915-860/935-60/ 9SS	14	Feb. 22, 2018
10	Band Reject Filter	Wairwright Instruments Gmbh	WRCG 1850/1910-1830/193 0-60/10SS	17	Feb. 22, 2018
11	HighPass Filter	Wairwright Instruments Gmbh	WHK3.1/18G-10SS	24	Mar. 09, 2018
12	Wireless Communication Test SET	Agilent	E5515C	MY48364183	Mar. 26, 2018
13	Microwave Preamplifier With Adaptor	EMC INSTRUMENT	EMC2654045	980039 & HA01	Mar. 26, 2018
14	Receiver	Agilent	N9038A	MY52130039	Sep. 04, 2017
15	wideband radio communication tester	R&S	CMW500	152372	Mar. 26, 2018
16	High pass filter	ZHPF-M1000-4000-1	ZHPF-M3-12.75G-3869	B2015073763	Aug. 04, 2017
17	High pass filter	ZHPF-M3-12.75G-3869	ZHPF-M1000-4000-1	B2015073762	Aug. 04, 2017
18	High pass filter	ZHPF-M6-18G-1727	ZHPF-M6-186-1727	B2015073764	Aug. 04, 2017
19	Cable	emci	LMR-400(30MHz-1GHz)(8m+5m)	N/A	Jun. 27, 2017
20	Cable	emci	EMC104-SM-SM-12000(12m)	N/A	Jul. 06, 2017
21	Controller	ETS-Lindgren	2090	N/A	N/A
22	Measurement Software	Farad	EZ-EMC Ver.NB-03A1-01	N/A	N/A

Conducted Emission & Band Edge & Occupied Bandwidth Measurement

Item	Kind of Equipment	Manufacturer	Type No.	Serial No.	Calibrated until
1	Wireless Communication Test SET	Agilent	E5515C	MY48364183	Mar. 26, 2018
2	EXA Spectrum Analyzer	Agilent	N9010A	MY50520044	Mar. 26, 2018
3	POWER SPLITTER	Mini-Circuits	ZFRSC-123-S+	331000910-1	Feb. 25, 2018
4	wideband radio communication tester	R&S	CMW500	152372	Mar. 26, 2018
5	Cable	N/A	RG316(0.3m)	N/A	Jul. 06, 2017
6	Cable	N/A	RG316(0.3m)	N/A	Jul. 06, 2017

Frequency Stability Measurement

Item	Kind of Equipment	Manufacturer	Type No.	Serial No.	Calibrated until
1	Wireless Communication Test SET	Agilent	E5515C	MY48364183	Mar. 26, 2018
2	DC power supply	GW Instek	GPC-3030DN	EK880675	Oct. 13, 2017
3	POWER SPLITTER	Mini-Circuits	ZFRSC-123-S+	331000910-1	Feb. 25, 2018
4	wideband radio communication tester	R&S	CMW500	152372	Mar. 26, 2018
5	Const Temp, & Humidity Chamber	Giant?Force	ITH-225-20-S	IAB0309-001	Sep. 04, 2017
6	Cable	N/A	RG316(0.3m)	N/A	Jul. 06, 2017

Remark: "N/A" denotes no model name, serial no. or calibration specified.
All calibration period of equipment list is one year.

ATTACHMENT A - OUTPUT POWER

Conducted Power:

DCS1900 (Capsensor Off)	Burst Conducted Power (dBm)		
	512CH	661CH	810CH
	1850.2MHz	1880MHz	1909.8MHz
GSM (CS)	29.72	29.51	29.28
GPRS/EDGE (GMSK)	29.75	29.53	29.31
	29.04	28.86	28.59
	27.97	27.82	27.59
	26.21	26.22	26.05
EDGE (8PSK)	26.42	26.25	26.12
	25.20	25.16	24.92
	23.82	23.68	23.32
	22.34	22.53	21.97

Modulation	Band	WCDMA Band II(Capsensor Off)		
	Tx Channel	9262CH	9400CH	9538CH
	Frequency	1852.4MHz	1880MHz	1907.6MHz
BPSK	RMC 12.2K	23.40	23.29	23.44
	RMC 64K	23.30	23.32	23.43
	RMC 144K	23.40	23.27	23.46
	RMC 384K	23.36	23.28	23.48
BPSK	HSDPA Subtest-1	22.39	22.32	22.45
	HSDPA Subtest-2	22.35	22.33	22.41
	HSDPA Subtest-3	21.85	21.80	21.87
	HSDPA Subtest-4	21.84	21.75	21.87
BPSK	HSUPA Subtest-1	22.40	22.27	22.44
	HSUPA Subtest-2	21.83	21.77	21.93
	HSUPA Subtest-3	22.38	22.27	22.45
	HSUPA Subtest-4	22.33	22.34	22.49
	HSUPA Subtest-5	22.36	22.34	22.42
BPSK	DC-HSDPA Subtest-1	22.39	22.32	22.45
	DC-HSDPA Subtest-2	22.35	22.33	22.41
	DC-HSDPA Subtest-3	21.85	21.80	21.87
	DC-HSDPA Subtest-4	21.84	21.75	21.87

LTE Band / BW	Modulation	RB Sizing	RB Offset	Low CH	Mid CH	High CH
				18607 CH	18900 CH	19193 CH
				1850.7 MHz	1880 MHz	1909.3 MHz
2 / 1.4M	QPSK	1	0	22.58	22.52	22.90
		1	2	22.70	22.57	23.00
		1	5	22.61	22.62	22.89
		3	0	22.72	22.68	22.79
		3	1	22.76	22.71	22.82
		3	3	22.84	22.72	22.72
	16QAM	6	0	21.80	21.71	21.87
		1	0	21.32	21.23	21.72
		1	2	21.42	21.14	21.80
		1	5	21.34	21.20	21.83
		3	0	21.64	21.48	21.86
		3	1	21.75	21.01	21.92
		3	3	21.63	21.00	21.96
		6	0	20.92	20.52	20.68

LTE Band / BW	Modulation	RB Sizing	RB Offset	Low CH	Mid CH	High CH
				18615 CH	18900 CH	19185 CH
				1851.5 MHz	1880 MHz	1908.5 MHz
2 / 3M	QPSK	1	0	22.75	22.60	22.78
		1	7	22.85	22.67	22.78
		1	14	22.82	22.67	22.78
		8	0	21.77	21.71	21.94
		8	3	21.77	21.73	21.79
		8	7	21.70	21.72	21.80
		15	0	21.74	21.71	21.87
	16QAM	1	0	21.88	21.79	21.84
		1	7	22.09	22.00	21.86
		1	14	21.90	21.72	21.72
		8	0	21.19	20.65	20.68
		8	3	21.15	20.68	20.63
		8	7	20.77	20.65	20.63
		15	0	20.85	20.49	20.49

LTE Band / BW	Modulation	RB Sizing	RB Offset	Low CH	Mid CH	High CH
				18625 CH	18900 CH	19175 CH
				1852.5 MHz	1880 MHz	1907.5 MHz
2 / 5M	QPSK	1	0	22.93	22.50	22.58
		1	12	22.92	22.64	22.71
		1	24	22.73	22.57	22.76
		12	0	21.72	21.69	21.88
		12	6	21.70	21.73	21.84
		12	13	21.71	21.71	21.82
		25	0	21.77	21.71	21.87
	16QAM	1	0	21.04	21.06	21.25
		1	12	21.16	21.22	21.30
		1	24	21.09	21.17	21.34
		12	0	20.58	20.58	20.47
		12	6	20.66	20.62	20.52
		12	13	20.68	20.59	20.52
		25	0	20.66	20.50	20.47

LTE Band / BW	Modulation	RB Siset	RB Offset	Low CH	Mid CH	High CH
				18650 CH	18900 CH	19150 CH
				1855 MHz	1880 MHz	1905 MHz
2 / 10M	QPSK	1	0	22.89	22.61	22.80
		1	24	22.79	22.84	22.79
		1	49	22.96	22.69	22.95
		25	0	21.86	21.72	21.74
		25	12	21.66	21.77	21.84
		25	25	21.66	21.74	21.83
	16QAM	50	0	21.67	21.75	21.79
		1	0	21.85	22.06	21.67
		1	24	21.78	22.16	21.77
		1	49	21.86	21.76	21.78
		25	0	20.71	20.59	20.87
		25	12	20.53	20.72	20.87
		25	25	20.51	20.75	20.84
		50	0	20.61	20.58	20.56

LTE Band / BW	Modulation	RB Siset	RB Offset	Low CH	Mid CH	High CH
				18675 CH	18900 CH	19125 CH
				1857.5 MHz	1880 MHz	1902.5 MHz
2 / 15M	QPSK	1	0	22.99	22.56	22.61
		1	37	23.21	22.68	22.80
		1	74	22.98	22.63	22.71
		36	0	21.82	22.63	21.77
		36	19	21.72	21.77	21.71
		36	39	21.80	21.69	21.80
		75	0	21.72	21.72	21.79
	16QAM	1	0	21.96	22.05	22.50
		1	37	22.20	21.93	22.73
		1	74	21.93	22.07	22.52
		36	0	20.57	20.67	20.59
		36	19	20.51	20.66	20.64
		36	39	20.61	20.56	20.63
		75	0	20.60	20.53	20.52

LTE Band / BW	Modulation	RB Siset	RB Offset	Low CH	Mid CH	High CH
				18700 CH	18900 CH	19100 CH
				1860 MHz	1880 MHz	1900 MHz
2 / 20M	QPSK	1	0	22.89	22.96	22.75
		1	50	22.78	22.62	22.74
		1	99	22.33	22.85	22.62
		50	0	21.76	21.73	21.80
		50	25	21.75	21.73	21.71
		50	50	21.62	21.64	21.76
		100	0	21.76	21.68	21.78
	16QAM	1	0	21.35	21.61	21.41
		1	50	21.45	21.50	22.24
		1	99	21.27	21.33	21.26
		50	0	20.73	20.50	20.60
		50	25	20.71	20.58	20.63
		50	50	20.50	20.66	20.68
		100	0	20.64	20.61	20.60

LTE Band / BW	Modulation	RB Siset	RB Offset	Low CH	Mid CH	High CH
				26047 CH	26365 CH	26683 CH
				1850.7MHz	1882.5MHz	1914.3MHz
25 / 1.4M	QPSK	1	0	22.30	22.19	22.48
		1	2	22.30	22.24	22.41
		1	5	22.31	22.24	22.35
		3	0	22.33	22.31	22.51
		3	1	22.36	22.34	22.59
		3	3	22.35	22.34	22.53
	16QAM	6	0	21.32	21.38	21.62
		1	0	21.08	21.09	21.56
		1	2	21.10	21.12	21.75
		1	5	21.02	21.06	21.51
		3	0	21.30	21.07	21.58
		3	1	21.32	21.10	21.60
		3	3	21.31	21.09	21.68
		6	0	20.57	20.31	20.48

LTE Band / BW	Modulation	RB Siset	RB Offset	Low CH	Mid CH	High CH
				26055 CH	26365 CH	26675 CH
				1851.5MHz	1882.5MHz	1913.5MHz
25 / 3M	QPSK	1	0	22.44	22.40	22.37
		1	7	22.55	22.35	22.52
		1	14	22.58	22.16	22.53
		8	0	21.32	21.34	21.60
		8	3	21.32	21.36	21.61
		8	7	21.25	21.33	21.57
		15	0	21.30	21.33	21.58
	16QAM	1	0	21.31	21.80	21.62
		1	7	21.49	21.76	21.67
		1	14	21.31	21.66	21.52
		8	0	20.20	20.33	20.21
		8	3	20.28	20.35	20.34
		8	7	20.17	20.32	20.36
		15	0	20.13	20.27	20.27

LTE Band / BW	Modulation	RB Siset	RB Offset	Low CH	Mid CH	High CH
				26065 CH	26365 CH	26665 CH
				1852.5MHz	1882.5MHz	1912.5MHz
25 / 5M	QPSK	1	0	22.40	22.23	22.28
		1	12	22.49	22.22	22.39
		1	24	22.48	22.22	22.43
		12	0	21.37	21.23	21.58
		12	6	21.35	21.26	21.61
		12	13	21.36	21.24	21.54
		25	0	21.32	21.25	21.63
	16QAM	1	0	21.19	21.48	21.71
		1	12	21.14	21.61	21.75
		1	24	21.07	21.38	21.52
		12	0	20.15	20.16	20.44
		12	6	20.23	20.19	20.48
		12	13	20.25	20.16	20.42
		25	0	20.42	20.29	20.39

LTE Band / BW	Modulation	RB Siset	RB Offset	Low CH	Mid CH	High CH
				26090 CH	26365 CH	26640 CH
				1855.0 MHz	1882.5 MHz	1910.0 MHz
25 / 10M	QPSK	1	0	22.52	22.26	22.52
		1	24	22.65	22.58	22.58
		1	49	22.71	22.24	22.23
		25	0	21.41	21.46	21.37
		25	12	21.37	21.48	21.49
		25	25	21.29	21.33	21.28
		50	0	21.34	21.35	21.33
	16QAM	1	0	21.36	21.14	21.52
		1	24	21.48	21.24	21.45
		1	49	21.60	21.66	21.43
		25	0	20.30	20.42	20.56
		25	12	20.30	20.35	20.38
		25	25	20.33	20.35	20.21
		50	0	20.29	20.35	20.27

LTE Band / BW	Modulation	RB Siset	RB Offset	Low CH	Mid CH	High CH
				26115 CH	26365 CH	26615 CH
				1857.5MHz	1882.5MHz	1907.5MHz
25 / 15M	QPSK	1	0	22.67	22.15	22.25
		1	37	22.59	22.36	22.15
		1	74	22.62	22.08	22.27
		36	0	21.37	22.08	21.48
		36	19	21.50	21.42	21.42
		36	39	21.45	21.32	21.33
		75	0	21.48	21.35	21.39
	16QAM	1	0	21.46	21.12	22.16
		1	37	21.54	21.17	22.44
		1	74	21.54	21.01	21.77
		36	0	20.27	20.81	20.32
		36	19	20.38	20.36	20.31
		36	39	20.39	20.25	20.24
		75	0	20.43	20.16	20.29

LTE Band / BW	Modulation	RB Siset	RB Offset	Low CH	Mid CH	High CH
				26140 CH	26365 CH	26590 CH
				1860.0MHz	1882.5MHz	1905.0MHz
25 / 20M	QPSK	1	0	22.05	22.49	22.15
		1	50	22.47	22.51	22.85
		1	99	22.07	22.60	22.14
		50	0	21.44	21.38	21.43
		50	25	21.37	21.37	21.44
		50	50	21.38	21.26	21.29
		100	0	21.40	21.30	21.40
	16QAM	1	0	21.28	21.39	21.86
		1	50	21.47	21.29	21.97
		1	99	21.29	21.23	21.88
		50	0	20.38	20.28	20.20
		50	25	20.42	20.27	20.31
		50	50	20.29	20.17	20.23
		100	0	20.47	20.29	20.28

EIRP Power

DCS1900 (Capsensor Off)	EIRP Power (dBm)		
	512CH	661CH	810CH
	1850.2MHz	1880MHz	1909.8MHz
GSM (CS)	31.22	31.01	30.78
GPRS/EDGE (GMSK)	31.25	31.03	30.81
	30.54	30.36	30.09
	29.47	29.32	29.09
	27.71	27.72	27.55
EDGE (8PSK)	27.92	27.75	27.62
	26.70	26.66	26.42
	25.32	25.18	24.82
	23.84	24.03	23.47

Modulation	Band	WCDMA Band II(Capsensor Off)		
	Tx Channel	9262CH	9400CH	9538CH
	Rx Channel	9662CH	9800CH	9938CH
	Frequency	1852.4MHz	1880MHz	1907.6MHz
BPSK	RMC 12.2K	24.90	24.79	24.94
	RMC 64K	24.80	24.82	24.93
	RMC 144K	24.90	24.77	24.96
	RMC 384K	24.86	24.78	24.98
BPSK	HSDPA Subtest-1	23.89	23.82	23.95
	HSDPA Subtest-2	23.85	23.83	23.91
	HSDPA Subtest-3	23.35	23.30	23.37
	HSDPA Subtest-4	23.34	23.25	23.37
BPSK	HSUPA Subtest-1	23.90	23.77	23.94
	HSUPA Subtest-2	23.33	23.27	23.43
	HSUPA Subtest-3	23.88	23.77	23.95
	HSUPA Subtest-4	23.83	23.84	23.99
	HSUPA Subtest-5	23.86	23.84	23.92
BPSK	DC-HSDPA Subtest-1	23.89	23.82	23.95
	DC-HSDPA Subtest-2	23.85	23.83	23.91
	DC-HSDPA Subtest-3	23.35	23.30	23.37
	DC-HSDPA Subtest-4	23.34	23.25	23.37

LTE Band / BW	Modulation	RB Sizing	RB Offset	Low CH	Mid CH	High CH
				18607 CH	18900 CH	19193 CH
				1850.7 MHz	1880 MHz	1909.3 MHz
2 / 1.4M	QPSK	1	0	24.08	24.02	24.40
		1	2	24.20	24.07	24.50
		1	5	24.11	24.12	24.39
		3	0	24.22	24.18	24.29
		3	1	24.26	24.21	24.32
		3	3	24.34	24.22	24.22
	16QAM	6	0	23.30	23.21	23.37
		1	0	22.82	22.73	23.22
		1	2	22.92	22.64	23.30
		1	5	22.84	22.70	23.33
		3	0	23.14	22.98	23.36
		3	1	23.25	22.51	23.42
		3	3	23.13	22.50	23.46
		6	0	22.42	22.02	22.18

LTE Band / BW	Modulation	RB Sizing	RB Offset	Low CH	Mid CH	High CH
				18615 CH	18900 CH	19185 CH
				1851.5 MHz	1880 MHz	1908.5 MHz
2 / 3M	QPSK	1	0	24.25	24.10	24.28
		1	7	24.35	24.17	24.28
		1	14	24.32	24.17	24.28
		8	0	23.27	23.21	23.44
		8	3	23.27	23.23	23.29
		8	7	23.20	23.22	23.30
		15	0	23.24	23.21	23.37
	16QAM	1	0	23.38	23.29	23.34
		1	7	23.59	23.50	23.36
		1	14	23.40	23.22	23.22
		8	0	22.69	22.15	22.18
		8	3	22.65	22.18	22.13
		8	7	22.27	22.15	22.13
		15	0	22.35	21.99	21.99

LTE Band / BW	Modulation	RB Sizing	RB Offset	Low CH	Mid CH	High CH
				18625 CH	18900 CH	19175 CH
				1852.5 MHz	1880 MHz	1907.5 MHz
2 / 5M	QPSK	1	0	24.43	24.00	24.08
		1	12	24.42	24.14	24.21
		1	24	24.23	24.07	24.26
		12	0	23.22	23.19	23.38
		12	6	23.20	23.23	23.34
		12	13	23.21	23.21	23.32
		25	0	23.27	23.21	23.37
	16QAM	1	0	22.54	22.56	22.75
		1	12	22.66	22.72	22.80
		1	24	22.59	22.67	22.84
		12	0	22.08	22.08	21.97
		12	6	22.16	22.12	22.02
		12	13	22.18	22.09	22.02
		25	0	22.16	22.00	21.97

LTE Band / BW	Modulation	RB Sizing	RB Offset	Low CH	Mid CH	High CH
				18650 CH	18900 CH	19150 CH
				1855 MHz	1880 MHz	1905 MHz
2 / 10M	QPSK	1	0	24.39	24.11	24.30
		1	24	24.29	24.34	24.29
		1	49	24.46	24.19	24.45
		25	0	23.36	23.22	23.24
		25	12	23.16	23.27	23.34
		25	25	23.16	23.24	23.33
	16QAM	50	0	23.17	23.25	23.29
		1	0	23.35	23.56	23.17
		1	24	23.28	23.66	23.27
		1	49	23.36	23.26	23.28
		25	0	22.21	22.09	22.37
		25	12	22.03	22.22	22.37
		25	25	22.01	22.25	22.34
		50	0	22.11	22.08	22.06

LTE Band / BW	Modulation	RB Sizing	RB Offset	Low CH	Mid CH	High CH
				18675 CH	18900 CH	19125 CH
				1857.5 MHz	1880 MHz	1902.5 MHz
2 / 15M	QPSK	1	0	24.49	24.06	24.11
		1	37	24.71	24.18	24.30
		1	74	24.48	24.13	24.21
		36	0	23.32	24.13	23.27
		36	19	23.22	23.27	23.21
		36	39	23.30	23.19	23.30
		75	0	23.22	23.22	23.29
	16QAM	1	0	23.46	23.55	24.00
		1	37	23.70	23.43	24.23
		1	74	23.43	23.57	24.02
		36	0	22.07	22.17	22.09
		36	19	22.01	22.16	22.14
		36	39	22.11	22.06	22.13
		75	0	22.10	22.03	22.02

LTE Band / BW	Modulation	RB Sizing	RB Offset	Low CH	Mid CH	High CH
				18700 CH	18900 CH	19100 CH
				1860 MHz	1880 MHz	1900 MHz
2 / 20M	QPSK	1	0	24.39	24.46	24.25
		1	50	24.28	24.12	24.24
		1	99	23.83	24.35	24.12
		50	0	23.26	23.23	23.30
		50	25	23.25	23.23	23.21
		50	50	23.12	23.14	23.26
		100	0	23.26	23.18	23.28
	16QAM	1	0	22.85	23.11	22.91
		1	50	22.95	23.00	23.74
		1	99	22.77	22.83	22.76
		50	0	22.23	22.00	22.10
		50	25	22.21	22.08	22.13
		50	50	22.00	22.16	22.18
		100	0	22.14	22.11	22.10

LTE Band / BW	Modulation	RB Sizing	RB Offset	Low CH	Mid CH	High CH
				26047 CH	26365 CH	26683 CH
				1850.7MHz	1882.5MHz	1914.3MHz
25 / 1.4M	QPSK	1	0	23.80	23.69	23.98
		1	2	23.80	23.74	23.91
		1	5	23.81	23.74	23.85
		3	0	23.83	23.81	24.01
		3	1	23.86	23.84	24.09
		3	3	23.85	23.84	24.03
	16QAM	6	0	22.82	22.88	23.12
		1	0	22.58	22.59	23.06
		1	2	22.60	22.62	23.25
		1	5	22.52	22.56	23.01
		3	0	22.80	22.57	23.08
		3	1	22.82	22.60	23.10
		3	3	22.81	22.59	23.18
		6	0	22.07	21.81	21.98

LTE Band / BW	Modulation	RB Sizing	RB Offset	Low CH	Mid CH	High CH
				26055 CH	26365 CH	26675 CH
				1851.5MHz	1882.5MHz	1913.5MHz
25 / 3M	QPSK	1	0	23.94	23.90	23.87
		1	7	24.05	23.85	24.02
		1	14	24.08	23.66	24.03
		8	0	22.82	22.84	23.10
		8	3	22.82	22.86	23.11
		8	7	22.75	22.83	23.07
		15	0	22.80	22.83	23.08
	16QAM	1	0	22.81	23.30	23.12
		1	7	22.99	23.26	23.17
		1	14	22.81	23.16	23.02
		8	0	21.70	21.83	21.71
		8	3	21.78	21.85	21.84
		8	7	21.67	21.82	21.86
		15	0	21.63	21.77	21.77

LTE Band / BW	Modulation	RB Sizing	RB Offset	Low CH	Mid CH	High CH
				26065 CH	26365 CH	26665 CH
				1852.5MHz	1882.5MHz	1912.5MHz
25 / 5M	QPSK	1	0	23.90	23.73	23.78
		1	12	23.99	23.72	23.89
		1	24	23.98	23.72	23.93
		12	0	22.87	22.73	23.08
		12	6	22.85	22.76	23.11
		12	13	22.86	22.74	23.04
		25	0	22.82	22.75	23.13
	16QAM	1	0	22.69	22.98	23.21
		1	12	22.64	23.11	23.25
		1	24	22.57	22.88	23.02
		12	0	21.65	21.66	21.94
		12	6	21.73	21.69	21.98
		12	13	21.75	21.66	21.92
		25	0	21.92	21.79	21.89

LTE Band / BW	Modulation	RB Sizing	RB Offset	Low CH	Mid CH	High CH
				26090 CH	26365 CH	26640 CH
				1855.0MHz	1882.5MHz	1910.0MHz
25 / 10M	QPSK	1	0	24.02	23.76	24.02
		1	24	24.15	24.08	24.08
		1	49	24.21	23.74	23.73
		25	0	22.91	22.96	22.87
		25	12	22.87	22.98	22.99
		25	25	22.79	22.83	22.78
	16QAM	50	0	22.84	22.85	22.83
		1	0	22.86	22.64	23.02
		1	24	22.98	22.74	22.95
		1	49	23.10	23.16	22.93
		25	0	21.80	21.92	22.06
		25	12	21.80	21.85	21.88
		25	25	21.83	21.85	21.71
		50	0	21.79	21.85	21.77

LTE Band / BW	Modulation	RB Sizing	RB Offset	Low CH	Mid CH	High CH
				26115 CH	26365 CH	26615 CH
				1857.5MHz	1882.5MHz	1907.5MHz
25 / 15M	QPSK	1	0	24.17	23.65	23.75
		1	37	24.09	23.86	23.65
		1	74	24.12	23.58	23.77
		36	0	22.87	23.58	22.98
		36	19	23.00	22.92	22.92
		36	39	22.95	22.82	22.83
		75	0	22.98	22.85	22.89
	16QAM	1	0	22.96	22.62	23.66
		1	37	23.04	22.67	23.94
		1	74	23.04	22.51	23.27
		36	0	21.77	22.31	21.82
		36	19	21.88	21.86	21.81
		36	39	21.89	21.75	21.74
		75	0	21.93	21.66	21.79

LTE Band / BW	Modulation	RB Sizing	RB Offset	Low CH	Mid CH	High CH
				26140 CH	26365 CH	26590 CH
				1860.0MHz	1882.5MHz	1905.0MHz
25 / 20M	QPSK	1	0	23.55	23.99	23.65
		1	50	23.97	24.01	24.35
		1	99	23.57	24.10	23.64
		50	0	22.94	22.88	22.93
		50	25	22.87	22.87	22.94
		50	50	22.88	22.76	22.79
		100	0	22.90	22.80	22.90
	16QAM	1	0	22.78	22.89	23.36
		1	50	22.97	22.79	23.47
		1	99	22.79	22.73	23.38
		50	0	21.88	21.78	21.70
		50	25	21.92	21.77	21.81
		50	50	21.79	21.67	21.73
		100	0	21.97	21.79	21.78

ATTACHMENT B - OCCUPIED BANDWIDTH

DCS1900					
GSM			EDGE		
CS			8PSK		
Channel	Frequency (MHz)	99% Occupied Bandwidth (MHz)	Channel	Frequency (MHz)	99% Occupied Bandwidth (MHz)
512	1850.2	0.2422	512	1850.2	0.2515
661	1880	0.2409	661	1880	0.2455
810	1909.8	0.2407	810	1909.8	0.2474
Channel	Frequency (MHz)	26dB Bandwidth (MHz)	Channel	Frequency (MHz)	26dB Bandwidth (MHz)
512	1850.2	0.3031	512	1850.2	0.3159
661	1880	0.3035	661	1880	0.3228
810	1909.8	0.3098	810	1909.8	0.3192

Spectrum Plot

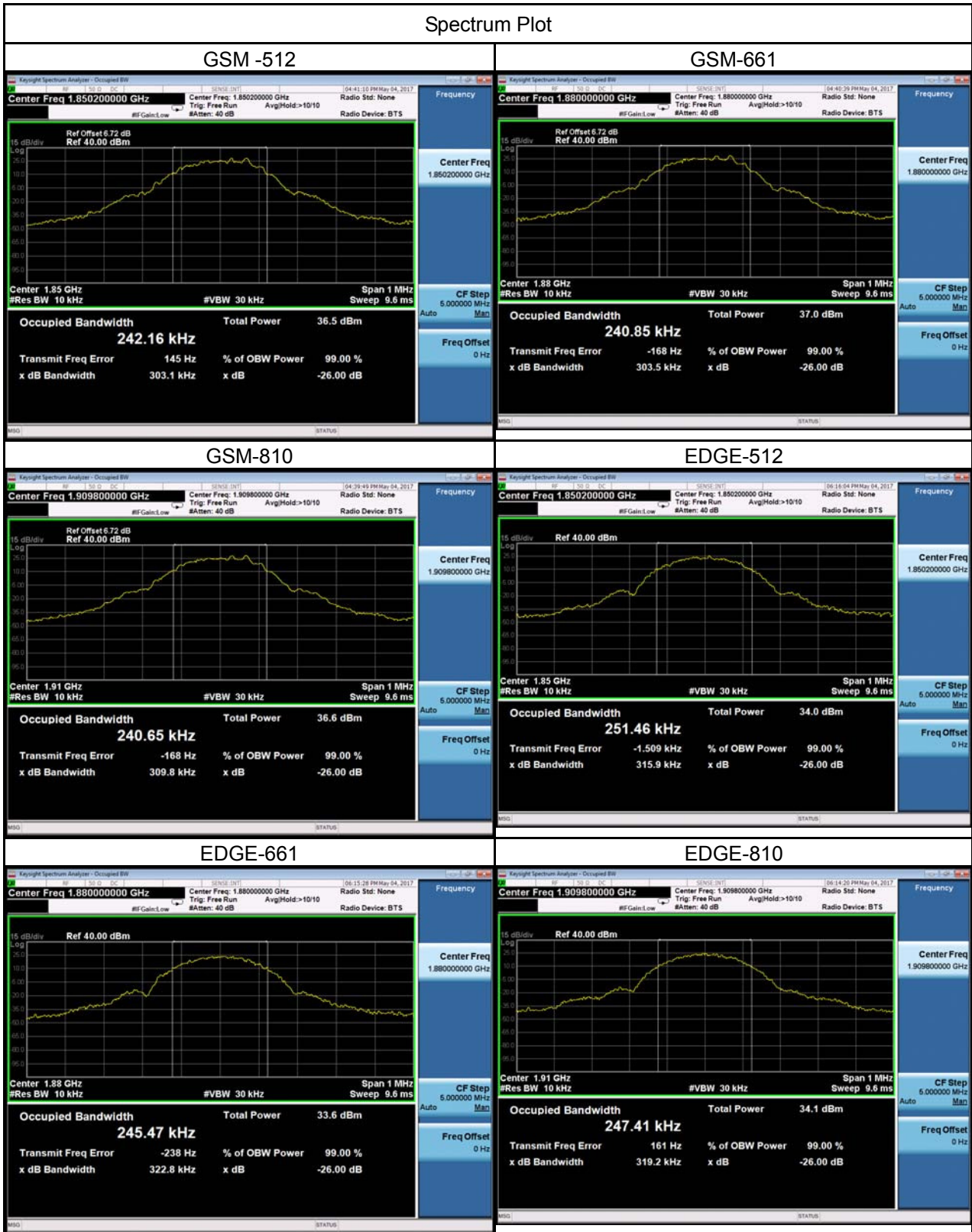

WCDMA Band II					
BPSK					
Channel	Frequency (MHz)	99% Occupied Bandwidth (MHz)	Channel	Frequency (MHz)	26dB Bandwidth (MHz)
9262	1852.4	4.1351	9262	1852.4	4.726
9400	1880	4.1502	9400	1880	4.724
9538	1907.6	4.1323	9538	1907.6	4.716



WCDMA_HSDPA Band II					
BPSK					
Channel	Frequency (MHz)	99% Occupied Bandwidth (MHz)	Channel	Frequency (MHz)	26dB Bandwidth (MHz)
9262	1852.4	4.1379	9262	1852.4	4.692
9400	1880	4.1292	9400	1880	4.697
9538	1907.6	4.1429	9538	1907.6	4.702



WCDMA_HSUPA Band II					
BPSK					
Channel	Frequency (MHz)	99% Occupied Bandwidth (MHz)	Channel	Frequency (MHz)	26dB Bandwidth (MHz)
9262	1852.4	4.1395	9262	1852.4	4.734
9400	1880	4.1381	9400	1880	4.741
9538	1907.6	4.1325	9538	1907.6	4.741

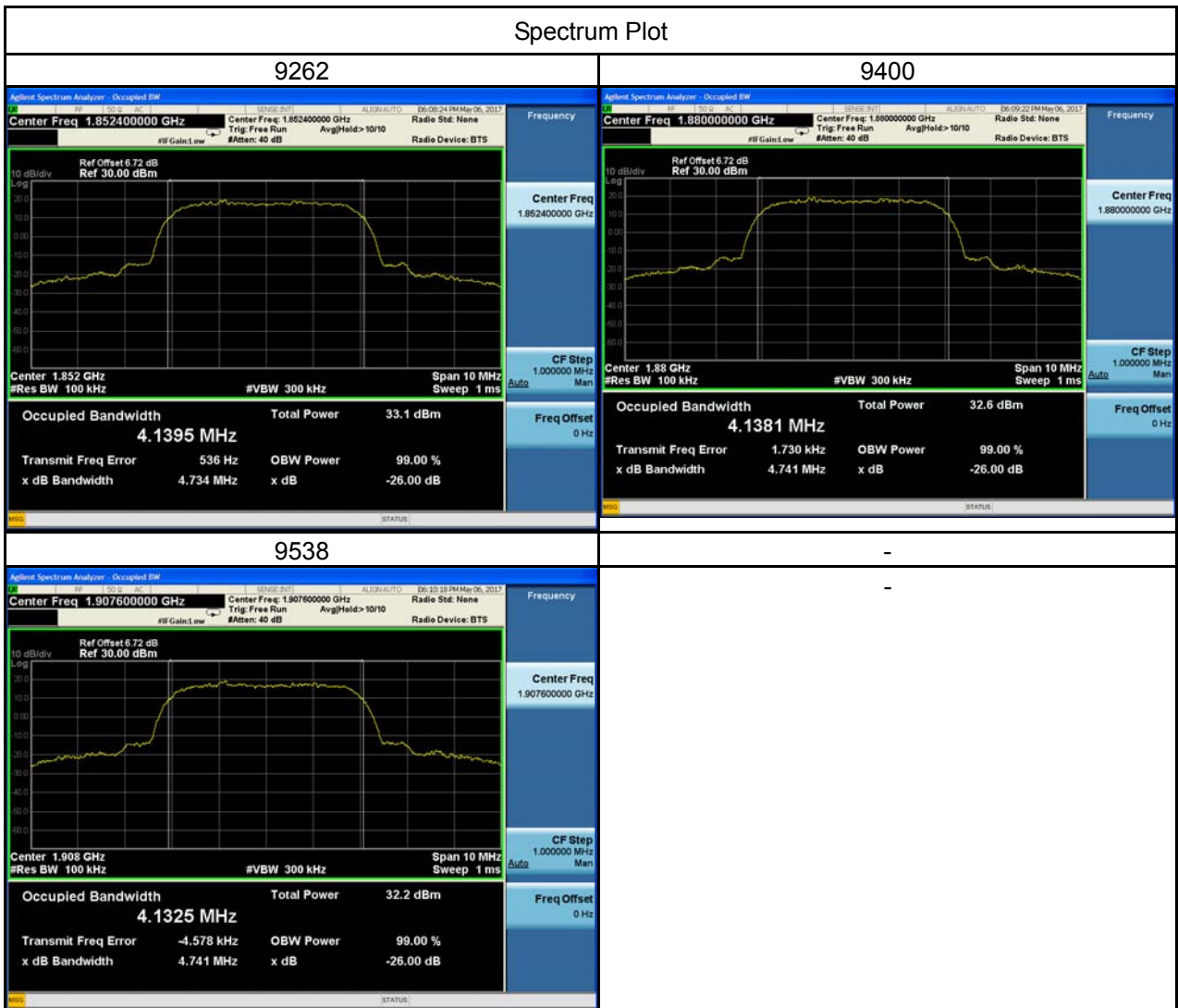

LTE Band 2_1.4M					
QPSK			16QAM		
Channel	Frequency (MHz)	99% Occupied Bandwidth (MHz)	Channel	Frequency (MHz)	99% Occupied Bandwidth (MHz)
18607	1850.7	1.0933	18607	1850.7	1.0925
18900	1880	1.0996	18900	1880	1.0951
19193	1909.3	1.0882	19193	1909.3	1.0903
Channel	Frequency (MHz)	26dB Bandwidth (MHz)	Channel	Frequency (MHz)	26dB Bandwidth (MHz)
18607	1850.7	1.287	18607	1850.7	1.303
18900	1880	1.321	18900	1880	1.301
19193	1909.3	1.286	19193	1909.3	1.305

Spectrum Plot

QPSK-18607

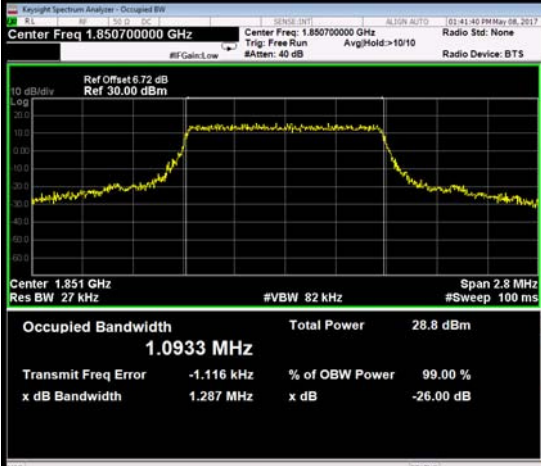

QPSK-18900



QPSK-19193

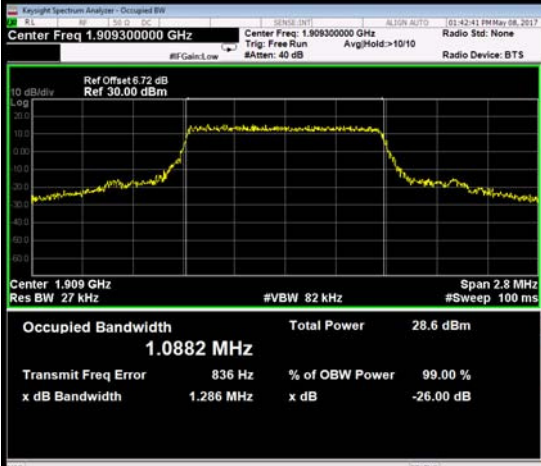

16QAM-18607



16QAM-18900

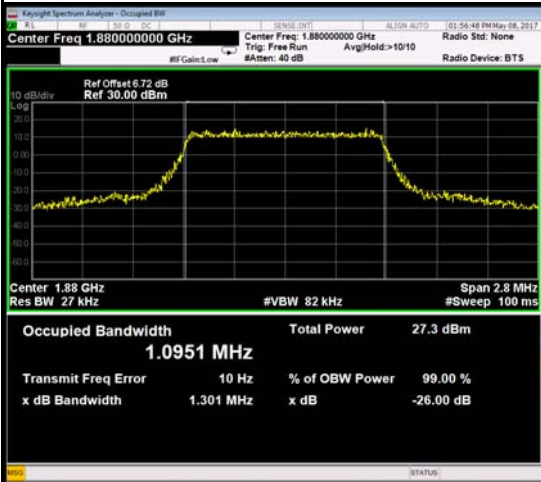

16QAM-19193

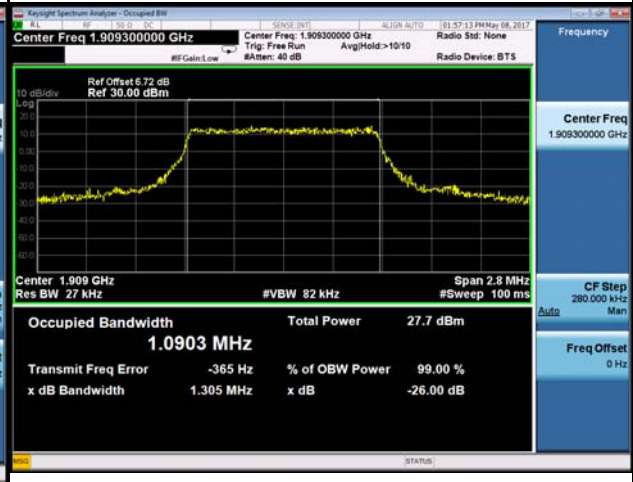

LTE Band 2_3M					
QPSK			16QAM		
Channel	Frequency (MHz)	99% Occupied Bandwidth (MHz)	Channel	Frequency (MHz)	99% Occupied Bandwidth (MHz)
18615	1851.5	2.6951	18615	1851.5	2.7020
18900	1880	2.7008	18900	1880	2.6986
19185	1908.5	2.7020	19185	1908.5	2.6975
Channel	Frequency (MHz)	26dB Bandwidth (MHz)	Channel	Frequency (MHz)	26dB Bandwidth (MHz)
18615	1851.5	2.999	18615	1851.5	3.002
18900	1880	2.991	18900	1880	2.998
19185	1908.5	2.964	19185	1908.5	2.993

Spectrum Plot

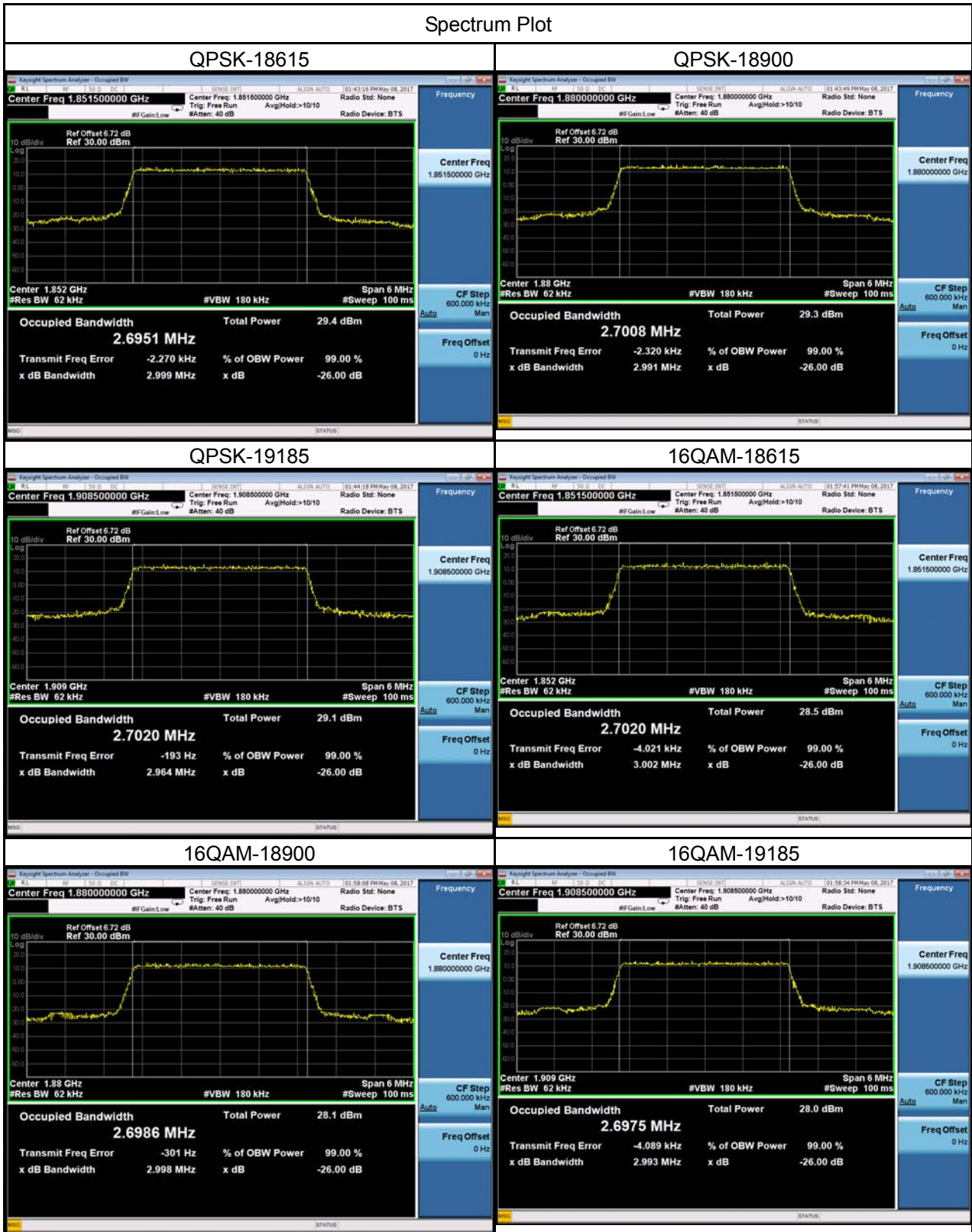

LTE Band 2_5M					
QPSK			16QAM		
Channel	Frequency (MHz)	99% Occupied Bandwidth (MHz)	Channel	Frequency (MHz)	99% Occupied Bandwidth (MHz)
18625	1852.5	4.5255	18625	1852.5	4.5043
18900	1880	4.5109	18900	1880	4.4991
19175	1907.5	4.5081	19175	1907.5	4.5096
Channel	Frequency (MHz)	26dB Bandwidth (MHz)	Channel	Frequency (MHz)	26dB Bandwidth (MHz)
18625	1852.5	5.001	18625	1852.5	4.973
18900	1880	4.984	18900	1880	4.973
19175	1907.5	5.023	19175	1907.5	4.928

Spectrum Plot

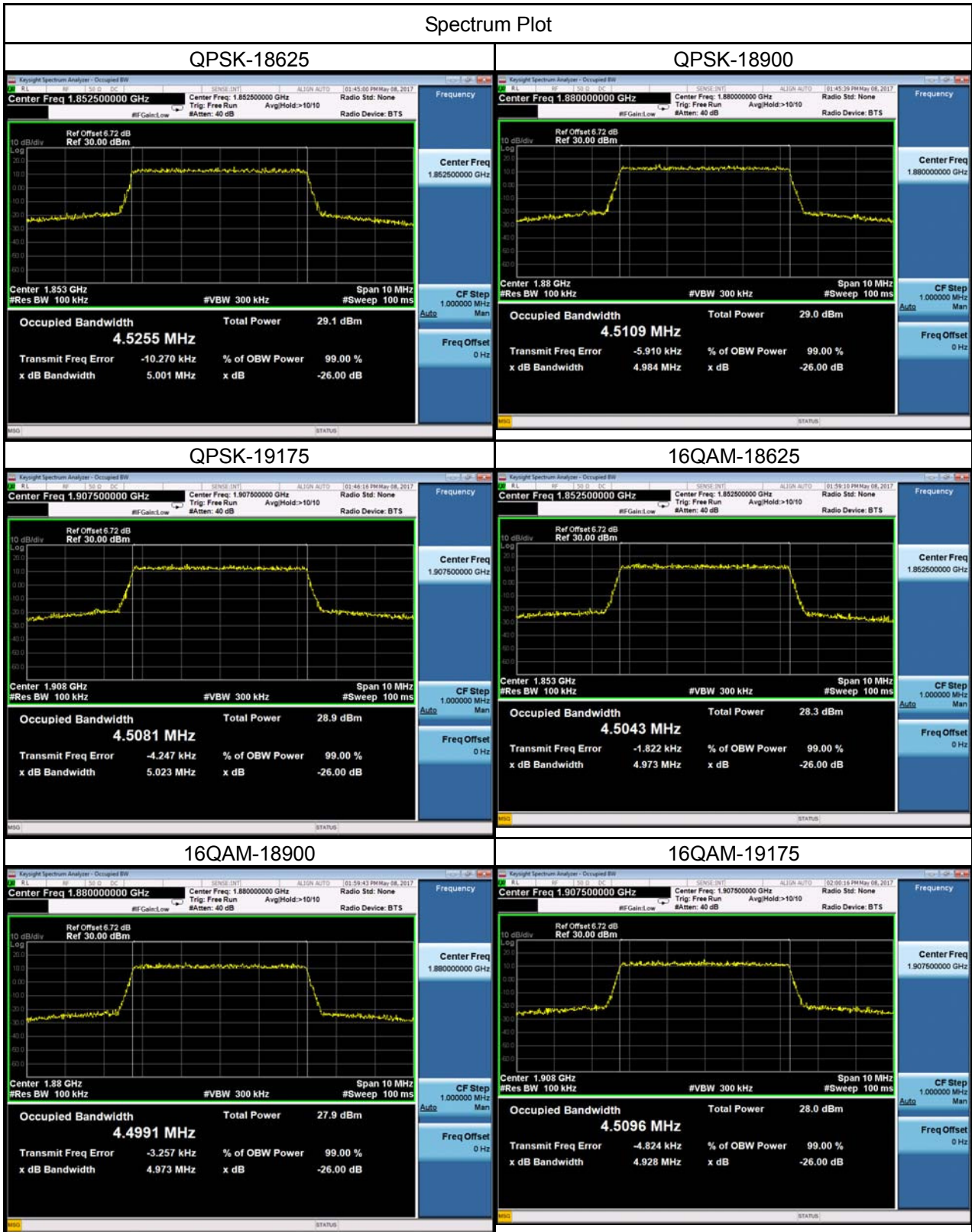

LTE Band 2_10M					
QPSK			16QAM		
Channel	Frequency (MHz)	99% Occupied Bandwidth (MHz)	Channel	Frequency (MHz)	99% Occupied Bandwidth (MHz)
18650	1855	8.9662	18650	1855	8.9723
18900	1880	8.9631	18900	1880	8.9747
19150	1905	8.9591	19150	1905	8.9746
Channel	Frequency (MHz)	26dB Bandwidth (MHz)	Channel	Frequency (MHz)	26dB Bandwidth (MHz)
18650	1855	9.840	18650	1855	9.889
18900	1880	9.775	18900	1880	9.839
19150	1905	9.948	19150	1905	9.746

Spectrum Plot

QPSK-18650

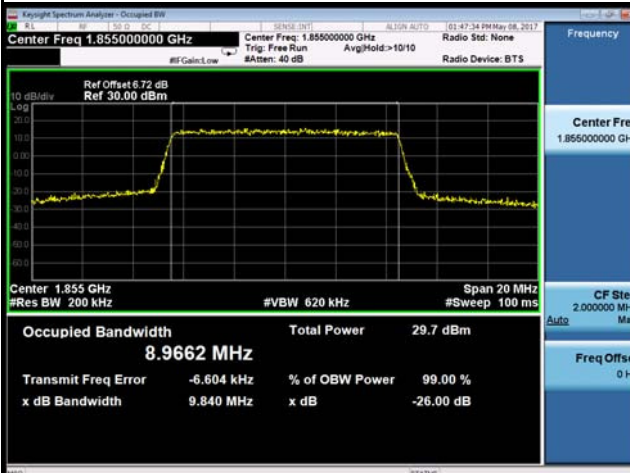

QPSK-18900



QPSK-19150



16QAM-18650



16QAM-18900



16QAM-19150



LTE Band 2_15M					
QPSK			16QAM		
Channel	Frequency (MHz)	99% Occupied Bandwidth (MHz)	Channel	Frequency (MHz)	99% Occupied Bandwidth (MHz)
18675	1857.5	13.442	18675	1857.5	13.472
18900	1880	13.441	18900	1880	13.417
19125	1902.5	13.415	19125	1902.5	13.396
Channel	Frequency (MHz)	26dB Bandwidth (MHz)	Channel	Frequency (MHz)	26dB Bandwidth (MHz)
18675	1857.5	14.67	18675	1857.5	14.62
18900	1880	14.62	18900	1880	14.62
19125	1902.5	14.58	19125	1902.5	14.63

Spectrum Plot

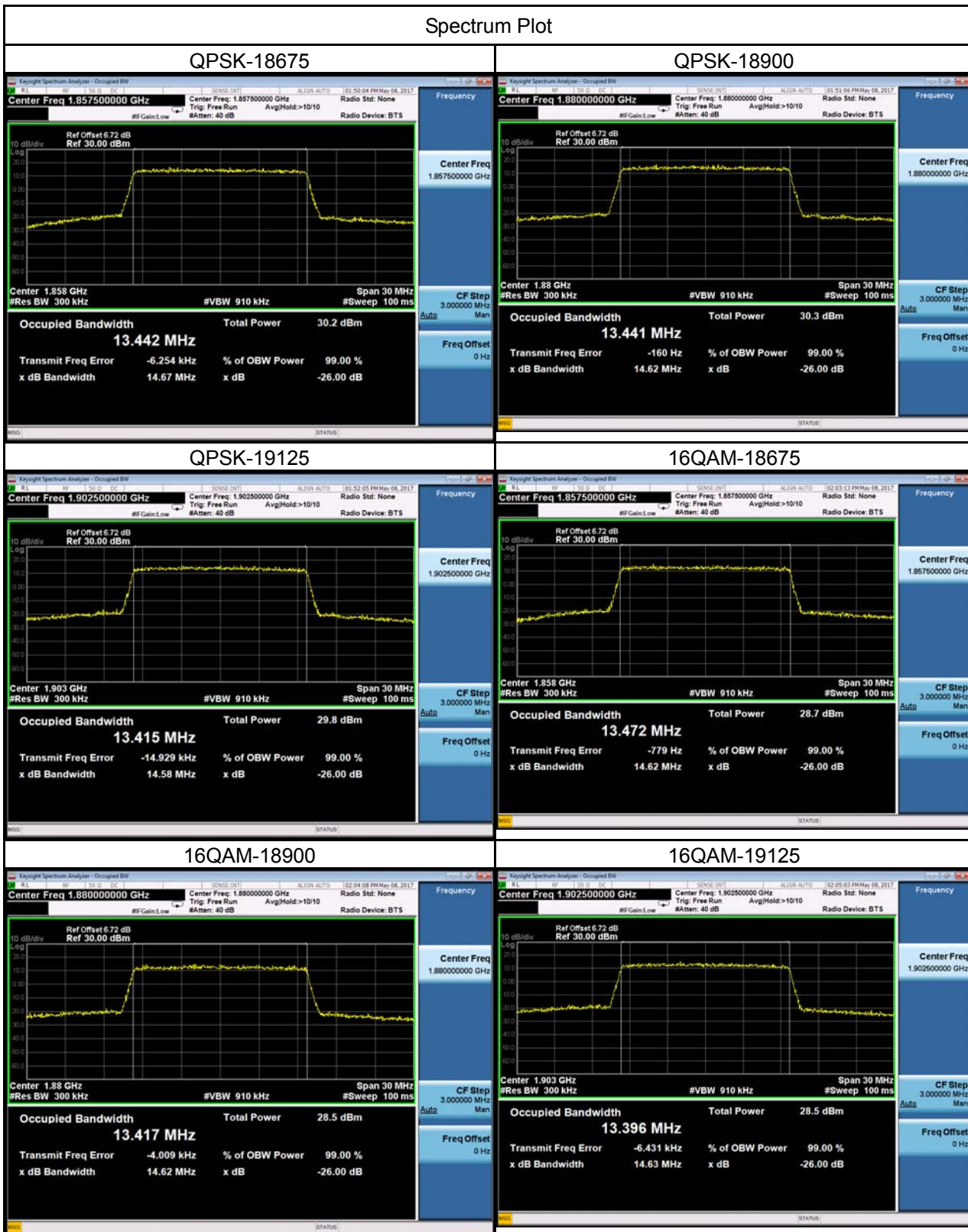

LTE Band 2_20M					
QPSK			16QAM		
Channel	Frequency (MHz)	99% Occupied Bandwidth (MHz)	Channel	Frequency (MHz)	99% Occupied Bandwidth (MHz)
18700	1860	17.916	18700	1860	17.903
18900	1880	17.874	18900	1880	17.907
19100	1900	17.831	19100	1900	17.870
Channel	Frequency (MHz)	26dB Bandwidth (MHz)	Channel	Frequency (MHz)	26dB Bandwidth (MHz)
18700	1860	19.46	18700	1860	19.33
18900	1880	19.38	18900	1880	19.40
19100	1900	19.39	19100	1900	19.22

Spectrum Plot

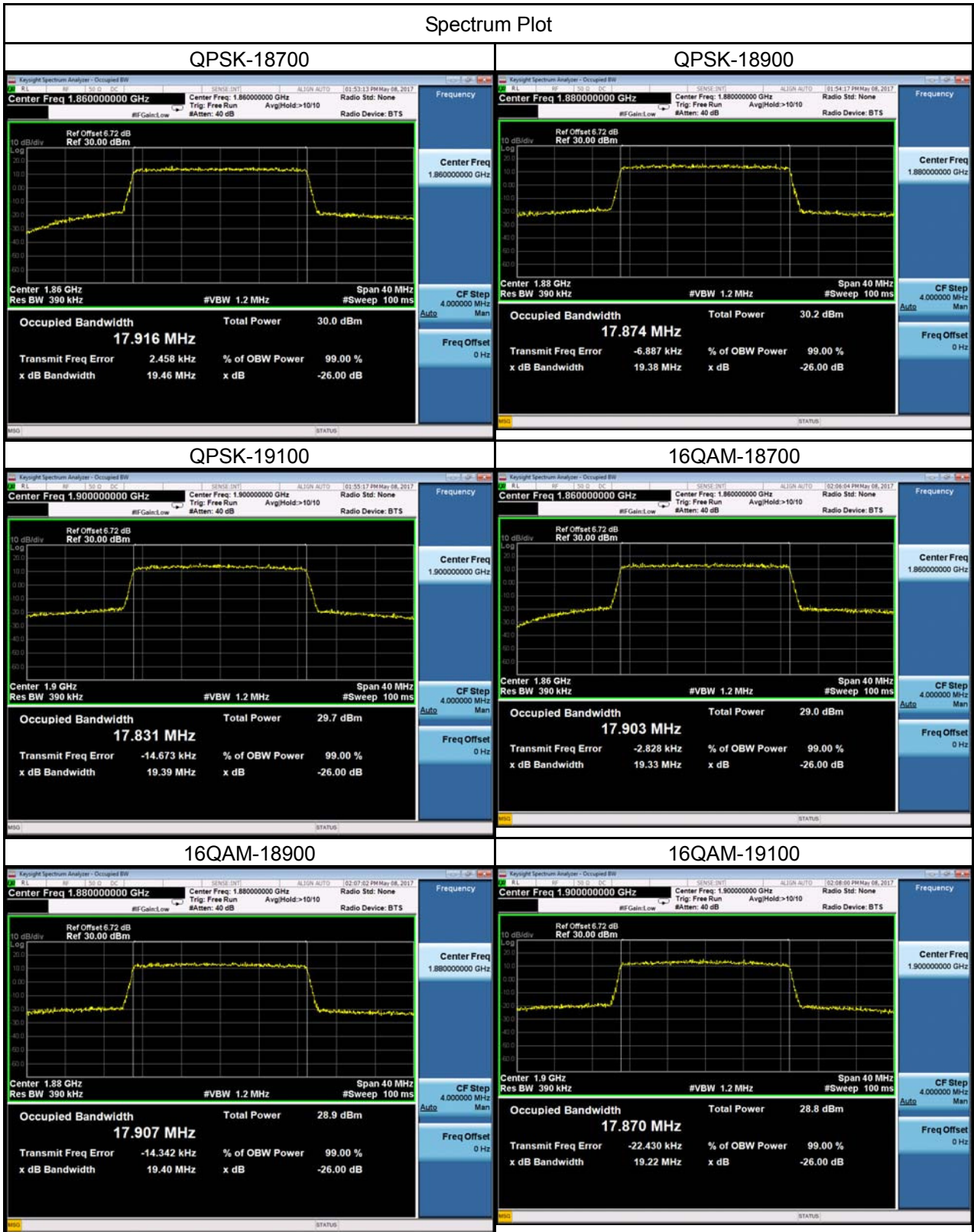

LTE Band 25_1.4M					
QPSK			16QAM		
Channel	Frequency (MHz)	99% Occupied Bandwidth (MHz)	Channel	Frequency (MHz)	99% Occupied Bandwidth (MHz)
26047	1850.7	1.0857	26047	1850.7	1.0925
26365	1882.5	1.0962	26365	1882.5	1.0891
26683	1914.3	1.001	26683	1914.3	1.0941
Channel	Frequency (MHz)	26dB Bandwidth (MHz)	Channel	Frequency (MHz)	26dB Bandwidth (MHz)
26047	1850.7	1.298	26047	1850.7	1.300
26365	1882.5	1.319	26365	1882.5	1.305
26683	1914.3	1.318	26683	1914.3	1.317

Spectrum Plot

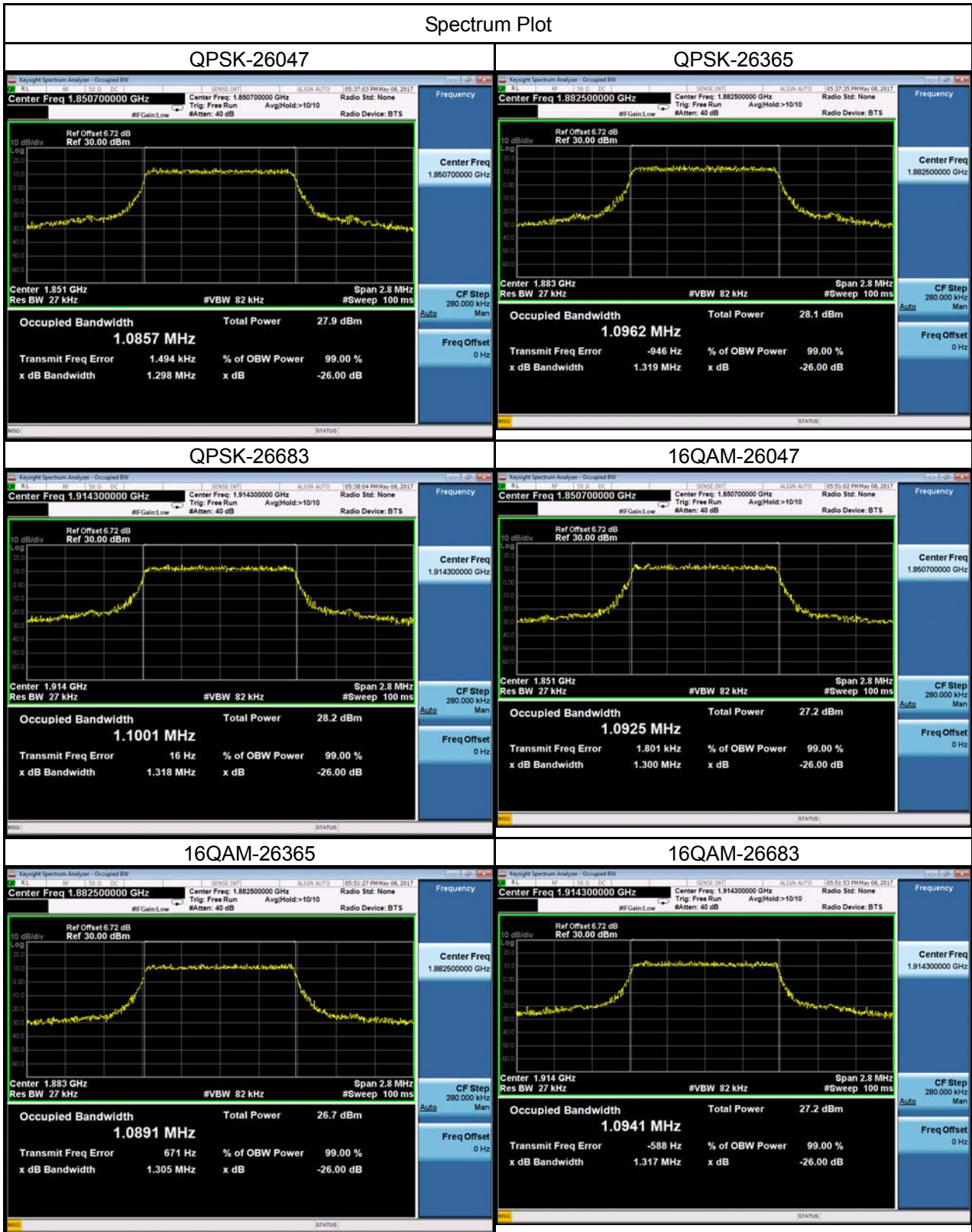

LTE Band 25_3M					
QPSK			16QAM		
Channel	Frequency (MHz)	99% Occupied Bandwidth (MHz)	Channel	Frequency (MHz)	99% Occupied Bandwidth (MHz)
26055	1851.5	2.6960	26055	1851.5	2.7053
26365	1882.5	2.7067	26365	1882.5	2.7012
26675	1913.5	2.7037	26675	1913.5	2.700
Channel	Frequency (MHz)	26dB Bandwidth (MHz)	Channel	Frequency (MHz)	26dB Bandwidth (MHz)
26055	1851.5	2.987	26055	1851.5	2.999
26365	1882.5	2.977	26365	1882.5	2.983
26675	1913.5	2.993	26675	1913.5	3.009

Spectrum Plot

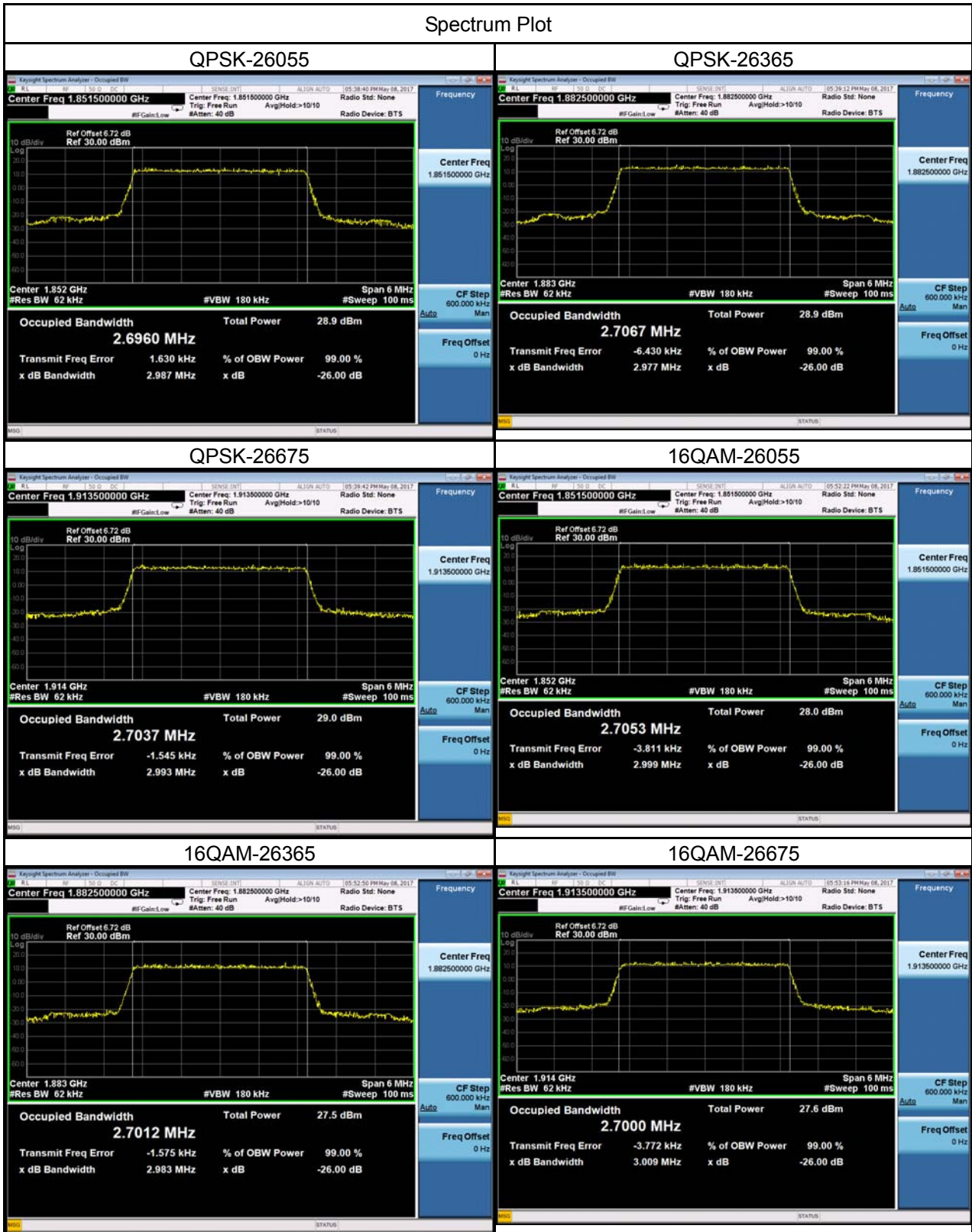

LTE Band 25_5M					
QPSK			16QAM		
Channel	Frequency (MHz)	99% Occupied Bandwidth (MHz)	Channel	Frequency (MHz)	99% Occupied Bandwidth (MHz)
26065	1852.5	4.5065	26065	1852.5	4.5045
26365	1882.5	4.5084	26365	1882.5	4.5106
26665	1912.5	4.5096	26665	1912.5	4.5076
Channel	Frequency (MHz)	26dB Bandwidth (MHz)	Channel	Frequency (MHz)	26dB Bandwidth (MHz)
26065	1852.5	5.015	26065	1852.5	4.990
26365	1882.5	4.989	26365	1882.5	4.971
26665	1912.5	4.999	26665	1912.5	4.945

Spectrum Plot

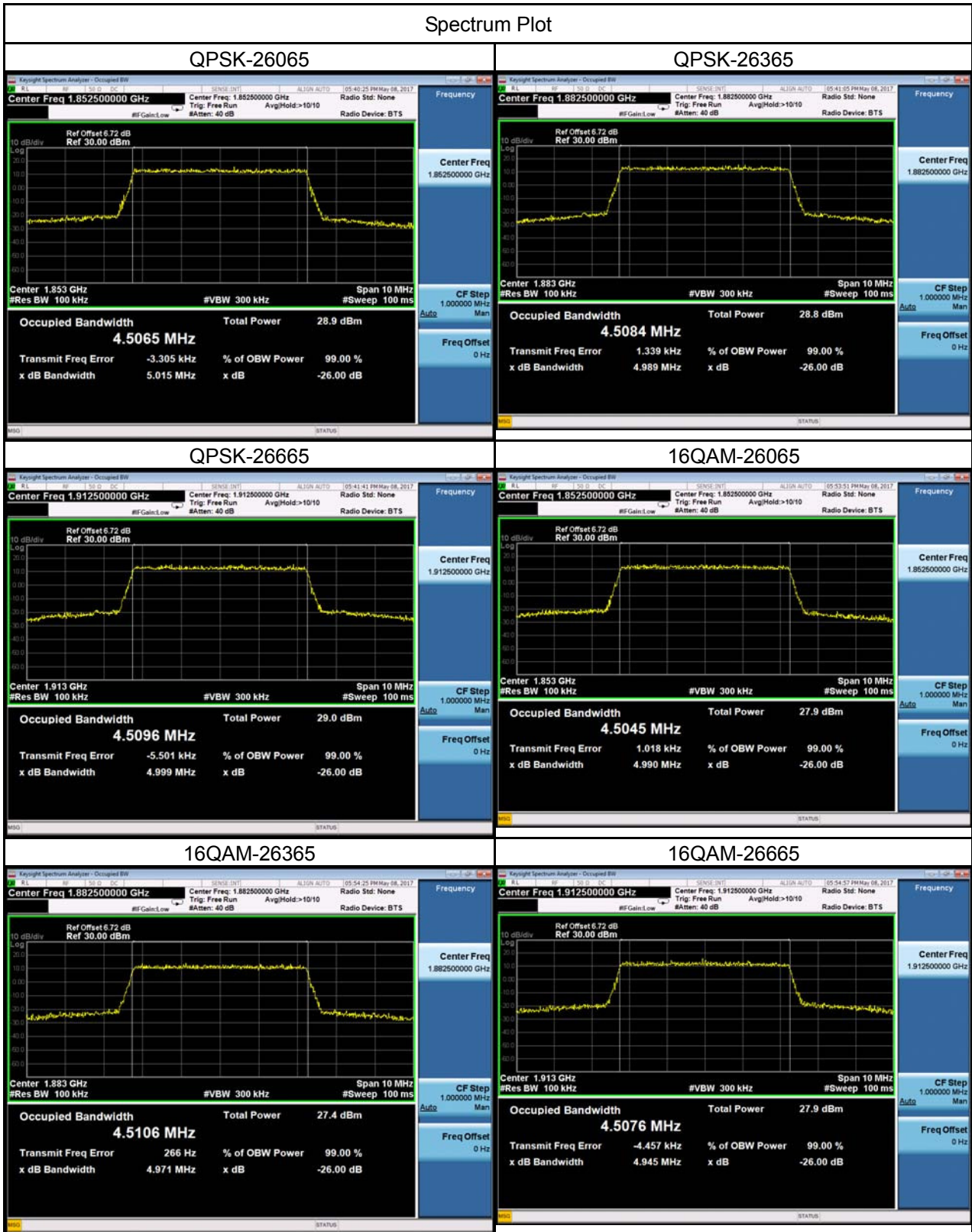

LTE Band 25_10M					
QPSK			16QAM		
Channel	Frequency (MHz)	99% Occupied Bandwidth (MHz)	Channel	Frequency (MHz)	99% Occupied Bandwidth (MHz)
26090	1855.0	8.9733	26090	1855.0	8.9572
26365	1882.5	8.9498	26365	1882.5	8.9591
26640	1910.0	8.9761	26640	1910.0	8.9705
Channel	Frequency (MHz)	26dB Bandwidth (MHz)	Channel	Frequency (MHz)	26dB Bandwidth (MHz)
26090	1855.0	9.985	26090	1855.0	9.876
26365	1882.5	9.855	26365	1882.5	9.767
26640	1910.0	9.865	26640	1910.0	9.922

Spectrum Plot

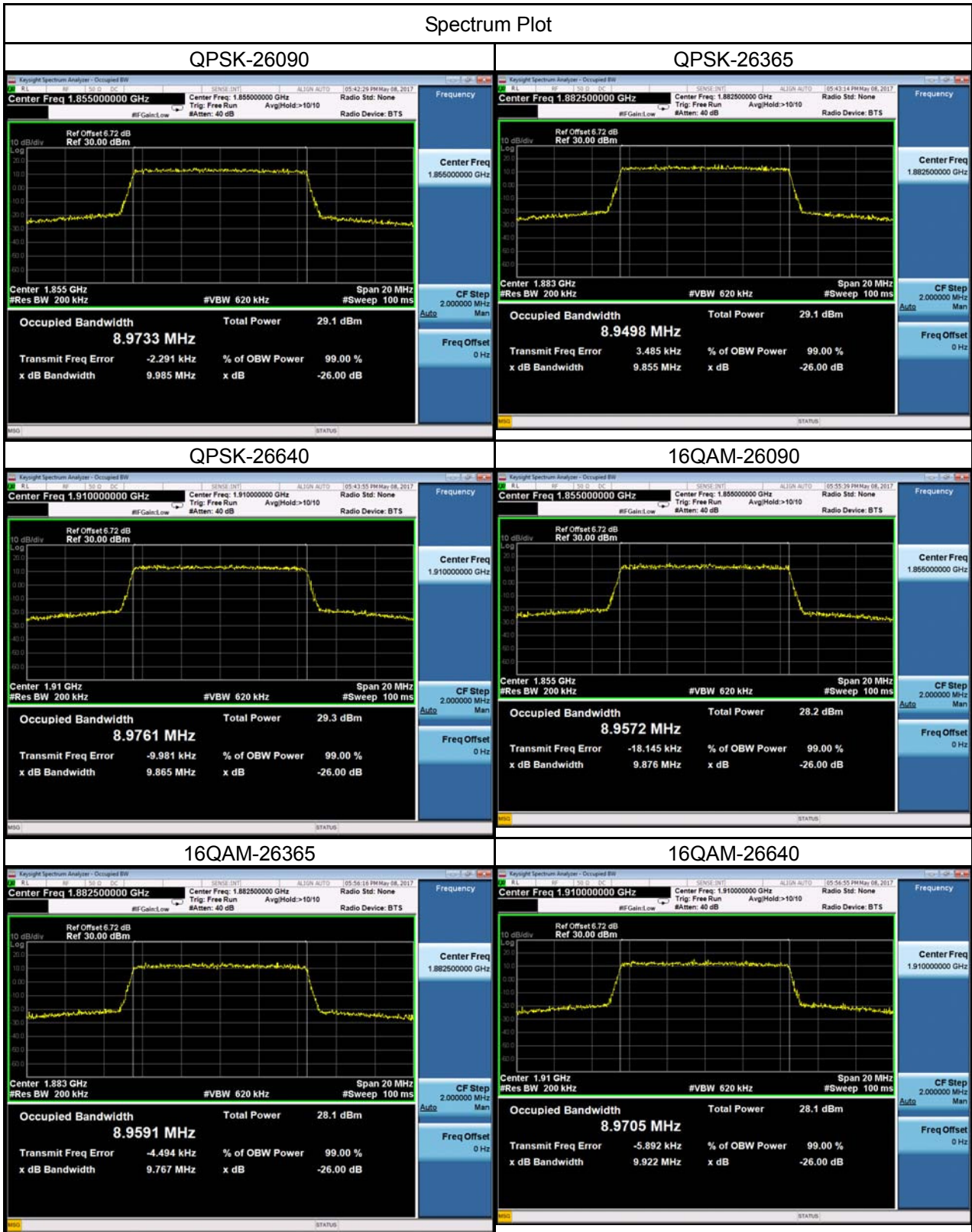

LTE Band 25_15M					
QPSK			16QAM		
Channel	Frequency (MHz)	99% Occupied Bandwidth (MHz)	Channel	Frequency (MHz)	99% Occupied Bandwidth (MHz)
26115	1857.5	13.451	26115	1857.5	13.438
26365	1882.5	14.436	26365	1882.5	13.426
26615	1907.5	13.429	26615	1907.5	13.410
Channel	Frequency (MHz)	26dB Bandwidth (MHz)	Channel	Frequency (MHz)	26dB Bandwidth (MHz)
26115	1857.5	14.64	26115	1857.5	14.62
26365	1882.5	14.62	26365	1882.5	14.71
26615	1907.5	14.64	26615	1907.5	14.63

Spectrum Plot

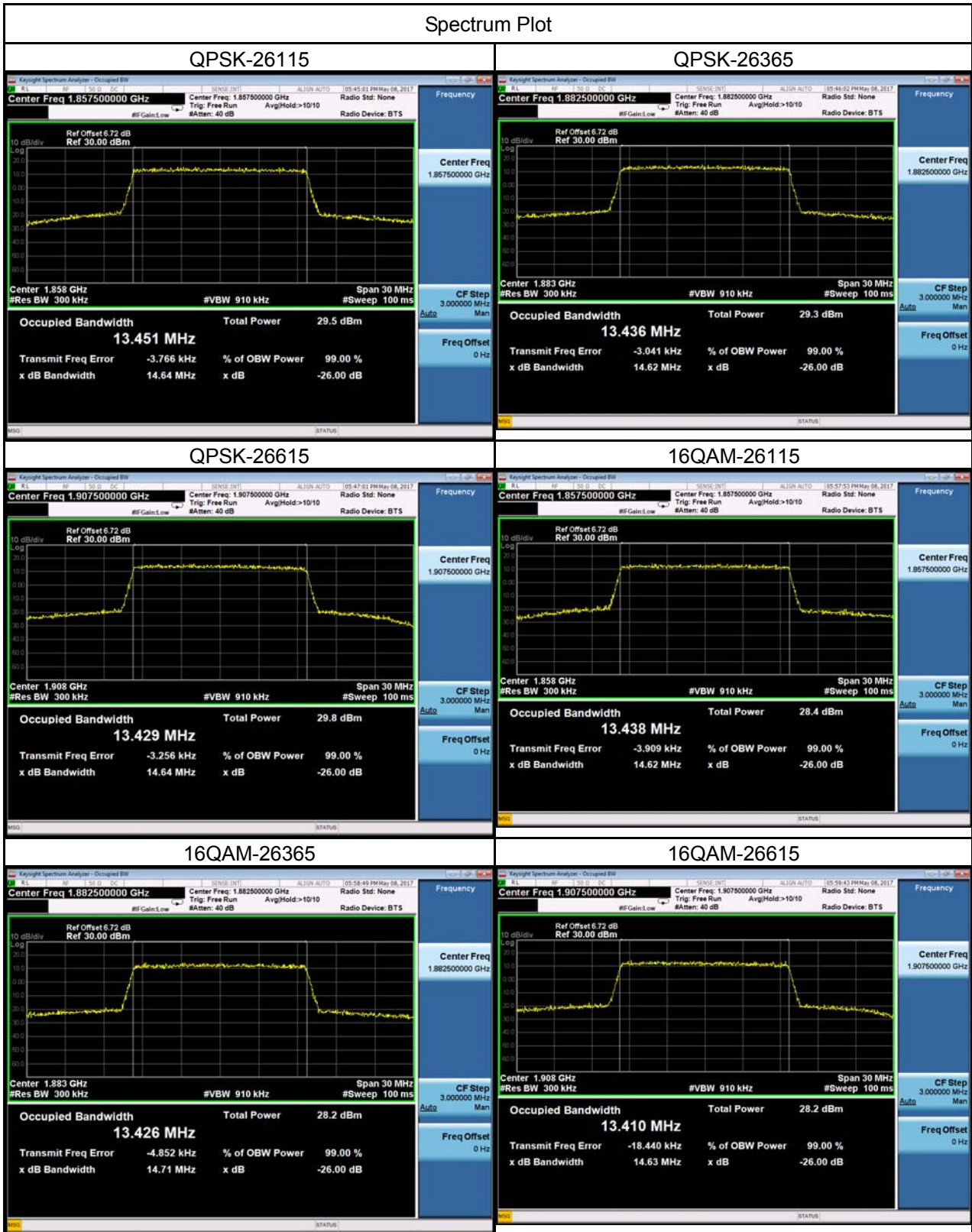

LTE Band 25_20M					
QPSK			16QAM		
Channel	Frequency (MHz)	99% Occupied Bandwidth (MHz)	Channel	Frequency (MHz)	99% Occupied Bandwidth (MHz)
26140	1860.0	17.921	26140	1860.0	17.901
26365	1882.5	17.886	26365	1882.5	17.910
26590	1905.0	17.852	26590	1905.0	17.843
Channel	Frequency (MHz)	26dB Bandwidth (MHz)	Channel	Frequency (MHz)	26dB Bandwidth (MHz)
26140	1860.0	19.46	26140	1860.0	19.36
26365	1882.5	19.41	26365	1882.5	19.41
26590	1905.0	19.36	26590	1905.0	19.30

Spectrum Plot

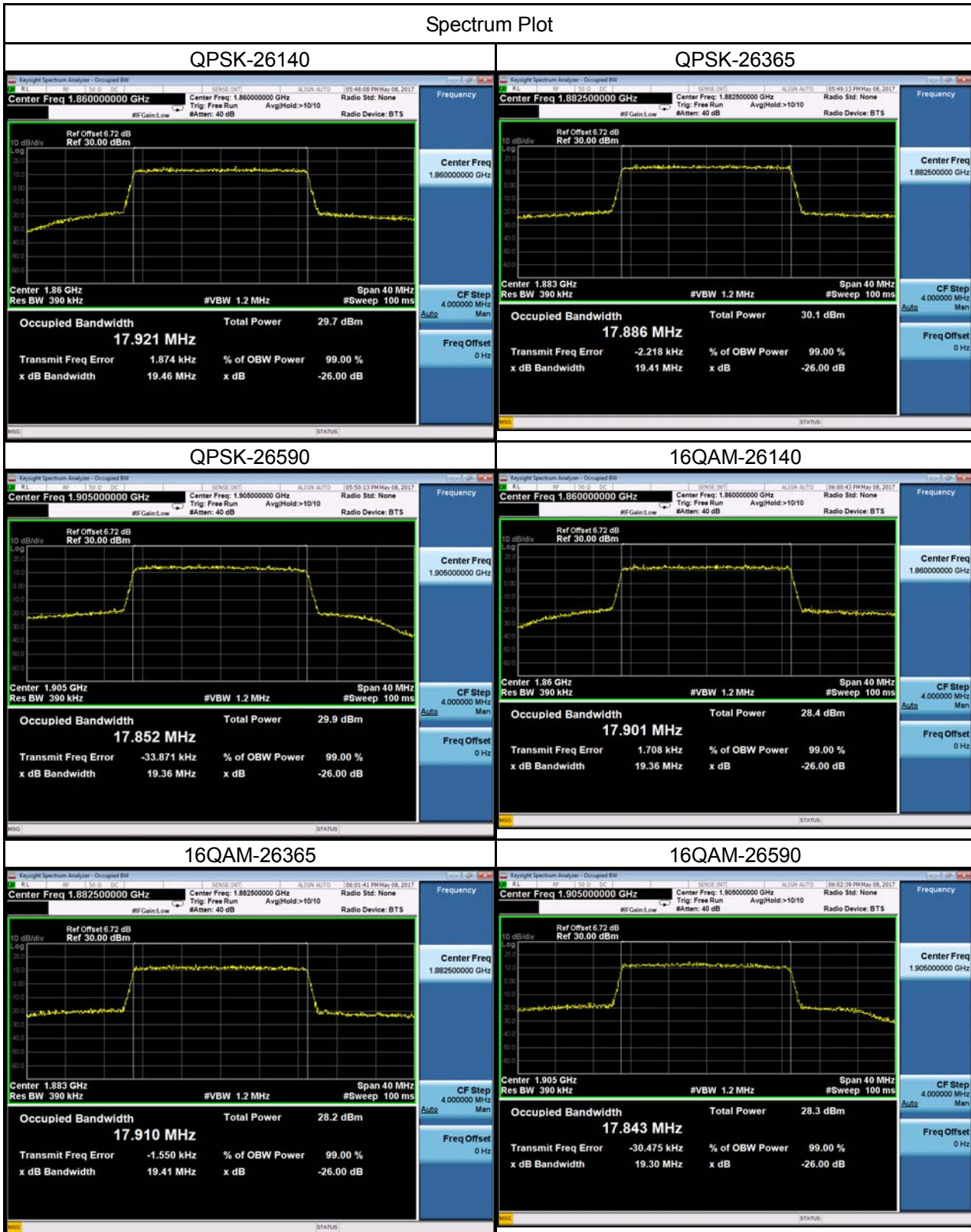

ATTACHMENT C - CONDUCTED EMISSIONS

DCS1900			
GSM		GSM	
Channel	Frequency(MHz)	Channel	Frequency(MHz)
661	1880	661	1880
Date: 28.APR.2017 18:56:04		Date: 28.APR.2017 19:10:51	
GSM		EDGE	
Channel	Frequency(MHz)	Channel	Frequency(MHz)
661	1880	661	1880
Date: 28.APR.2017 18:55:07		Date: 28.APR.2017 18:55:07	
EDGE		EDGE	
Channel	Frequency(MHz)	Channel	Frequency(MHz)
661	1880	661	1880
Date: 28.APR.2017 19:09:49		Date: 28.APR.2017 19:09:49	

WCDMA Band II

Channel	Frequency(MHz)	Channel	Frequency(MHz)
9400	1880	9400	1880
Date: 28.APR.2017 18:58:57		Date: 28.APR.2017 19:12:52	
Channel	Frequency(MHz)	-	-
9400	1880	-	-

WCDMA_HSDPA Band II

Channel	Frequency(MHz)	Channel	Frequency(MHz)
9400	1880	9400	1880

Channel	Frequency(MHz)		
9400	1880	-	-

Auto Tune

Center Freq 10.015000000 GHz

Start Freq 30.000000 MHz

Stop Freq 20.000000000 GHz

CF Step 1.997000000 GHz
Auto Man

Freq Offset 0 Hz

WCDMA_HSUPA Band II

Channel	Frequency(MHz)	Channel	Frequency(MHz)
9400	1880	9400	1880
Channel	Frequency(MHz)	-	-
9400	1880	-	-

LTE Band 2_1.4M

Channel	Frequency(MHz)	Channel	Frequency(MHz)
18900	1880	18900	1880
Date: 13.MAY.2017 10:07:31		Date: 13.MAY.2017 10:08:09	
Channel	Frequency(MHz)	-	-
18900	1880	-	-

LTE Band 2_3M

Channel	Frequency(MHz)	Channel	Frequency(MHz)
18900	1880	18900	1880
Date: 13.MAY.2017 10:09:34		Date: 13.MAY.2017 10:09:02	
Channel	Frequency(MHz)	-	-
18900	1880	-	-

LTE Band 2_5M

Channel	Frequency(MHz)	Channel	Frequency(MHz)
18900	1880	18900	1880
Date: 13.MAY.2017	10:03:07	Date: 13.MAY.2017	10:05:59
Channel	Frequency(MHz)	-	-
18900	1880	-	-

LTE Band 2_10M

Channel	Frequency(MHz)	Channel	Frequency(MHz)
18900	1880	18900	1880
Date: 13.MAY.2017 10:12:19		Date: 13.MAY.2017 12:31:27	
Channel	Frequency(MHz)	-	-
18900	1880	-	-

LTE Band 2_15M

Channel	Frequency(MHz)	Channel	Frequency(MHz)
18900	1880	18900	1880
Channel	Frequency(MHz)	-	-
18900	1880	-	-

LTE Band 2_20M

Channel	Frequency(MHz)	Channel	Frequency(MHz)
18900	1880	18900	1880
Channel	Frequency(MHz)	-	-
18900	1880	-	-

LTE Band 25_1.4M

Channel	Frequency(MHz)	Channel	Frequency(MHz)
26365	1882.5	26365	1882.5
Channel	Frequency(MHz)	-	-
26365	1882.5	-	-

LTE Band 25_3M

Channel	Frequency(MHz)	Channel	Frequency(MHz)
26365	1882.5	26365	1882.5

Date: 13.MAY.2017 11:38:36 Date: 13.MAY.2017 11:38:11

Channel	Frequency(MHz)		
26365	1882.5	-	-

Frequency

Auto Tune

Center Freq
9.427500000 GHz

Start Freq
30.00000000 MHz

Stop Freq
18.825000000 GHz

CF Step
1.879500000 GHz

Freq Offset
0 Hz

Scale Type
Log

Center Freq 9.427500000 GHz Mkr1 5.650 GHz -17.43 dBm

Start 30 MHz #VBW 3.0 MHz Stop 18.825 GHz

#Res BW 1.0 MHz Sweep 31.33 ms (1001 pts)

LTE Band 25_5M

Channel	Frequency(MHz)	Channel	Frequency(MHz)
26365	1882.5	26365	1882.5

Date: 13.MAY.2017 11:36:28

Date: 13.MAY.2017 11:36:49

Channel	Frequency(MHz)	-	-
26365	1882.5	-	-

Frequency

Auto Tune

Center Freq
9.427500000 GHz

Start Freq
30.0000000 MHz

Stop Freq
18.825000000 GHz

CF Step
1.879500000 GHz

Freq Offset
0 Hz

Scale Type
Log

LTE Band 25_10M

Channel	Frequency(MHz)	Channel	Frequency(MHz)
26365	1882.5	26365	1882.5

Date: 13.MAY.2017 11:38:55

Date: 13.MAY.2017 11:39:12

Channel	Frequency(MHz)		
26365	1882.5	-	-

Center Freq 9.427500000 GHz
Start Freq 30.00000000 MHz
Stop Freq 18.825000000 GHz
CF Step 1.879500000 GHz
Mkr1 5.631 GHz -18.89 dBm

Auto Tune

Center Freq
9.427500000 GHz

Start Freq
30.000000 MHz

Stop Freq
18.825000000 GHz

CF Step
1.879500000 GHz

Freq Offset
0 Hz

Scale Type
Log

LTE Band 25_15M

Channel	Frequency(MHz)	Channel	Frequency(MHz)
26365	1882.5	26365	1882.5

Date: 13.MAY.2017 11:40:07

Date: 13.MAY.2017 11:40:25

Channel	Frequency(MHz)	-	-
26365	1882.5	-	-

Center Freq 9.427500000 GHz

Mkr1 5.631 GHz -21.25 dBm

Start 30 MHz, #Res BW 1.0 MHz, #VBW 3.0 MHz, Sweep 31.33 ms (1001 pts)

LTE Band 25_20M

Channel	Frequency(MHz)	Channel	Frequency(MHz)
26365	1882.5	26365	1882.5

Date: 13.MAY.2017 11:41:16

Date: 13.MAY.2017 11:40:55

Channel	Frequency(MHz)	-	-
26365	1882.5	-	-

Frequency

Auto Tune

Center Freq
9.427500000 GHz

Start Freq
30.000000 MHz

Stop Freq
18.825000000 GHz

CF Step
1.879500000 GHz

Freq Offset
0 Hz

Scale Type
Log

ATTACHMENT D - RADIATED EMISSION

Test Mode: TX Mode (Adapter: PHITEK)

Ant 0°

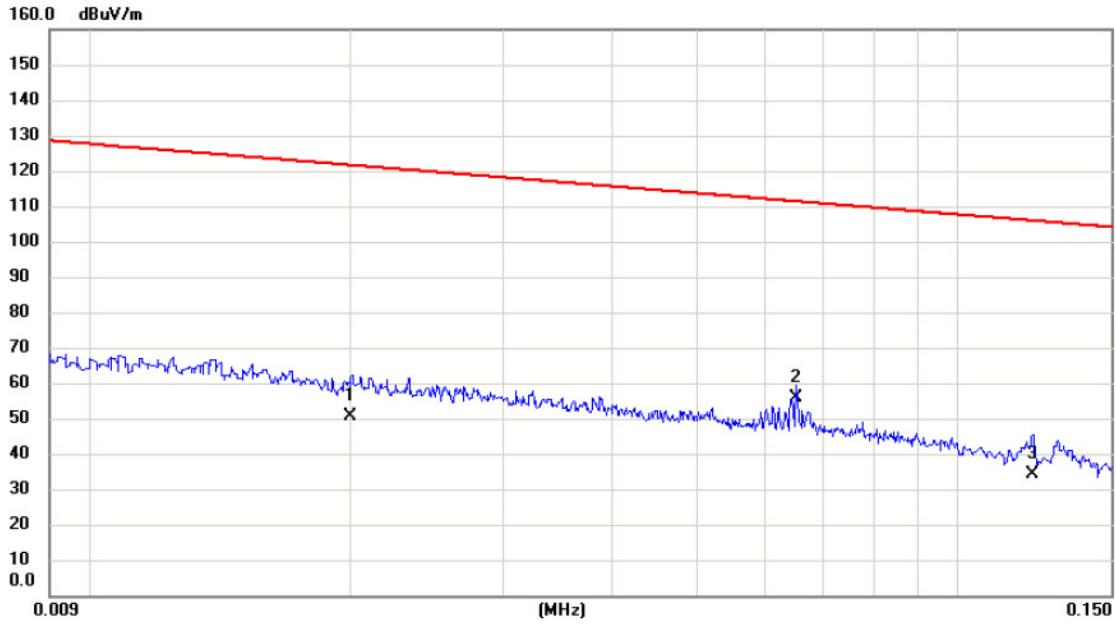

No.	Mk.	Freq.	Reading Level	Correct Factor	Measurement	Limit	Margin	Detector	Comment
		MHz	dBuV	dB	dBuV/m	dBuV/m	dB		
1		0.0200	30.80	19.62	50.42	121.58	-71.16	AVG	
2	*	0.0652	37.30	18.43	55.73	111.32	-55.59	AVG	
3		0.1218	16.80	17.32	34.12	105.89	-71.77	AVG	

Test Mode: TX Mode (Adapter: PHITEK)

Ant 0°

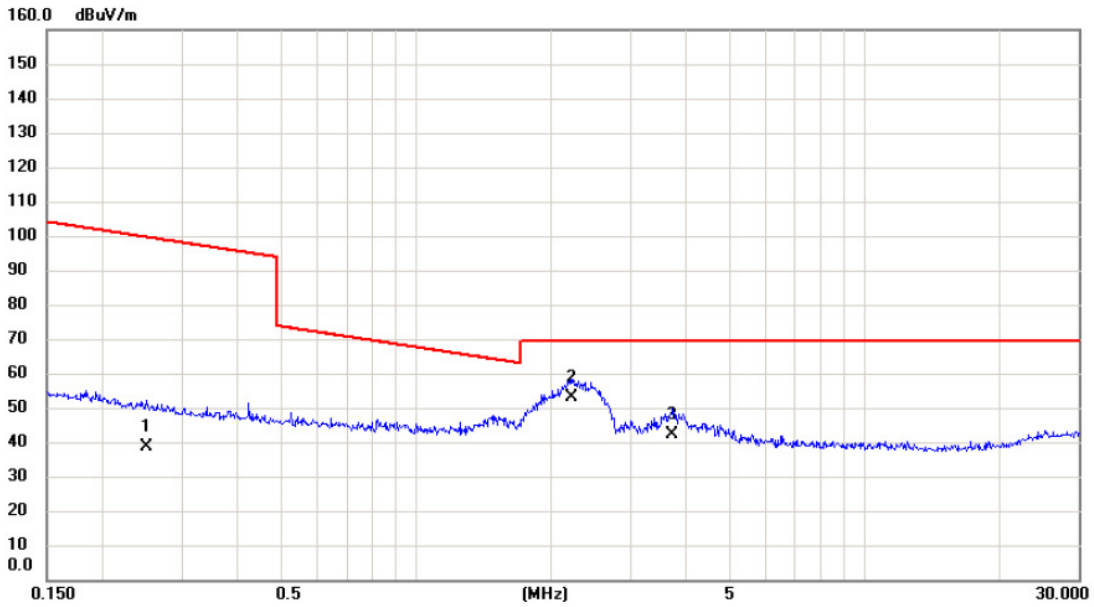

No.	Mk.	Freq. MHz	Reading Level dBuV	Correct Factor dB	Measure- ment dBuV/m	Limit dBuV/m	Margin dB	Detector	Comment
1		0.2508	22.10	16.65	38.75	99.62	-60.87	AVG	
2	*	2.2250	37.70	15.44	53.14	69.54	-16.40	QP	
3		3.7198	27.30	15.03	42.33	69.54	-27.21	QP	

Test Mode: TX Mode (Adapter: PHITEK)

Ant 90°

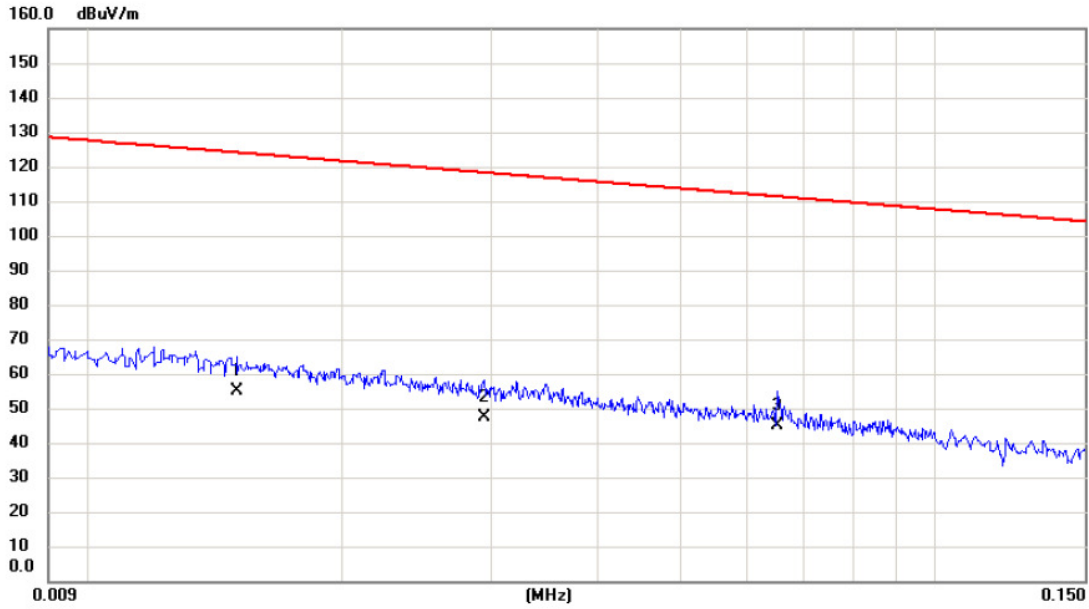

No.	Mk.	Freq.	Reading Level	Correct Factor	Measurement	Limit	Margin	Detector	Comment
		MHz	dBuV	dB	dBuV/m	dBuV/m	dB		
1		0.0150	34.65	20.27	54.92	124.08	-69.16	AVG	
2		0.0294	28.03	19.34	47.37	118.24	-70.87	AVG	
3	*	0.0652	26.77	18.43	45.20	111.32	-66.12	AVG	

Test Mode: TX Mode (Adapter: PHITEK)

Ant 90°

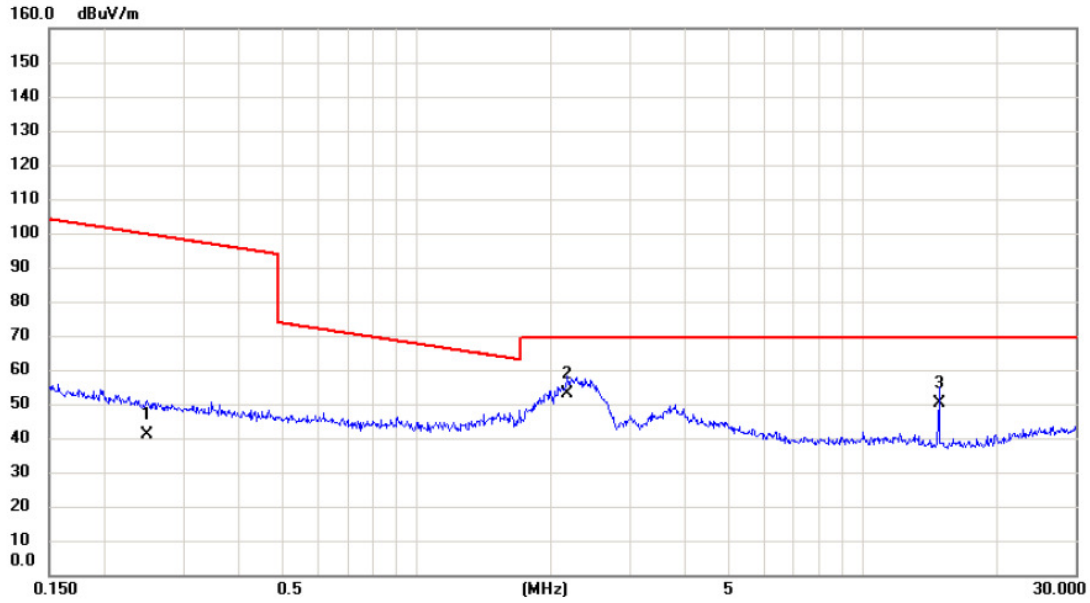

No.	Mk.	Freq. MHz	Reading Level dBuV	Correct Factor dB	Measure- ment dBuV/m	Limit dBuV/m	Margin dB	Detector	Comment
1		0.2481	24.36	16.66	41.02	99.71	-58.69	AVG	
2	*	2.1783	37.73	15.46	53.19	69.54	-16.35	QP	
3		14.8281	36.10	14.08	50.18	69.54	-19.36	QP	

Test Mode: TX Mode (Adapter: HUNTKEY)

Ant 0°

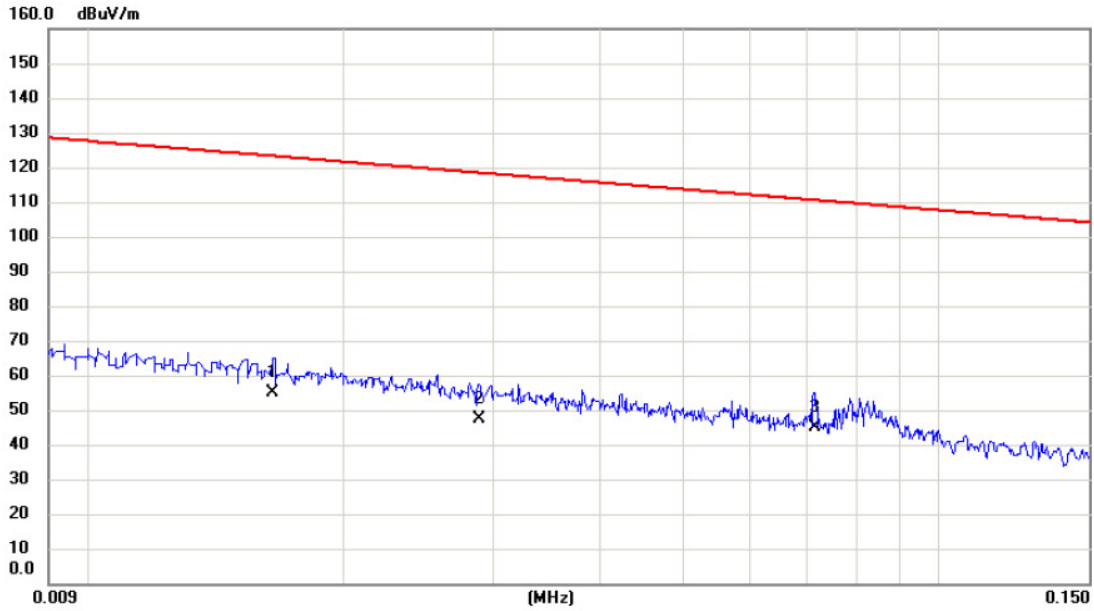

No.	Mk.	Freq.	Reading Level	Correct Factor	Measurement	Limit	Margin	Detector	Comment
		MHz	dBuV	dB	dBuV/m	dBuV/m	dB		
1		0.0165	35.03	20.07	55.10	123.26	-68.16	AVG	
2		0.0288	27.98	19.36	47.34	118.42	-71.08	AVG	
3	*	0.0716	26.83	18.30	45.13	110.51	-65.38	AVG	

Test Mode: TX Mode (Adapter: HUNTKEY)

Ant 0°

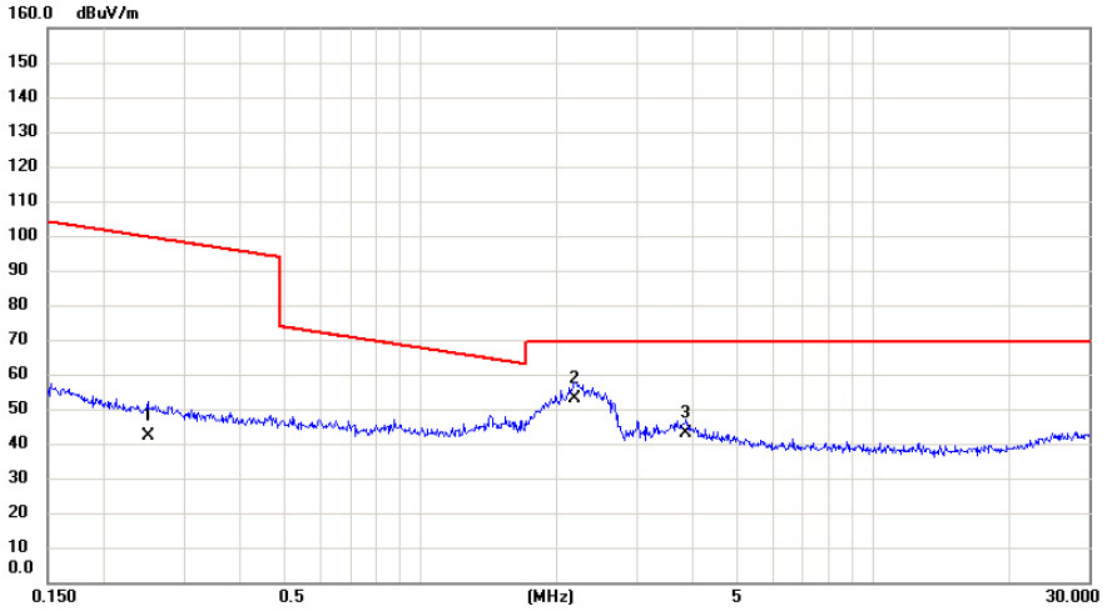

No. Mk.	Freq. MHz	Reading Level dBuV	Correct Factor dB	Measure- ment dBuV/m	Limit dBuV/m	Margin dB	Detector	Comment
1	0.2508	25.48	16.65	42.13	99.62	-57.49	AVG	
2 *	2.1898	37.36	15.45	52.81	69.54	-16.73	QP	
3	3.8603	27.87	14.99	42.86	69.54	-26.68	QP	

Test Mode: TX Mode (Adapter: HUNTKEY)

Ant 90°

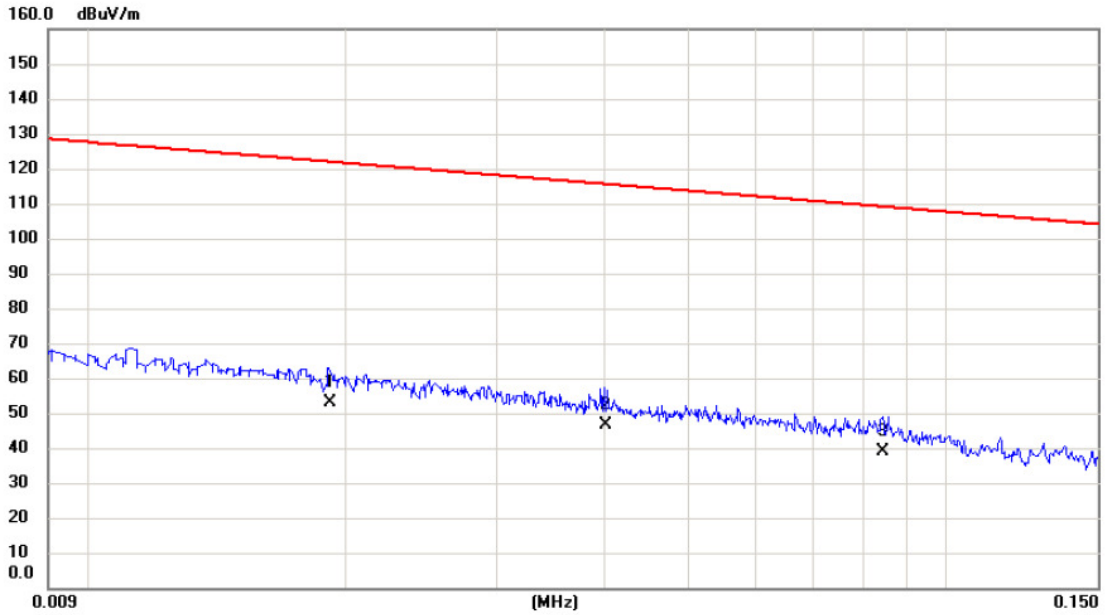

No.	Mk.	Freq. MHz	Reading Level dBuV	Correct Factor dB	Measure- ment dBuV/m	Limit dBuV/m	Margin dB	Detector	Comment
1	*	0.0192	33.41	19.72	53.13	121.94	-68.81	AVG	
2		0.0401	27.41	19.02	46.43	115.54	-69.11	AVG	
3		0.0844	21.18	18.00	39.18	109.08	-69.90	AVG	

Test Mode: TX Mode (Adapter: HUNTKEY)

Ant 90°

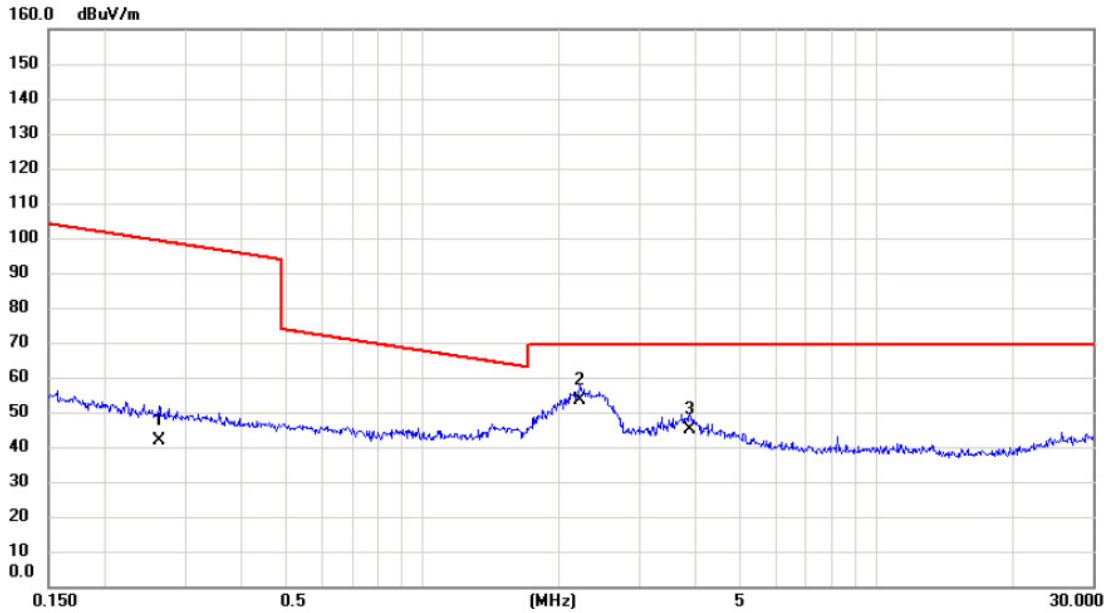

No.	Mk.	Freq. MHz	Reading Level dBuV	Correct Factor dB	Measure- ment dBuV/m	Limit dBuV/m	Margin dB	Detector	Comment
1		0.2630	25.09	16.64	41.73	99.21	-57.48	AVG	
2	*	2.2250	37.84	15.44	53.28	69.54	-16.26	QP	
3		3.8808	29.90	14.99	44.89	69.54	-24.65	QP	

Test Mode: TX Mode (Adapter: BYD)

Ant 0°

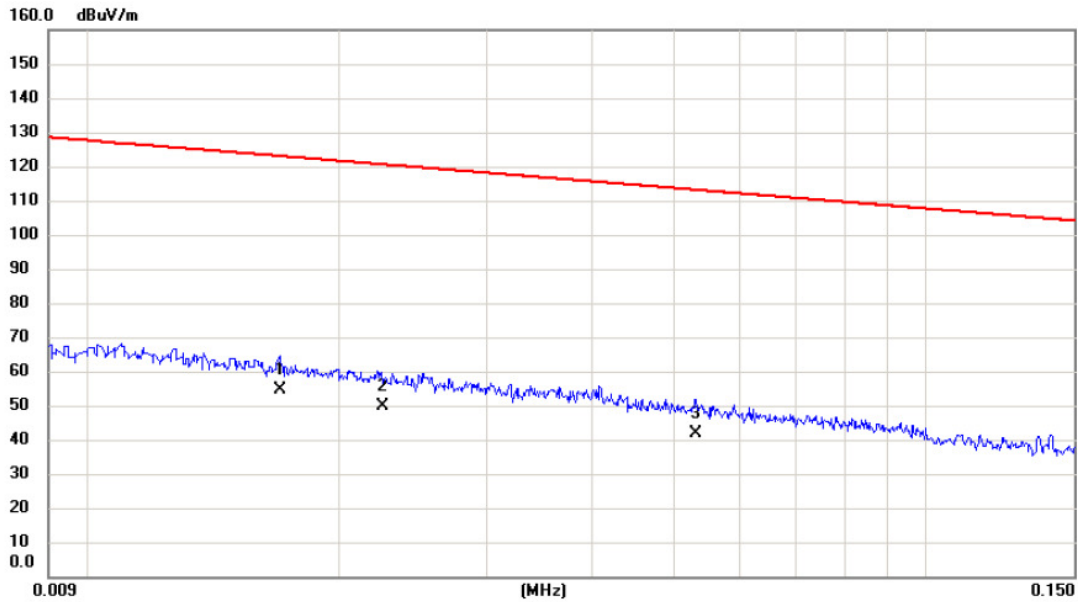

No.	Mk.	Freq. MHz	Reading Level dBuV	Correct Factor dB	Measure- ment dBuV/m	Limit dBuV/m	Margin dB	Detector	Comment
1	*	0.0170	34.54	20.01	54.55	123.00	-68.45	AVG	
2		0.0225	30.18	19.55	49.73	120.56	-70.83	AVG	
3		0.0531	23.18	18.66	41.84	113.10	-71.26	AVG	

Test Mode: TX Mode (Adapter: BYD)

Ant 0°

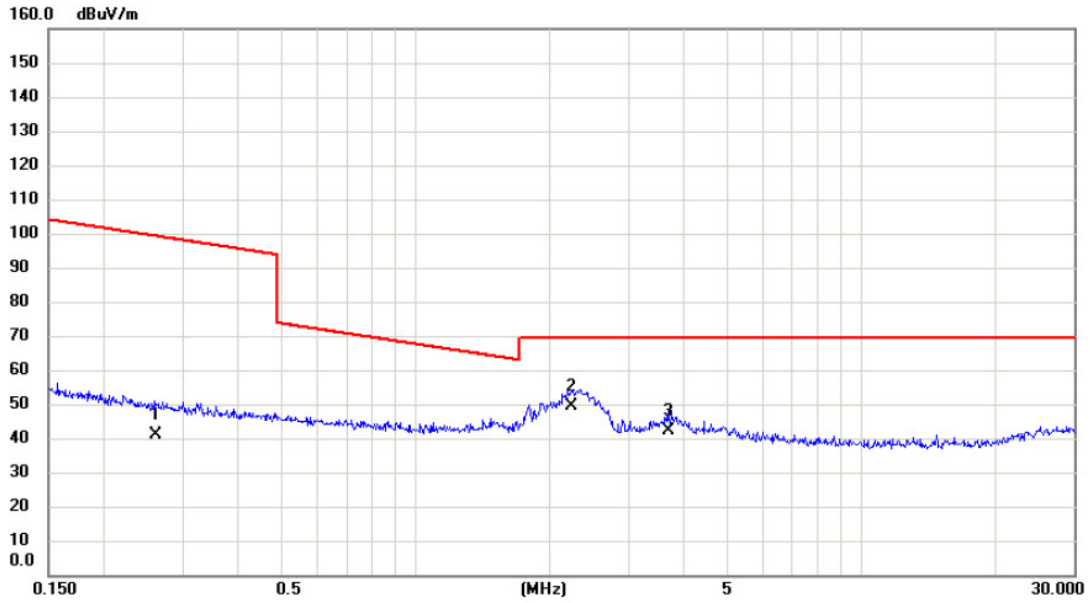

No.	Mk.	Freq. MHz	Reading Level dBuV	Correct Factor dB	Measure- ment dBuV/m	Limit dBuV/m	Margin dB	Detector	Comment
1		0.2603	24.23	16.64	40.87	99.30	-58.43	AVG	
2	*	2.2367	33.93	15.44	49.37	69.54	-20.17	QP	
3		3.6806	27.25	15.05	42.30	69.54	-27.24	QP	

Test Mode: TX Mode (Adapter: BYD)

Ant 90°

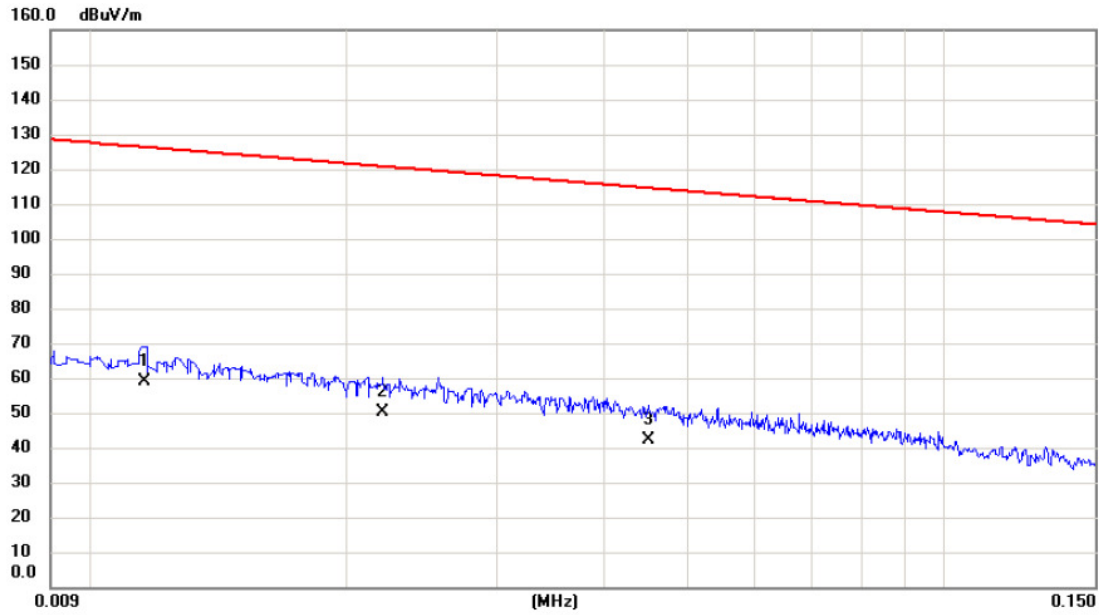

No.	Mk.	Freq.	Reading Level	Correct Factor	Measurement	Limit	Margin	Detector	Comment
		MHz	dBuV	dB	dBuV/m	dBuV/m	dB		
1	*	0.0116	38.26	20.71	58.97	126.32	-67.35	AVG	
2		0.0220	30.55	19.56	50.11	120.76	-70.65	AVG	
3		0.0450	23.15	18.87	42.02	114.54	-72.52	AVG	

Test Mode: TX Mode (Adapter: BYD)

Ant 90°

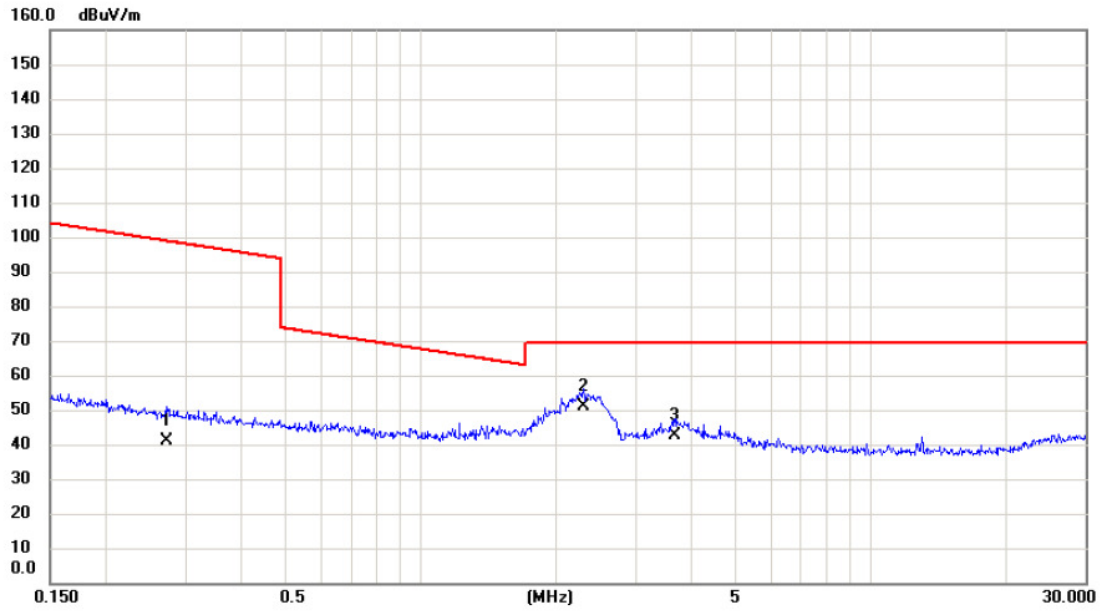

No.	Mk.	Freq. MHz	Reading Level dBuV	Correct Factor dB	Measure- ment dBuV/m	Limit dBuV/m	Margin dB	Detector	Comment
1		0.2730	24.40	16.63	41.03	98.88	-57.85	AVG	
2	*	2.2968	35.66	15.42	51.08	69.54	-18.46	QP	
3		3.6611	27.46	15.05	42.51	69.54	-27.03	QP	

Test Mode: DCS1900_TX CH512_GSM

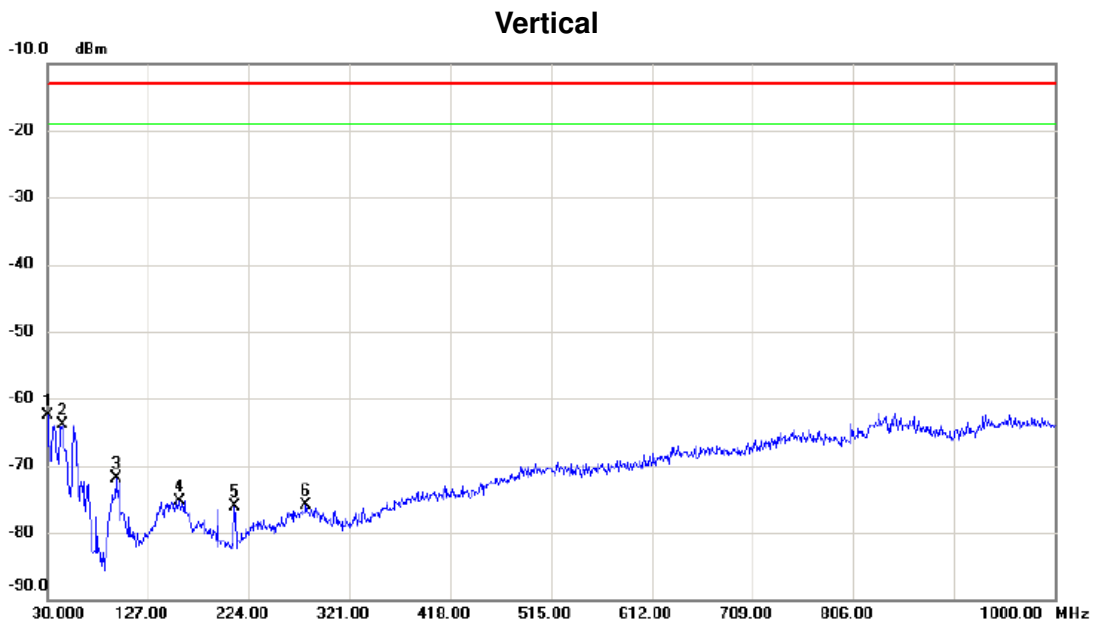

No.	Mk.	Freq. MHz	Reading Level dBm	Correct Factor dB	Measure- ment dBm	Limit dBm	Margin dB	Detector	Comment
1	*	30.000	-62.24	-0.26	-62.50	-13.00	-49.50	peak	
2		44.550	-65.94	1.96	-63.98	-13.00	-50.98	peak	
3		95.960	-68.76	-3.14	-71.90	-13.00	-58.90	peak	
4		157.070	-78.50	3.17	-75.33	-13.00	-62.33	peak	
5		210.420	-73.71	-2.44	-76.15	-13.00	-63.15	peak	
6		279.290	-78.49	2.62	-75.87	-13.00	-62.87	peak	

Test Mode: DCS1900_TX CH512_GSM

Horizontal

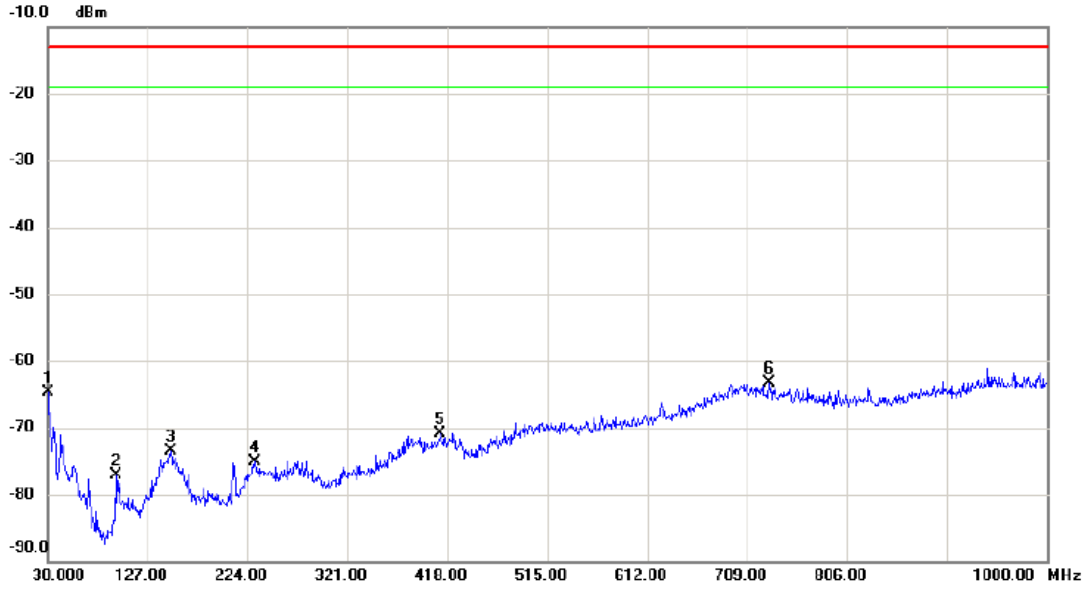

No.	Mk.	Freq. MHz	Reading Level dBm	Correct Factor dB	Measure- ment dBm	Limit dBm	Margin dB	Detector	Comment
1		30.000	-66.61	1.88	-64.73	-13.00	-51.73	peak	
2		95.960	-71.21	-5.81	-77.02	-13.00	-64.02	peak	
3		149.310	-77.62	4.16	-73.46	-13.00	-60.46	peak	
4		230.790	-78.33	3.18	-75.15	-13.00	-62.15	peak	
5		411.210	-77.26	6.44	-70.82	-13.00	-57.82	peak	
6	*	730.340	-76.49	13.25	-63.24	-13.00	-50.24	peak	

Test Mode: DCS1900_TX CH512_GSM

Vertical

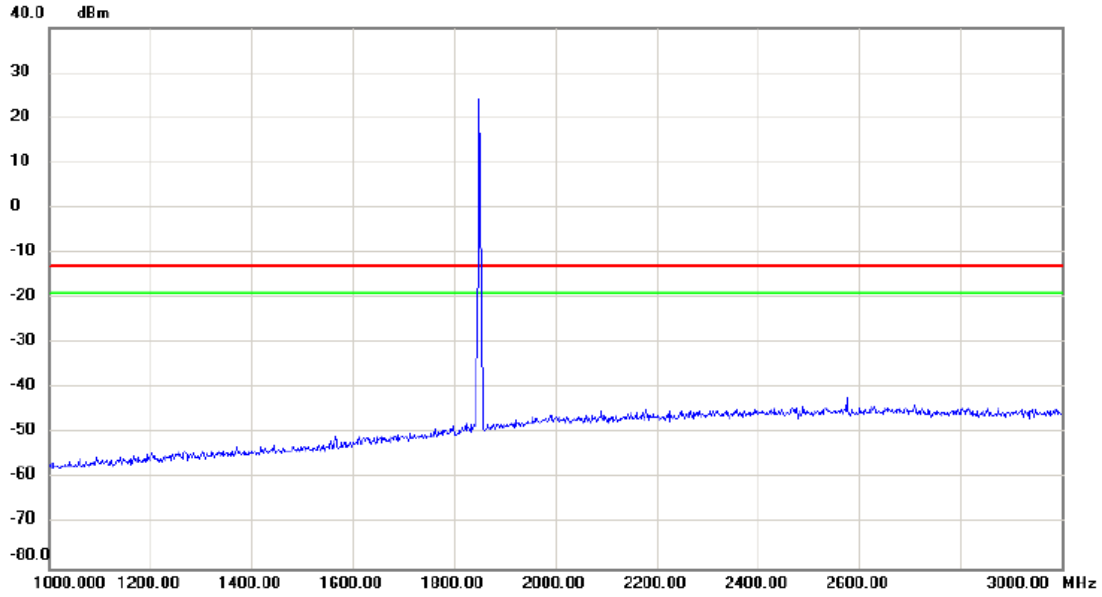

No.	Mk.	Freq. MHz	Reading Level dBm	Correct Factor dB	Measure- ment dBm	Limit dBm	Margin dB	Detector	Comment
		1930.00	25.00	0.00	25.00	-15.00	40.00		

Test Mode: DCS1900_TX CH512_GSM

Horizontal

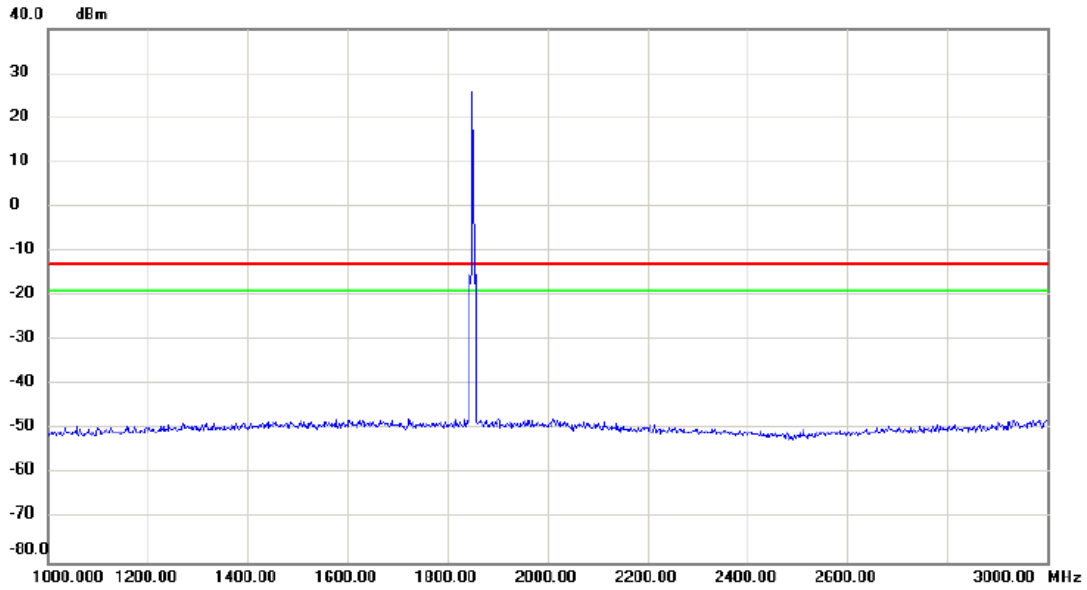

No.	Mk.	Freq.	Reading Level	Correct Factor	Measurement	Limit	Margin	Detector	Comment
		MHz	dBm	dB	dBm	dBm	dB		
		1880.00	25.00	0.00	25.00	-15.00	40.00		

Test Mode: DCS1900_TX CH512_GSM

Vertical

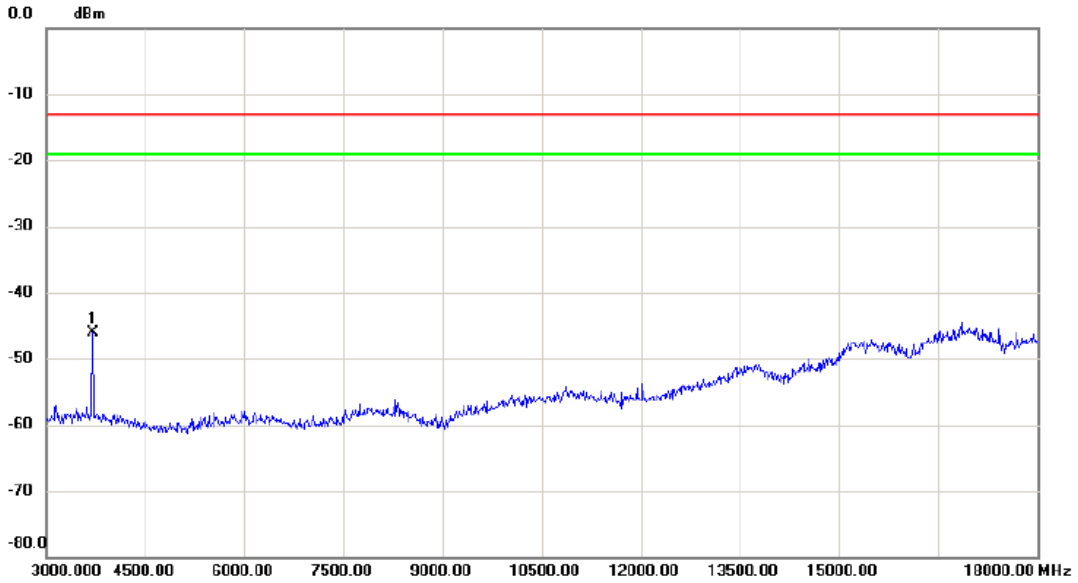

No.	Mk.	Freq.	Reading Level	Correct Factor	Measurement	Limit	Margin	Detector	Comment
		MHz	dBm	dB	dBm	dBm	dB		
1	*	3705.000	-60.59	14.46	-46.13	-13.00	-33.13	peak	

Test Mode: DCS1900_TX CH512_GSM

Horizontal

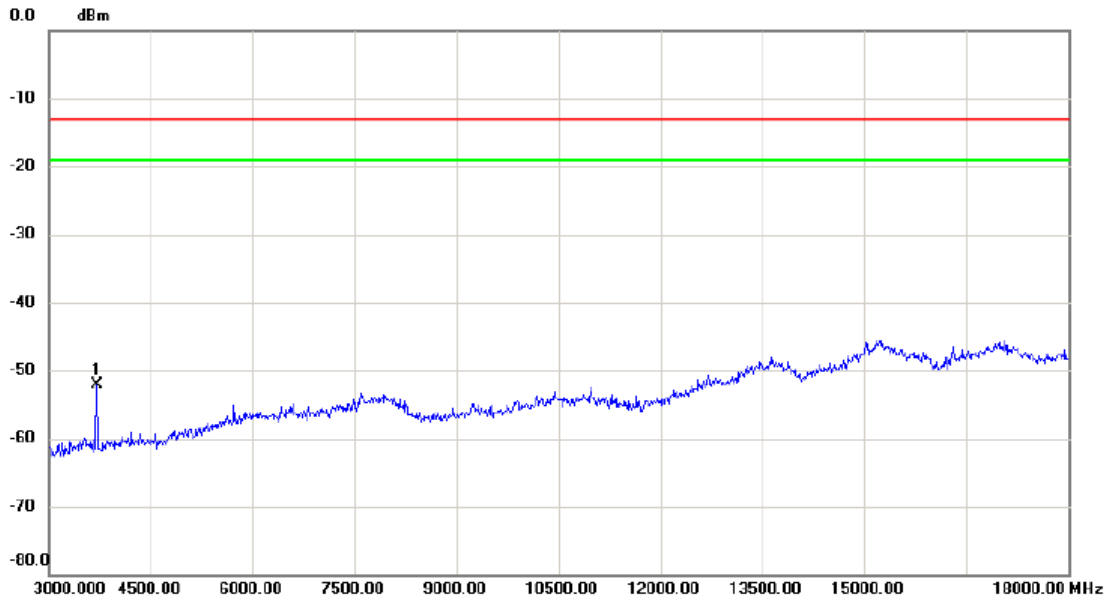

No.	Mk.	Freq. MHz	Reading Level dBm	Correct Factor dB	Measure- ment dBm	Limit dBm	Margin dB	Detector	Comment
1	*	3705.000	-63.34	11.19	-52.15	-13.00	-39.15	peak	

Test Mode: DCS1900_TX CH512_GSM

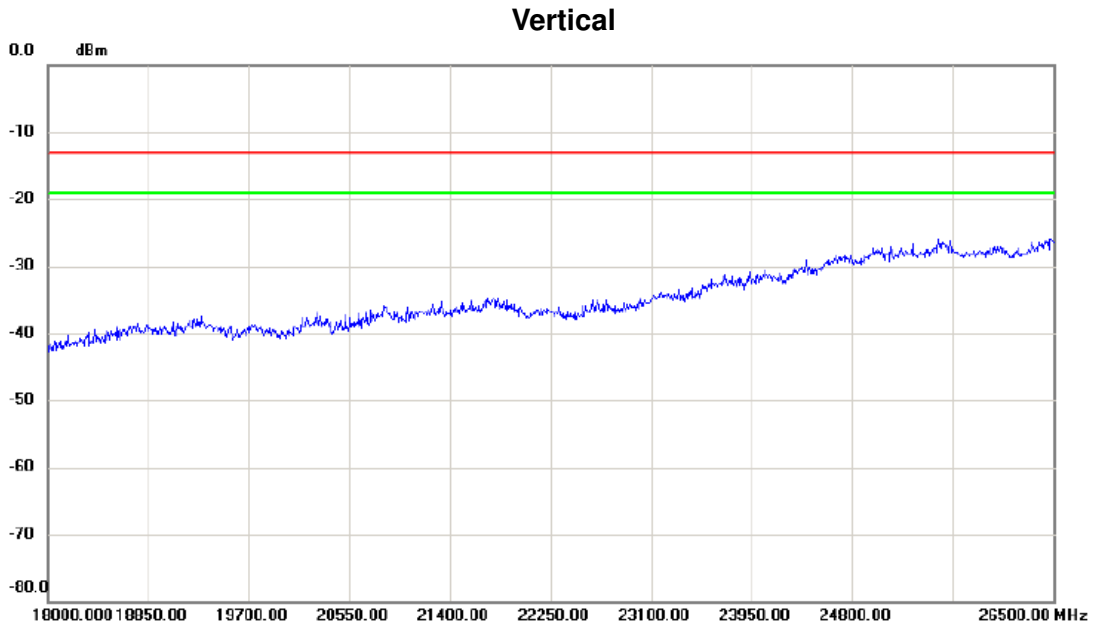

No.	Mk.	Freq.	Reading Level	Correct Factor	Measurement	Limit	Margin	Detector	Comment
		MHz	dBm	dB	dBm	dBm	dB		
		18000.00	-45						
		18950.00	-45						
		19700.00	-45						
		20550.00	-45						
		21400.00	-45						
		22250.00	-45						
		23100.00	-45						
		23950.00	-45						
		24800.00	-45						
		25650.00	-45						

Test Mode: DCS1900_TX CH512_GSM

Horizontal

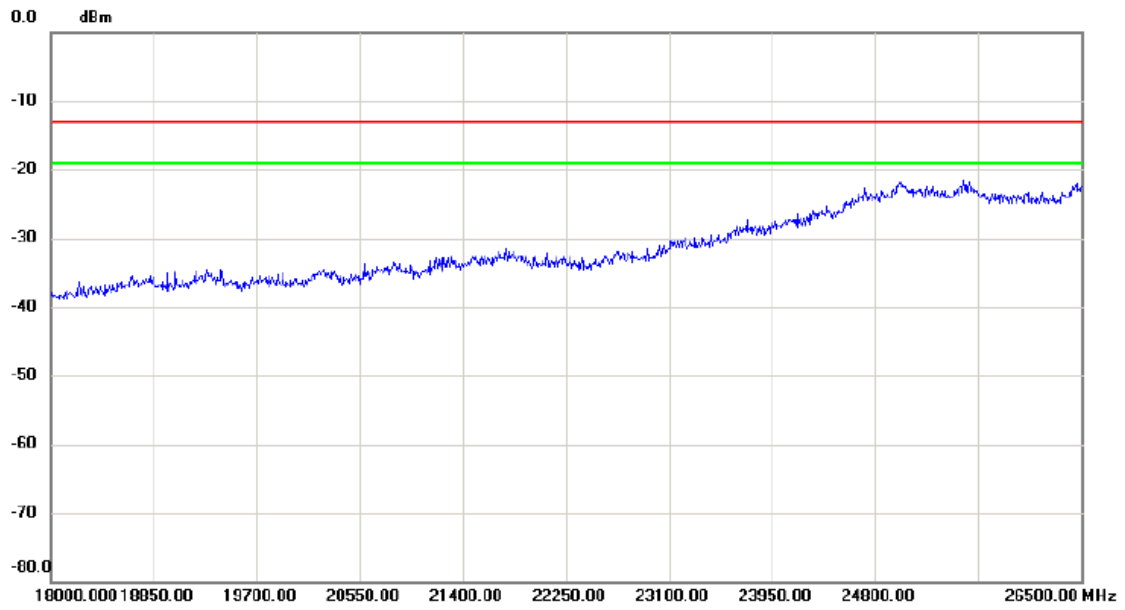

No.	Mk.	Freq.	Reading Level	Correct Factor	Measurement	Limit	Margin	Detector	Comment
		MHz	dBm	dB	dBm	dBm	dB		

Test Mode: DCS1900_TX CH512_EDGE

Vertical

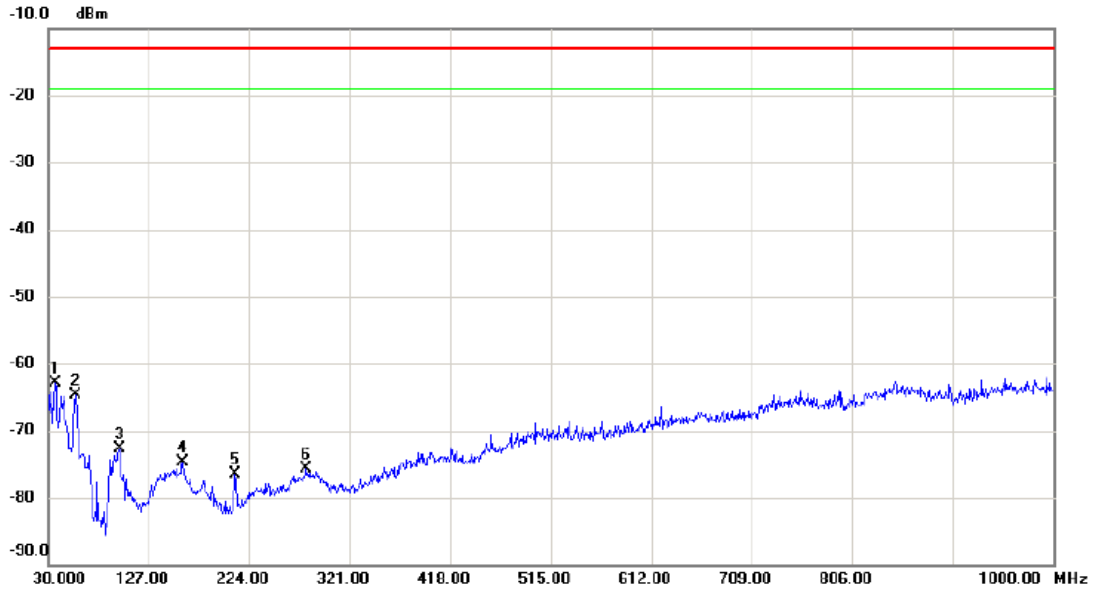

No.	Mk.	Freq. MHz	Reading Level dBm	Correct Factor dB	Measure- ment dBm	Limit dBm	Margin dB	Detector	Comment
1	*	36.790	-62.74	-0.18	-62.92	-13.00	-49.92	peak	
2		56.190	-66.83	2.18	-64.65	-13.00	-51.65	peak	
3		98.870	-70.82	-1.87	-72.69	-13.00	-59.69	peak	
4		159.980	-77.85	3.18	-74.67	-13.00	-61.67	peak	
5		210.420	-74.09	-2.44	-76.53	-13.00	-63.53	peak	
6		279.290	-78.25	2.62	-75.63	-13.00	-62.63	peak	

Test Mode: DCS1900_TX CH512_EDGE

Horizontal

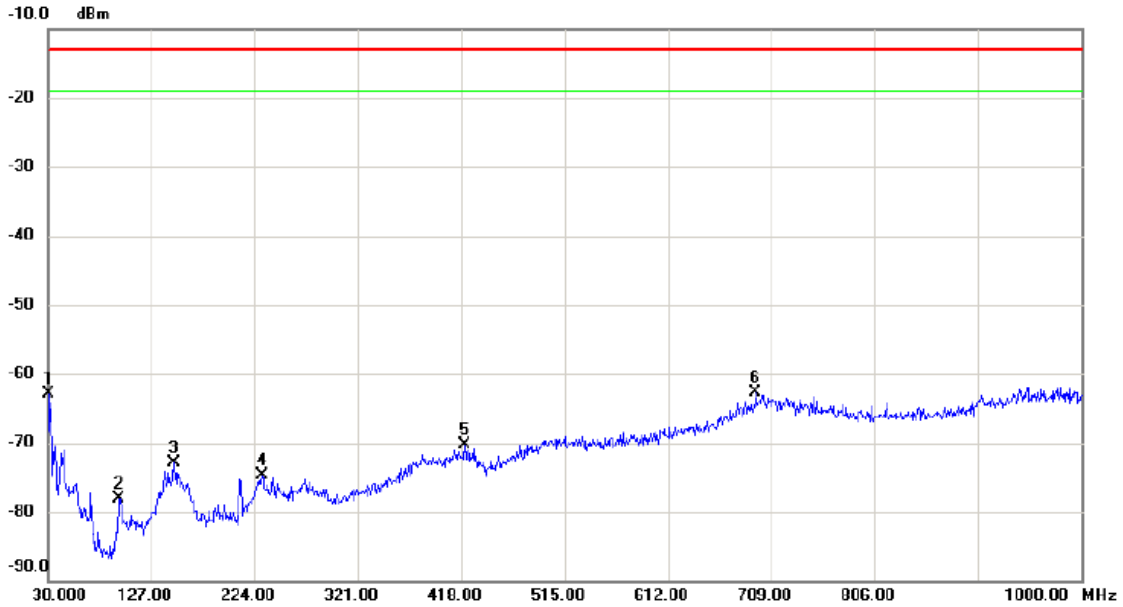

No.	Mk.	Freq. MHz	Reading Level dBm	Correct Factor dB	Measure- ment dBm	Limit dBm	Margin dB	Detector	Comment
1		30.000	-64.71	1.88	-62.83	-13.00	-49.83	peak	
2		96.930	-72.73	-5.32	-78.05	-13.00	-65.05	peak	
3		148.340	-77.03	4.06	-72.97	-13.00	-59.97	peak	
4		230.790	-77.97	3.18	-74.79	-13.00	-61.79	peak	
5		420.910	-77.04	6.78	-70.26	-13.00	-57.26	peak	
6 *		694.450	-76.35	13.60	-62.75	-13.00	-49.75	peak	

Test Mode: DCS1900_TX CH512_EDGE

Vertical

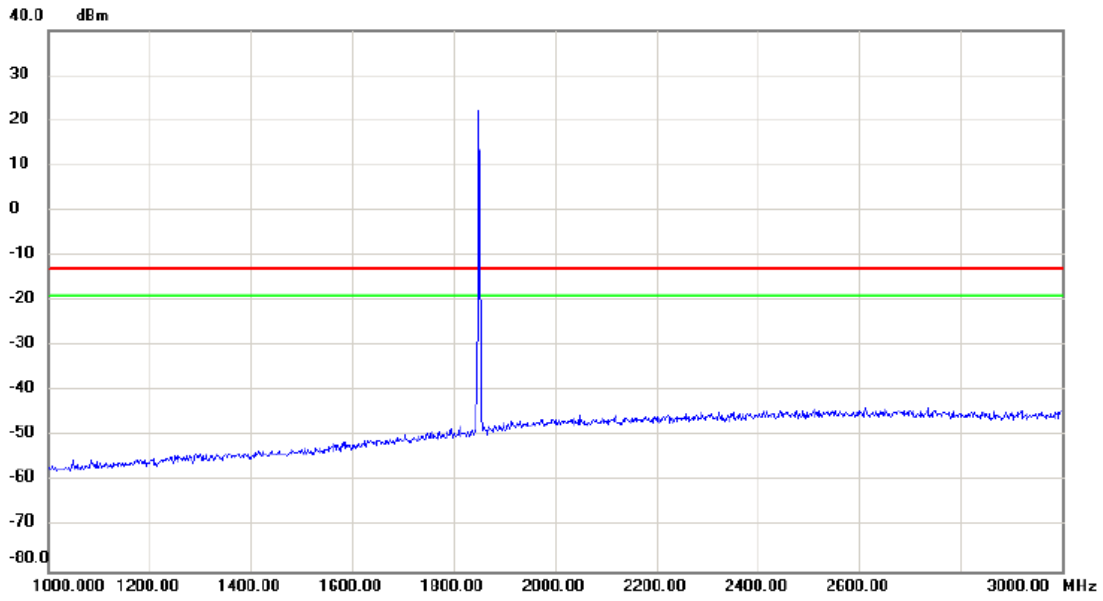

No.	Mk.	Freq.	Reading Level	Correct Factor	Measurement	Limit	Margin	Detector	Comment
		MHz	dBm	dB	dBm	dBm	dB		
		1930.00	22.00	0.00	22.00	-15.00	7.00		

Test Mode: DCS1900_TX CH512_EDGE

Horizontal

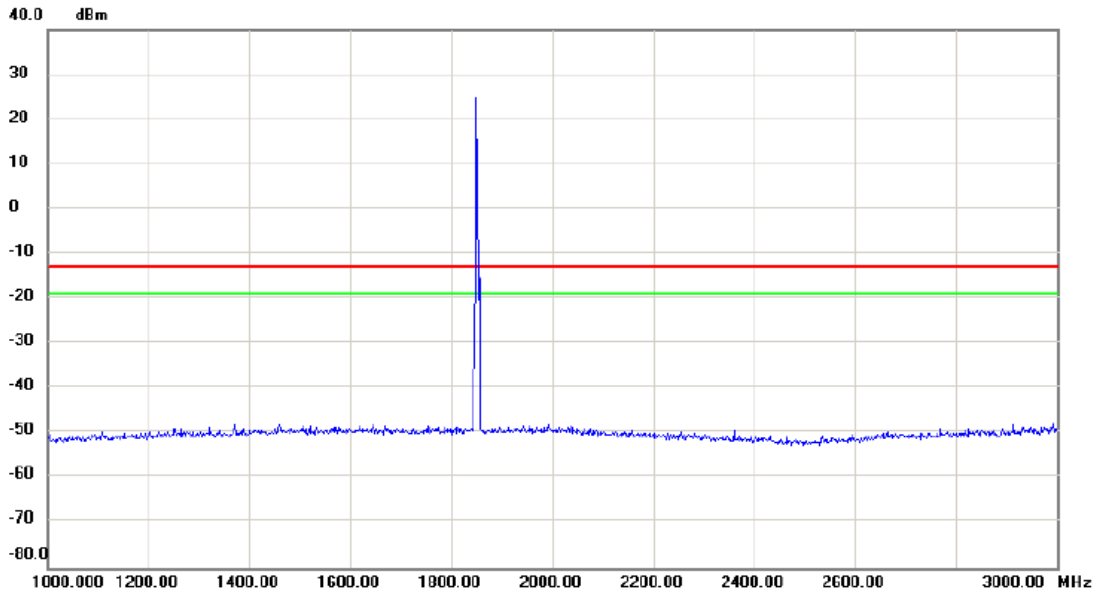

No.	Mk.	Freq.	Reading Level	Correct Factor	Measurement	Limit	Margin	Detector	Comment
		MHz	dBm	dB	dBm	dBm	dB		
		1930.000	25.0	0.0	25.0	-15.0	40.0		

Test Mode: DCS1900_TX CH512_EDGE

Vertical

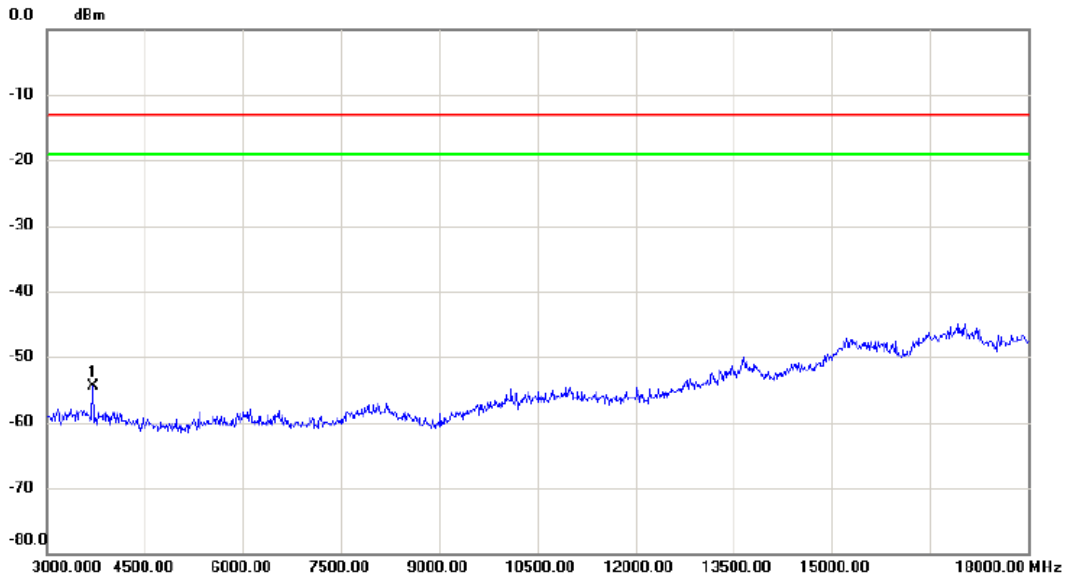

No.	Mk.	Freq. MHz	Reading Level dBm	Correct Factor dB	Measure- ment dBm	Limit dBm	Margin dB	Detector	Comment
1	*	3705.000	-69.03	14.46	-54.57	-13.00	-41.57	peak	

Test Mode: DCS1900_TX CH512_EDGE

Horizontal

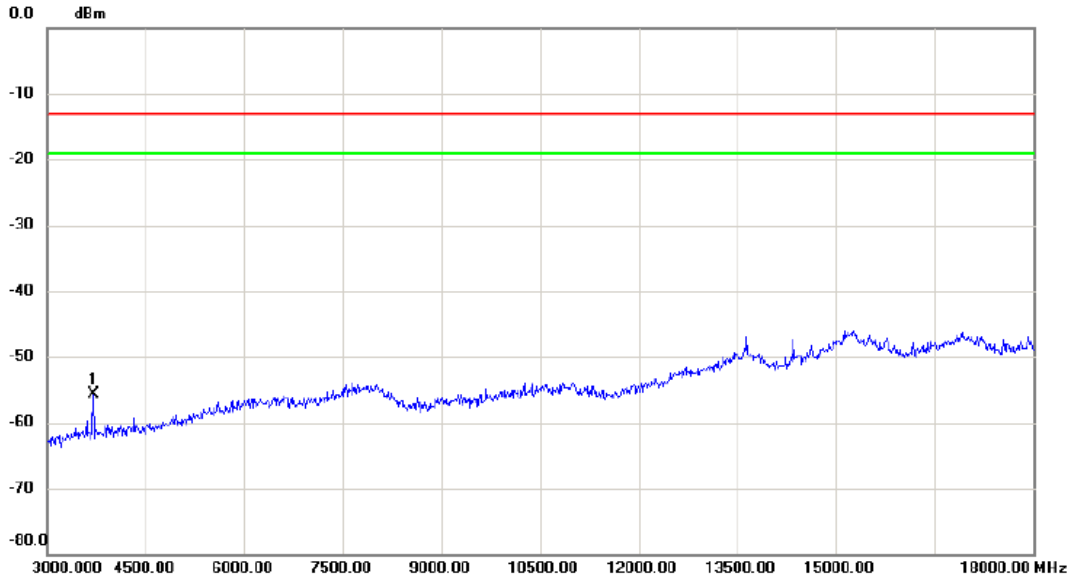

No.	Mk.	Freq.	Reading Level	Correct Factor	Measurement	Limit	Margin	Detector	Comment
		MHz	dBm	dB	dBm	dBm	dB		
1	*	3705.000	-66.97	11.19	-55.78	-13.00	-42.78	peak	

Test Mode: DCS1900_TX CH512_EDGE

Vertical

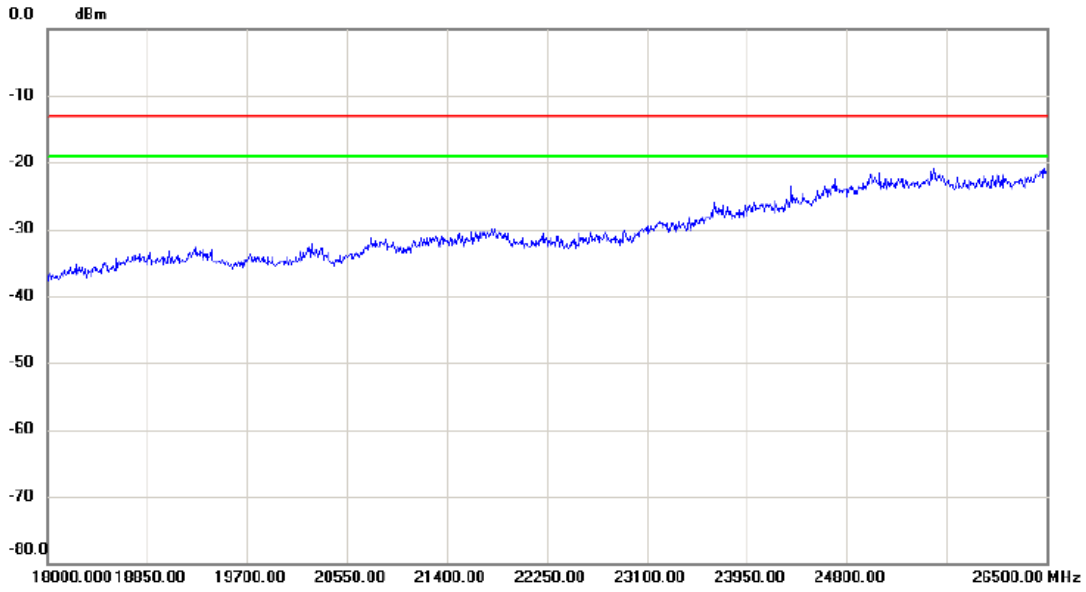

No.	Mk.	Freq.	Reading Level	Correct Factor	Measurement	Limit	Margin	Detector	Comment
		MHz	dBm	dB	dBm	dBm	dB		

Test Mode: DCS1900_TX CH512_EDGE

Horizontal

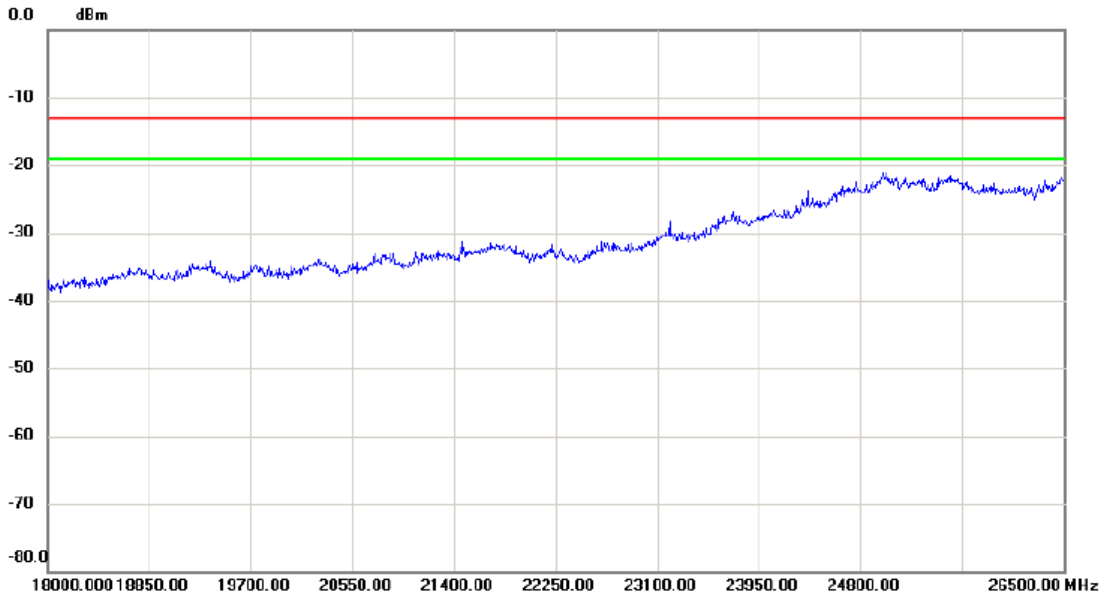

No.	Mk.	Freq.	Reading Level	Correct Factor	Measurement	Limit	Margin	Detector	Comment
		MHz	dBm	dB	dBm	dBm	dB		

Test Mode: WCDMA Band II_TX CH9400

Vertical

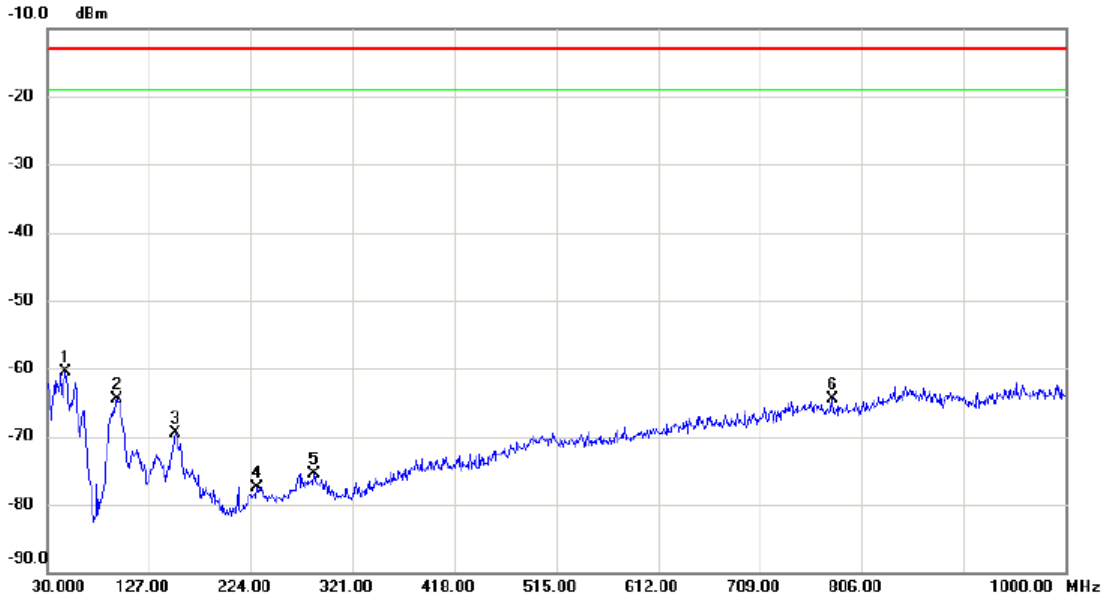

No.	Mk.	Freq. MHz	Reading Level dBm	Correct Factor dB	Measure- ment dBm	Limit dBm	Margin dB	Detector	Comment
1	*	47.460	-61.83	1.29	-60.54	-13.00	-47.54	peak	
2		95.960	-61.37	-3.14	-64.51	-13.00	-51.51	peak	
3		152.220	-72.74	3.16	-69.58	-13.00	-56.58	peak	
4		229.820	-77.95	0.45	-77.50	-13.00	-64.50	peak	
5		284.140	-77.91	2.47	-75.44	-13.00	-62.44	peak	
6		777.870	-76.65	12.15	-64.50	-13.00	-51.50	peak	

Test Mode: WCDMA Band II_TX CH9400

Horizontal

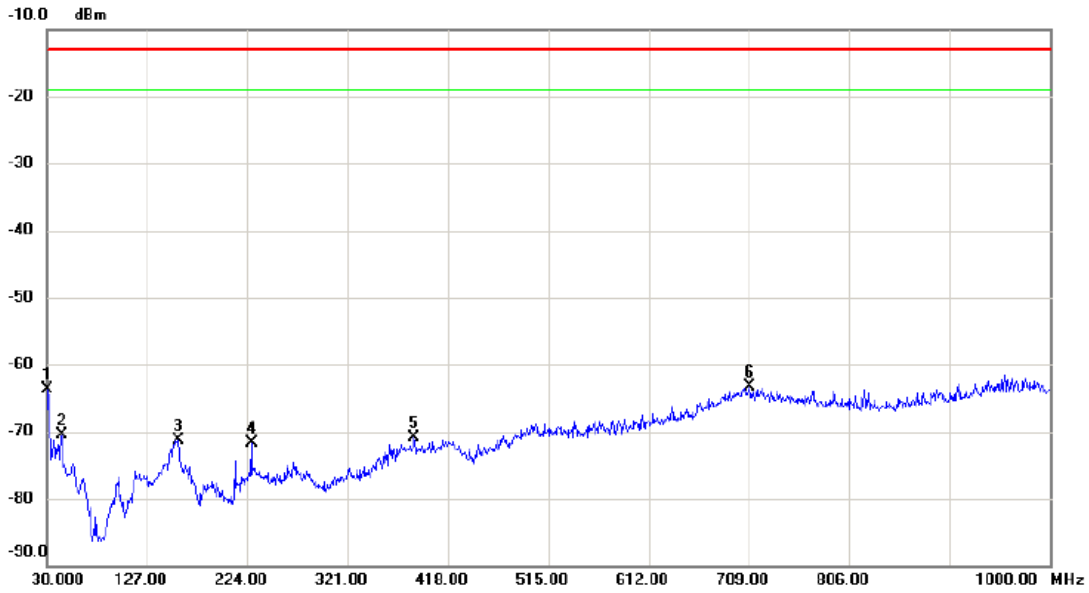

No.	Mk.	Freq. MHz	Reading Level dBm	Correct Factor dB	Measure- ment dBm	Limit dBm	Margin dB	Detector	Comment
1		30.000	-65.59	1.88	-63.71	-13.00	-50.71	peak	
2		44.550	-73.41	2.97	-70.44	-13.00	-57.44	peak	
3		157.070	-74.44	3.19	-71.25	-13.00	-58.25	peak	
4		227.880	-74.46	2.68	-71.78	-13.00	-58.78	peak	
5		385.020	-76.88	6.04	-70.84	-13.00	-57.84	peak	
6	*	709.000	-77.03	13.76	-63.27	-13.00	-50.27	peak	

Test Mode: WCDMA Band II_TX CH9400

Vertical

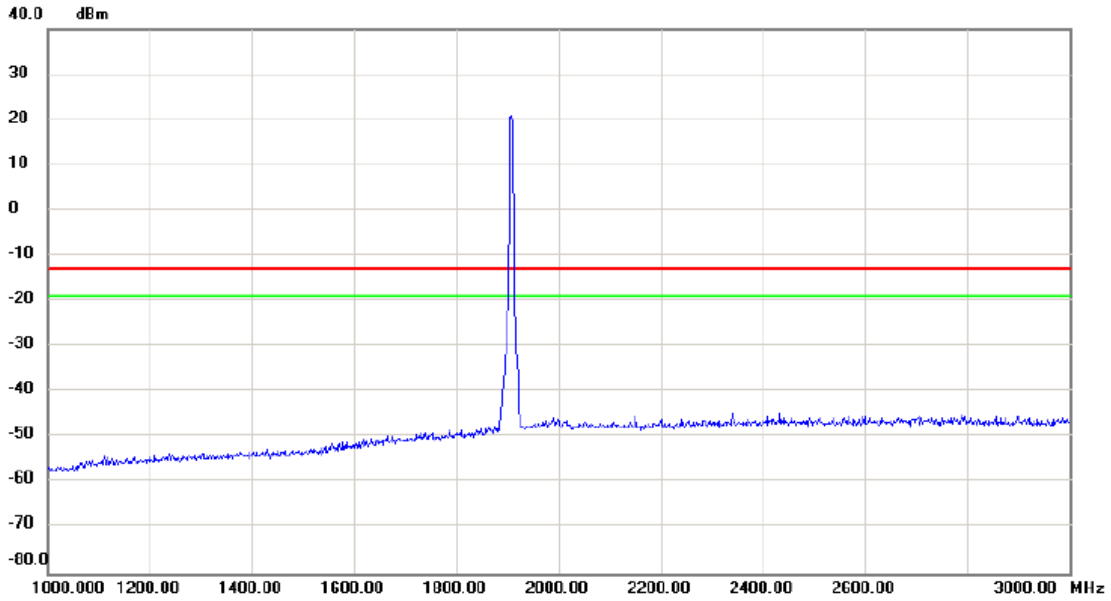

No.	Mk.	Freq.	Reading Level	Correct Factor	Measurement	Limit	Margin	Detector	Comment
		MHz	dBm	dB	dBm	dBm	dB		
		1930.00	20.00	0.00	20.00	-15.00	35.00		

Test Mode: WCDMA Band II_TX CH9400

Horizontal

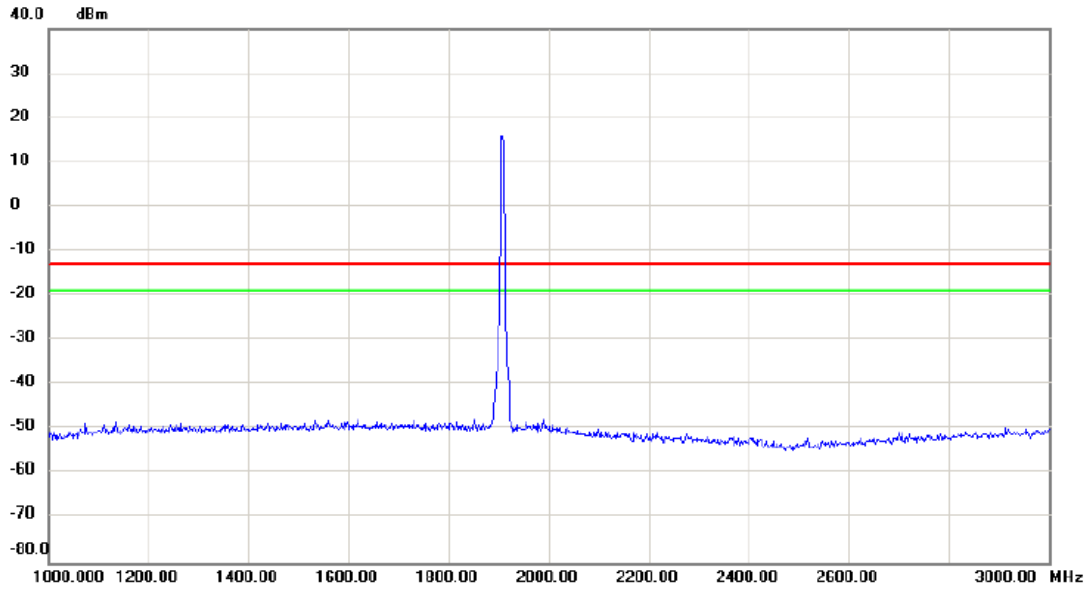

No.	Mk.	Freq.	Reading Level	Correct Factor	Measurement	Limit	Margin	Detector	Comment
		MHz	dBm	dB	dBm	dBm	dB		
		1880.00	15.00	0.00	15.00	-15.00	30.00		

Test Mode: WCDMA Band II_TX CH9400

Vertical

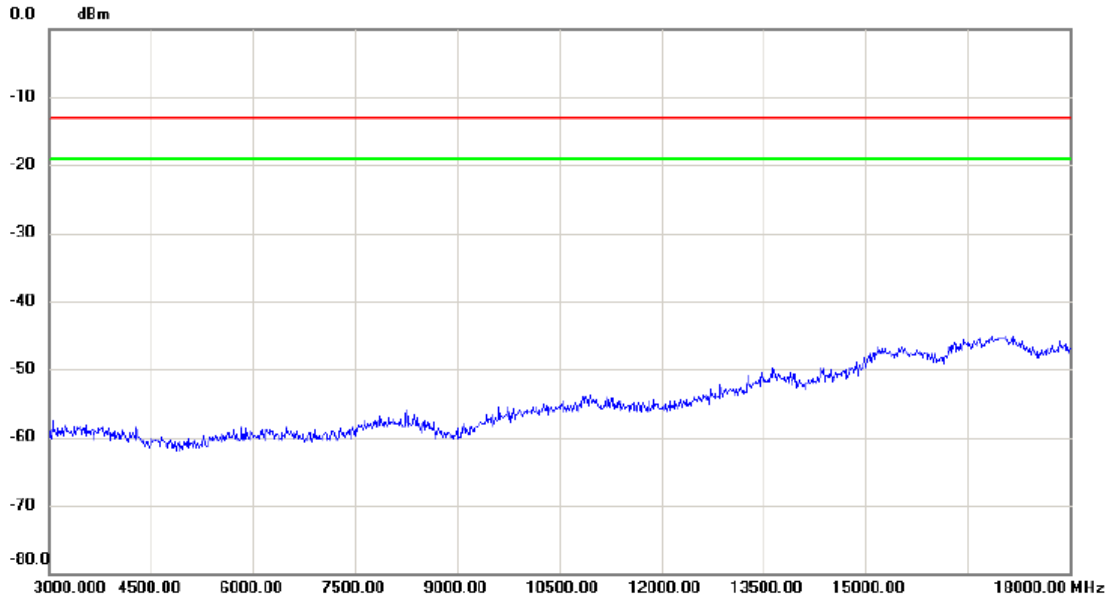

No.	Mk.	Freq.	Reading Level	Correct Factor	Measurement	Limit	Margin	Detector	Comment
		MHz	dBm	dB	dBm	dBm	dB		

Test Mode: WCDMA Band II_TX CH9400

Horizontal

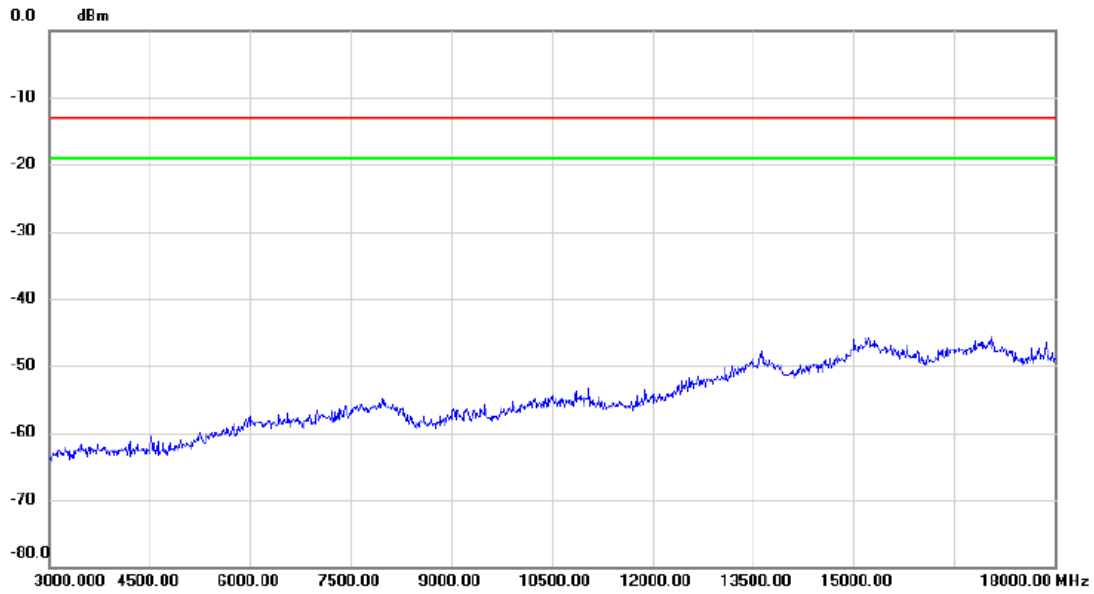

No.	Mk.	Freq.	Reading Level	Correct Factor	Measurement	Limit	Margin	Detector	Comment
		MHz	dBm	dB	dBm	dBm	dB		

Test Mode: WCDMA Band II_TX CH9400

Vertical

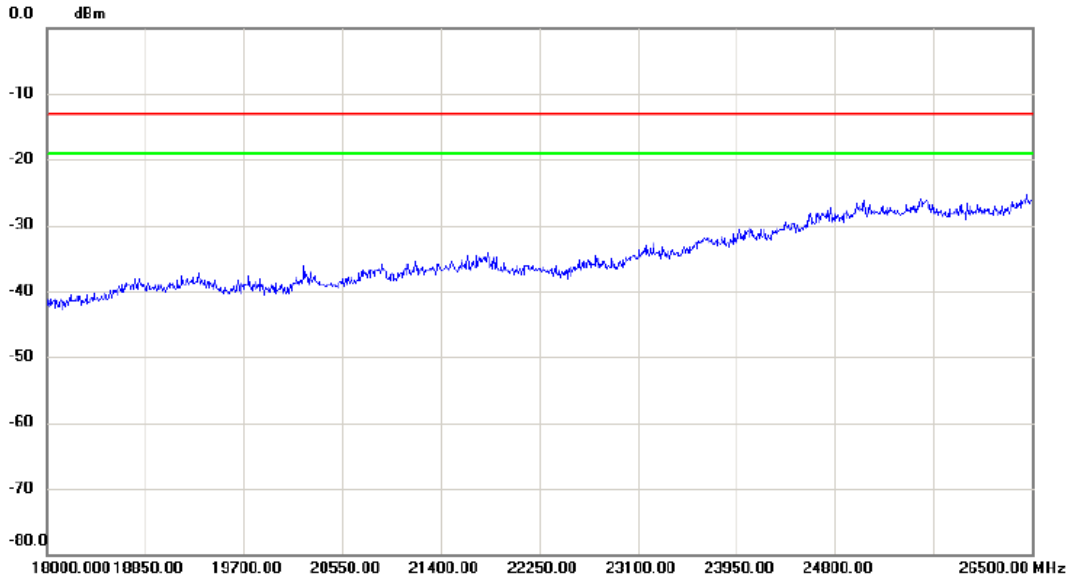

No.	Mk.	Freq.	Reading Level	Correct Factor	Measurement	Limit	Margin	Detector	Comment
		MHz	dBm	dB	dBm	dBm	dB		
		19000.00	-42						
		19500.00	-40						
		19700.00	-40						
		20550.00	-38						
		21400.00	-36						
		22250.00	-35						
		23100.00	-33						
		23950.00	-31						
		24800.00	-29						
		25500.00	-27						

Test Mode: WCDMA Band II_TX CH9400

Horizontal

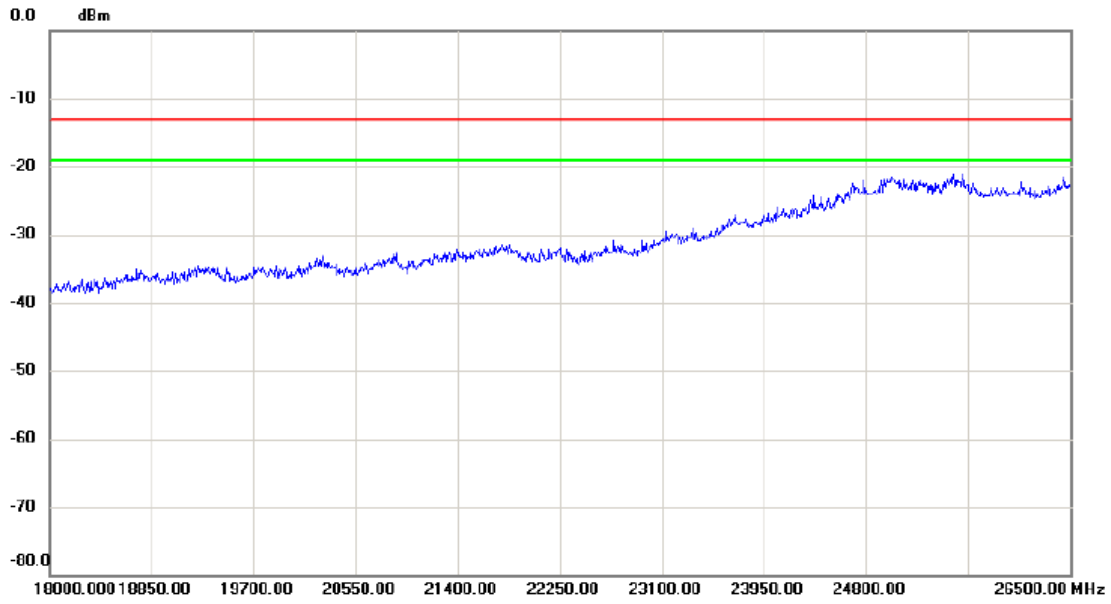

No.	Mk.	Freq.	Reading Level	Correct Factor	Measurement	Limit	Margin	Detector	Comment
		MHz	dBm	dB	dBm	dBm	dB		

Test Mode: WCDMA Band II_HSDPA_TX CH9400

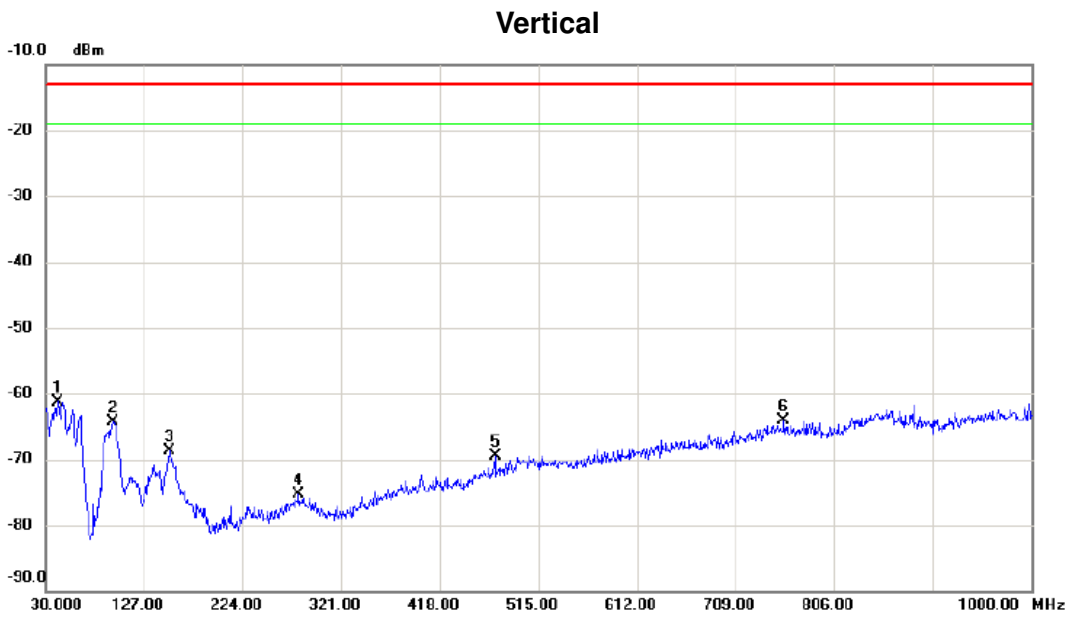

No.	Mk.	Freq. MHz	Reading Level dBm	Correct Factor dB	Measure- ment dBm	Limit dBm	Margin dB	Detector	Comment
1	*	42.610	-63.23	2.03	-61.20	-13.00	-48.20	peak	
2		96.930	-61.65	-2.72	-64.37	-13.00	-51.37	peak	
3		152.220	-71.88	3.16	-68.72	-13.00	-55.72	peak	
4		279.290	-77.97	2.62	-75.35	-13.00	-62.35	peak	
5		472.320	-75.62	6.18	-69.44	-13.00	-56.44	peak	
6		756.530	-76.41	12.40	-64.01	-13.00	-51.01	peak	

Test Mode: WCDMA Band II_HSDPA_TX CH9400

Horizontal

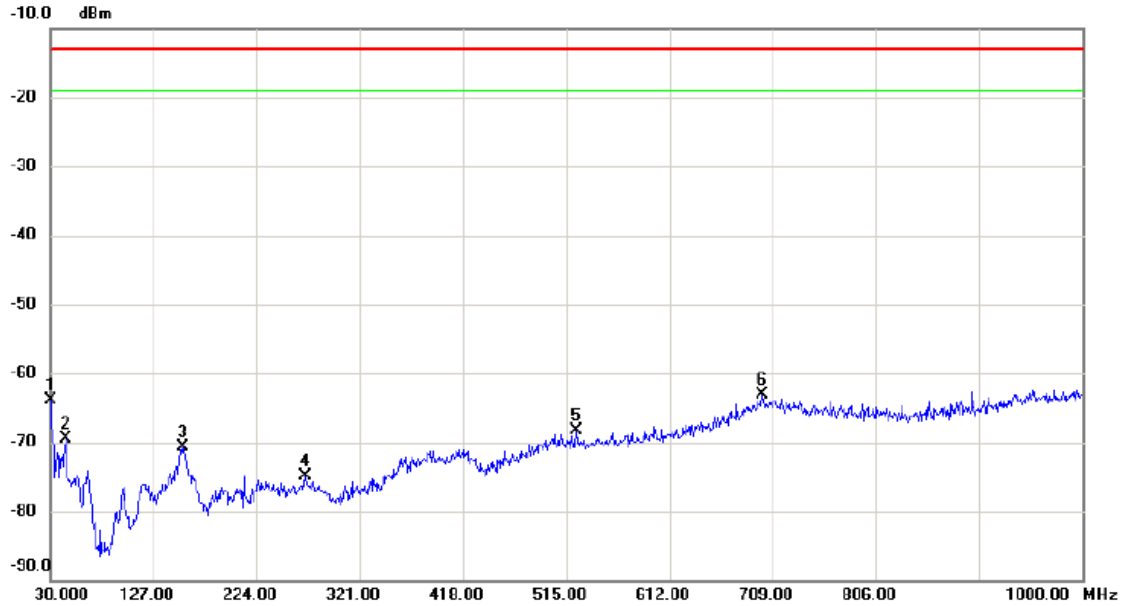

No.	Mk.	Freq. MHz	Reading Level dBm	Correct Factor dB	Measure- ment dBm	Limit dBm	Margin dB	Detector	Comment
1		30.000	-65.84	1.88	-63.96	-13.00	-50.96	peak	
2		44.550	-72.54	2.97	-69.57	-13.00	-56.57	peak	
3		154.160	-74.41	3.62	-70.79	-13.00	-57.79	peak	
4		269.590	-77.88	2.98	-74.90	-13.00	-61.90	peak	
5		524.700	-76.41	8.08	-68.33	-13.00	-55.33	peak	
6	*	699.300	-77.11	13.93	-63.18	-13.00	-50.18	peak	

Test Mode: WCDMA Band II_HSDPA_TX CH9400

Vertical

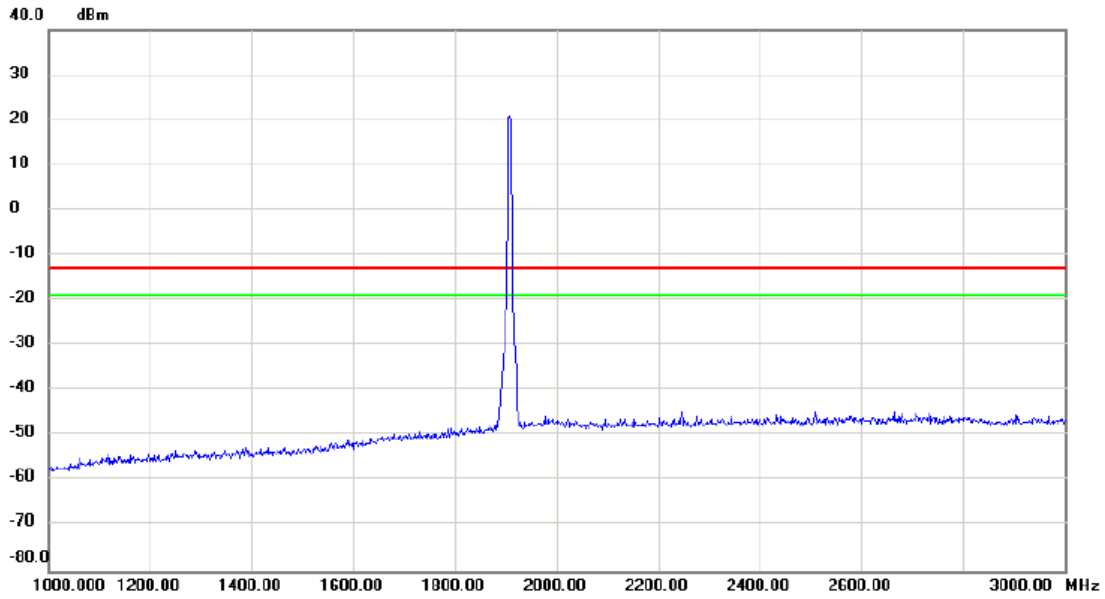

No. Mk.	Freq.	Reading Level	Correct Factor	Measurement	Limit	Margin	Detector	Comment
	MHz	dBm	dB	dBm	dBm	dB		
	1950.00	20.00		20.00	-15.00	35.00		

Test Mode: WCDMA Band II_HSDPA_TX CH9400

Horizontal

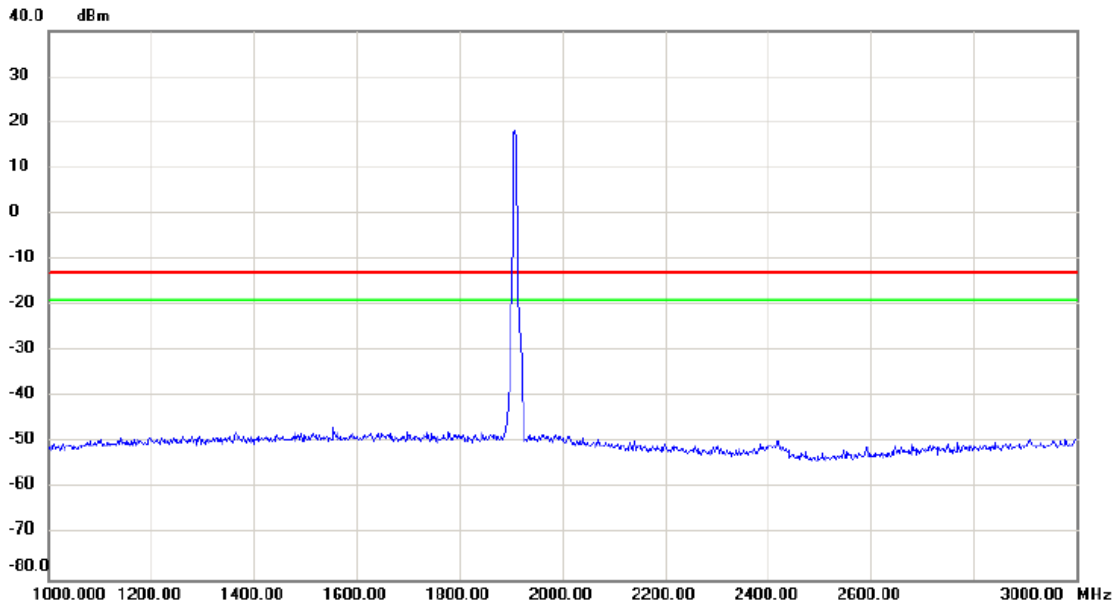

No.	Mk.	Freq.	Reading Level	Correct Factor	Measurement	Limit	Margin	Detector	Comment
		MHz	dBm	dB	dBm	dBm	dB		
		1930.00	18.00	0.00	18.00	-15.00	33.00		

Test Mode: WCDMA Band II_HSDPA_TX CH9400

Vertical

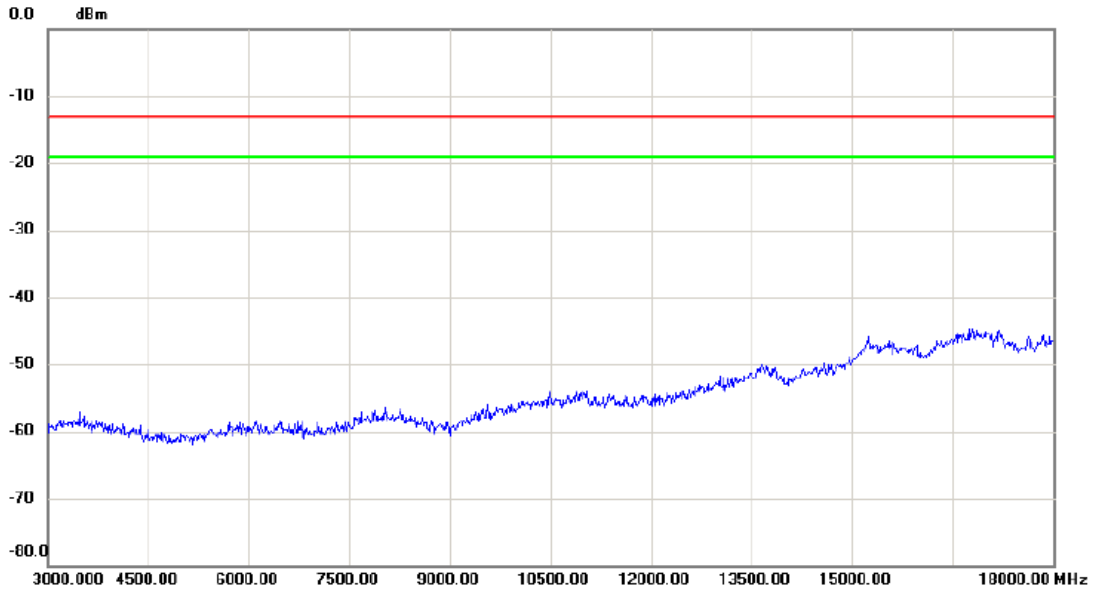

No.	Mk.	Freq. MHz	Reading Level dBm	Correct Factor dB	Measure- ment dBm	Limit dBm	Margin dB	Detector	Comment
-----	-----	--------------	-------------------------	-------------------------	-------------------------	--------------	--------------	----------	---------

Test Mode: WCDMA Band II_HSDPA_TX CH9400

Horizontal

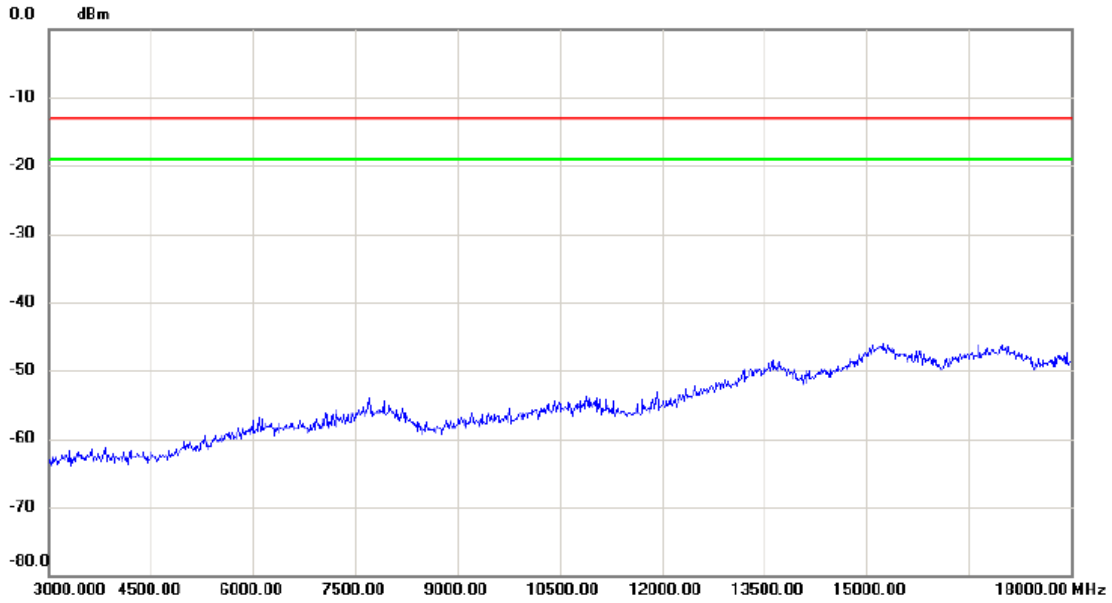

No.	Mk.	Freq.	Reading Level	Correct Factor	Measurement	Limit	Margin	Detector	Comment
		MHz	dBm	dB	dBm	dBm	dB		

Test Mode: WCDMA Band II_HSDPA_TX CH9400

Vertical

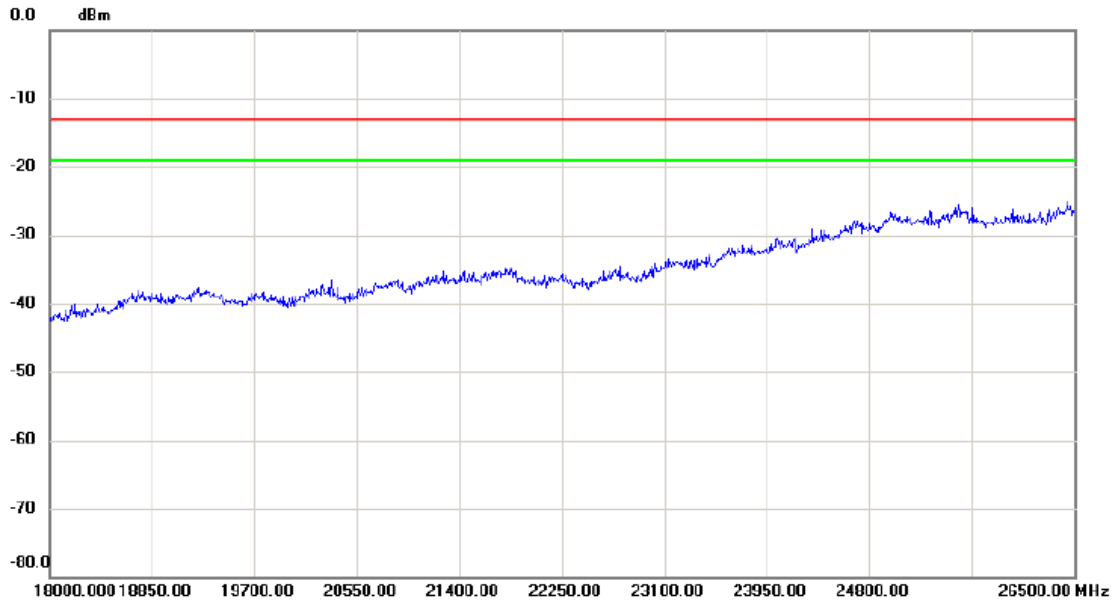

No.	Mk.	Freq. MHz	Reading Level dBm	Correct Factor dB	Measure- ment dBm	Limit dBm	Margin dB	Detector	Comment
-----	-----	--------------	-------------------------	-------------------------	-------------------------	--------------	--------------	----------	---------

Test Mode: WCDMA Band II_HSDPA_TX CH9400

Horizontal

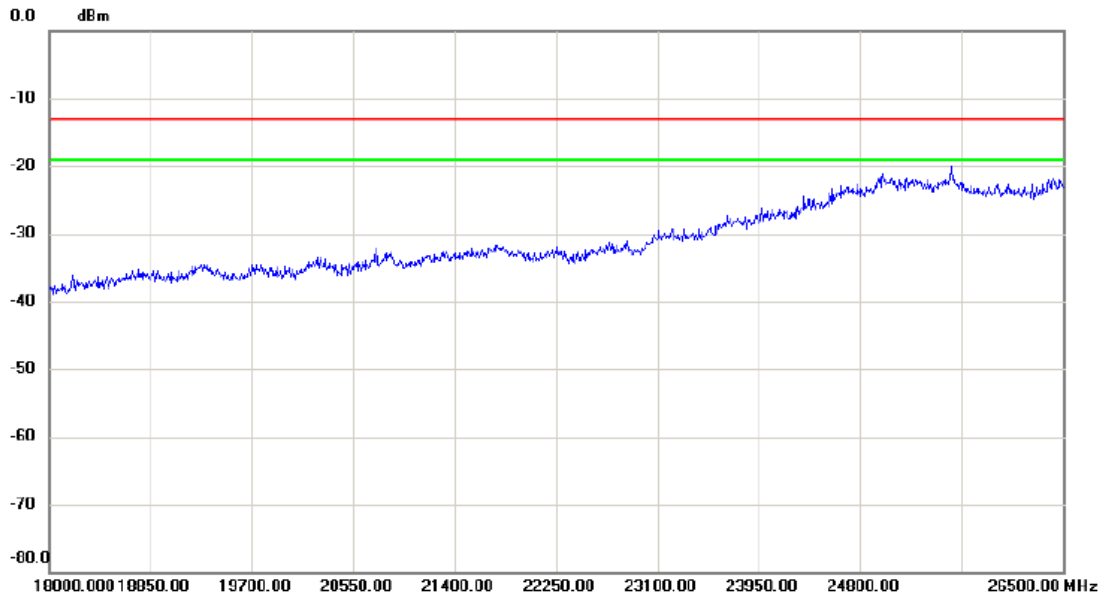

No.	Mk.	Freq.	Reading Level	Correct Factor	Measurement	Limit	Margin	Detector	Comment
		MHz	dBm	dB	dBm	dBm	dB		

Test Mode: WCDMA Band II_HSUPA_TX CH9400

Vertical

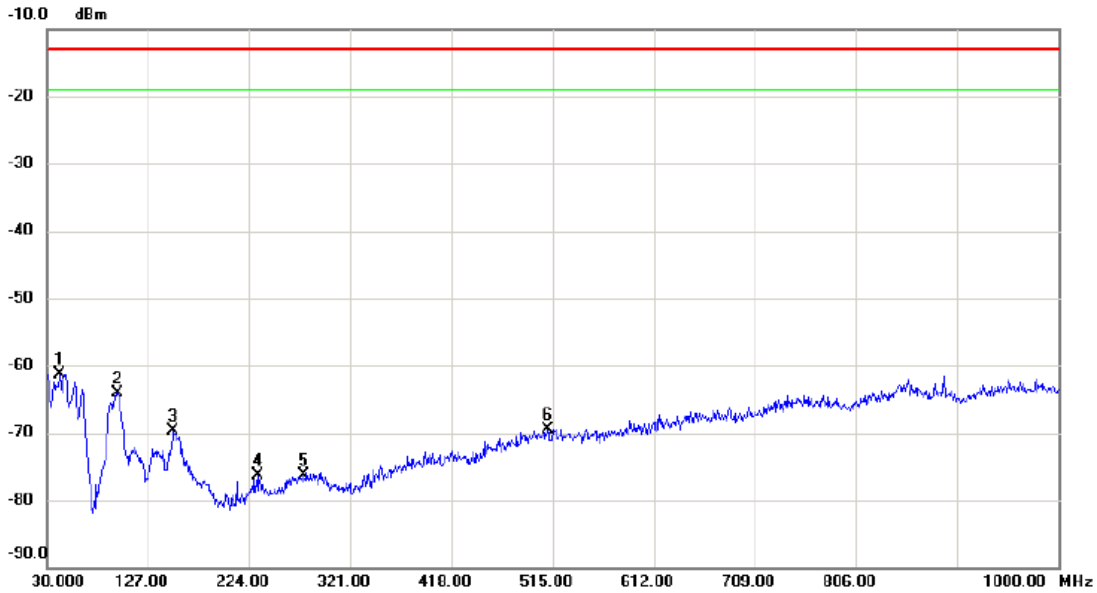

No.	Mk.	Freq. MHz	Reading Level dBm	Correct Factor dB	Measure- ment dBm	Limit dBm	Margin dB	Detector	Comment
1	*	42.610	-63.30	2.03	-61.27	-13.00	-48.27	peak	
2		97.900	-61.70	-2.30	-64.00	-13.00	-51.00	peak	
3		151.250	-72.78	3.15	-69.63	-13.00	-56.63	peak	
4		231.760	-76.71	0.44	-76.27	-13.00	-63.27	peak	
5		276.380	-78.71	2.48	-76.23	-13.00	-63.23	peak	
6		510.150	-76.95	7.53	-69.42	-13.00	-56.42	peak	

Test Mode: WCDMA Band II_HSUPA_TX CH9400

Horizontal



No.	Mk.	Freq. MHz	Reading Level dBm	Correct Factor dB	Measure- ment dBm	Limit dBm	Margin dB	Detector	Comment
1		30.000	-66.30	1.88	-64.42	-13.00	-51.42	peak	
2		43.580	-73.60	2.78	-70.82	-13.00	-57.82	peak	
3		152.220	-74.76	3.91	-70.85	-13.00	-57.85	peak	
4		212.360	-72.74	-1.35	-74.09	-13.00	-61.09	peak	
5		549.920	-76.34	8.10	-68.24	-13.00	-55.24	peak	
6 *		698.330	-76.51	13.87	-62.64	-13.00	-49.64	peak	

Test Mode: WCDMA Band II_HSUPA_TX CH9400

Vertical

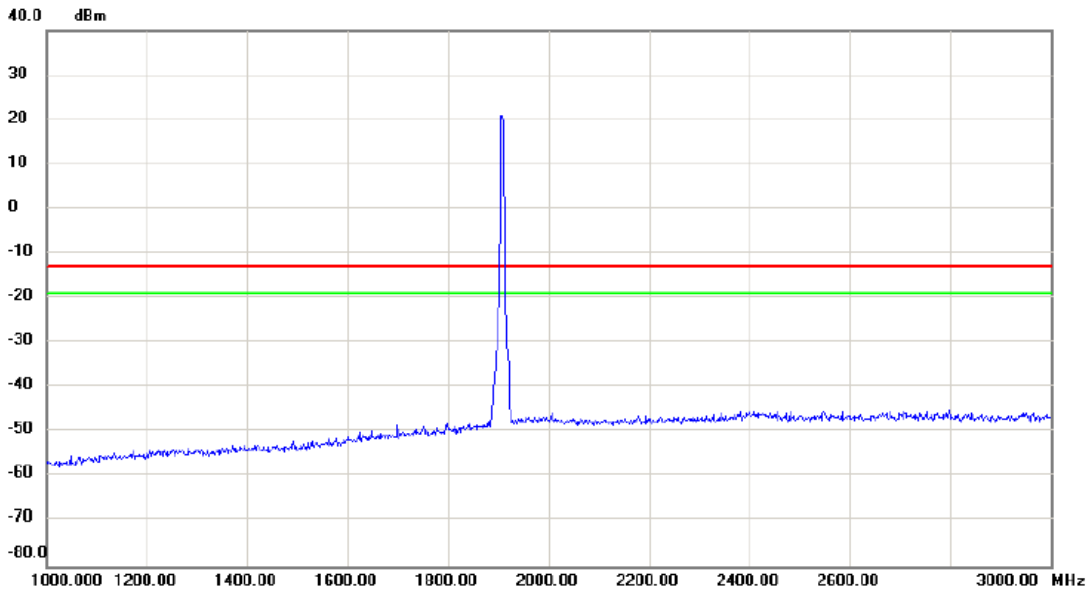

No.	Mk.	Freq.	Reading Level	Correct Factor	Measurement	Limit	Margin	Detector	Comment
		MHz	dBm	dB	dBm	dBm	dB		
		1930.00	20.00		20.00	-15.00	5.00		

Test Mode: WCDMA Band II_HSUPA_TX CH9400

Horizontal

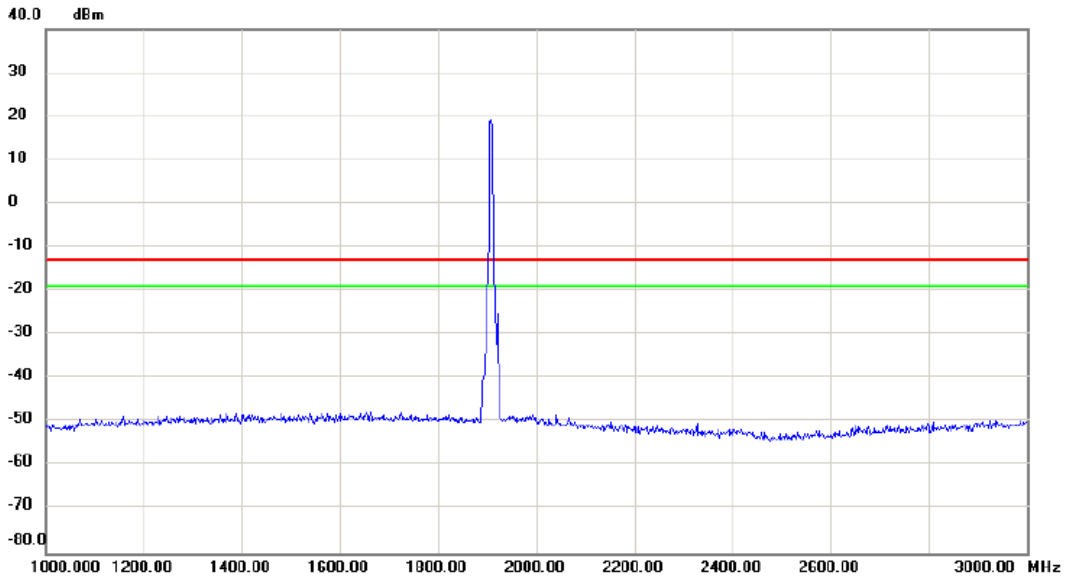

No.	Mk.	Freq.	Reading Level	Correct Factor	Measurement	Limit	Margin	Detector	Comment
		MHz	dBm	dB	dBm	dBm	dB		
		1950.00	18.00	0.00	18.00	-15.00	3.00		

Test Mode: WCDMA Band II_HSUPA_TX CH9400

Vertical

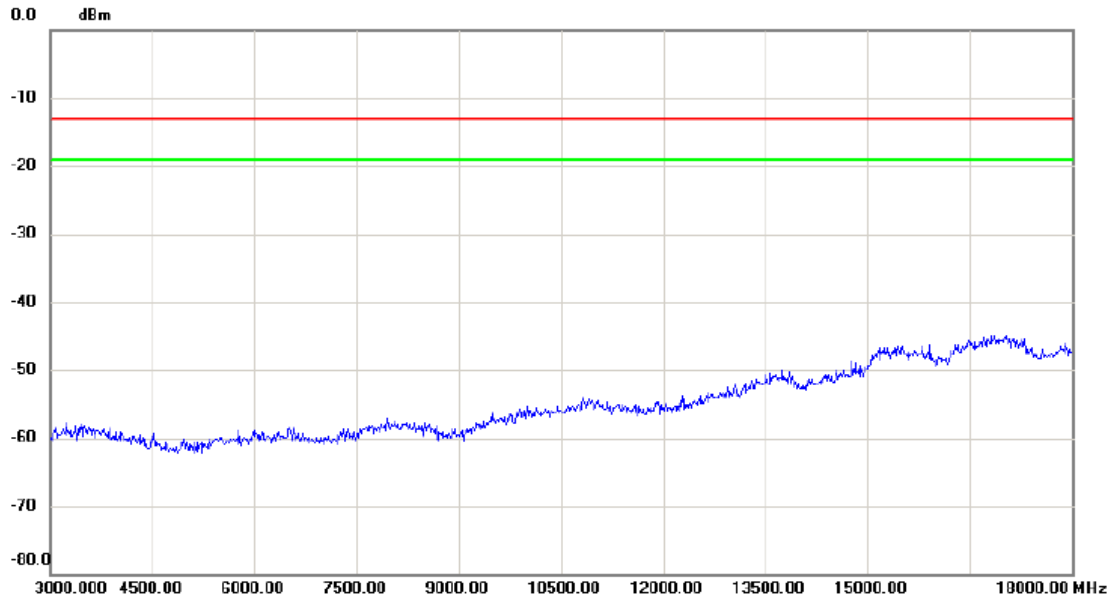

No.	Mk.	Freq. MHz	Reading Level dBm	Correct Factor dB	Measure- ment dBm	Limit dBm	Margin dB	Detector	Comment

Test Mode: WCDMA Band II_HSUPA_TX CH9400

Horizontal

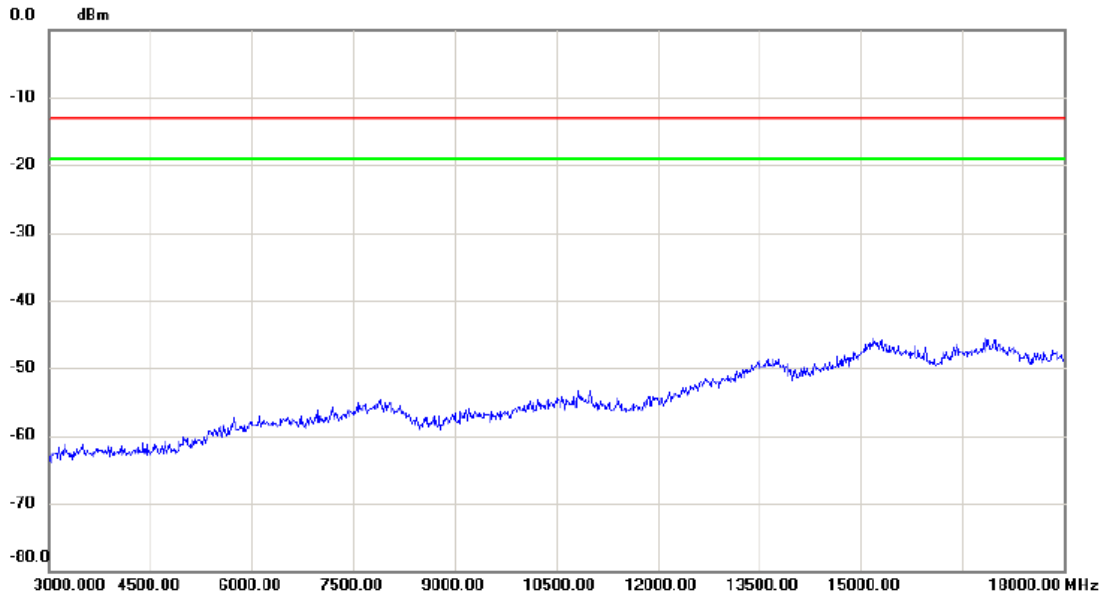

No.	Mk.	Freq.	Reading Level	Correct Factor	Measurement	Limit	Margin	Detector	Comment
		MHz	dBm	dB	dBm	dBm	dB		

Test Mode: WCDMA Band II_HSUPA_TX CH9400

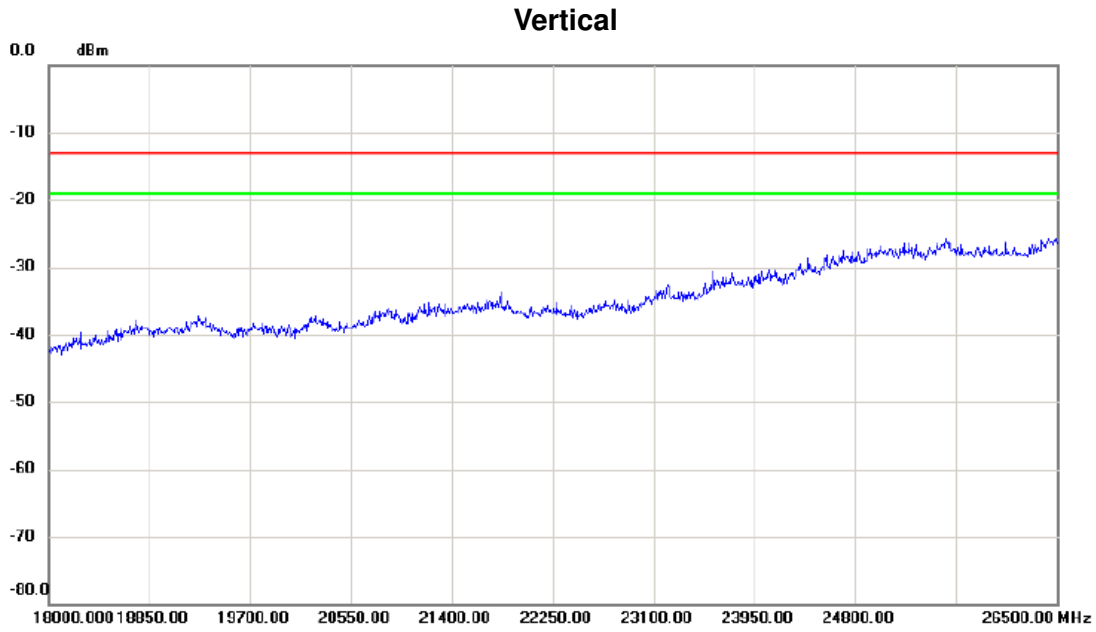

No.	Mk.	Freq. MHz	Reading Level dBm	Correct Factor dB	Measure- ment dBm	Limit dBm	Margin dB	Detector	Comment
-----	-----	--------------	-------------------------	-------------------------	-------------------------	--------------	--------------	----------	---------

Test Mode: WCDMA Band II_HSUPA_TX CH9400

Horizontal

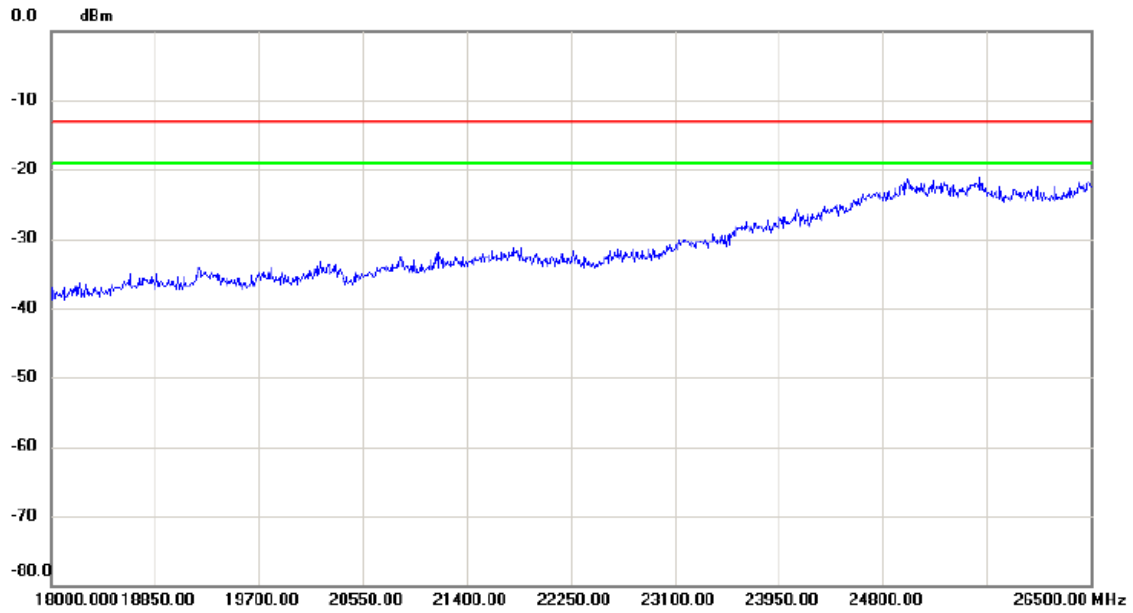

No.	Mk.	Freq. MHz	Reading Level dBm	Correct Factor dB	Measure- ment dBm	Limit dBm	Margin dB	Detector	Comment

Test Mode: LTE Band 2_TX CH18900_1.4M

Vertical

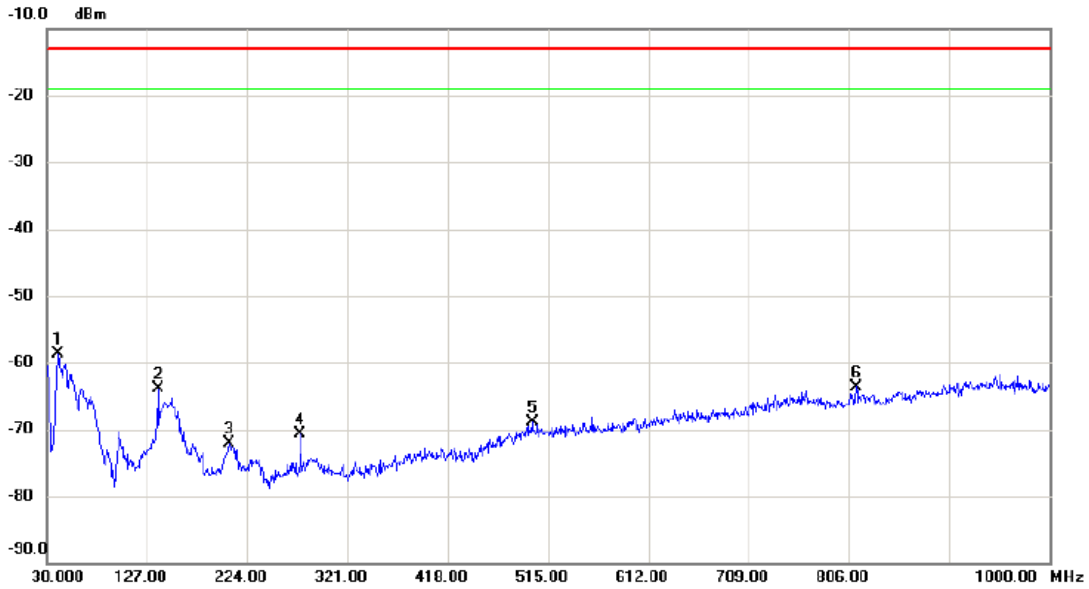

No.	Mk.	Freq. MHz	Reading Level dBm	Correct Factor dB	Measure- ment dBm	Limit dBm	Margin dB	Detector	Comment
1	*	40.670	-60.85	2.10	-58.75	-13.00	-45.75	peak	
2		137.670	-65.32	1.50	-63.82	-13.00	-50.82	peak	
3		206.540	-69.71	-2.43	-72.14	-13.00	-59.14	peak	
4		275.410	-73.15	2.44	-70.71	-13.00	-57.71	peak	
5		499.480	-76.51	7.52	-68.99	-13.00	-55.99	peak	
6		812.790	-76.15	12.55	-63.60	-13.00	-50.60	peak	

Test Mode: LTE Band 2_TX CH18900_1.4M

Horizontal

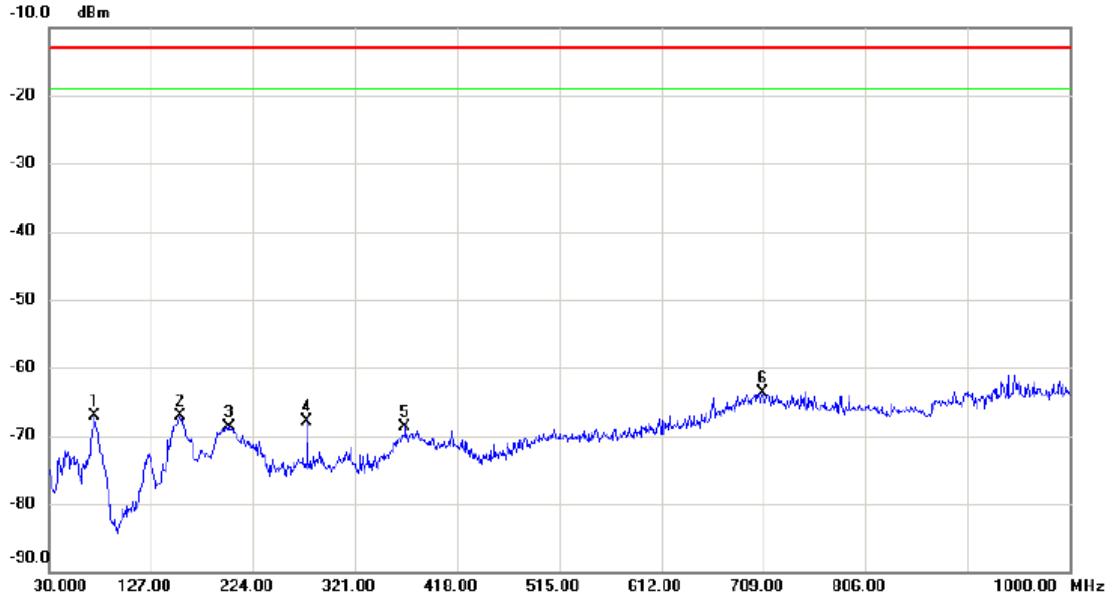

No.	Mk.	Freq. MHz	Reading Level dBm	Correct Factor dB	Measure- ment dBm	Limit dBm	Margin dB	Detector	Comment
1		73.650	-60.80	-6.25	-67.05	-13.00	-54.05	peak	
2		155.130	-70.49	3.48	-67.01	-13.00	-54.01	peak	
3		200.720	-66.74	-1.91	-68.65	-13.00	-55.65	peak	
4		275.410	-70.61	2.74	-67.87	-13.00	-54.87	peak	
5		368.530	-73.44	4.74	-68.70	-13.00	-55.70	peak	
6	*	708.030	-77.56	13.79	-63.77	-13.00	-50.77	peak	

Test Mode: LTE Band 2_TX CH18900_1.4M

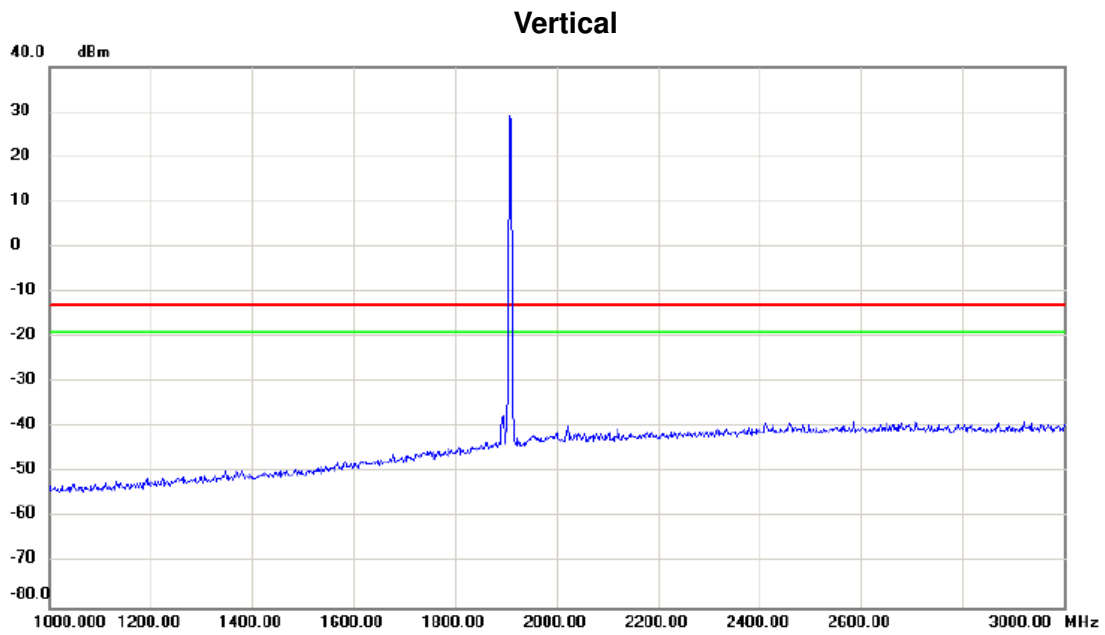

No.	Mk.	Freq. MHz	Reading Level dBm	Correct Factor dB	Measure- ment dBm	Limit dBm	Margin dB	Detector	Comment
		1890.00	30.00	0.00	30.00	-15.00	15.00		

Test Mode: LTE Band 2_TX CH18900_1.4M

Horizontal

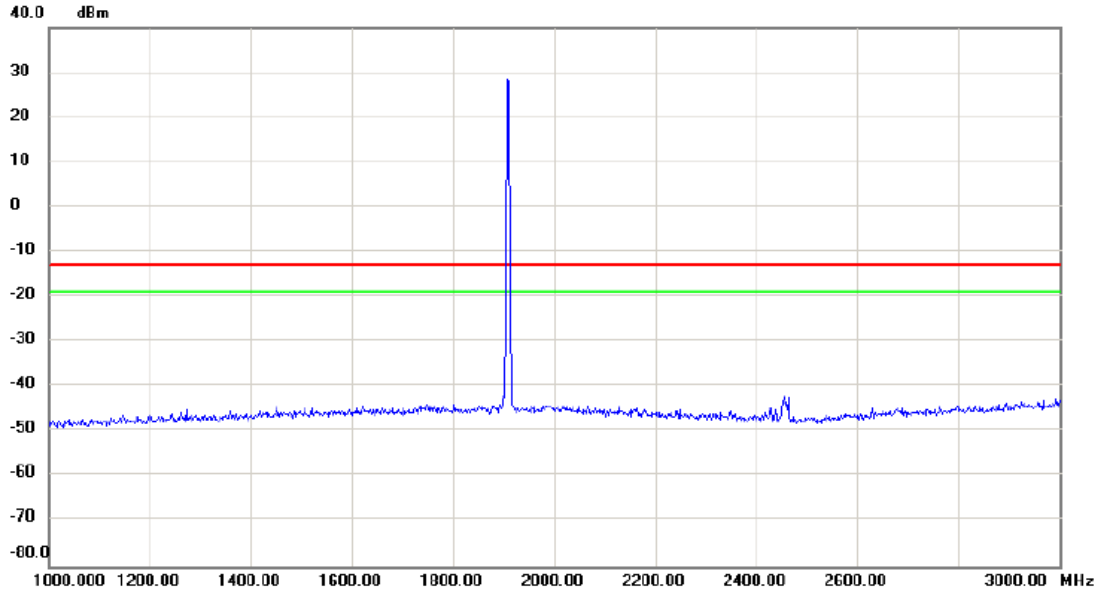

No.	Mk.	Freq.	Reading Level	Correct Factor	Measurement	Limit	Margin	Detector	Comment
		MHz	dBm	dB	dBm	dBm	dB		
		1900.00	28.00	0.00	28.00	-15.00	43.00		

Test Mode: LTE Band 2_TX CH18900_1.4M

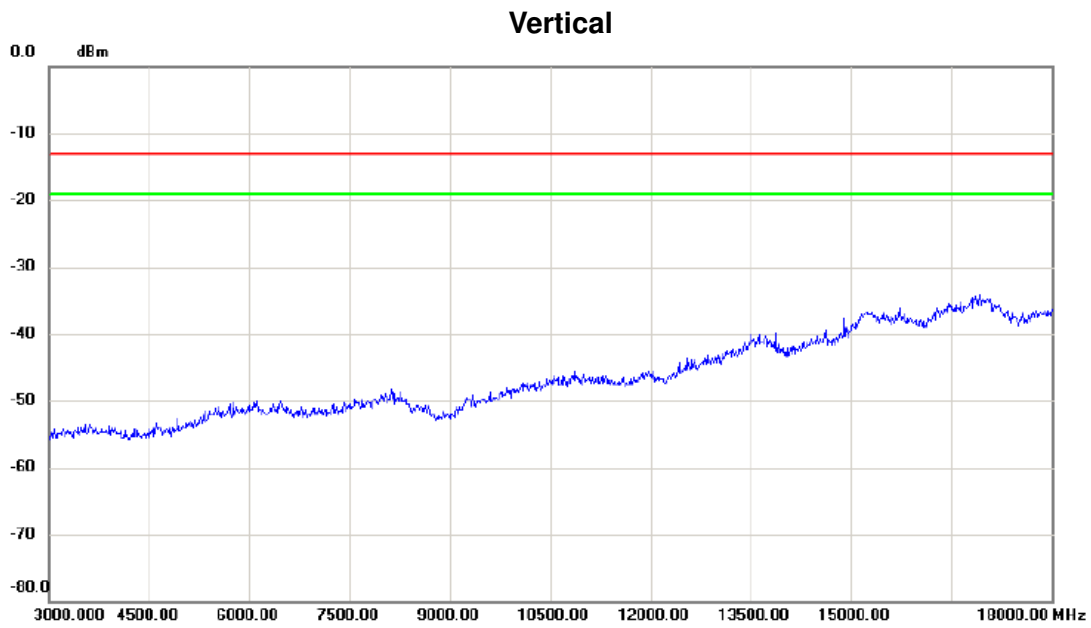

No.	Mk.	Freq. MHz	Reading Level dBm	Correct Factor dB	Measure- ment dBm	Limit dBm	Margin dB	Detector	Comment
-----	-----	--------------	-------------------------	-------------------------	-------------------------	--------------	--------------	----------	---------

Test Mode: LTE Band 2_TX CH18900_1.4M

Horizontal

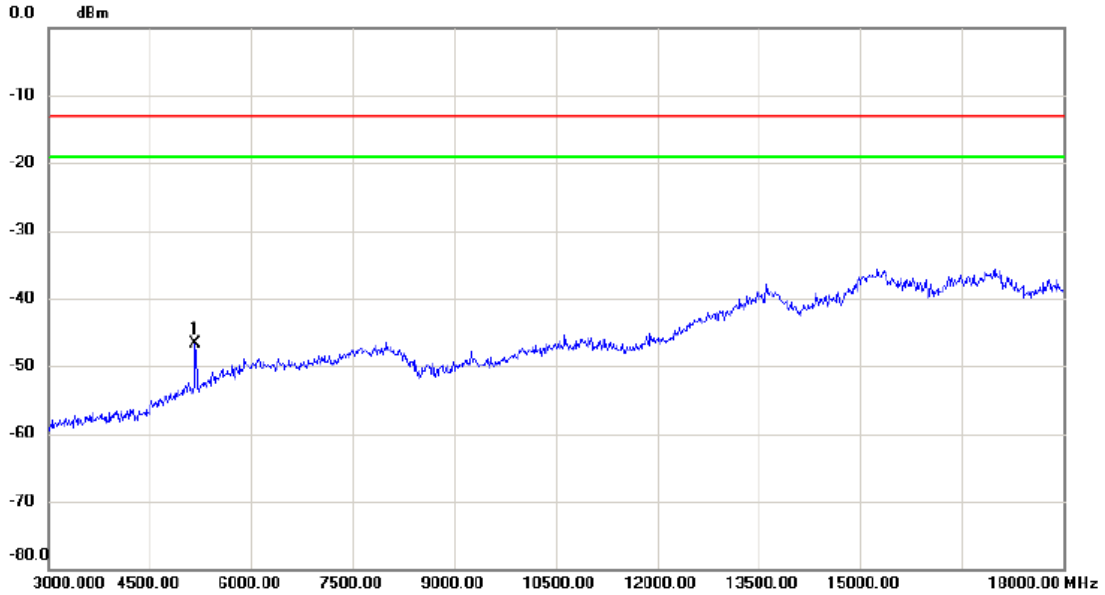

No.	Mk.	Freq. MHz	Reading Level dBm	Correct Factor dB	Measure- ment dBm	Limit dBm	Margin dB	Detector	Comment
1	*	5175.000	-62.06	15.34	-46.72	-13.00	-33.72	peak	

Test Mode: LTE Band 2_TX CH18900_1.4M

Vertical

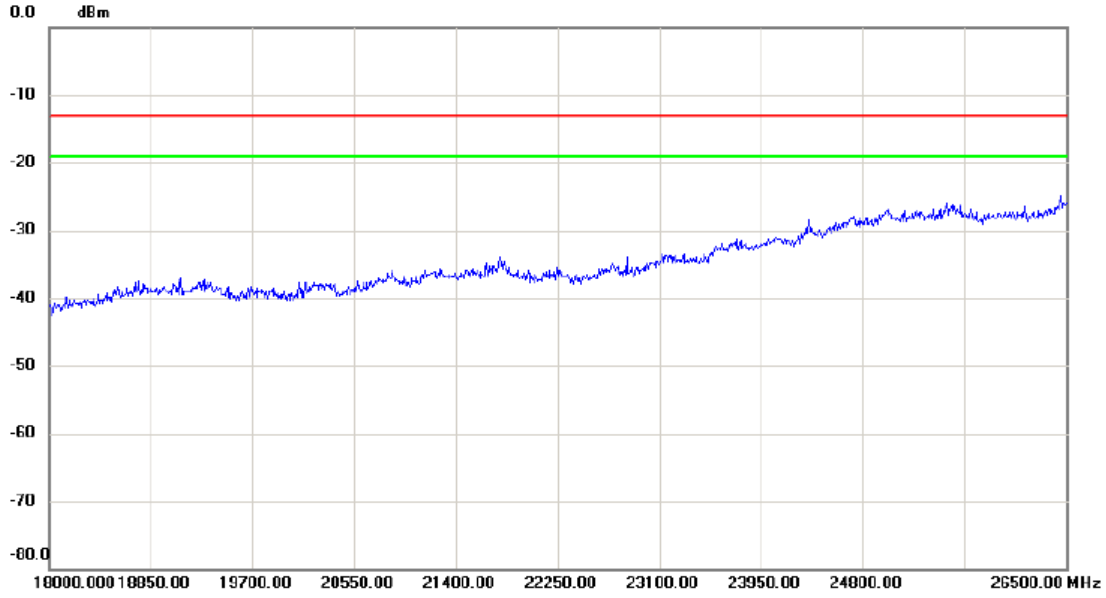

No.	Mk.	Freq. MHz	Reading Level dBm	Correct Factor dB	Measure- ment dBm	Limit dBm	Margin dB	Detector	Comment
-----	-----	--------------	-------------------------	-------------------------	-------------------------	--------------	--------------	----------	---------

Test Mode: LTE Band 2_TX CH18900_1.4M

Horizontal

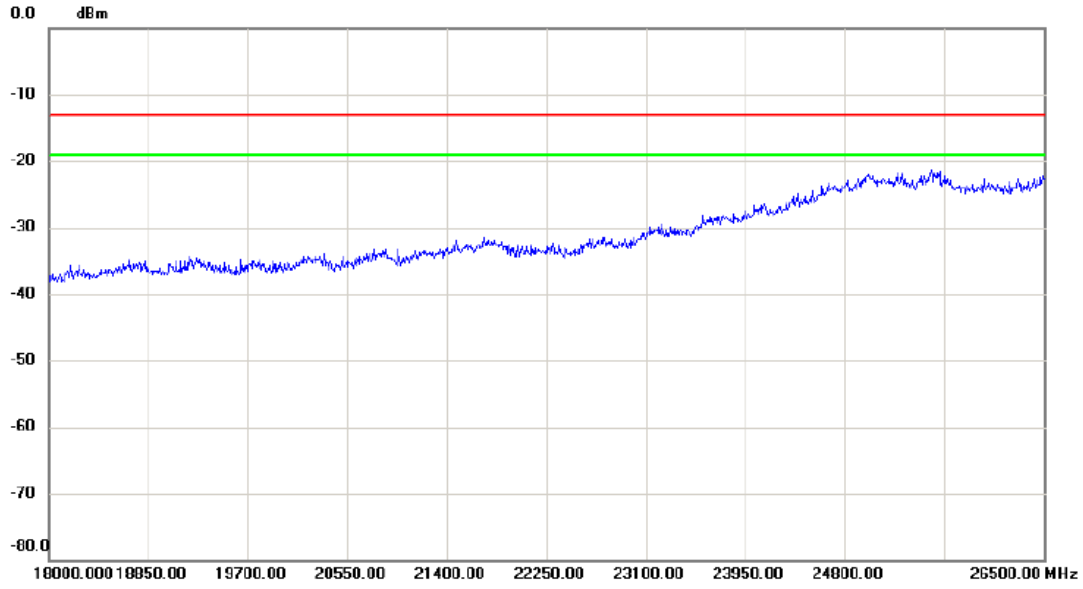

No.	Mk.	Freq.	Reading Level	Correct Factor	Measurement	Limit	Margin	Detector	Comment
		MHz	dBm	dB	dBm	dBm	dB		

Test Mode: LTE Band 2_TX CH18900_20M

Vertical

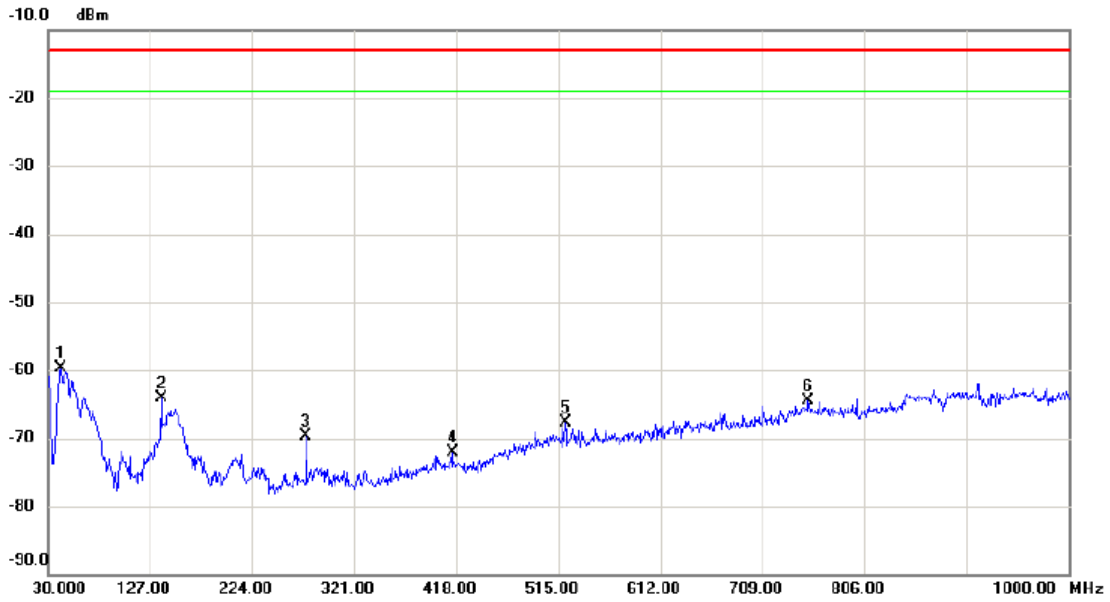

No.	Mk.	Freq. MHz	Reading Level dBm	Correct Factor dB	Measure- ment dBm	Limit dBm	Margin dB	Detector	Comment
1	*	41.640	-61.84	2.06	-59.78	-13.00	-46.78	peak	
2		137.670	-65.61	1.50	-64.11	-13.00	-51.11	peak	
3		275.410	-72.23	2.44	-69.79	-13.00	-56.79	peak	
4		414.120	-76.66	4.49	-72.17	-13.00	-59.17	peak	
5		521.790	-75.29	7.51	-67.78	-13.00	-54.78	peak	
6		752.650	-76.92	12.45	-64.47	-13.00	-51.47	peak	

Test Mode: LTE Band 2_TX CH18900_20M

Horizontal

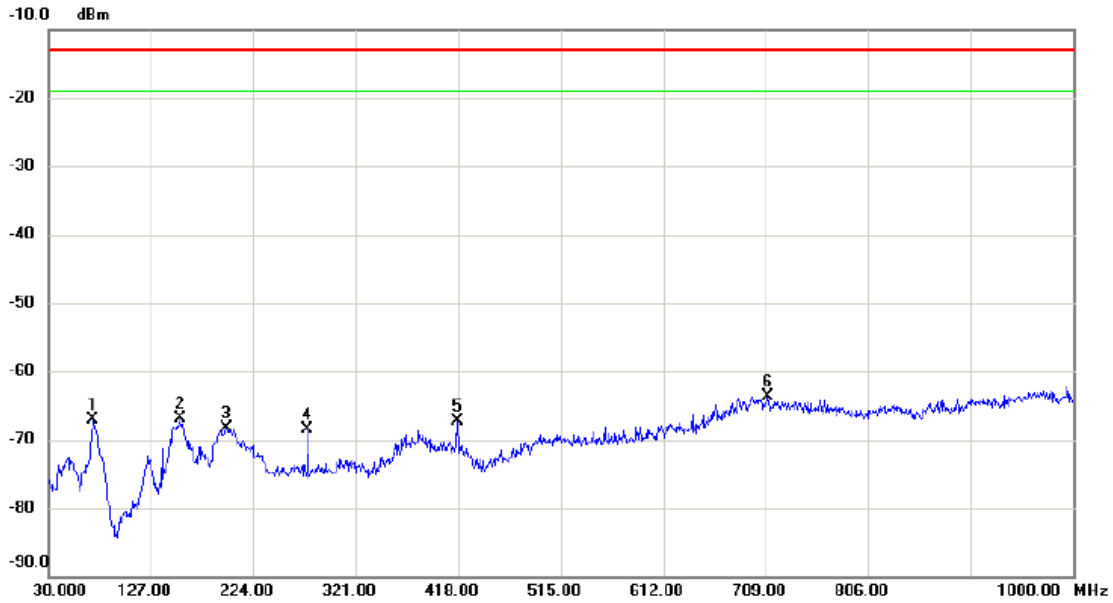

No.	Mk.	Freq. MHz	Reading Level dBm	Correct Factor dB	Measure- ment dBm	Limit dBm	Margin dB	Detector	Comment
1		71.710	-62.13	-5.02	-67.15	-13.00	-54.15	peak	
2		154.160	-70.50	3.62	-66.88	-13.00	-53.88	peak	
3		198.780	-66.37	-1.87	-68.24	-13.00	-55.24	peak	
4		275.410	-71.23	2.74	-68.49	-13.00	-55.49	peak	
5		417.030	-73.98	6.73	-67.25	-13.00	-54.25	peak	
6	*	710.940	-77.39	13.72	-63.67	-13.00	-50.67	peak	

Test Mode: LTE Band 2_TX CH18900_20M

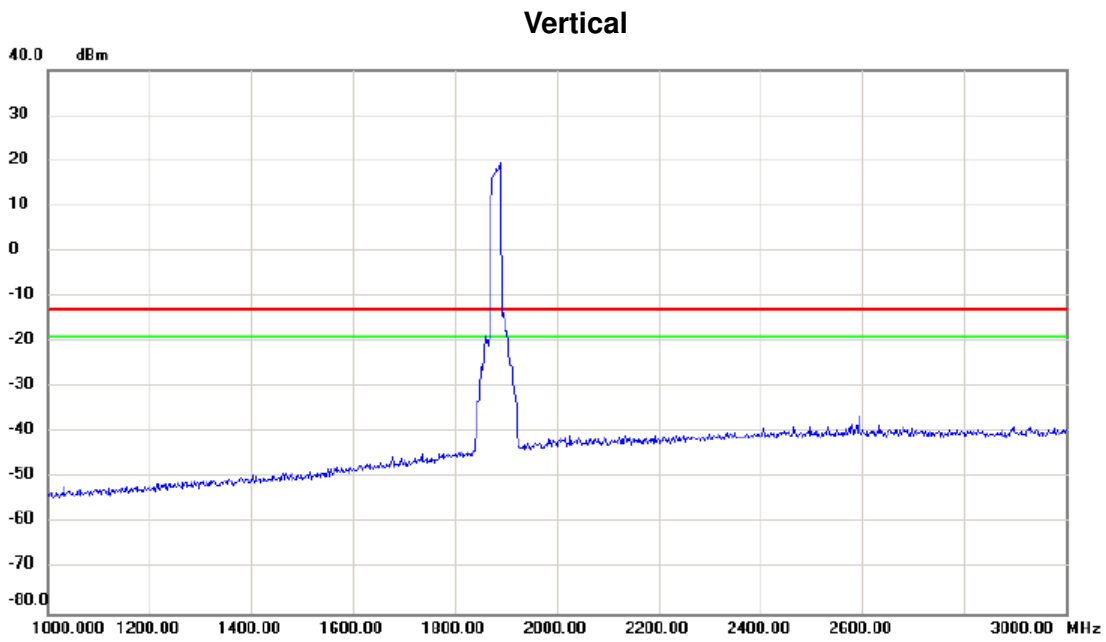

No.	Mk.	Freq.	Reading Level	Correct Factor	Measurement	Limit	Margin	Detector	Comment
		MHz	dBm	dB	dBm	dBm	dB		
		1890.00	18.00	0.00	18.00	-15.00	33.00		

Test Mode: LTE Band 2_TX CH18900_20M

Horizontal

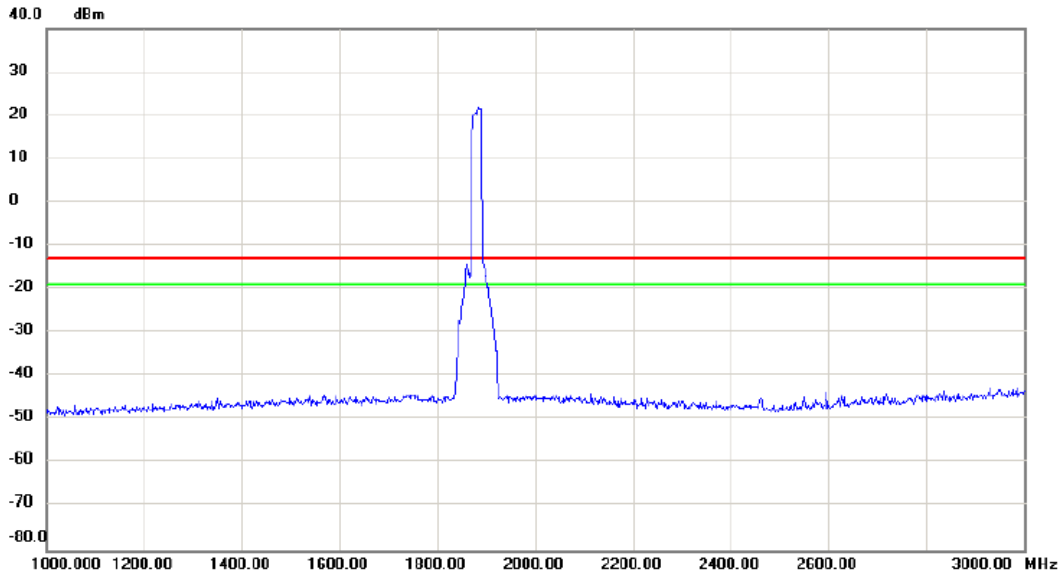

No. Mk.	Freq. MHz	Reading Level dBm	Correct Factor dB	Measure- ment dBm	Limit dBm	Margin dB	Detector	Comment
	1950.00	20.00	0.00	20.00	-15.00	35.00		

Test Mode: LTE Band 2_TX CH18900_20M

Vertical

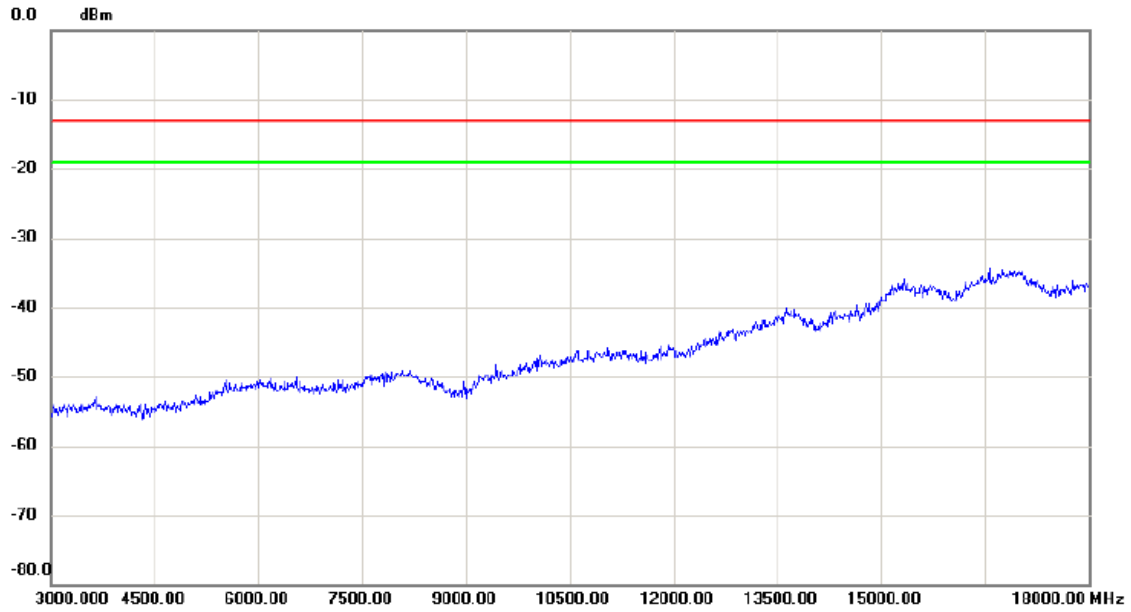

No.	Mk.	Freq.	Reading Level	Correct Factor	Measurement	Limit	Margin	Detector	Comment
		MHz	dBm	dB	dBm	dBm	dB		