



RF TEST REPORT

Applicant Huawei Technologies Co., Ltd.
FCC ID QISAGRK-L09
Product Tablet
Model AGRK-L09
Report No. R2201A0045-R1
Issue Date January 13, 2022

TA Technology (Shanghai) Co., Ltd. tested the above equipment in accordance with the requirements in **FCC CFR47 Part 2 (2020)/ FCC CFR 47 Part 22H (2020)**. The test results show that the equipment tested is capable of demonstrating compliance with the requirements as documented in this report.

Prepared by: Peng Tao

Approved by: Kai Xu

TA Technology (Shanghai) Co., Ltd.

No.145, Jintang Rd, Tangzhen Industry Park, Pudong Shanghai, China

TEL: +86-021-50791141/2/3

FAX: +86-021-50791141/2/3-8000



TABLE OF CONTENT

1. Test Laboratory	4
1.1. Notes of the Test Report	4
1.2. Test facility	4
1.3. Testing Location	4
2. General Description of Equipment under Test.....	5
2.1. Applicant and Manufacturer Information	5
2.2. General Information.....	5
3. Applied Standards	7
4. Test Configuration.....	8
5. Test Case Results.....	10
5.1. RF Power Output and Effective Radiated Power	10
5.2. Occupied Bandwidth	15
5.3. Band Edge Compliance.....	26
5.4. Peak-to-Average Power Ratio (PAPR)	37
5.5. Frequency Stability.....	40
5.6. Spurious Emissions at Antenna Terminals	44
5.7. Radiates Spurious Emission	49
6. Main Test Instruments	55
ANNEX A: The EUT Appearance	56
ANNEX B: Test Setup Photos	57



Summary of measurement results

No.	Test Case	Clause in FCC rules	Verdict
1	RF Power Output and Effective Radiated Power	2.1046 22.913(a)(5)	PASS
2	Occupied Bandwidth	2.1049	PASS
3	Band Edge Compliance	2.1051 / 22.917(a)	PASS
4	Peak-to-Average Power Ratio	22.913(d)/ KDB 971168 D01(5.7)	PASS
5	Frequency Stability	2.1055 / 22.355	PASS
6	Spurious Emissions at Antenna Terminals	2.1051 / 22.917(a)	PASS
7	Radiates Spurious Emission	2.1053 / 22.917 (a)	PASS

Date of Testing: November 25, 2021 ~ December 8, 2021

Date of Sample Received: November 22, 2021

Note: PASS: The EUT complies with the essential requirements in the standard.

FAIL: The EUT does not comply with the essential requirements in the standard.

All indications of Pass/Fail in this report are opinions expressed by TA Technology (Shanghai) Co., Ltd. based on interpretations and/or observations of test results. Measurement Uncertainties were not taken into account and are published for informational purposes only.



1. Test Laboratory

1.1. Notes of the Test Report

This report shall not be reproduced in full or partial, without the written approval of **TA technology (shanghai) co., Ltd.** The results documented in this report apply only to the tested sample, under the conditions and modes of operation as described herein. Measurement Uncertainties were not taken into account and are published for informational purposes only. This report is written to support regulatory compliance of the applicable standards stated above.

1.2. Test facility

FCC (Designation number: CN1179, Test Firm Registration Number: 446626)

TA Technology (Shanghai) Co., Ltd. has been listed on the US Federal Communications Commission list of test facilities recognized to perform measurements.

A2LA (Certificate Number: 3857.01)

TA Technology (Shanghai) Co., Ltd. has been listed by American Association for Laboratory Accreditation to perform measurement.

1.3. Testing Location

Company: TA Technology (Shanghai) Co., Ltd.
Address: No.145, Jintang Rd, Tangzhen Industry Park, Pudong
City: Shanghai
Post code: 201201
Country: P. R. China
Contact: Xu Kai
Telephone: +86-021-50791141/2/3
Fax: +86-021-50791141/2/3-8000
Website: <http://www.ta-shanghai.com>
E-mail: xukai@ta-shanghai.com

2. General Description of Equipment under Test

2.1. Applicant and Manufacturer Information

Applicant	Huawei Technologies Co., Ltd.
Applicant address	Administration Building, Headquarters of Huawei Technologies Co., Ltd., Bantian, Longgang District, Shenzhen, 518129, P.R.C
Manufacturer	Huawei Technologies Co., Ltd.
Manufacturer address	Administration Building, Headquarters of Huawei Technologies Co., Ltd., Bantian, Longgang District, Shenzhen, 518129, P.R.C

2.2. General Information

EUT Description			
Model	AGRK-L09		
SN	9JVYD21A13200045		
Hardware Version	SH1AGS3LM		
Software Version	10.1.0.115(SP5C605E2R1P1)		
Power Supply	Battery / AC adapter		
Antenna Type	Internal Antenna		
Antenna Gain	GSM 850:	-0.5dBi	
	WCDMA Band V:	0.1dBi	
	LTE Band 5:	0.1dBi	
Test Mode(s)	GSM 850; WCDMA Band V; LTE Band 5;		
Test Modulation	(GSM/GPRS)GMSK, (EGPRS) GMSK/ 8PSK; (WCDMA) BPSK, QPSK, 16QAM; (LTE) QPSK, 16QAM, 64QAM;		
GPRS Multislot Class	12		
EGPRS Multislot Class	12		
HSDPA UE Release	R9		
HSUPA UE Release	R9		
LTE Category	5		
Maximum E.R.P.	GSM 850:	29.85dBm	
	WCDMA Band V:	21.79dBm	
	LTE Band 5:	21.80dBm	
Rated Power Supply Voltage	3.82V		
Operating Voltage	Minimum: 3.6V Maximum: 4.4V		
Operating Temperature	Lowest: 0°C Highest: +35°C		
Testing Temperature	Lowest: -20°C Highest: +55°C		
Operating Frequency Range(s)	Band	Tx (MHz)	Rx (MHz)



		GSM850	824 ~ 849	869 ~ 894
		WCDMA Band V	824 ~ 849	869 ~ 894
		LTE Band 5	824 ~ 849	869 ~ 894
EUT Accessory				
Accessory	Model	Manufacture		No.
Adapter	HW-050100U01	HuaweiTechnologies Co., Ltd. (Manufacturer: Huizhou BYD Electronic Co., Ltd.)		1
		HuaweiTechnologies Co., Ltd. (Manufacturer: Shenzhen HUNTKEY Electric Co., Ltd.)		2
Battery	HB2899C0ECW-C	SCUD (Fujian) Electronics Co.,Ltd		1
USB Cable	WA0072	NINGBO BROAD TELECOMMUNICATION CO.,LTD		1
	L99UC154-CS-H	Luxshare Precision Industry Co.,LTD		2
	CUDU01B-HC450-EH	FOXCONN INTERCONNECT TECHNOLOGY LIMITED		3
<p>Note: 1. The EUT is sent from the applicant to TA and the information of the EUT is declared by the applicant.</p> <p>2. There are more than one Adapter and USB Cable, each one should be applied throughout the compliance test respectively, however, only the worst case (Adapter 2 and USB Cable 3) will be recorded in this report.</p>				



3. Applied Standards

According to the specifications of the manufacturer, it must comply with the requirements of the following standards:

Test standards:

FCC CFR 47 Part 22H (2020)

FCC CFR47 Part 2 (2020)

Reference standard:

ANSI C63.26 (2015)

KDB 971168 D01 Power Meas License Digital Systems v03r01

4. Test Configuration

Radiated measurements are performed by rotating the EUT in three different orthogonal test planes. EUT stand-up position (Z axis), lie-down position (X, Y axis). Receiver antenna polarization (horizontal and vertical), the worst emission was found in position GSM/WCDMA for (Z axis, vertical polarization) ; LTE for (X, Y axis, horizontal polarization) and the worst case was recorded.

All mode and data rates and positions and RB size and modulations were investigated. Subsequently, only the worst case emissions are reported.

The following testing in GSM/WCDMA/LTE is set based on the maximum RF Output Power.

Test modes are chosen to be reported as the worst case configuration below:

Test items	Modes/Modulation	
	GSM 850	WCDMA Band V
RF Power Output and Effective Radiated power	GSM GPRS EGPRS	RMC HSDPA/HSUPA DC-HSDPA/HSPA+
Occupied Bandwidth	GSM GPRS(1Tx slot) EGPRS(1Tx slot)	RMC
Band Edge Compliance	GSM GPRS(1Tx slot) EGPRS(1Tx slot)	RMC
Peak-to-Average Power Ratio	GSM GPRS(1Tx slot) EGPRS(1Tx slot)	RMC
Frequency Stability	GSM GPRS(1Tx slot) EGPRS(1Tx slot)	RMC
Spurious Emissions at Antenna Terminals	GSM	RMC
Radiates Spurious Emission	GSM	RMC



Test modes are chosen as the worst case configuration below for LTE Band 5.

Test items	Bandwidth (MHz)				Modulation		RB			Test Channel		
	1.4	3	5	10	QPSK	16QAM/ 64QAM	1	50%	100%	L	M	H
RF power output and Effective Radiated power	O	O	O	O	O	O	O	O	O	O	O	O
Occupied Bandwidth	O	O	O	O	O	O	-	-	O	O	O	O
Band Edge Compliance	O	O	O	O	O	O	O	-	O	O	-	O
Peak-to-Average Power Ratio	O	O	O	O	O	O	-	-	O	O	O	O
Frequency Stability	O	O	O	O	O	O	O	-	-	-	O	-
Spurious Emissions at Antenna Terminals	O	O	O	O	O	-	O	-	-	O	O	O
Radiates Spurious Emission	O	-	O	O	O	-	O	-	-	-	O	-
Note	1. The mark "O" means that this configuration is chosen for testing. 2. The mark "-" means that this configuration is not testing.											

5. Test Case Results

5.1. RF Power Output and Effective Radiated Power

Ambient condition

Temperature	Relative humidity	Pressure
23°C ~25°C	45%~50%	101.5kPa

Methods of Measurement

During the process of the testing, The EUT was connected to the Base Station Simulator with a known loss. The EUT is controlled by the Base Station Simulator test set to ensure max power transmission with proper modulation.

ERP can then be calculated as follows:

$$\text{EIRP (dBm)} = \text{Output Power (dBm)} - \text{Losses (dB)} + \text{Antenna Gain (dBi)}$$

where:dBd refers to gain relative to an ideal dipole.

$$\text{EIRP (dBm)} = \text{ERP (dBm)} + 2.15 \text{ (dB)}.$$

Test Setup

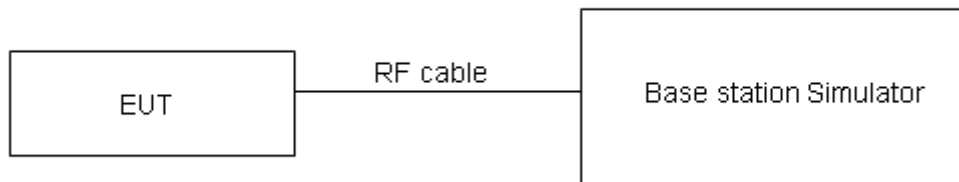

Limits

No specific RF power output requirements in part 2.1046.

Rule Part 22.913(a)(5) specifies that "Mobile/portable stations are limited to 7 watts ERP".

Limit	≤ 7 W (38.45 dBm)
-------	-------------------

Measurement Uncertainty

The assessed measurement uncertainty to ensure 95% confidence level for the normal distribution is with the coverage factor $k = 2$, $U = 0.4$ dB for RF power output, $k = 2$, $U = 1.19$ dB for ERP.

Test Results

GSM 850		Maximum Output Power (dBm)			ERP (dBm)		
		Channel 128	Channel 190	Channel 251	Channel 128	Channel 190	Channel 251
		824.2 (MHz)	836.6 (MHz)	848.8 (MHz)	824.2 (MHz)	836.6 (MHz)	848.8 (MHz)
GSM(GMSK)	Results	32.50	32.31	32.15	29.85	29.66	29.50
GPRS (GMSK)	1TXslot	32.42	32.33	32.20	29.77	29.68	29.55
	2TXslots	30.17	30.20	30.26	27.52	27.55	27.61
	3TXslots	28.00	28.11	28.18	25.35	25.46	25.53
	4TXslots	26.13	26.35	26.41	23.48	23.70	23.76
EGPRS (8PSK)	1TXslot	25.53	25.78	25.51	22.88	23.13	22.86
	2TXslots	23.54	23.51	23.47	20.89	20.86	20.82
	3TXslots	21.47	21.54	21.58	18.82	18.89	18.93
	4TXslots	20.47	20.50	20.50	17.82	17.85	17.85

WCDMA Band V		Maximum Output Power (dBm)			ERP (dBm)		
		Channel 4132	Channel 4183	Channel 4233	Channel 4132	Channel 4183	Channel 4233
		826.4 (MHz)	836.6 (MHz)	846.6 (MHz)	826.4 (MHz)	836.6 (MHz)	846.6 (MHz)
RMC		23.71	23.63	23.74	21.66	21.58	21.69
AMR		23.63	23.49	23.84	21.58	21.44	21.79
HSDPA	Sub - Test 1	23.43	23.35	23.26	21.38	21.30	21.21
	Sub - Test 2	22.51	22.61	22.48	20.46	20.56	20.43
	Sub - Test 3	21.95	22.17	22.12	19.90	20.12	20.07
	Sub - Test 4	22.25	21.97	22.14	20.20	19.92	20.09
HSUPA	Sub - Test 1	21.61	21.61	21.76	19.56	19.56	19.71
	Sub - Test 2	20.17	20.21	20.28	18.12	18.16	18.23
	Sub - Test 3	20.95	20.61	20.86	18.90	18.56	18.81
	Sub - Test 4	20.11	19.77	20.08	18.06	17.72	18.03
	Sub - Test 5	21.75	21.75	21.76	19.70	19.70	19.71
DC-HSDPA	Sub - Test 1	23.39	23.33	23.24	21.34	21.28	21.19
	Sub - Test 2	22.61	22.47	22.66	20.56	20.42	20.61
	Sub - Test 3	22.09	21.89	22.28	20.04	19.84	20.23
	Sub - Test 4	22.35	21.97	22.12	20.30	19.92	20.07
HSPA+	16QAM	20.95	20.93	21.06	18.90	18.88	19.01



LTE Band 5				Maximum Output Power(dBm)			ERP (dBm)		
BW	Modulation	RB size	RB offset	Channel/Frequency(MHz)					
				20407 /824.7	20525 /836.5	20643 /848.3	20407 /824.7	20525 /836.5	20643 /848.3
1.4MHz	QPSK	1	0	23.78	23.81	23.68	21.73	21.76	21.63
		1	2	23.67	23.64	23.52	21.62	21.59	21.47
		1	5	23.68	23.63	23.67	21.63	21.58	21.62
		3	0	23.72	23.66	23.66	21.67	21.61	21.61
		3	2	23.67	23.77	23.66	21.62	21.72	21.61
		3	3	23.74	23.66	23.66	21.69	21.61	21.61
		6	0	22.72	22.75	22.72	20.67	20.70	20.67
	16QAM	1	0	22.36	22.95	22.55	20.31	20.90	20.50
		1	2	22.34	22.95	22.25	20.29	20.90	20.20
		1	5	22.44	22.96	22.56	20.39	20.91	20.51
		3	0	22.12	22.65	22.19	20.07	20.60	20.14
		3	2	22.18	22.65	22.20	20.13	20.60	20.15
		3	3	22.15	22.70	22.19	20.10	20.65	20.14
		6	0	21.20	21.75	21.30	19.15	19.70	19.25
	64QAM	1	0	21.48	21.46	21.46	19.43	19.41	19.41
		1	2	21.32	21.34	21.42	19.27	19.29	19.37
		1	5	21.49	21.57	21.53	19.44	19.52	19.48
		3	0	21.16	21.09	21.21	19.11	19.04	19.16
		3	2	21.20	21.26	21.21	19.15	19.21	19.16
		3	3	21.23	21.22	21.27	19.18	19.17	19.22
		6	0	20.19	20.31	20.27	18.14	18.26	18.22
BW	Modulation	RB size	RB offset	Channel/Frequency(MHz)					
				20415 /825.5	20525 /836.5	20635 /847.5	20415 /825.5	20525 /836.5	20635 /847.5
3MHz	QPSK	1	0	23.80	23.85	23.71	21.75	21.80	21.66
		1	7	23.65	23.67	23.56	21.60	21.62	21.51
		1	14	23.71	23.68	23.71	21.66	21.63	21.66
		8	0	22.82	22.78	22.79	20.77	20.73	20.74
		8	4	22.79	22.87	22.78	20.74	20.82	20.73
		8	7	22.84	22.77	22.76	20.79	20.72	20.71
		15	0	22.72	22.79	22.75	20.67	20.74	20.70
	16QAM	1	0	22.39	22.97	22.58	20.34	20.92	20.53



BW	Modulation	RB size	RB offset	Channel/Frequency(MHz)						
				20425	20525	20625	20425	20525	20625	
				/826.5	/836.5	/846.5	/826.5	/836.5	/846.5	
		1	7	22.37	22.95	22.29	20.32	20.90	20.24	
		1	14	22.46	23.00	22.59	20.41	20.95	20.54	
		8	0	21.23	21.78	21.31	19.18	19.73	19.26	
		8	4	21.29	21.78	21.32	19.24	19.73	19.27	
		8	7	21.25	21.82	21.32	19.20	19.77	19.27	
		15	0	21.23	21.79	21.33	19.18	19.74	19.28	
	64QAM	1	0	21.51	21.48	21.49	19.46	19.43	19.44	
		1	7	21.35	21.34	21.44	19.30	19.29	19.39	
		1	14	21.51	21.56	21.56	19.46	19.51	19.51	
		8	0	20.27	20.22	20.33	18.22	18.17	18.28	
		8	4	20.31	20.39	20.33	18.26	18.34	18.28	
		8	7	20.33	20.34	20.40	18.28	18.29	18.35	
			15	0	20.22	20.35	20.30	18.17	18.30	18.25
	5MHz	QPSK	1	0	23.77	23.83	23.67	21.72	21.78	21.62
1			13	23.63	23.63	23.53	21.58	21.58	21.48	
1			24	23.68	23.63	23.67	21.63	21.58	21.62	
12			0	22.79	22.73	22.75	20.74	20.68	20.70	
12			6	22.77	22.83	22.73	20.72	20.78	20.68	
12			13	22.82	22.75	22.72	20.77	20.70	20.67	
25			0	22.72	22.78	22.73	20.67	20.73	20.68	
16QAM		1	0	22.36	22.93	22.55	20.31	20.88	20.50	
		1	13	22.34	22.93	22.26	20.29	20.88	20.21	
		1	24	22.43	22.98	22.55	20.38	20.93	20.50	
		12	0	21.21	21.74	21.28	19.16	19.69	19.23	
		12	6	21.26	21.73	21.28	19.21	19.68	19.23	
		12	13	21.22	21.77	21.28	19.17	19.72	19.23	
		25	0	21.21	21.75	21.28	19.16	19.70	19.23	
64QAM		1	0	21.48	21.48	21.46	19.43	19.43	19.41	
		1	13	21.32	21.36	21.41	19.27	19.31	19.36	
		1	24	21.52	21.54	21.52	19.47	19.49	19.47	
		12	0	20.25	20.18	20.34	18.20	18.13	18.29	
		12	6	20.28	20.34	20.29	18.23	18.29	18.24	
		12	13	20.30	20.29	20.36	18.25	18.24	18.31	
		25	0	20.20	20.31	20.25	18.15	18.26	18.20	



BW	Modulation	RB size	RB offset	Channel/Frequency(MHz)					
				20450 /829	20525 /836.5	20600 /844	20450 /829	20525 /836.5	20600 /844
10MHz	QPSK	1	0	23.75	23.76	23.65	21.70	21.71	21.60
		1	25	23.63	23.63	23.52	21.58	21.58	21.47
		1	49	23.65	23.61	23.63	21.60	21.56	21.58
		25	0	22.77	22.69	22.72	20.72	20.64	20.67
		25	13	22.75	22.79	22.70	20.70	20.74	20.65
		25	25	22.78	22.71	22.69	20.73	20.66	20.64
		50	0	22.71	22.71	22.68	20.66	20.66	20.63
	16QAM	1	0	22.44	22.90	22.50	20.39	20.85	20.45
		1	25	22.31	22.92	22.23	20.26	20.87	20.18
		1	49	22.41	22.93	22.53	20.36	20.88	20.48
		25	0	21.18	21.73	21.26	19.13	19.68	19.21
		25	13	21.22	21.70	21.24	19.17	19.65	19.19
		25	25	21.20	21.73	21.25	19.15	19.68	19.20
		50	0	21.19	21.71	21.25	19.14	19.66	19.20
	64QAM	1	0	21.43	21.41	21.41	19.38	19.36	19.36
		1	25	21.29	21.31	21.38	19.24	19.26	19.33
		1	49	21.46	21.49	21.50	19.41	19.44	19.45
		25	0	20.22	20.17	20.28	18.17	18.12	18.23
		25	13	20.24	20.31	20.25	18.19	18.26	18.20
		25	25	20.28	20.25	20.33	18.23	18.20	18.28
		50	0	20.18	20.27	20.22	18.13	18.22	18.17

5.2. Occupied Bandwidth

Ambient condition

Temperature	Relative humidity	Pressure
23°C ~25°C	45%~50%	101.5kPa

Method of Measurement

The EUT was connected to Spectrum Analyzer and Base Station Simulator via power Splitter. The occupied bandwidth is measured using spectrum analyzer.

RBW is set to $\geq 1\%$ EBW, VBW is set to 3x RBW.

99% power and -26dBc occupied bandwidths are recorded. Spectrum analyzer plots are included on the following pages.

Test Setup

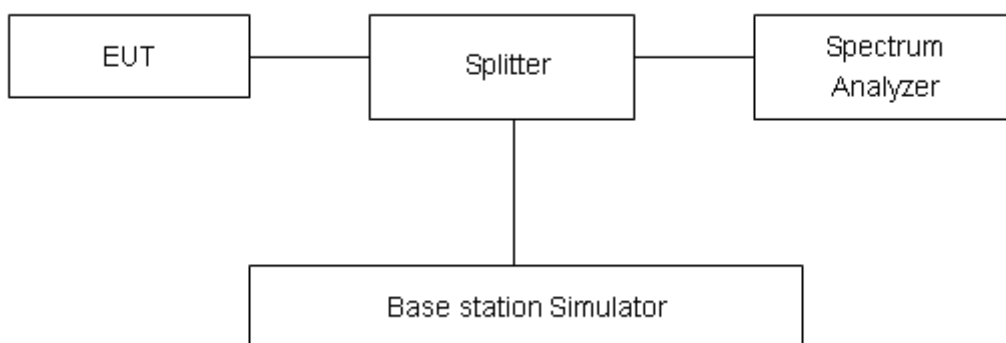

Limits

No specific occupied bandwidth requirements in part 2.1049.

Measurement Uncertainty

The assessed measurement uncertainty to ensure 95% confidence level for the normal distribution is with the coverage factor $k = 2$, $U = 624\text{Hz}$.



Test Result

Mode	Channel	Frequency (MHz)	99% Power Bandwidth (MHz)	-26dBc Bandwidth(MHz)
GSM 850 (GMSK)	128	824.2	0.244	0.307
	190	836.6	0.246	0.312
	251	848.8	0.246	0.316
GPRS 850 (GMSK)	128	824.2	0.244	0.317
	190	836.6	0.243	0.314
	251	848.8	0.248	0.315
EGPRS 850 (8PSK)	128	824.2	0.247	0.314
	190	836.6	0.249	0.310
	251	848.8	0.249	0.311
WCDMA Band V (RMC)	4132	826.4	4.172	4.721
	4183	836.6	4.170	4.681
	4233	846.6	4.153	4.684

LTE Band 5						
RB	Modulation	Bandwidth (MHz)	Channel	Frequency (MHz)	99% Power Bandwidth(MHz)	-26dBc Bandwidth(MHz)
100%	QPSK	1.4	20407	824.7	1.090	1.232
			20525	836.5	1.099	1.251
			20643	848.3	1.105	1.244
		3	20415	825.5	2.698	2.980
			20525	836.5	2.697	2.988
			20635	847.5	2.717	2.994
		5	20425	826.5	4.512	4.942
			20525	836.5	4.501	4.956
			20625	846.5	4.508	4.976
		10	20450	829	8.997	9.831
			20525	836.5	9.005	9.782
			20600	844	8.982	9.824
	16QAM	1.4	20407	824.7	1.094	1.248
			20525	836.5	1.094	1.243
			20643	848.3	1.091	1.239
3		20415	825.5	2.707	2.969	



			20525	836.5	2.712	2.982
			20635	847.5	2.711	2.972
		5	20425	826.5	4.512	4.958
			20525	836.5	4.518	4.956
			20625	846.5	4.507	4.978
		10	20450	829	8.986	9.867
			20525	836.5	8.987	9.711
			20600	844	9.001	9.768
		64QAM	1.4	20407	824.7	1.095
	20525			836.5	1.095	1.255
	20643			848.3	1.098	1.236
	3		20415	825.5	2.700	2.975
			20525	836.5	2.705	2.979
			20635	847.5	2.724	2.972
	5		20425	826.5	4.518	4.969
			20525	836.5	4.512	4.931
			20625	846.5	4.532	4.948
	10		20450	829	9.012	9.847
20525			836.5	8.975	9.839	
20600			844	9.002	9.754	

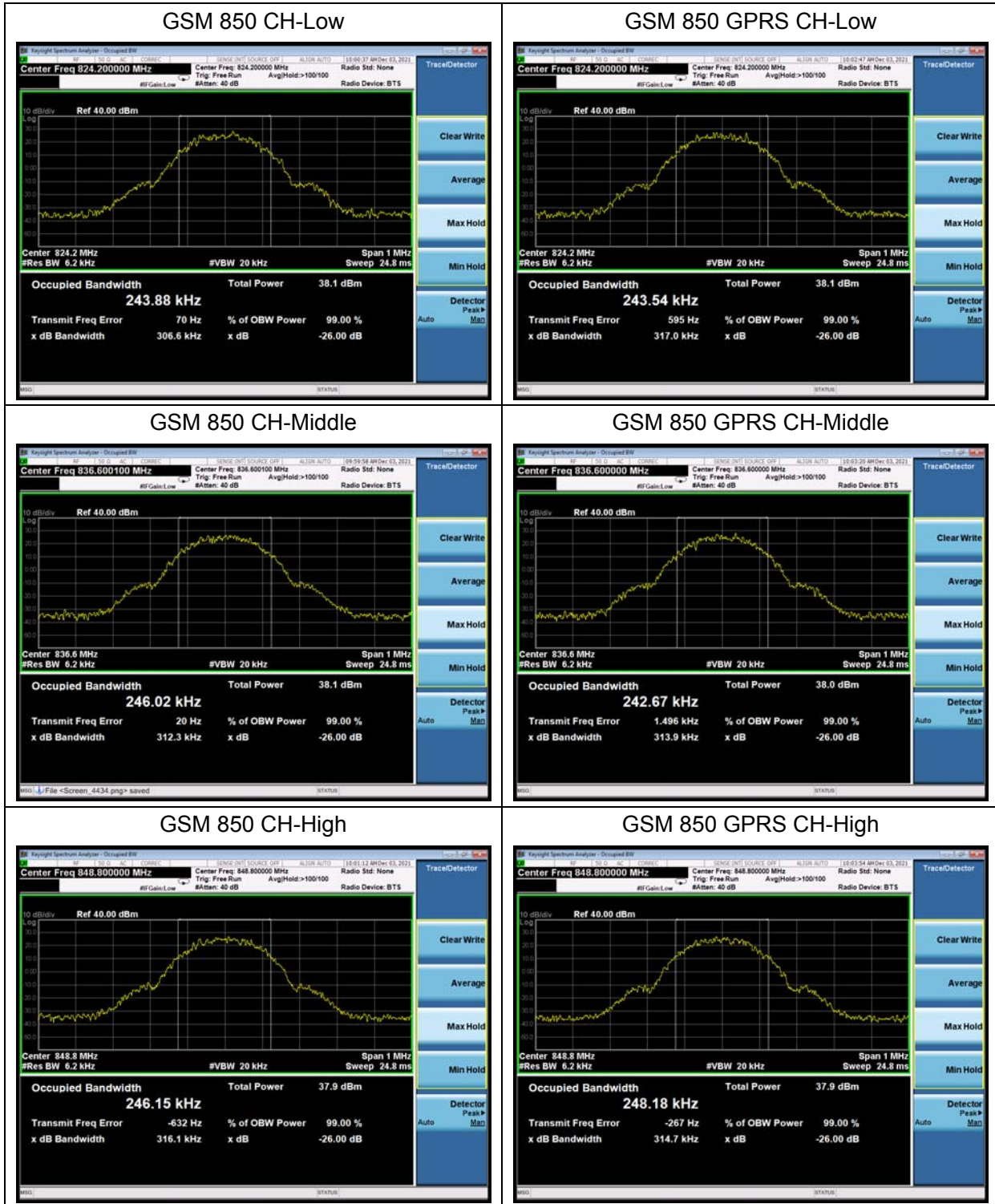

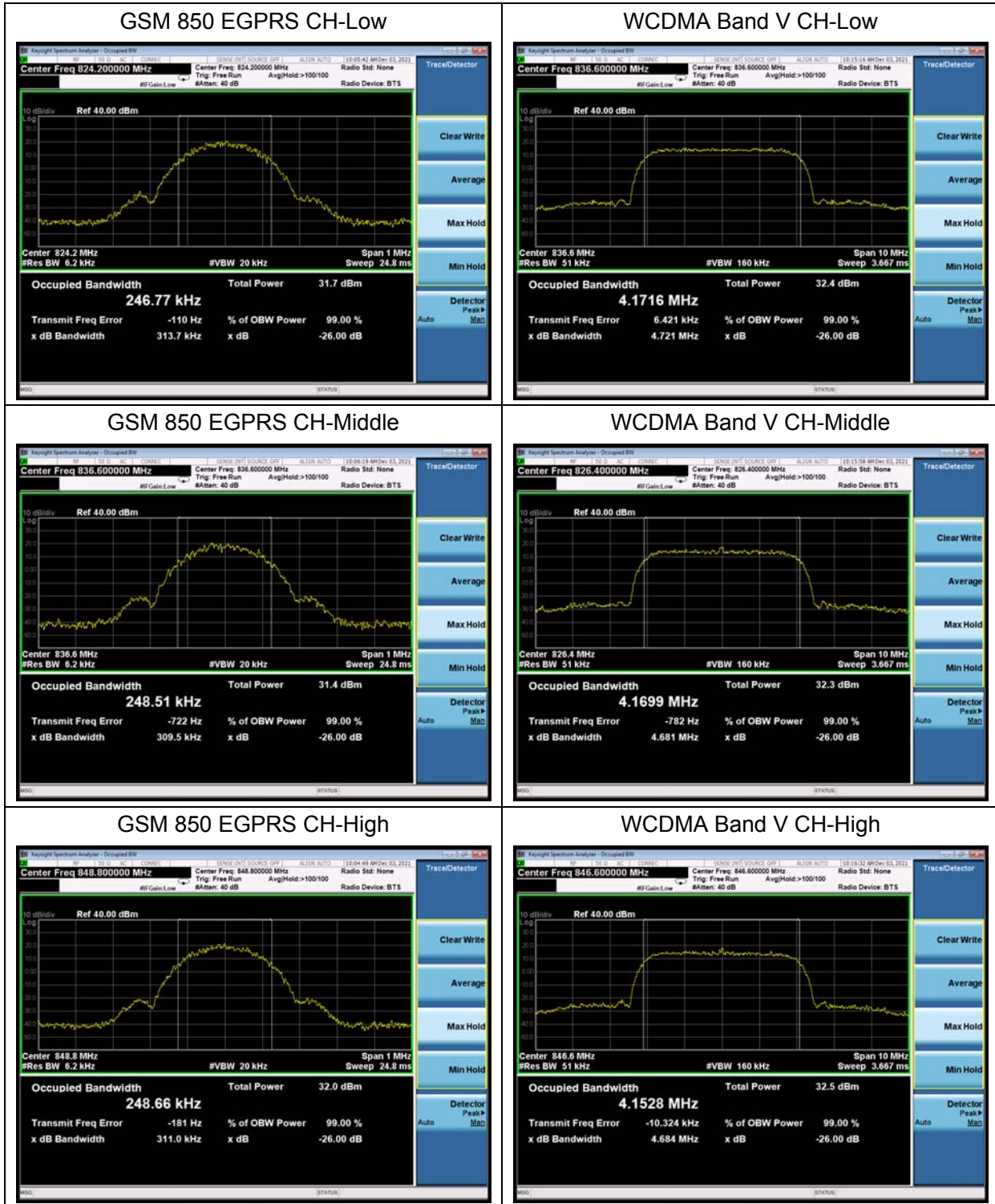

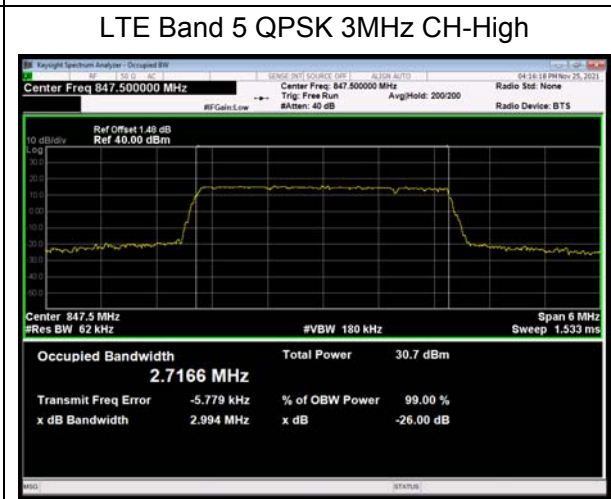
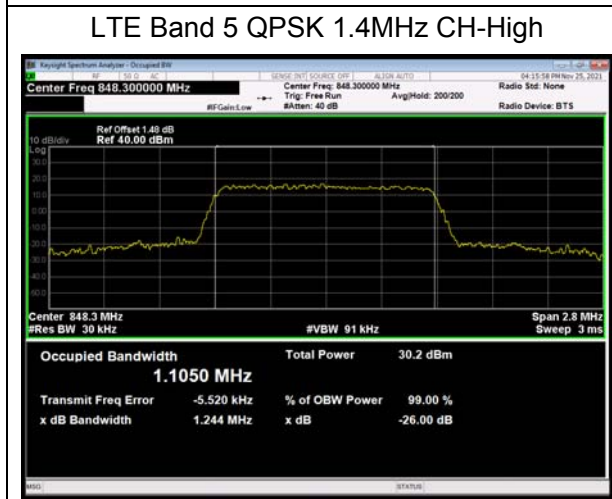
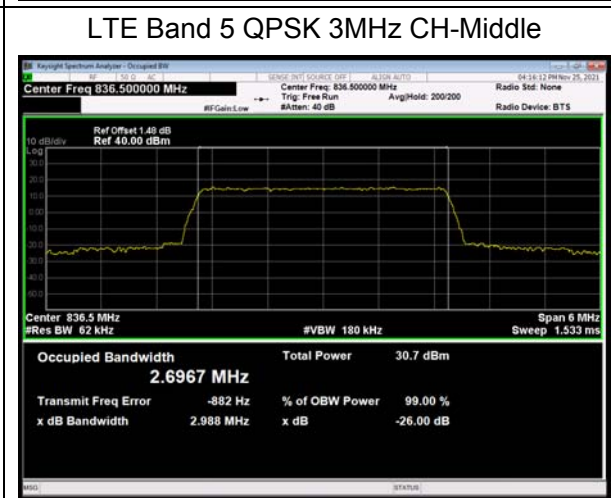
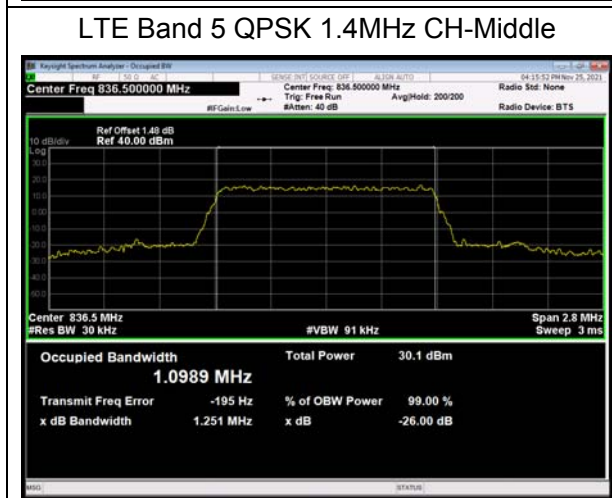
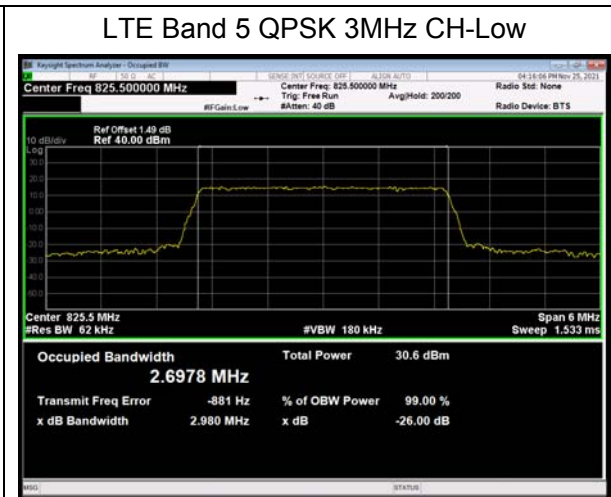
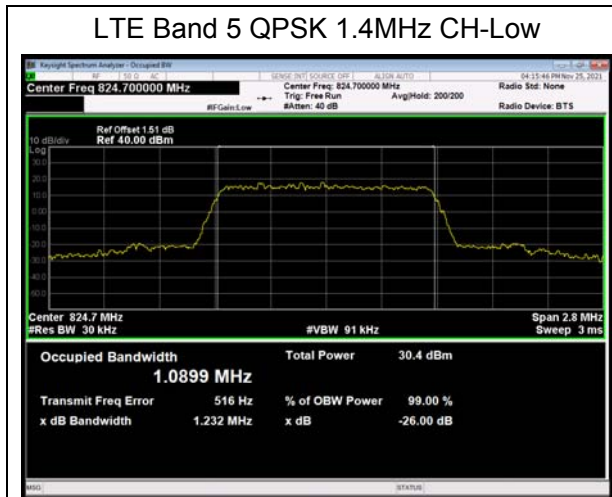

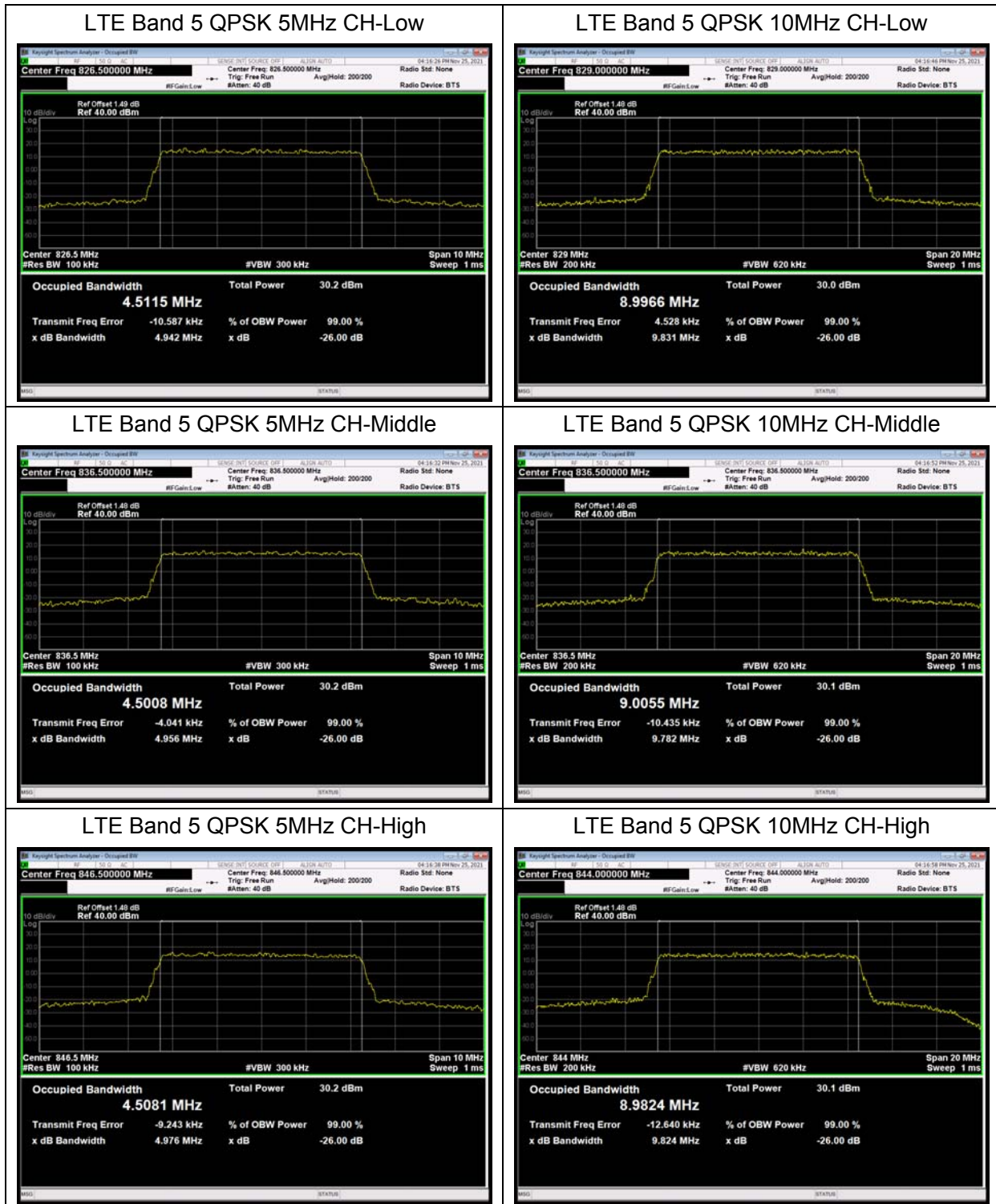

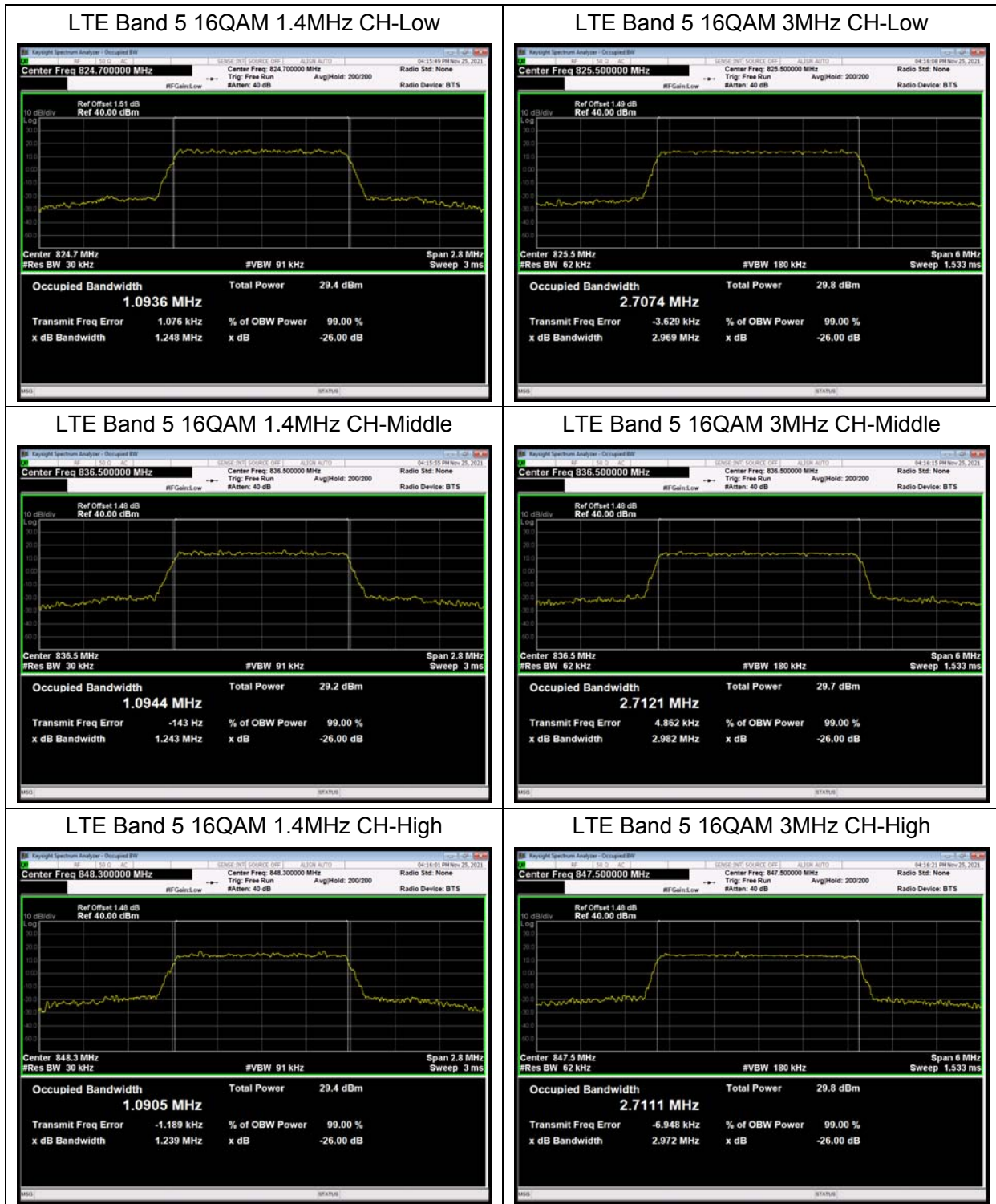

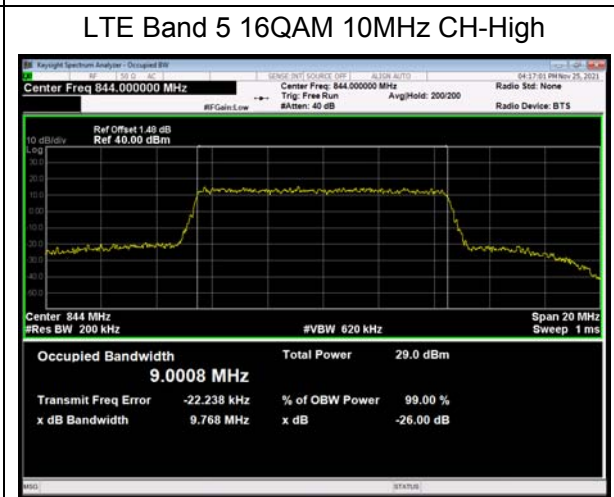
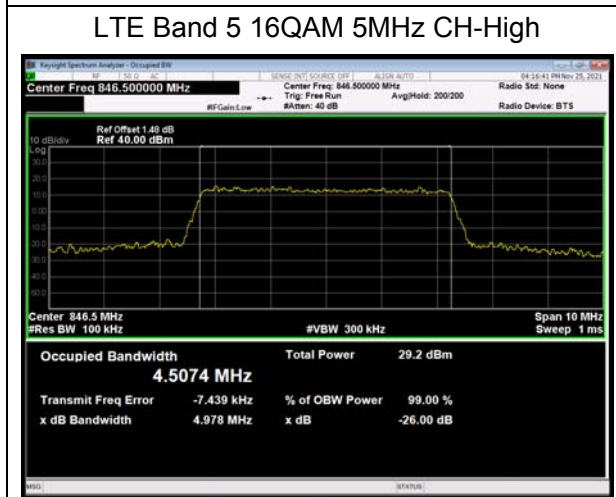
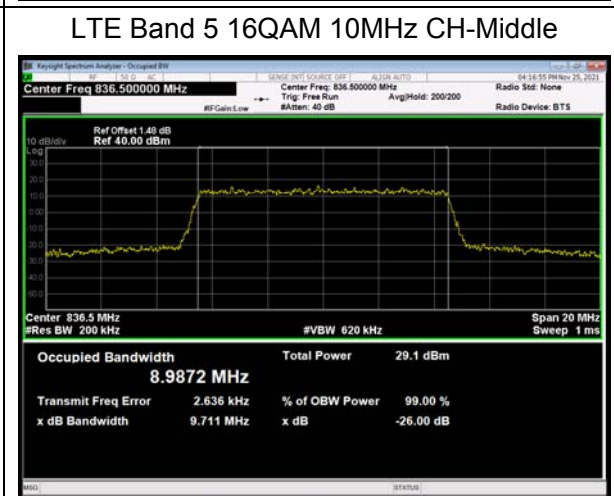
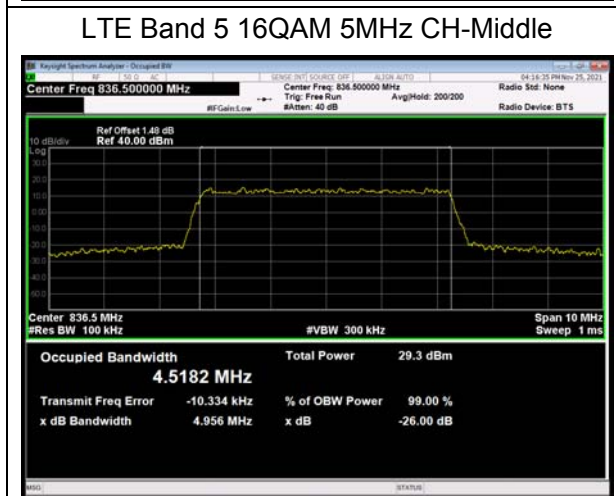
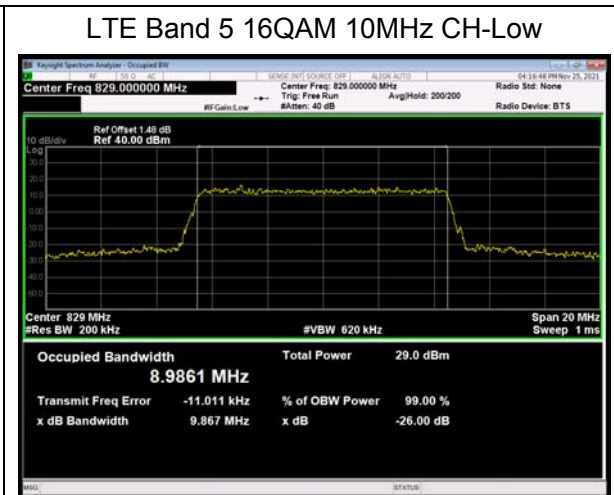
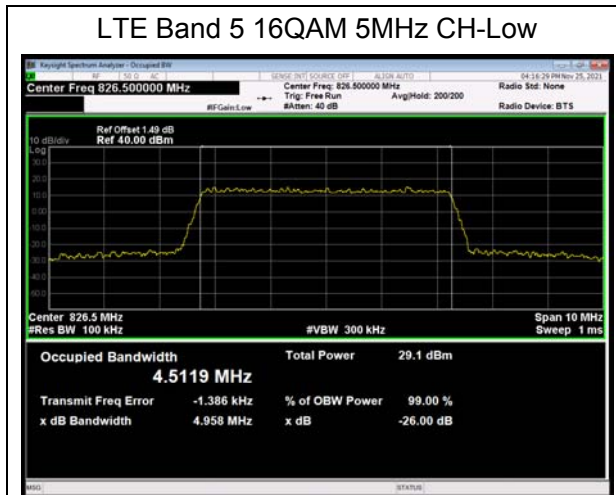

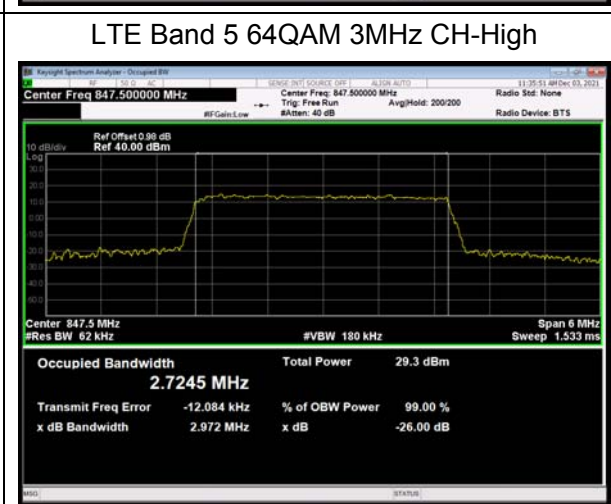
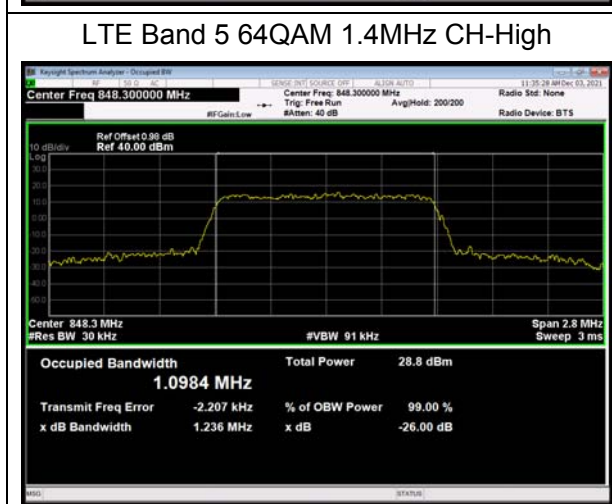
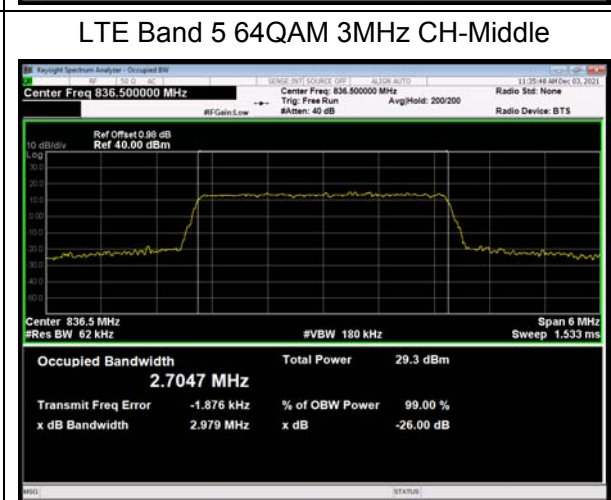
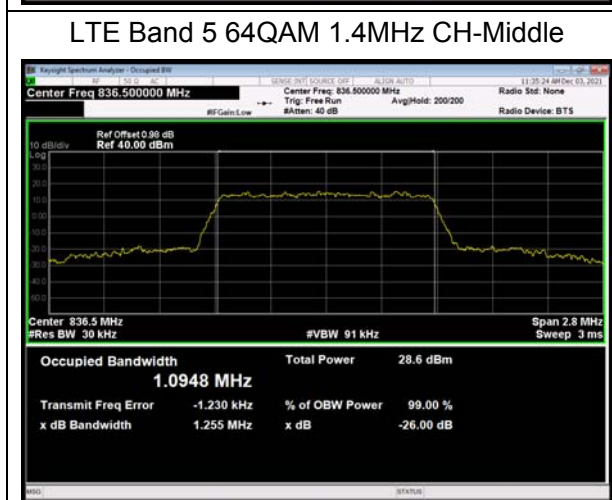
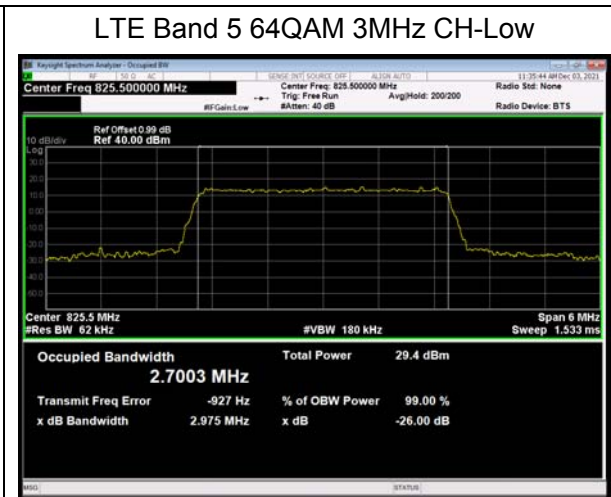
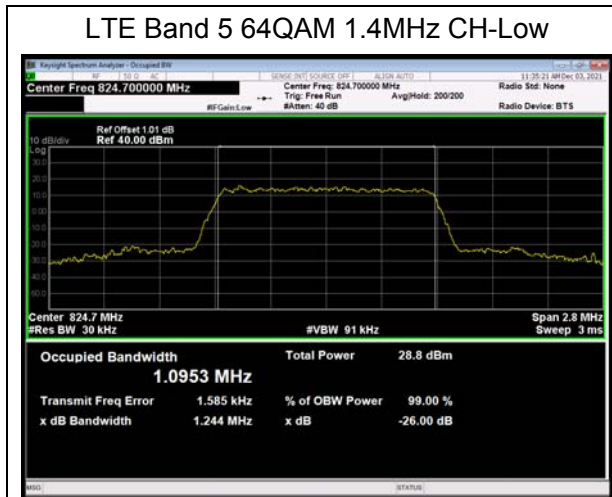

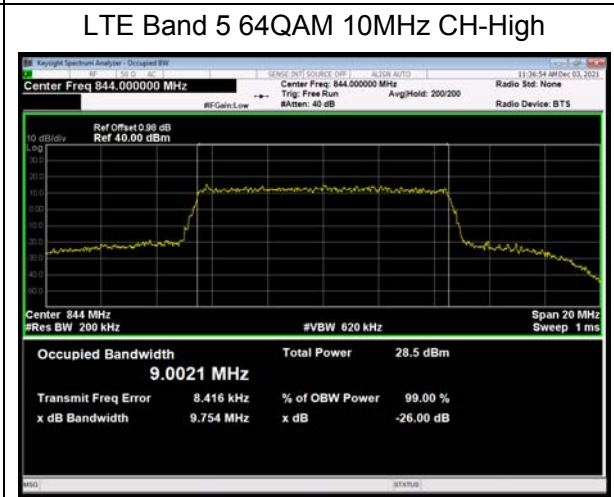
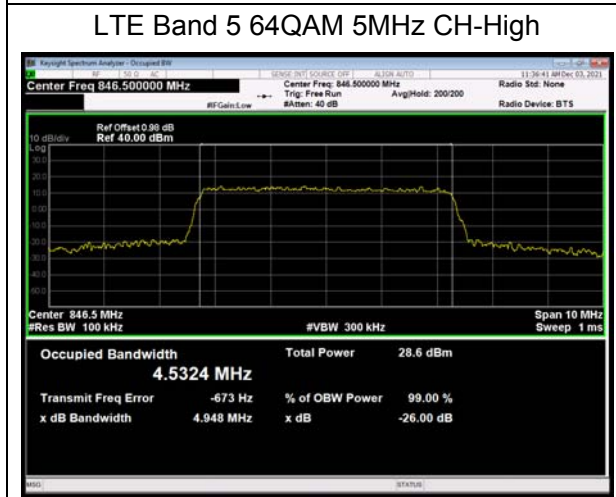
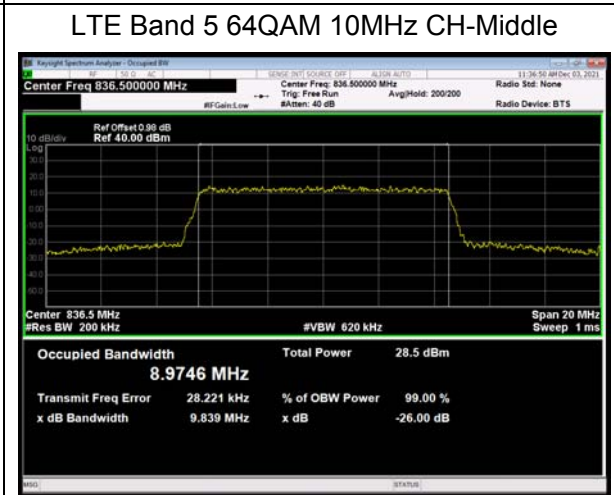
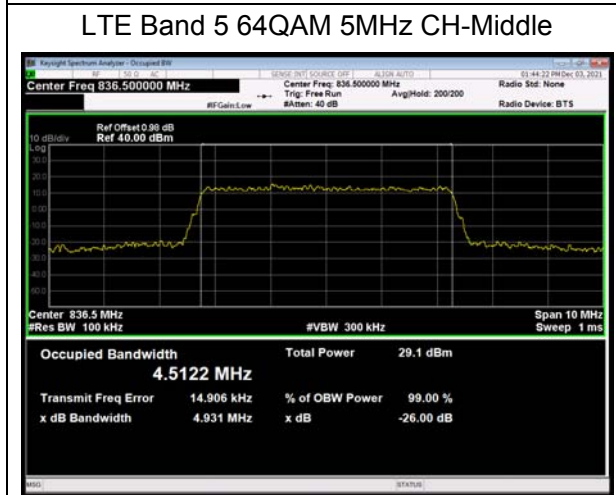
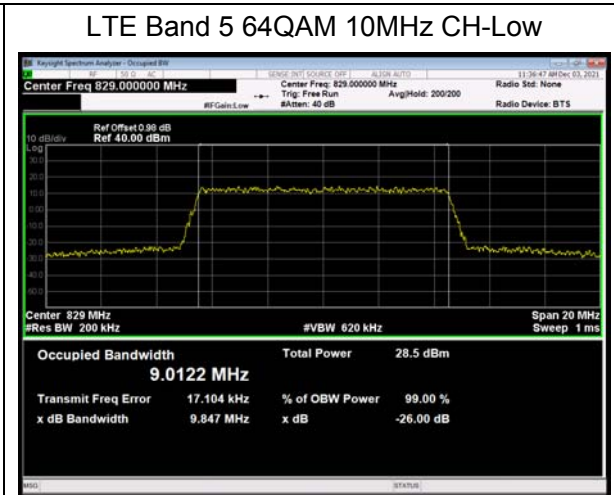
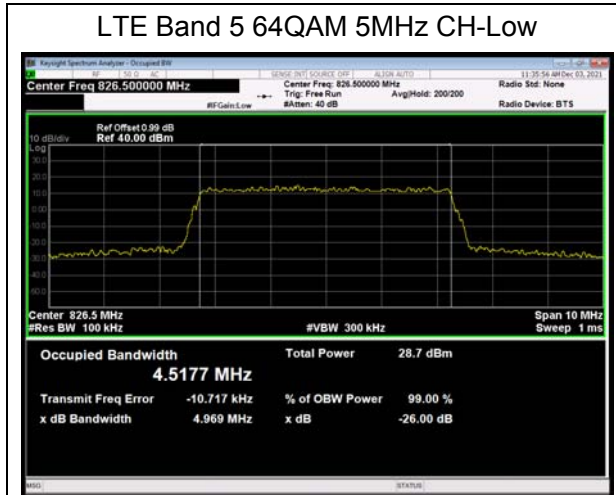

5.3. Band Edge Compliance

Ambient condition

Temperature	Relative humidity	Pressure
23°C ~25°C	45%~50%	101.5kPa

Method of Measurement

The EUT was connected to Spectrum Analyzer and Base Station Simulator via power Splitter. The band edge of the lowest and highest channels were measured. The average detector is used. RBW is set to $\geq 1\%EBW$, VBW is set to 3x RBW.

Spectrum analyzer plots are included on the following pages.

Test Setup

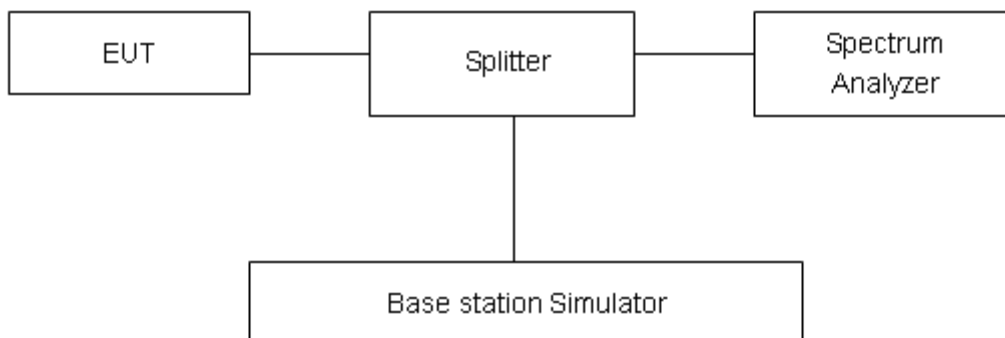

Limits

Rule Part 22.917(a) specifies that “The power of any emission outside of the authorized operating frequency ranges must be attenuated below the transmitting power (P) by a factor of at least 43 + 10 log(P) dB.”

Limit	-13 dBm
-------	---------

Measurement Uncertainty

The assessed measurement uncertainty to ensure 95% confidence level for the normal distribution is with the coverage factor $k = 1.96$, $U=0.684dB$.

Test Result:

GSM 850 CH-Low



GSM 850 CH-High



GSM 850 GPRS CH-Low



GSM 850 GPRS CH-High

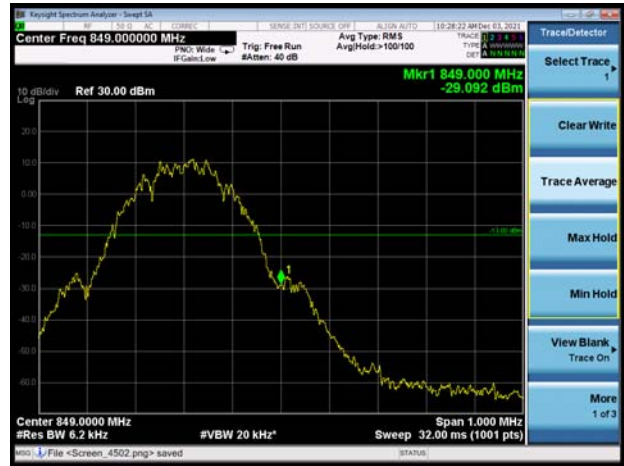

GSM 850 EGPRS CH-Low



GSM 850 EGPRS CH-High

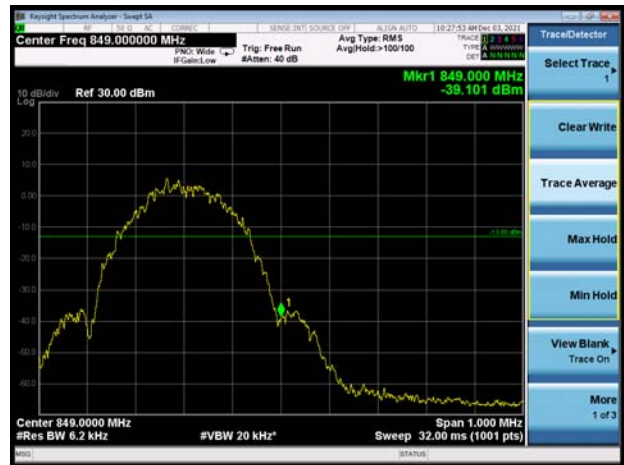



WCDMA Band V CH-Low

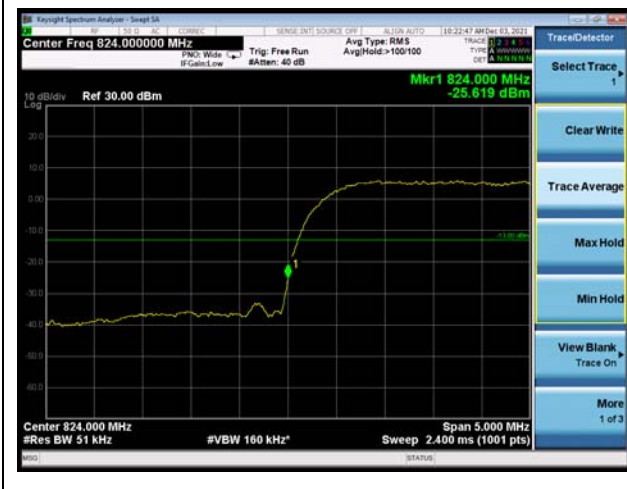

WCDMA Band V CH-High



LTE Band 5 QPSK 1.4MHz CH-Low 1RB

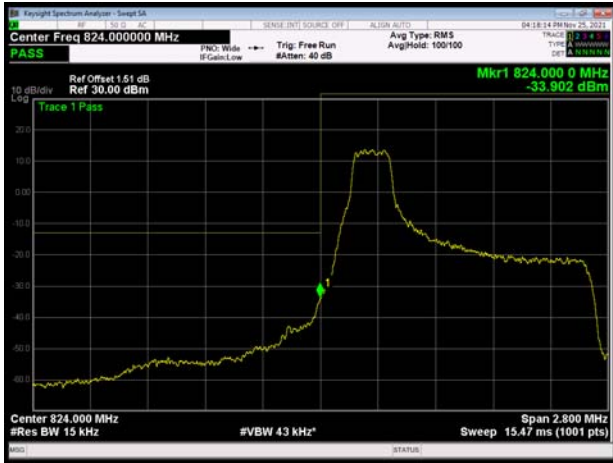

LTE Band 5 QPSK 1.4MHz CH-High 1RB

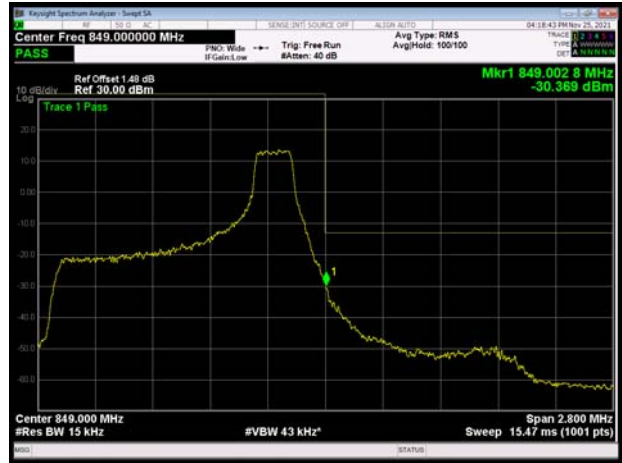

LTE Band 5 QPSK 1.4MHz CH-Low 100%RB

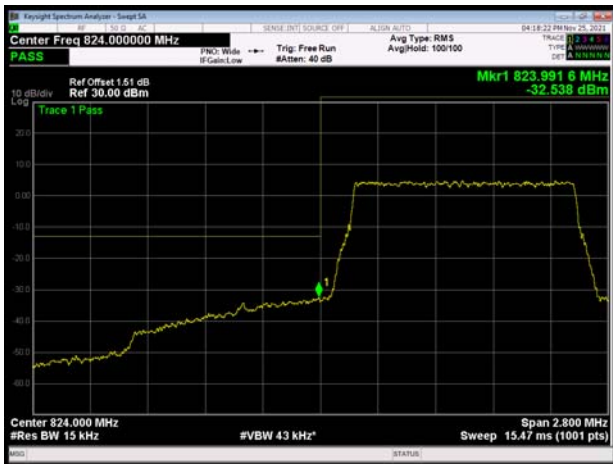

LTE Band 5 QPSK 1.4MHz CH-High 100%RB



LTE Band 5 QPSK 3MHz CH-Low 1RB

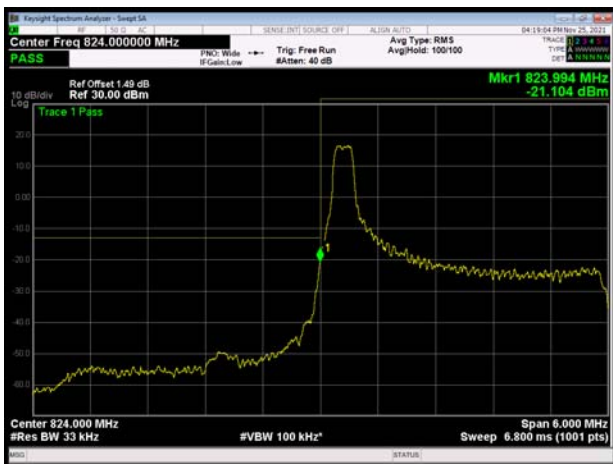

LTE Band 5 QPSK 3MHz CH-High 1RB

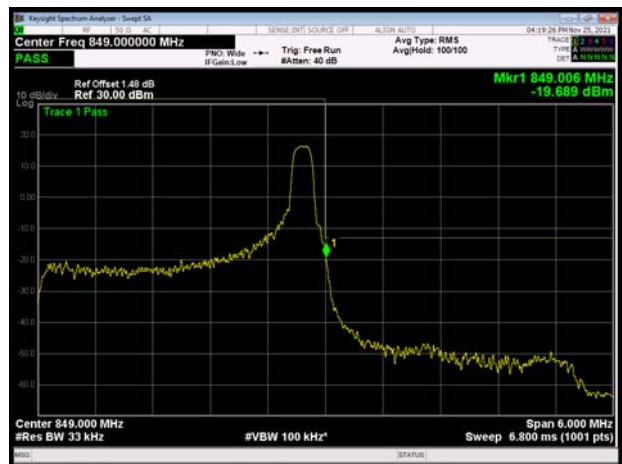

LTE Band 5 QPSK 3MHz CH-Low 100%RB

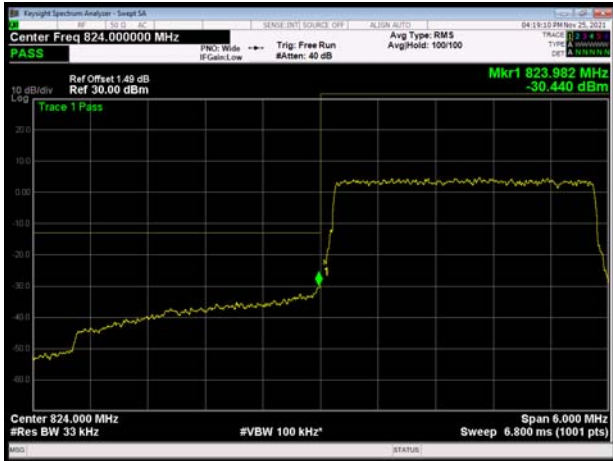

LTE Band 5 QPSK 3MHz CH-High 100%RB



LTE Band 5 QPSK 5MHz CH-Low 1RB

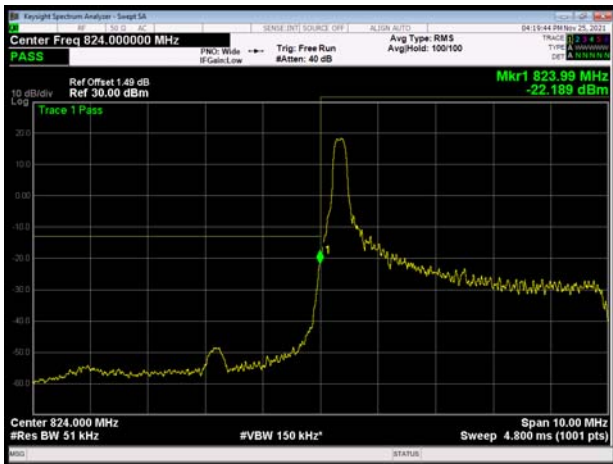

LTE Band 5 QPSK 5MHz CH-High 1RB

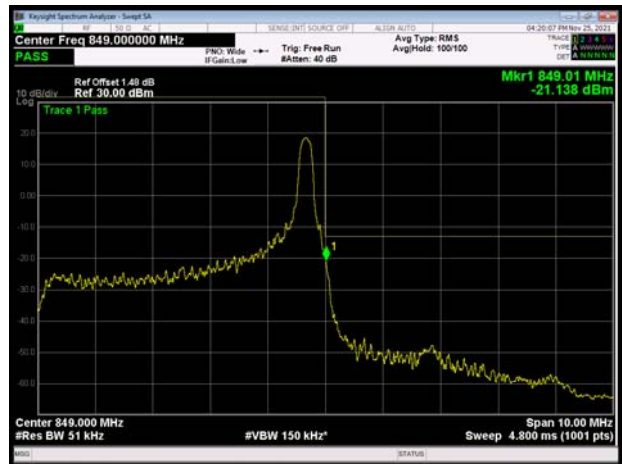

LTE Band 5 QPSK 5MHz CH-Low 100%RB

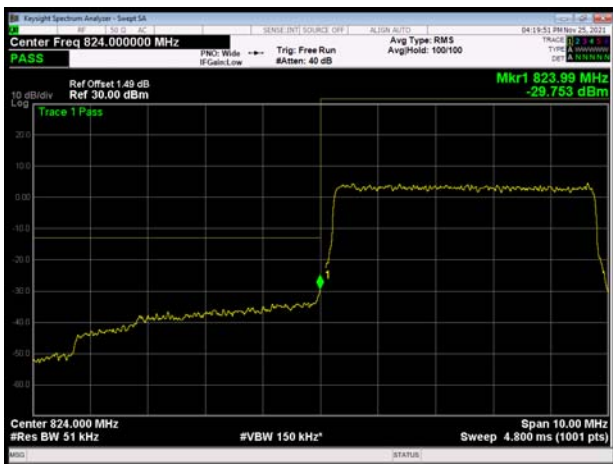

LTE Band 5 QPSK 5MHz CH-High 100%RB

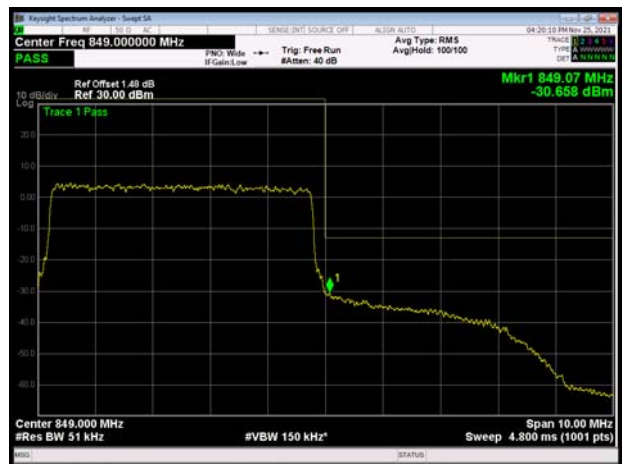

LTE Band 5 QPSK 10MHz CH-Low 1RB

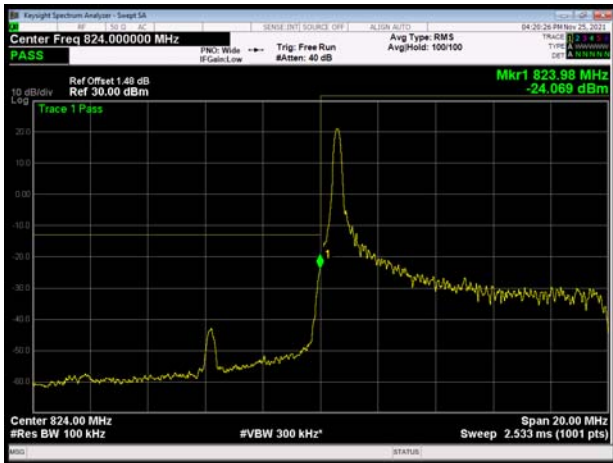

LTE Band 5 QPSK 10MHz CH-High 1RB

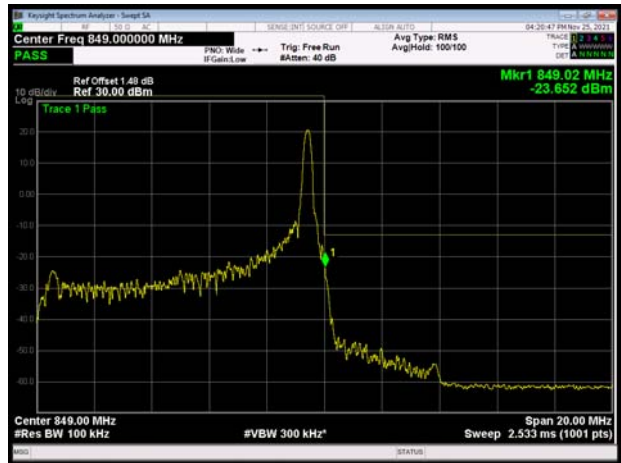

LTE Band 5 QPSK 10MHz CH-Low 100%RB

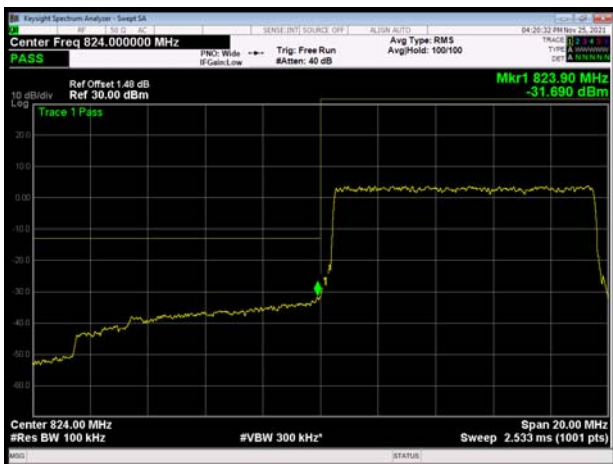

LTE Band 5 QPSK 10MHz CH-High 100%RB



LTE Band 5 16QAM 1.4MHz CH-Low 1RB

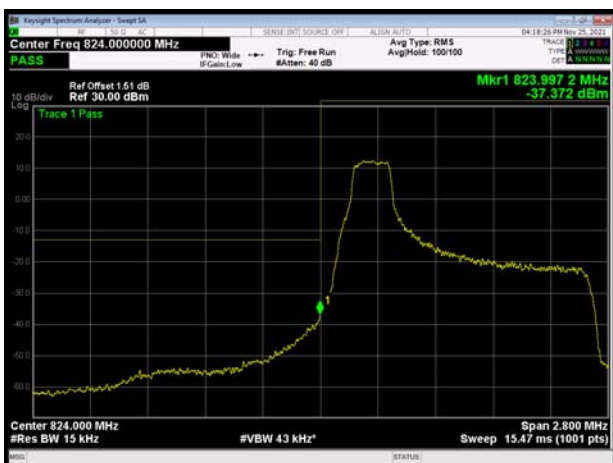

LTE Band 5 16QAM 1.4MHz CH-High 1RB

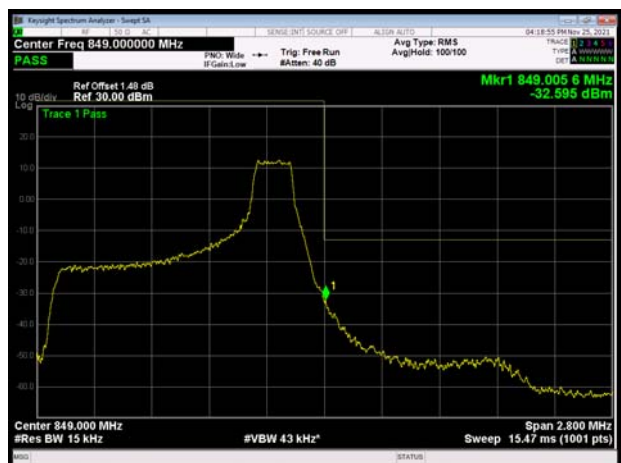

LTE Band 5 16QAM 1.4MHz CH-Low 100%RB

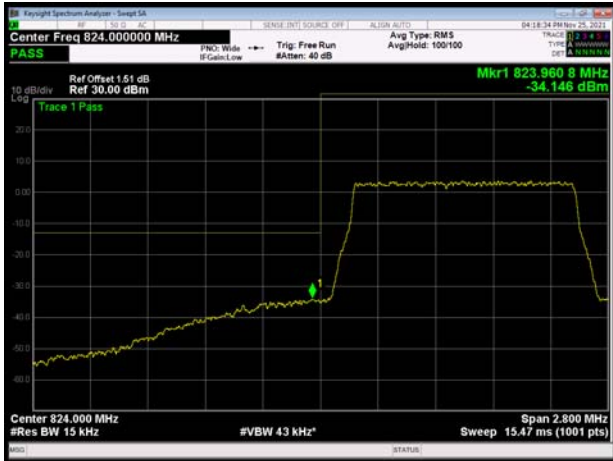

LTE Band 5 16QAM 1.4MHz CH-High 100%RB

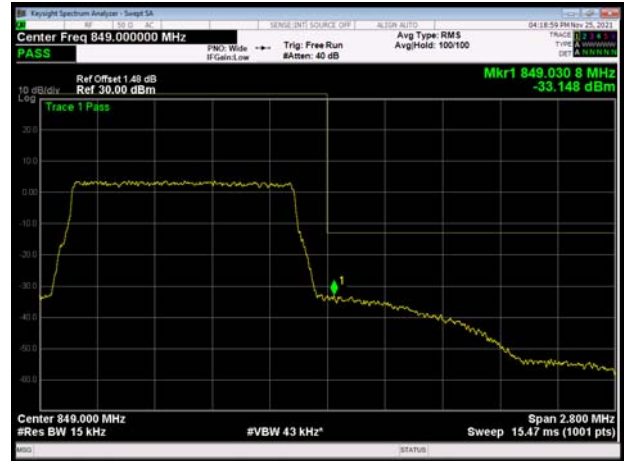

LTE Band 5 16QAM 3MHz CH-Low 1RB

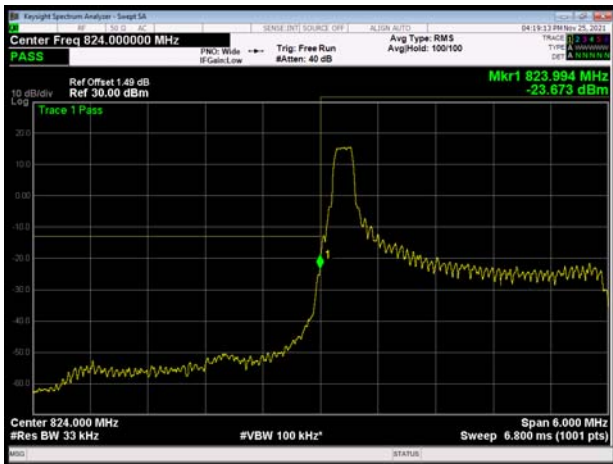

LTE Band 5 16QAM 3MHz CH-High 1RB

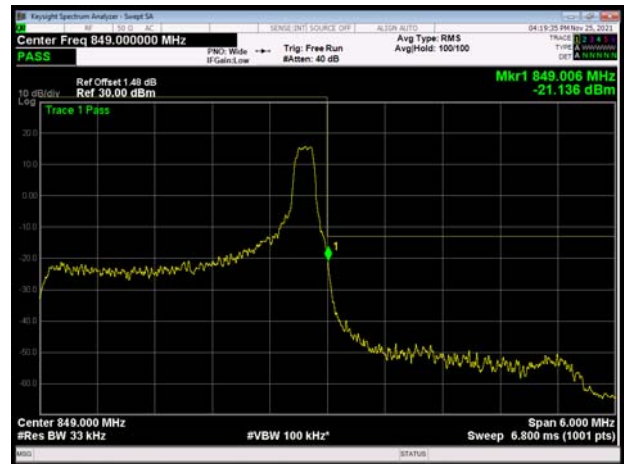

LTE Band 5 16QAM 3MHz CH-Low 100%RB

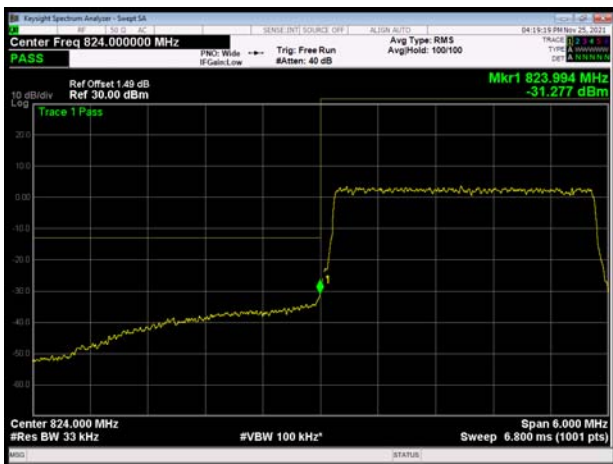

LTE Band 5 16QAM 3MHz CH-High 100%RB

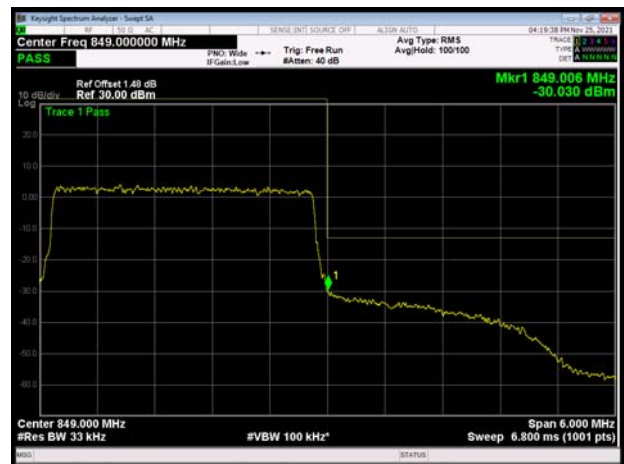



LTE Band 5 16QAM 5MHz CH-Low 1RB

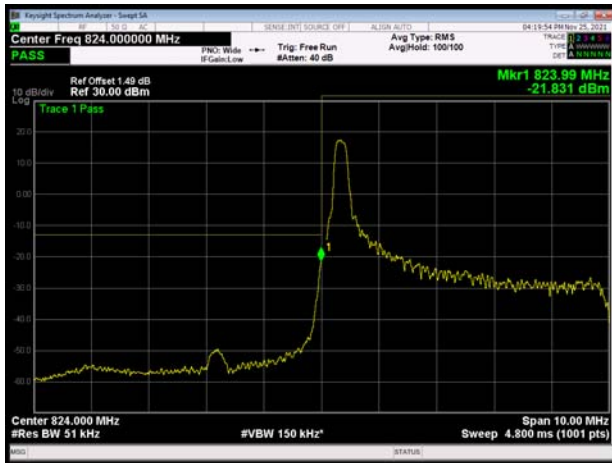

LTE Band 5 16QAM 5MHz CH-High 1RB

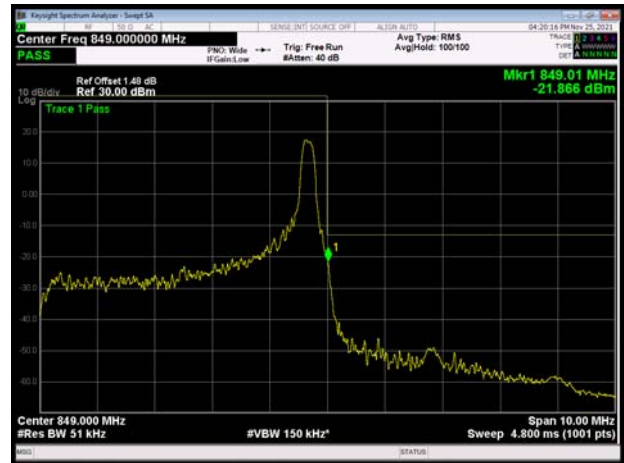

LTE Band 5 16QAM 5MHz CH-Low 100%RB

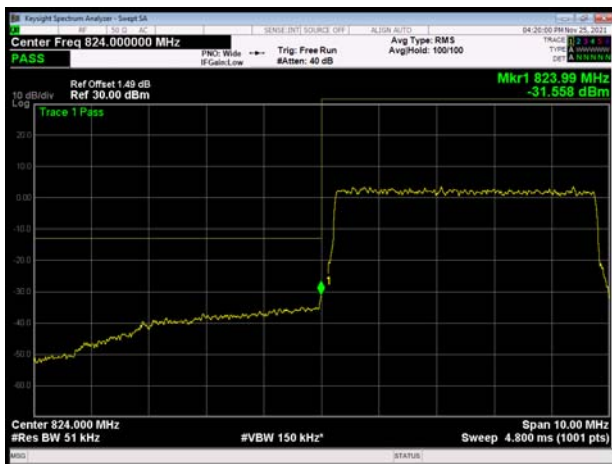

LTE Band 5 16QAM 5MHz CH-High 100%RB

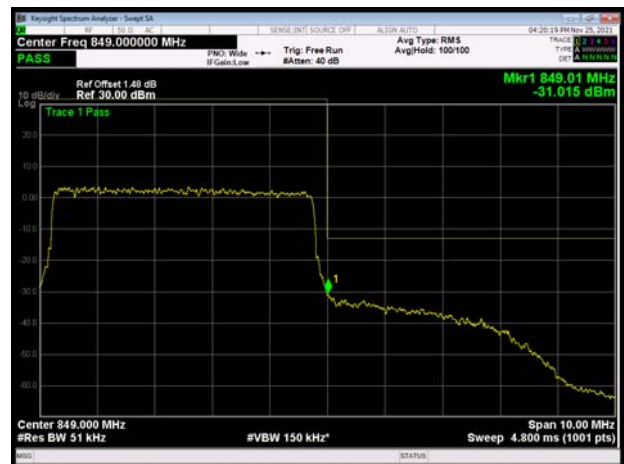

LTE Band 5 16QAM 10MHz CH-Low 1RB

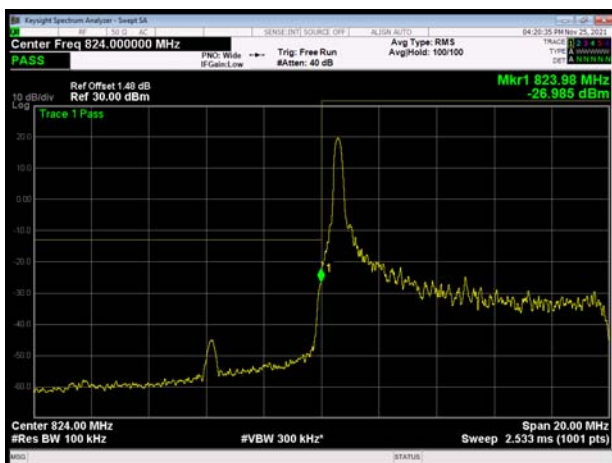

LTE Band 5 16QAM 10MHz CH-High 1RB

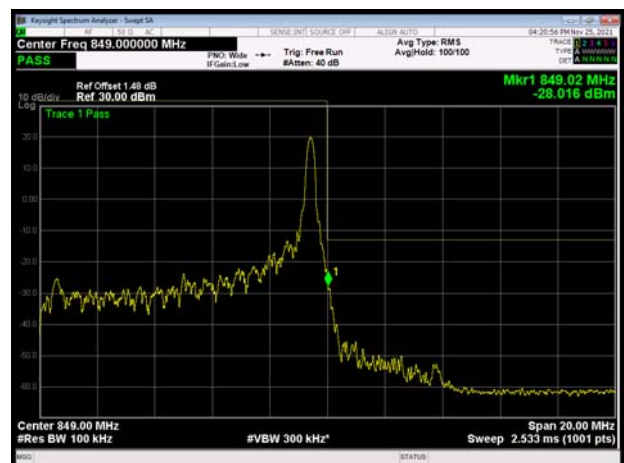



LTE Band 5 16QAM 10MHz CH-Low 100%RB

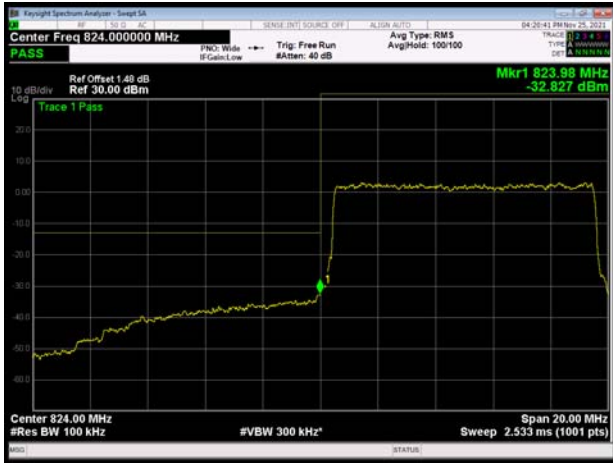

LTE Band 5 16QAM 10MHz CH-High 100%RB

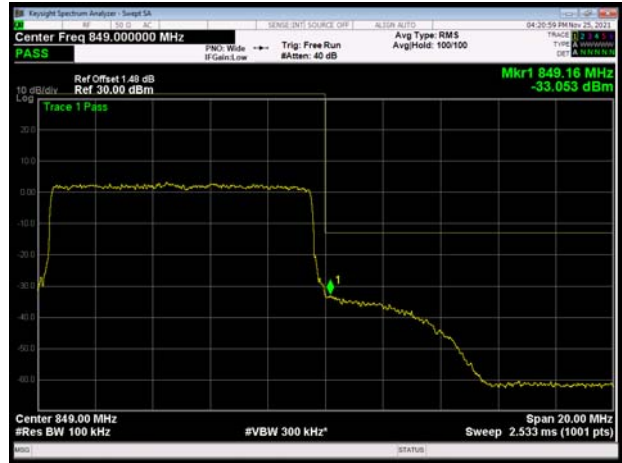

LTE Band 5 64QAM 1.4MHz CH-Low 1RB

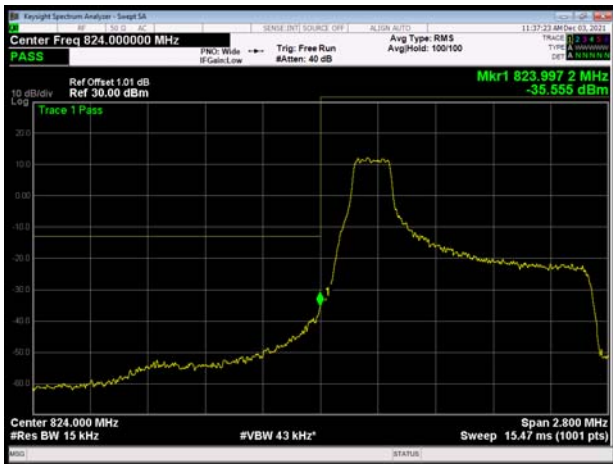

LTE Band 5 64QAM 1.4MHz CH-High 1RB

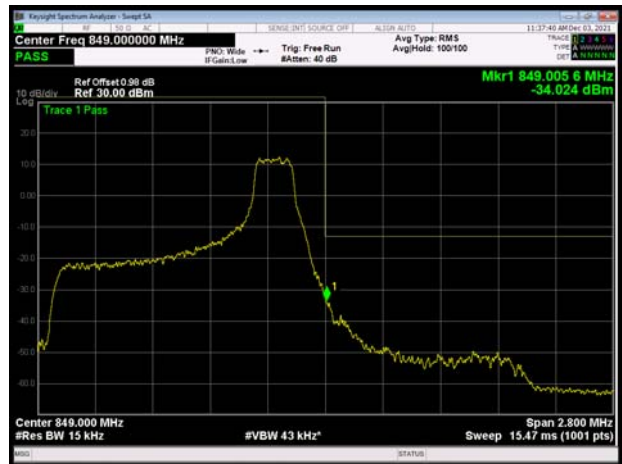

LTE Band 5 64QAM 1.4MHz CH-Low 100%RB

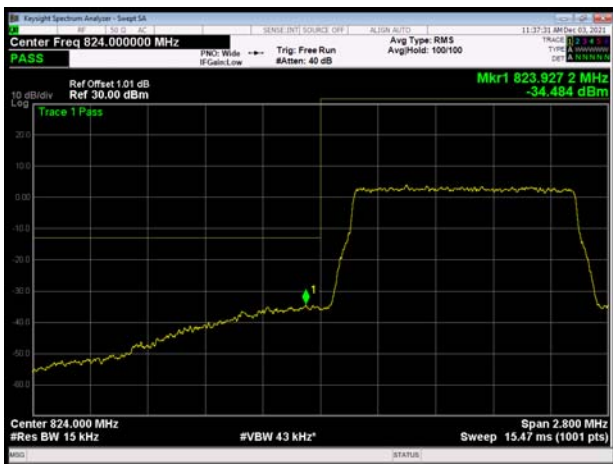

LTE Band 5 64QAM 1.4MHz CH-High 100%RB



LTE Band 5 64QAM 3MHz CH-Low 1RB

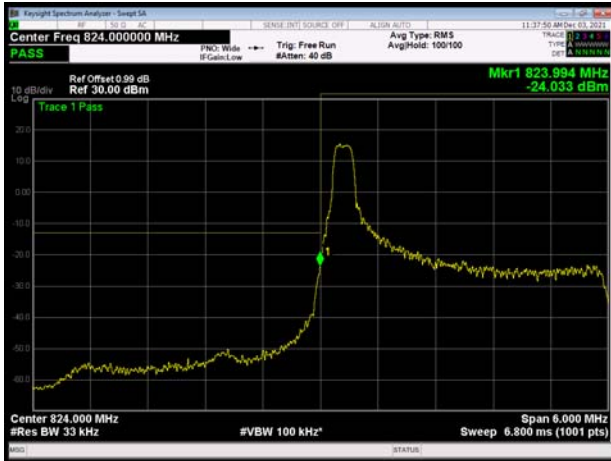

LTE Band 5 64QAM 3MHz CH-High 1RB

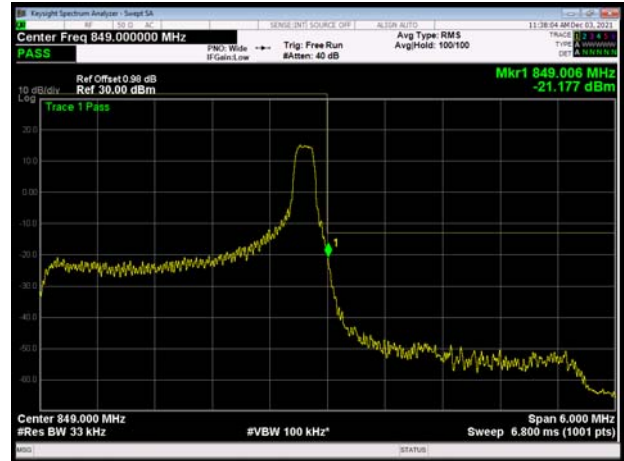

LTE Band 5 64QAM 3MHz CH-Low 100%RB

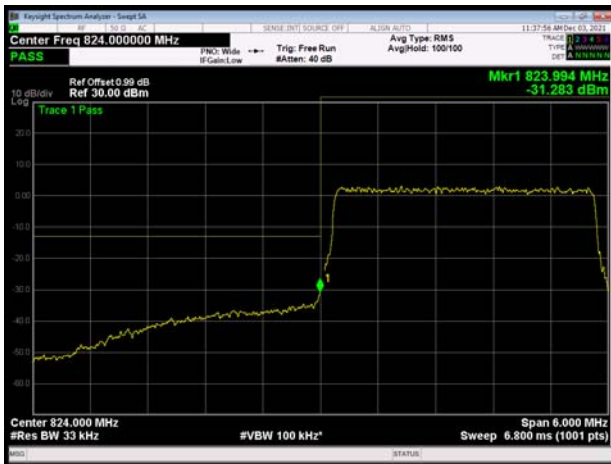

LTE Band 5 64QAM 3MHz CH-High 100%RB

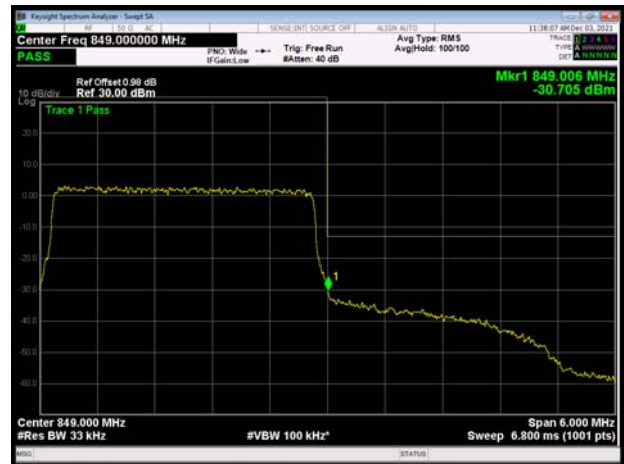

LTE Band 5 64QAM 5MHz CH-Low 1RB

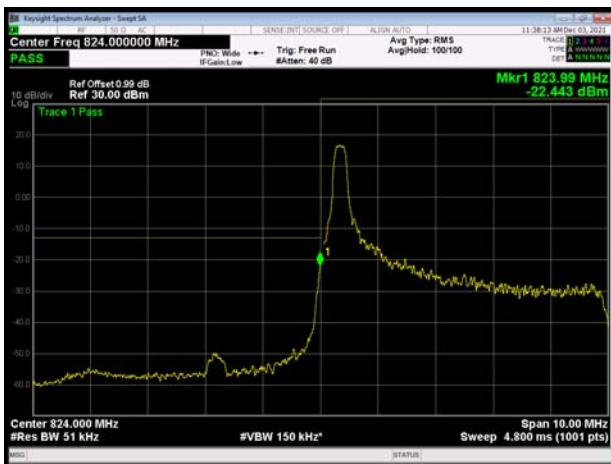

LTE Band 5 64QAM 5MHz CH-High 1RB

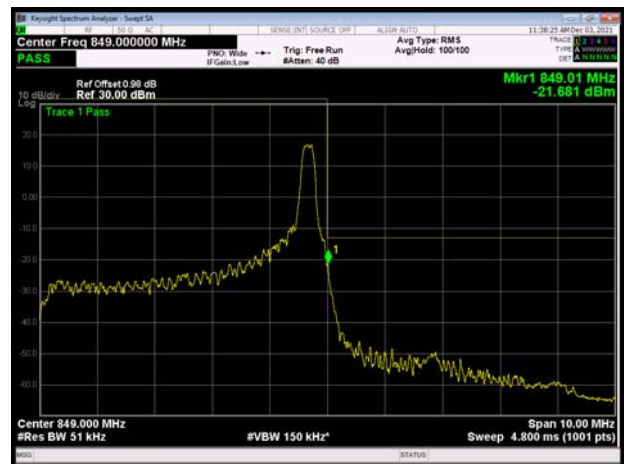



LTE Band 5 64QAM 5MHz CH-Low 100%RB

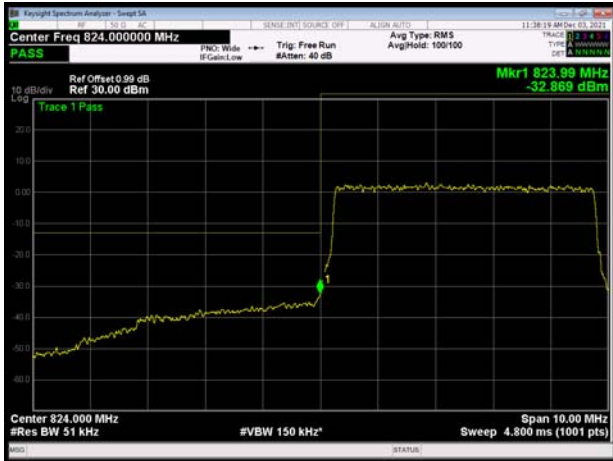

LTE Band 5 64QAM 5MHz CH-High 100%RB



LTE Band 5 64QAM 10MHz CH-Low 1RB

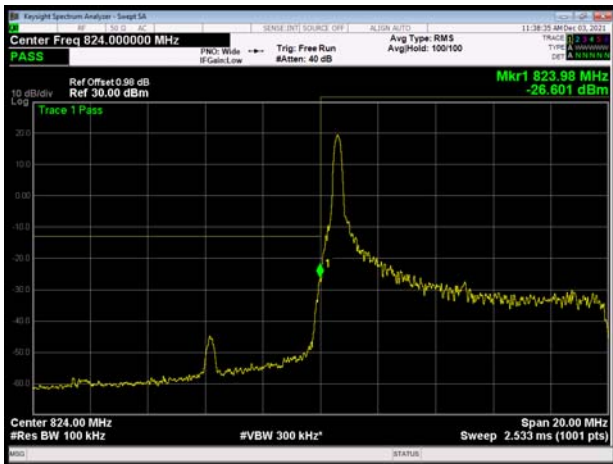

LTE Band 5 64QAM 10MHz CH-High 1RB

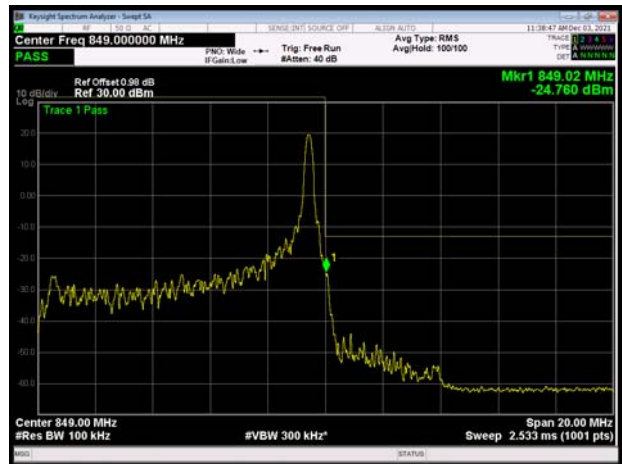

LTE Band 5 64QAM 10MHz CH-Low 100%RB

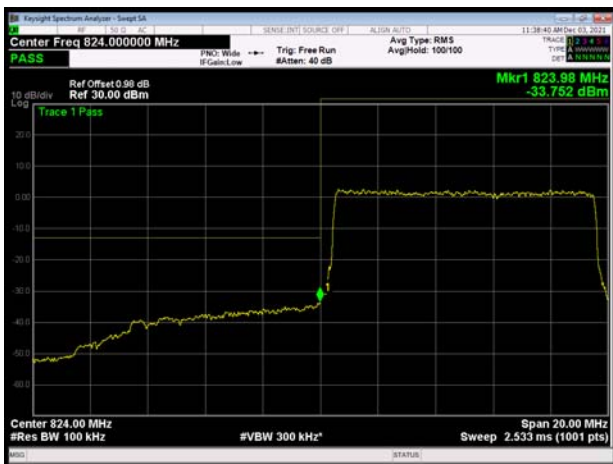

LTE Band 5 64QAM 10MHz CH-High 100%RB



5.4. Peak-to-Average Power Ratio (PAPR)

Ambient condition

Temperature	Relative humidity	Pressure
23°C ~25°C	45%~50%	101.5kPa

Methods of Measurement

Measure the total peak power and record as P_{Pk} . And measure the total average power and record as P_{Avg} . Both the peak and average power levels must be expressed in the same logarithmic units (e.g., dBm). Determine the PAPR from:

$$PAPR (dB) = P_{Pk} (dBm) - P_{Avg} (dBm).$$

Test Setup

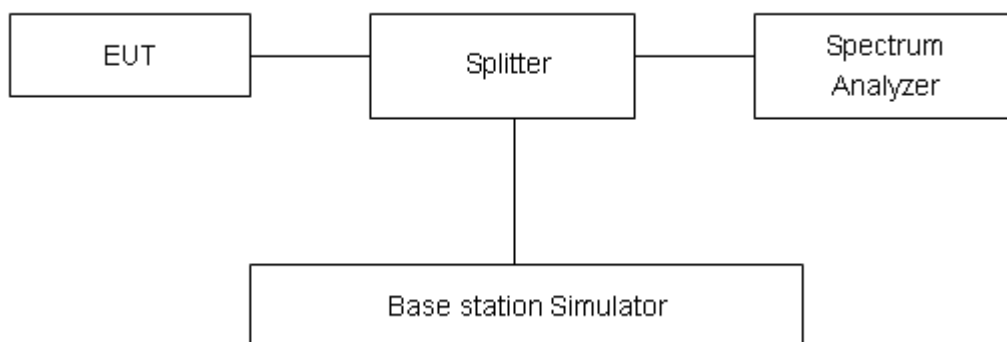

Limits

According to the Sec. 22.913(d), The peak-to-average ratio (PAR) of the transmission must not exceed 13 dB.

Measurement Uncertainty

The assessed measurement uncertainty to ensure 95% confidence level for the normal distribution is with the coverage factor $k = 2$, $U = 0.4$ dB.

Test Results

Mode	Channel	Frequency (MHz)	Peak (dBm)	Avg (dBm)	PAPR (dB)	Limit (dB)	Conclusion
GSM 850 (GMSK)	128	824.2	32.00	29.24	2.76	≤13	PASS
	190	836.6	32.19	29.43	2.76	≤13	PASS
	251	848.8	31.81	29.05	2.76	≤13	PASS
GPRS 850 (GMSK)	128	824.2	32.00	29.23	2.77	≤13	PASS
	190	836.6	32.18	29.42	2.76	≤13	PASS
	251	848.8	31.81	29.05	2.76	≤13	PASS
EGPRS 850 (8PSK)	128	824.2	28.41	22.63	5.78	≤13	PASS
	190	836.6	28.72	22.95	5.77	≤13	PASS
	251	848.8	28.66	22.92	5.74	≤13	PASS
WCDMA Band V (RMC)	4132	826.4	26.47	23.62	2.85	≤13	PASS
	4183	836.6	26.37	23.61	2.76	≤13	PASS
	4233	846.6	26.28	23.60	2.68	≤13	PASS

LTE Band 5								
Modulation	Bandwidth (MHz)	Channel	Frequency (MHz)	Peak (dBm)	Avg (dBm)	PAPR (dB)	Limit (dB)	Conclusion
QPSK	1.4	20407	824.7	27.54	22.10	5.44	≤13	PASS
		20525	836.5	27.25	22.13	5.12	≤13	PASS
		20643	848.3	26.92	21.96	4.96	≤13	PASS
	3	20415	825.5	27.61	22.27	5.34	≤13	PASS
		20525	836.5	27.36	22.22	5.14	≤13	PASS
		20635	847.5	27.06	22.28	4.78	≤13	PASS
	5	20425	826.5	27.67	22.28	5.39	≤13	PASS
		20525	836.5	27.35	22.22	5.13	≤13	PASS
		20625	846.5	27.11	22.23	4.88	≤13	PASS
	10	20450	829	27.59	22.21	5.38	≤13	PASS
		20525	836.5	27.32	22.17	5.15	≤13	PASS
		20600	844	27.28	22.19	5.09	≤13	PASS
16QAM	1.4	20407	824.7	26.93	21.06	5.87	≤13	PASS
		20525	836.5	26.95	21.12	5.83	≤13	PASS
		20643	848.3	26.44	21.11	5.33	≤13	PASS
	3	20415	825.5	27.25	21.21	6.04	≤13	PASS
		20525	836.5	26.89	21.17	5.72	≤13	PASS



	5	20635	847.5	26.55	21.24	5.31	≤13	PASS	
		20425	826.5	27.23	21.22	6.01	≤13	PASS	
		20525	836.5	26.84	21.15	5.69	≤13	PASS	
	10	20625	846.5	26.64	21.20	5.44	≤13	PASS	
		20450	829	27.15	21.15	6.00	≤13	PASS	
		20525	836.5	26.86	21.12	5.74	≤13	PASS	
64QAM	1.4	20600	844	26.80	21.14	5.66	≤13	PASS	
		20407	824.7	26.71	20.72	5.99	≤13	PASS	
		20525	836.5	26.26	20.62	5.64	≤13	PASS	
	3	20643	848.3	26.12	20.64	5.48	≤13	PASS	
		20415	825.5	26.66	20.70	5.96	≤13	PASS	
		20525	836.5	26.37	20.71	5.66	≤13	PASS	
	5	20635	847.5	26.20	20.67	5.53	≤13	PASS	
		20425	826.5	26.74	20.71	6.03	≤13	PASS	
		20525	836.5	26.29	20.66	5.63	≤13	PASS	
	10	20625	846.5	26.11	20.69	5.42	≤13	PASS	
		20450	829	26.69	20.67	6.02	≤13	PASS	
		20525	836.5	26.42	20.71	5.71	≤13	PASS	
			20600	844	26.29	20.65	5.64	≤13	PASS

5.5. Frequency Stability

Ambient condition

Temperature	Relative humidity	Pressure
23°C ~25°C	45%~50%	101.5kPa

Method of Measurement

Frequency Stability (Temperature Variation)

The temperature inside the climate chamber is varied from -20°C to +55°C in 10°C step size,

(1) With all power removed, the temperature was decreased to 0°C and permitted to stabilize for three hours.

(2) Measure the carrier frequency with the test equipment in a “call mode”. These measurements should be made within 1 minute of powering up the mobile station, to prevent significant self warming.

(3) Repeat the above measurements at 10°C increments from -20°C to +55°C. Allow at least 1.5 hours at each temperature, un-powered, before making measurements.

Frequency Stability (Voltage Variation)

The frequency stability shall be measured with variation of primary supply voltage as follows:

Primary Supply Voltage: The primary supply voltage is varied from 85% to 115% of the nominal value for non hand-carried battery and AC powered equipment. For hand-carried, battery-powered equipment, primary supply voltage is reduced to the battery operating end point which shall be specified by the manufacturer.

This transceiver is specified to operate with an input voltage of between 3.6V and 4.4V, with a nominal voltage of 3.82V.

Test setup

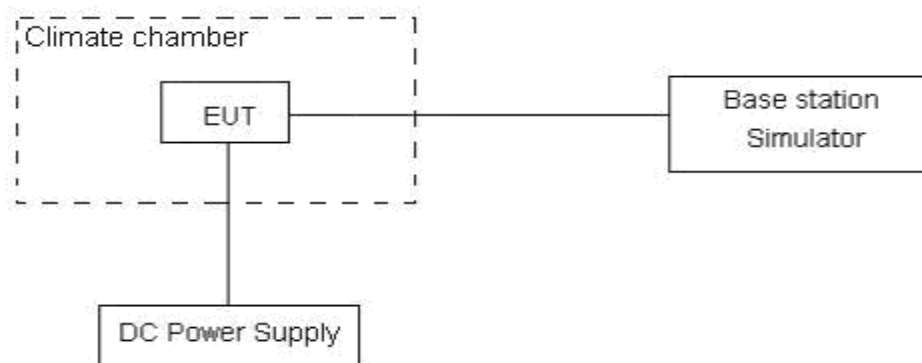

Limits

According to the Sec. 22.355, the frequency stability of the carrier shall be accurate to within 2.5 ppm of the received frequency for mobile stations.

Limits	≤ 2.5 ppm
--------	-----------

Measurement Uncertainty

The assessed measurement uncertainty to ensure 99.75% confidence level for the normal distribution is with the coverage factor $k = 3$, $U = 0.01\text{ppm}$.

Test Result

GSM850						
Condition		Freq.Error (Hz)	Freq.Error (Hz)	Frequency Stability (ppm)	Frequency Stability (ppm)	Verdict
Temperature	Voltage	GMSK	8PSK	GMSK	8PSK	
Normal (25°C)	Normal	8.99	11.11	0.01075	0.01328	PASS
Extreme (55°C)		5.02	10.61	0.00600	0.01268	PASS
Extreme (50°C)		7.73	13.35	0.00924	0.01596	PASS
Extreme (40°C)		14.26	11.40	0.01704	0.01363	PASS
Extreme (30°C)		11.35	12.81	0.01357	0.01531	PASS
Extreme (20°C)		14.55	16.95	0.01739	0.02026	PASS
Extreme (10°C)		13.03	9.31	0.01557	0.01113	PASS
Extreme (0°C)		17.97	16.37	0.02148	0.01956	PASS
Extreme (-10°C)		8.01	8.08	0.00957	0.00966	PASS
Extreme (-20°C)		5.67	10.63	0.00678	0.01271	PASS
25°C	LV	16.98	6.32	0.02029	0.00756	PASS
	HV	5.70	9.25	0.00681	0.01106	PASS

WCDMA Band 5						
Condition		Freq.Error (Hz)	Freq.Error (Hz)	Frequency Stability (ppm)	Frequency Stability (ppm)	Verdict
Temperature	Voltage	BPSK	QPSK	BPSK	QPSK	
Normal (25°C)	Normal	3.42	10.33	0.00409	0.01235	PASS
Extreme (55°C)		5.03	5.04	0.00602	0.00603	PASS
Extreme (50°C)		8.78	6.67	0.01049	0.00797	PASS
Extreme (40°C)		13.90	9.37	0.01661	0.01120	PASS
Extreme (30°C)		12.99	12.25	0.01553	0.01464	PASS
Extreme (20°C)		13.01	9.05	0.01555	0.01082	PASS
Extreme (10°C)		14.29	11.59	0.01708	0.01385	PASS
Extreme (0°C)		16.36	6.83	0.01956	0.00817	PASS
Extreme (-10°C)		13.27	17.92	0.01586	0.02142	PASS
Extreme (-20°C)		1.33	12.04	0.00159	0.01439	PASS
25°C	LV	11.27	2.55	0.01347	0.00305	PASS
	HV	6.20	7.36	0.00741	0.00879	PASS



LTE Band 5								
Condition		Freq.Error (Hz)	Freq.Error (Hz)	Freq.Error (Hz)	Frequency Stability (ppm)	Frequency Stability (ppm)	Frequency Stability (ppm)	Verdict
BANDWIDTH	1.4MHz							
Temperature	Voltage	64QAM	16QAM	QPSK	64QAM	16QAM	QPSK	
Normal (25°C)	Normal	16.18	8.75	16.43	0.01934	0.01047	0.01964	PASS
Extreme (55°C)		7.32	14.97	5.70	0.00876	0.01789	0.00682	PASS
Extreme (50°C)		12.54	13.39	14.69	0.01500	0.01600	0.01756	PASS
Extreme (40°C)		6.34	17.13	1.57	0.00757	0.02047	0.00188	PASS
Extreme (30°C)		13.35	12.09	3.43	0.01596	0.01446	0.00411	PASS
Extreme (20°C)		5.86	14.33	5.08	0.00700	0.01713	0.00608	PASS
Extreme (10°C)		12.72	11.48	3.74	0.01521	0.01372	0.00447	PASS
Extreme (0°C)		2.40	17.14	12.56	0.00287	0.02049	0.01502	PASS
Extreme (-10°C)		16.17	3.29	8.00	0.01933	0.00393	0.00956	PASS
Extreme (-20°C)		6.79	1.39	16.14	0.00812	0.00166	0.01930	PASS
25°C		LV	10.21	2.37	14.28	0.01220	0.00283	0.01707
	HV	11.86	17.51	1.95	0.01417	0.02093	0.00233	PASS
Condition		Freq.Error (Hz)	Freq.Error (Hz)	Freq.Error (Hz)	Frequency Stability (ppm)	Frequency Stability (ppm)	Frequency Stability (ppm)	Verdict
BANDWIDTH	3MHz							
Temperature	Voltage	64QAM	16QAM	QPSK	64QAM	16QAM	QPSK	
Normal (25°C)	Normal	12.63	15.51	16.96	0.01510	0.01854	0.02027	PASS
Extreme (55°C)		10.99	14.15	17.90	0.01314	0.01692	0.02140	PASS
Extreme (50°C)		3.89	14.18	17.97	0.00465	0.01695	0.02149	PASS
Extreme (40°C)		15.36	2.16	16.22	0.01836	0.00258	0.01939	PASS
Extreme (30°C)		12.86	11.44	9.07	0.01537	0.01368	0.01084	PASS
Extreme (20°C)		6.69	15.14	15.95	0.00799	0.01810	0.01907	PASS
Extreme (10°C)		17.54	5.30	15.87	0.02097	0.00633	0.01898	PASS
Extreme (0°C)		10.08	10.28	9.62	0.01206	0.01229	0.01151	PASS
Extreme (-10°C)		15.20	12.53	3.13	0.01817	0.01498	0.00374	PASS
Extreme (-20°C)		8.67	7.11	6.95	0.01036	0.00850	0.00831	PASS
25°C		LV	15.68	7.05	11.55	0.01875	0.00842	0.01381
	HV	3.50	15.25	5.53	0.00419	0.01822	0.00662	PASS
Condition		Freq.Error (Hz)	Freq.Error (Hz)	Freq.Error (Hz)	Frequency Stability (ppm)	Frequency Stability (ppm)	Frequency Stability (ppm)	Verdict
BANDWIDTH	5MHz							
Temperature	Voltage	64QAM	16QAM	QPSK	64QAM	16QAM	QPSK	
Normal (25°C)	Normal	1.17	6.95	17.41	0.00140	0.00830	0.02081	PASS
Extreme (55°C)		3.41	13.25	1.79	0.00407	0.01584	0.00213	PASS



Extreme (50°C)		13.05	6.15	10.75	0.01560	0.00735	0.01286	PASS
Extreme (40°C)		4.33	14.62	5.74	0.00518	0.01748	0.00686	PASS
Extreme (30°C)		2.55	16.71	2.72	0.00304	0.01997	0.00325	PASS
Extreme (20°C)		10.99	15.21	1.12	0.01313	0.01819	0.00134	PASS
Extreme (10°C)		1.82	7.86	4.81	0.00217	0.00939	0.00575	PASS
Extreme (0°C)		5.22	14.49	13.29	0.00624	0.01732	0.01589	PASS
Extreme (-10°C)		14.11	13.92	2.03	0.01686	0.01664	0.00243	PASS
Extreme (-20°C)		14.52	3.91	13.58	0.01736	0.00467	0.01623	PASS
25°C	LV	13.28	1.50	11.02	0.01588	0.00180	0.01317	PASS
	HV	16.24	5.19	1.14	0.01941	0.00620	0.00136	PASS
Condition		Freq.Error (Hz)	Freq.Error (Hz)	Freq.Error (Hz)	Frequency Stability (ppm)	Frequency Stability (ppm)	Frequency Stability (ppm)	Verdict
BANDWIDTH	10MHz							
Temperature	Voltage	64QAM	16QAM	QPSK	64QAM	16QAM	QPSK	
Normal (25°C)	Normal	7.12	8.53	16.73	0.00852	0.01019	0.02001	PASS
Extreme (55°C)		12.22	15.01	5.93	0.01461	0.01794	0.00709	PASS
Extreme (50°C)		5.37	1.90	11.84	0.00642	0.00228	0.01416	PASS
Extreme (40°C)		14.86	17.87	3.04	0.01777	0.02136	0.00363	PASS
Extreme (30°C)		6.74	1.04	16.43	0.00806	0.00124	0.01964	PASS
Extreme (20°C)		17.57	10.76	14.21	0.02101	0.01286	0.01698	PASS
Extreme (10°C)		5.73	2.54	10.40	0.00685	0.00304	0.01244	PASS
Extreme (0°C)		17.77	16.13	16.91	0.02125	0.01929	0.02022	PASS
Extreme (-10°C)		17.49	15.81	9.51	0.02091	0.01890	0.01136	PASS
Extreme (-20°C)		13.51	13.05	3.27	0.01615	0.01560	0.00390	PASS
25°C	LV	6.08	15.83	3.51	0.00727	0.01892	0.00419	PASS
	HV	8.53	5.73	11.17	0.01019	0.00685	0.01335	PASS

5.6. Spurious Emissions at Antenna Terminals

Ambient condition

Temperature	Relative humidity	Pressure
23°C ~25°C	45%~50%	101.5kPa

Method of Measurement

The EUT was connected to Spectrum Analyzer and Base Station Simulator via power Splitter. The measurement is carried out using a spectrum analyzer. The spectrum analyzer scans from 9kHz to the 10th harmonic of the carrier.

The peak detector is used. RBW are set to 100 kHz and VBW are set to 300 kHz for below 1G, RBW are set to 1MHz and VBW are set to 3MHz for above 1G, Sweep is set to ATUO.

RBW is set to 1 kHz (0.009MHz~ 0.15 MHz),

RBW is set to 10 kHz (0.15 MHz~ 30 MHz)

RBW is set to 100 kHz (30MHz~1000 MHz)

RBW is set to 1000 kHz (above 1000MHz)

The modulation mode and RB allocation refer to section 5.1, using the maximum output power configuration.

Test setup

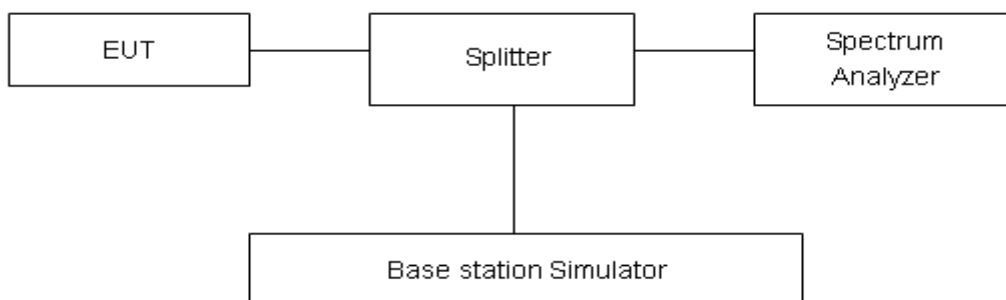

Limits

Rule Part 22.917(a) specifies that “The power of any emission outside of the authorized operating frequency ranges must be attenuated below the transmitting power (P) by a factor of at least 43 + 10 log (P) dB.”

Limit	-13 dBm

Measurement Uncertainty

The assessed measurement uncertainty to ensure 99.75% confidence level for the normal distribution is with the coverage factor $k = 1.96$.

Frequency	Uncertainty
9kHz-1GHz	0.684 dB
1GHz-20GHz	1.407 dB



Test Result

Sweep the whole frequency band through the range from 9kHz to the 10th harmonic of the carrier, the emissions more than 20 dB below the limit are not reported.

The signal beyond the limit is carrier.

GSM 850 CH-Low 9kHz ~ 20GHz

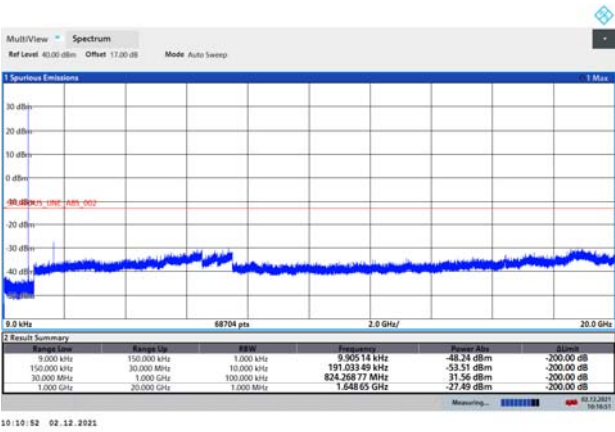

GPRS 850 CH-Low 9kHz ~ 20GHz

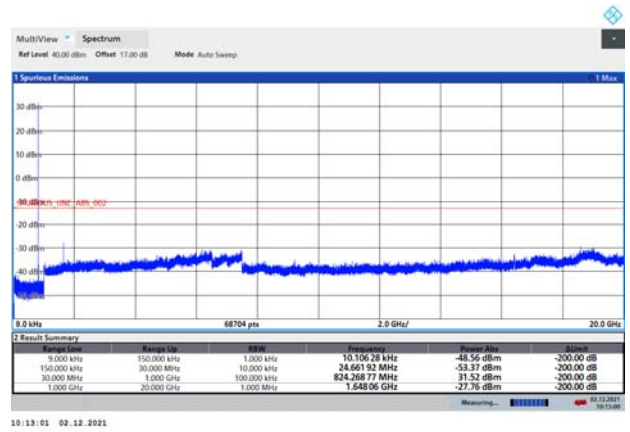

GSM 850 CH-Middle 9kHz ~ 20GHz

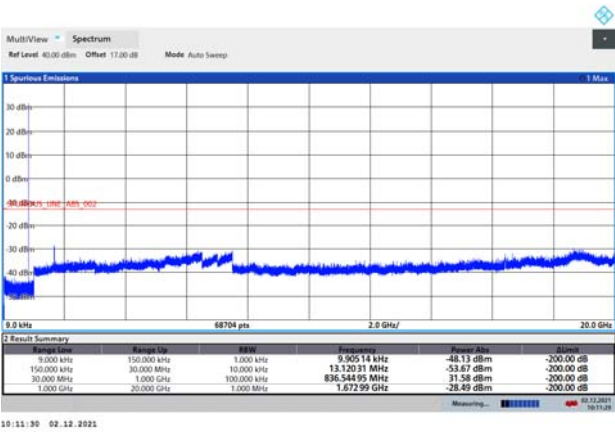

GPRS 850 CH-Middle 9kHz ~ 20GHz

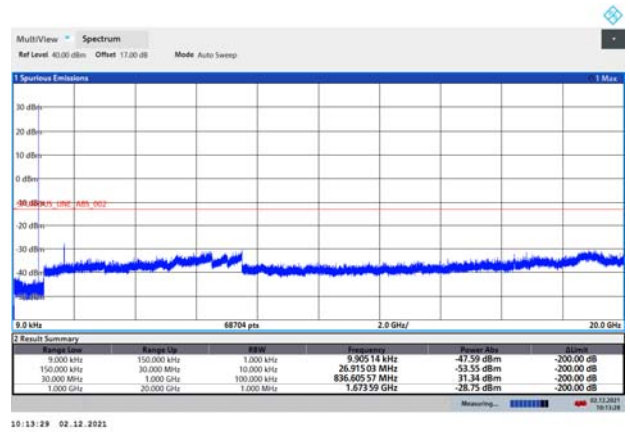

GSM 850 CH-High 9kHz ~ 20GHz

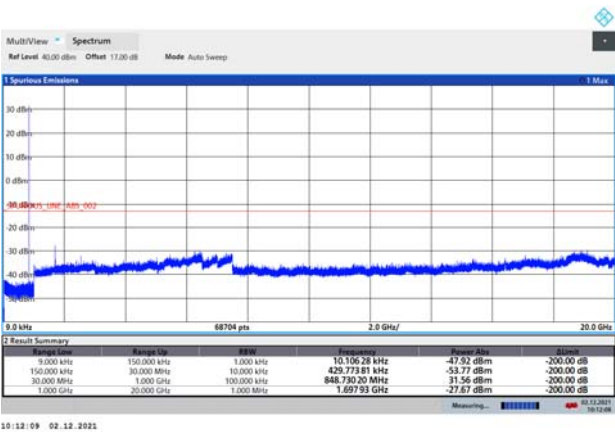

GPRS 850 CH-High 9kHz ~ 20GHz

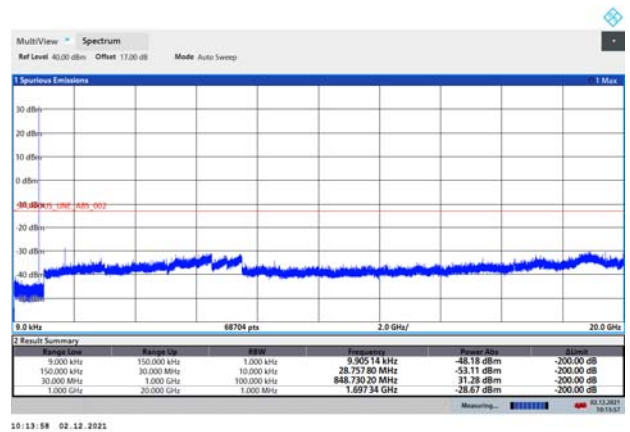



EGPRS 850 CH-Low 9kHz ~ 20GHz

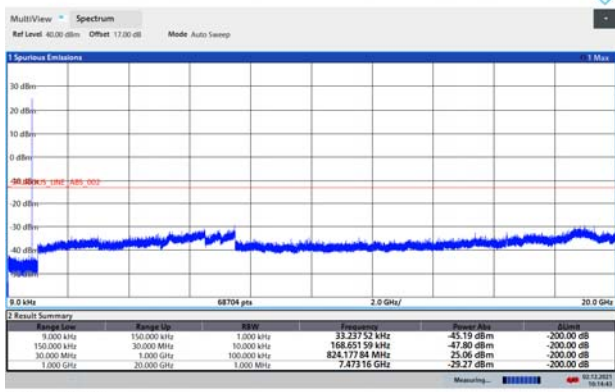

10:14:43 02.12.2021

WCDMA BAND V CH-Low 9kHz ~ 20GHz

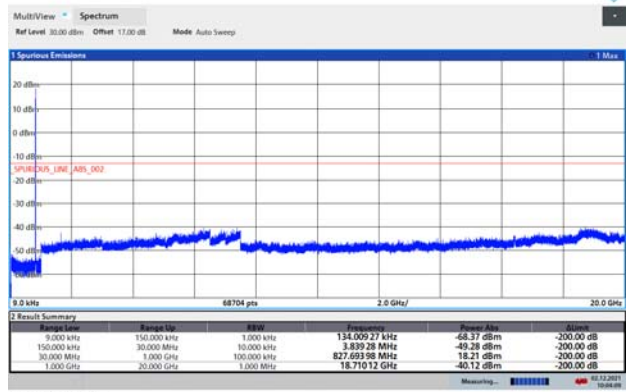

10:04:10 02.12.2021

EGPRS 850 CH-Middle 9kHz ~ 20GHz

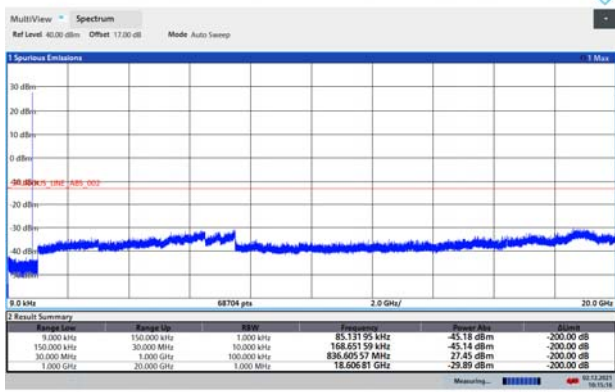

10:15:16 02.12.2021

WCDMA BAND V CH-Middle 9kHz ~ 20GHz

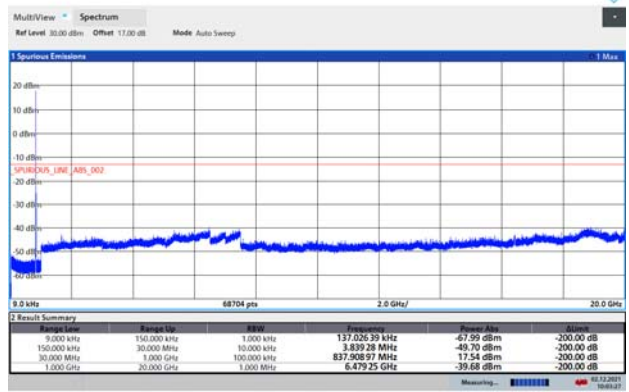

10:09:27 02.12.2021

EGPRS 850 CH-High 9kHz ~ 20GHz

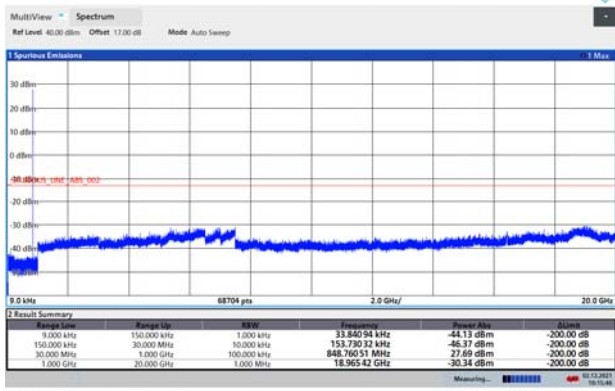

10:15:47 02.12.2021

WCDMA BAND V CH-High 9kHz ~ 20GHz

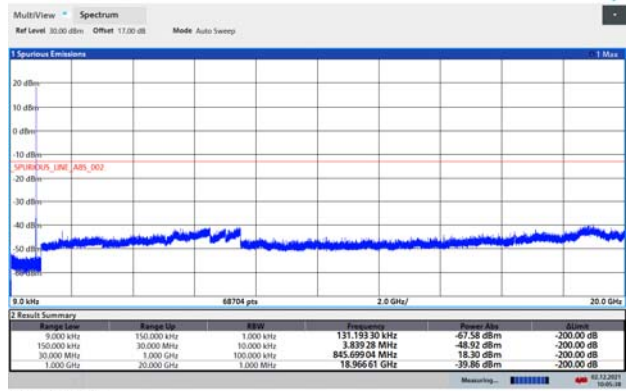

10:05:39 02.12.2021

LTE Band 5 1.4MHz CH-Low 9kHz~10GHz

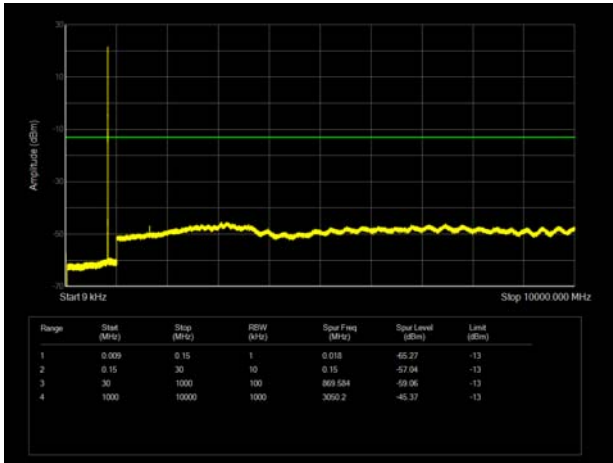

LTE Band 5 3MHz CH-Low 9kHz~10GHz

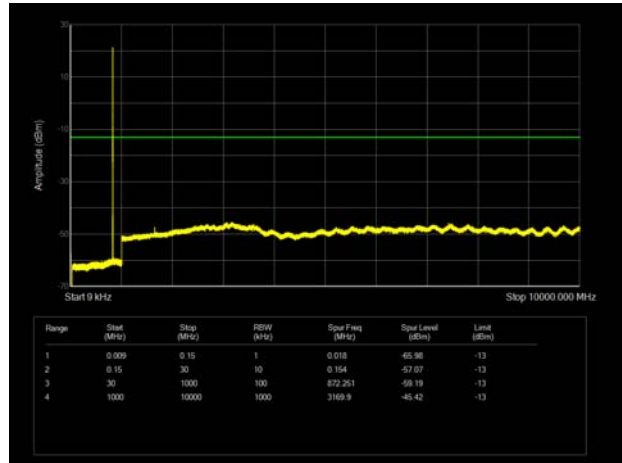

LTE Band 5 1.4MHz CH-Middle 9kHz~10GHz

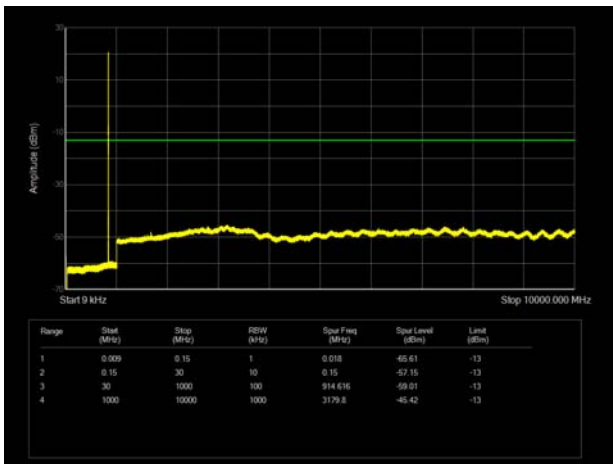

LTE Band 5 3MHz CH-Middle 9kHz~10GHz

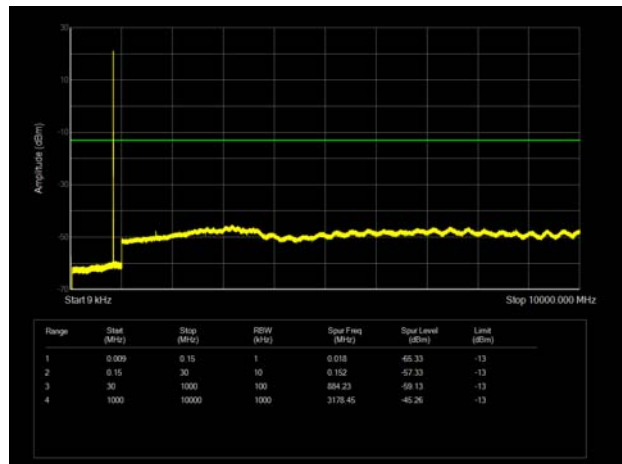

LTE Band 5 1.4MHz CH-High 9kHz~10GHz

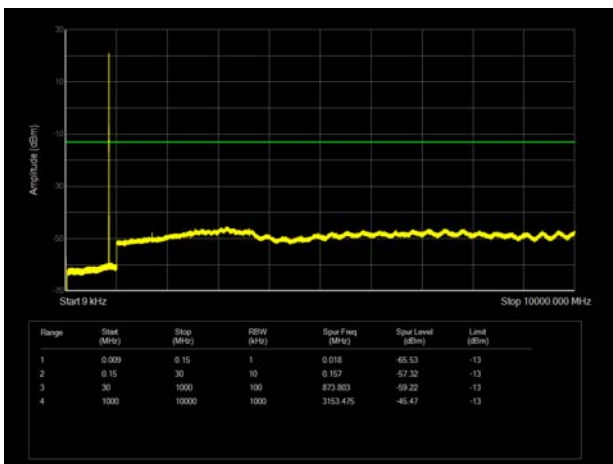

LTE Band 5 3MHz CH-High 9kHz~10GHz

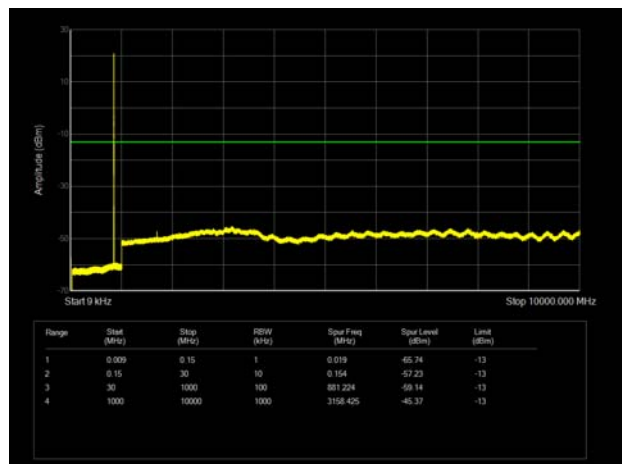

LTE Band 5 5MHz CH-Low 9kHz~10GHz

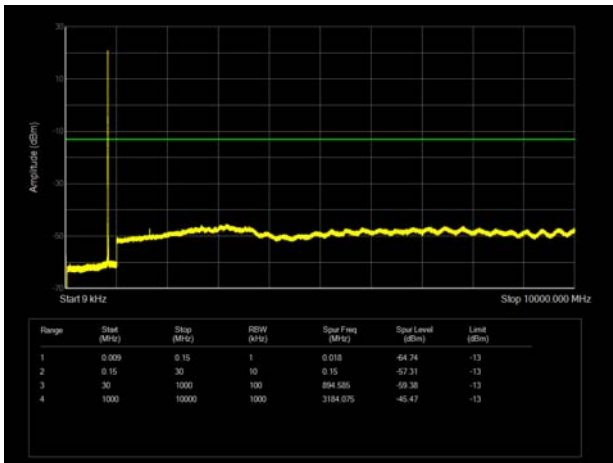

LTE Band 5 10MHz CH-Low 9kHz~10GHz

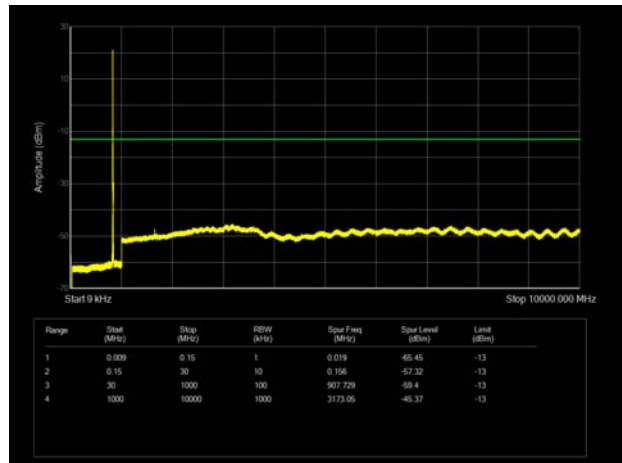

LTE Band 5 5MHz CH-Middle 9kHz~10GHz

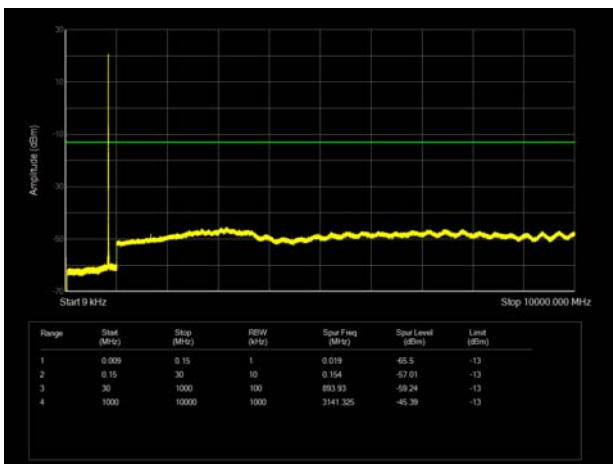

LTE Band 5 10MHz CH-Middle 9kHz~10GHz

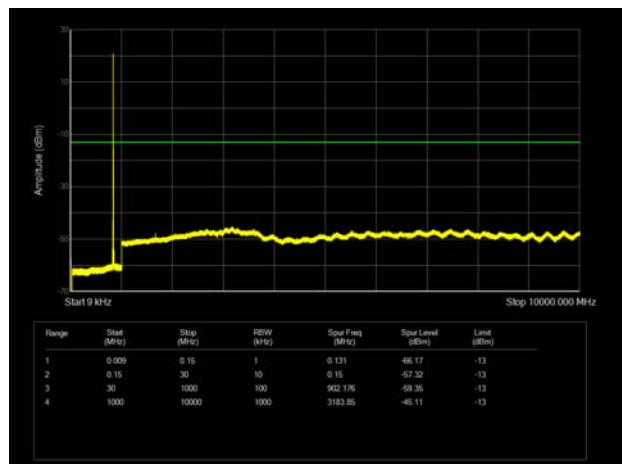

LTE Band 5 5MHz CH-High 9kHz~10GHz

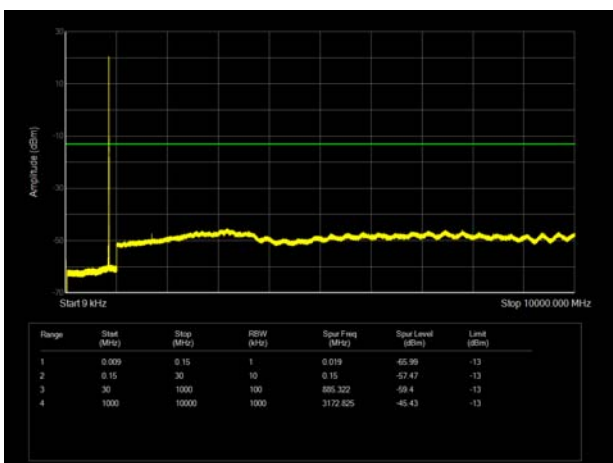

LTE Band 5 10MHz CH-High 9kHz~10GHz

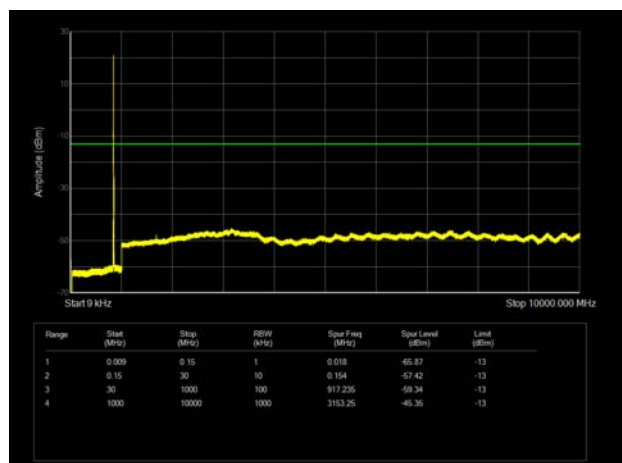

5.7. Radiates Spurious Emission

Ambient condition

Temperature	Relative humidity	Pressure
23°C ~25°C	45%~50%	101.5kPa

Method of Measurement

1. The testing follows FCC KDB 971168 v03r01 Section 5.8 and ANSI C63.26 (2015).
2. Below 1GHz: The EUT is placed on a turntable 0.8 meters above the ground in the chamber, 3 meter away from the antenna. The maximal emission value is acquired by adjusting the antenna height, polarisation and turntable azimuth. Normally, the height range of antenna is 1 m to 4 m, the azimuth range of turntable is 0° to 360°, and the receive antenna has two polarizations Vertical (V) and Horizontal (H). Above 1GHz: (Note: the FCC's permission to use 1.5m as an alternative per TCBC Conf call of Dec. 2, 2014.) The EUT is placed on a turntable 1.5 meters above the ground in the chamber, 3 meter away from the antenna. The maximal emission value is acquired by adjusting the antenna height, polarisation and turntable azimuth. Normally, the height range of antenna is 1 m to 4 m, the azimuth range of turntable is 0° to 360°, and the receive antenna has two polarizations Vertical (V) and Horizontal (H).
3. A loop antenna, A log-periodic antenna or horn antenna shall be substituted in place of the EUT. The log-periodic antenna will be driven by a signal generator and the level will be adjusted till the same power value on the spectrum analyzer or receiver. The level of the spurious emissions can be calculated through the level of the signal generator, cable loss, the gain of the substitution antenna and the reading of the spectrum analyzer or receiver.
4. The EUT is then put into continuously transmitting mode at its maximum power level during the test. Set Test Receiver or Spectrum RBW=100kHz,VBW=300kHz, and the maximum value of the receiver should be recorded as (Pr).
5. The EUT shall be replaced by a substitution antenna. In the chamber, an substitution antenna for the frequency band of interest is placed at the reference point of the chamber. An RF Signal source for the frequency band of interest is connected to the substitution antenna with a cable that has been constructed to not interfere with the radiation pattern of the antenna. A power (PMea) is applied to the input of the substitution antenna, and adjust the level of the signal generator output until the value of the receiver reach the previously recorded (Pr). The power of signal source (PMea) is recorded. The test should be performed by rotating the test item and adjusting the receiving antenna polarization.
6. A amplifier should be connected to the Signal Source output port. And the cable should be connect between the Amplifier and the Substitution Antenna. The cable loss (Pcl), the Substitution Antenna Gain (Ga) and the Amplifier Gain (PAg) should be recorded after test.
7. The measurement results are obtained as described below:
Power(EIRP)=PMea- PAg - Pcl + Ga
The measurement results are amend as described below:
Power(EIRP)=PMea- Pcl + Ga
8. This value is EIRP since the measurement is calibrated using an antenna of known gain (2.15 dB) and known input power. ERP can be calculated from EIRP by subtracting the gain of the dipole, ERP

= EIRP-2.15dB.

The modulation mode and RB allocation refer to section 5.1, using the maximum output power configuration.

Test setup

9KHz ~ 30MHz

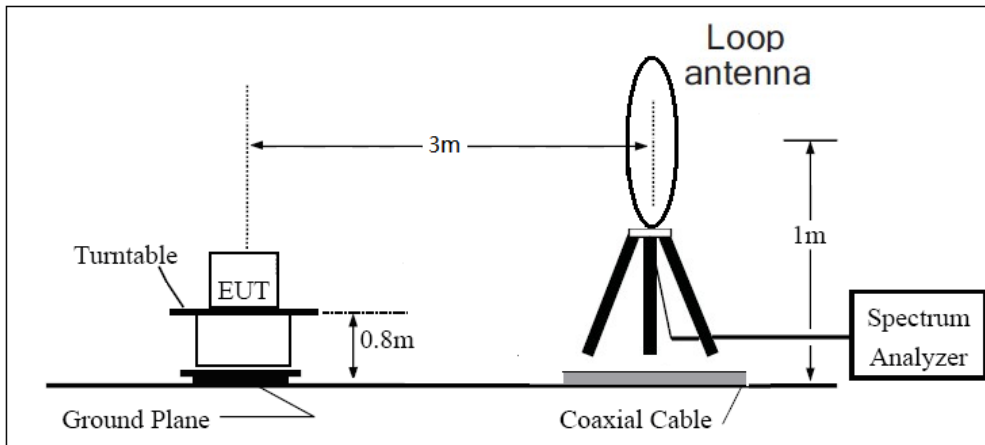

30MHz ~ 1GHz

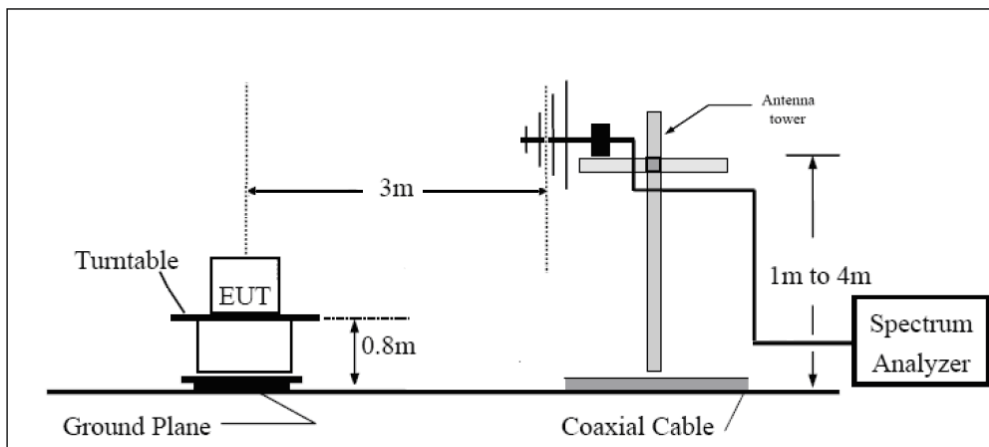

Above 1GHz

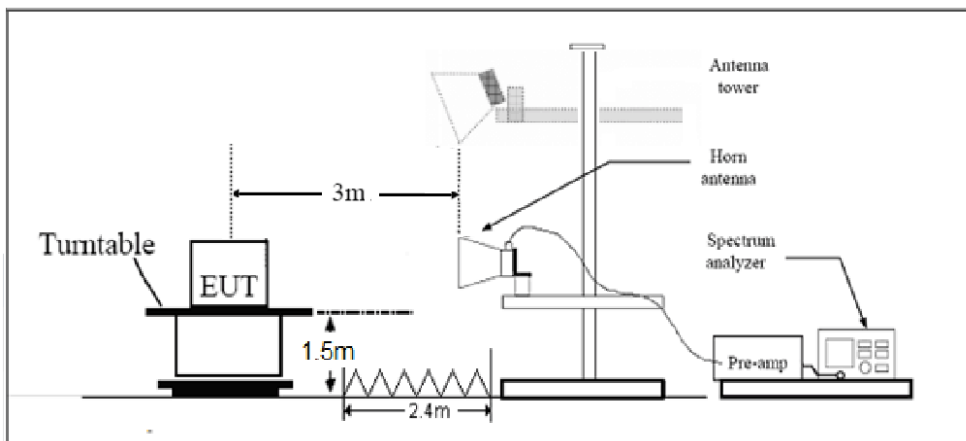

Note: Area side:2.4mX3.6m

Limits

Rule Part 22.917(a) specifies that “The power of any emission outside of the authorized operating frequency ranges must be attenuated below the transmitting power (P) by a factor of at least $43 + 10 \log (P)$ dB.”

Limit	-13 dBm
-------	---------

Measurement Uncertainty

The assessed measurement uncertainty to ensure 95% confidence level for the normal distribution is with the coverage factor $k = 1.96$, $U = 3.55$ dB.

**Test Result**

Sweep the whole frequency band through the range from 9kHz to the 10th harmonic of the carrier, the emissions below the noise floor will not be recorded in the report.

GSM 850 CH-Middle

Harmonic	Frequency (MHz)	SG (dBm)	Cable Loss (dB)	Gain (dBi)	Antenna Polarization	ERP Level (dBm)	Limit (dBm)	Margin (dB)	Azimuth (deg)
2	1672.95	-55.40	1.70	8.70	Vertical	-50.55	-13.00	37.55	315
3	2509.50	-52.39	2.30	12.00	Vertical	-44.84	-13.00	31.84	180
4	3346.40	-63.91	2.70	12.70	Vertical	-56.06	-13.00	43.06	45
5	4183.00	-64.44	3.00	12.50	Vertical	-57.09	-13.00	44.09	225
6	5019.60	-61.17	3.40	12.50	Vertical	-54.22	-13.00	41.22	180
7	5856.20	-63.03	3.40	12.80	Vertical	-55.78	-13.00	42.78	90
8	6692.80	-58.14	4.10	11.50	Vertical	-52.89	-13.00	39.89	0
9	7529.40	-55.26	4.20	12.20	Vertical	-49.41	-13.00	36.41	315
10	8366.00	-55.04	4.30	12.50	Vertical	-48.99	-13.00	35.99	225

Note: 1.The other Spurious RF Radiated emissions level is no more than noise floor.

2.The worst emission was found in the antenna is Vertical position.

WCDMA Band V CH-Middle

Harmonic	Frequency (MHz)	SG (dBm)	Cable Loss (dB)	Gain (dBi)	Antenna Polarization	ERP Level (dBm)	Limit (dBm)	Margin (dB)	Azimuth (deg)
2	1673.20	-63.20	1.70	8.70	Vertical	-58.35	-13.00	45.35	315
3	2509.80	-63.70	2.30	12.00	Vertical	-56.15	-13.00	43.15	135
4	3346.40	-65.19	2.70	12.70	Vertical	-57.34	-13.00	44.34	45
5	4183.00	-63.68	3.00	12.50	Vertical	-56.33	-13.00	43.33	270
6	5019.60	-60.58	3.40	12.50	Vertical	-53.63	-13.00	40.63	180
7	5856.20	-62.36	3.40	12.80	Vertical	-55.11	-13.00	42.11	45
8	6692.80	-57.69	4.10	11.50	Vertical	-52.44	-13.00	39.44	225
9	7529.40	-56.13	4.20	12.20	Vertical	-50.28	-13.00	37.28	0
10	8366.00	-54.69	4.30	12.50	Vertical	-48.64	-13.00	35.64	270

Note: 1.The other Spurious RF Radiated emissions level is no more than noise floor.

2.The worst emission was found in the antenna is Vertical position.



LTE Band 5 1.4MHz CH-Middle

Harmonic	Frequency (MHz)	SG (dBm)	Cable Loss (dB)	Gain (dBi)	Antenna Polarization	ERP Level (dBm)	Limit (dBm)	Margin (dB)	Azimuth (deg)
2	1673.00	-63.14	1.70	8.70	Horizontal	-58.29	-13.00	45.29	225
3	2509.50	-63.59	2.30	12.00	Horizontal	-56.04	-13.00	43.04	90
4	3346.00	-64.74	2.70	12.70	Horizontal	-56.89	-13.00	43.89	90
5	4182.50	-63.42	3.00	12.50	Horizontal	-56.07	-13.00	43.07	45
6	5019.00	-61.24	3.40	12.50	Horizontal	-54.29	-13.00	41.29	135
7	5855.50	-62.05	3.40	12.80	Horizontal	-54.80	-13.00	41.80	180
8	6692.00	-62.29	4.10	11.50	Horizontal	-57.04	-13.00	44.04	45
9	7528.50	-55.06	4.20	12.20	Horizontal	-49.21	-13.00	36.21	315
10	8365.00	-55.68	4.30	12.50	Horizontal	-49.63	-13.00	36.63	90

Note: 1.The other Spurious RF Radiated emissions level is no more than noise floor.
2.The worst emission was found in the antenna is Horizontal position.

LTE Band 5 5MHz CH-Middle

Harmonic	Frequency (MHz)	SG (dBm)	Cable Loss (dB)	Gain (dBi)	Antenna Polarization	ERP Level (dBm)	Limit (dBm)	Margin (dB)	Azimuth (deg)
2	1668.60	-63.14	1.70	8.70	Horizontal	-58.29	-13.00	45.29	315
3	2503.30	-66.86	2.30	12.00	Horizontal	-59.31	-13.00	46.31	90
4	3466.20	-64.16	2.70	12.70	Horizontal	-56.31	-13.00	43.31	90
5	4215.90	-63.17	3.00	12.50	Horizontal	-55.82	-13.00	42.82	45
6	5165.60	-61.25	3.40	12.50	Horizontal	-54.30	-13.00	41.30	225
7	5815.30	-61.92	3.40	12.80	Horizontal	-54.67	-13.00	41.67	90
8	6765.00	-57.64	4.10	11.50	Horizontal	-52.39	-13.00	39.39	45
9	7614.70	-55.25	4.20	12.20	Horizontal	-49.40	-13.00	36.40	315
10	8464.40	-55.43	4.30	12.50	Horizontal	-49.38	-13.00	36.38	90

Note: 1.The other Spurious RF Radiated emissions level is no more than noise floor.
2.The worst emission was found in the antenna is Horizontal position.



LTE Band 5 10MHz CH-Middle

Harmonic	Frequency (MHz)	SG (dBm)	Cable Loss (dB)	Gain (dBi)	Antenna Polarization	ERP Level (dBm)	Limit (dBm)	Margin (dB)	Azimuth (deg)
2	1664.40	-60.56	1.70	8.70	Horizontal	-55.71	-13.00	42.71	225
3	2496.60	-65.02	2.30	12.00	Horizontal	-57.47	-13.00	44.47	90
4	3328.00	-63.89	2.70	12.70	Horizontal	-56.04	-13.00	43.04	225
5	4160.00	-63.42	3.00	12.50	Horizontal	-56.07	-13.00	43.07	0
6	4992.00	-59.91	3.40	12.50	Horizontal	-52.96	-13.00	39.96	0
7	5824.00	-62.10	3.40	12.80	Horizontal	-54.85	-13.00	41.85	90
8	6656.00	-57.52	4.10	11.50	Horizontal	-52.27	-13.00	39.27	45
9	7488.00	-54.60	4.20	12.20	Horizontal	-48.75	-13.00	35.75	315
10	8320.00	-55.15	4.30	12.50	Horizontal	-49.10	-13.00	36.10	90

Note: 1.The other Spurious RF Radiated emissions level is no more than noise floor.

2.The worst emission was found in the antenna is Horizontal position.



6. Main Test Instruments

Name	Manufacturer	Type	Serial Number	Calibration Date	Expiration Date
Horn Antenna	Schwarzbeck	BBHA 9120D	1594	2020-12-17	2021-12-16
Signal Analyzer	R&S	FSV30	104028	2021-05-15	2022-05-14
TRILOG Broadband Antenna	Schwarzbeck	VULB 9163	01111	2019-09-12	2022-09-11
Software	R&S	EMC32	10.35.10	/	/
Universal Radio Communication Tester	R&S	CMW500	150415	2021-05-15	2022-05-14
Spectrum Analyzer	Keysight	N9020A	MY52330084	2021-05-15	2022-05-14
Universal Radio Communication Tester	Agilent	E5515C	GB44400275	2021-05-15	2022-05-14
Spectrum Analyzer	R&S	FSV3030	101411	2020-12-13	2021-12-12
Climate Chamber	WEISS	VT 4002	582261194500 10	2021-05-15	2022-05-14

*****END OF REPORT *****



ANNEX A: The EUT Appearance

The EUT Appearance are submitted separately.



ANNEX B: Test Setup Photos

The Test Setup Photos are submitted separately.