

FCC Radio Test Report

FCC ID: QIS-TE10

This report concerns (check one): Original Grant Class II Change

Project No. : 1608C052
Equipment : Videoconferencing Endpoint
Model Name : HUAWEI TE10
Applicant : Huawei Technologies Co., Ltd.
Address : Administration Building, Headquarters of Huawei Technologies Co., Ltd., Bantian, Longgang District Shenzhen, 518129, P.R.C

Date of Receipt : Aug. 04, 2016
Date of Test : Aug. 04, 2016 ~ Aug. 30, 2016
Issued Date : Aug. 31, 2016
Tested by : BTL Inc.

Testing Engineer : Shawn Xiao
(Shawn Xiao)

Technical Manager : David Mao
(David Mao)

Authorized Signatory : Steven Lu
(Steven Lu)

B T L I N C .

No.3, Jinshagang 1st Road, Shixia, Dalang Town, Dongguan, Guangdong, China.

TEL: +86-769-8318-3000 FAX: +86-769-8319-6000

Declaration

BTL represents to the client that testing is done in accordance with standard procedures as applicable and that test instruments used has been calibrated with standards traceable to international standard(s) and/or national standard(s).

BTL's reports apply only to the specific samples tested under conditions. It is manufacture's responsibility to ensure that additional production units of this model are manufactured with the identical electrical and mechanical components. **BTL** shall have no liability for any declarations, inferences or generalizations drawn by the client or others from **BTL** issued reports.

BTL's report must not be used by the client to claim product certification, approval, or endorsement by NVLAP, NIST, or any agency of the Federal Government.

This report is the confidential property of the client. As a mutual protection to the clients, the public and **BTL-self**, extracts from the test report shall not be reproduced except in full with **BTL's** authorized written approval.

BTL's laboratory quality assurance procedures are in compliance with the **ISO Guide 17025** requirements, and accredited by the conformity assessment authorities listed in this test report.

Limitation

For the use of the authority's logo is limited unless the Test Standard(s)/Scope(s)/Item(s) mentioned in this test report is (are) included in the conformity assessment authorities acceptance respective.

Table of Contents	Page
1 . CERTIFICATION	6
2 . SUMMARY OF TEST RESULTS	7
2.1 TEST FACILITY	8
2.2 MEASUREMENT UNCERTAINTY	8
3 . GENERAL INFORMATION	9
3.1 GENERAL DESCRIPTION OF EUT	9
3.2 DESCRIPTION OF TEST MODES	10
3.3 TABLE OF PARAMETERS OF TEXT SOFTWARE SETTING	10
3.4 BLOCK DIAGRAM SHOWING THE CONFIGURATION OF SYSTEM TESTED	11
3.5 DESCRIPTION OF SUPPORT UNITS	11
4 . EMC EMISSION TEST	12
4.1 CONDUCTED EMISSION MEASUREMENT	12
4.1.1 POWER LINE CONDUCTED EMISSION LIMITS	12
4.1.2 TEST PROCEDURE	12
4.1.3 DEVIATION FROM TEST STANDARD	12
4.1.4 TEST SETUP	13
4.1.5 EUT OPERATING CONDITIONS	13
4.1.6 EUT TEST CONDITIONS	13
4.1.7 TEST RESULTS	13
4.2 RADIATED EMISSION MEASUREMENT	14
4.2.1 RADIATED EMISSION LIMITS	14
4.2.2 TEST PROCEDURE	15
4.2.3 DEVIATION FROM TEST STANDARD	15
4.2.4 TEST SETUP	16
4.2.5 EUT TEST CONDITIONS	17
4.2.6 TEST RESULTS (9KHZ TO 30MHZ)	17
4.2.7 TEST RESULTS (BETWEEN 30MHZ TO 1000 MHZ)	18
4.2.8 TEST RESULTS (ABOVE 1000 MHZ)	18
5 . BANDWIDTH TEST	19
5.1 APPLIED PROCEDURES / LIMIT	19
5.1.1 TEST PROCEDURE	19
5.1.2 DEVIATION FROM STANDARD	19
5.1.3 TEST SETUP	19
5.1.4 EUT OPERATION CONDITIONS	19
5.1.5 EUT TEST CONDITIONS	19
5.1.6 TEST RESULTS	19
6 . MAXIMUM OUTPUT POWER TEST	20

Table of Contents	Page
6.1 APPLIED PROCEDURES / LIMIT	20
6.1.1 TEST PROCEDURE	20
6.1.2 DEVIATION FROM STANDARD	20
6.1.3 TEST SETUP	20
6.1.4 EUT OPERATION CONDITIONS	20
6.1.5 EUT TEST CONDITIONS	20
6.1.6 TEST RESULTS	20
7 . ANTENNA CONDUCTED SPURIOUS EMISSION	21
7.1 APPLIED PROCEDURES / LIMIT	21
7.1.1 TEST PROCEDURE	21
7.1.2 DEVIATION FROM STANDARD	21
7.1.3 TEST SETUP	21
7.1.4 EUT OPERATION CONDITIONS	21
7.1.5 EUT OPERATION CONDITIONS	21
7.1.6 TEST RESULTS	21
8 . POWER SPECTRAL DENSITY TEST	22
8.1 APPLIED PROCEDURES / LIMIT	22
8.1.1 TEST PROCEDURE	22
8.1.2 DEVIATION FROM STANDARD	22
8.1.3 TEST SETUP	22
8.1.4 EUT OPERATION CONDITIONS	22
8.1.5 EUT TEST CONDITIONS	22
8.1.6 TEST RESULTS	22
9 . MEASUREMENT INSTRUMENTS LIST	23
10 . EUT TEST PHOTO	25
ATTACHMENT A - CONDUCTED EMISSION	31
ATTACHMENT B - RADIATED EMISSION (9KHZ TO 30MHZ)	34
ATTACHMENT C - RADIATED EMISSION BETWEEN (30MHZ TO 1000MHZ)	39
ATTACHMENT D - RADIATED EMISSION (ABOVE 1000MHZ)	44
ATTACHMENT E - BANDWIDTH	57
ATTACHMENT F - MAXIMUM OUTPUT POWER TEST	60
ATTACHMENT G - ANTENNA CONDUCTED SPURIOUS EMISSION	61
ATTACHMENT H - POWER SPECTRAL DENSITY TEST	65

REPORT ISSUED HISTORY

Issued No.	Description	Issued Date
BTL-FCCP-2-1608C052	Original Issue.	Aug. 31, 2016

1. CERTIFICATION

Equipment : Videoconferencing Endpoint
Brand Name : HUAWEI
Model Name : HUAWEI TE10
Applicant : Huawei Technologies Co., Ltd.
Manufacturer : Huawei Technologies Co.,Ltd.
Address : Administration Building, Headquarters of Huawei Technologies Co., Ltd.,
Bantian, Longgang District Shenzhen,518129, P.R.C
Factory : Maintek Computer (Suzhou) Co., Ltd.
Address : No. 233, JinFeng Road, New District, SuZhou, China
Date of Test : Aug. 04, 2016 ~ Aug. 30, 2016
Test Sample : Engineering Sample
Standard(s) : FCC Part15, Subpart C (15.247) / ANSI C63.10-2013

The above equipment has been tested and found compliance with the requirement of the relative standards by BTL Inc.

The test data, data evaluation, and equipment configuration contained in our test report (Ref No. BTL-FCCP-2-1608C052) were obtained utilizing the test procedures, test instruments, test sites that has been accredited by the Authority of TAF according to the ISO-17025 quality assessment standard and technical standard(s).

Test results included in this report is only for the IEEE 802.15.4 part.

2. SUMMARY OF TEST RESULTS

Test procedures according to the technical standard(s):

Applied Standard(s): FCC Part15 (15.247) , Subpart C				
Standard(s)	Section	Test Item	Judgment	Remark
	15.207	Conducted Emission	PASS	
	15.247(d)	Antenna conducted Spurious Emission	PASS	
	15.247(a)(2)	6dB Bandwidth	PASS	
	15.247(b)(3)	Peak Output Power	PASS	
	15.247(e)	Power Spectral Density	PASS	
	15.203	Antenna Requirement	PASS	
	15.209/15.205	Transmitter Radiated Emissions	PASS	

NOTE:

(1) "N/A" denotes test is not applicable to this device.

2.1 TEST FACILITY

The test facilities used to collect the test data in this report is at the location of No.3, Jinshagang 1st Road, Shixia, Dalang Town, Dongguan, Guangdong, China.
BTL's test firm number for FCC: 319330

2.2 MEASUREMENT UNCERTAINTY

Where relevant, the following measurement uncertainty levels have been estimated for tests performed on the EUT as specified in CISPR 16-4-2. The measurement instrumentation uncertainty considerations contained in CISPR 16-4-2.

The reported uncertainty of measurement $y \pm U$, where expanded uncertainty U is based on a standard uncertainty multiplied by a coverage factor of $k=2$, providing a level of confidence of approximately **95 %**.

A. Conducted Measurement :

Test Site	Method	Measurement Frequency Range	U, (dB)
DG-C02	CISPR	150 KHz ~ 30MHz	2.32

B. Radiated Measurement :

Test Site	Method	Measurement Frequency Range	Ant. H / V	U, (dB)
DG-CB03	CISPR	9KHz~30MHz	V	3.79
		9KHz~30MHz	H	3.57
		30MHz ~ 200MHz	V	3.82
		30MHz ~ 200MHz	H	3.78
		200MHz ~ 1,000MHz	V	4.10
		200MHz ~ 1,000MHz	H	4.06
		1GHz~18GHz	V	3.12
		1GHz~18GHz	H	3.68
		18GHz~40GHz	V	4.15
		18GHz~40GHz	H	4.14

Note: Unless specifically mentioned, the uncertainty of measurement has not been taken into account to declare the compliance or non-compliance to the specification.

3. GENERAL INFORMATION

3.1 GENERAL DESCRIPTION OF EUT

Equipment	Videoconferencing Endpoint		
Brand Name	HUAWEI		
Model Name	HUAWEI TE10		
Model Difference	N/A		
Product Description	Operation Frequency	2425~2475 MHz	
	Modulation Technology	DSSS	
	Bit Rate of Transmitter	1Mbps	
	Output Power (Max.)	-2.24 dBm	
Power Source	DC Voltage supplied from adapter. Model: MU12AR120100-A2		
Power Rating	I/P: 100-240V~50/60Hz 0.3A O/P: 12V --- 1A		

Note:

- For a more detailed features description, please refer to the manufacturer's specifications or the user's manual.
- Channel List:

Channel	Frequency (MHz)	Channel	Frequency (MHz)
01	2425	07	2455
02	2430	08	2460
03	2435	09	2465
04	2440	10	2470
05	2445	11	2475
06	2450		

3. Table for Filed Antenna:

Ant.	Brand	Model Name	Antenna Type	Connector	Gain (dBi)
1	N/A	N/A	Internal	N/A	2

3.2 DESCRIPTION OF TEST MODES

To investigate the maximum EMI emission characteristics generates from EUT, the test system was pre-scanning tested base on the consideration of following EUT operation mode or test configuration mode which possible have effect on EMI emission level. Each of these EUT operation mode(s) or test configuration mode(s) mentioned above was evaluated respectively.

Pretest Mode	Description
Mode 1	TX Mode NOTE (1)

The EUT system operated these modes were found to be the worst case during the pre-scanning test as following:

For Conducted Test	
Final Test Mode	Description
Mode 1	TX Mode NOTE (1)

For Radiated Test	
Final Test Mode	Description
Mode 1	TX Mode NOTE (1)

Note:

- (1) The measurements are performed at the high, middle, low available channels.
- (2) The measurements for radiated emission, the worst case are high and low channels, only worst case was documented.

3.3 TABLE OF PARAMETERS OF TEXT SOFTWARE SETTING

During testing channel & power controlling software provided by the customer was used to control the operating channel as well as the output power level. The RF output power selection is for the setting of RF output power expected by the customer and is going to be fixed on the firmware of the final end product power parameters of IEEE 802.15.4.

Test Software Version	DutApi_w8887_BrdigeEth		
Frequency (MHz)	2425	2450	2475
IEEE 802.15.4	0	0	0

3.4 BLOCK DIAGRAM SHOWING THE CONFIGURATION OF SYSTEM TESTED

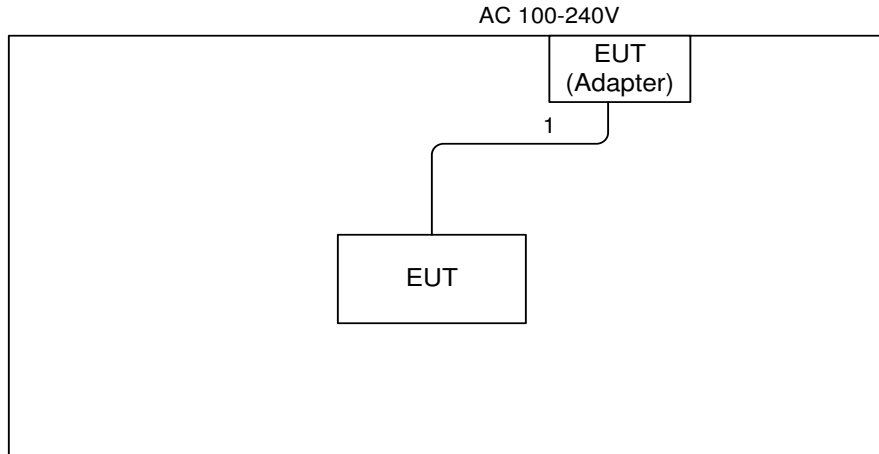

3.5 DESCRIPTION OF SUPPORT UNITS

The EUT has been tested as an independent unit together with other necessary accessories or support units. The following support units or accessories were used to form a representative test configuration during the tests.

Item	Equipment	Mfr/Brand	Model/Type No.	FCC ID	Series No.
-	-	-	-	-	-

Item	Shielded Type	Ferrite Core	Length	Note
1	NO	NO	1.5m	Power Cable

4. EMC EMISSION TEST

4.1 CONDUCTED EMISSION MEASUREMENT

4.1.1 POWER LINE CONDUCTED EMISSION LIMITS (Frequency Range 150KHz-30MHz)

Frequency of Emission (MHz)	Conducted Limit (dBμV)	
	Quasi-peak	Average
0.15 -0.5	66 to 56*	56 to 46*
0.50 -5.0	56	46
5.0 -30.0	60	50

Note:

- (1) The limit of " * " decreases with the logarithm of the frequency
- (2) The test result calculated as following:
 Measurement Value = Reading Level + Correct Factor
 Correct Factor = Antenna Factor + Cable Loss - Amplifier Gain(if use)
 Margin Level = Measurement Value - Limit Value

The following table is the setting of the receiver

Receiver Parameters	Setting
Attenuation	10 dB
Start Frequency	0.15 MHz
Stop Frequency	30 MHz
IF Bandwidth	9 kHz

4.1.2 TEST PROCEDURE

- a. The EUT was placed 0.8 meters from the horizontal ground plane with EUT being connected to the power mains through a line impedance stabilization network (LISN). All other support equipment powered from additional LISN(s). The LISN provide 50 Ohm/ 50uH of coupling impedance for the measuring instrument.
- b. Interconnecting cables that hang closer than 40 cm to the ground plane shall be folded back and forth in the center forming a bundle 30 to 40 cm long.
- c. I/O cables that are not connected to a peripheral shall be bundled in the center. The end of the cable may be terminated, if required, using the correct terminating impedance. The overall length shall not exceed 1 m.
- d. LISN at least 80 cm from nearest part of EUT chassis.
- e. For the actual test configuration, please refer to the related Item –EUT Test Photos.

4.1.3 DEVIATION FROM TEST STANDARD

No deviation

4.1.4 TEST SETUP

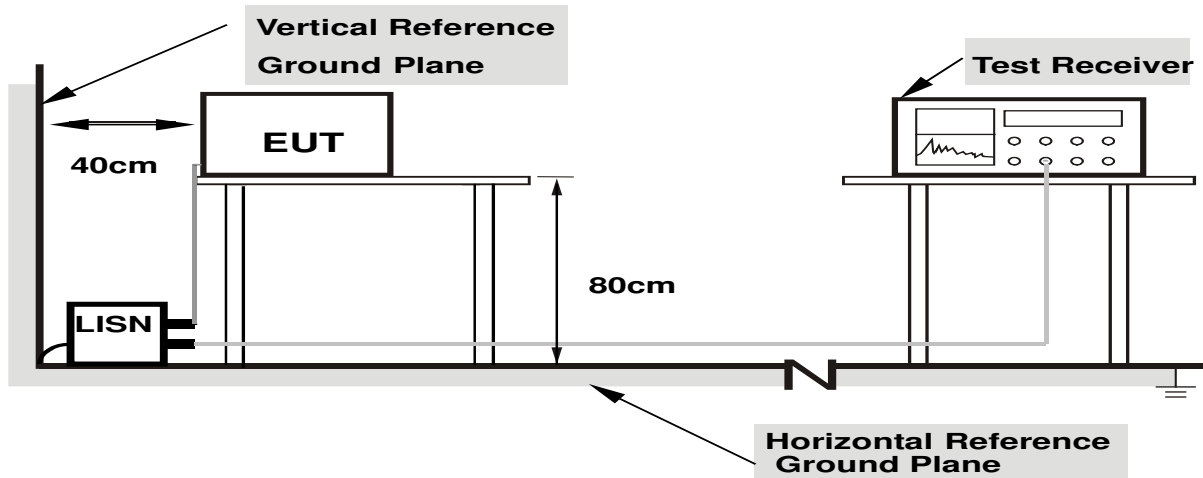

- Note:**
- 1.Support units were connected to second LISN.
 - 2.Both of LISNs (AMN) are 80 cm from EUT and at least 80 from other units and other metal planes

4.1.5 EUT OPERATING CONDITIONS

The EUT was configured for testing in a typical function (as a customer would normally use it), EUT was programmed to be in continuously transmitting/receiving data or hopping on mode.

4.1.6 EUT TEST CONDITIONS

Temperature: 25°C
 Relative Humidity: 55%
 Test Voltage: AC 120V/60Hz

4.1.7 TEST RESULTS

Please refer to the Attachment A.

Remark:

- (1) All readings are QP Mode value unless otherwise stated AVG in column of 『Note』 . If the QP Mode Measured value compliance with the QP Limits and lower than AVG Limits, the EUT shall be deemed to meet both QP & AVG Limits and then only QP Mode was measured, but AVG Mode didn't perform.In this case, a “ * ” marked in AVG Mode column of Interference Voltage Measured.
- (2) Measuring frequency range from 150KHz to 30MHz.
- (3) “ N/A” denotes test is not applicable to this device.

4.2 RADIATED EMISSION MEASUREMENT

4.2.1 RADIATED EMISSION LIMITS

In case the emission fall within the restricted band specified on 15.205(a), then the 15.209(a) limit in the table below has to be followed.

LIMITS OF RADIATED EMISSION MEASUREMENT (9KHz-1000MHz)

Frequency (MHz)	Field Strength (microvolts/meter)	Measurement Distance (meters)
0.009~0.490	2400/F(KHz)	300
0.490~1.705	24000/F(KHz)	30
1.705~30.0	30	30
30~88	100	3
88~216	150	3
216~960	200	3
960~1000	500	3

LIMITS OF RADIATED EMISSION MEASUREMENT (Above 1000MHz)

Frequency (MHz)	Band edge at 3m (dBμV/m)		Harmonic at 1.5m (dBμV/m)	
	Peak	Average	Peak	Average
Above 1000	74	54	80 (Note 5)	60 (Note 5)

Notes:

- (1) The limit for radiated test was performed according to FCC PART 15C.
- (2) The tighter limit applies at the band edges.
- (3) Emission level (dBuV/m)=20log Emission level (uV/m).
- (4) The test result calculated as following:
 Measurement Value = Reading Level + Correct Factor
 Correct Factor = Antenna Factor + Cable Loss - Amplifier Gain(if use)
 Margin Level = Measurement Value - Limit Value

(5)

$$FS_{\text{limit}} = FS_{\text{max}} - 20 \log \left(\frac{d_{\text{limit}}}{d_{\text{measure}}} \right)$$

$$20 \log d_{\text{limit}}/d_{\text{measure}} = 20 \log 3/1.5 = 6 \text{dB.}$$

Spectrum Parameter	Setting
Attenuation	Auto
Start Frequency	1000 MHz
Stop Frequency	10th carrier harmonic
RBW / VBW (Emission in restricted band)	RBW 1MHz VBW 3MHz peak detector for Pk value RMS detector for AV value

Receiver Parameter	Setting
Attenuation	Auto
Start ~ Stop Frequency	9KHz~90KHz for PK/AVG detector
Start ~ Stop Frequency	90KHz~110KHz for QP detector
Start ~ Stop Frequency	110KHz~490KHz for PK/AVG detector
Start ~ Stop Frequency	490KHz~30MHz for QP detector
Start ~ Stop Frequency	30MHz~1000MHz for QP detector

4.2.2 TEST PROCEDURE

- a. The measuring distance of 3 m shall be used for measurements. The EUT was placed on the top of a rotating table 0.8 meter above the ground at a 3 meter semi-anechoic chamber. The table was rotated 360 degrees to determine the position of the highest radiation.(below 1GHz)
- b. The measuring distance of 3 or 1.5m m shall be used for measurements. The EUT was placed on the top of a rotating table 1.5 meter above the ground at a 3 meter semi-anechoic chamber. The table was rotated 360 degrees to determine the position of the highest radiation.(above 1GHz)
- c. The height of the equipment or of the substitution antenna shall be 0.8 m or 1.5 m, the height of the test antenna shall vary between 1 m to 4 m. Both horizontal and vertical polarizations of the antenna are set to make the measurement.
- d. For each suspected emission, the EUT was arranged to its worst case and then the antenna was tuned to heights find the maximum reading (used Bore sight function).
- e. The receiver system was set to peak and average detect function and specified bandwidth with maximum hold mode when the test frequency is above 1GHz.
- f. The initial step in collecting radiated emission data is a receiver peak detector mode pre-scanning the measurement frequency range. Significant peaks are then marked and then Quasi Peak detector mode re-measured.
- g. All readings are Peak unless otherwise stated QP in column of Note. Peak denotes that the Peak reading compliance with the QP Limits and then QP Mode measurement didn't perform. (below 1GHz)
- h. All readings are Peak Mode value unless otherwise stated AVG in column of Note. If the Peak Mode Measured value compliance with the Peak Limits and lower than AVG Limits, the EUT shall be deemed to meet both Peak & AVG Limits and then only Peak Mode was measured, but AVG Mode didn't perform. (above 1GHz)
- i. For the actual test configuration, please refer to the related Item –EUT Test Photos.

4.2.3 DEVIATION FROM TEST STANDARD

No deviation

4.2.4 TEST SETUP

(A) Radiated Emission Test Set-Up Frequency Below 1 GHz

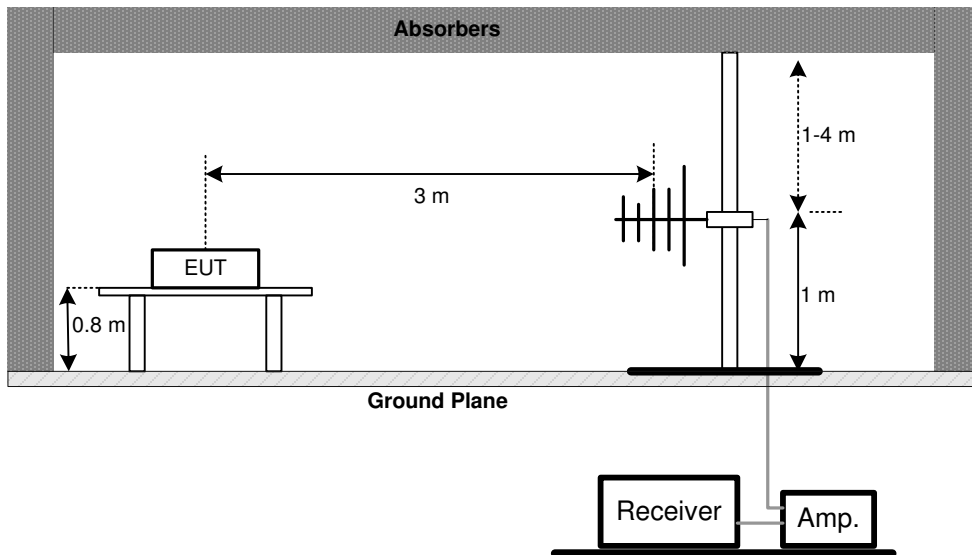

(B) Radiated Emission Test Set-Up Frequency Above 1 GHz
Band edge

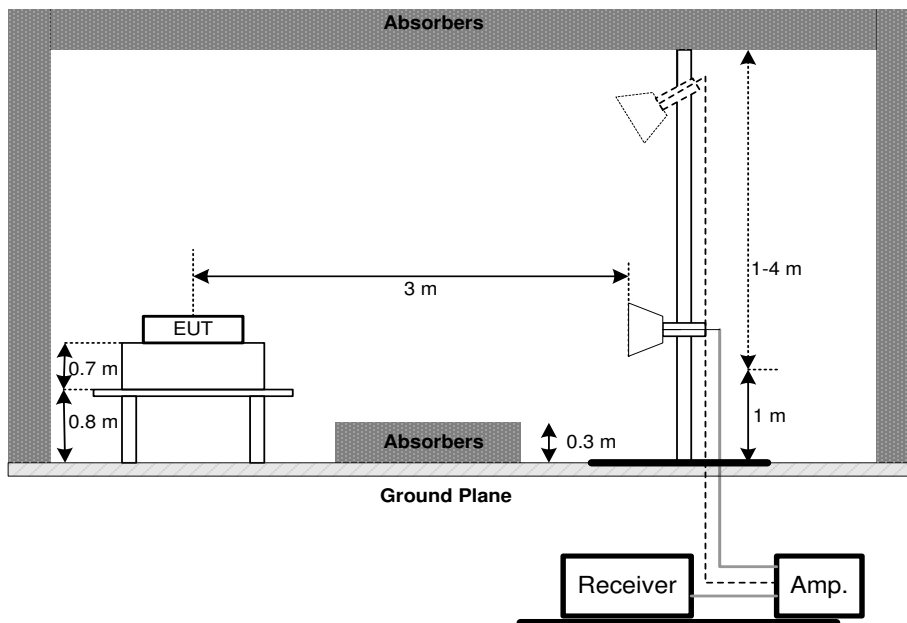

Harmonic

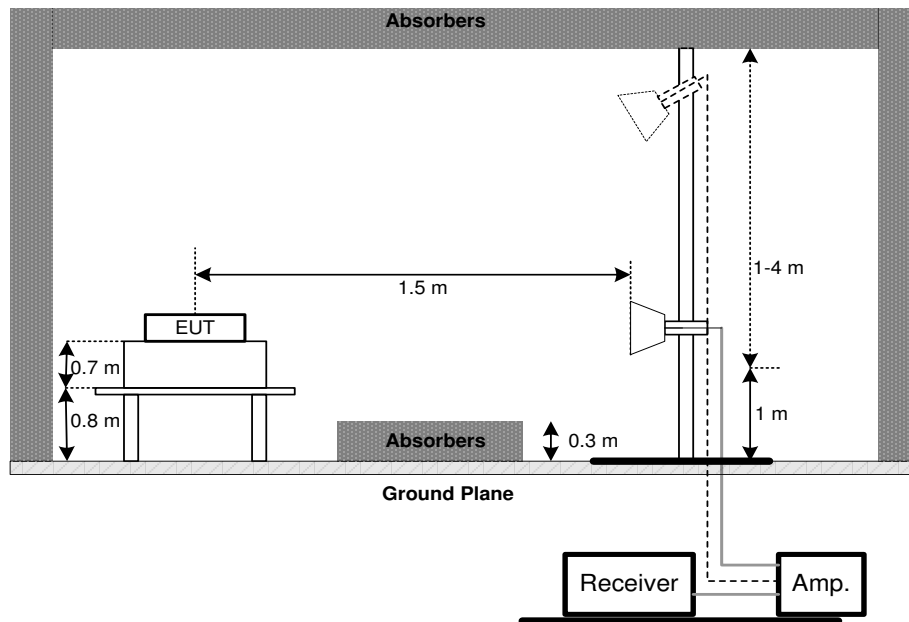

(C) For Radiated Emissions Below 30MHz

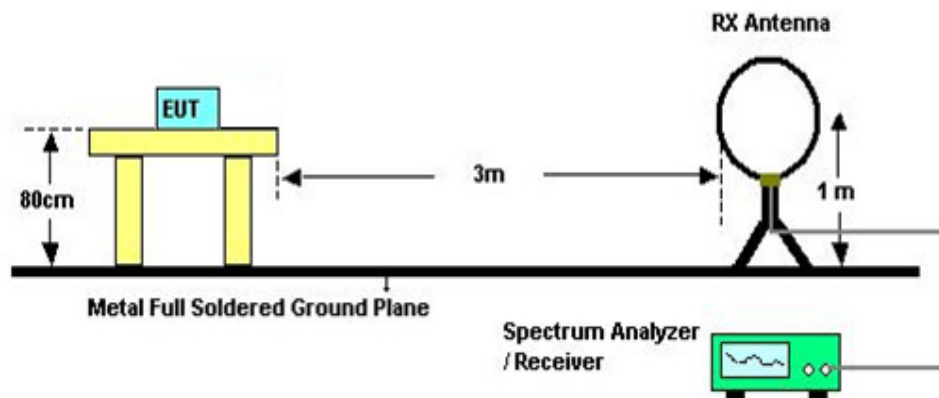

4.2.5 EUT TEST CONDITIONS

Temperature: 25°C
 Relative Humidity: 55%
 Test Voltage: AC 120V/60Hz

4.2.6 TEST RESULTS (9KHZ TO 30MHZ)

Please refer to the Attachment B.

Remark:

- (1) The amplitude of spurious emissions which are attenuated by more than 20 dB below the permissible value has no need to be reported.
- (2) Distance extrapolation factor = $40 \log(\text{specific distance} / \text{test distance})$ (dB).
- (3) Limit line = specific limits (dBuV) + distance extrapolation factor.

4.2.7 TEST RESULTS (BETWEEN 30MHZ TO 1000 MHZ)

Please refer to the Attachment C.

Remark:

- (1) Measuring frequency range from 30MHz to 1000MHz.
- (2) If the peak scan value lower limit more than 20dB, then this signal data does not show in table.

4.2.8 TEST RESULTS (ABOVE 1000 MHZ)

Please refer to the Attachment D.

Remark:

- (1) Radiated emissions measured in frequency range above 1000MHz were made with an instrument using Peak detector mode and AV detector mode of the emission
- (2) A preamp and high pass filter were used for this test in order to provide sufficient measurement sensitivity.
- (3) EUT Orthogonal Axis:
"X" - denotes Laid on Table ; "Y" - denotes Vertical Stand ; "Z" - denotes Side Stand
- (4) During the measurements above 1 GHz it is taken care of that the EUT is always within the 3 dB cone of radiation BW of the used antenna
- (5) No limit: This is fundamental signal, the judgment is not applicable.
For fundamental signal judgment was referred to Peak output test.

5. BANDWIDTH TEST

5.1 APPLIED PROCEDURES / LIMIT

FCC Part15 (15.247) , Subpart C				
Section	Test Item	Limit	Frequency Range (MHz)	Result
15.247(a)(2)	Bandwidth	$\geq 500\text{KHz}$ (6dB bandwidth)	2425~2475 MHz	PASS

5.1.1 TEST PROCEDURE

- a. The EUT was directly connected to the spectrum analyzer and antenna output port as show in the block diagram below,
- b. Spectrum Setting : RBW= 100KHz, VBW=300KHz, Sweep time = 2.5 ms.

5.1.2 DEVIATION FROM STANDARD

No deviation.

5.1.3 TEST SETUP

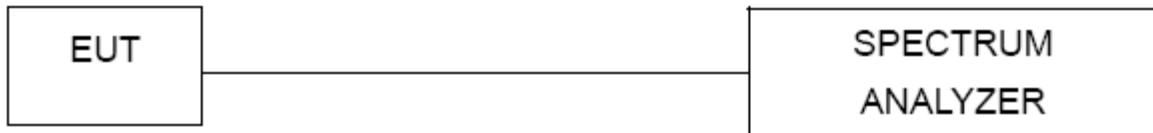

5.1.4 EUT OPERATION CONDITIONS

The EUT tested system was configured as the statements of 4.1.5 unless otherwise a special operating condition is specified in the follows during the testing.

5.1.5 EUT TEST CONDITIONS

Temperature: 25°C
 Relative Humidity: 55%
 Test Voltage: AC 120V/60Hz

5.1.6 TEST RESULTS

Please refer to the Attachment E.

6. MAXIMUM OUTPUT POWER TEST

6.1 APPLIED PROCEDURES / LIMIT

FCC Part15 (15.247) , Subpart C				
Section	Test Item	Limit	Frequency Range (MHz)	Result
15.247(b)(3)	Maximum Output Power	1 watt or 30dBm	2425~2475 MHz	PASS

6.1.1 TEST PROCEDURE

- a. The EUT was directly connected to the power meter and antenna output port as show in the block diagram below,
- b. The maximum peak conducted output power was performed in accordance with method 9.1.2 of FCC KDB 558074 D01 DTS Meas Guidance v03r05.

6.1.2 DEVIATION FROM STANDARD

No deviation.

6.1.3 TEST SETUP

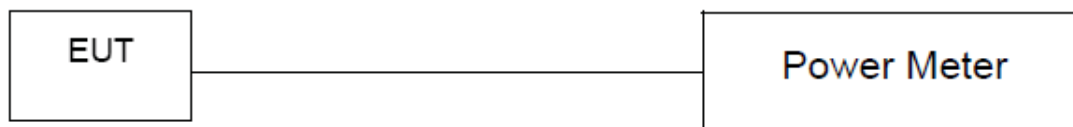

6.1.4 EUT OPERATION CONDITIONS

The EUT tested system was configured as the statements of 4.1.5 unless otherwise a special operating condition is specified in the follows during the testing. Transmit output power was measured while the host equipment supply voltage was varied from 85 % to 115 % of the nominal rated supply voltage. No change in transmit output power was observed.

6.1.5 EUT TEST CONDITIONS

Temperature: 25°C
 Relative Humidity: 55%
 Test Voltage: AC 120V/60Hz

6.1.6 TEST RESULTS

Please refer to the Attachment F.

7. ANTENNA CONDUCTED SPURIOUS EMISSION

7.1 APPLIED PROCEDURES / LIMIT

In any 100 kHz bandwidth outside the frequency band in which the spread spectrum or digitally modulated intentional radiator is operating, the radio frequency power that is produced by the intentional radiator shall be at least 20 dB below that in the 100 kHz bandwidth within the band that contains the highest level of the desired power, based on either an RF conducted measurement, provided the transmitter demonstrates compliance with the peak conducted power limits.

7.1.1 TEST PROCEDURE

- a. The EUT was directly connected to the spectrum analyzer and antenna output port as show in the block diagram below,
- b. Spectrum Setting : RBW= 100KHz, VBW=300KHz, Sweep time = 10 ms.
- c. Offset=antenna gain + cable loss

7.1.2 DEVIATION FROM STANDARD

No deviation.

7.1.3 TEST SETUP

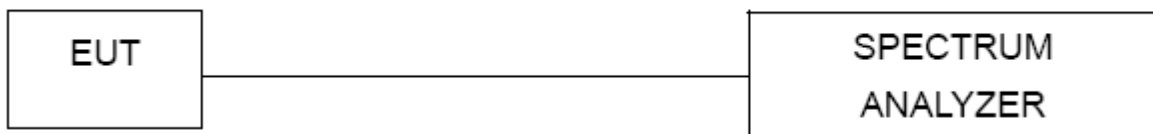

7.1.4 EUT OPERATION CONDITIONS

The EUT tested system was configured as the statements of 4.1.5 unless otherwise a special operating condition is specified in the follows during the testing.

7.1.5 EUT OPERATION CONDITIONS

Temperature: 25°C
 Relative Humidity: 55%
 Test Voltage: AC 120V/60Hz

7.1.6 TEST RESULTS

Please refer to the Attachment G.

8. POWER SPECTRAL DENSITY TEST

8.1 APPLIED PROCEDURES / LIMIT

FCC Part15 (15.247) , Subpart C				
Section	Test Item	Limit	Frequency Range (MHz)	Result
15.247(e)	Power Spectral Density	8 dBm (in any 3KHz)	2425~2475 MHz	PASS

8.1.1 TEST PROCEDURE

- a. The EUT was directly connected to the spectrum analyzer and antenna output port as show in the block diagram below,
- b. Spectrum Setting: RBW=3KHz, VBW=10 KHz, Sweep time = auto.

8.1.2 DEVIATION FROM STANDARD

No deviation.

8.1.3 TEST SETUP



8.1.4 EUT OPERATION CONDITIONS

The EUT tested system was configured as the statements of 4.1.5 unless otherwise a special operating condition is specified in the follows during the testing.

8.1.5 EUT TEST CONDITIONS

Temperature: 25°C
 Relative Humidity: 55%
 Test Voltage: AC 120V/60Hz

8.1.6 TEST RESULTS

Please refer to the Attachment H.

9. MEASUREMENT INSTRUMENTS LIST

Conducted Emission Measurement					
Item	Kind of Equipment	Manufacturer	Type No.	Serial No.	Calibrated until
1	LISN	EMCO	3816/2	0052765	Mar. 27, 2017
2	LISN	R&S	ENV216	101447	Mar. 27, 2017
3	Test Cable	emci	RG223(9KHz-30 MHz)	C_17	Mar. 10, 2017
4	EMI Test Receiver	R&S	ESCI	100382	Mar. 27, 2017
5	50Ω Terminator	SHX	TF2-3G-A	08122901	Mar. 27, 2017
6	Measurement Software	Farad	EZ-EMC Ver.NB-03A1-01	N/A	N/A

Radiated Emission Measurement					
Item	Kind of Equipment	Manufacturer	Type No.	Serial No.	Calibrated until
1	Antenna	Schwarzbeck	VULB9160	9160-3232	Mar. 27, 2017
2	Amplifier	HP	8447D	2944A09673	Nov. 09, 2016
3	Receiver	AGILENT	N9038A	MY52130039	Oct. 11, 2016
4	Test Cable	emci	LMR-400(30MHz-1GHz)	C-01	Jun. 26, 2017
5	Controller	CT	SC100	N/A	N/A
6	Measurement Software	Farad	EZ-EMC Ver.NB-03A1-01	N/A	N/A
7	Antenna	ETS	3115	00075789	Mar. 27, 2017
8	Amplifier	Agilent	8449B	3008A02274	Nov. 01, 2016
9	Receiver	AGILENT	N9038A	MY52130039	Oct. 11, 2016
10	Test Cable	emci	EMC104-SM-S M-10000(1GHz-26.5GHz)	C-68	Jun. 26, 2017
11	Broad-Band Horn Antenna	Schwarzbeck	BBHA 9170	9170319	Mar. 27, 2017
12	Microwave Preamplifier With Adaptor	EMC INSTRUMENT	EMC2654045	980039 & HA01	Mar. 27, 2017
13	Active Loop Antenna	R&S	HFH2-Z2	830749/020	Sep. 07, 2016

6dB Bandwidth Measurement					
Item	Kind of Equipment	Manufacturer	Type No.	Serial No.	Calibrated until
1	Spectrum Analyzer	R&S	FSP 40	100185	Oct. 11, 2016

Peak Output Power Measurement					
Item	Kind of Equipment	Manufacturer	Type No.	Serial No.	Calibrated until
1	power Meter	ANRITSU	ML2495A	1128009	Mar. 27, 2017
2	Pulse Power Sensor	ANRITSU	MA 2411B	1027500	Mar. 27, 2017

Antenna Conducted Spurious Emission Measurement					
Item	Kind of Equipment	Manufacturer	Type No.	Serial No.	Calibrated until
1	Spectrum Analyzer	R&S	FSP 40	100185	Oct. 11, 2016

Power Spectral Density Measurement					
Item	Kind of Equipment	Manufacturer	Type No.	Serial No.	Calibrated until
1	Spectrum Analyzer	R&S	FSP 40	100185	Oct. 11, 2016

Remark: "N/A" denotes no model name, serial no. or calibration specified.
 All calibration period of equipment list is one year.

10. EUT TEST PHOTO

Conducted Measurement Photos



9KHz to 30MHz Radiated Measurement Photos



30MHz to 1000MHz Radiated Measurement Photos

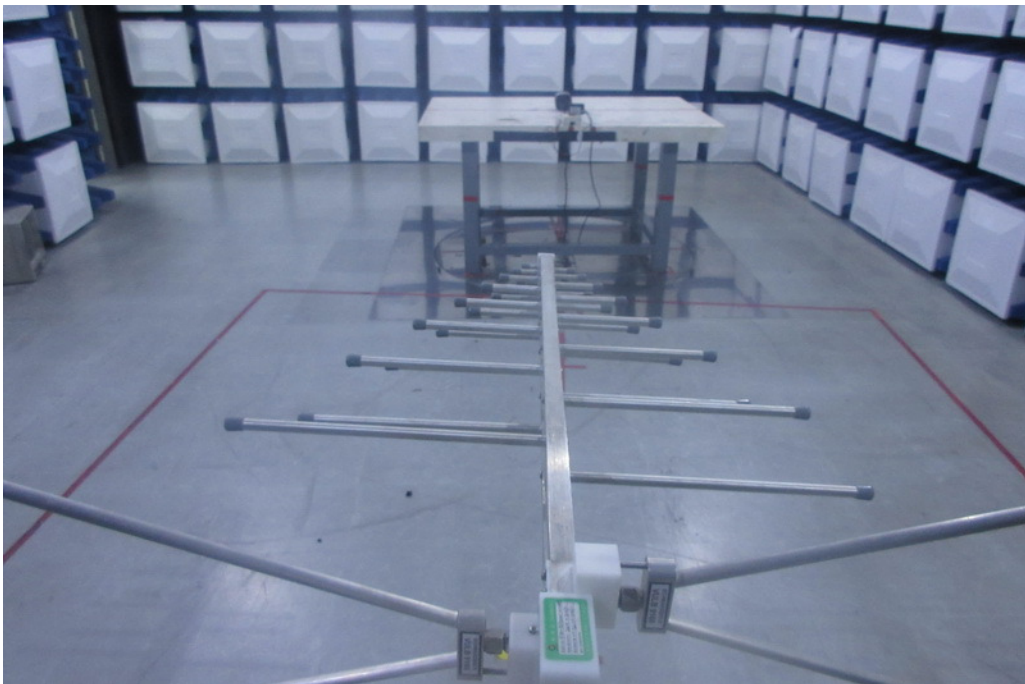
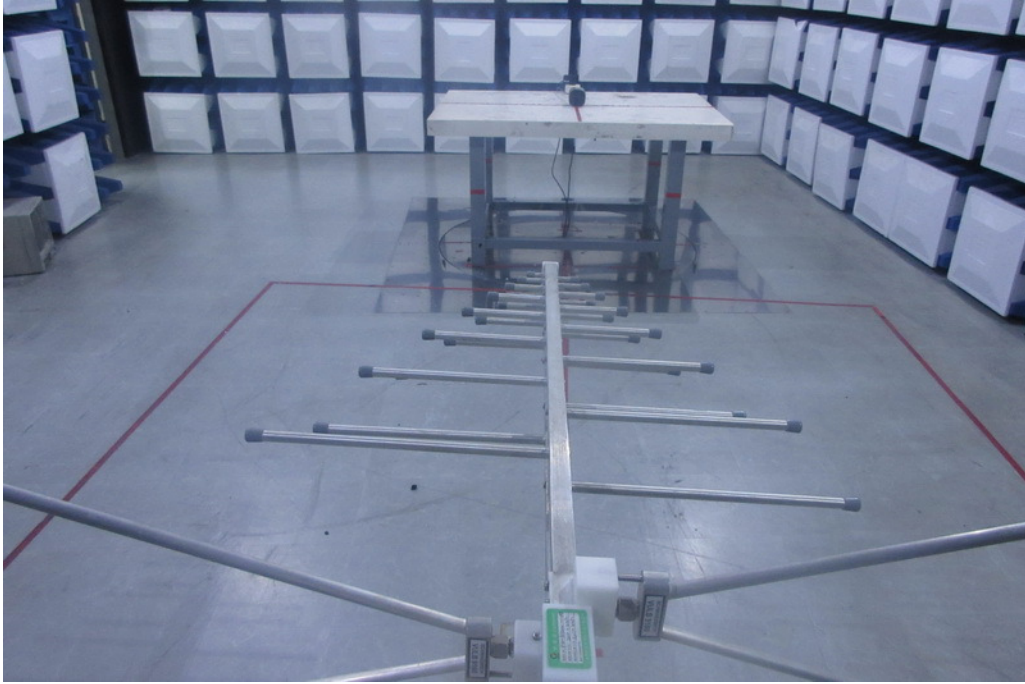

1GHz to 18GHz Radiated Measurement Photos

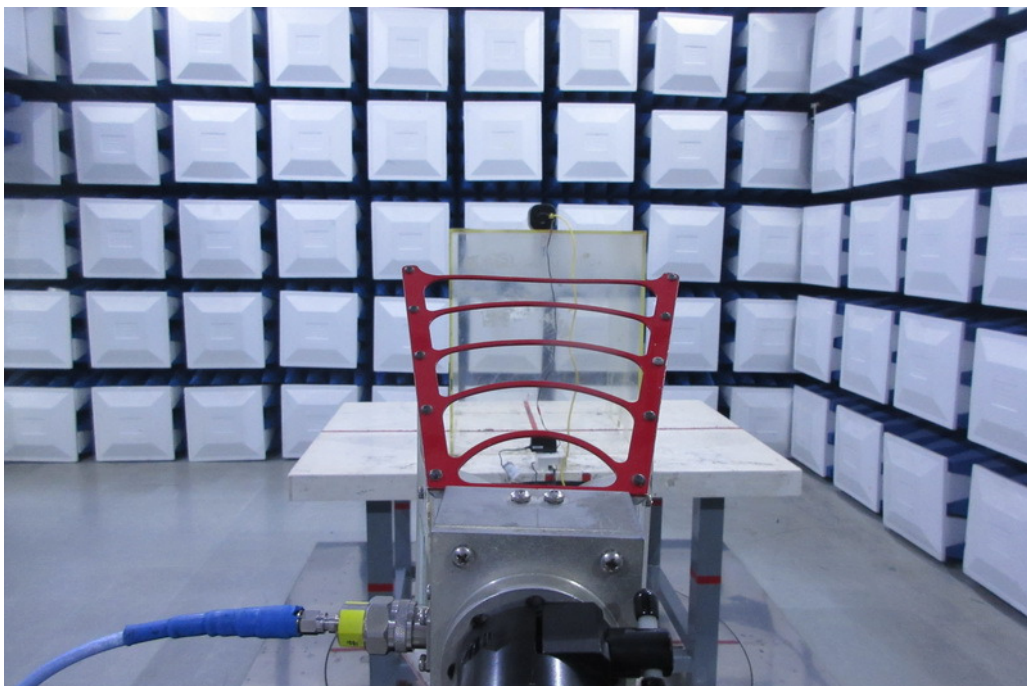
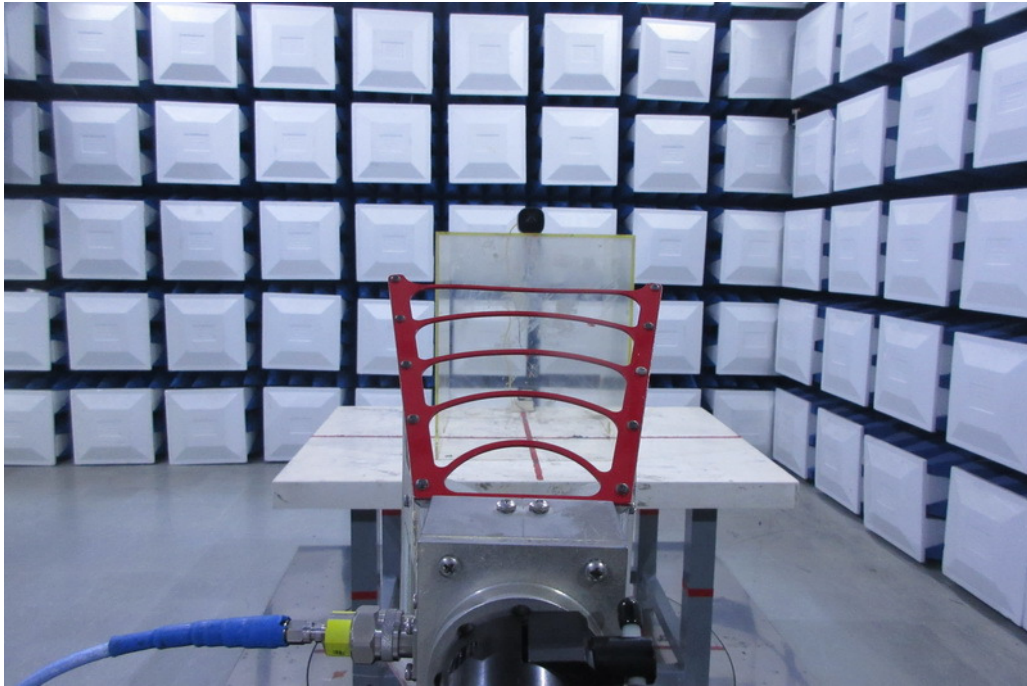

18GHz to 26.5GHz Radiated Measurement Photos

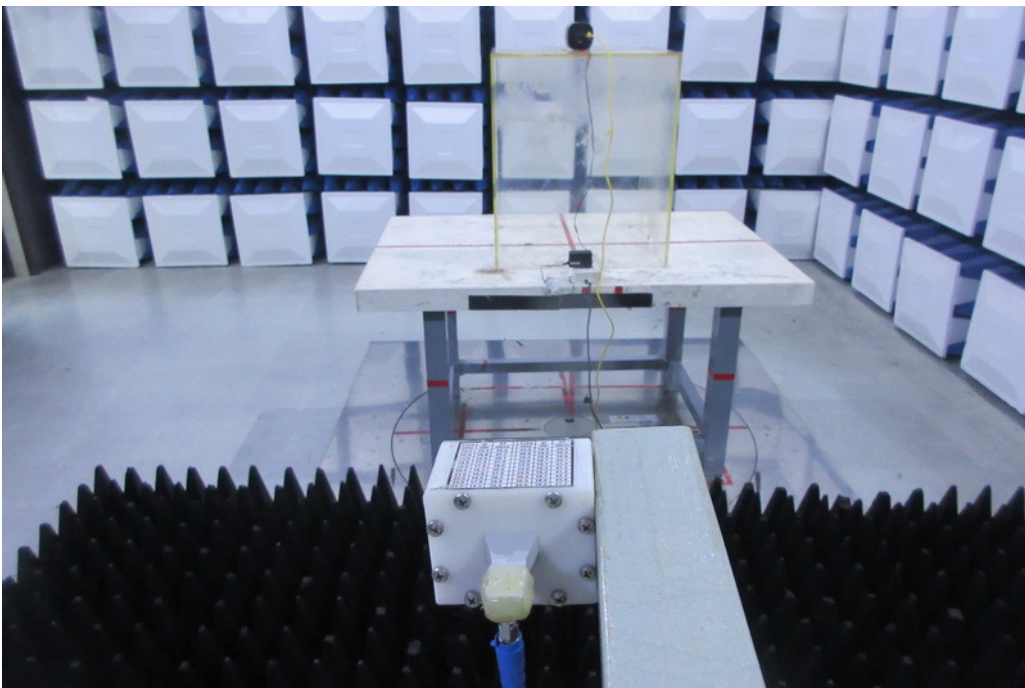
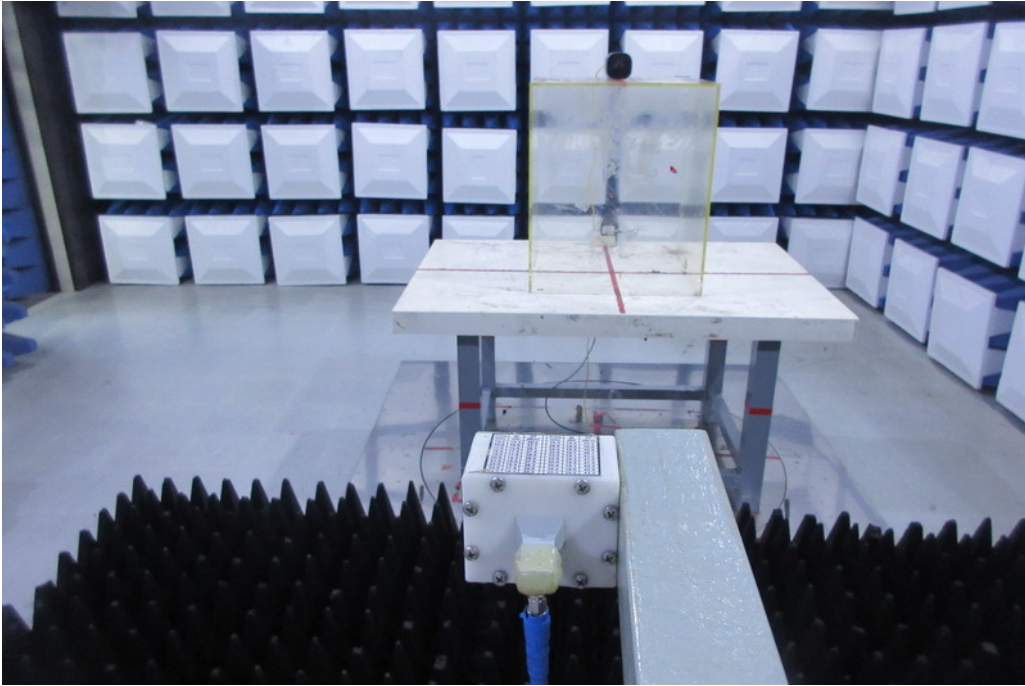

Band Edge Measurement Photos

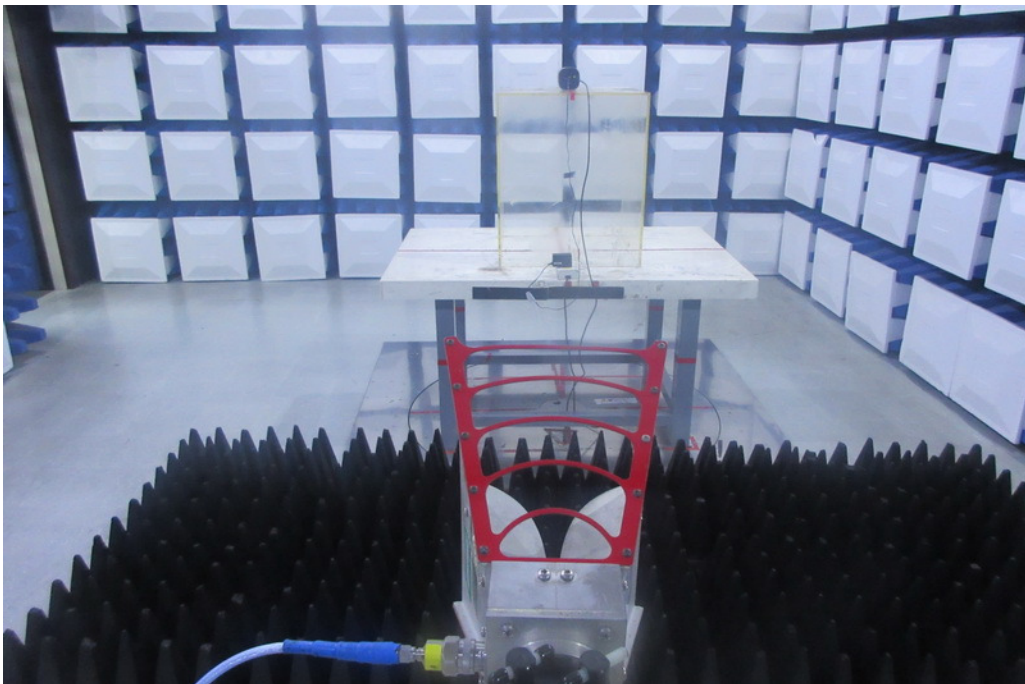
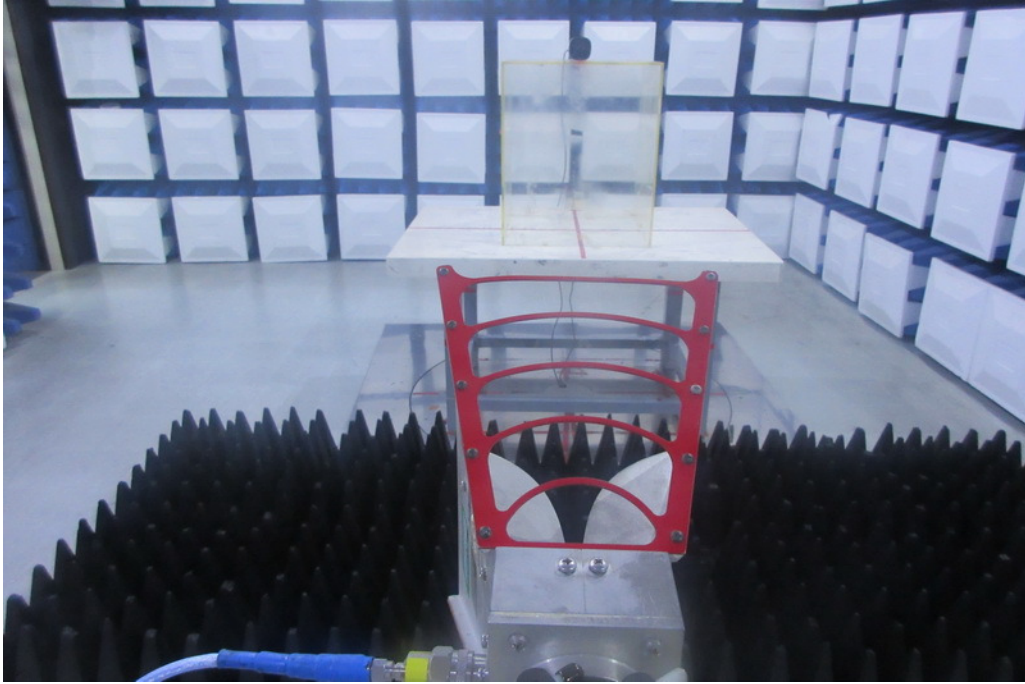

ATTACHMENT A - CONDUCTED EMISSION

Test Mode: TX Mode

Line

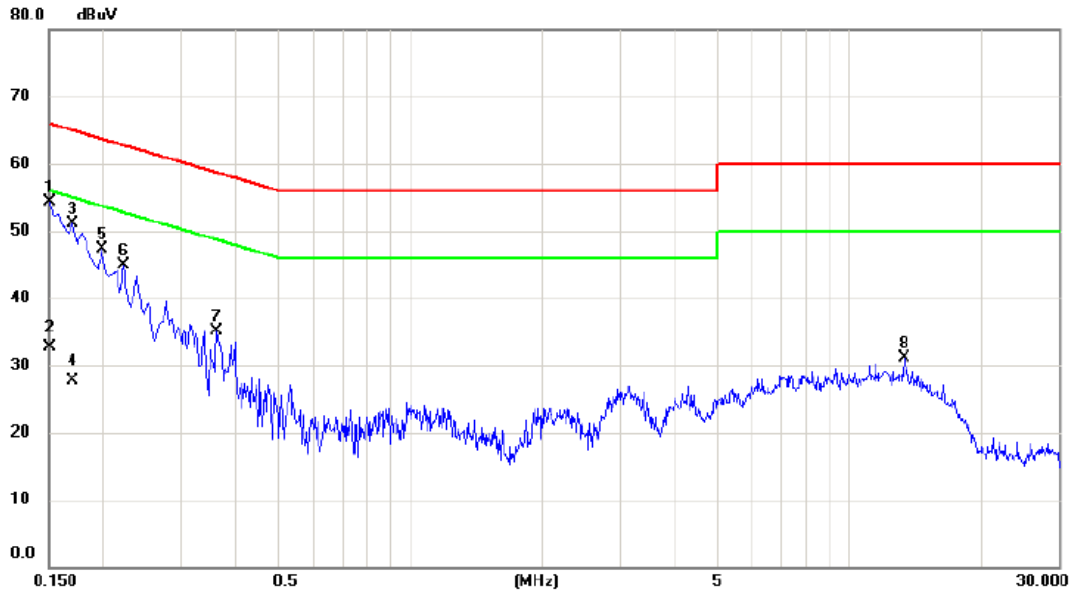

No.	Mk.	Freq. MHz	Reading Level dBuV	Correct Factor dB	Measure- ment dBuV	Limit dBuV	Margin dB	Detector	Comment
1	*	0.1500	44.81	9.52	54.33	66.00	-11.67	peak	
2		0.1500	23.20	9.52	32.72	56.00	-23.28	AVG	
3		0.1700	41.68	9.52	51.20	64.96	-13.76	peak	
4		0.1700	18.10	9.52	27.62	54.96	-27.34	AVG	
5		0.1980	37.77	9.53	47.30	63.69	-16.39	peak	
6		0.2220	35.37	9.53	44.90	62.74	-17.84	peak	
7		0.3620	25.48	9.54	35.02	58.68	-23.66	peak	
8		13.3860	20.77	10.31	31.08	60.00	-28.92	peak	

Test Mode: TX Mode

Neutral

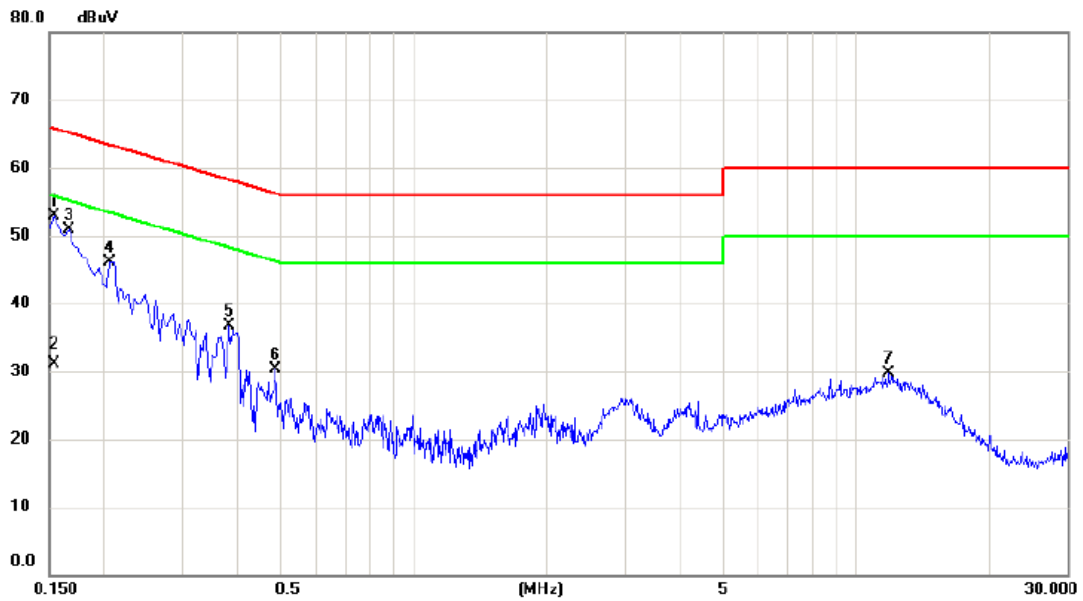

No.	Mk.	Freq. MHz	Reading Level dBuV	Correct Factor dB	Measure- ment dBuV	Limit dBuV	Margin dB	Detector	Comment
1	*	0.1540	43.45	9.50	52.95	65.78	-12.83	peak	
2		0.1540	21.70	9.50	31.20	55.78	-24.58	AVG	
3		0.1660	41.53	9.44	50.97	65.16	-14.19	peak	
4		0.2060	36.57	9.53	46.10	63.37	-17.27	peak	
5		0.3820	27.16	9.48	36.64	58.24	-21.60	peak	
6		0.4860	20.90	9.44	30.34	56.24	-25.90	peak	
7		11.8780	19.36	10.33	29.69	60.00	-30.31	peak	

ATTACHMENT B - RADIATED EMISSION (9KHZ TO 30MHZ)

Test Mode: TX Mode

Ant 0°

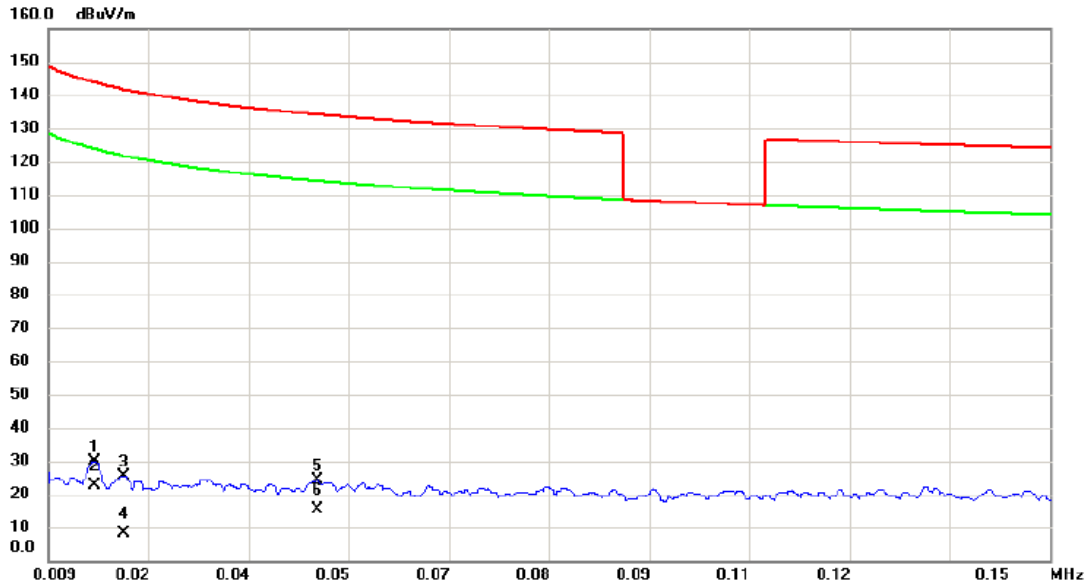

No.	Mk.	Freq. MHz	Reading Level dBuV	Correct Factor dB	Measure- ment dBuV/m	Limit dBuV/m	Margin dB	Detector	Comment
1		0.0155	8.46	21.40	29.86	143.80	-113.94	peak	
2		0.0155	1.20	21.40	22.60	123.80	-101.20	AVG	
3		0.0196	4.23	21.33	25.56	141.76	-116.20	peak	
4		0.0196	-13.10	21.33	8.23	121.76	-113.53	AVG	
5		0.0468	2.59	21.59	24.18	134.20	-110.02	peak	
6	*	0.0468	-6.20	21.59	15.39	114.20	-98.81	AVG	

Test Mode: TX Mode

Ant 0°

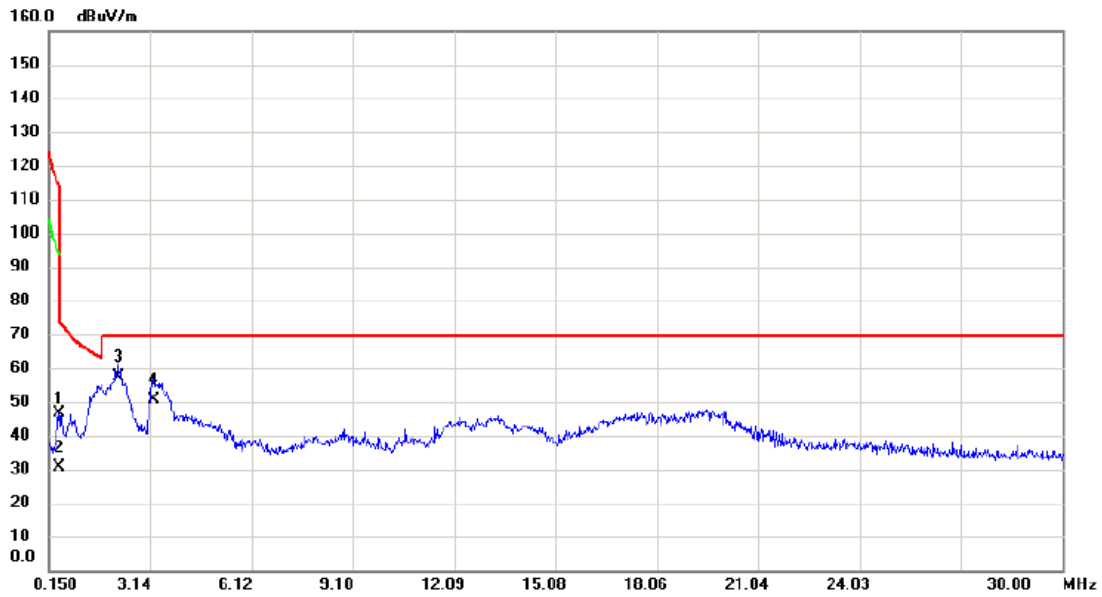

No.	Mk.	Freq. MHz	Reading Level dBuV	Correct Factor dB	Measurement dBuV/m	Limit dBuV/m	Margin dB	Detector	Comment
1		0.4485	25.55	20.98	46.53	114.57	-68.04	peak	
2		0.4485	9.80	20.98	30.78	94.57	-63.79	AVG	
3	*	2.1798	35.70	21.70	57.40	69.54	-12.14	QP	
4		3.2244	28.50	21.93	50.43	69.54	-19.11	QP	

Test Mode: TX Mode

Ant 90°

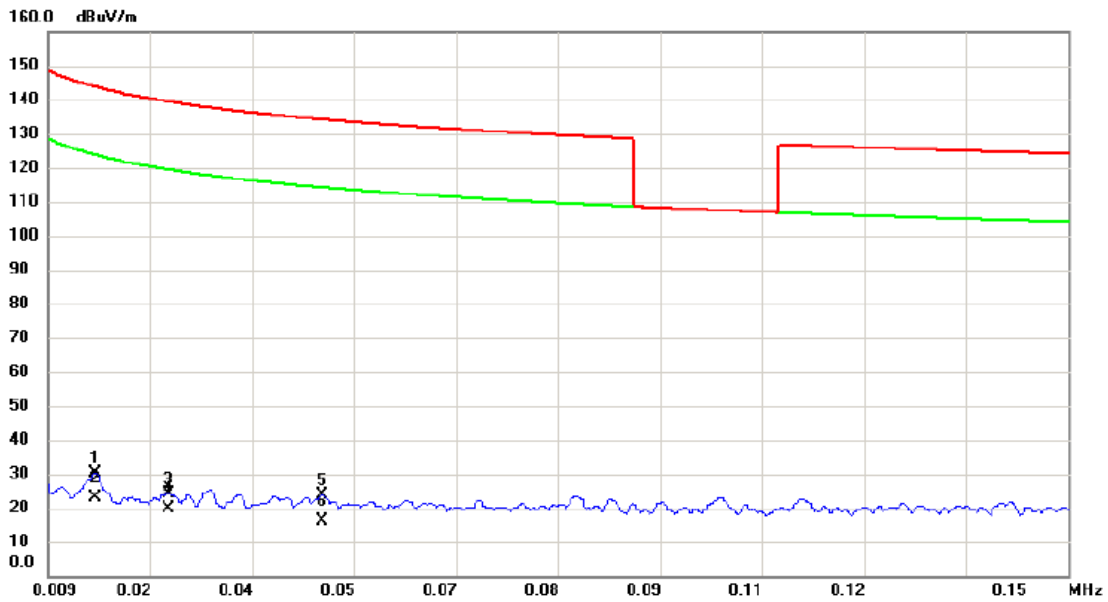

No.	Mk.	Freq. MHz	Reading Level dBuV	Correct Factor dB	Measure- ment dBuV/m	Limit dBuV/m	Margin dB	Detector	Comment
1		0.0154	8.72	21.40	30.12	143.85	-113.73	peak	
2		0.0154	1.70	21.40	23.10	123.85	-100.75	AVG	
3		0.0256	2.86	21.38	24.24	139.44	-115.20	peak	
4		0.0256	-1.40	21.38	19.98	119.44	-99.46	AVG	
5		0.0468	2.36	21.59	23.95	134.20	-110.25	peak	
6	*	0.0468	-5.50	21.59	16.09	114.20	-98.11	AVG	

Test Mode: TX Mode

Ant 90°

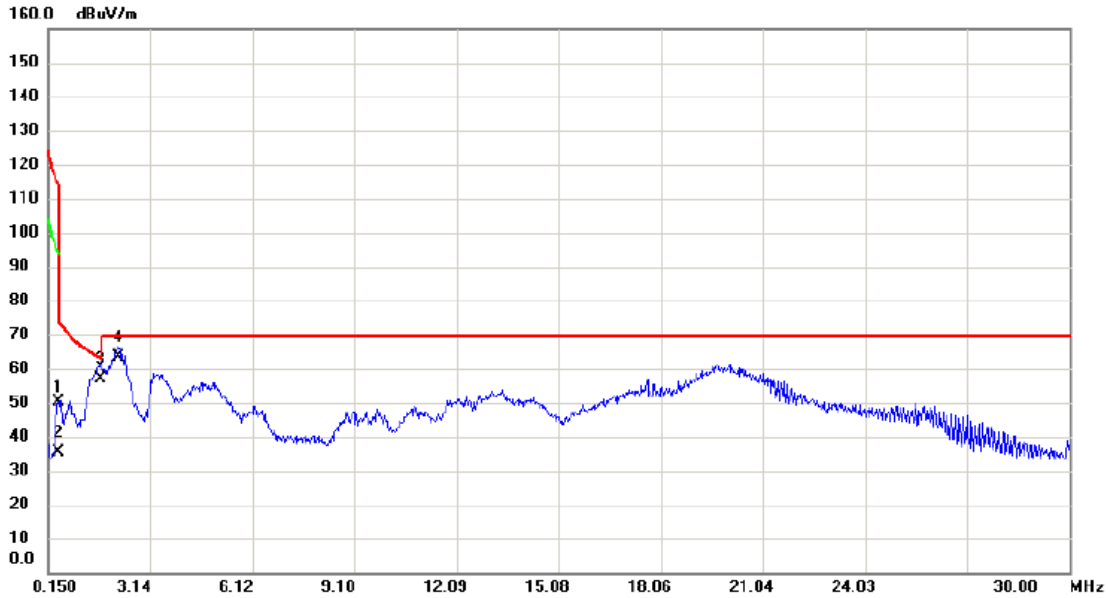

No.	Mk.	Freq. MHz	Reading Level dBuV	Correct Factor dB	Measure- ment dBuV/m	Limit dBuV/m	Margin dB	Detector	Comment
1		0.4485	29.12	20.98	50.10	114.57	-64.47	peak	
2		0.4485	14.30	20.98	35.28	94.57	-59.29	AVG	
3	*	1.6724	35.40	21.60	57.00	63.14	-6.14	QP	
4		2.1798	41.70	21.70	63.40	69.54	-6.14	QP	

**ATTACHMENT C - RADIATED EMISSION BETWEEN (30MHZ TO
1000MHZ)**

Test Mode: TX 2425MHz

Vertical

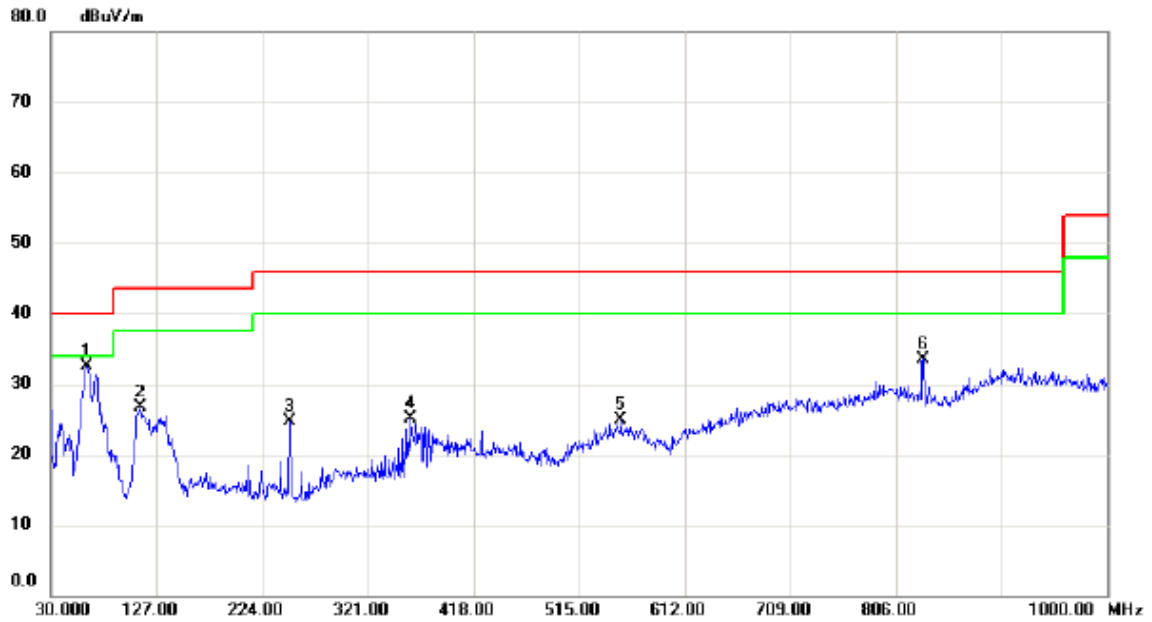

No.	Mk.	Freq. MHz	Reading Level dBuV	Correct Factor dB	Measure- ment dBuV/m	Limit dBuV/m	Margin dB	Detector	Comment
1	*	62.9800	46.99	-14.58	32.41	40.00	-7.59	peak	
2		112.4500	40.98	-14.36	26.62	43.50	-16.88	peak	
3		249.2200	38.91	-14.16	24.75	46.00	-21.25	peak	
4		360.7700	35.57	-10.49	25.08	46.00	-20.92	peak	
5		553.8000	29.69	-4.73	24.96	46.00	-21.04	peak	
6		831.2200	34.23	-0.69	33.54	46.00	-12.46	peak	

Test Mode: TX 2425MHz

Horizontal

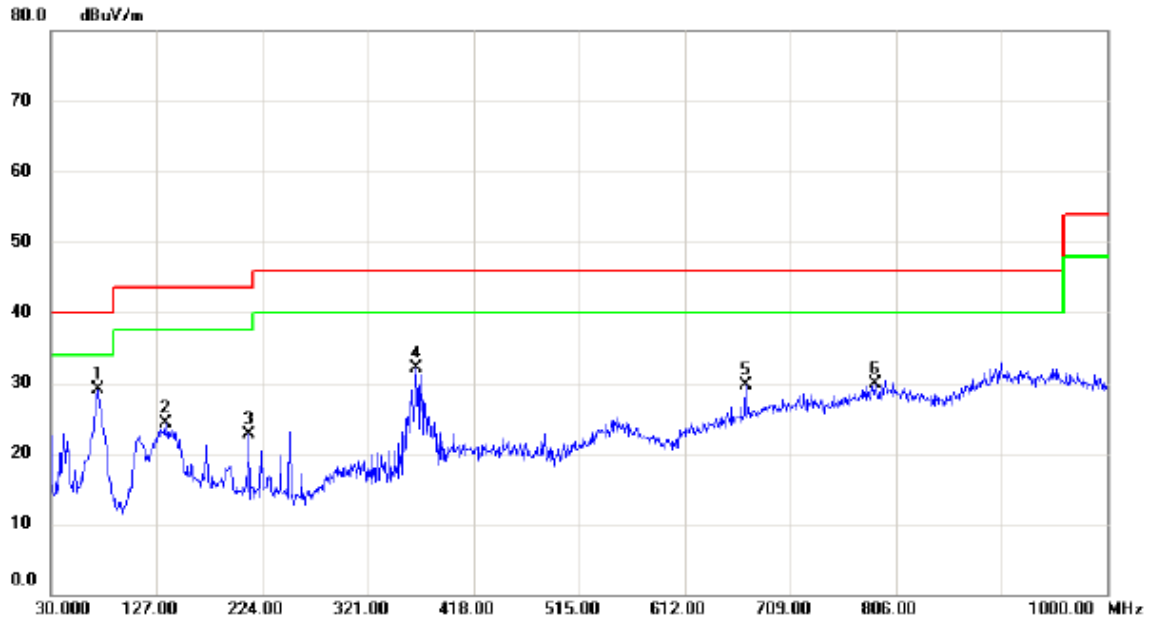

No.	Mk.	Freq. MHz	Reading Level dBuV	Correct Factor dB	Measure- ment dBuV/m	Limit dBuV/m	Margin dB	Detector	Comment
1	*	72.6800	45.57	-16.55	29.02	40.00	-10.98	peak	
2		134.7600	37.36	-13.01	24.35	43.50	-19.15	peak	
3		211.3900	37.28	-14.59	22.69	43.50	-20.81	peak	
4		365.6200	42.19	-10.15	32.04	46.00	-13.96	peak	
5		668.2600	33.15	-3.42	29.73	46.00	-16.27	peak	
6		786.6000	30.26	-0.34	29.92	46.00	-16.08	peak	

Test Mode: TX 2475MHz

Vertical

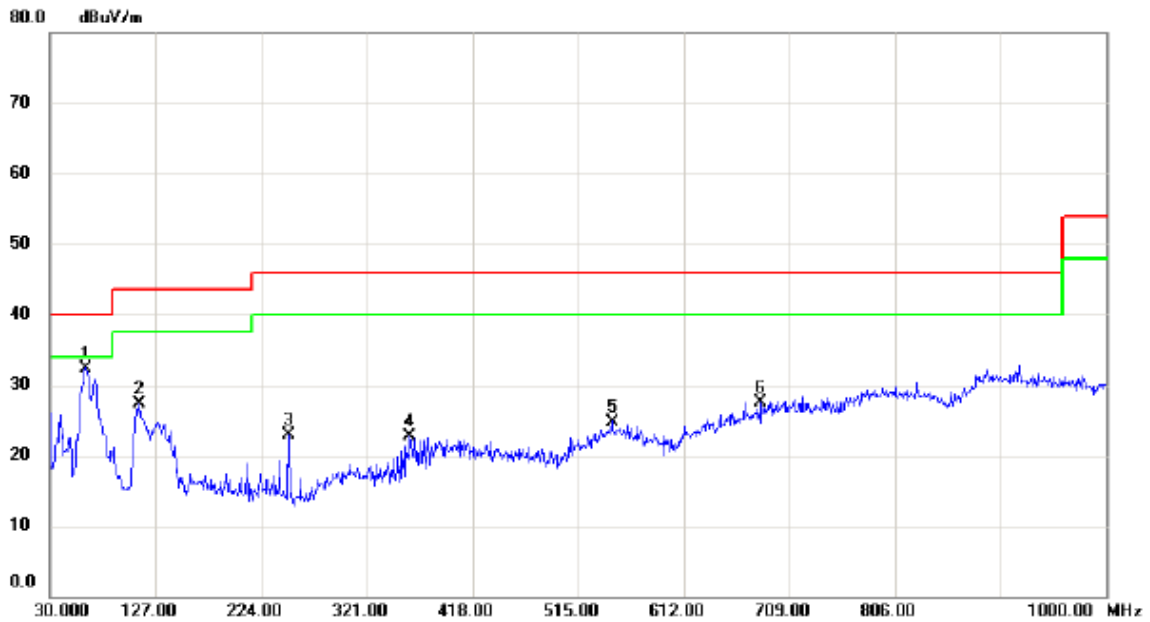

No.	Mk.	Freq. MHz	Reading Level dBuV	Correct Factor dB	Measure- ment dBuV/m	Limit dBuV/m	Margin dB	Detector	Comment
1	*	62.9800	46.98	-14.58	32.40	40.00	-7.60	peak	
2		112.4500	41.64	-14.36	27.28	43.50	-16.22	peak	
3		249.2200	36.97	-14.16	22.81	46.00	-23.19	peak	
4		360.7700	33.28	-10.49	22.79	46.00	-23.21	peak	
5		546.0400	29.76	-4.96	24.80	46.00	-21.20	peak	
6		682.8100	30.38	-2.81	27.57	46.00	-18.43	peak	

Test Mode: TX 2475MHz

Horizontal

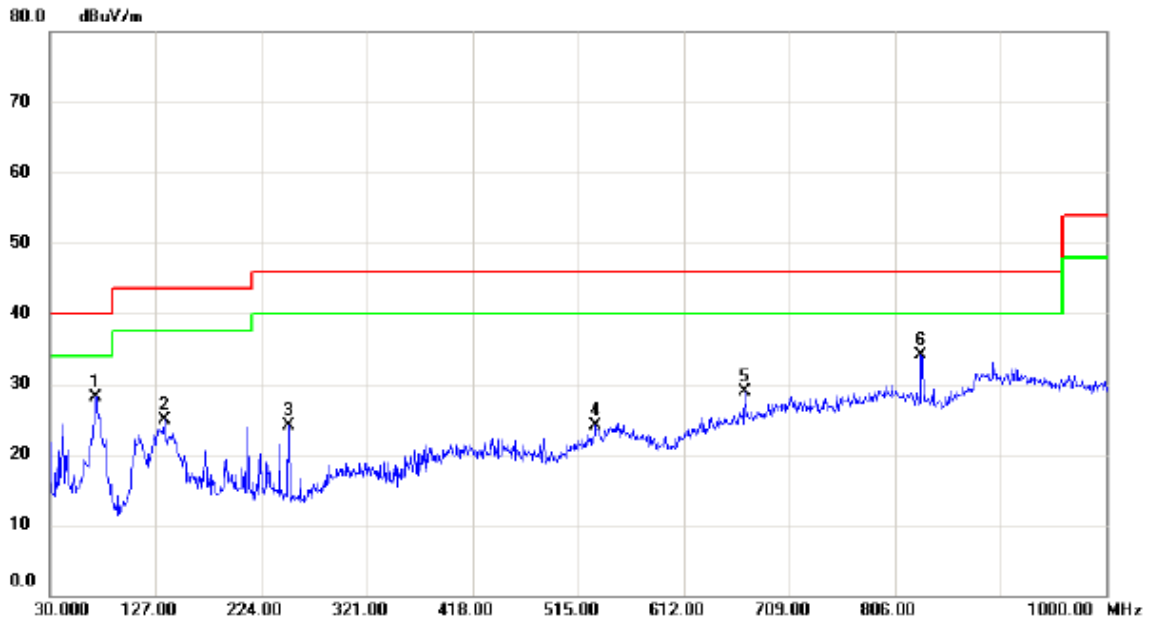

No.	Mk.	Freq. MHz	Reading Level dBuV	Correct Factor dB	Measure- ment dBuV/m	Limit dBuV/m	Margin dB	Detector	Comment
1	*	71.7100	44.68	-16.54	28.14	40.00	-11.86	peak	
2		134.7600	37.91	-13.01	24.90	43.50	-18.60	peak	
3		249.2200	38.33	-14.16	24.17	46.00	-21.83	peak	
4		531.4900	30.51	-6.46	24.05	46.00	-21.95	peak	
5		668.2600	32.36	-3.42	28.94	46.00	-17.06	peak	
6		830.2500	34.67	-0.66	34.01	46.00	-11.99	peak	

ATTACHMENT D - RADIATED EMISSION (ABOVE 1000MHZ)

Orthogonal Axis :	X
Test Mode :	TX 2425MHz

Vertical

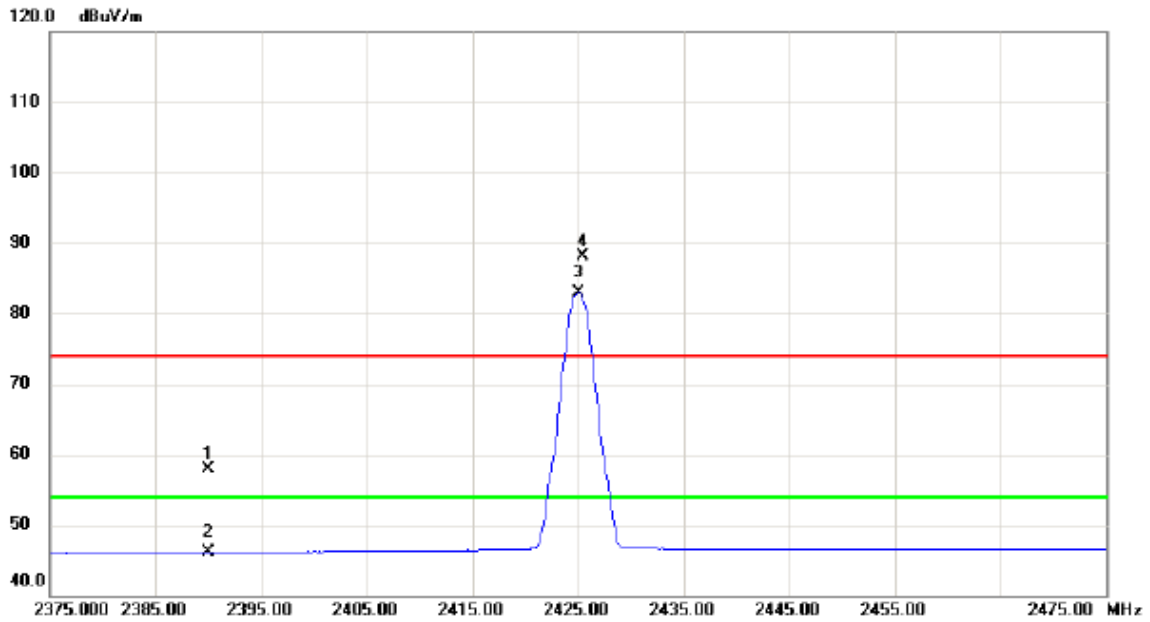

No.	Mk.	Freq.	Reading Level	Correct Factor	Measurement	Limit	Margin	Detector	Comment
		MHz	dBuV	dB	dBuV/m	dBuV/m	dB		
1		2390.000	24.88	33.01	57.89	74.00	-16.11	peak	
2		2390.000	13.08	33.01	46.09	54.00	-7.91	AVG	
3	*	2425.100	49.78	33.16	82.94	54.00	28.94	AVG	No Limit
4	X	2425.500	54.97	33.16	88.13	74.00	14.13	peak	No Limit

Orthogonal Axis :	X
Test Mode :	TX 2425MHz

Vertical

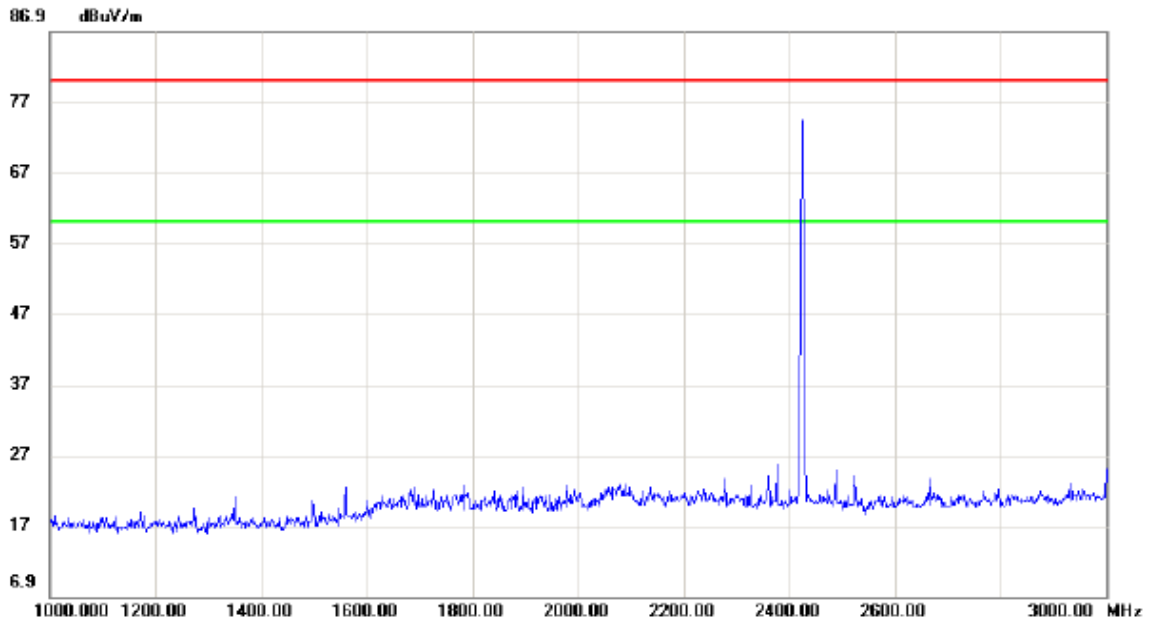

No.	Mk.	Freq.	Reading Level	Correct Factor	Measurement	Limit	Margin	Detector	Comment
		MHz	dBuV	dB	dBuV/m	dBuV/m	dB		

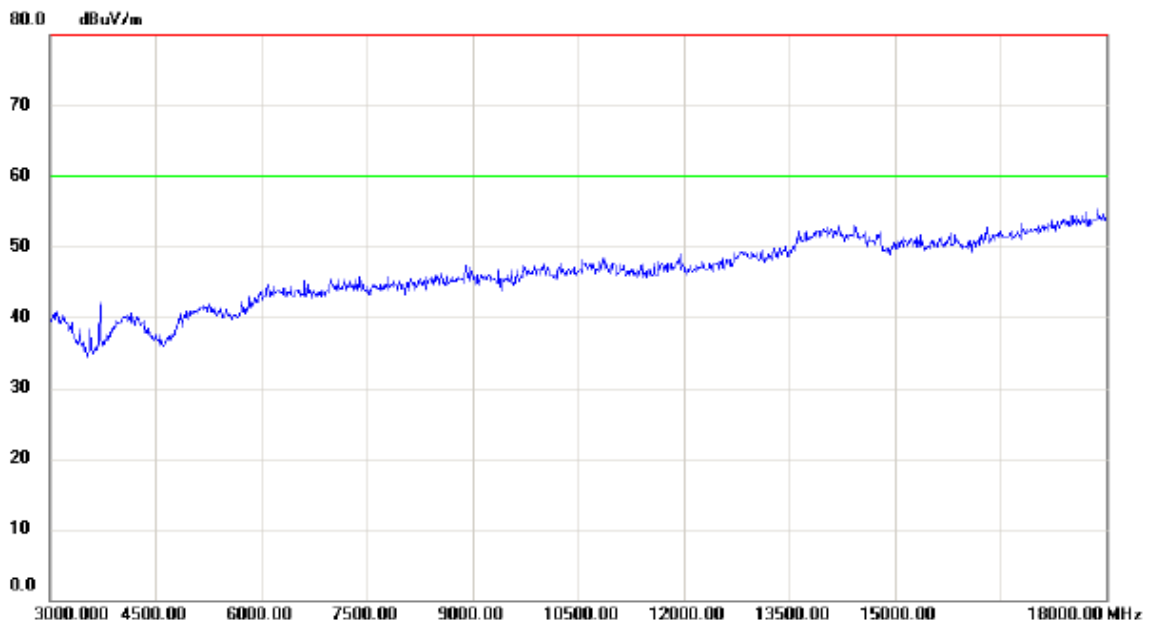

No.	Mk.	Freq.	Reading Level	Correct Factor	Measurement	Limit	Margin	Detector	Comment
		MHz	dBuV	dB	dBuV/m	dBuV/m	dB		

Orthogonal Axis :	X
Test Mode :	TX 2425MHz

Vertical

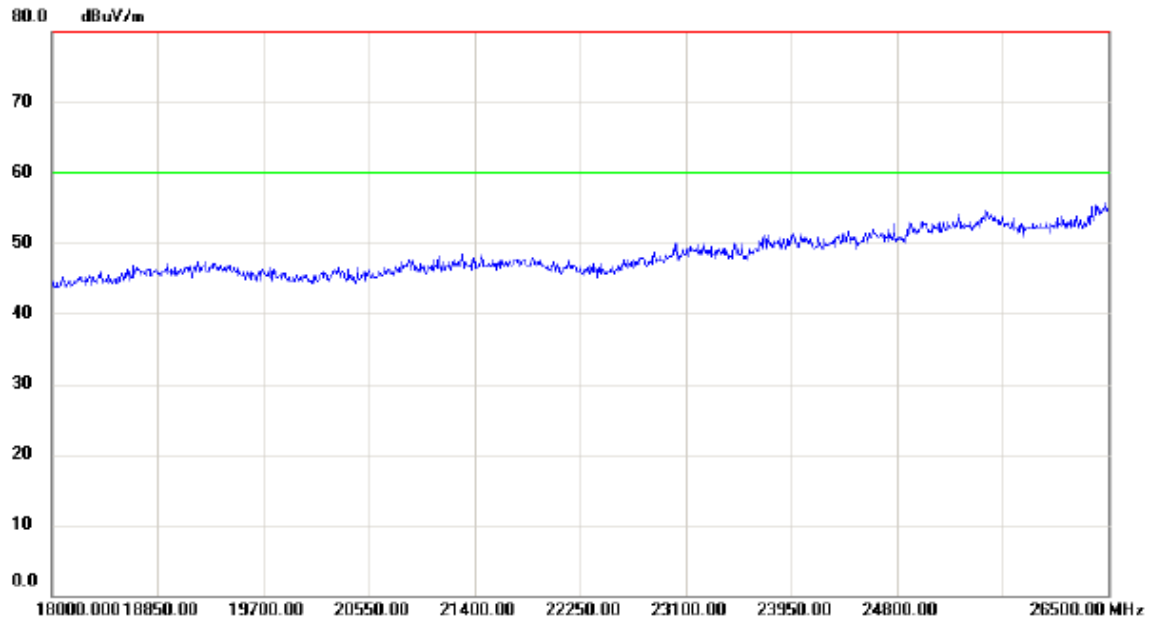

No.	Mk.	Freq.	Reading Level	Correct Factor	Measurement	Limit	Margin	Detector	Comment
		MHz	dBuV	dB	dBuV/m	dBuV/m	dB		

Orthogonal Axis :	X
Test Mode :	TX 2425MHz

Horizontal

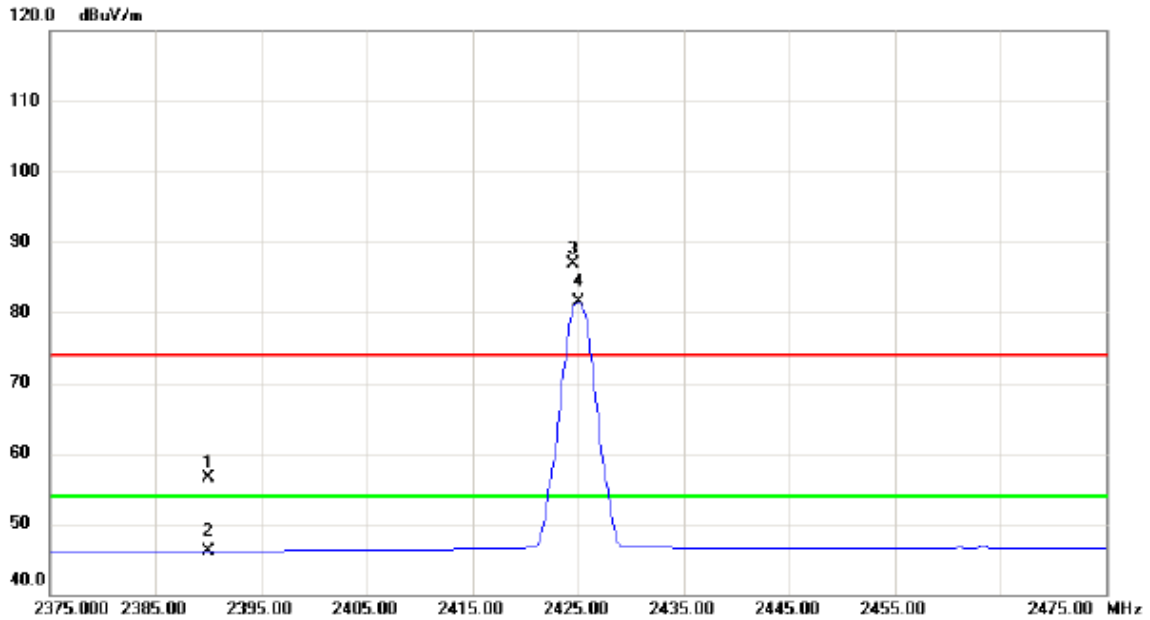

No.	Mk.	Freq. MHz	Reading Level dBuV	Correct Factor dB	Measure- ment dBuV/m	Limit dBuV/m	Margin dB	Detector	Comment
1		2390.000	23.58	33.01	56.59	74.00	-17.41	peak	
2		2390.000	13.11	33.01	46.12	54.00	-7.88	AVG	
3	X	2424.600	53.67	33.16	86.83	74.00	12.83	peak	No Limit
4	*	2425.000	48.38	33.16	81.54	54.00	27.54	AVG	No Limit

Orthogonal Axis :	X
Test Mode :	TX 2425MHz

Horizontal

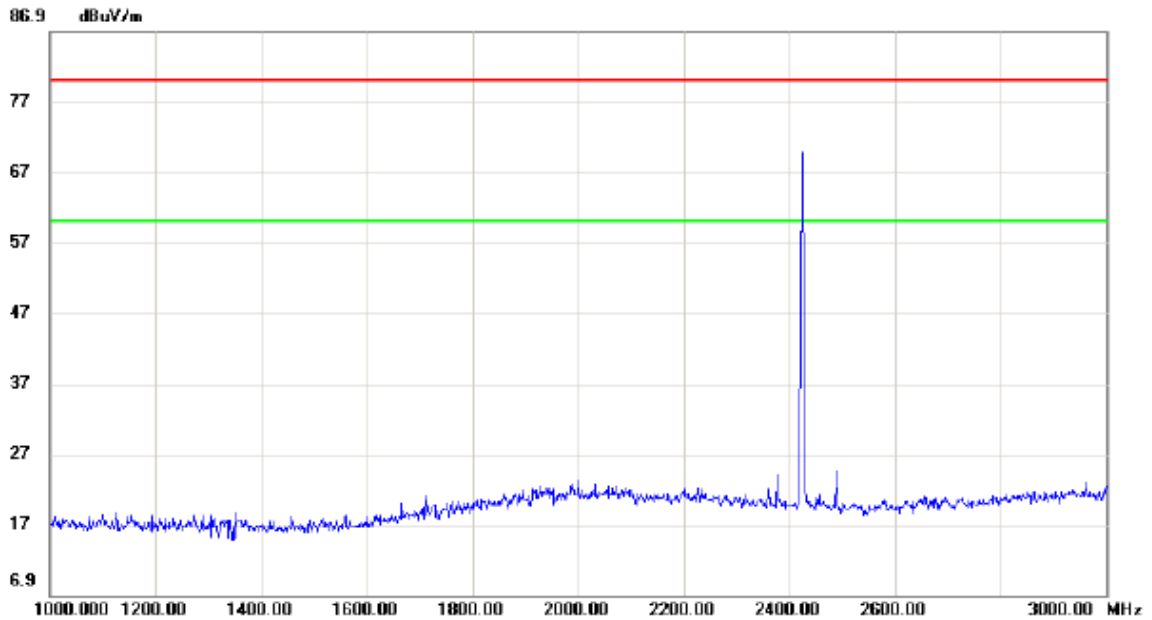

No.	Mk.	Freq.	Reading Level	Correct Factor	Measurement	Limit	Margin	Detector	Comment
		MHz	dBuV	dB	dBuV/m	dBuV/m	dB		

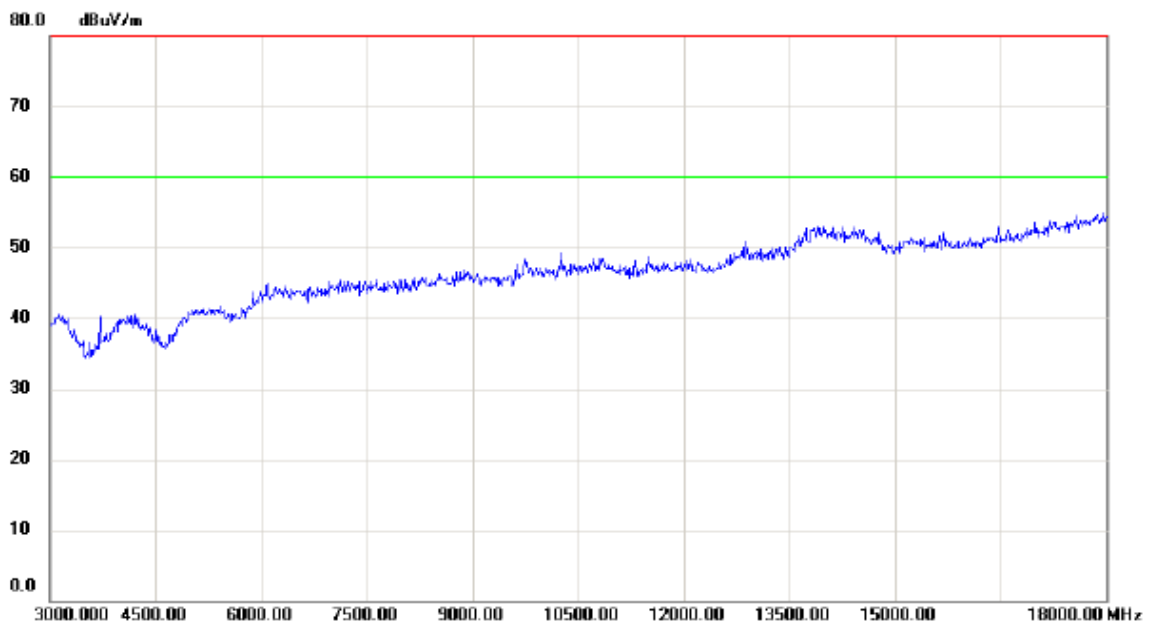

No.	Mk.	Freq.	Reading Level	Correct Factor	Measurement	Limit	Margin	Detector	Comment
		MHz	dBuV	dB	dBuV/m	dBuV/m	dB		

Orthogonal Axis :	X
Test Mode :	TX 2425MHz

Horizontal

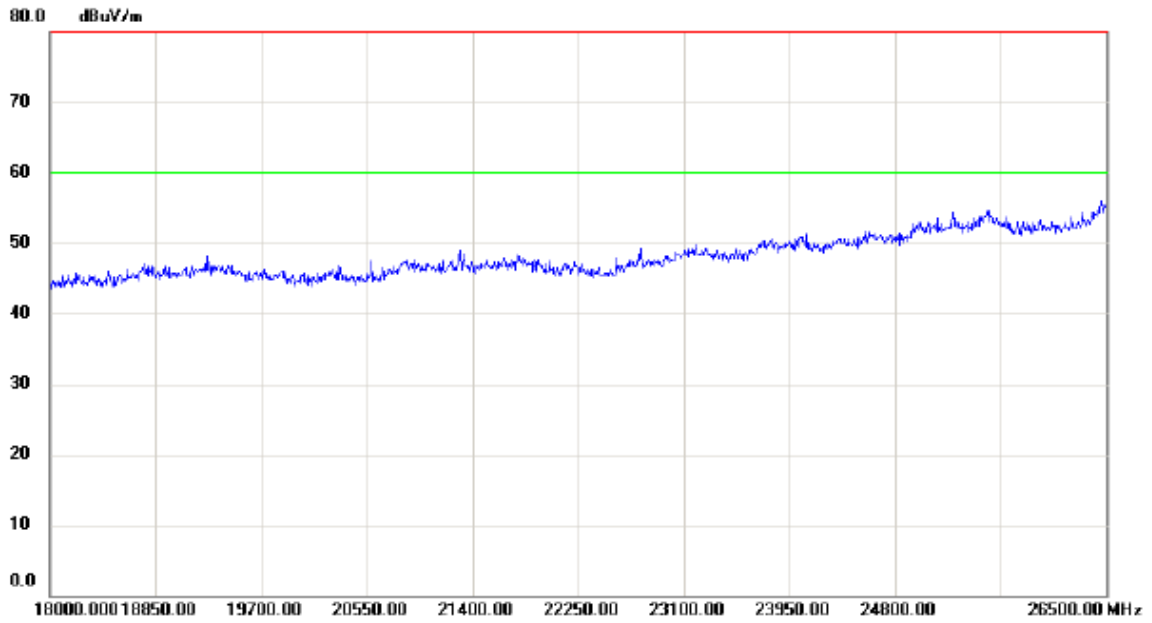

No.	Mk.	Freq.	Reading Level	Correct Factor	Measurement	Limit	Margin	Detector	Comment
		MHz	dBuV	dB	dBuV/m	dBuV/m	dB		

Orthogonal Axis :	X
Test Mode :	TX 2475MHz

Vertical

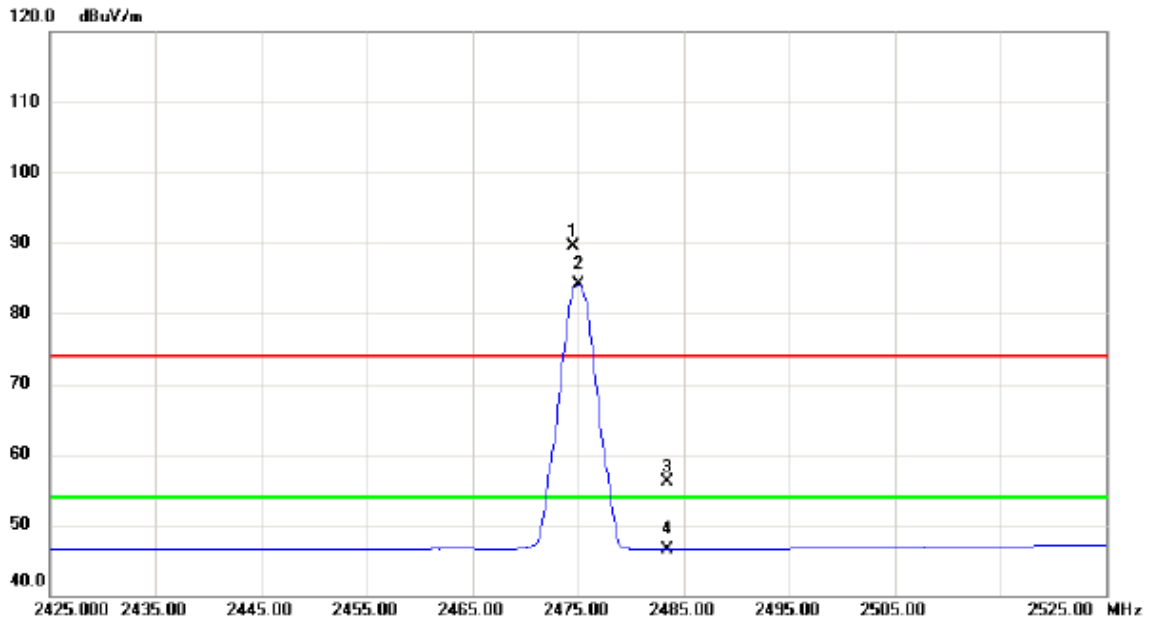

No.	Mk.	Freq.	Reading Level	Correct Factor	Measurement	Limit	Margin	Detector	Comment
		MHz	dBuV	dB	dBuV/m	dBuV/m	dB		
1	X	2474.500	56.06	33.37	89.43	74.00	15.43	peak	No Limit
2	*	2475.000	50.82	33.37	84.19	54.00	30.19	AVG	No Limit
3		2483.500	22.79	33.40	56.19	74.00	-17.81	peak	
4		2483.500	13.13	33.40	46.53	54.00	-7.47	AVG	

Orthogonal Axis :	X
Test Mode :	TX 2475MHz

Vertical

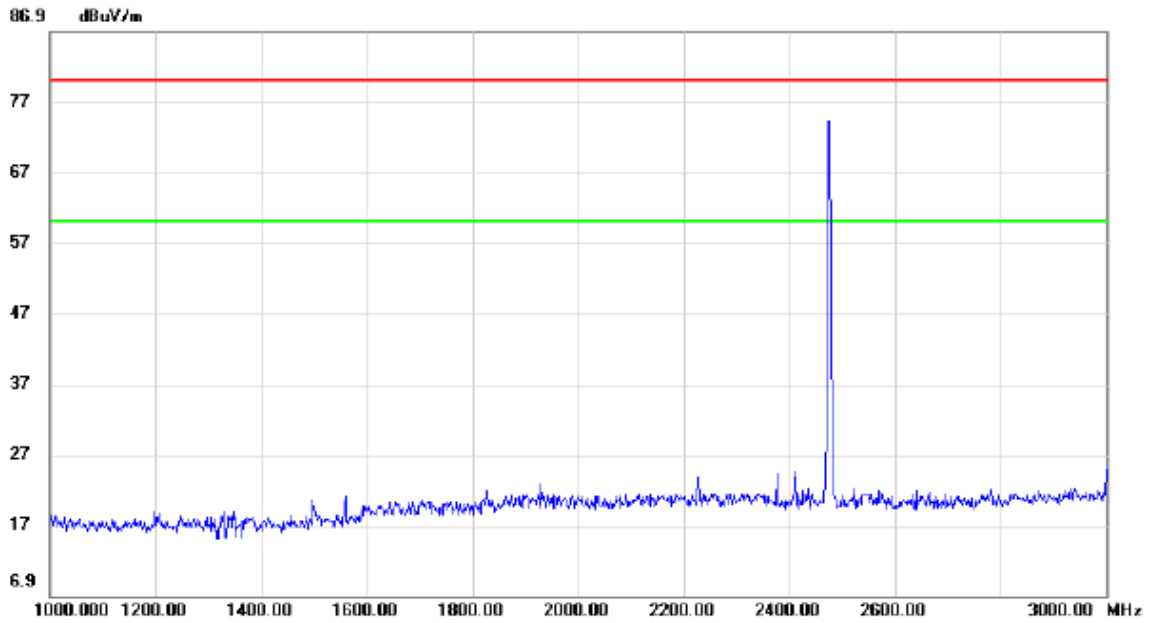

No.	Mk.	Freq.	Reading Level	Correct Factor	Measurement	Limit	Margin	Detector	Comment
		MHz	dBuV	dB	dBuV/m	dBuV/m	dB		

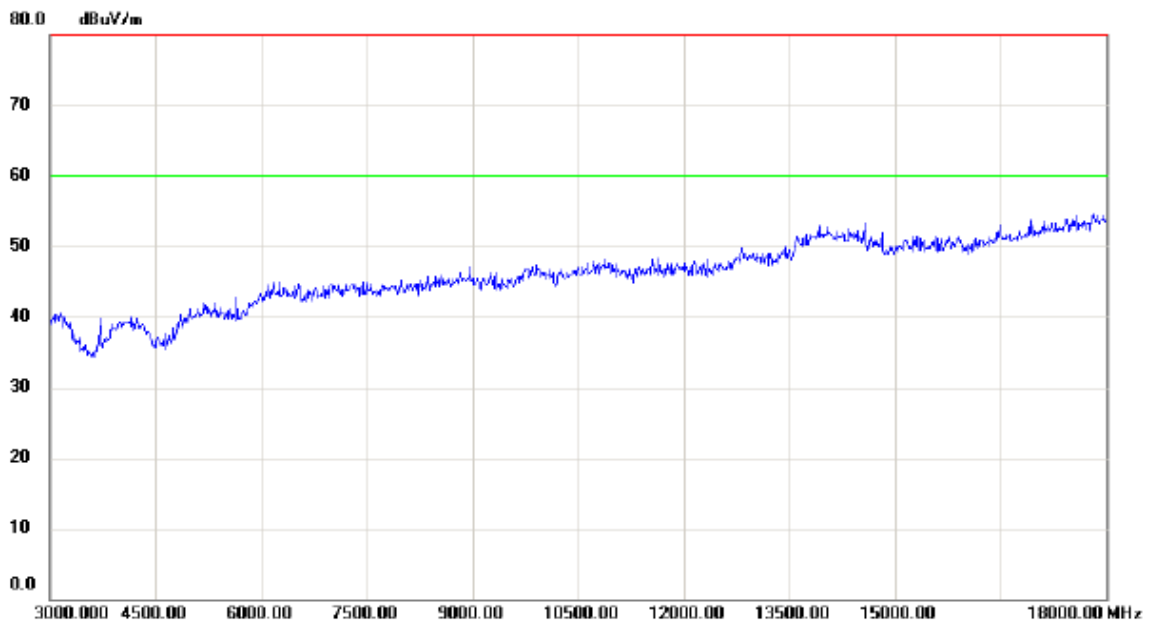

No.	Mk.	Freq.	Reading Level	Correct Factor	Measurement	Limit	Margin	Detector	Comment
		MHz	dBuV	dB	dBuV/m	dBuV/m	dB		

Orthogonal Axis :	X
Test Mode :	TX 2475MHz

Vertical

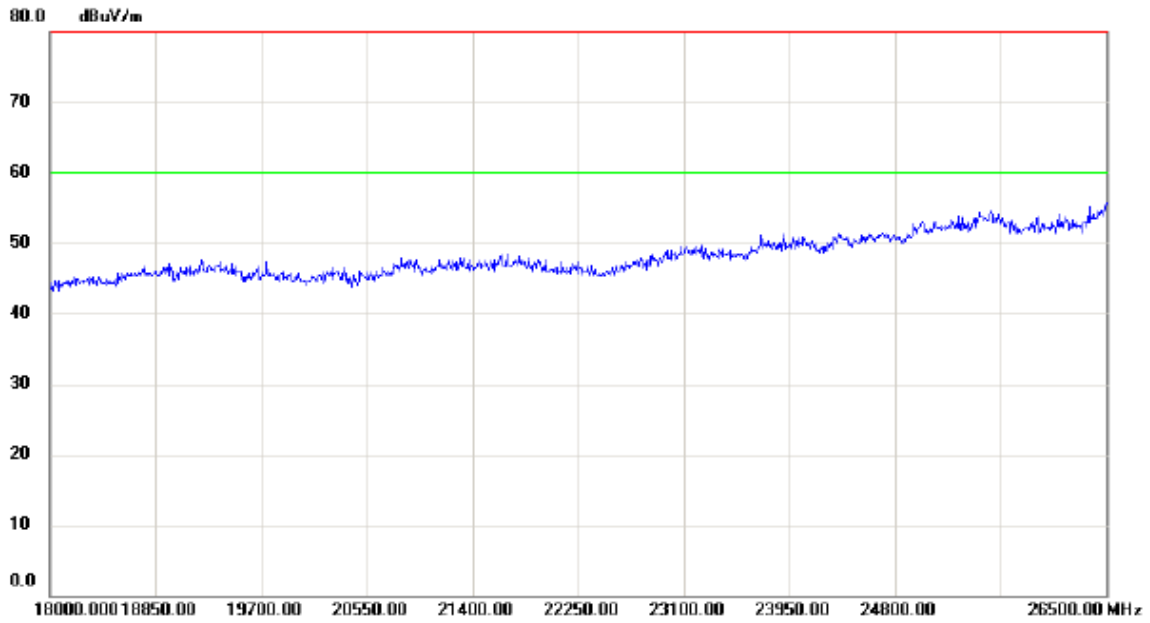

No.	Mk.	Freq.	Reading Level	Correct Factor	Measurement	Limit	Margin	Detector	Comment
		MHz	dBuV	dB	dBuV/m	dBuV/m	dB		

Orthogonal Axis :	X
Test Mode :	TX 2475MHz

Horizontal

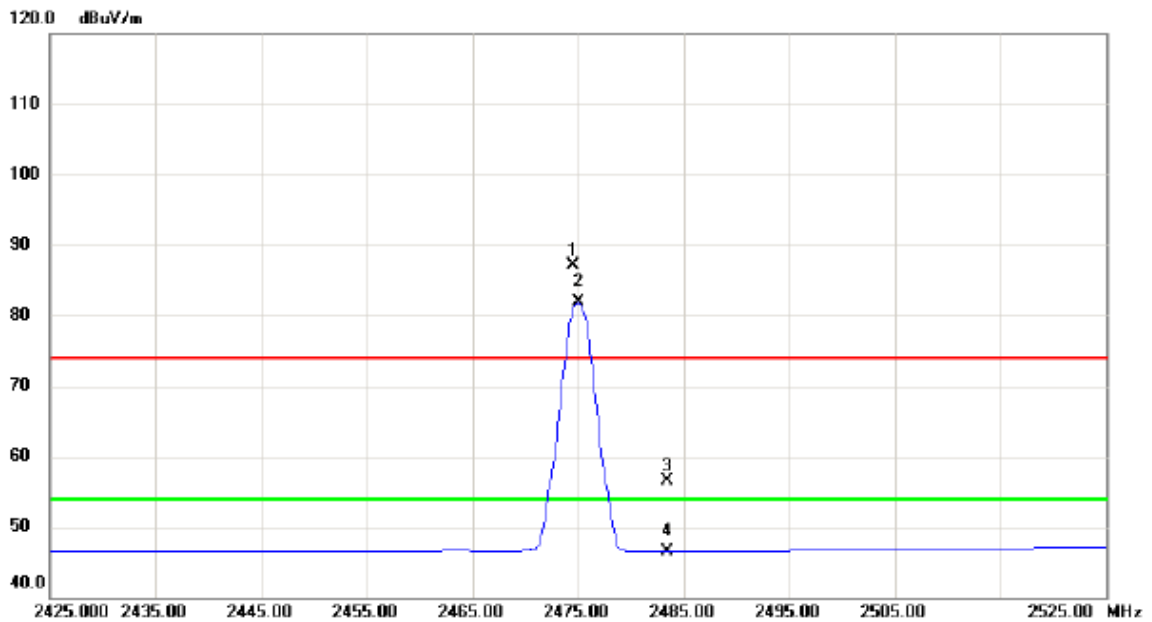

No.	Mk.	Freq. MHz	Reading Level dBuV	Correct Factor dB	Measure- ment dBuV/m	Limit dBuV/m	Margin dB	Detector	Comment
1	X	2474.500	53.73	33.37	87.10	74.00	13.10	peak	No Limit
2	*	2475.000	48.44	33.37	81.81	54.00	27.81	AVG	No Limit
3		2483.500	23.05	33.40	56.45	74.00	-17.55	peak	
4		2483.500	13.12	33.40	46.52	54.00	-7.48	AVG	

Orthogonal Axis :	X
Test Mode :	TX 2475MHz

Horizontal

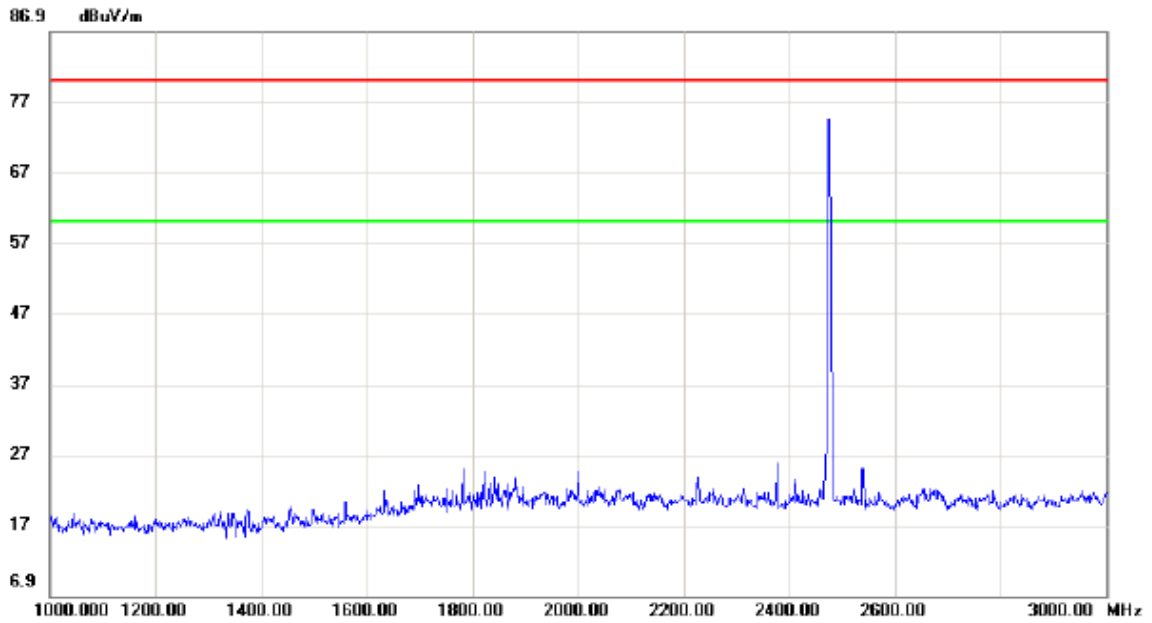

No. Mk.	Freq.	Reading Level	Correct Factor	Measurement	Limit	Margin	Detector	Comment
	MHz	dBuV	dB	dBuV/m	dBuV/m	dB		

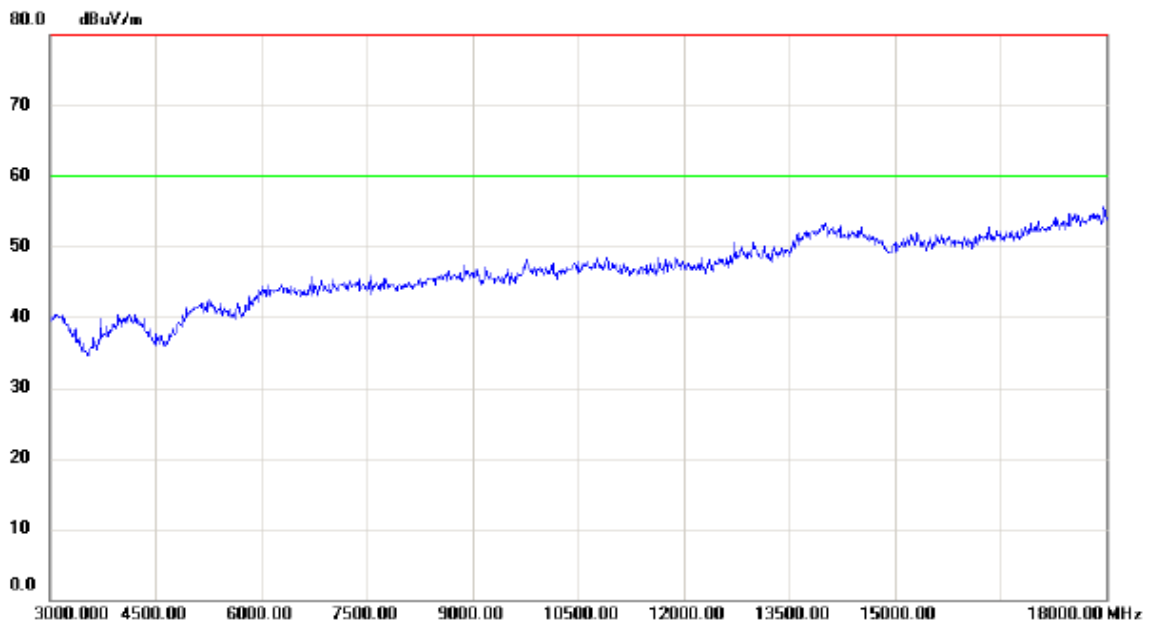

No. Mk.	Freq.	Reading Level	Correct Factor	Measurement	Limit	Margin	Detector	Comment
	MHz	dBuV	dB	dBuV/m	dBuV/m	dB		

Orthogonal Axis :	X
Test Mode :	TX 2475MHz

Horizontal

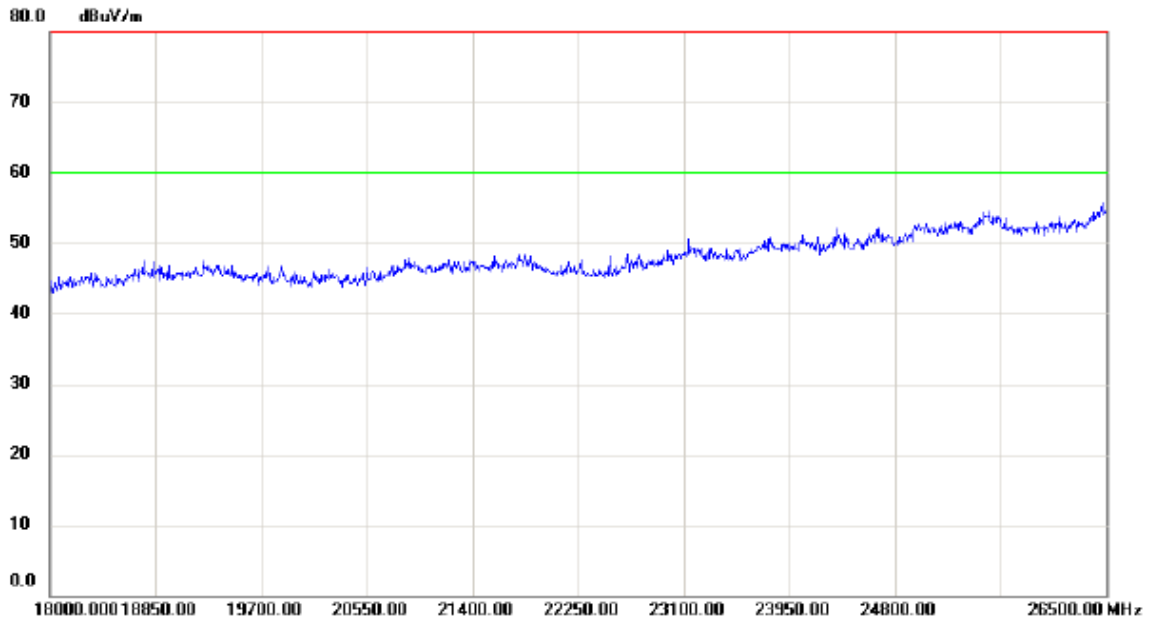

No.	Mk.	Freq.	Reading Level	Correct Factor	Measurement	Limit	Margin	Detector	Comment
		MHz	dBuV	dB	dBuV/m	dBuV/m	dB		

ATTACHMENT E - BANDWIDTH

Frequency (MHz)	6dB Bandwidth (MHz)	99% Occupied BW (MHz)	Min. Limit (kHz)	Test Result
2425	1.580	2.580	500	Complies
2450	1.610	2.580	500	Complies
2475	1.600	2.570	500	Complies

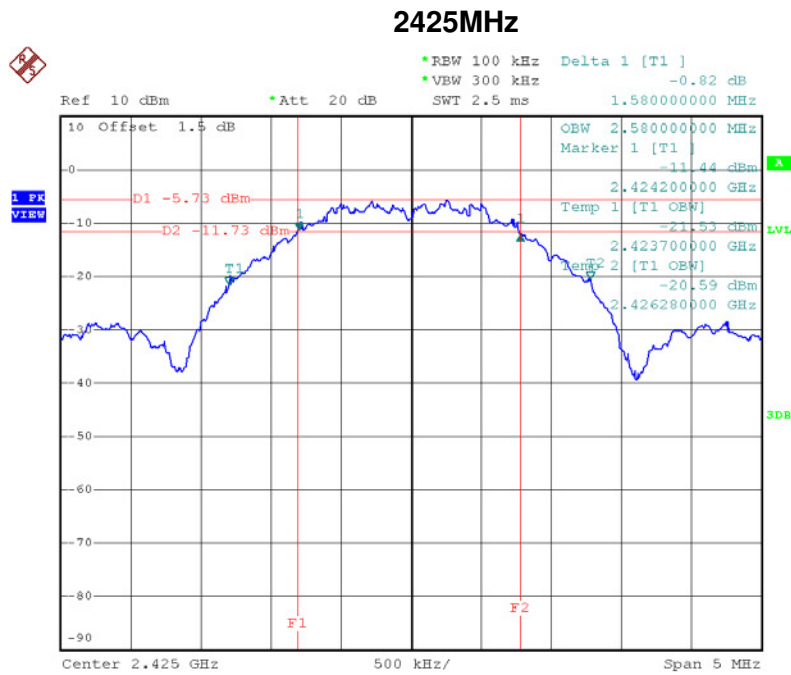

Date: 15.AUG.2016 15:02:37

2450MHz

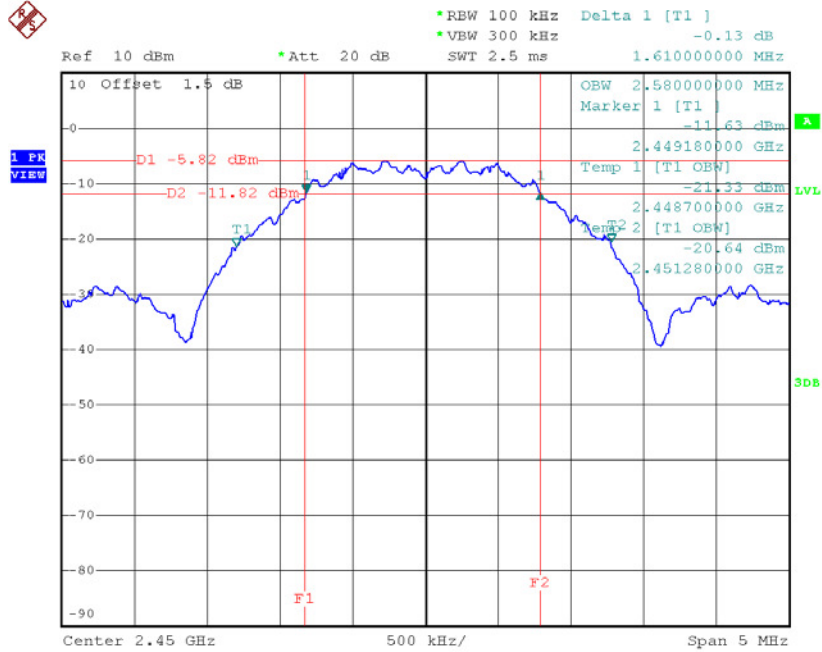

Date: 15.AUG.2016 15:00:25

2475MHz

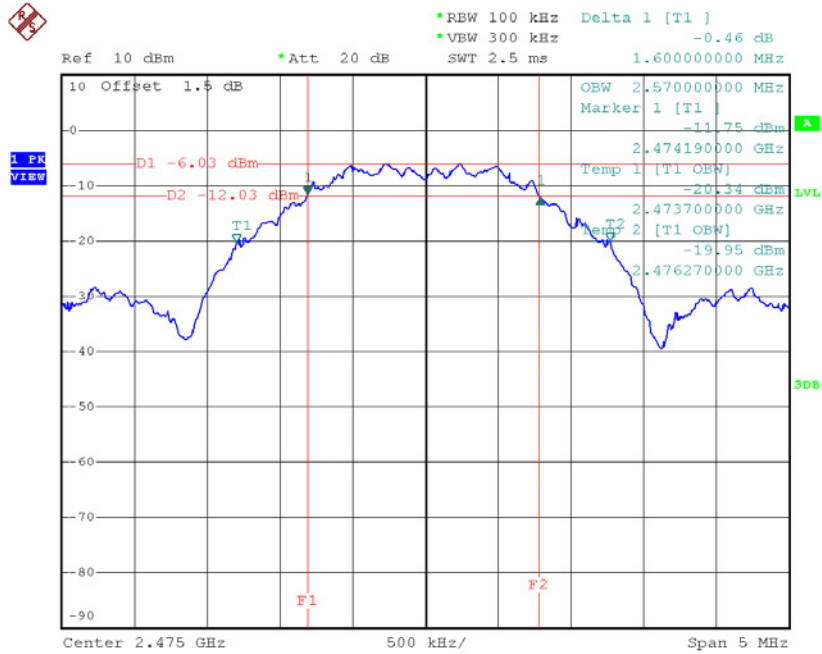

Date: 15.AUG.2016 15:04:22

ATTACHMENT F - MAXIMUM OUTPUT POWER TEST

Test Mode :	TX Mode
-------------	---------

Frequency (MHz)	Conducted Power (dBm)	Conducted Power (Watt)	Max. Limit (dBm)	Max. Limit (Watt)	Test Result
2425	-2.24	0.0006	30.00	1.00	Complies
2450	-2.31	0.0006	30.00	1.00	Complies
2475	-2.39	0.0006	30.00	1.00	Complies

ATTACHMENT G - ANTENNA CONDUCTED SPURIOUS EMISSION

Test Mode : TX Mode

2425MHz (Lower)

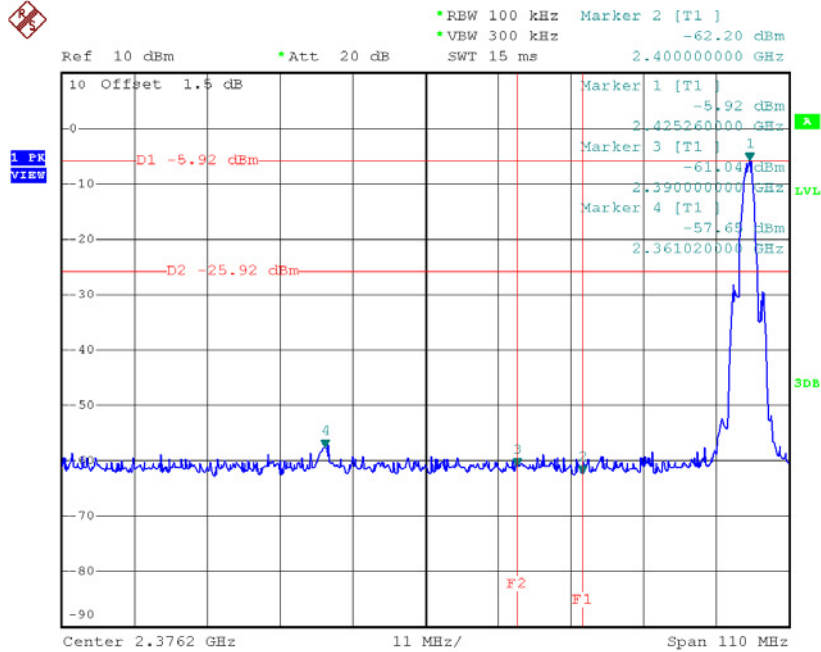

Date: 15.AUG.2016 15:13:53

2475MHz (upper)

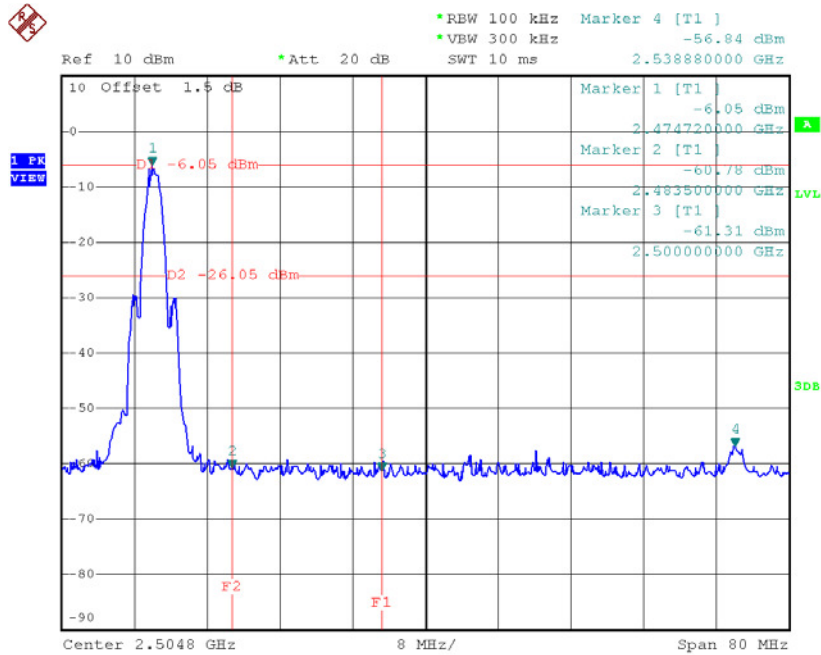

Date: 15.AUG.2016 15:21:50

2425MHz (10 Harmonic of the frequency)

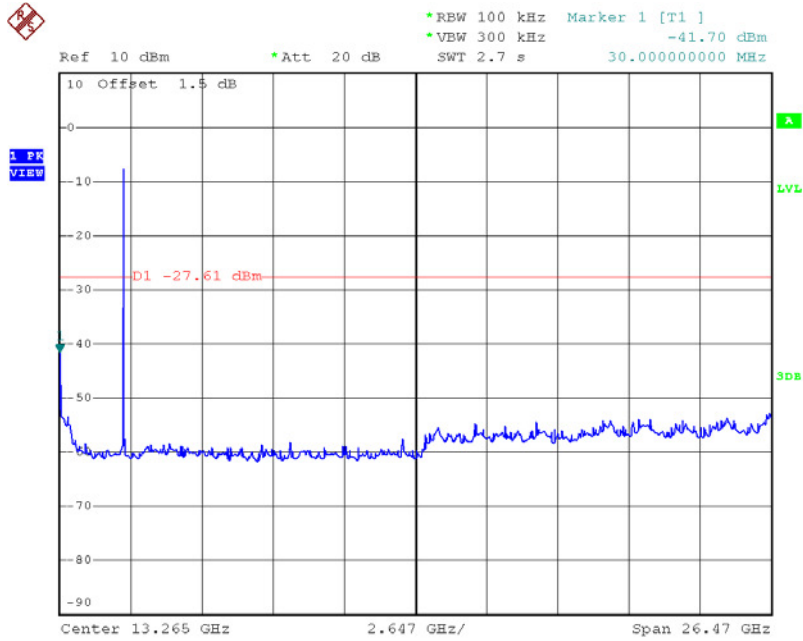

Date: 15.AUG.2016 15:08:47

2450MHz (10 Harmonic of the frequency)

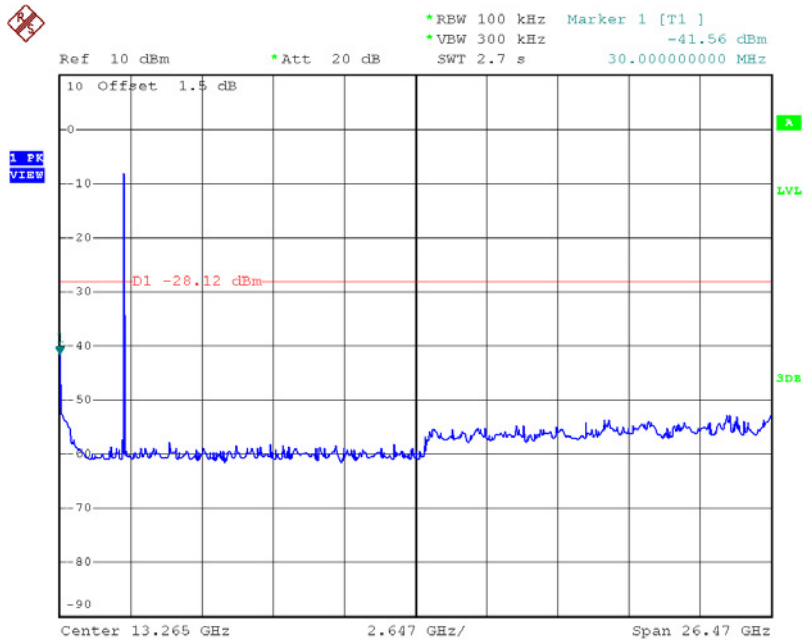

Date: 15.AUG.2016 15:07:55

2475MHz (10 Harmonic of the frequency)

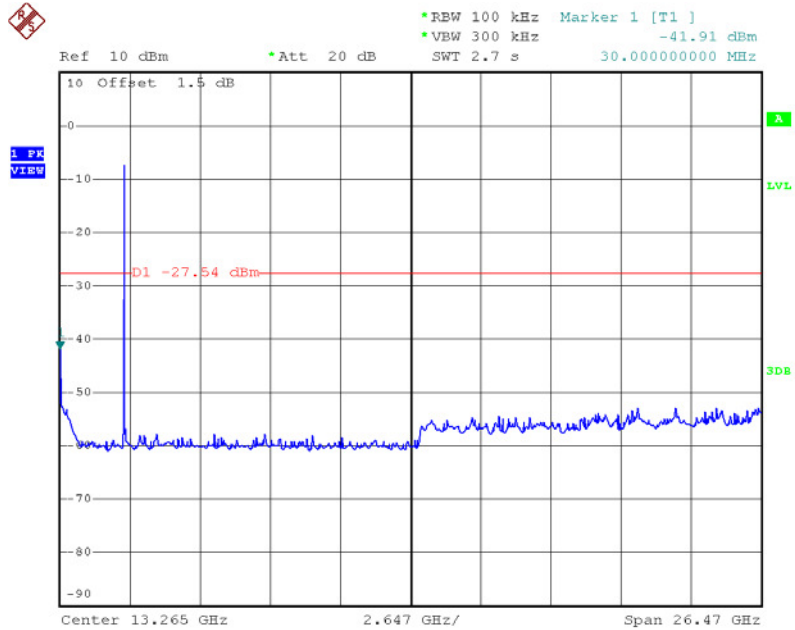

Date: 15.AUG.2016 15:06:55

ATTACHMENT H - POWER SPECTRAL DENSITY TEST

Test Mode : TX Mode

Frequency (MHz)	Power Density (dBm)	Max. Limit (dBm)	Result
2425	-17.88	8	Complies
2450	-18.19	8	Complies
2475	-18.95	8	Complies

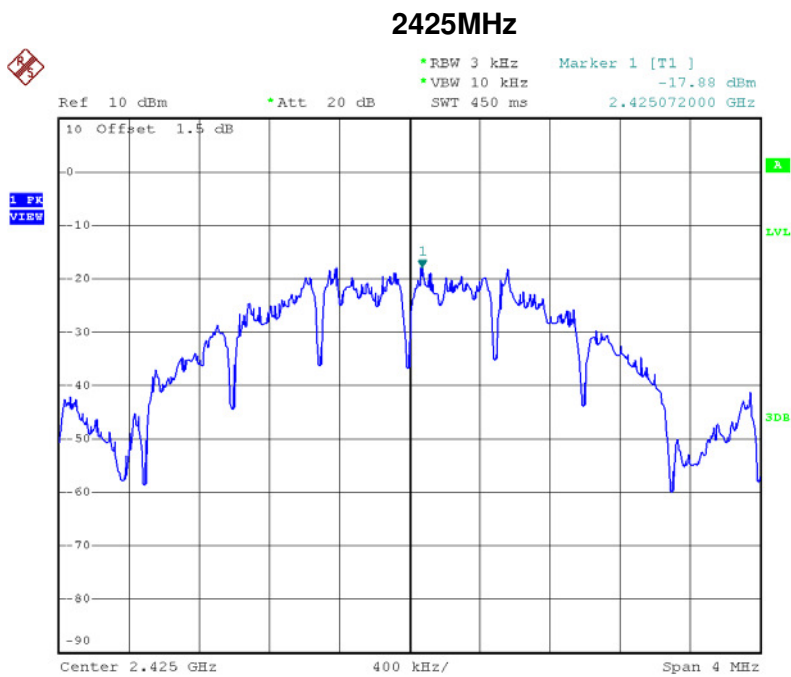

Date: 15.AUG.2016 15:15:32

2450MHz

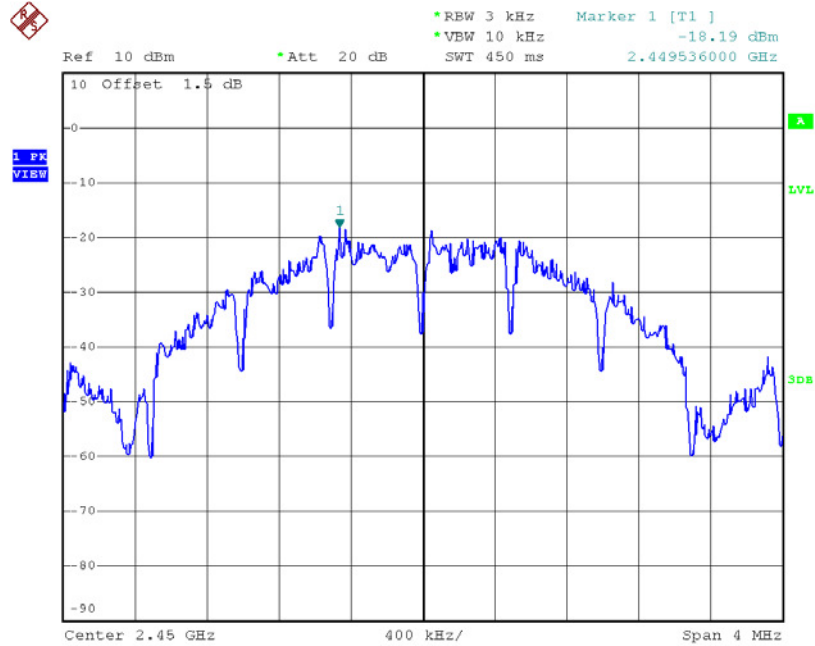

Date: 15.AUG.2016 15:16:13

TX 2475MHz

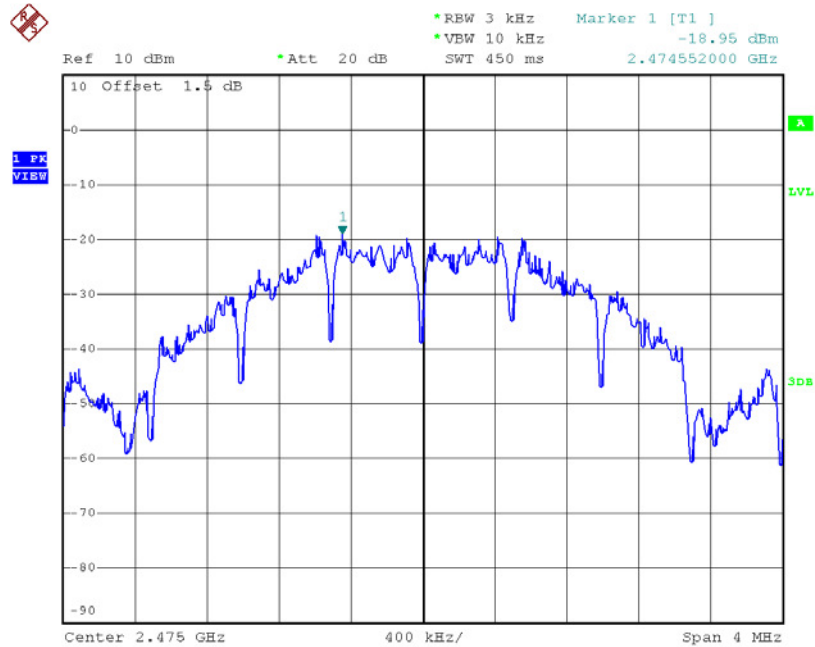

Date: 15.AUG.2016 15:17:06