



**CFR 47 FCC PART 15 SUBPART C  
ISED RSS-247 ISSUE 2**

**TEST REPORT**

*For*

**Huawei STB / Huawei BOX**

**MODEL NUMBER: Q21E**

**FCC ID: QIS-Q21E**

**IC: 6369A-Q21E**

**REPORT NUMBER: 4788692075.1-1**

**ISSUE DATE: October 22, 2018**

*Prepared for*

**Huawei Technologies Co., Ltd.  
Administration Building, Huawei Technologies Co., Ltd. Bantian, Longgang  
District, Shenzhen, P.R. China, 518129**

*Prepared by*

**UL Verification Services (Guangzhou) Co., Ltd, Song Shan Lake Branch  
Building 10, Innovation Technology Park, No. 1, Li Bin Road, Song Shan Lake  
Hi-Tech Development Zone Dongguan, People's Republic of China  
Tel: +86 769 22038881  
Fax: +86 769 33244054  
Website: [www.ul.com](http://www.ul.com)**

The results reported herein have been performed in accordance with the laboratory's terms of accreditation. This report shall not be reproduced except in full without the written approval of the Laboratory. The results in this report apply to the test sample(s) mentioned above at the time of the testing period only and are not to be used to indicate applicability to other similar products. This report does not imply that the product(s) has met the criteria for certification.



Revision History

<u>Rev.</u>	<u>Issue Date</u>	<u>Revisions</u>	<u>Revised By</u>
V0	10/22/2018	Initial Issue	



Summary of Test Results			
Clause	Test Items	FCC/IC Rules	Test Results
1	6dB Bandwidth and 99% Occupied Bandwidth	FCC Part 15.247 (a) (2) RSS-247 Clause 5.2 (a) ISED RSS-Gen Clause 6.7	Pass
2	Peak Conducted Output Power	FCC Part 15.247 (b) (3) RSS-247 Clause 5.4 (e)	Pass
3	Power Spectral Density	FCC Part 15.247 (e) RSS-247 Clause 5.2 (b)	Pass
4	Conducted Bandedge and Spurious Emission	FCC Part 15.247 (d) RSS-247 Clause 5.5	Pass
5	Radiated Bandedge and Spurious Emission	FCC Part 15.247 (d) FCC Part 15.209 FCC Part 15.205 RSS-247 Clause 5.5 RSS-GEN Clause 8.9	Pass
6	Conducted Emission Test For AC Power Port	FCC Part 15.207 RSS-GEN Clause 8.8	Pass
7	Antenna Requirement	FCC Part 15.203 RSS-GEN Clause 8.3	Pass



## TABLE OF CONTENTS

<b>1. ATTESTATION OF TEST RESULTS .....</b>	<b>6</b>
<b>2. TEST METHODOLOGY .....</b>	<b>7</b>
<b>3. FACILITIES AND ACCREDITATION .....</b>	<b>7</b>
<b>4. CALIBRATION AND UNCERTAINTY .....</b>	<b>8</b>
4.1. MEASURING INSTRUMENT CALIBRATION .....	8
4.2. MEASUREMENT UNCERTAINTY.....	8
<b>5. EQUIPMENT UNDER TEST .....</b>	<b>9</b>
5.1. DESCRIPTION OF EUT .....	9
5.2. MAXIMUM OUTPUT POWER.....	9
5.3. CHANNEL LIST .....	10
5.4. TEST CHANNEL CONFIGURATION.....	10
5.5. THE WORSE CASE CONFIGURATIONS .....	10
5.6. DESCRIPTION OF AVAILABLE ANTENNAS .....	11
5.7. DESCRIPTION OF TEST SETUP.....	12
<b>6. MEASURING INSTRUMENT AND SOFTWARE USED .....</b>	<b>13</b>
<b>7. MEASUREMENT METHODS .....</b>	<b>14</b>
<b>8. ANTENNA PORT TEST RESULTS .....</b>	<b>15</b>
8.1. ON TIME AND DUTY CYCLE.....	15
8.2. 6 dB DTS BANDWIDTH AND 99% OCCUPIED BANDWIDTH .....	18
8.2.1. 802.11b MODE .....	19
8.2.2. 802.11g MODE .....	23
8.2.3. 802.11n HT20 MODE .....	27
8.2.4. 802.11n HT40 MODE .....	31
8.3. PEAK CONDUCTED OUTPUT POWER.....	35
8.3.1. 802.11b MODE .....	36
8.3.2. 802.11g MODE .....	36
8.3.3. 802.11n HT20 MODE .....	36
8.3.4. 802.11 n HT40 MODE .....	36
8.4. POWER SPECTRAL DENSITY .....	37
8.4.1. 802.11b MODE .....	38
8.4.2. 802.11g MODE .....	40
8.4.3. 802.11n HT20 MODE .....	42
8.4.4. 802.11n HT40 MODE .....	44
8.5. CONDUCTED BANDEDGE AND SPURIOUS EMISSIONS.....	46
8.5.1. 802.11b MODE .....	47



8.5.2.	802.11g MODE .....	51
8.5.3.	802.11n HT20 MODE .....	54
8.5.4.	802.11n HT40 MODE .....	57
<b>9.</b>	<b>RADIATED TEST RESULTS.....</b>	<b>60</b>
9.1.	<i>RESTRICTED BANDEDGE</i> .....	66
9.1.1.	802.11b MODE .....	66
9.1.2.	802.11g MODE .....	70
9.1.3.	802.11n HT20 MODE .....	78
9.1.4.	802.11n HT40 MODE .....	86
9.2.	<i>SPURIOUS EMISSIONS (1~3GHz)</i> .....	93
9.2.1.	802.11b MODE .....	93
9.2.2.	802.11g MODE .....	99
9.2.3.	802.11n HT20 MODE .....	105
9.2.4.	802.11n HT40 MODE .....	111
9.3.	<i>SPURIOUS EMISSIONS (3~18GHz)</i> .....	117
9.3.1.	802.11b MODE .....	117
9.3.2.	802.11g MODE .....	123
9.3.3.	802.11n HT20 MODE .....	129
9.3.4.	802.11n HT40 MODE .....	135
9.4.	<i>SPURIOUS EMISSIONS (18~26GHz)</i> .....	141
9.4.1.	802.11b MODE .....	141
9.5.	<i>SPURIOUS EMISSIONS (0.03 ~ 1 GHz)</i> .....	143
9.5.1.	802.11b MODE .....	143
9.6.	<i>SPURIOUS EMISSIONS BELOW 30M</i> .....	145
9.6.1.	802.11b MODE .....	145
<b>10.</b>	<b>AC POWER LINE CONDUCTED EMISSIONS .....</b>	<b>149</b>
10.1.	802.11b MODE.....	150
<b>11.</b>	<b>ANTENNA REQUIREMENTS .....</b>	<b>152</b>



# 1. ATTESTATION OF TEST RESULTS

## Applicant Information

Company Name: HUAWEI TECHNOLOGIES CO., LTD.  
Address: Administration Building, Huawei Technologies Co., Ltd. Bantian, Longgang District, Shenzhen, P.R. China, 518129

## Manufacturer Information

Company Name: HUAWEI TECHNOLOGIES CO., LTD.  
Address: Administration Building, Huawei Technologies Co., Ltd. Bantian, Longgang District, Shenzhen, P.R. China, 518129

## EUT Description

EUT Name: Huawei STB / Huawei BOX  
Model: Q21E  
Brand Name: HUAWEI  
Sample Status: Normal  
Sample Received Date: September 28, 2018  
Date of Tested: October 8, 2018 ~ October 17, 2018

APPLICABLE STANDARDS	
STANDARD	TEST RESULTS
CFR 47 FCC PART 15 SUBPART C	PASS
ISED RSS-247 Issue 2	PASS
ISED RSS-GEN Issue 5	PASS

Prepared By:

Checked By:

Denny Huang  
Engineer Project Associate

Shawn Wen  
Laboratory Leader

Approved By:

Stephen Guo  
Laboratory Manager



## 2. TEST METHODOLOGY

The tests documented in this report were performed in accordance with 558074 D01 DTS Meas Guidance v05, 414788 D01 Radiated Test Site v01r01, CFR 47 FCC Part 2, CFR 47 FCC Part 15, ANSI C63.10-2013, ISED RSS-247 Issue 2 and ISED RSS-GEN Issue 5.

## 3. FACILITIES AND ACCREDITATION

Accreditation Certificate	<p><b>A2LA (Certificate No.: 4102.01)</b> UL Verification Services (Guangzhou) Co., Ltd. Song Shan Lake Branch. has been assessed and proved to be in compliance with A2LA.</p> <p><b>FCC (FCC Designation No.: CN1187)</b> UL Verification Services (Guangzhou) Co., Ltd. Song Shan Lake Branch. Has been recognized to perform compliance testing on equipment subject to the Commission's Declaration of Conformity (DoC) and Certification rules</p> <p><b>IC(Company No.: 21320)</b> UL Verification Services (Guangzhou) Co., Ltd. Song Shan Lake Branch. has been registered and fully described in a report filed with ISED. The Company Number is 21320.</p> <p><b>VCCI (Registration No.: G-20019, R-20004, C-20012 and T-20011)</b> UL Verification Services (Guangzhou) Co., Ltd. Song Shan Lake Branch. has been assessed and proved to be in compliance with VCCI, the Membership No. is 3793. Facility Name: Chamber D, the VCCI registration No. is G-20019 and R-20004 Shielding Room B , the VCCI registration No. is C-20012 and T-20011</p>
---------------------------	---

Note 1: All tests measurement facilities use to collect the measurement data are located at Building 10, Innovation Technology Park, Song Shan Lake Hi tech Development Zone, Dongguan, 523808, China

Note 2 : For below 30MHz, lab had performed measurements at test anechoic chamber and comparing to measurements obtained on an open field site. These measurements below 30MHz had been correlated to measurements performed on an OATS.



## 4. CALIBRATION AND UNCERTAINTY

### 4.1. MEASURING INSTRUMENT CALIBRATION

The measuring equipment utilized to perform the tests documented in this report has been calibrated in accordance with the manufacturer's recommendations, and is traceable to recognize national standards.

### 4.2. MEASUREMENT UNCERTAINTY

Where relevant, the following measurement uncertainty levels have been estimated for tests performed on the apparatus:

Test Item	Uncertainty
Conduction emission	3.62dB
Radiation Emission test(include Fundamental emission) (9KHz-30MHz)	2.2dB
Radiation Emission test(include Fundamental emission) (30MHz-1GHz)	4.00dB
Radiation Emission test (1GHz to 26GHz)( include Fundamental emission)	5.78dB (1GHz-18Gz)
	5.23dB (18GHz-26Gz)
Note: This uncertainty represents an expanded uncertainty expressed at approximately the 95% confidence level using a coverage factor of k=2.	





## 5. EQUIPMENT UNDER TEST

### 5.1. DESCRIPTION OF EUT

EUT Name	Huawei STB / Huawei BOX		
Model	Q21E		
Radio Technology	IEEE802.11b/g/n HT20/n HT40		
Operation frequency	IEEE 802.11b: 2412MHz—2462MHz IEEE 802.11g: 2412MHz—2462MHz IEEE 802.11n HT20: 2412MHz—2462MHz IEEE 802.11n HT40: 2422MHz—2452MHz		
Modulation	IEEE 802.11b: DSSS(CCK) IEEE 802.11g: OFDM(64QAM, 16QAM, QPSK, BPSK) IEEE 802.11n HT20: OFDM (64QAM, 16QAM, QPSK,BPSK) IEEE 802.11n HT40: OFDM (64QAM, 16QAM, QPSK,BPSK)		
Rated Input	DC 12V		
Power Supply	Power Adapter	Input	AC120~240V, 50/60Hz, 0.5A
		Output	DC 12V, 1.0A

### 5.2. MAXIMUM OUTPUT POWER

Number of Transmit Chains (NTX)	IEE Std. 802.11	Frequency (MHz)	Channel Number	Max PK Conducted Power (dBm)
1	IEEE 802.11b	2412-2462	1-11[11]	14.02
1	IEEE 802.11g	2412-2462	1-11[11]	17.71
1	IEEE 802.11nHT20	2412-2462	1-11[11]	18.51
1	IEEE 802.11nHT40	2422-2452	3-9[7]	17.54



### 5.3. CHANNEL LIST

Channel List for 802.11b/g/n (20 MHz)							
Channel	Frequency (MHz)	Channel	Frequency (MHz)	Channel	Frequency (MHz)	Channel	Frequency (MHz)
1	2412	4	2427	7	2442	10	2457
2	2417	5	2432	8	2447	11	2462
3	2422	6	2437	9	2452	/	/

Channel List for 802.11n (40 MHz)							
Channel	Frequency (MHz)	Channel	Frequency (MHz)	Channel	Frequency (MHz)	Channel	Frequency (MHz)
3	2422	5	2432	7	2442	9	2452
4	2427	6	2437	8	2447	/	/

### 5.4. TEST CHANNEL CONFIGURATION

Test Mode	Test Channel	Frequency
WiFi TX(802.11b)	CH 1, CH 6, CH 11	2412MHz, 2437MHz, 2462MHz
WiFi TX(802.11g)	CH 1, CH 6, CH 11	2412MHz, 2437MHz, 2462MHz
WiFi TX(802.11n HT20)	CH 1, CH 6, CH 11	2412MHz, 2437MHz, 2462MHz
WiFi TX(802.11n HT40)	CH 3, CH 6, CH 9	2422MHz, 2437MHz, 2452MHz

### 5.5. THE WORSE CASE CONFIGURATIONS

The Worst Case Power Setting Parameter under 2400 ~ 2483.5MHz Band							
Test Software		Tera Term					
Modulation Mode	Transmit Antenna Number	Test Channel					
		NCB: 20MHz			NCB: 40MHz		
		CH 1	CH 6	CH 11	CH 3	CH 6	CH 9
802.11b	1	Default	Default	Default	/		
802.11g	1	Default	Default	Default			
802.11n HT20	1	Default	Default	Default			
802.11n HT40	1	/			Default	Default	Default



### 5.6. DESCRIPTION OF AVAILABLE ANTENNAS

Antenna	Frequency (MHz)	Antenna Type	Antenna Gain (dBi)
1	2412-2462	FPCB Antenna	0

Test Mode	Transmit and Receive Mode	Description
IEEE 802.11b	<input checked="" type="checkbox"/> 1TX, 1RX	Antenna 1 can be used as transmitting/receiving antenna.
IEEE 802.11g	<input checked="" type="checkbox"/> 1TX, 1RX	Antenna 1 can be used as transmitting/receiving antenna.
IEEE 802.11n HT20	<input checked="" type="checkbox"/> 1TX, 1RX	Antenna 1 can be used as transmitting/receiving antenna.
IEEE 802.11n HT40	<input checked="" type="checkbox"/> 1TX, 1RX	Antenna 1 can be used as transmitting/receiving antenna.

## 5.7. DESCRIPTION OF TEST SETUP

### SUPPORT EQUIPMENT

Item	Equipment	Brand Name	Model Name	P/N
1	Laptop	ThinkPad	T460S	SL10K24796 JS
2	High Pass Filter	Wi	WHKX10-2700-3000-18000-40SS	23
3	Band Reject Filter	Wainwright	WRCJV8-2350-2400-2483.5-2533.5-40SS	4
4	Headphone	Sony	/	SSL-LT-RE-019
5	Monitor	DELL	P2715Q	CN-040FHF-WS200-79C-390L
6	Mouse	Dell	/	/

Note: Item 2 and Item 3 only use for radiated test.

### I/O CABLES

Item	Port	Connector Type	Cable Type	Cable Length(m)	Remarks
1	USB	USB	Unshielded	0.5	/
2	DC IN	DC	Unshielded	0.8	/
3	HDMI	HDMI	Shielded	0.5	/
4	RJ45	RJ45	Unshielded	0.8	/
5	AUX	AUX	Unshielded	0.5	/

### ACCESSORIES

Item	Accessory	Brand Name	Model Name	Description
1	AC ADAPTOR	HUAWEI	HW-120100E0W	Input: 100-240 Vac, 50/60 Hz, 0.5 A Output: 12Vdc, 1A
2	remote control	HUAWEI	/	/

### TEST SETUP

The EUT can work in engineering mode with a software through a Laptop.

### SETUP DIAGRAM FOR TESTS

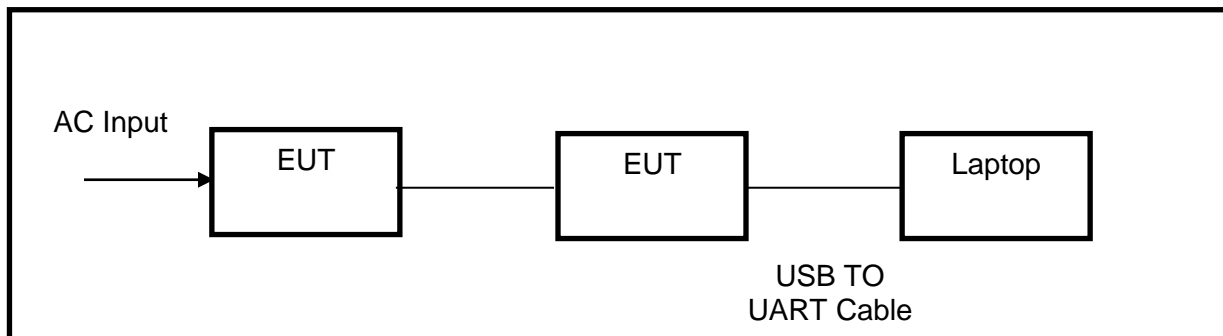



## 6. MEASURING INSTRUMENT AND SOFTWARE USED

Conducted Emissions						
Instrument						
Used	Equipment	Manufacturer	Model No.	Serial No.	Last Cal.	Next Cal.
<input checked="" type="checkbox"/>	EMI Test Receiver	R&S	ESR3	101961	Dec.12,2017	Dec.11,2018
<input checked="" type="checkbox"/>	Two-Line V-Network	R&S	ENV216	101983	Dec.12,2017	Dec.11,2018
<input checked="" type="checkbox"/>	Artificial Mains Networks	Schwarzbeck	NSLK 8126	8126465	Dec.12,2017	Dec.11,2018
Software						
Used	Description	Manufacturer	Name	Version		
<input checked="" type="checkbox"/>	Test Software for Conducted disturbance	Farad	EZ-EMC	Ver. UL-3A1		
Radiated Emissions						
Instrument						
Used	Equipment	Manufacturer	Model No.	Serial No.	Last Cal.	Next Cal.
<input checked="" type="checkbox"/>	MXE EMI Receiver	KESIGHT	N9038A	MY56400036	Dec.12,2017	Dec.11,2018
<input checked="" type="checkbox"/>	Hybrid Log Periodic Antenna	TDK	HLP-3003C	130960	Jan.09, 2016	Jan.09, 2019
<input checked="" type="checkbox"/>	Preamplifier	HP	8447D	2944A09099	Dec.12,2017	Dec.11,2018
<input checked="" type="checkbox"/>	EMI Measurement Receiver	R&S	ESR26	101377	Dec.12,2017	Dec.11,2018
<input checked="" type="checkbox"/>	Horn Antenna	TDK	HRN-0118	130939	Jan. 09, 2016	Jan. 09, 2019
<input checked="" type="checkbox"/>	High Gain Horn Antenna	Schwarzbeck	BBHA-9170	691	Jan.06, 2016	Jan.06, 2019
<input checked="" type="checkbox"/>	Preamplifier	TDK	PA-02-0118	TRS-305-00066	Dec.12,2017	Dec.11,2018
<input checked="" type="checkbox"/>	Preamplifier	TDK	PA-02-2	TRS-307-00003	Dec.12,2017	Dec.11,2018
<input checked="" type="checkbox"/>	Loop antenna	Schwarzbeck	1519B	00008	Mar. 26, 2016	Mar. 25, 2019
Software						
Used	Description	Manufacturer	Name	Version		
<input checked="" type="checkbox"/>	Test Software for Radiated disturbance	Farad	EZ-EMC	Ver. UL-3A1		
Other instruments						
Used	Equipment	Manufacturer	Model No.	Serial No.	Last Cal.	Next Cal.
<input checked="" type="checkbox"/>	Spectrum Analyzer	Keysight	N9030A	MY55410512	Dec.12,2017	Dec.11,2018
<input checked="" type="checkbox"/>	Power Meter	Keysight	N1911A	MY55416024	Dec.12,2017	Dec.11,2018
<input checked="" type="checkbox"/>	Power Sensor	Keysight	U2021XA	MY5100022	Dec.12,2017	Dec.11,2018



## 7. MEASUREMENT METHODS

No.	Test Item	KDB Name	Section
1	6dB Bandwidth	KDB 558074 D01 DTS Meas Guidance v05	8.2
2	Peak Output Power	KDB 558074 D01 DTS Meas Guidance v05	8.3.1.3/8.3.2.3
3	Power Spectral Density	KDB 558074 D01 DTS Meas Guidance v05	8.4
4	Out-of-band emissions in non-restricted bands	KDB 558074 D01 DTS Meas Guidance v05	8.5
5	Out-of-band emissions in restricted bands	KDB 558074 D01 DTS Meas Guidance v05	8.6
6	Band-edge	KDB 558074 D01 DTS Meas Guidance v05	8.7
7	Conducted Emission Test For AC Power Port	ANSI C63.10-2013	6.2



## 8. ANTENNA PORT TEST RESULTS

### 8.1. ON TIME AND DUTY CYCLE

#### LIMITS

None; for reporting purposes only

#### PROCEDURE

KDB 558074 Zero-Span Spectrum Analyzer Method

#### TEST SETUP

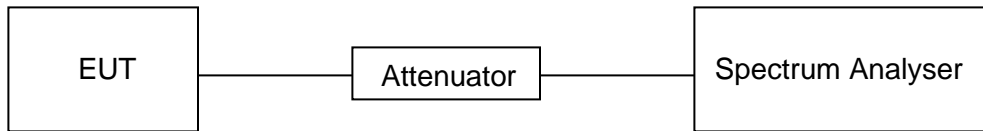

#### TEST ENVIRONMENT

Temperature	24.3°C	Relative Humidity	58%
Atmosphere Pressure	101kPa	Test Voltage	AC120V

#### RESULTS

Mode	On Time (msec)	Period (msec)	Duty Cycle x (Linear)	Duty Cycle (%)	Duty Cycle Correction Factor (dB)	1/T Minimum VBW (KHz)	Final setting For VBW (KHz)
11b	12.41	12.46	0.9959	99.59	0.01	0.08	0.01
11g	2.057	2.171	0.9475	94.75	0.23	0.49	0.5
11n20	1.915	2.045	0.9364	93.64	0.29	0.52	1
11n40	0.940	1.089	0.8632	86.32	0.64	1.06	2

Note:

Duty Cycle Correction Factor=10log (1/x).

Where: x is Duty Cycle (Linear)

Where: T is On Time

If that calculated VBW is not available on the analyzer then the next higher value should be used.

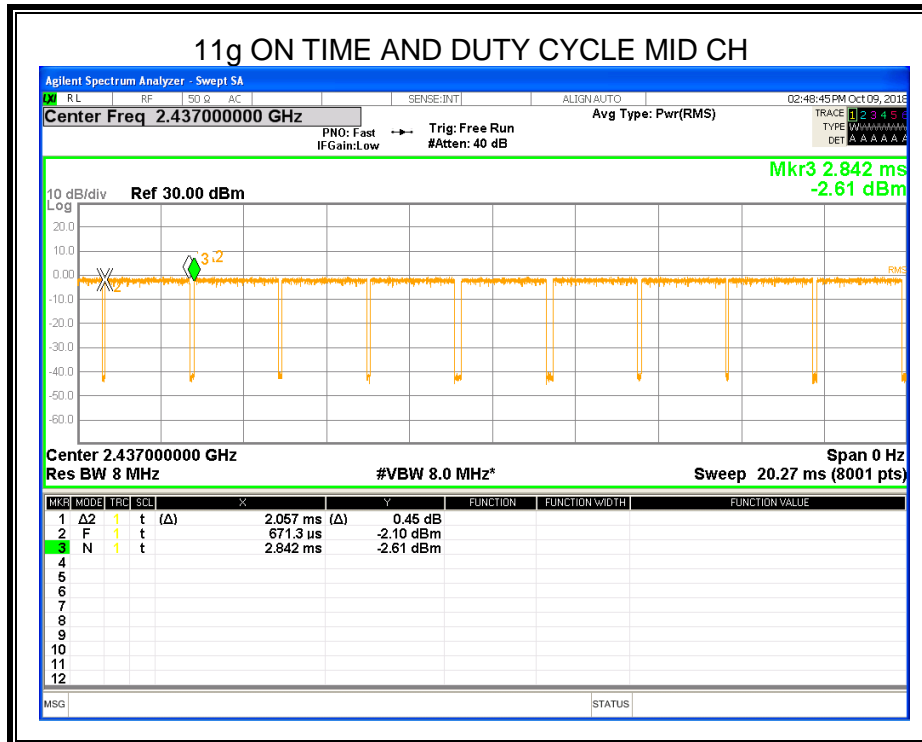
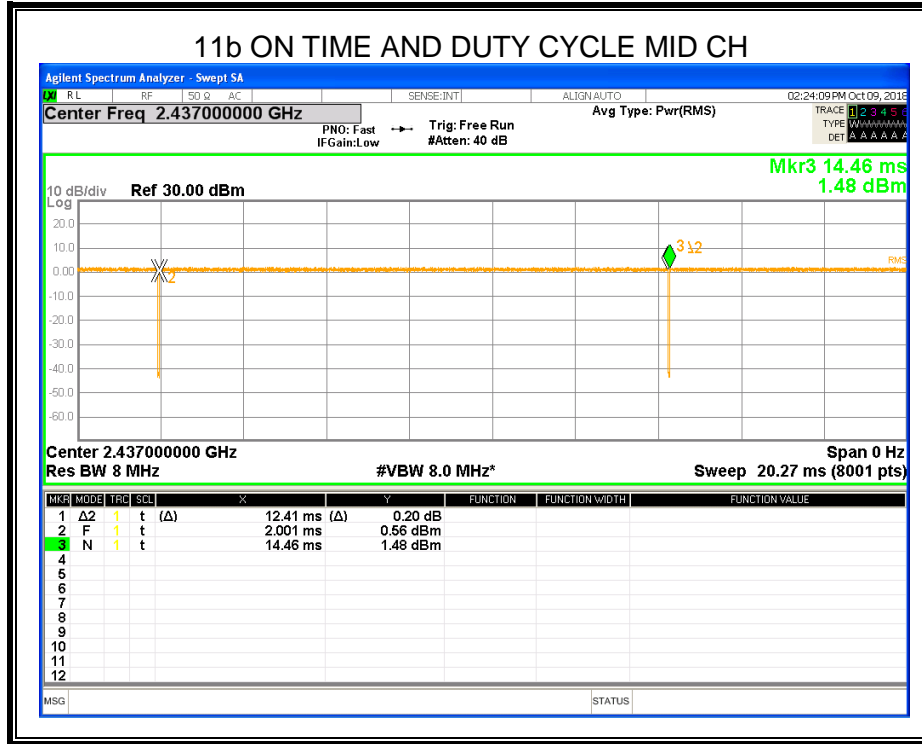



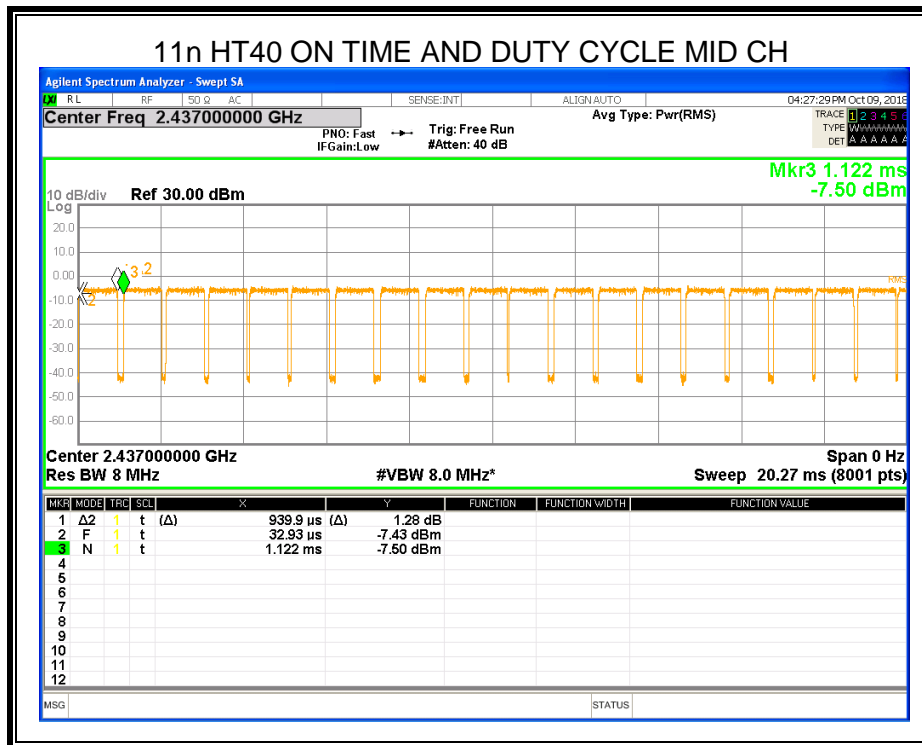
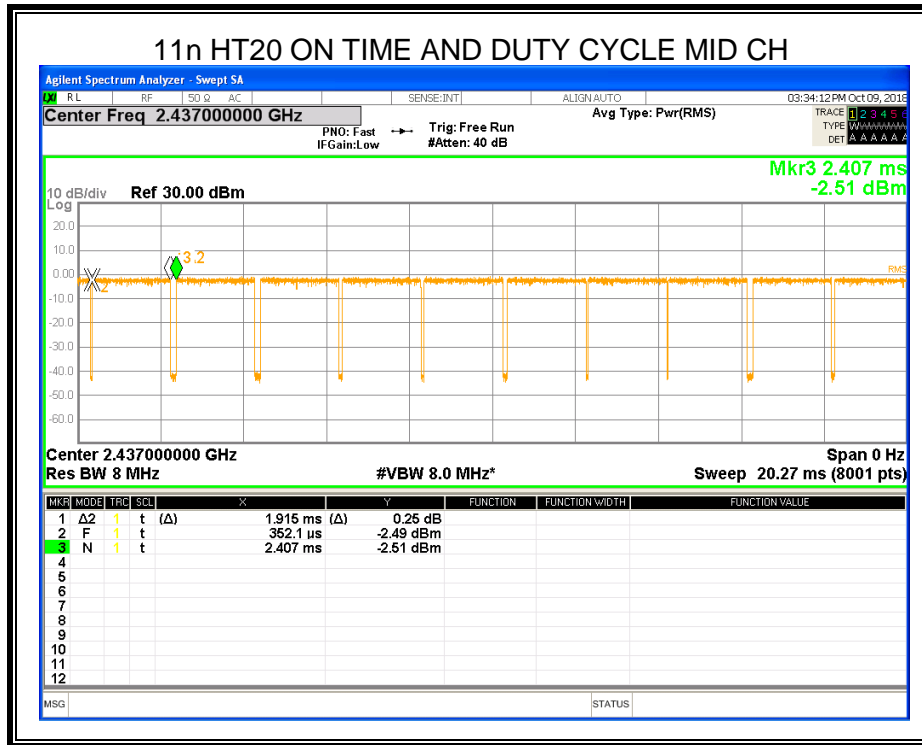

## 8.2. 6 dB DTS BANDWIDTH AND 99% OCCUPIED BANDWIDTH

### LIMITS

CFR 47 FCC Part15 (15.247) Subpart C ISED RSS-247 ISSUE 2			
Section	Test Item	Limit	Frequency Range (MHz)
CFR 47 FCC 15.247(a)(2) ISED RSS-247 5.2 (a)	6 dB Bandwidth	≥ 500KHz	2400-2483.5
ISED RSS-Gen Clause 6.7	99% Occupied Bandwidth	For reporting purposes only.	2400-2483.5

### TEST PROCEDURE

Connect the UUT to the spectrum analyser and use the following settings:

Center Frequency	The centre frequency of the channel under test
Detector	Peak
RBW	For 6dB Bandwidth :100K For 99% Occupied Bandwidth :1% to 5% of the occupied bandwidth
VBW	For 6dB Bandwidth : ≥3 × RBW For 99% Occupied Bandwidth : approximately 3×RBW
Trace	Max hold
Sweep	Auto couple

Allow the trace to stabilize and measure the maximum width of the emission that is constrained by the frequencies associated with the two outermost amplitude points (upper and lower frequencies) that are attenuated by 6 dB and 99% relative to the maximum level measured in the fundamental emission.

### TEST SETUP

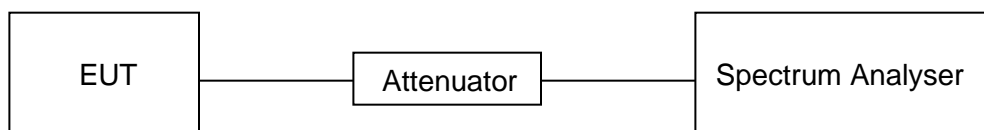



**TEST ENVIRONMENT**

Temperature	24.3°C	Relative Humidity	58%
Atmosphere Pressure	101kPa	Test Voltage	AC120V

**RESULTS**

**8.2.1. 802.11b MODE**

Channel	6dB bandwidth (MHz)	99% bandwidth (MHz)	Limit (kHz)	Result
Low	8.593	13.609	≥500	Pass
Middle	8.547	13.314	≥500	Pass
High	8.539	13.256	≥500	Pass

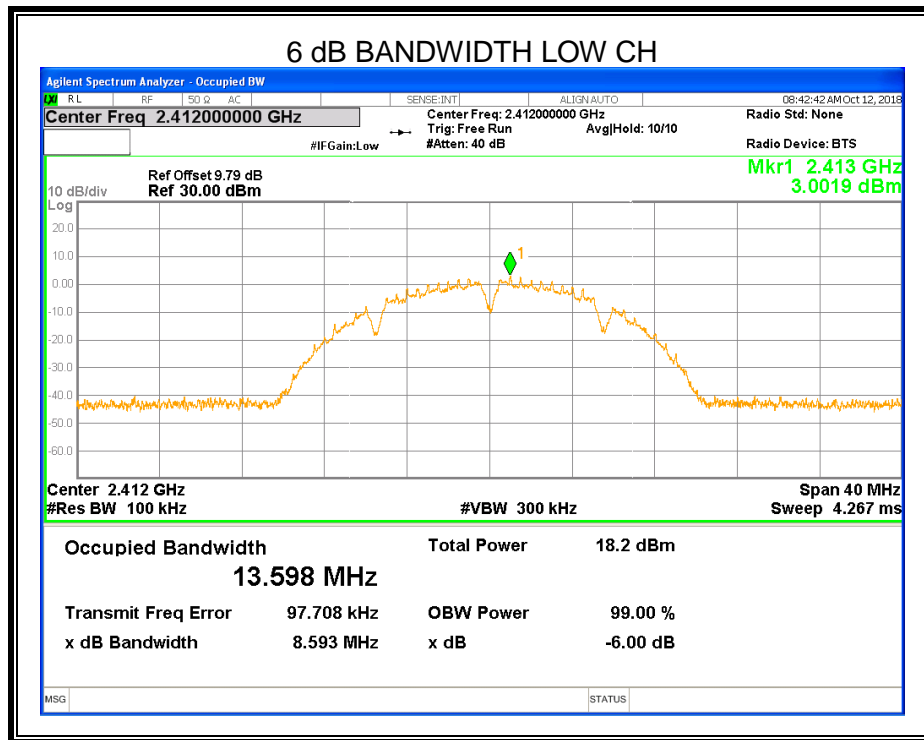

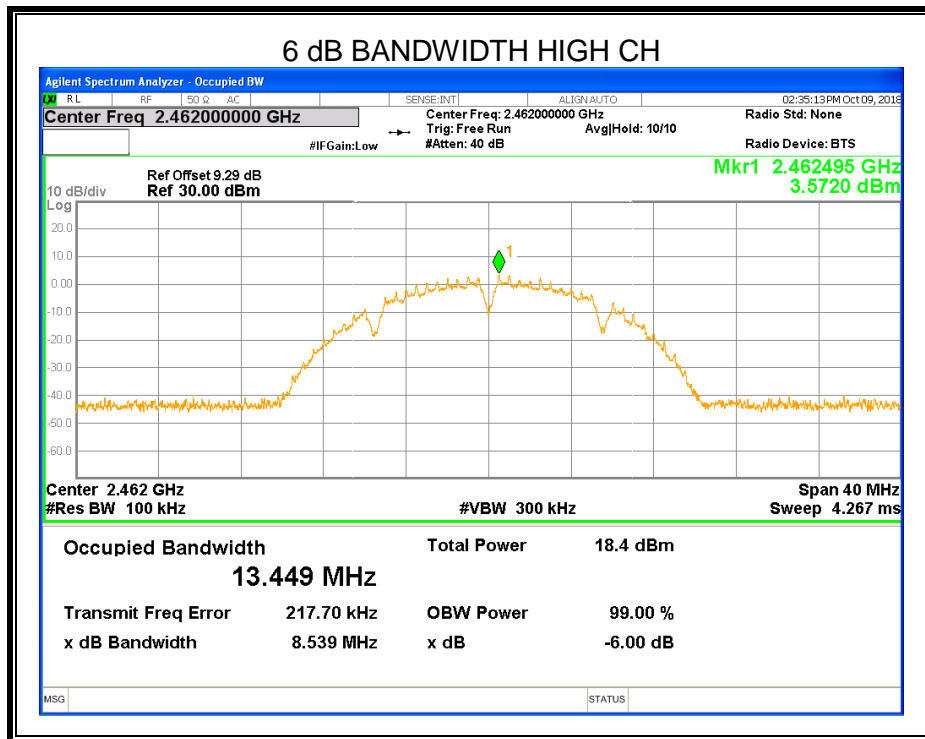
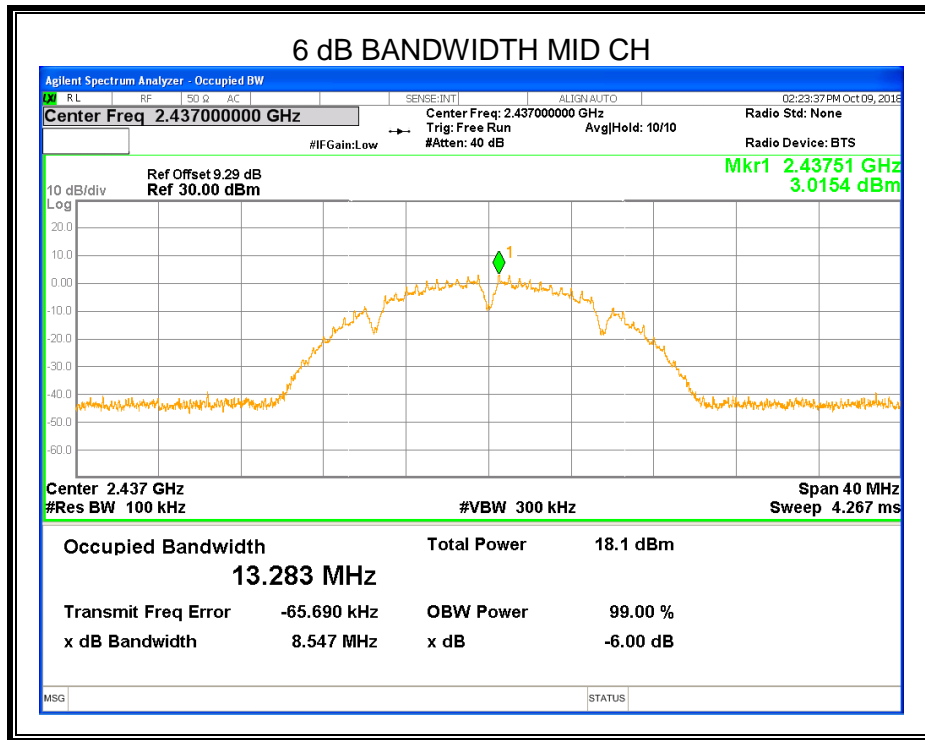

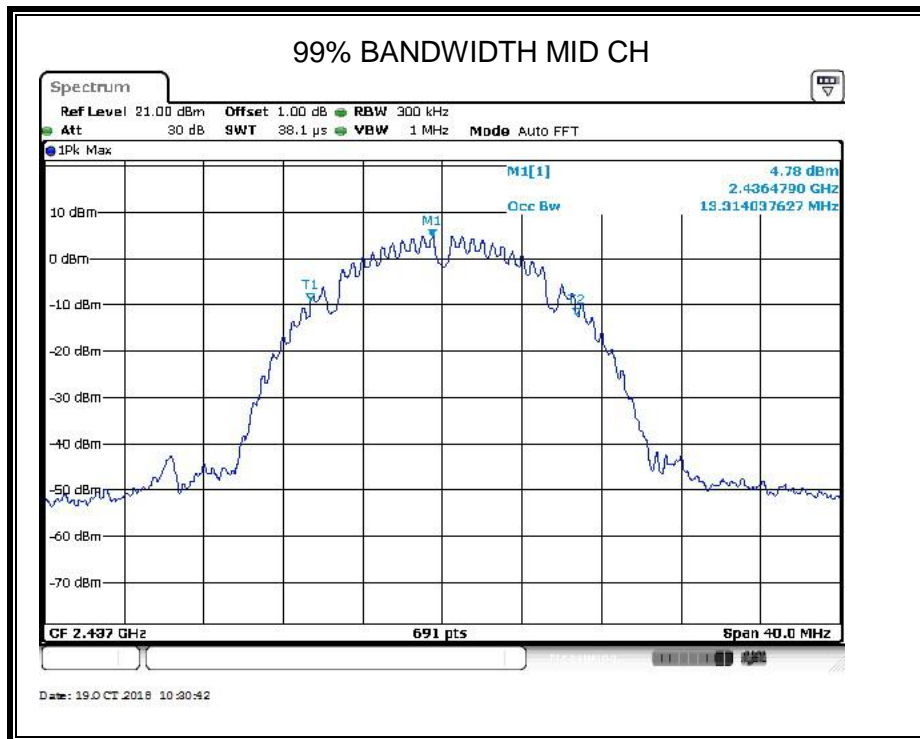
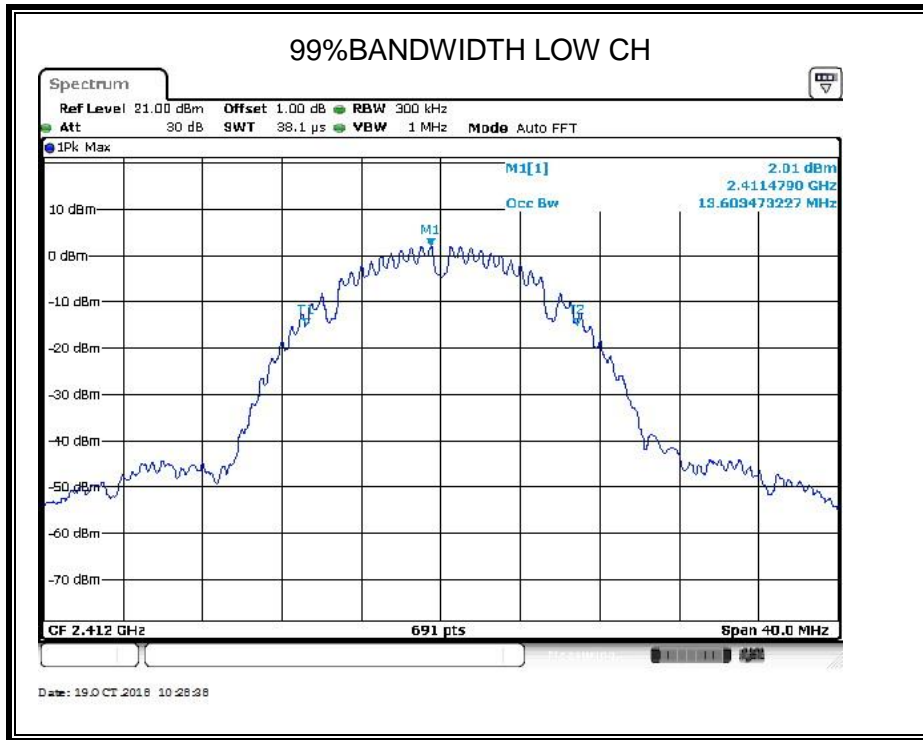

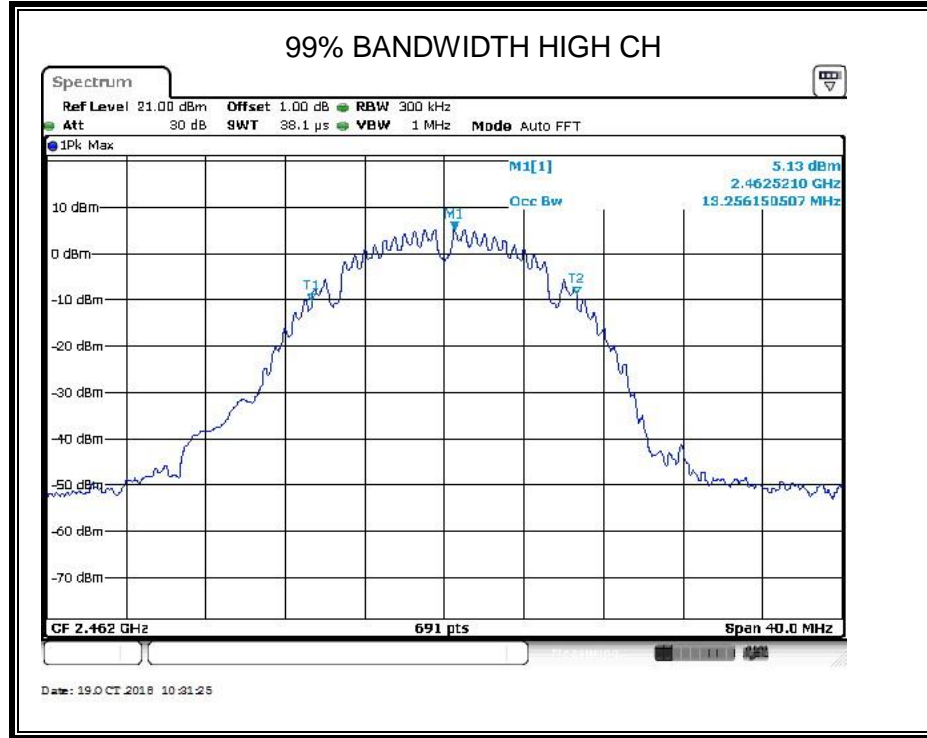



### 8.2.2. 802.11g MODE

Channel	6dB bandwidth (MHz)	99% bandwidth (MHz)	Limit (kHz)	Result
Low	16.40	16.903	≥500	Pass
Middle	16.32	16.845	≥500	Pass
High	16.04	16.787	≥500	Pass

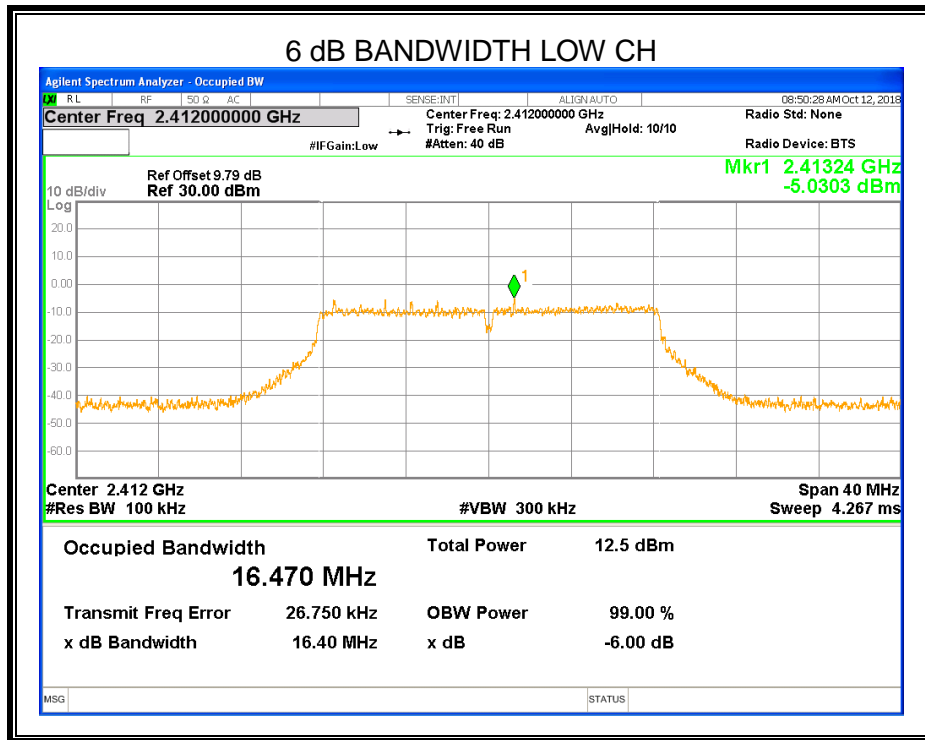

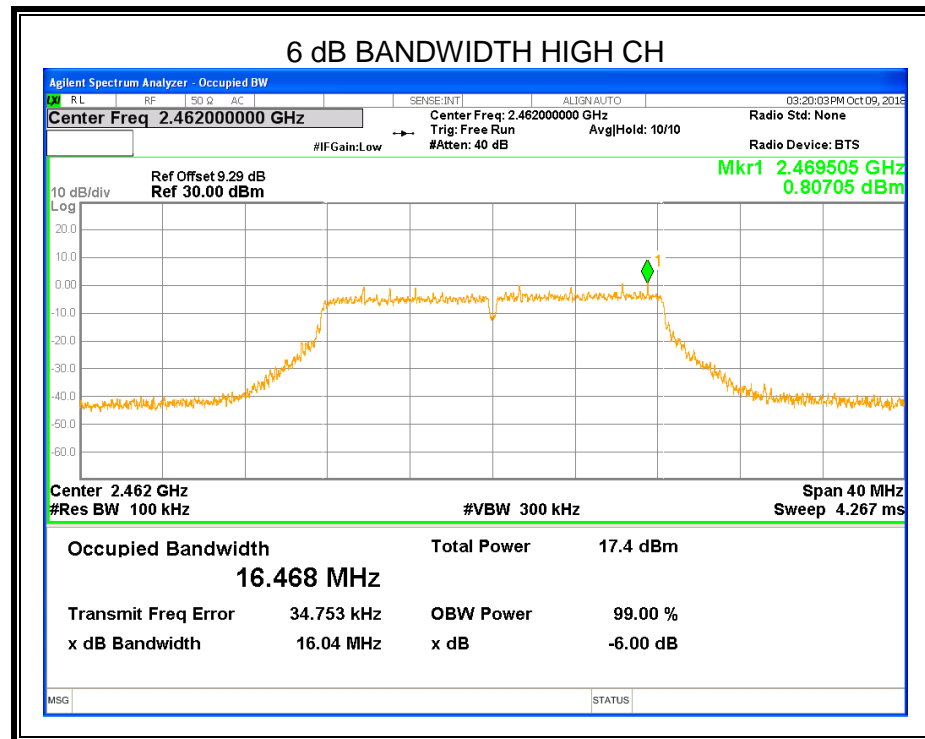
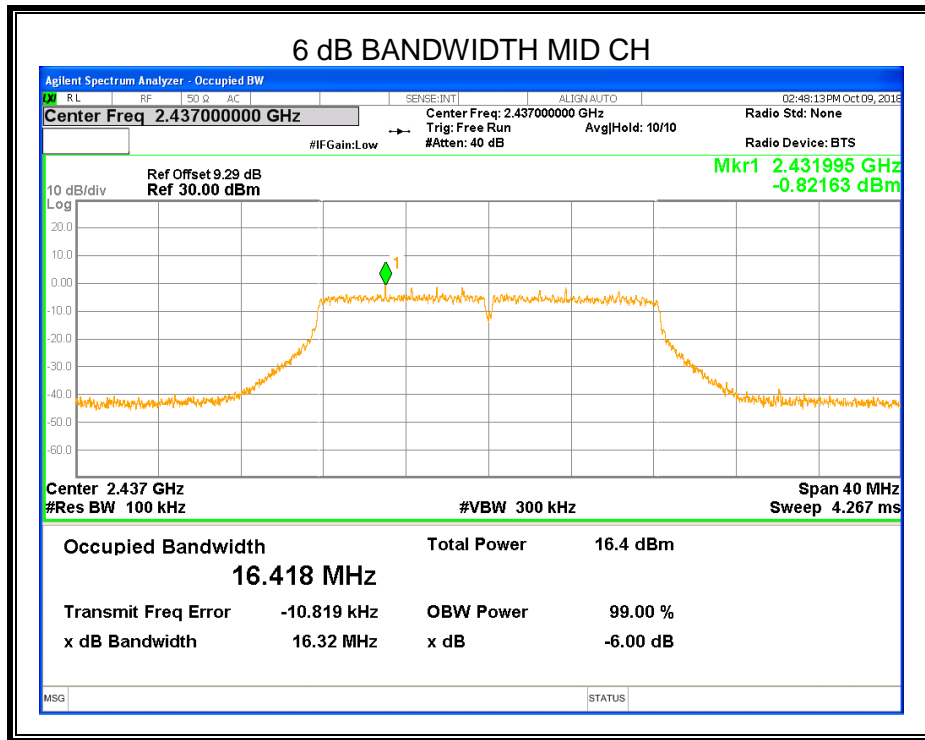



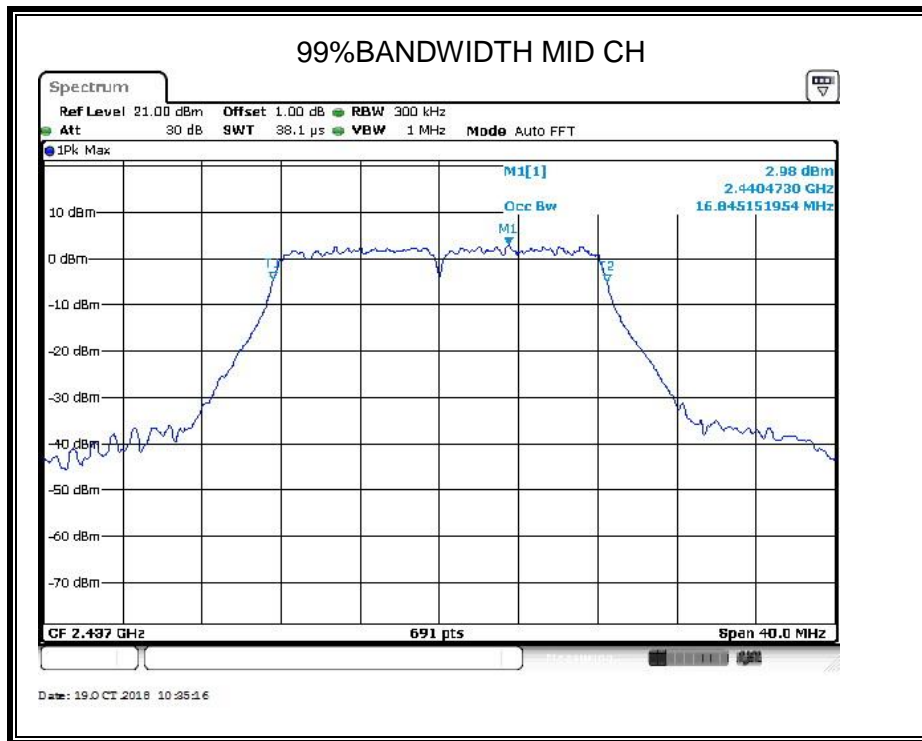
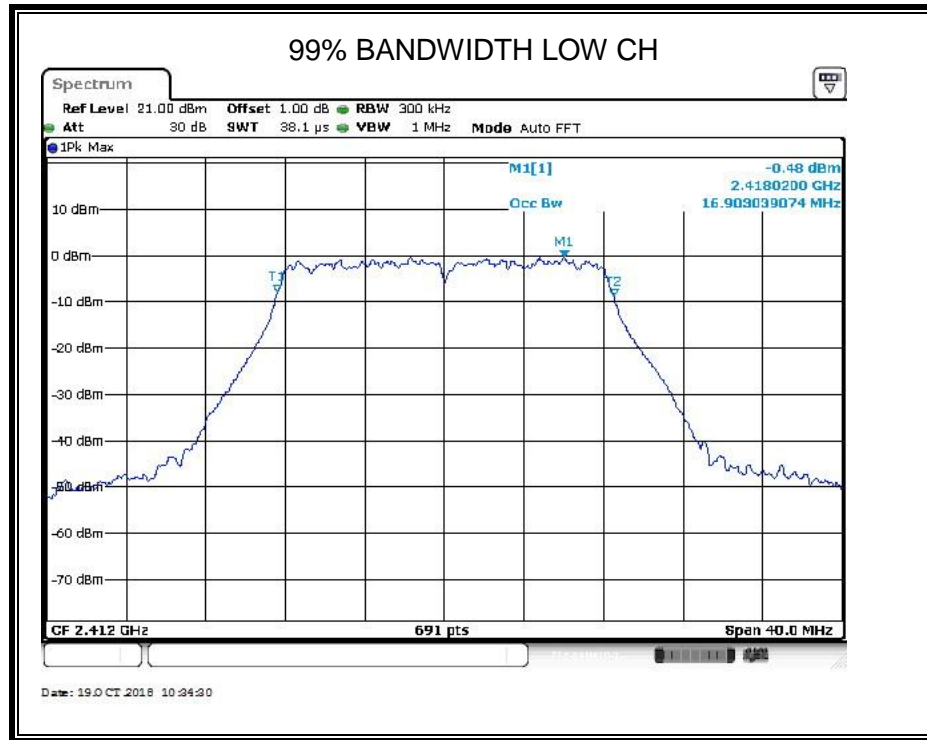

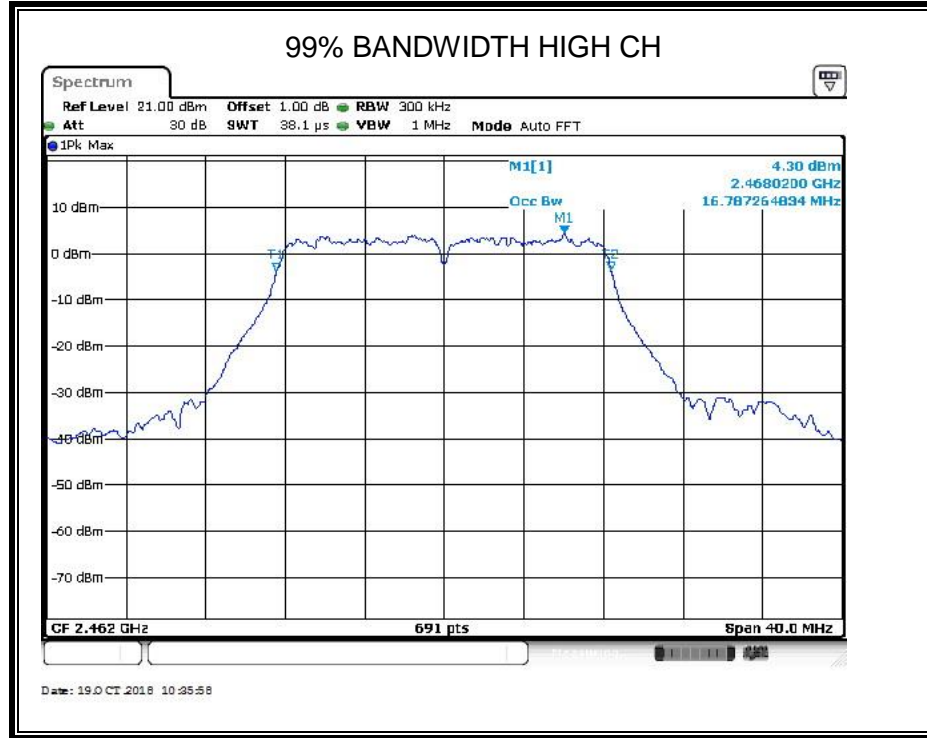



8.2.3. 802.11n HT20 MODE

Channel	6dB bandwidth (MHz)	99% bandwidth (MHz)	Limit (kHz)	Result
Low	17.54	17.829	≥500	Pass
Middle	17.19	17.945	≥500	Pass
High	16.69	18.003	≥500	Pass

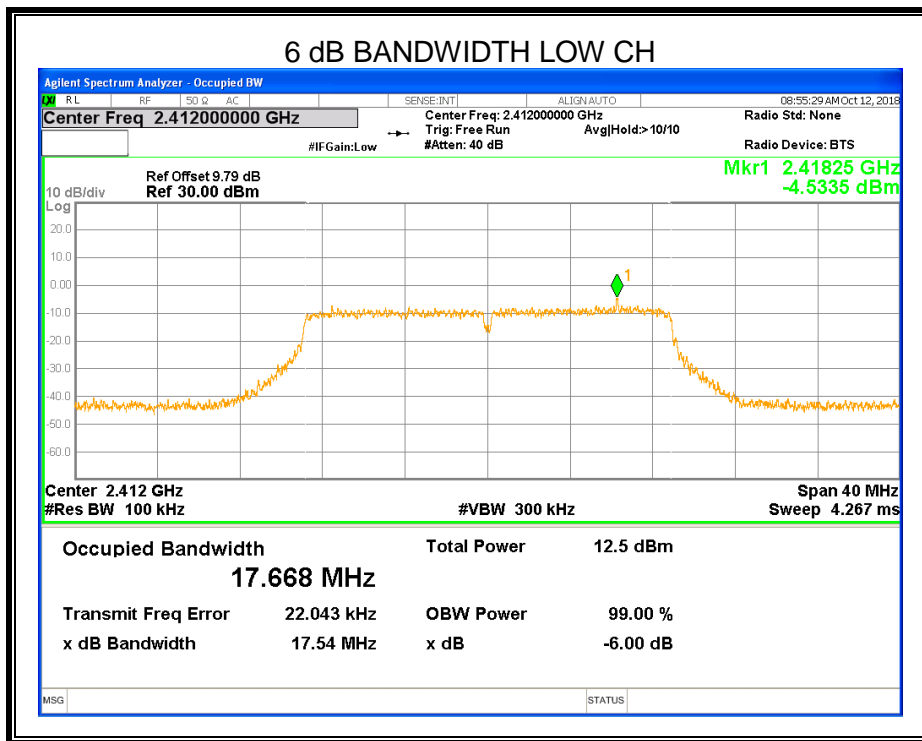

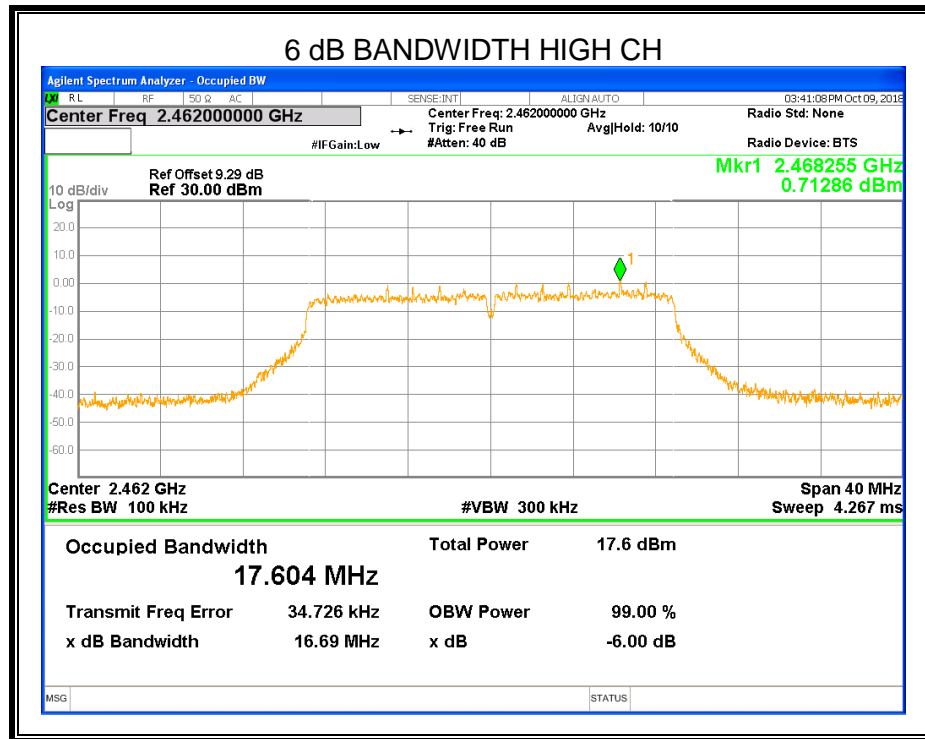
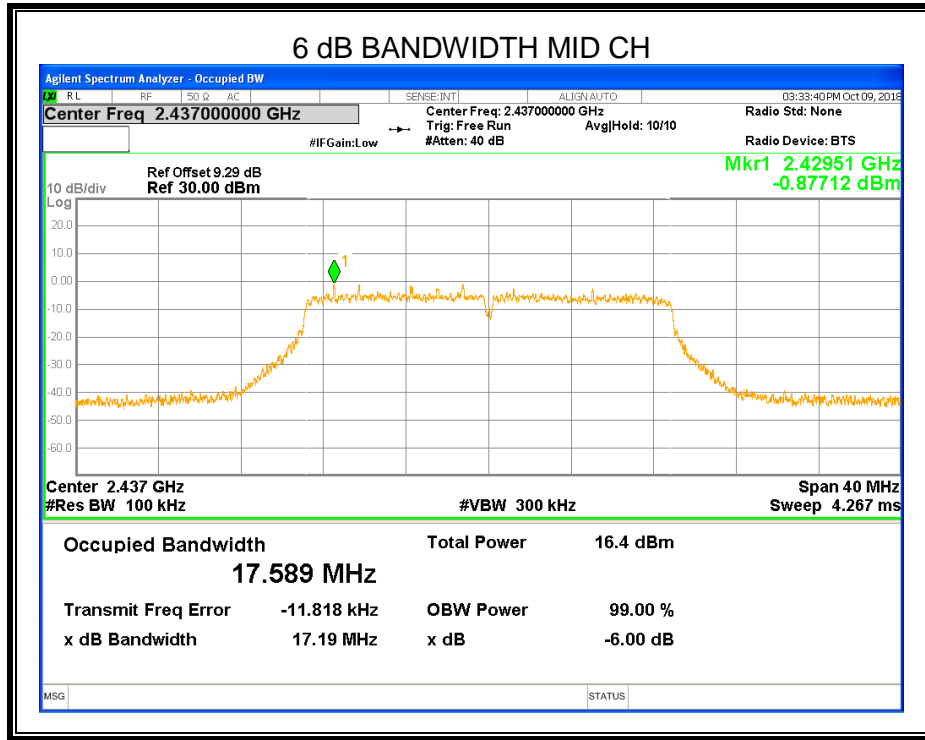

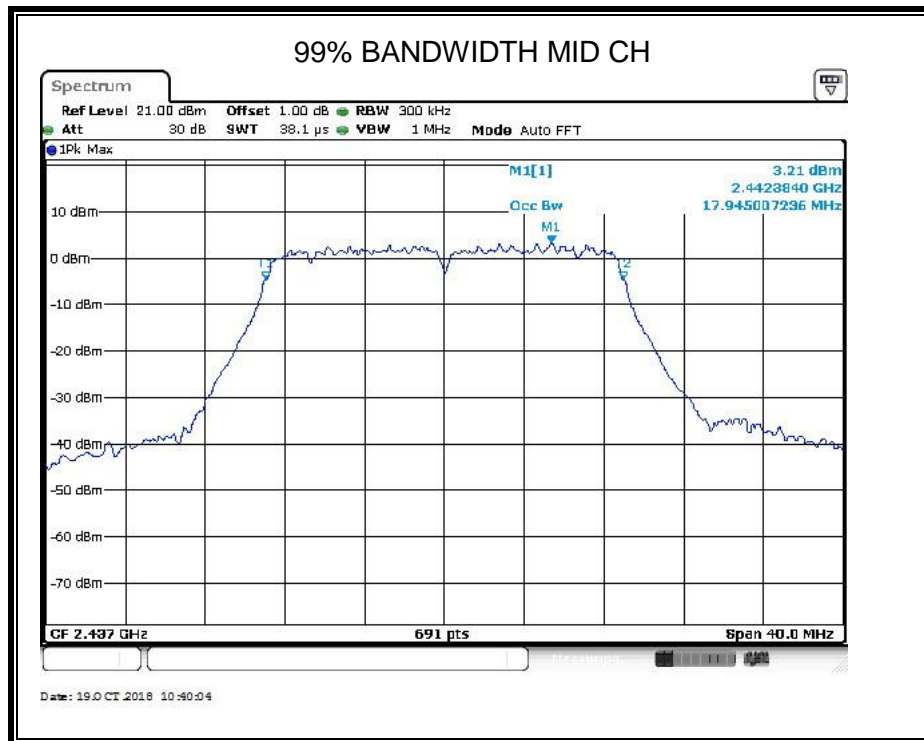

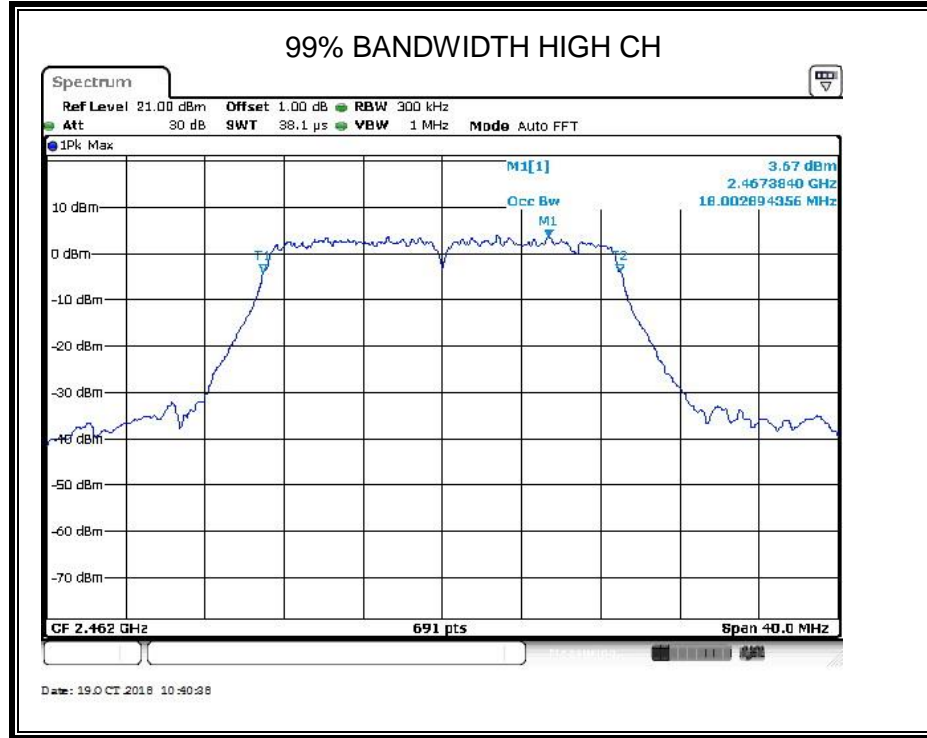



8.2.4. 802.11n HT40 MODE

Channel	6dB bandwidth (MHz)	99% bandwidth (MHz)	Limit (kHz)	Result
Low	35.41	36.585	≥500	Pass
Middle	35.46	36.585	≥500	Pass
High	36.06	36.469	≥500	Pass

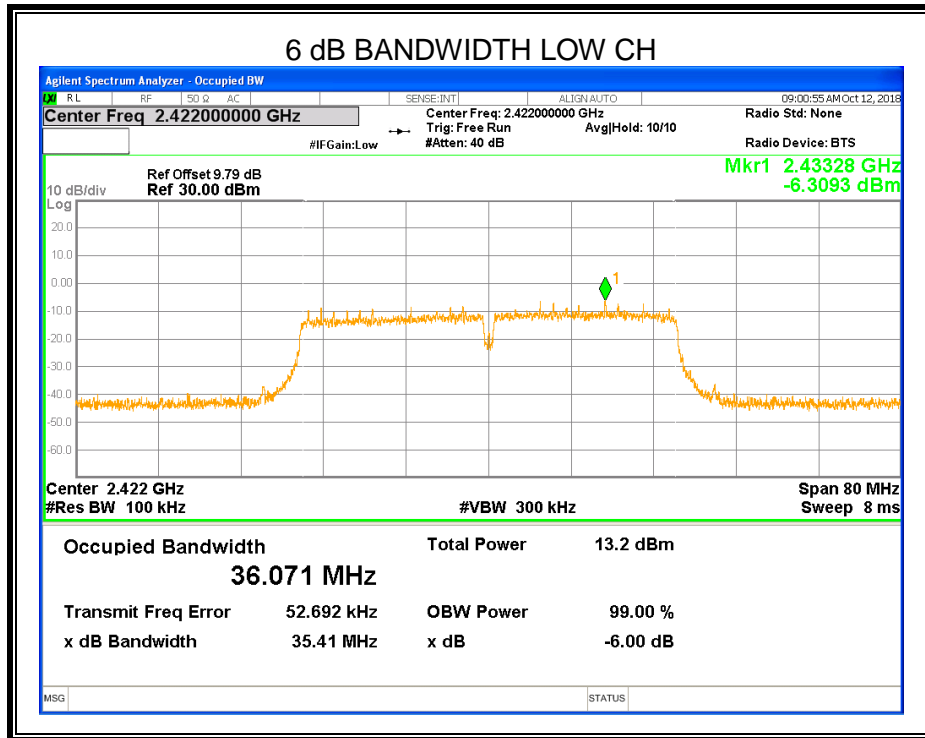

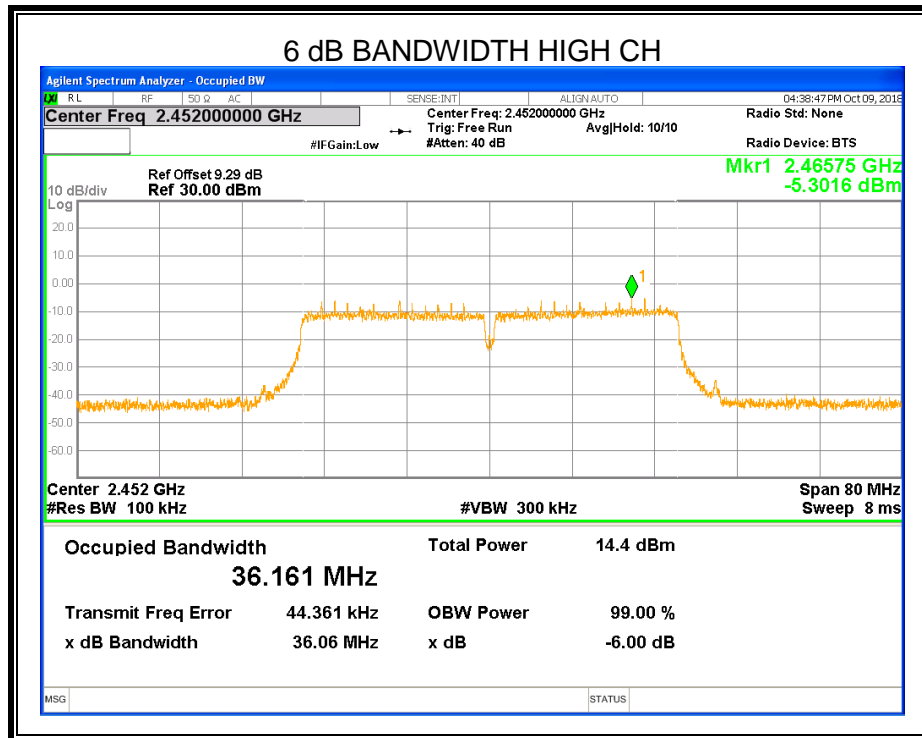
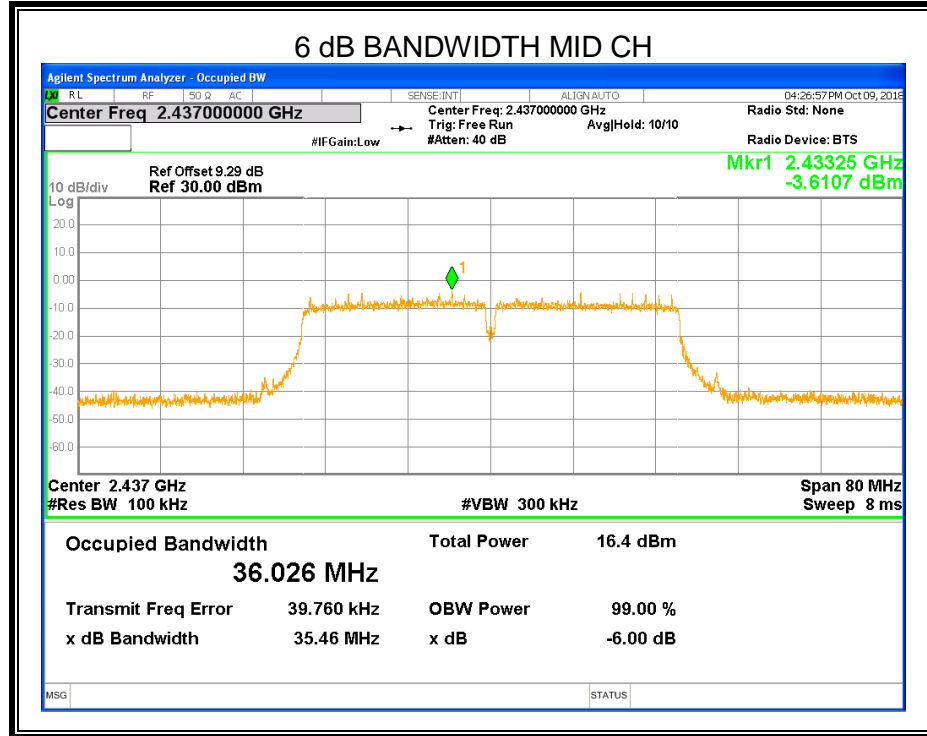



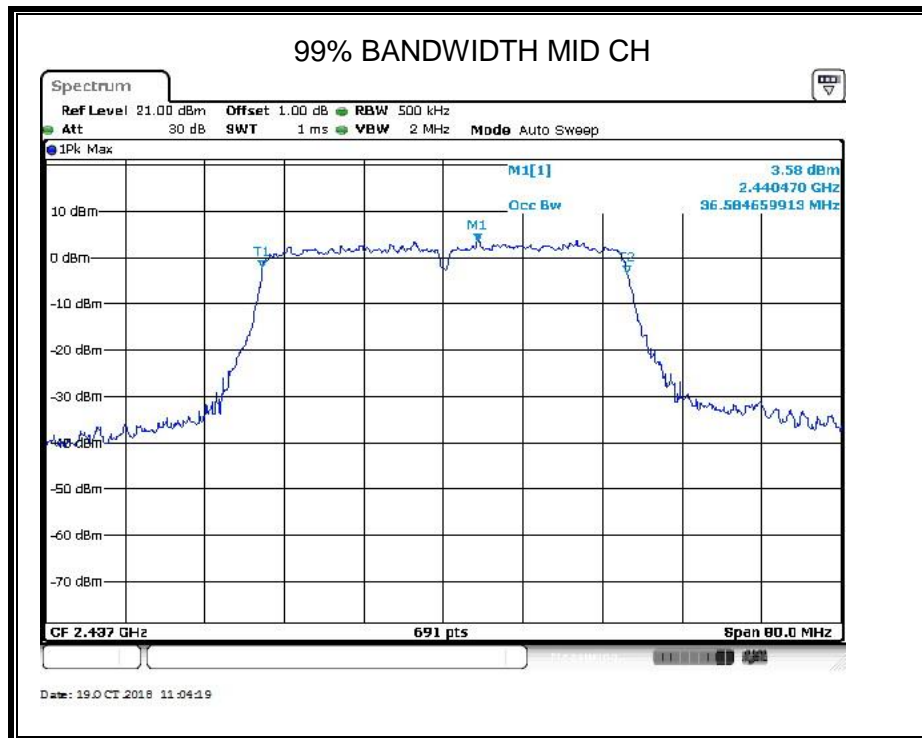
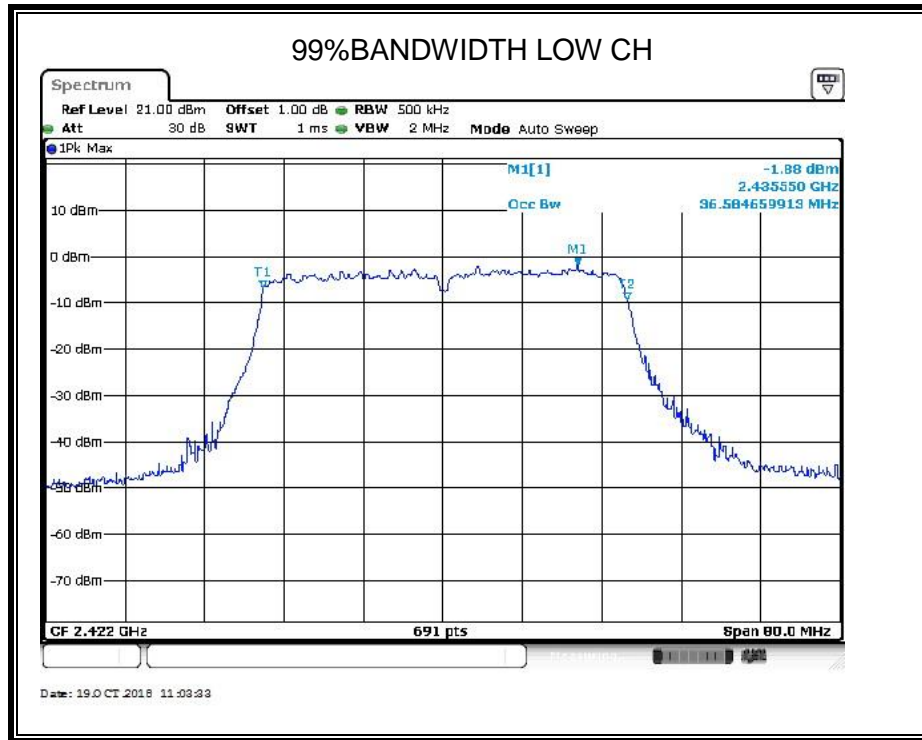





### 8.3. PEAK CONDUCTED OUTPUT POWER

#### LIMITS

CFR 47 FCC Part15 (15.247) Subpart C ISED RSS-247 ISSUE 2			
Section	Test Item	Limit	Frequency Range (MHz)
CFR 47 FCC 15.247(b)(3) ISED RSS-247 5.4 (e)	Peak Output Power	1 watt or 30dBm	2400-2483.5

#### TEST PROCEDURE

Place the EUT on the table and set it in the transmitting mode.  
Remove the antenna from the EUT and then connect a low loss RF cable from the antenna port to the Power sensor.  
Measure peak power each channel.  
Peak Detector use for Peak result.  
AVG Detector use for AVG result.

#### TEST SETUP

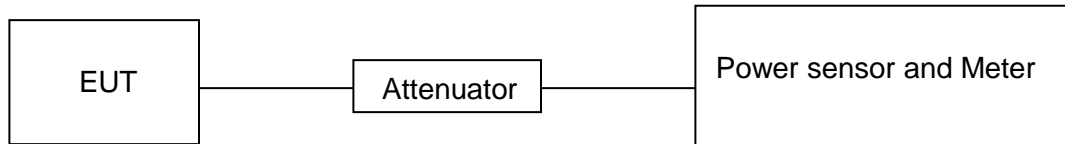

#### TEST ENVIRONMENT

Temperature	24.3°C	Relative Humidity	58%
Atmosphere Pressure	101kPa	Test Voltage	AC120V



**RESULTS**

**8.3.1. 802.11b MODE**

Test Channel	Maximum Conducted Output Power(PK)	Maximum Conducted Output Power(AV)	LIMIT
	(dBm)	(dBm)	dBm
Low	13.50	11.21	30
Middle	13.67	11.42	30
High	14.02	11.85	30

**8.3.2. 802.11g MODE**

Test Channel	Maximum Conducted Output Power(PK)	Maximum Conducted Output Power(AV)	LIMIT
	(dBm)	(dBm)	dBm
Low	13.73	6.66	30
Middle	17.71	10.58	30
High	18.67	11.71	30

**8.3.3. 802.11n HT20 MODE**

Test Channel	Maximum Conducted Output Power(PK)	Maximum Conducted Output Power(AV)	LIMIT
	(dBm)	(dBm)	dBm
Low	13.72	6.37	30
Middle	17.62	10.60	30
High	18.51	11.53	30

**8.3.4. 802.11 n HT40 MODE**

Test Channel	Maximum Conducted Output Power(PK)	Maximum Conducted Output Power(AV)	LIMIT
	(dBm)	(dBm)	dBm
Low	14.12	7.24	30
Middle	17.54	10.66	30
High	15.58	8.56	30

## 8.4. POWER SPECTRAL DENSITY

### LIMITS

CFR 47 FCC Part15 (15.247) Subpart C ISED RSS-247 ISSUE 2			
Section	Test Item	Limit	Frequency Range (MHz)
CFR 47 FCC §15.247 (e) ISED RSS-247 5.2 (b)	Power Spectral Density	8 dBm/3 kHz	2400-2483.5

### TEST PROCEDURE

Connect the UUT to the spectrum analyser and use the following settings:

Center Frequency	The centre frequency of the channel under test
Detector	Peak
RBW	$3 \text{ kHz} \leq \text{RBW} \leq 100 \text{ kHz}$
VBW	$\geq 3 \times \text{RBW}$
Span	1.5 x DTS bandwidth
Trace	Max hold
Sweep time	Auto couple.

Allow trace to fully stabilize and use the peak marker function to determine the maximum amplitude level within the RBW.  
If measured value exceeds limit, reduce RBW (no less than 3 kHz) and repeat.

### TEST SETUP

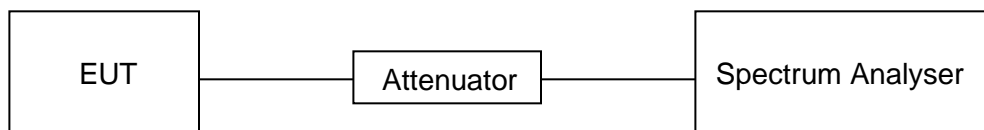

### TEST ENVIRONMENT

Temperature	24.3°C	Relative Humidity	58%
Atmosphere Pressure	101kPa	Test Voltage	AC120V



**RESULTS**

**8.4.1. 802.11b MODE**

Test Channel	Power Spectral Density (dBm/3kHz)	Limit (dBm/3kHz)	Result
Low	-10.361	8	PASS
Middle	-11.357	8	PASS
High	-10.488	8	PASS

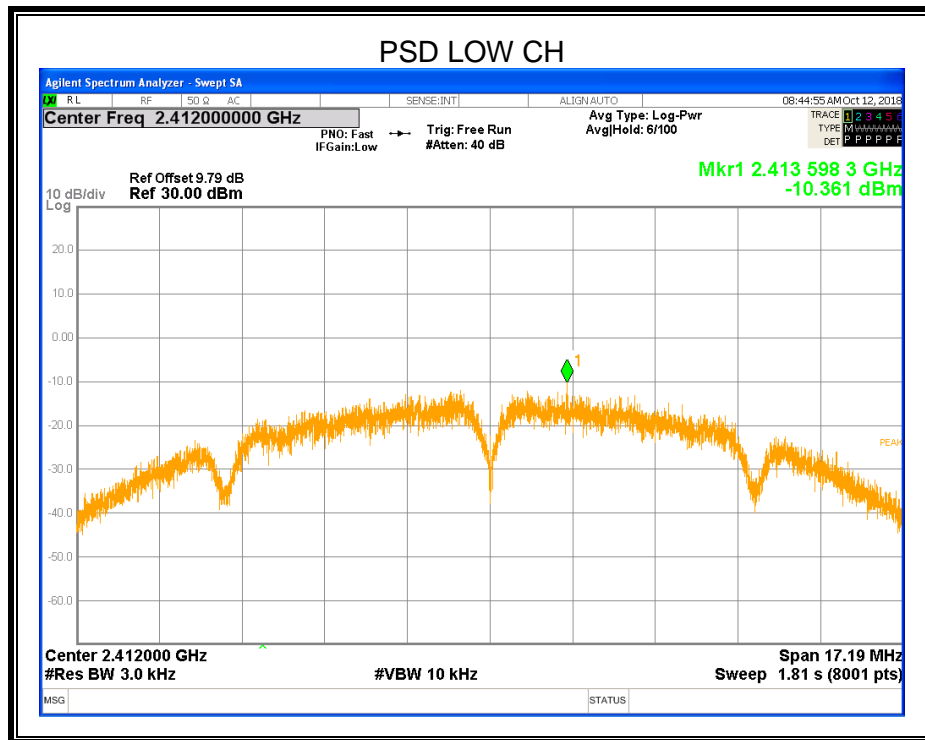

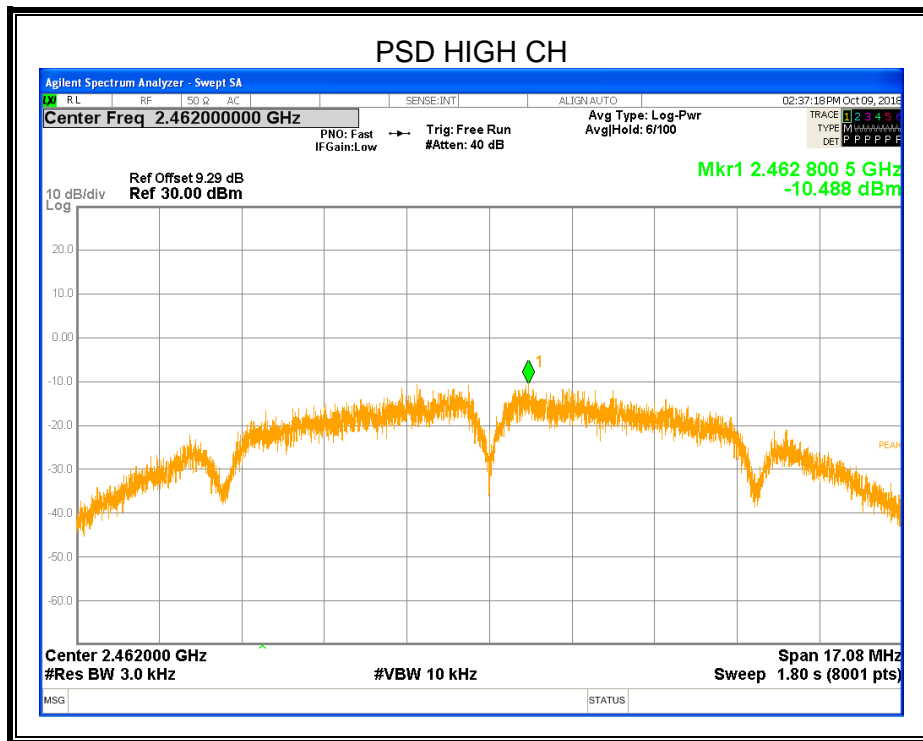
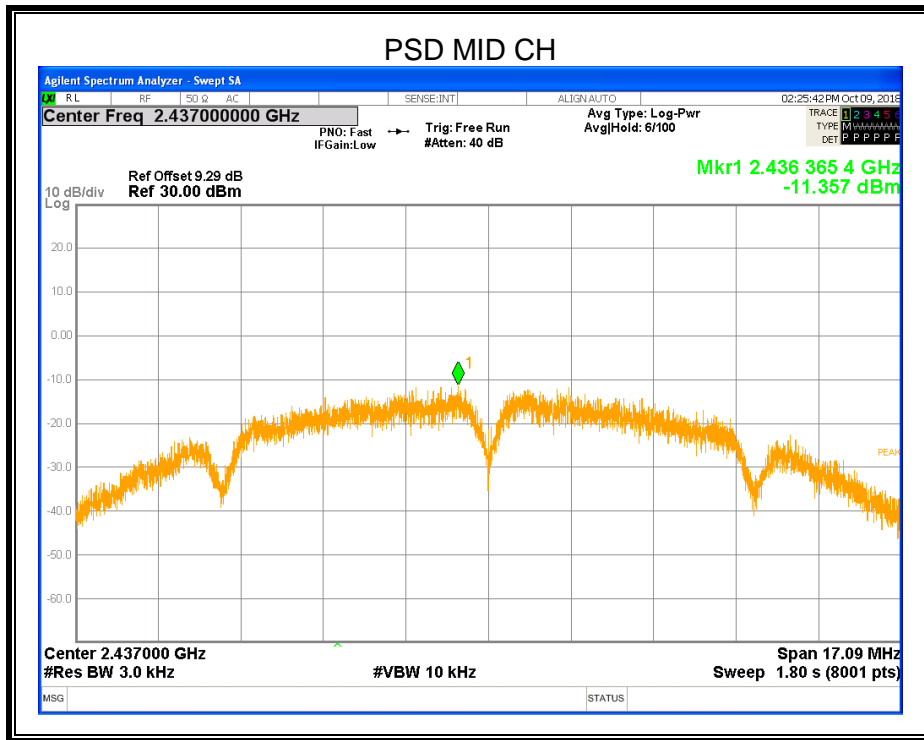



### 8.4.2. 802.11g MODE

Test Channel	Power Spectral Density (dBm/3kHz)	Limit (dBm/3kHz)	Result
Low	-19.100	8	PASS
Middle	-15.214	8	PASS
High	-13.322	8	PASS

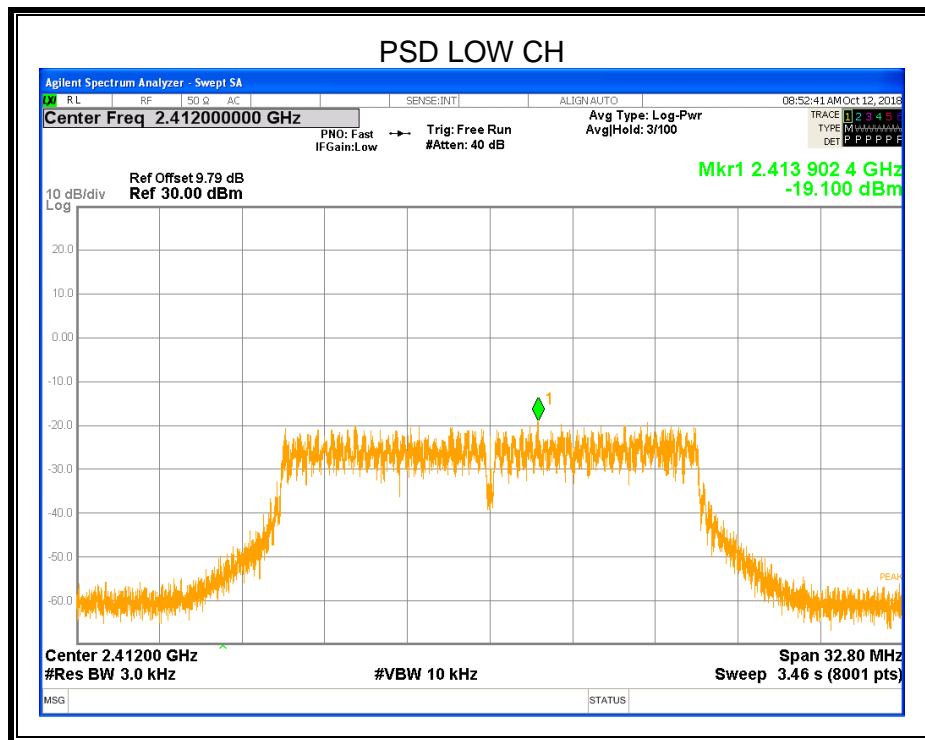



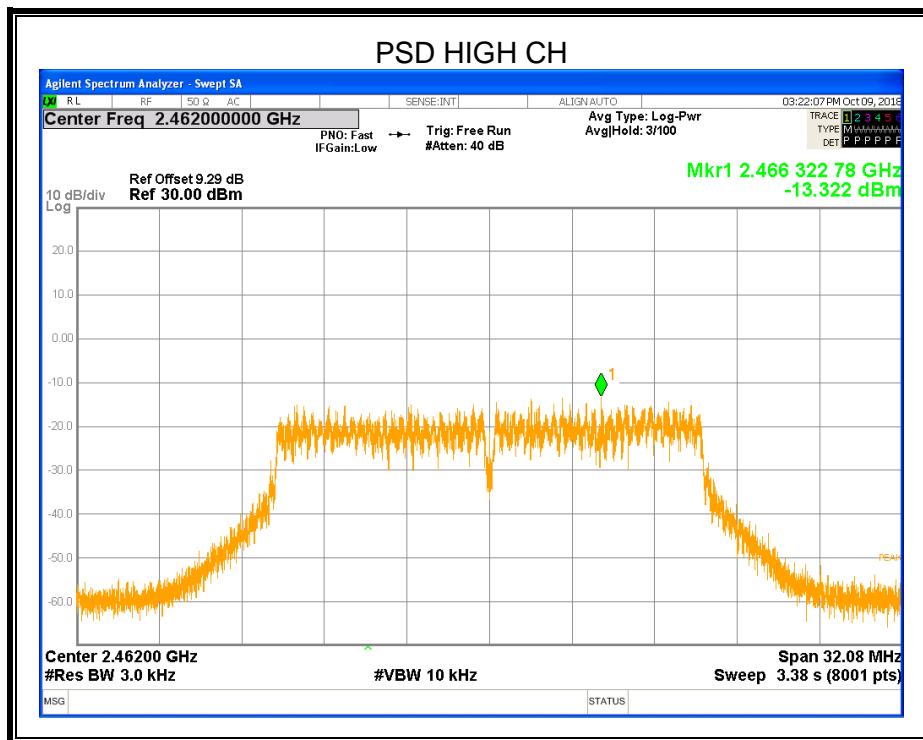
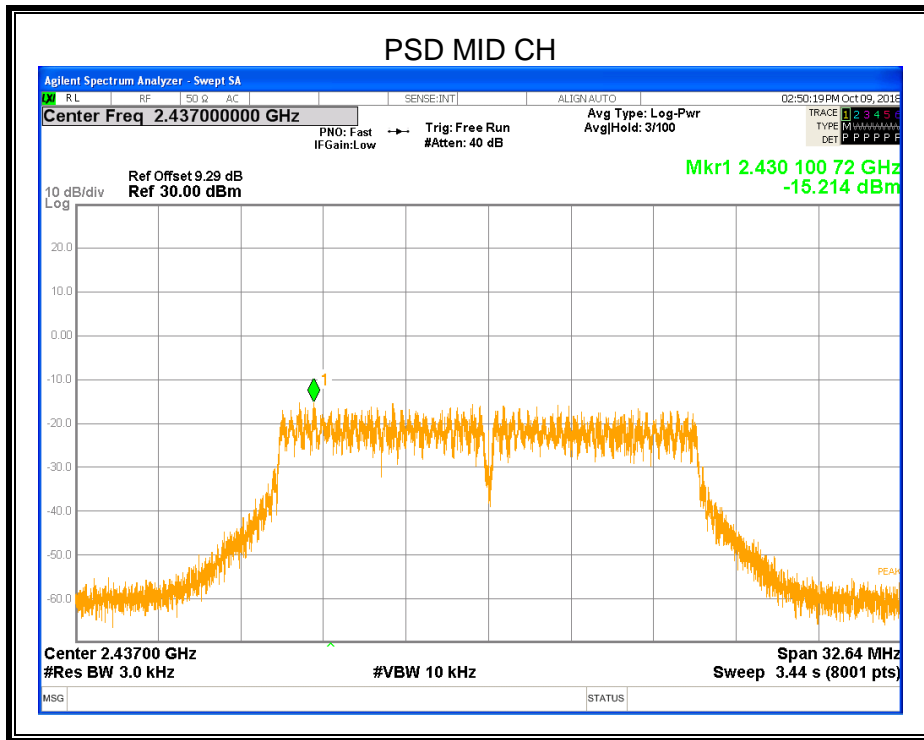



### 8.4.3. 802.11n HT20 MODE

Test Channel	Power Spectral Density (dBm/3kHz)	Limit (dBm/3kHz)	Result
Low	-18.706	8	PASS
Middle	-15.525	8	PASS
High	-14.337	8	PASS

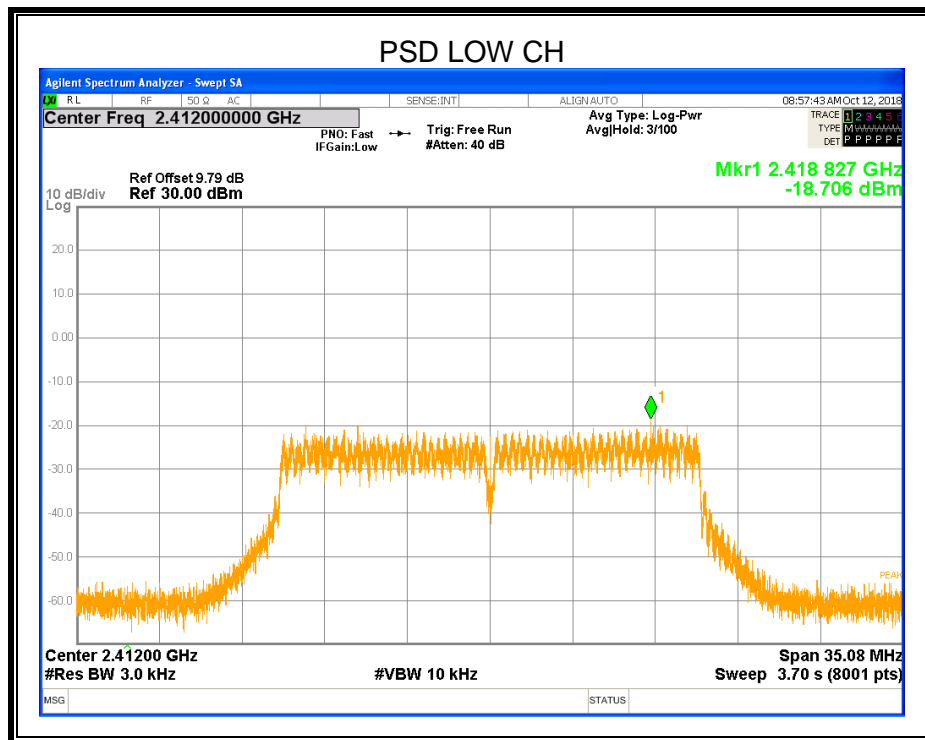

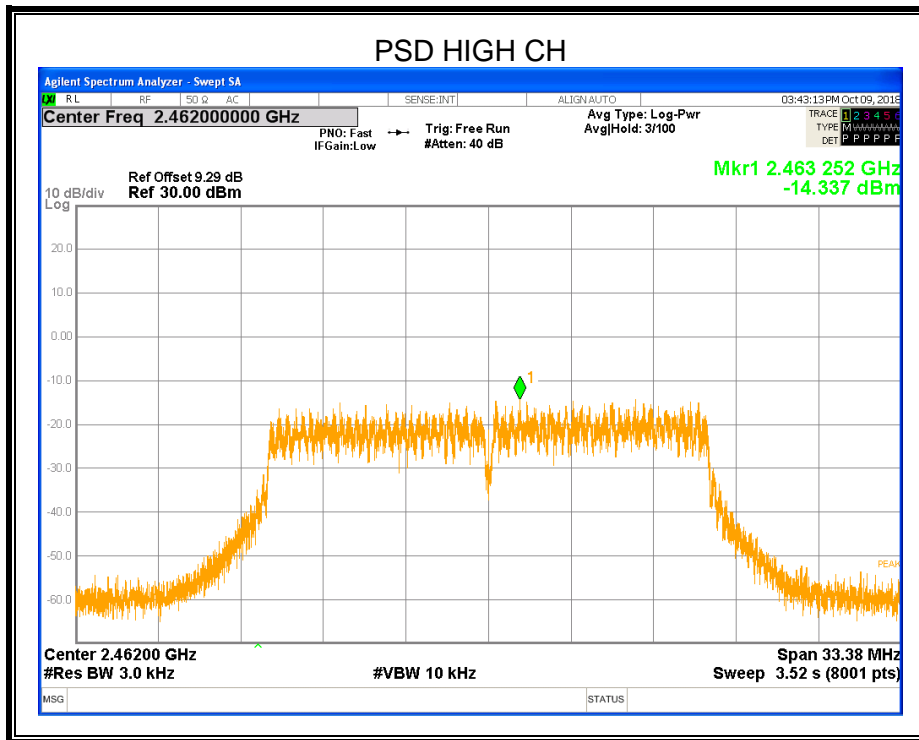
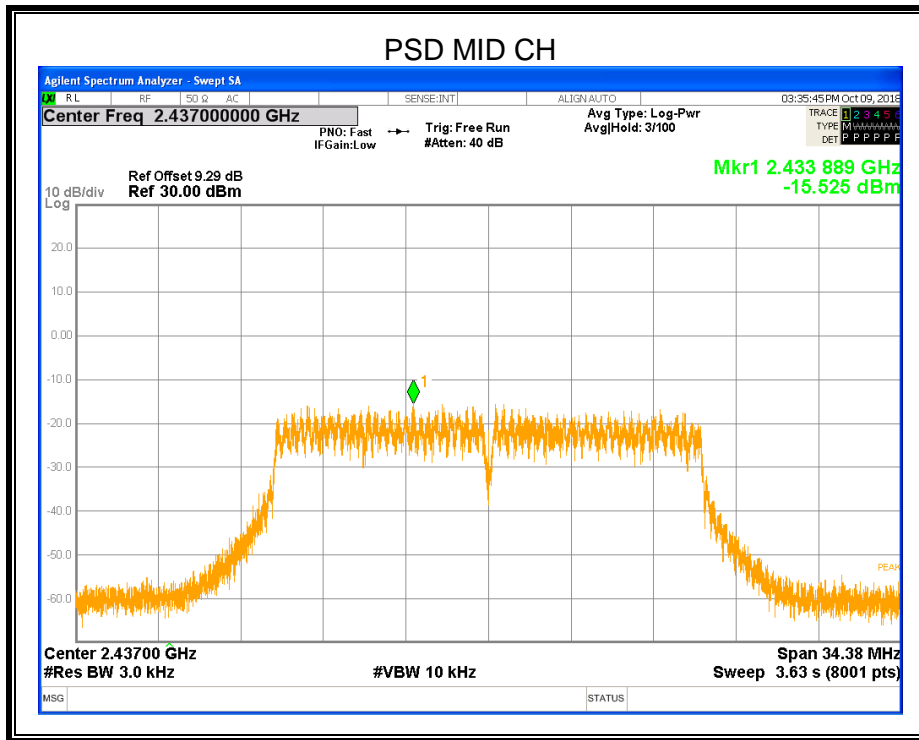



**8.4.4. 802.11n HT40 MODE**

Test Channel	Power Spectral Density (dBm/3kHz)	Limit (dBm/3kHz)	Result
Low	-21.240	8	PASS
Middle	-18.051	8	PASS
High	-19.479	8	PASS

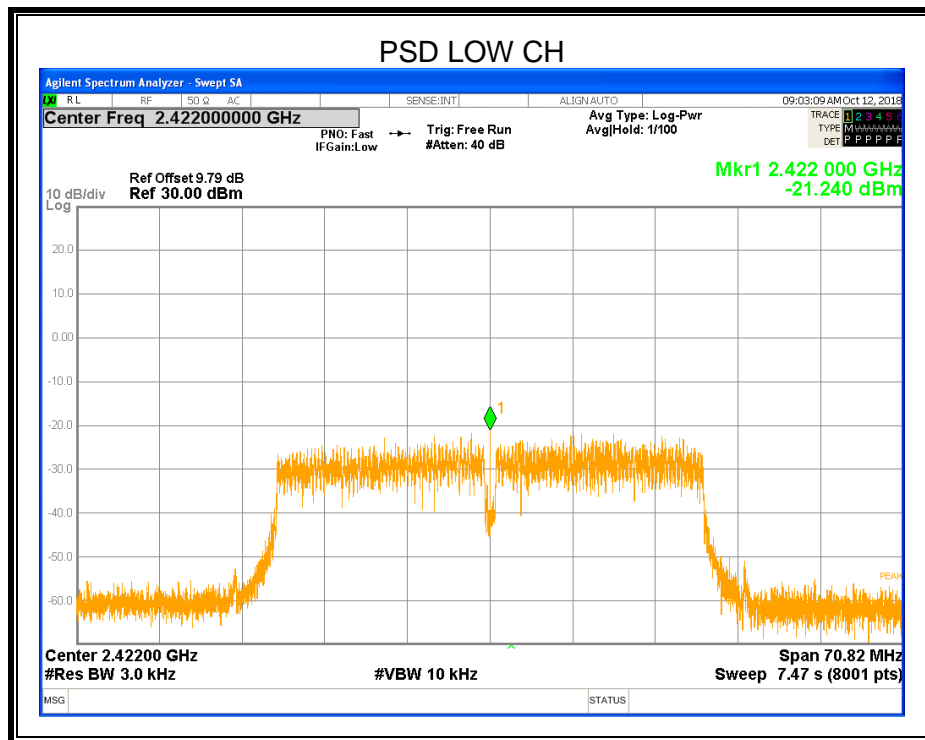

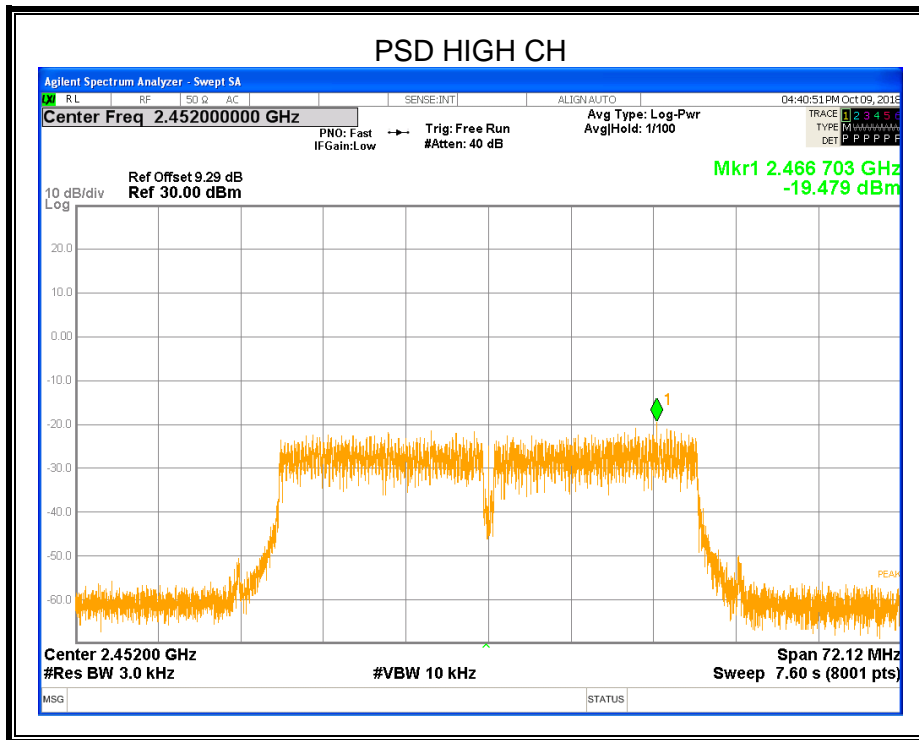
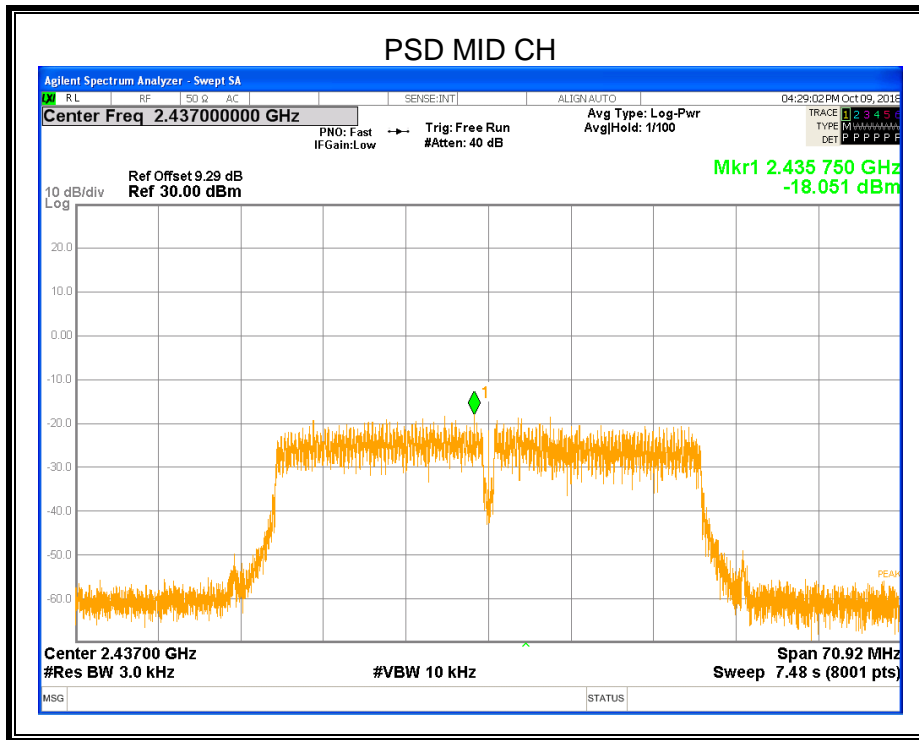



## 8.5. CONDUCTED BANDEGE AND SPURIOUS EMISSIONS

### LIMITS

CFR 47 FCC Part15 (15.247) Subpart C ISED RSS-247 ISSUE 2		
Section	Test Item	Limit
CFR 47 FCC §15.247 (d) ISED RSS-247 5.5	Conducted Bandedge and Spurious Emissions	at least 20 dB below that in the 100 kHz bandwidth within the band that contains the highest level of the desired power

### TEST PROCEDURE

Connect the UUT to the spectrum analyser and use the following settings:

Center Frequency	The centre frequency of the channel under test
Detector	Peak
RBW	100K
VBW	$\geq 3 \times \text{RBW}$
Span	1.5 x DTS bandwidth
Trace	Max hold
Sweep time	Auto couple.

Use the peak marker function to determine the maximum PSD level.

Span	Set the center frequency and span to encompass frequency range to be measured
Detector	Peak
RBW	100K
VBW	$\geq 3 \times \text{RBW}$
measurement points	$\geq \text{span}/\text{RBW}$
Trace	Max hold
Sweep time	Auto couple.

Use the peak marker function to determine the maximum amplitude level.



**TEST SETUP**

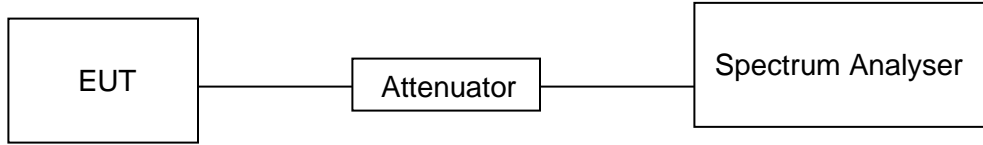

**TEST ENVIRONMENT**

Temperature	24.3°C	Relative Humidity	58%
Atmosphere Pressure	101kPa	Test Voltage	AC120V

**RESULTS**

**8.5.1. 802.11b MODE**

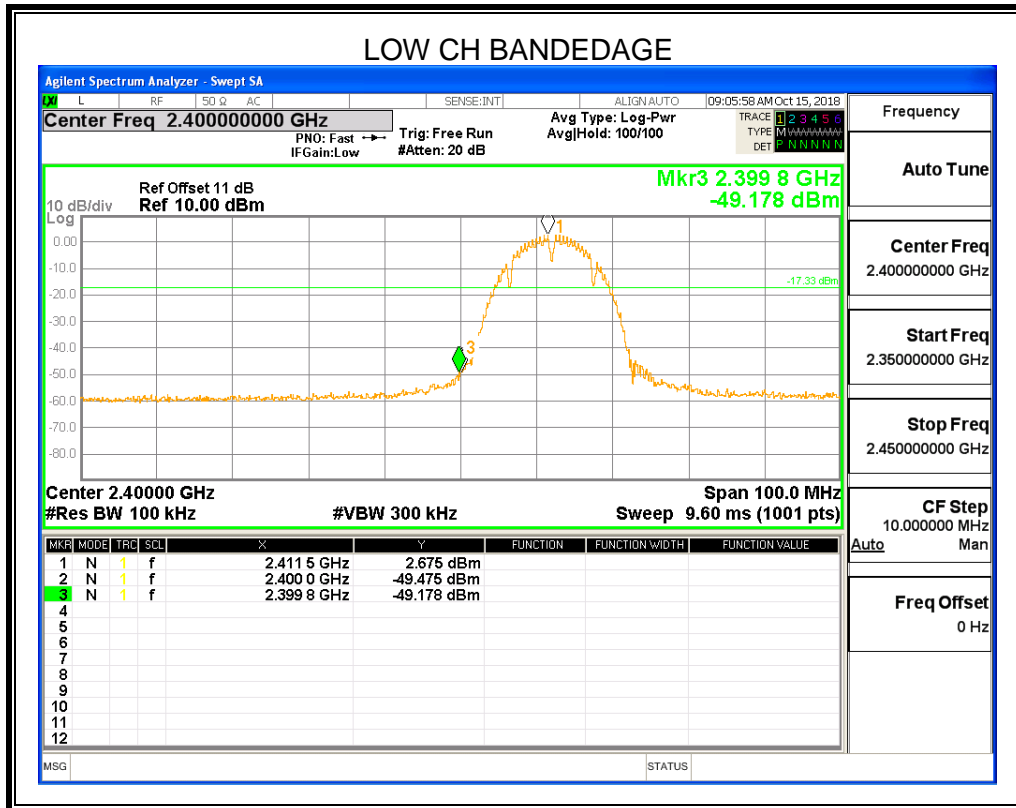

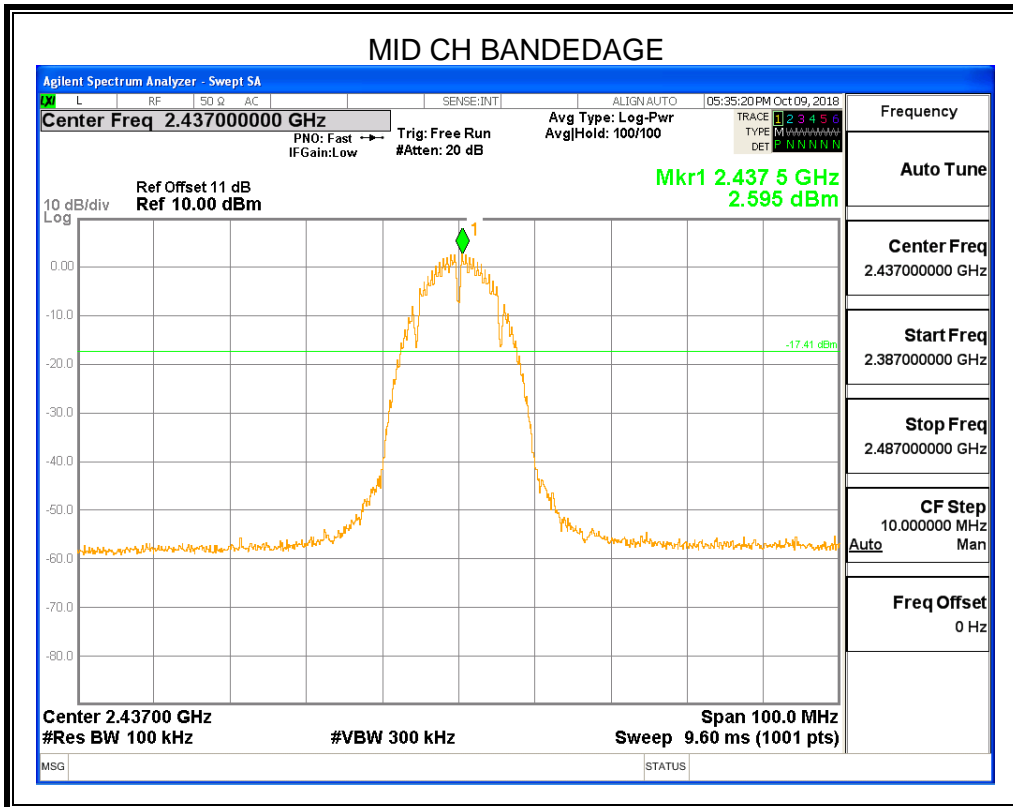
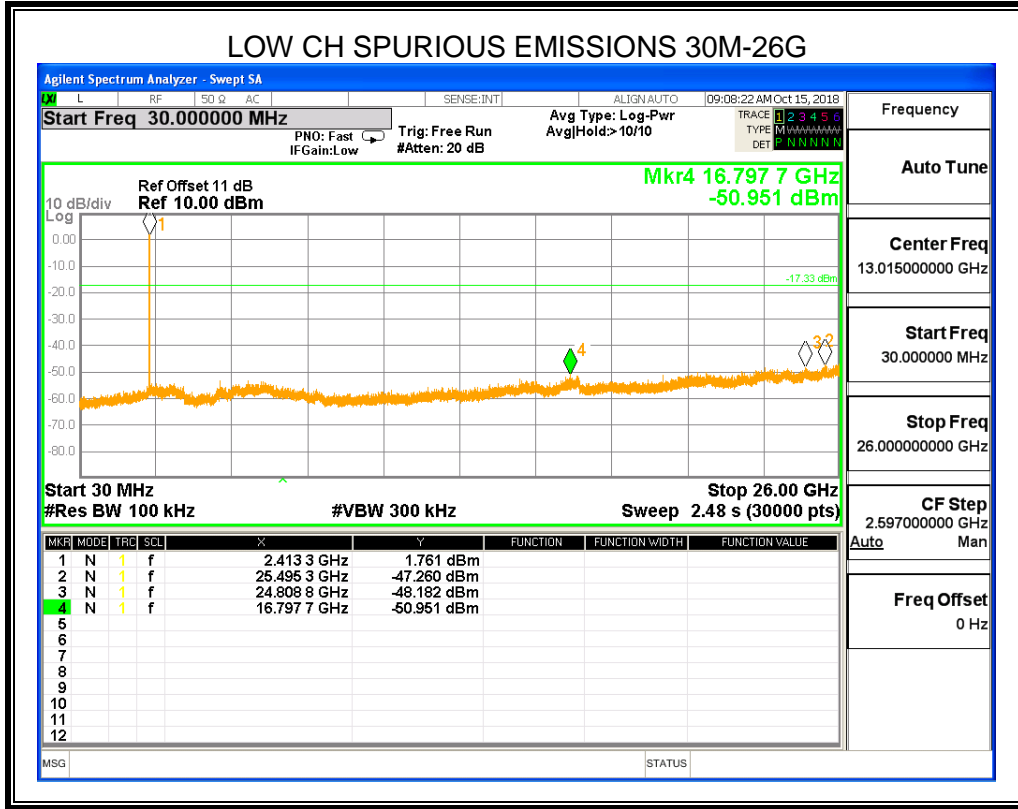



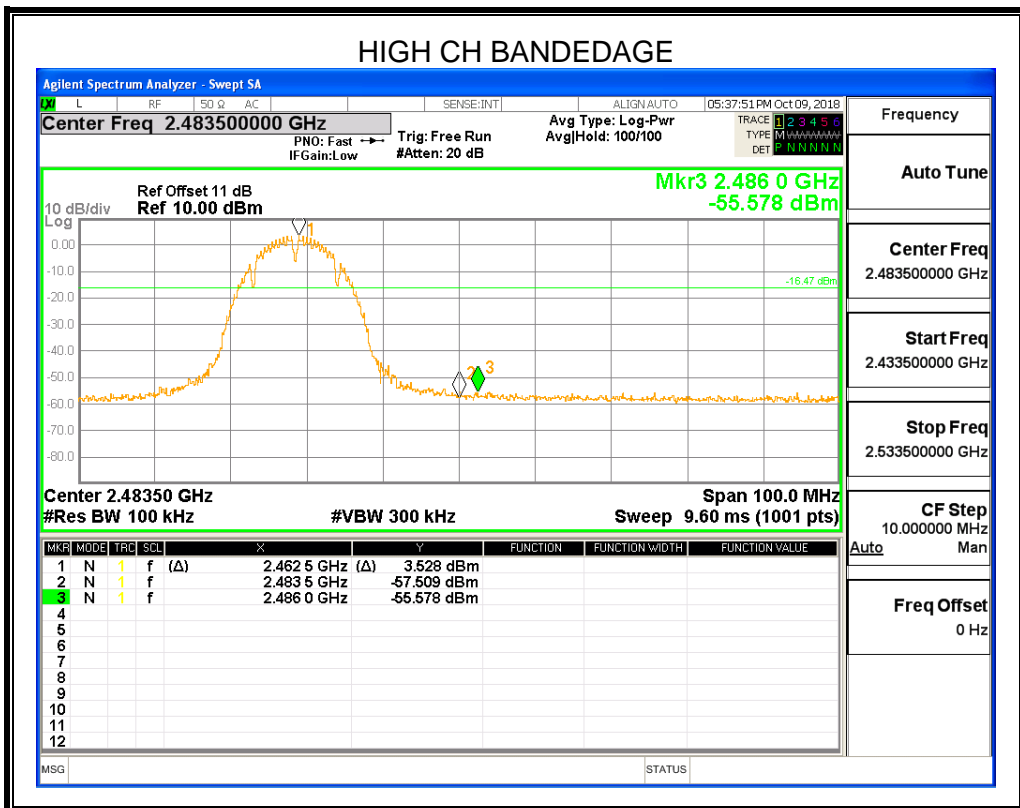
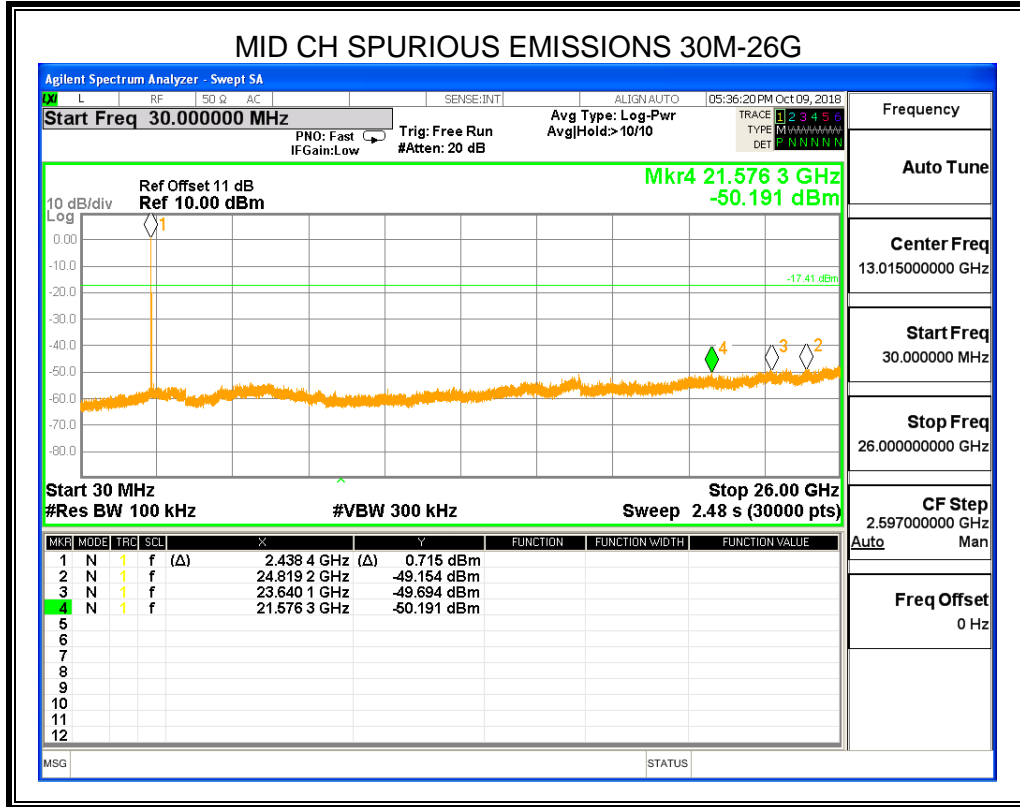

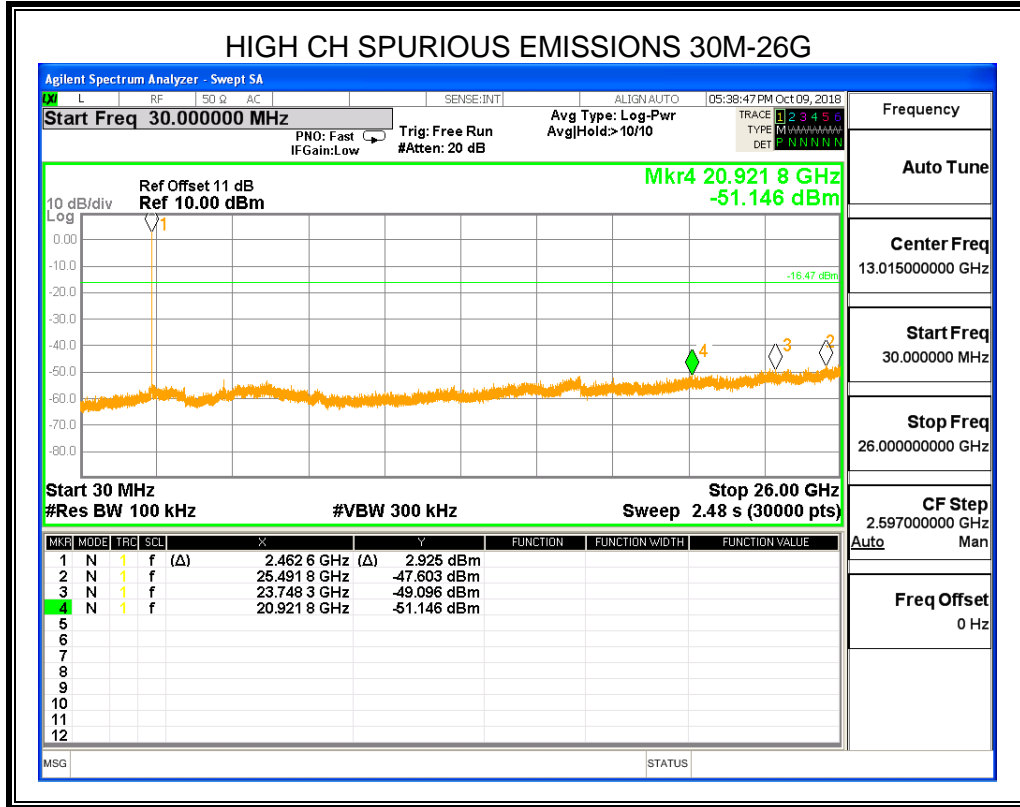



### 8.5.2. 802.11g MODE

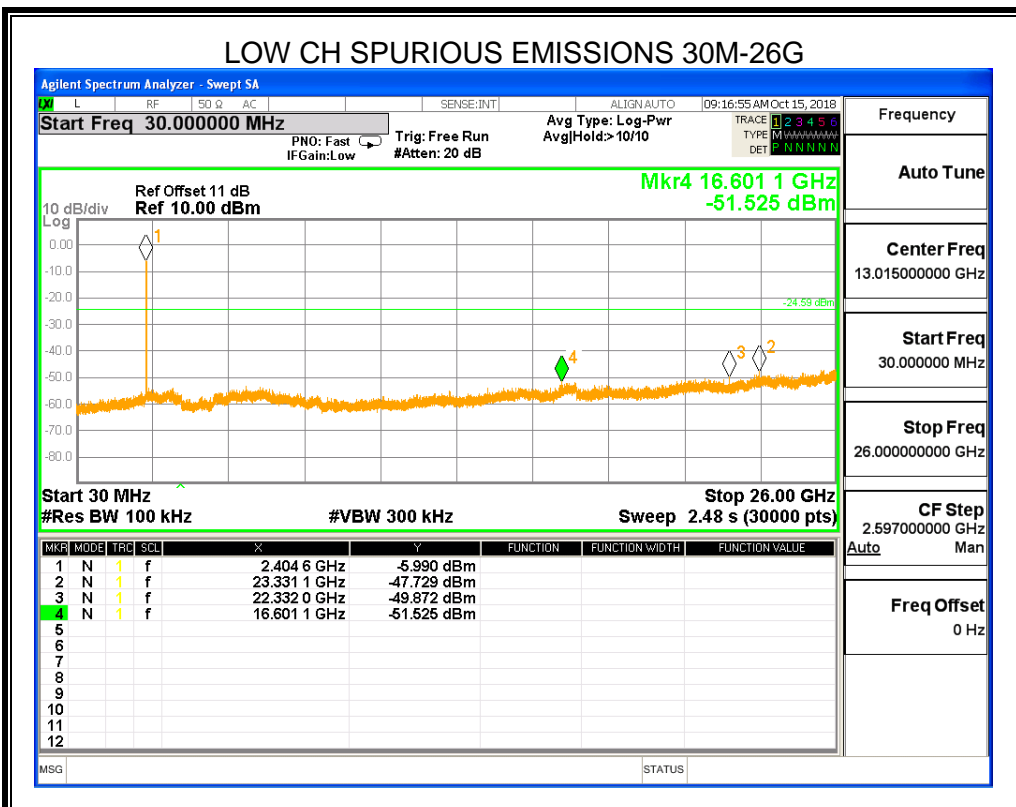
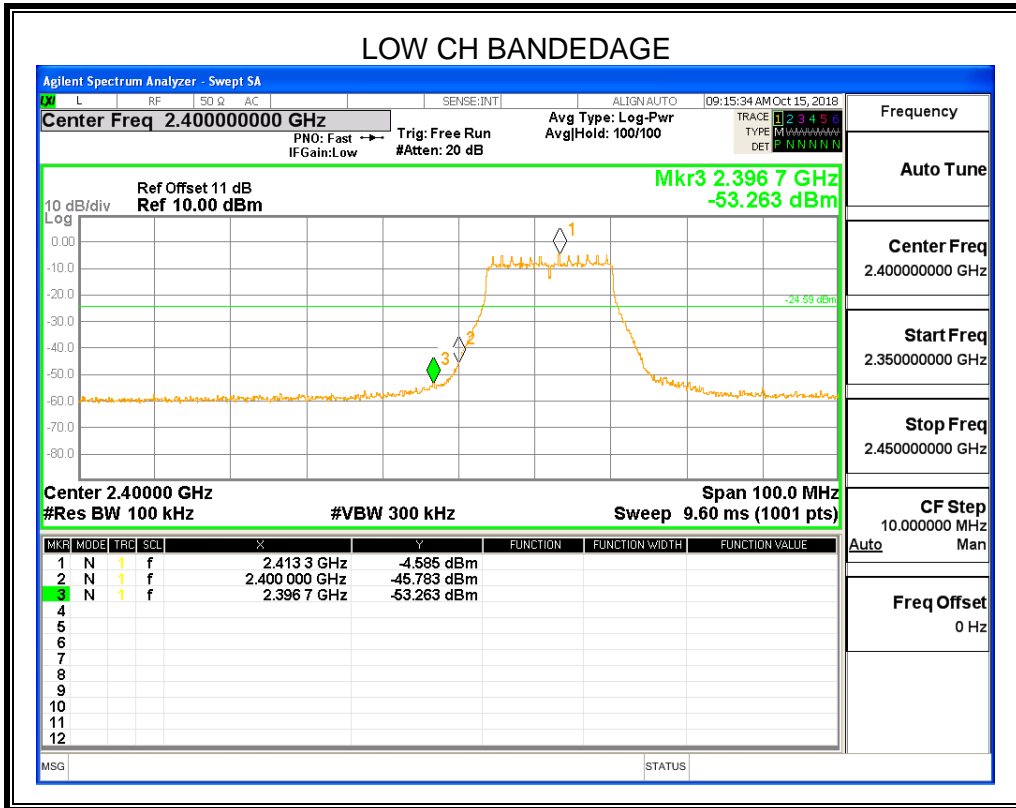

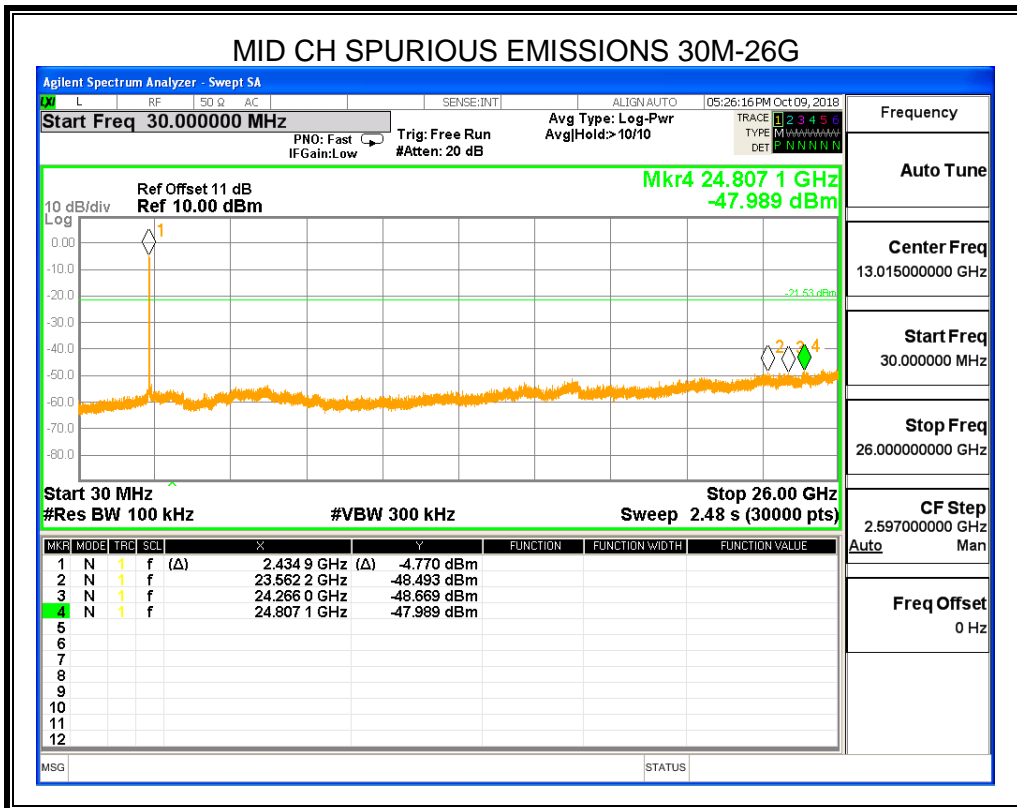
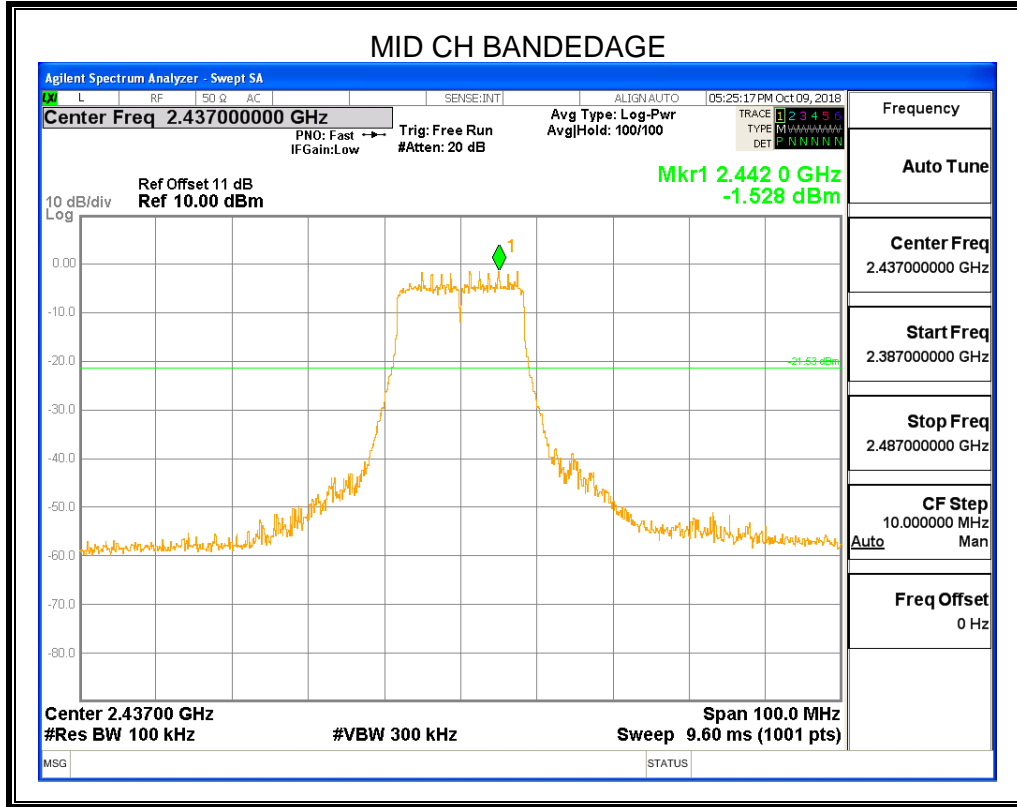

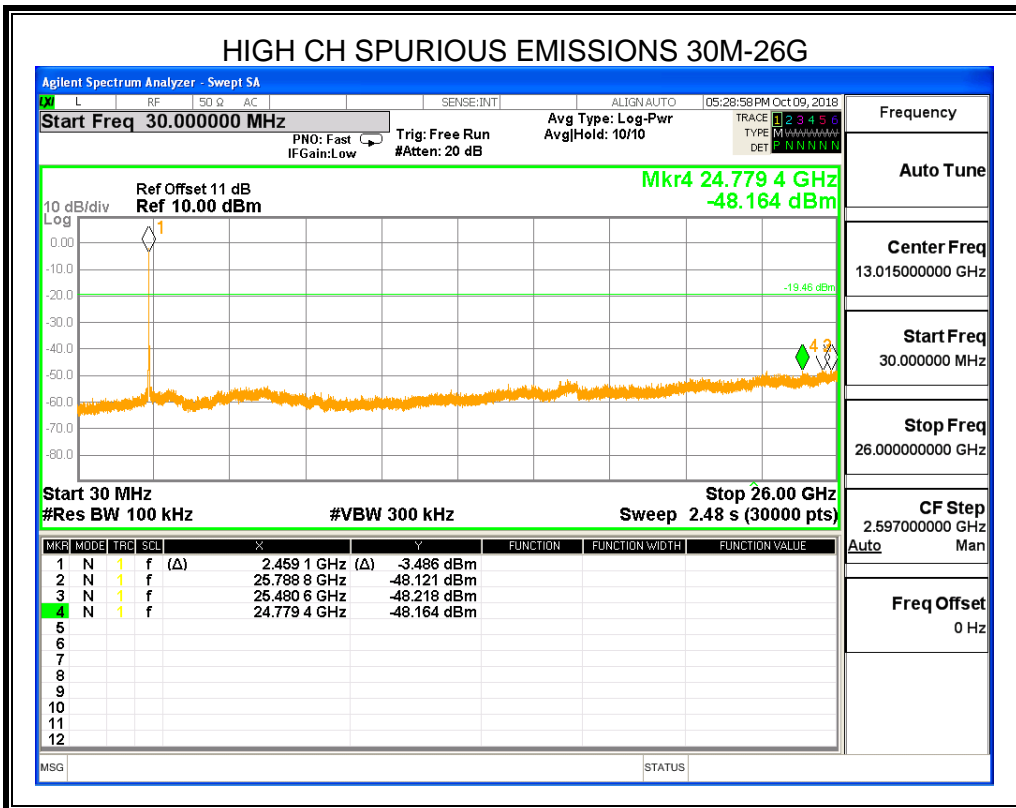
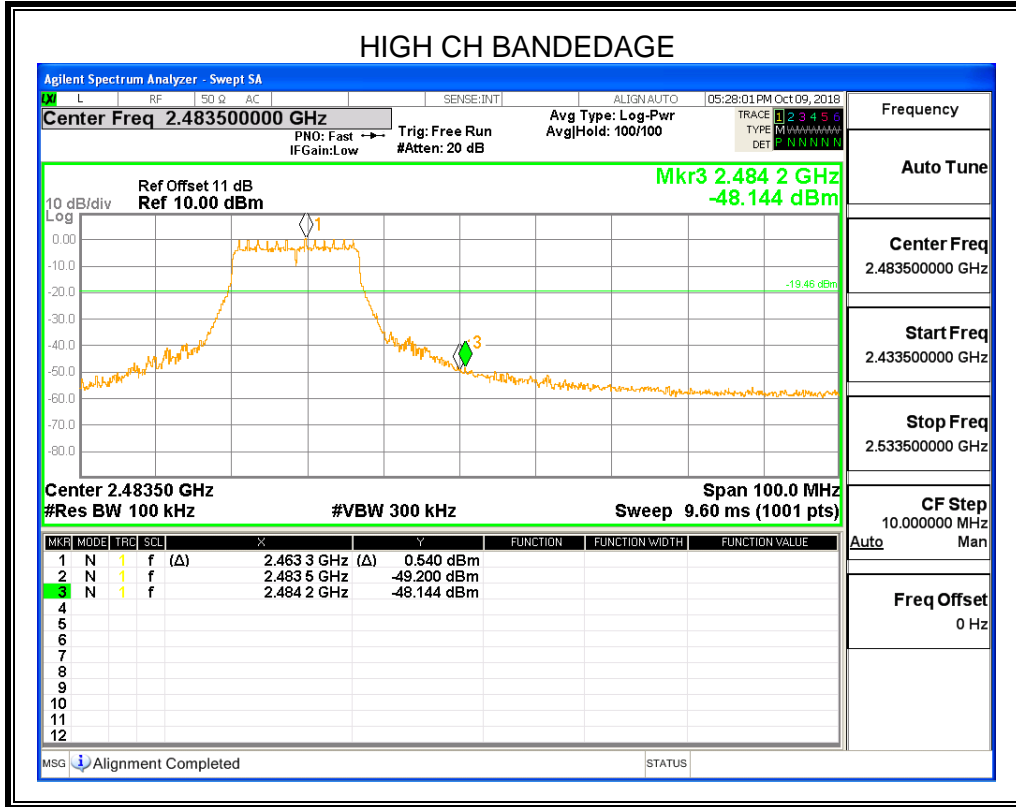



### 8.5.3. 802.11n HT20 MODE

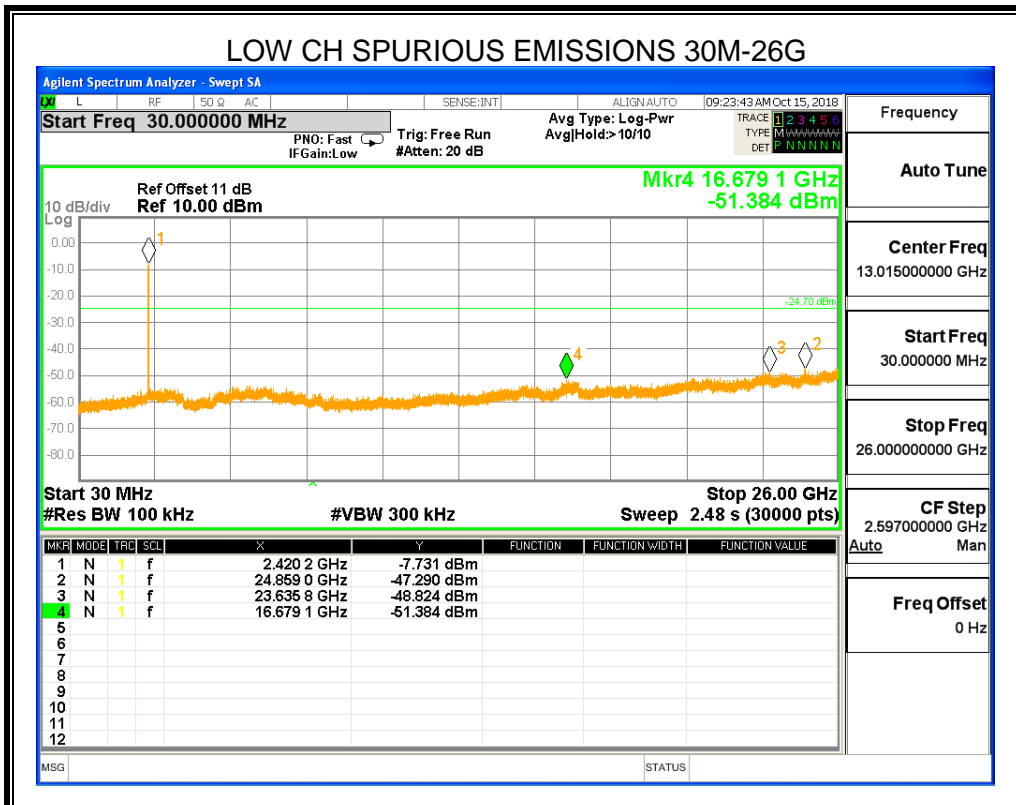
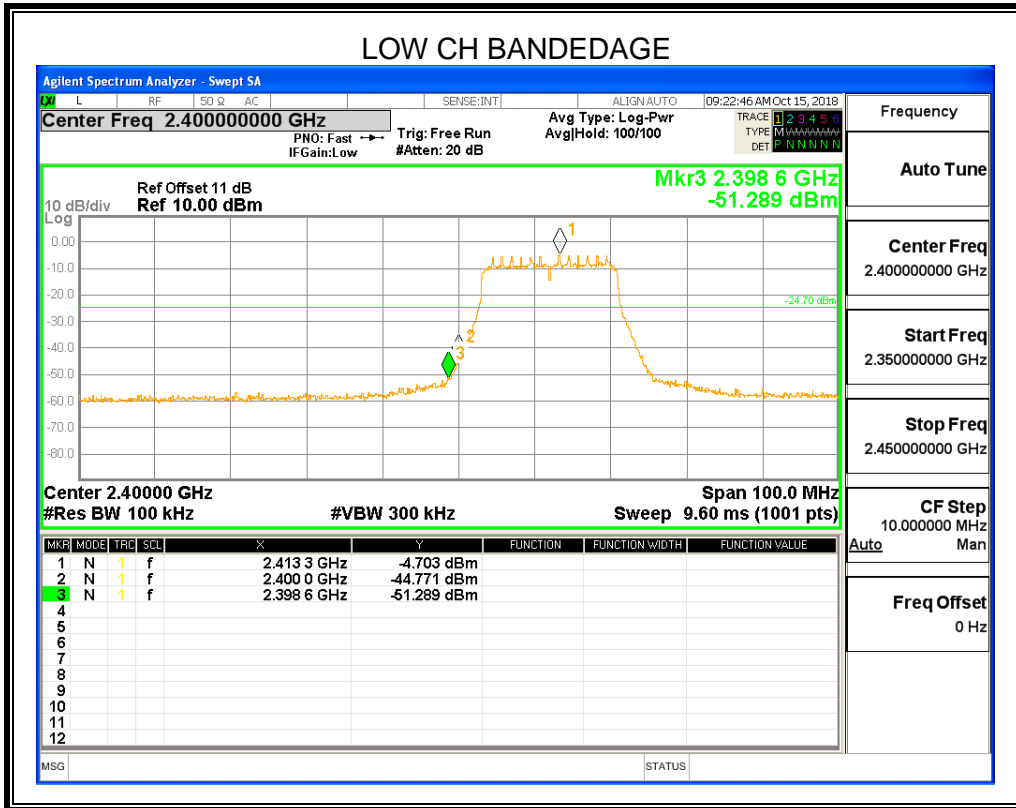

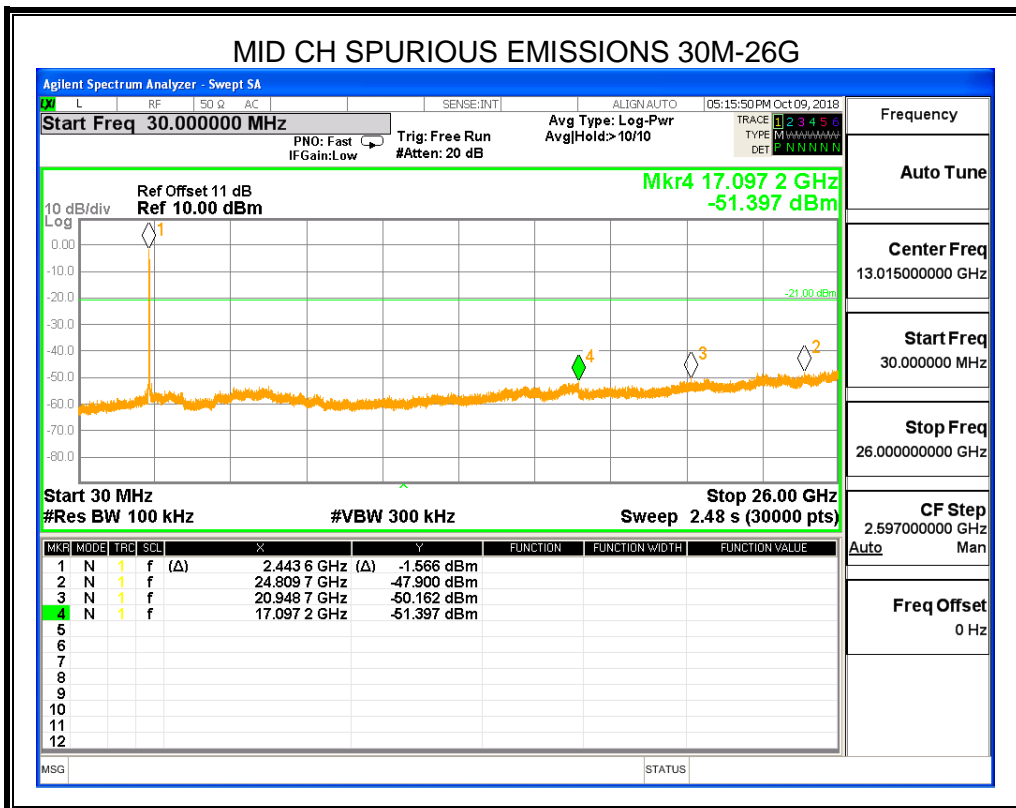
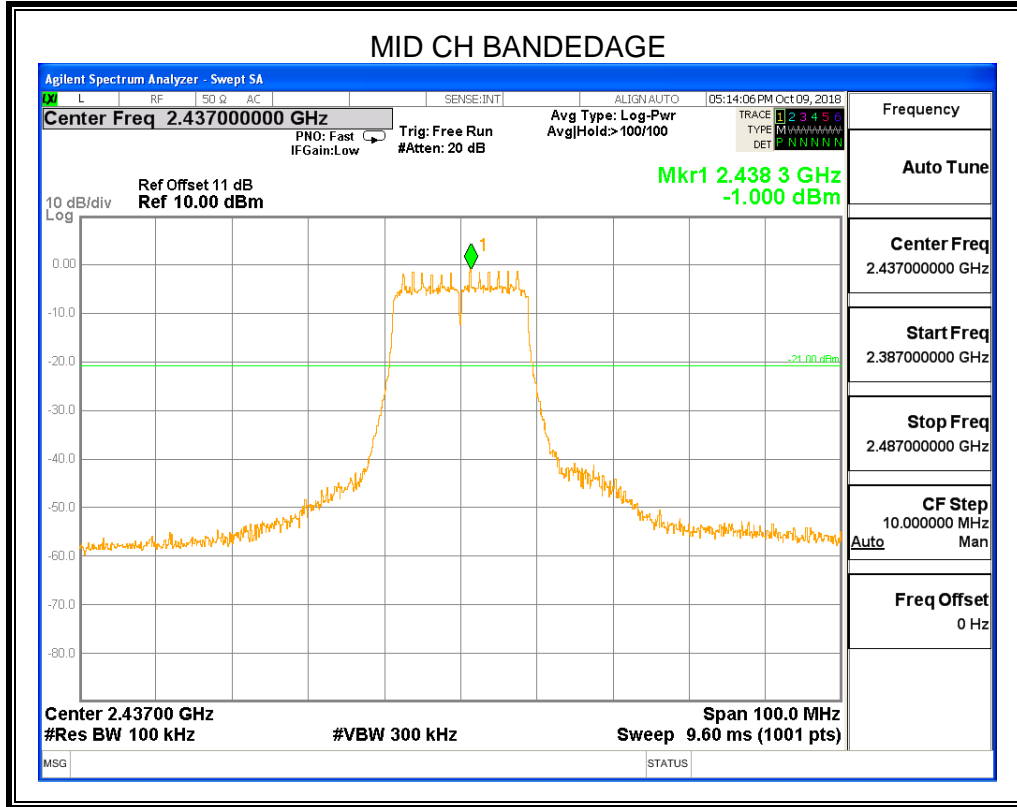

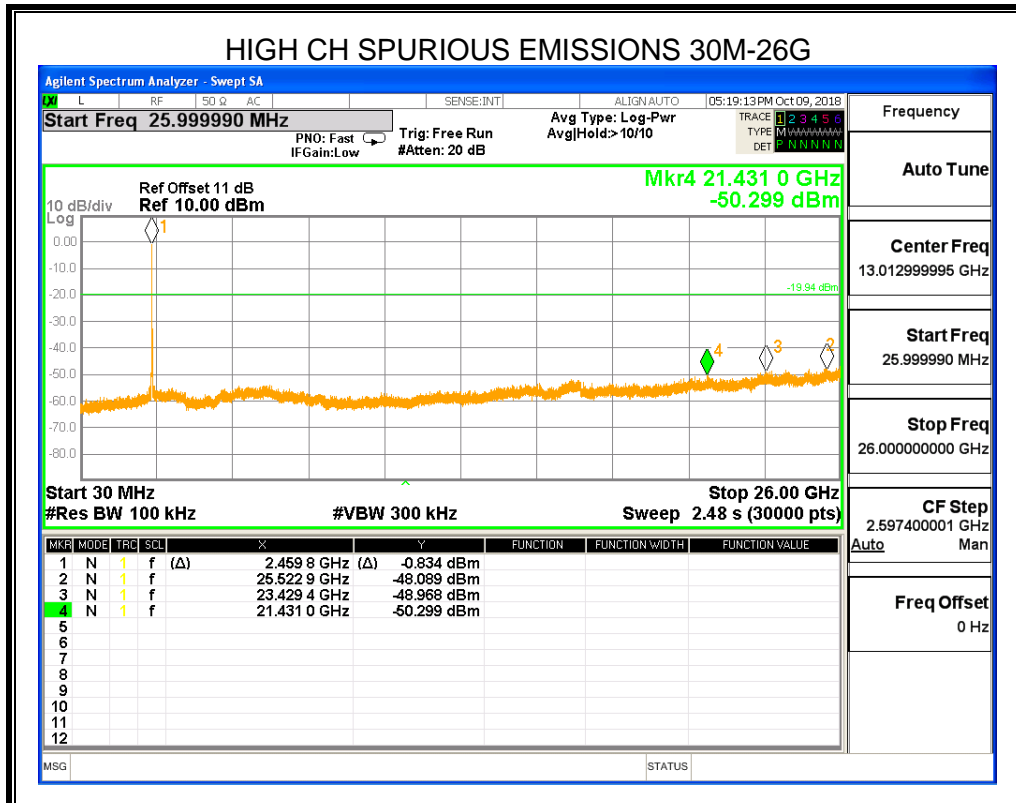
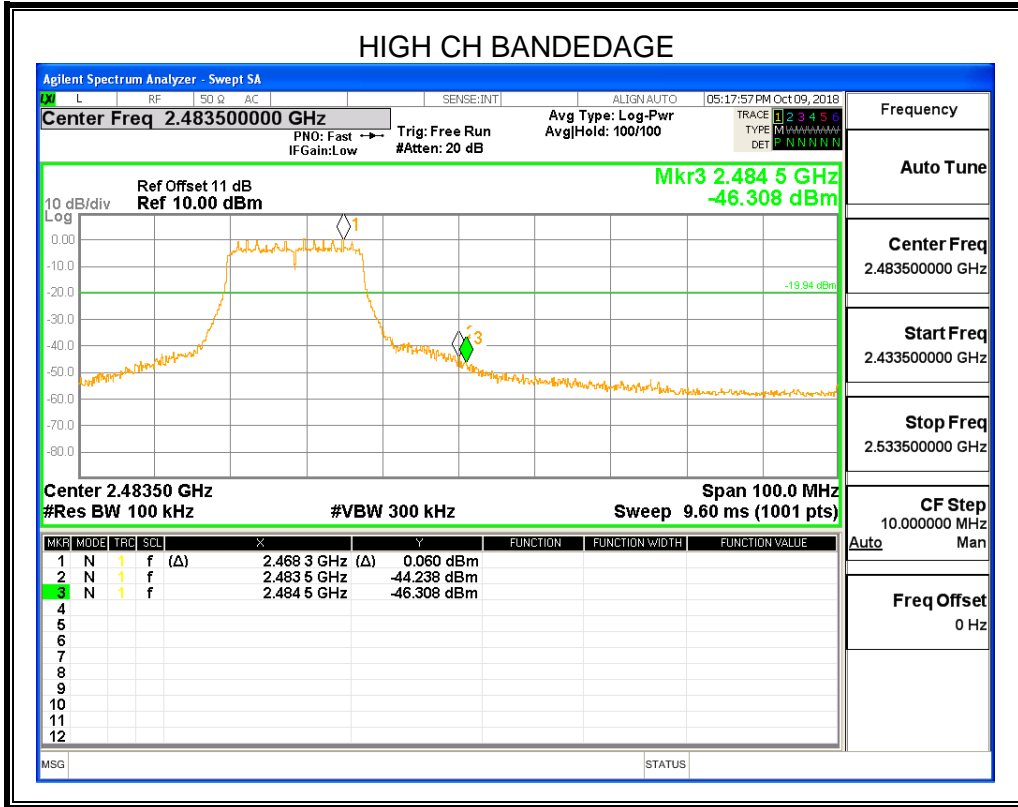





### 8.5.4. 802.11n HT40 MODE

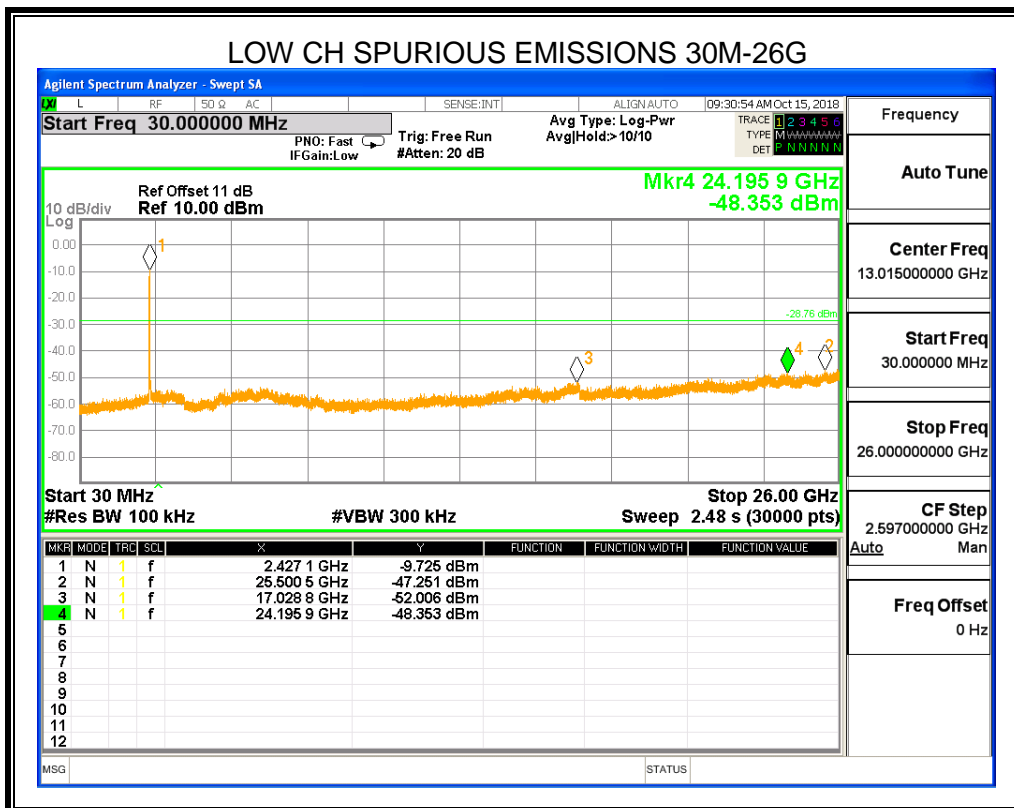
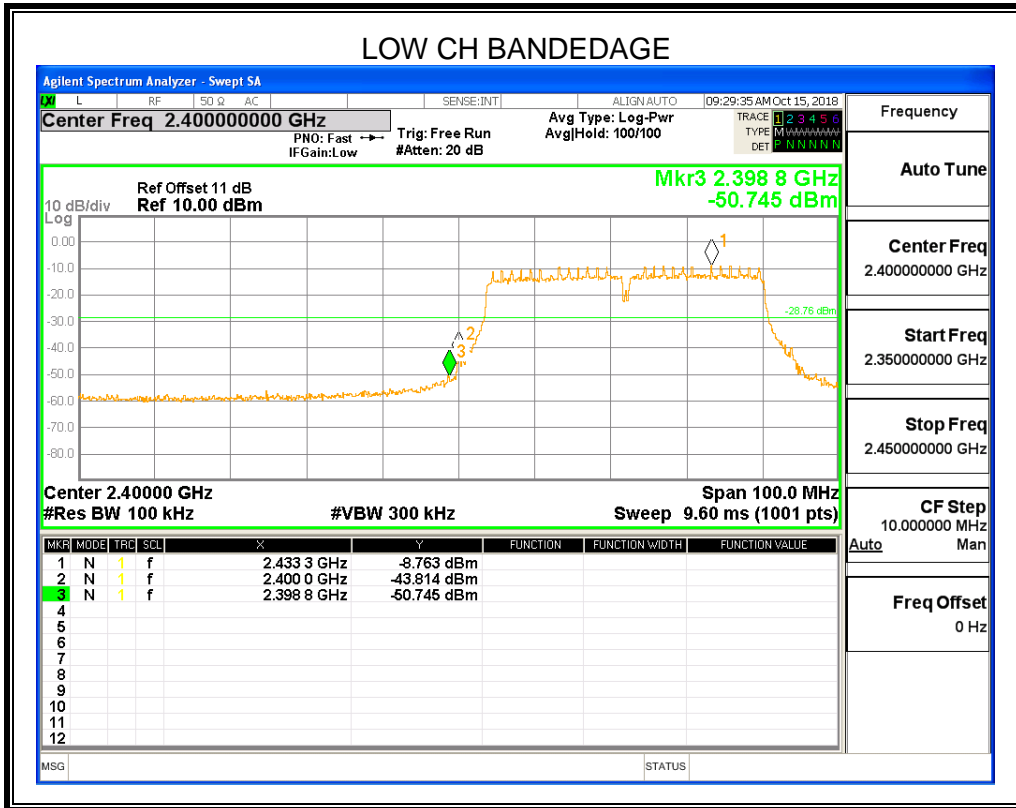

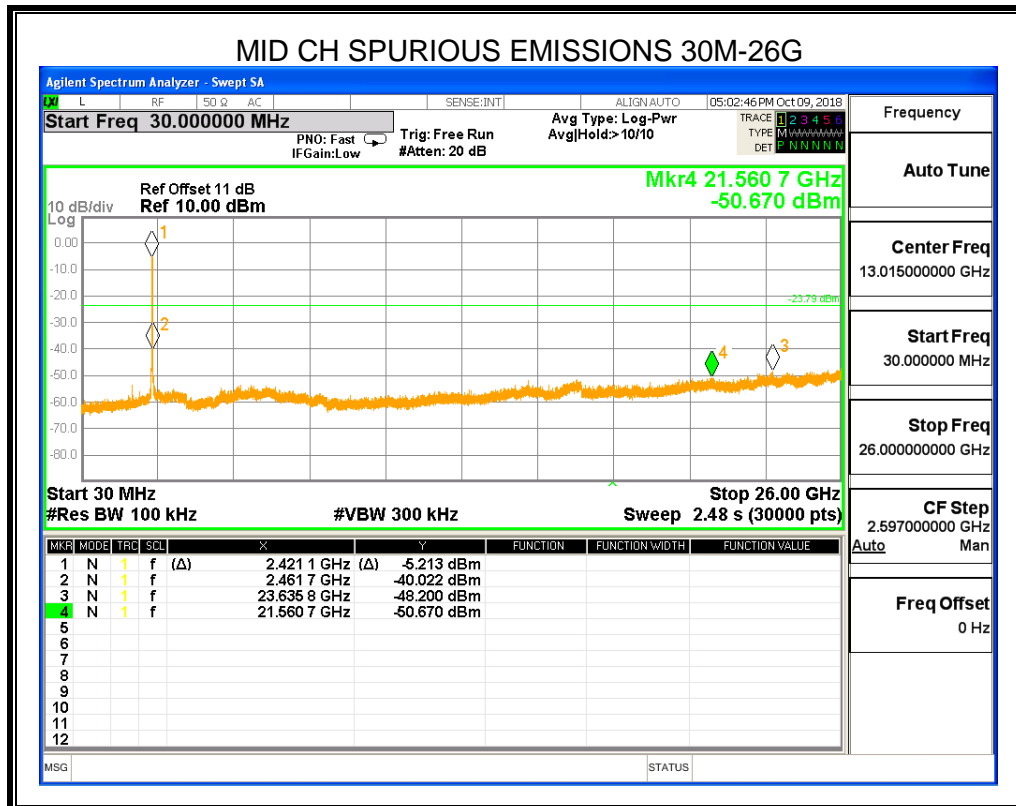
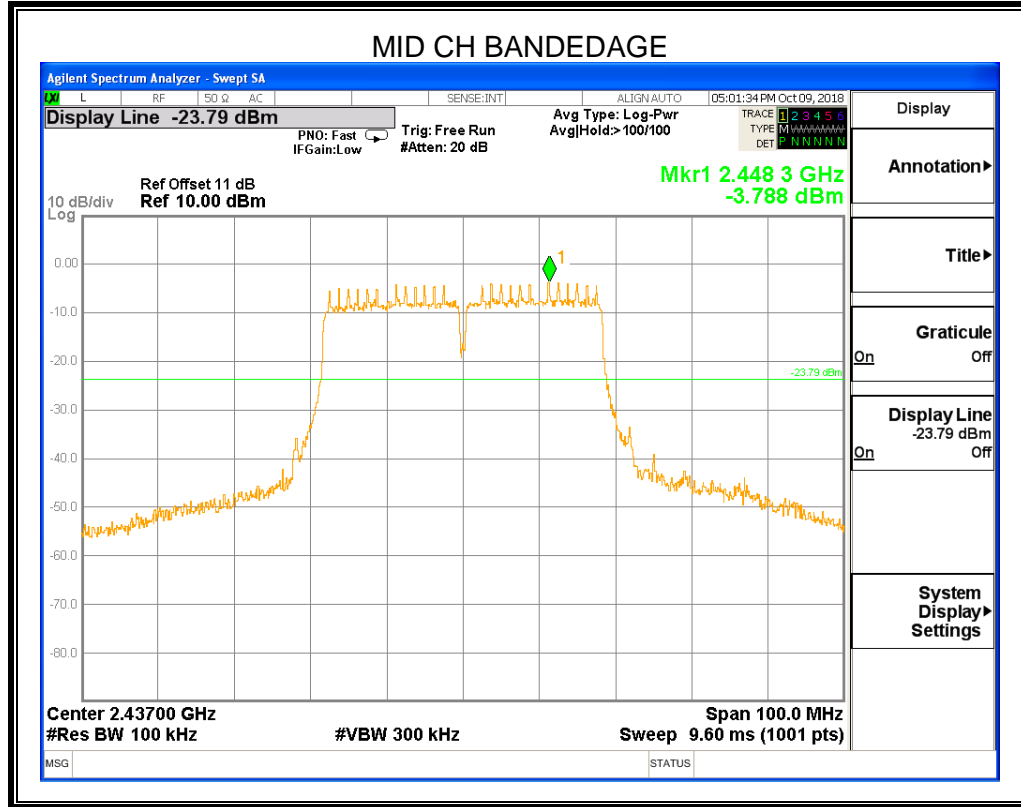

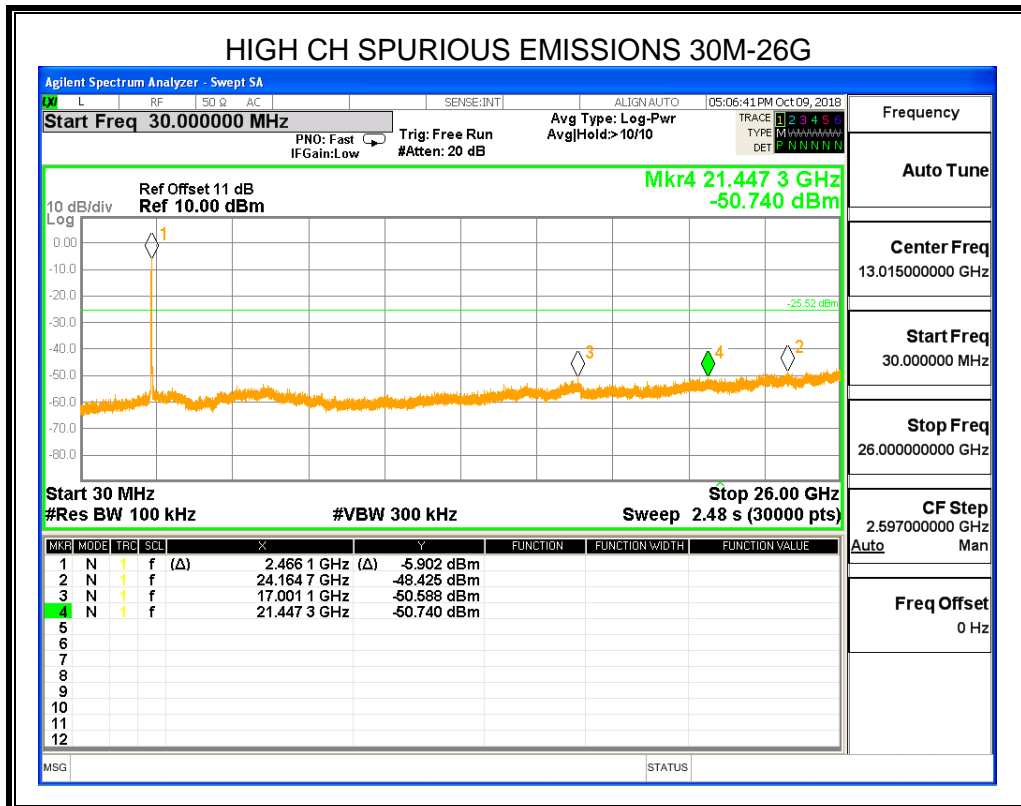
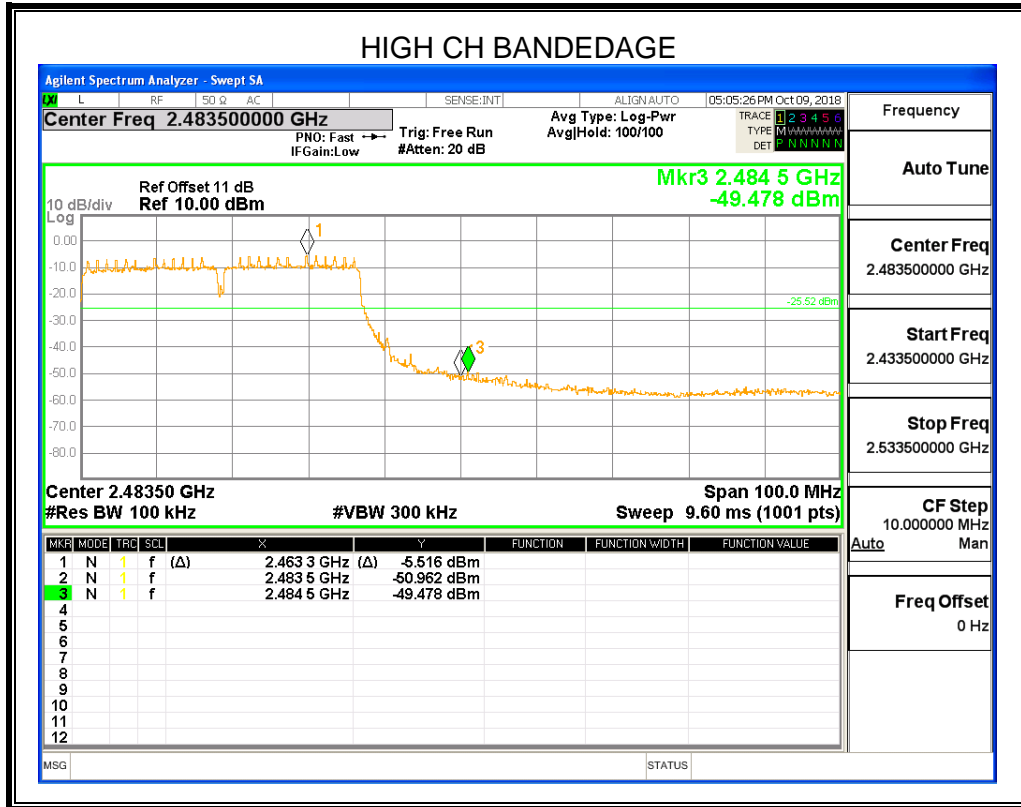



## 9. RADIATED TEST RESULTS

### LIMITS

Please refer to CFR 47 FCC §15.205 and §15.209

Please refer to ISED RSS-GEN Clause 8.9 (Transmitter)

Radiation Disturbance Test Limit for FCC (Class B)(9KHz-1GHz)

Frequency (MHz)	Field Strength (microvolts/meter)	Measurement Distance (meters)
0.009~0.490	2400/F(KHz)	300
0.490~1.705	24000/F(KHz)	30
1.705~30.0	30	30
30~88	100	3
88~216	150	3
216~960	200	3
960~1000	500	3

Note: 1) At frequencies at or above 30 MHz, measurements may be performed at a distance other than what is specified provided: measurements are not made in the near field except where it can be shown that near field measurements are appropriate due to the characteristics of the device; and it can be demonstrated that the signal levels needed to be measured at the distance employed can be detected by the measurement equipment. Measurements shall not be performed at a distance greater than 30 meters unless it can be further demonstrated that measurements at a distance of 30 meters or less are impractical. When performing measurements at a distance other than that specified, the results shall be extrapolated to the specified distance using an extrapolation factor of 20 dB/decade (inverse linear-distance for field strength measurements; inverse-linear-distance-squared for power density measurements).

(2) At frequencies below 30 MHz, measurements may be performed at a distance closer than that specified in the regulations; however, an attempt should be made to avoid making measurements in the near field. Pending the development of an appropriate measurement procedure for measurements performed below 30 MHz, when performing measurements at a closer distance than specified, the results shall be extrapolated to the specified distance by either making measurements at a minimum of two distances on at least one radial to determine the proper extrapolation factor or by using the square of an inverse linear distance extrapolation factor (40 dB/decade). This paragraph (f) shall not apply to Access BPL devices operating below 30 MHz.



Radiation Disturbance Test Limit for FCC (Above 1G)

Frequency (MHz)	dB(uV/m) (at 3 meters)	
	Peak	Average
Above 1000	74	54

IC Restricted bands please refer to ISED RSS-GEN Clause 8.10

FCC Restricted bands of operation:

MHz	MHz	MHz	GHz
0.090-0.110	16.42-16.423	399.9-410	4.5-5.15
<sup>1</sup> 0.495-0.505	16.69475-16.69525	608-614	5.35-5.46
2.1735-2.1905	16.80425-16.80475	960-1240	7.25-7.75
4.125-4.128	25.5-25.67	1300-1427	8.025-8.5
4.17725-4.17775	37.5-38.25	1435-1626.5	9.0-9.2
4.20725-4.20775	73-74.6	1645.5-1646.5	9.3-9.5
6.215-6.218	74.8-75.2	1660-1710	10.6-12.7
6.26775-6.26825	108-121.94	1718.8-1722.2	13.25-13.4
6.31175-6.31225	123-138	2200-2300	14.47-14.5
8.291-8.294	149.9-150.05	2310-2390	15.35-16.2
8.362-8.366	156.52475-156.52525	2483.5-2500	17.7-21.4
8.37625-8.38675	156.7-156.9	2690-2900	22.01-23.12
8.41425-8.41475	162.0125-167.17	3260-3267	23.6-24.0
12.29-12.293	167.72-173.2	3332-3339	31.2-31.8
12.51975-12.52025	240-285	3345.8-3358	36.43-36.5
12.57675-12.57725	322-335.4	3600-4400	( <sup>2</sup> )
13.36-13.41			

Note: <sup>1</sup>Until February 1, 1999, this restricted band shall be 0.490-0.510 MHz.

<sup>2</sup>Above 38.6c

**TEST SETUP AND PROCEDURE**

Below 30MHz

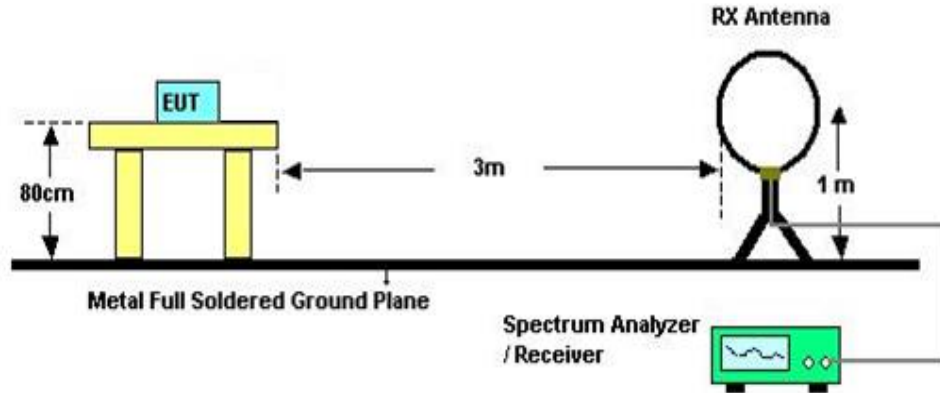

The setting of the spectrum analyser

RBW	200Hz (From 9kHz to 0.15MHz)/ 9KHz (From 0.15MHz to 30MHz)
VBW	200Hz (From 9kHz to 0.15MHz)/ 9KHz (From 0.15MHz to 30MHz)
Sweep	Auto
Detector	Peak/QP/ Average
Trace	Max hold

1. The testing follows the guidelines in ANSI C63.10-2013
2. The EUT was arranged to its worst case and then turntable (from 0 degree to 360 degrees) to find the maximum reading. A pre-amp and a high pass filter are used for the test in order to get better signal level. Both horizontal and vertical polarizations of the antenna are set to make the measurement.
3. The EUT was placed on a turntable with 0.8 meter above ground.
4. The EUT was set 3 meters from the interference receiving antenna, which was mounted on the top of a variable height antenna tower.
5. For measurement below 1GHz, the initial step in collecting conducted emission data is a spectrum analyzer peak detector mode pre-scanning the measurement frequency range. Significant peaks are then marked and then Quasi Peak detector mode re-measured. If the emission level of the EUT measured by the peak detector is 3 dB lower than the applicable limit, the peak emission level will be reported. Otherwise, the emission measurement will be repeated using the quasi-peak detector and reported.
6. Although these tests were performed other than open area test site, adequate comparison measurements were confirmed against 30m open are test site. Therefore sufficient tests were made to demonstrate that the alternative site produces results that correlate with the ones of tests made in an open field based on KDB 414788.

Below 1G

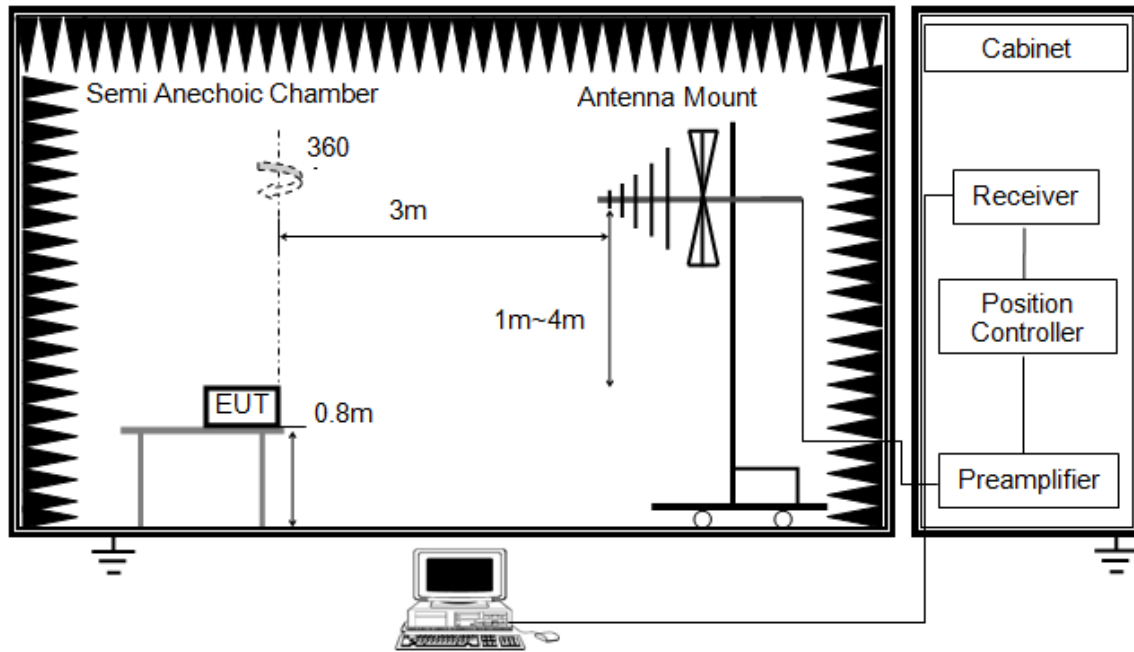

The setting of the spectrum analyser

RBW	120K
VBW	300K
Sweep	Auto
Detector	Peak/QP
Trace	Max hold

1. The testing follows the guidelines in ANSI C63.10-2013.
2. The EUT was arranged to its worst case and then tune the antenna tower (from 1 m to 4 m) and turntable (from 0 degree to 360 degrees) to find the maximum reading. A pre-amp and a high pass filter are used for the test in order to get better signal level. Both horizontal and vertical polarizations of the antenna are set to make the measurement.
3. The EUT was placed on a turntable with 0.8 meter above ground.
4. The EUT was set 3 meters from the interference receiving antenna, which was mounted on the top of a variable height antenna tower.
5. For measurement below 1GHz, the initial step in collecting conducted emission data is a spectrum analyzer peak detector mode pre-scanning the measurement frequency range. Significant peaks are then marked and then Quasi Peak detector mode re-measured. If the emission level of the EUT measured by the peak detector is 3 dB lower than the applicable limit, the peak emission level will be reported. Otherwise, the emission measurement will be repeated using the quasi-peak detector and reported.

ABOVE 1G

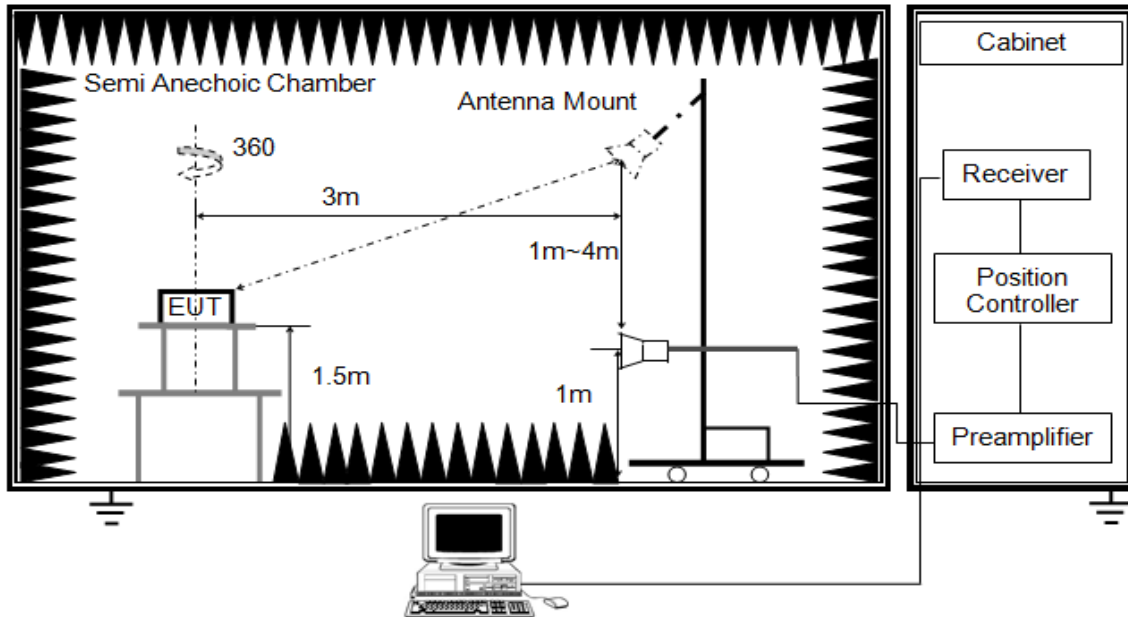

The setting of the spectrum analyser

RBW	1M
VBW	PEAK: 3M AVG: see note 6
Sweep	Auto
Detector	Peak
Trace	Max hold

1. The testing follows the guidelines in ANSI C63.10-2013.
2. The EUT was arranged to its worst case and then tune the antenna tower (from 1 m to 4 m) and turntable (from 0 degree to 360 degrees) to find the maximum reading. A pre-amp and a high pass filter are used for the test in order to get better signal level. Both horizontal and vertical polarizations of the antenna are set to make the measurement.
3. The EUT was placed on a turntable with 1.5m above ground.
4. The EUT was set 3 meters from the interference receiving antenna, which was mounted on the top of a variable height antenna tower.
5. For measurement above 1GHz, the emission measurement will be measured by the peak detector. This peak level, once corrected, must comply with the limit specified in Section 15.209.
6. For measurements above 1 GHz the resolution bandwidth is set to 1 MHz, then the video bandwidth is set to 3 MHz for peak measurements and 1 MHz resolution bandwidth with 1/T video bandwidth with peak detector for average measurements. For the Duty Cycle please refer to clause 8.1.ON TIME AND DUTY CYCLE.



X axis, Y axis, Z axis positions:

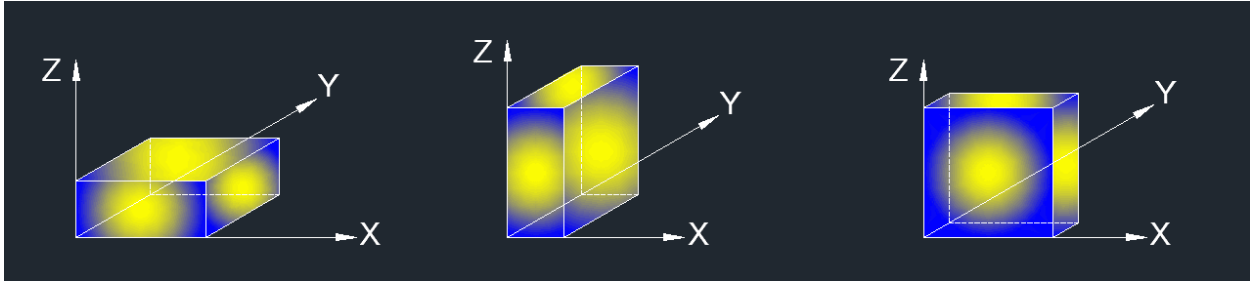

Note 1: For all radiated test, EUT in each of three orthogonal axis emissions had been tested, but only the worst case (X axis) data recorded in the report.

Note 2: The EUT was fully exercised with external accessories during the test. In the case of multiple accessory external ports, an external accessory shall be connected to one of each type of port.

**TEST ENVIRONMENT**

Temperature	24.1°C	Relative Humidity	54%
Atmosphere Pressure	101kPa	Test Voltage	AC120V



### 9.1. RESTRICTED BANDEDGE

#### 9.1.1. 802.11b MODE

##### RESTRICTED BANDEDGE (LOW CHANNEL, HORIZONTAL)

##### PEAK

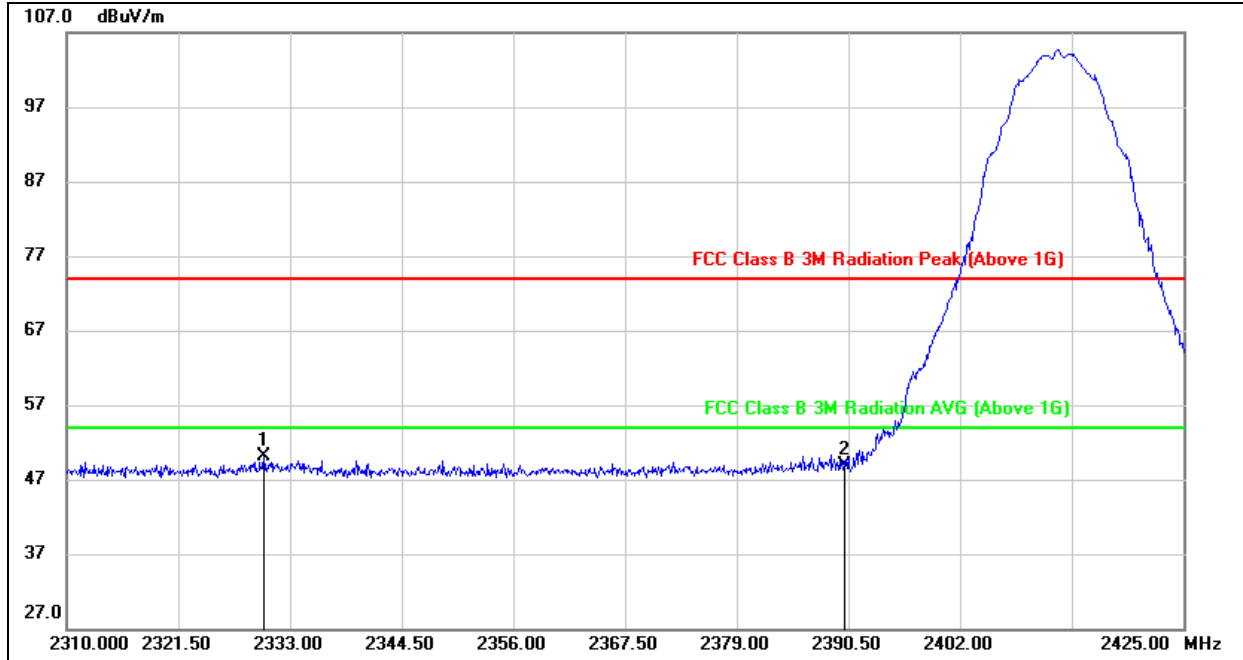

No.	Frequency (MHz)	Reading (dBuV)	Correct (dB/m)	Result (dBuV/m)	Limit (dBuV/m)	Margin (dB)	Remark
1	2330.240	16.52	33.57	50.09	74.00	-23.91	peak
2	2390.000	15.71	33.14	48.85	74.00	-25.15	peak

Note: 1. Measurement = Reading Level + Correct Factor.  
 2. If Peak Result complies with AV limit, AV Result is deemed to comply with AV limit.  
 3. Peak: Peak detector.  
 4. Only the worst case emission was recorded, if it complies with the limit, the other emissions deemed to comply with the limit.



**RESTRICTED BANDEDGE (LOW CHANNEL, VERTICAL)**

**PEAK**

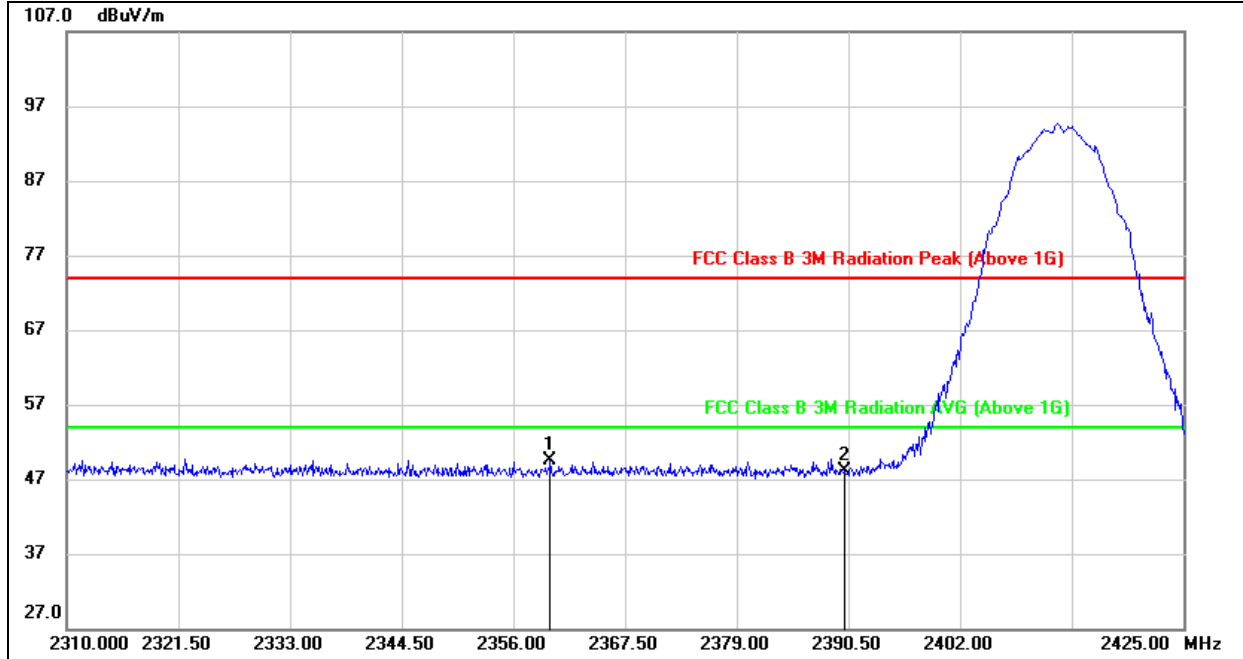

No.	Frequency (MHz)	Reading (dBuV)	Correct (dB/m)	Result (dBuV/m)	Limit (dBuV/m)	Margin (dB)	Remark
1	2359.795	16.07	33.46	49.53	74.00	-24.47	peak
2	2390.000	14.78	33.24	48.02	74.00	-25.98	peak

- Note: 1. Measurement = Reading Level + Correct Factor.  
 2. If Peak Result complies with AV limit, AV Result is deemed to comply with AV limit.  
 3. Peak: Peak detector.  
 4. Only the worst case emission was recorded, if it complies with the limit, the other emissions deemed to comply with the limit.



**RESTRICTED BANDEDGE (HIGH CHANNEL, HORIZONTAL)**

**PEAK**

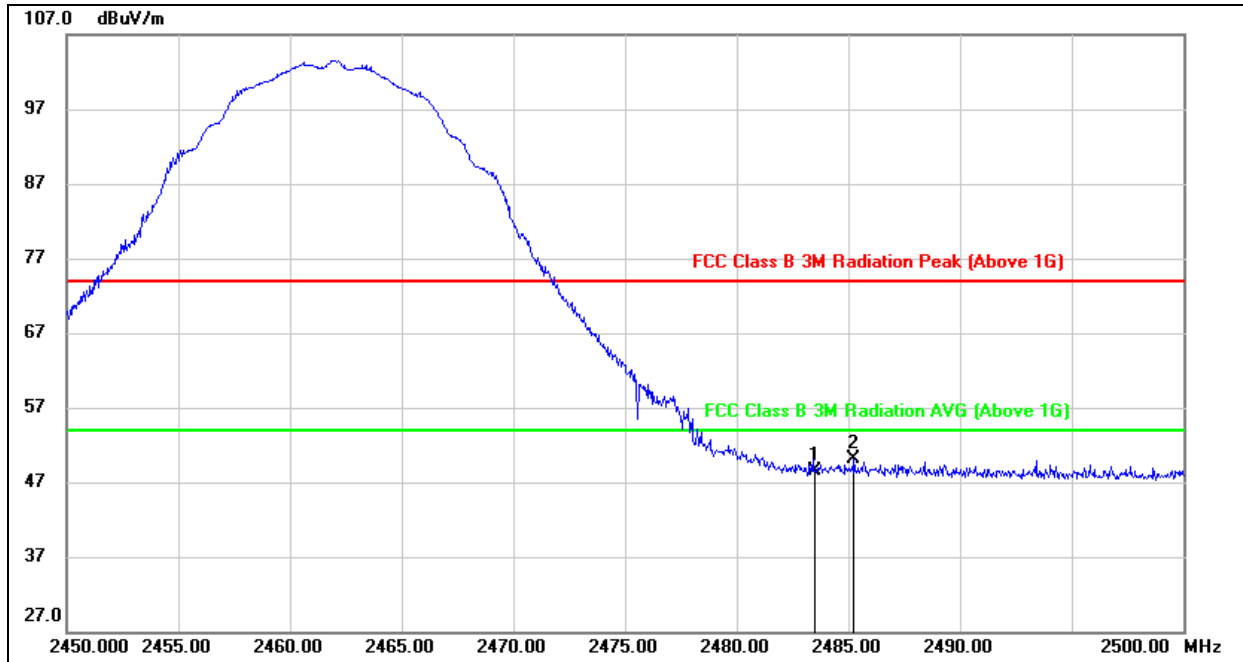

No.	Frequency (MHz)	Reading (dBuV)	Correct (dB/m)	Result (dBuV/m)	Limit (dBuV/m)	Margin (dB)	Remark
1	2483.500	15.66	32.78	48.44	74.00	-25.56	peak
2	2485.250	17.23	32.79	50.02	74.00	-23.98	peak

- Note: 1. Measurement = Reading Level + Correct Factor.  
 2. If Peak Result complies with AV limit, AV Result is deemed to comply with AV limit.  
 3. Peak: Peak detector.  
 4. Only the worst case emission was recorded, if it complies with the limit, the other emissions deemed to comply with the limit.



**RESTRICTED BANDEDGE (HIGH CHANNEL, VERTICAL)**

**PEAK**

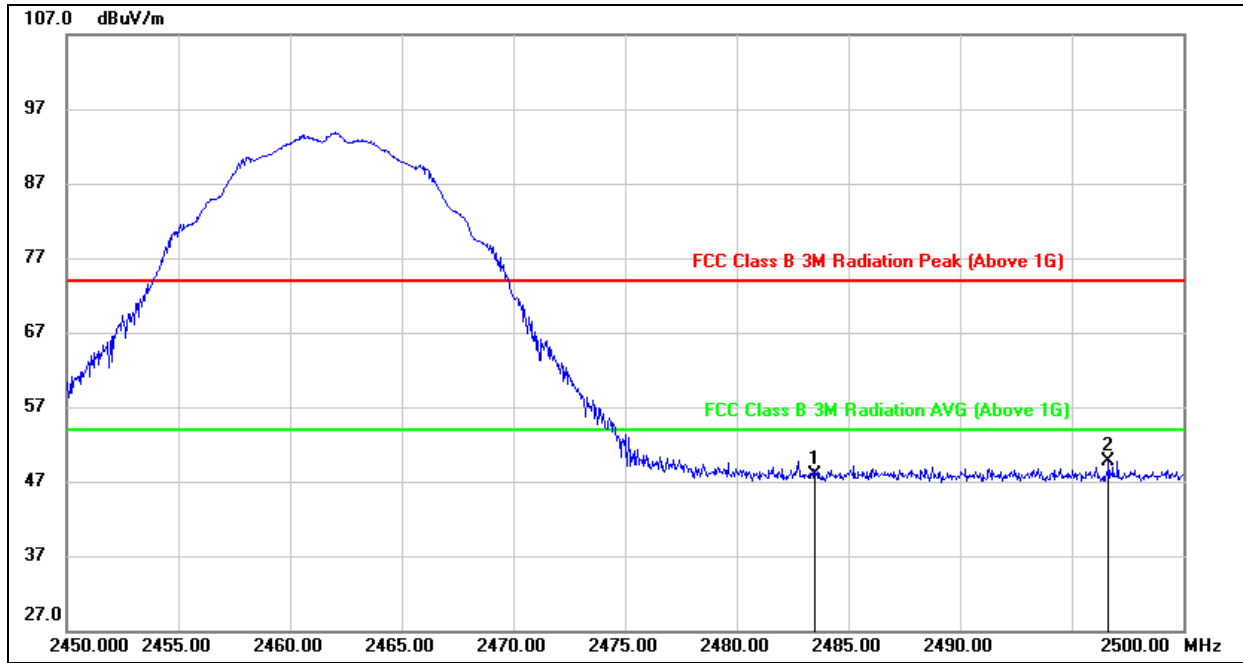

No.	Frequency (MHz)	Reading (dBuV)	Correct (dB/m)	Result (dBuV/m)	Limit (dBuV/m)	Margin (dB)	Remark
1	2483.500	15.11	32.88	47.99	74.00	-26.01	peak
2	2496.650	16.85	32.88	49.73	74.00	-24.27	peak

- Note: 1. Measurement = Reading Level + Correct Factor.  
 2. If Peak Result complies with AV limit, AV Result is deemed to comply with AV limit.  
 3. Peak: Peak detector.  
 4. Only the worst case emission was recorded, if it complies with the limit, the other emissions deemed to comply with the limit.



9.1.2. 802.11g MODE

RESTRICTED BANDEDGE (LOW CHANNEL, HORIZONTAL)

PEAK

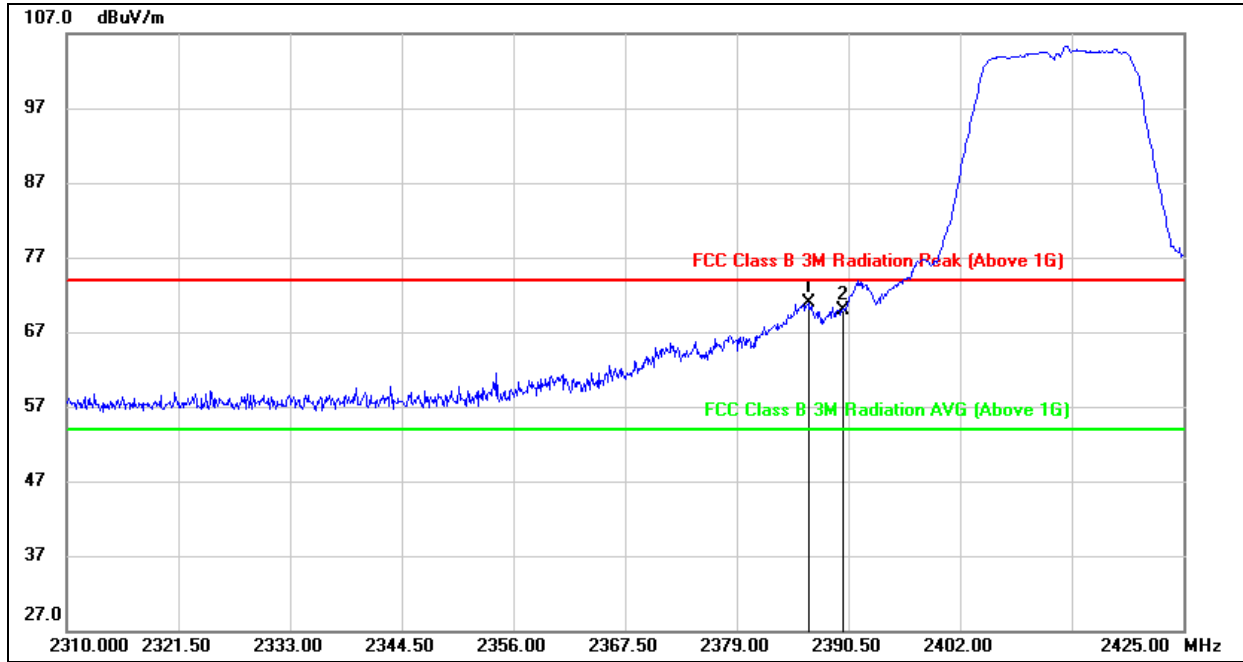

No.	Frequency (MHz)	Reading (dBuV)	Correct (dB/m)	Result (dBuV/m)	Limit (dBuV/m)	Margin (dB)	Remark
1	2386.360	37.65	33.17	70.82	74.00	-3.18	peak
2	2390.000	36.67	33.14	69.81	74.00	-4.19	peak

- Note: 1. Measurement = Reading Level + Correct Factor.  
 2. If Peak Result complies with AV limit, AV Result is deemed to comply with AV limit.  
 3. Peak: Peak detector.  
 4. Only the worst case emission was recorded, if it complies with the limit, the other emissions deemed to comply with the limit.



**AVG**

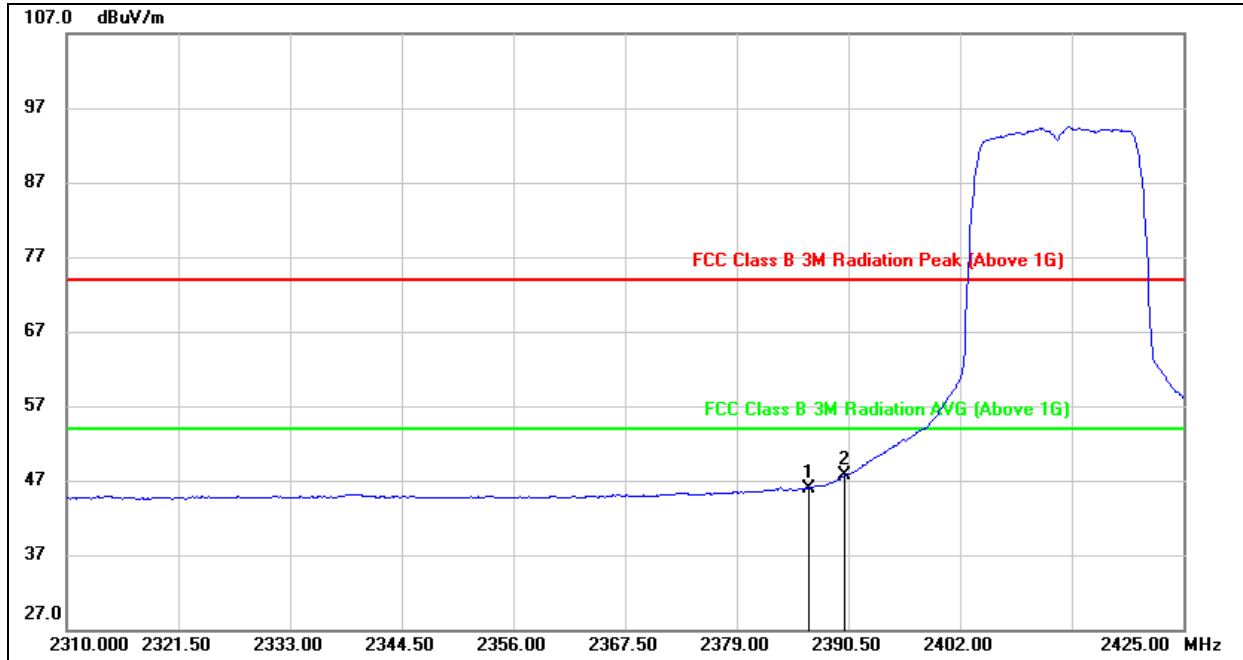

No.	Frequency (MHz)	Reading (dBuV)	Correct (dB/m)	Result (dBuV/m)	Limit (dBuV/m)	Margin (dB)	Remark
1	2386.360	12.81	33.17	45.98	54.00	-8.02	AVG
2	2390.000	14.53	33.14	47.67	54.00	-6.33	AVG

- Note:
1. Measurement = Reading Level + Correct Factor.
  2. If Peak Result complies with AV limit, AV Result is deemed to comply with AV limit.
  3. AVG:  $VBW=1/Ton$  where: ton is transmit duration.
  4. For transmit duration, please refer to clause 8.1.
  5. Only the worst case emission was recorded, if it complies with the limit, the other emissions deemed to comply with the limit.



**RESTRICTED BANDEDGE (LOW CHANNEL, VERTICAL)**

**PEAK**

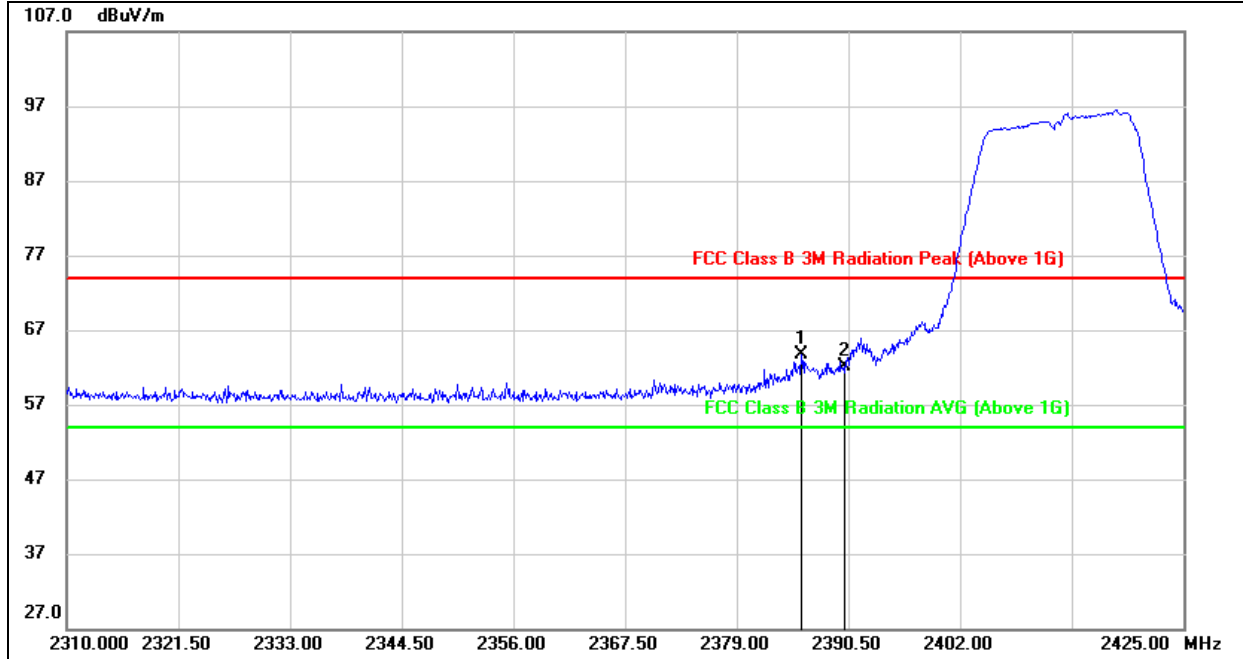

No.	Frequency (MHz)	Reading (dBuV)	Correct (dB/m)	Result (dBuV/m)	Limit (dBuV/m)	Margin (dB)	Remark
1	2385.670	30.36	33.27	63.63	74.00	-10.37	peak
2	2390.000	28.81	33.24	62.05	74.00	-11.95	peak

- Note: 1. Measurement = Reading Level + Correct Factor.  
 2. If Peak Result complies with AV limit, AV Result is deemed to comply with AV limit.  
 3. Peak: Peak detector.  
 4. Only the worst case emission was recorded, if it complies with the limit, the other emissions deemed to comply with the limit.





**AVG**

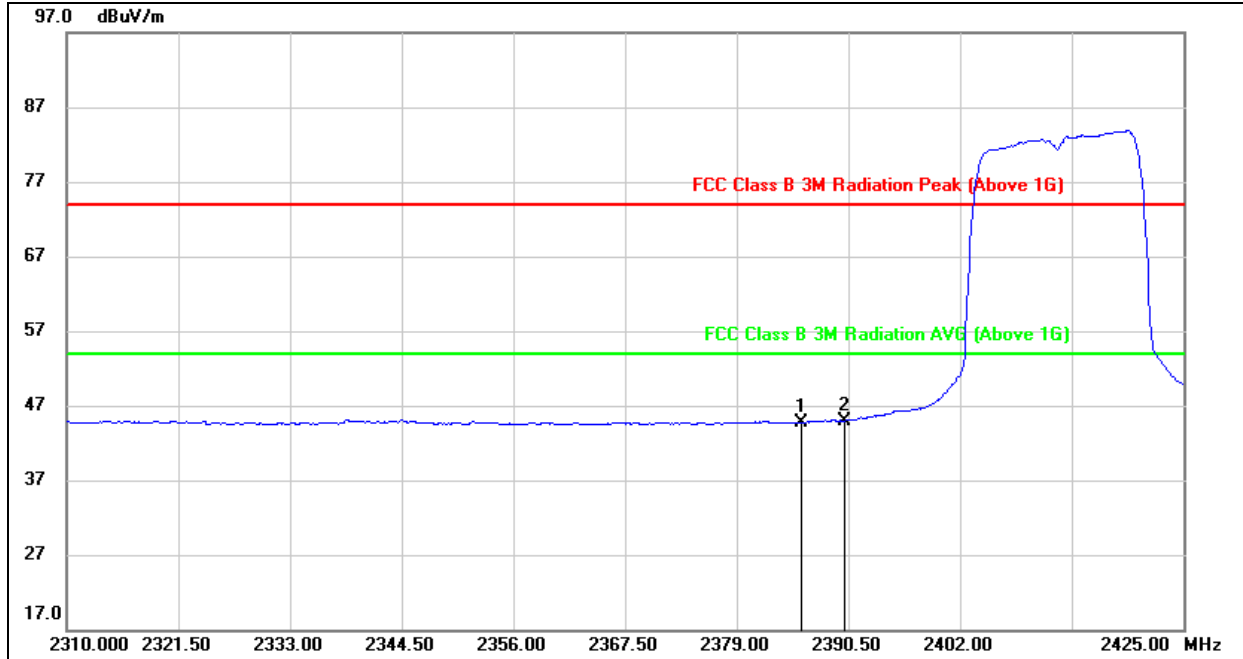

No.	Frequency (MHz)	Reading (dBuV)	Correct (dB/m)	Result (dBuV/m)	Limit (dBuV/m)	Margin (dB)	Remark
1	2385.670	11.50	33.27	44.77	54.00	-9.23	AVG
2	2390.000	11.72	33.24	44.96	54.00	-9.04	AVG

- Note:
1. Measurement = Reading Level + Correct Factor.
  2. If Peak Result complies with AV limit, AV Result is deemed to comply with AV limit.
  3. AVG:  $VBW=1/Ton$  where: ton is transmit duration.
  4. For transmit duration, please refer to clause 8.1.
  5. Only the worst case emission was recorded, if it complies with the limit, the other emissions deemed to comply with the limit.



**RESTRICTED BANDEDGE (HIGH CHANNEL, HORIZONTAL)**

**PEAK**

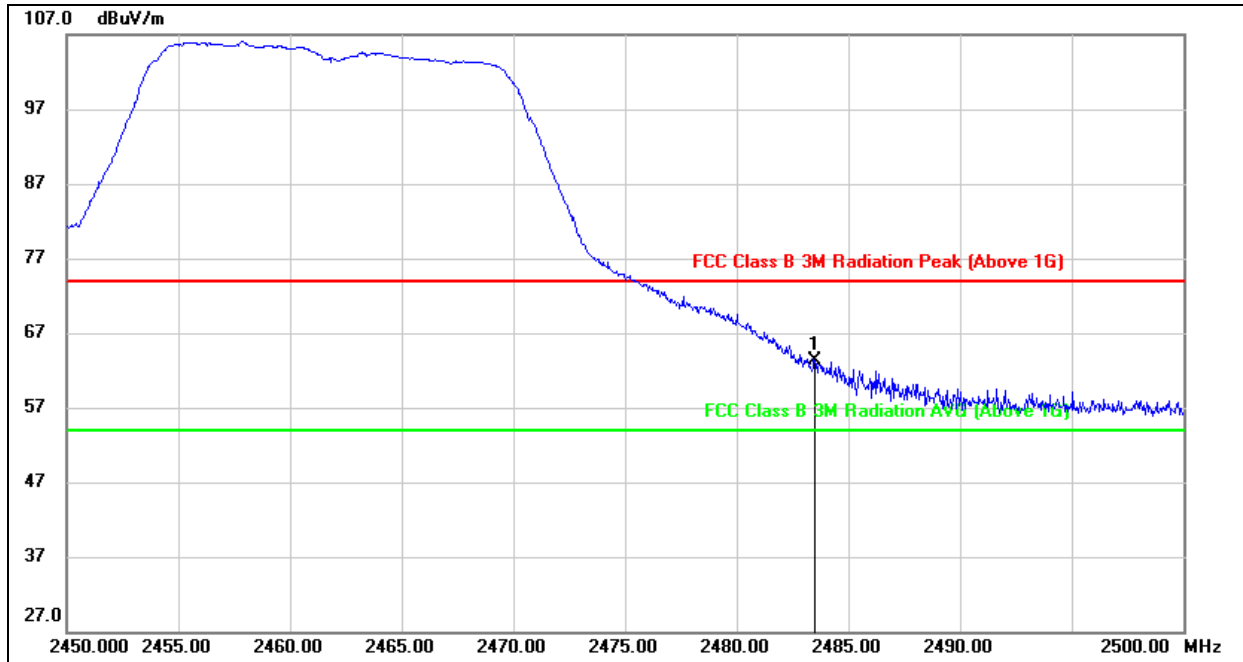

No.	Frequency (MHz)	Reading (dBuV)	Correct (dB/m)	Result (dBuV/m)	Limit (dBuV/m)	Margin (dB)	Remark
1	2483.500	30.57	32.78	63.35	74.00	-10.65	peak

- Note: 1. Measurement = Reading Level + Correct Factor.  
 2. If Peak Result complies with AV limit, AV Result is deemed to comply with AV limit.  
 3. Peak: Peak detector.  
 4. Only the worst case emission was recorded, if it complies with the limit, the other emissions deemed to comply with the limit.



**AVG**

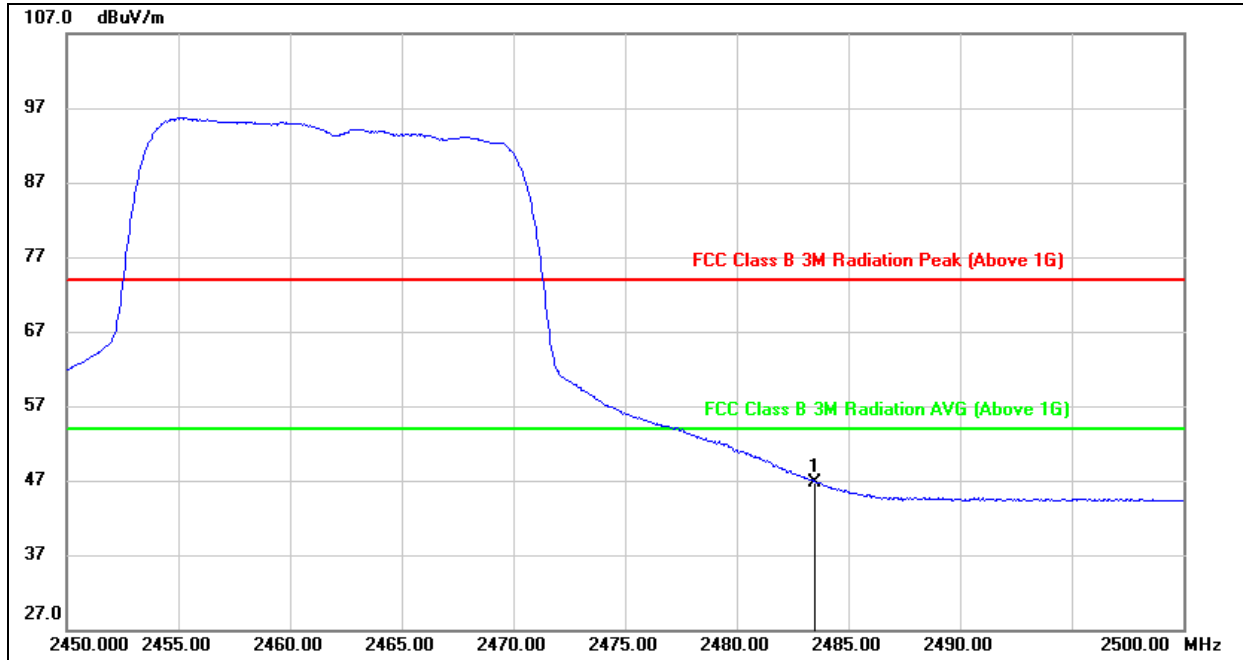

No.	Frequency (MHz)	Reading (dBuV)	Correct (dB/m)	Result (dBuV/m)	Limit (dBuV/m)	Margin (dB)	Remark
1	2483.500	14.02	32.78	46.80	54.00	-7.20	AVG

- Note:
1. Measurement = Reading Level + Correct Factor.
  2. If Peak Result complies with AV limit, AV Result is deemed to comply with AV limit.
  3. AVG:  $VBW=1/Ton$  where: ton is transmit duration.
  4. For transmit duration, please refer to clause 8.1.
  5. Only the worst case emission was recorded, if it complies with the limit, the other emissions deemed to comply with the limit.



**RESTRICTED BANDEDGE (HIGH CHANNEL, VERTICAL)**

**PEAK**

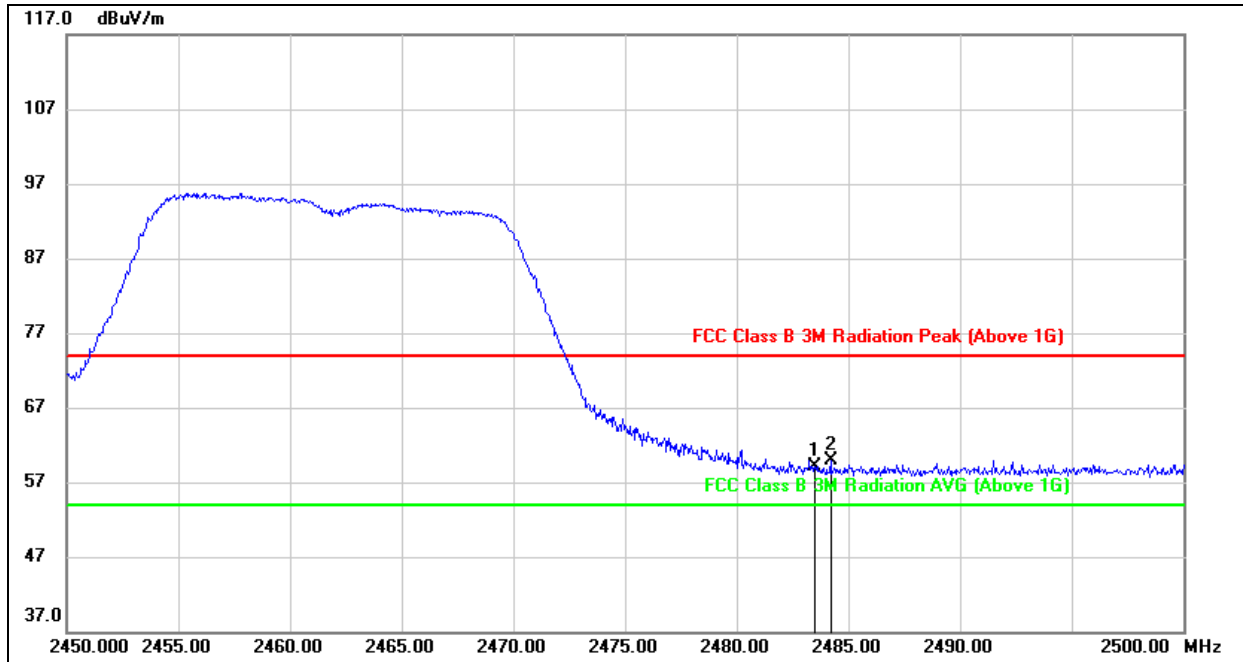

No.	Frequency (MHz)	Reading (dBuV)	Correct (dB/m)	Result (dBuV/m)	Limit (dBuV/m)	Margin (dB)	Remark
1	2483.500	26.18	32.88	59.06	74.00	-14.94	peak
2	2484.200	26.94	32.88	59.82	74.00	-14.18	peak

Note: 1. Measurement = Reading Level + Correct Factor.  
 2. If Peak Result complies with AV limit, AV Result is deemed to comply with AV limit.  
 3. Peak: Peak detector.  
 4. Only the worst case emission was recorded, if it complies with the limit, the other emissions deemed to comply with the limit.



**AVG**

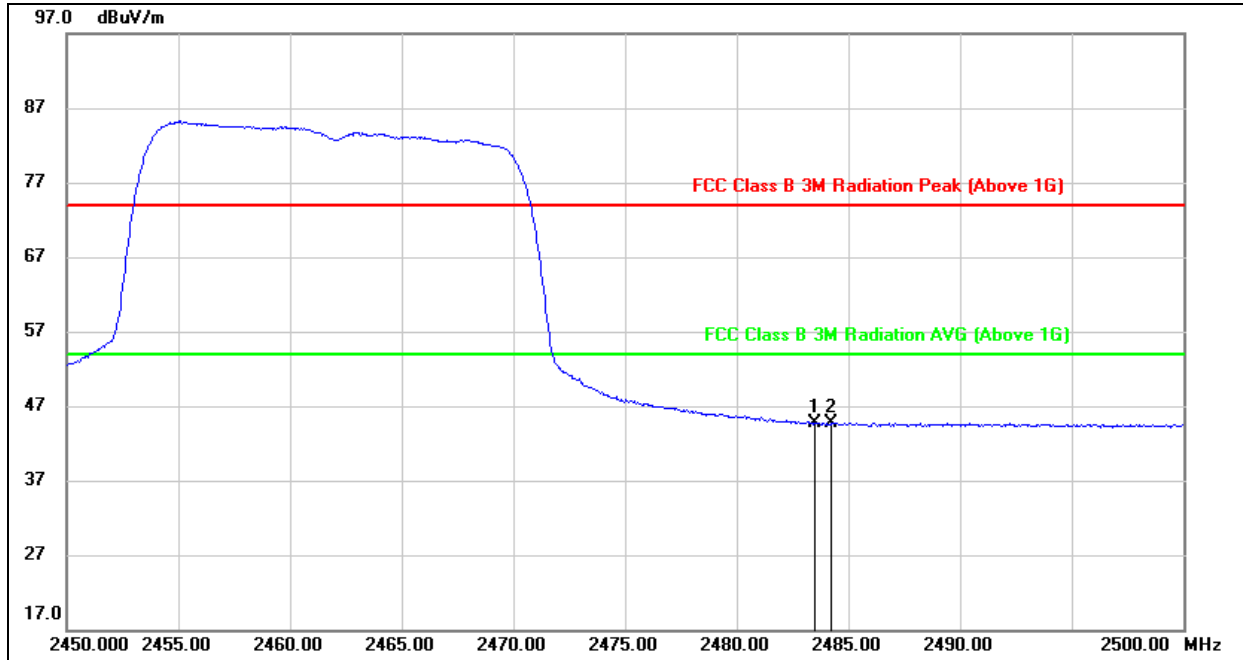

No.	Frequency (MHz)	Reading (dBuV)	Correct (dB/m)	Result (dBuV/m)	Limit (dBuV/m)	Margin (dB)	Remark
1	2483.500	11.79	32.88	44.67	54.00	-9.33	AVG
2	2484.200	11.81	32.88	44.69	54.00	-9.31	AVG

- Note:
1. Measurement = Reading Level + Correct Factor.
  2. If Peak Result complies with AV limit, AV Result is deemed to comply with AV limit.
  3. AVG:  $VBW=1/Ton$  where: ton is transmit duration.
  4. For transmit duration, please refer to clause 8.1.
  5. Only the worst case emission was recorded, if it complies with the limit, the other emissions deemed to comply with the limit.



9.1.3. 802.11n HT20 MODE

RESTRICTED BANDEDGE (LOW CHANNEL, HORIZONTAL)

PEAK

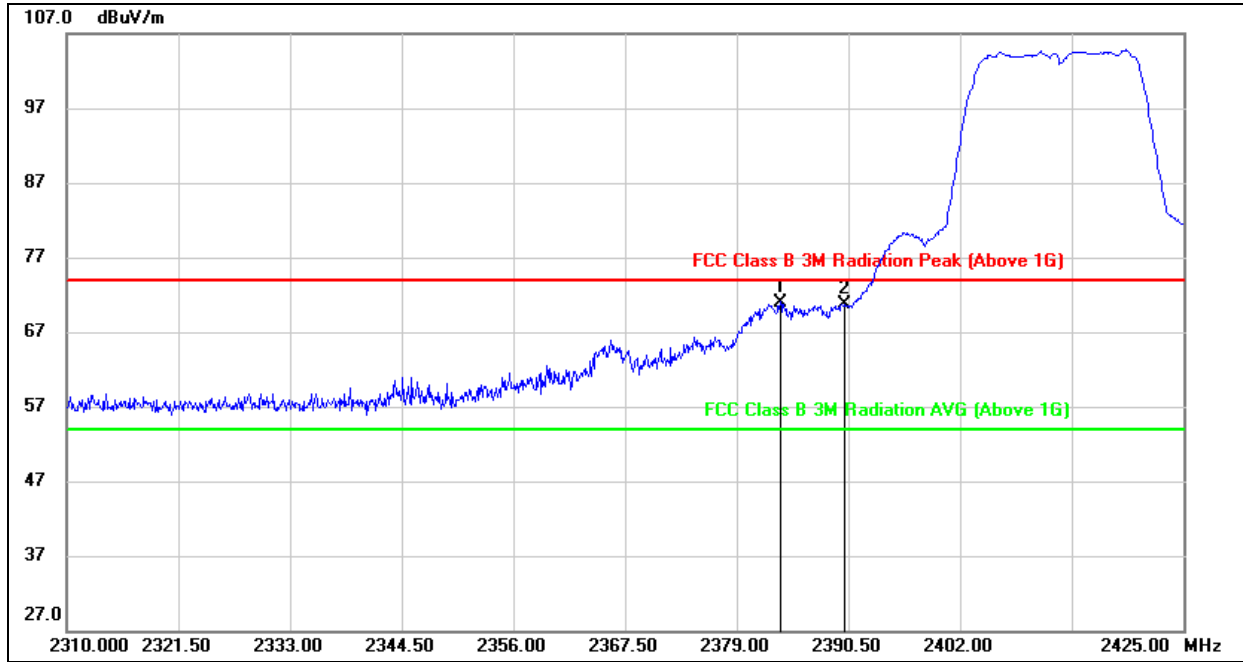

No.	Frequency (MHz)	Reading (dBuV)	Correct (dB/m)	Result (dBuV/m)	Limit (dBuV/m)	Margin (dB)	Remark
1	2383.485	37.81	33.19	71.00	74.00	-3.00	peak
2	2390.000	37.55	33.14	70.69	74.00	-3.31	peak

- Note: 1. Measurement = Reading Level + Correct Factor.  
 2. If Peak Result complies with AV limit, AV Result is deemed to comply with AV limit.  
 3. Peak: Peak detector.  
 4. Only the worst case emission was recorded, if it complies with the limit, the other emissions deemed to comply with the limit.



**AVG**

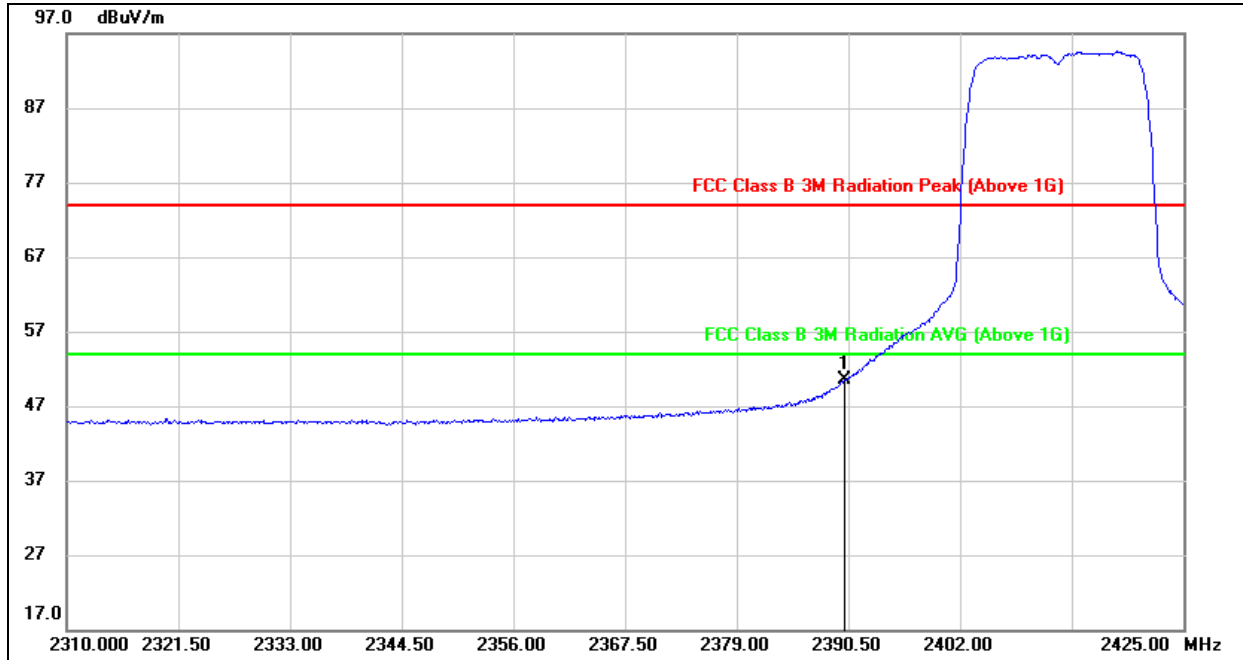

No.	Frequency (MHz)	Reading (dBuV)	Correct (dB/m)	Result (dBuV/m)	Limit (dBuV/m)	Margin (dB)	Remark
1	2390.000	17.29	33.14	50.43	54.00	-3.57	AVG

- Note:
1. Measurement = Reading Level + Correct Factor.
  2. If Peak Result complies with AV limit, AV Result is deemed to comply with AV limit.
  3. AVG:  $VBW=1/Ton$  where: ton is transmit duration.
  4. For transmit duration, please refer to clause 8.1.
  5. Only the worst case emission was recorded, if it complies with the limit, the other emissions deemed to comply with the limit.



**RESTRICTED BANDEDGE (LOW CHANNEL, VERTICAL)**

**PEAK**

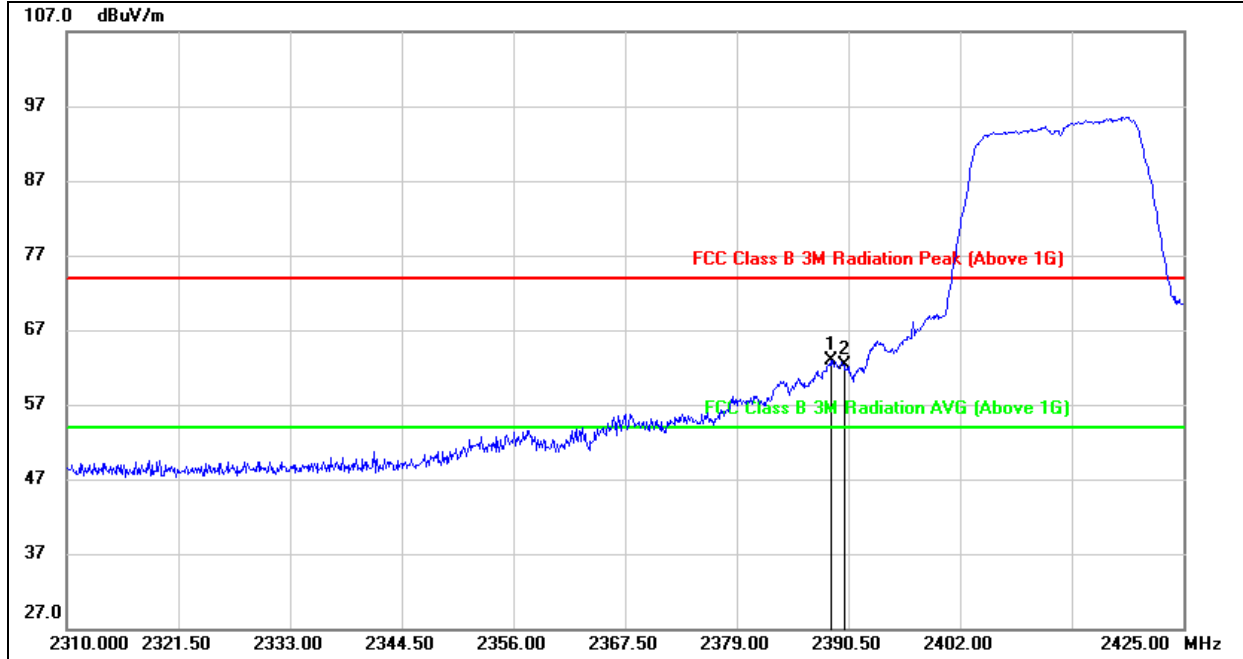

No.	Frequency (MHz)	Reading (dBuV)	Correct (dB/m)	Result (dBuV/m)	Limit (dBuV/m)	Margin (dB)	Remark
1	2388.660	29.71	33.25	62.96	74.00	-11.04	peak
2	2390.000	29.12	33.24	62.36	74.00	-11.64	peak

- Note: 1. Measurement = Reading Level + Correct Factor.  
 2. If Peak Result complies with AV limit, AV Result is deemed to comply with AV limit.  
 3. Peak: Peak detector.  
 4. Only the worst case emission was recorded, if it complies with the limit, the other emissions deemed to comply with the limit.





**AVG**

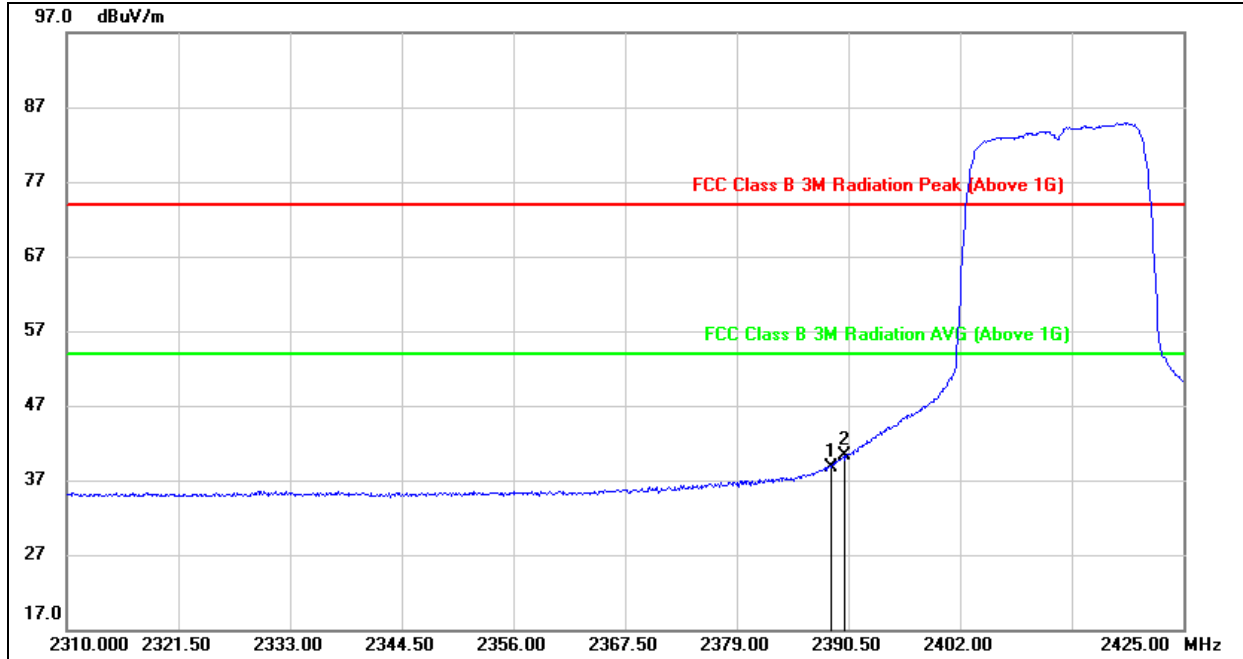

No.	Frequency (MHz)	Reading (dBuV)	Correct (dB/m)	Result (dBuV/m)	Limit (dBuV/m)	Margin (dB)	Remark
1	2388.660	5.48	33.25	38.73	54.00	-15.27	AVG
2	2390.000	7.02	33.24	40.26	54.00	-13.74	AVG

- Note:
1. Measurement = Reading Level + Correct Factor.
  2. If Peak Result complies with AV limit, AV Result is deemed to comply with AV limit.
  3. AVG:  $VBW=1/Ton$  where: ton is transmit duration.
  4. For transmit duration, please refer to clause 8.1.
  5. Only the worst case emission was recorded, if it complies with the limit, the other emissions deemed to comply with the limit.



**RESTRICTED BANDEDGE (HIGH CHANNEL, HORIZONTAL)**

**PEAK**

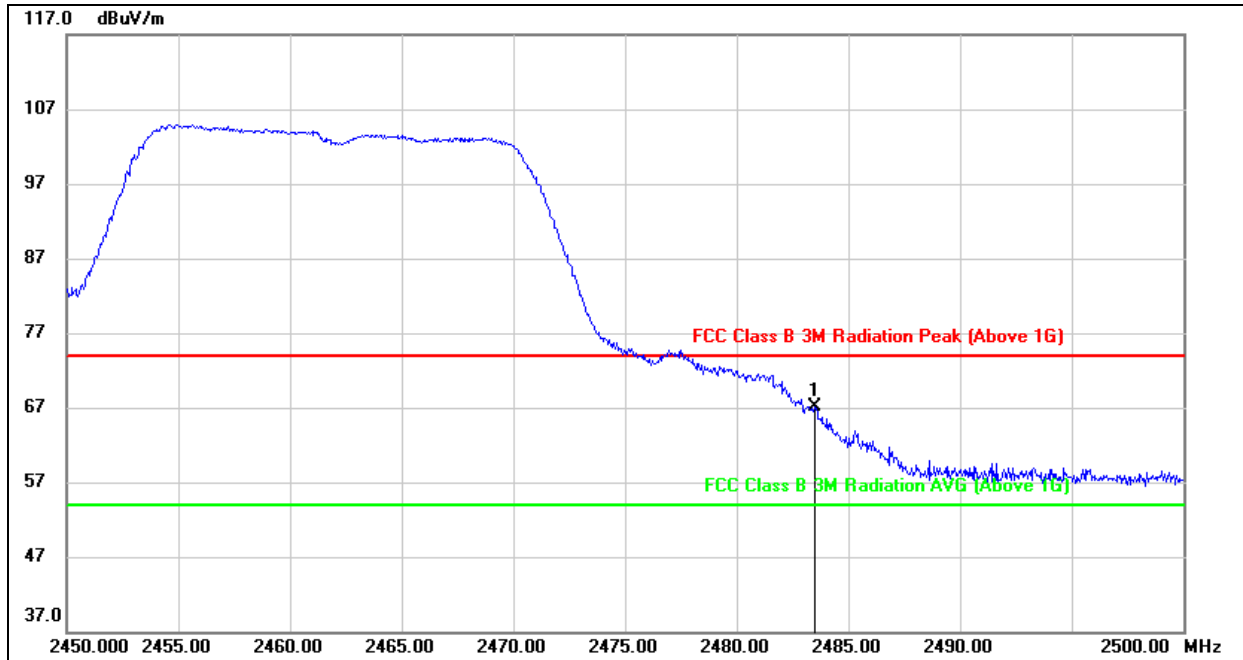

No.	Frequency (MHz)	Reading (dBuV)	Correct (dB/m)	Result (dBuV/m)	Limit (dBuV/m)	Margin (dB)	Remark
1	2483.500	34.35	32.78	67.13	74.00	-6.87	peak

- Note: 1. Measurement = Reading Level + Correct Factor.  
 2. If Peak Result complies with AV limit, AV Result is deemed to comply with AV limit.  
 3. Peak: Peak detector.  
 4. Only the worst case emission was recorded, if it complies with the limit, the other emissions deemed to comply with the limit.



**AVG**

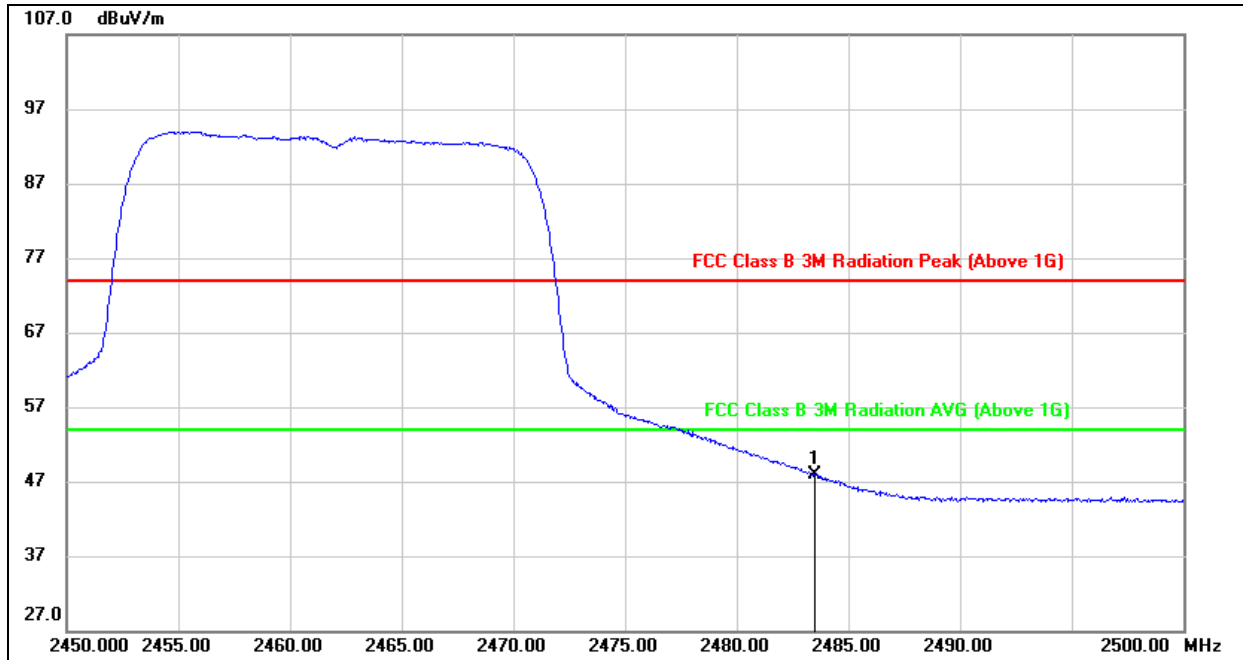

No.	Frequency (MHz)	Reading (dBuV)	Correct (dB/m)	Result (dBuV/m)	Limit (dBuV/m)	Margin (dB)	Remark
1	2483.500	15.14	32.78	47.92	54.00	-6.08	AVG

- Note:
1. Measurement = Reading Level + Correct Factor.
  2. If Peak Result complies with AV limit, AV Result is deemed to comply with AV limit.
  3. AVG:  $VBW=1/Ton$  where: ton is transmit duration.
  4. For transmit duration, please refer to clause 8.1.
  5. Only the worst case emission was recorded, if it complies with the limit, the other emissions deemed to comply with the limit.



**RESTRICTED BANDEDGE (HIGH CHANNEL, VERTICAL)**

**PEAK**

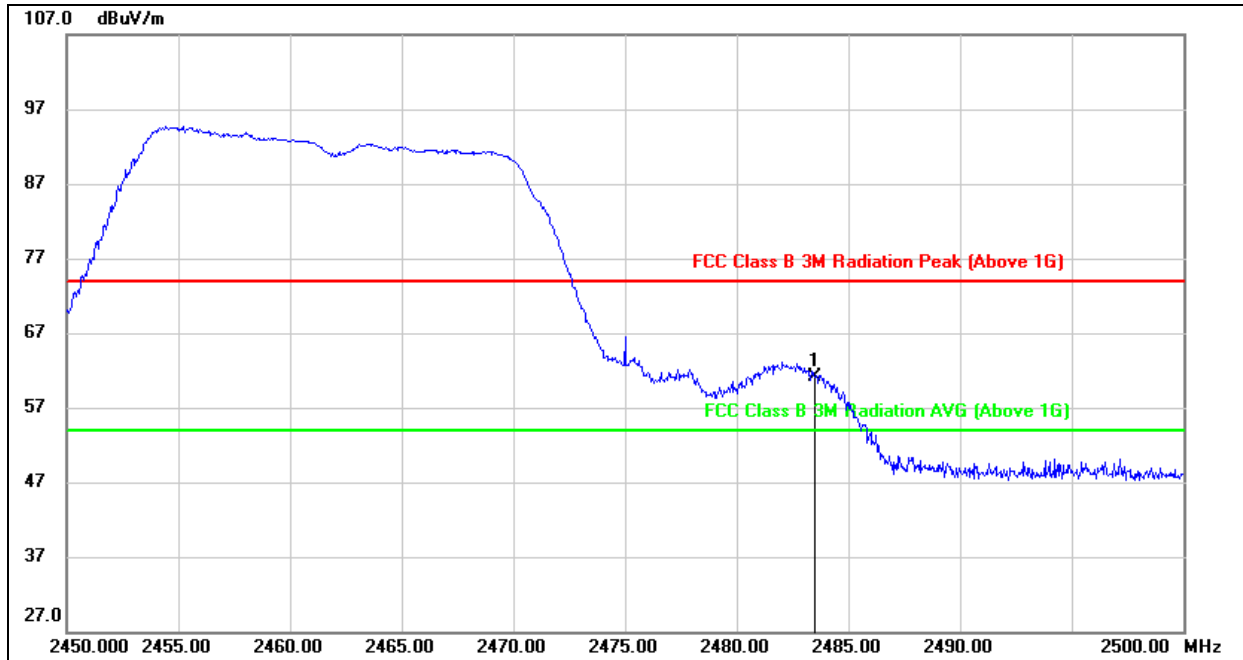

No.	Frequency (MHz)	Reading (dBuV)	Correct (dB/m)	Result (dBuV/m)	Limit (dBuV/m)	Margin (dB)	Remark
1	2483.500	28.21	32.88	61.09	74.00	-12.91	peak

- Note:
1. Measurement = Reading Level + Correct Factor.
  2. If Peak Result complies with AV limit, AV Result is deemed to comply with AV limit.
  3. Peak: Peak detector.
  4. Only the worst case emission was recorded, if it complies with the limit, the other emissions deemed to comply with the limit.



**AVG**

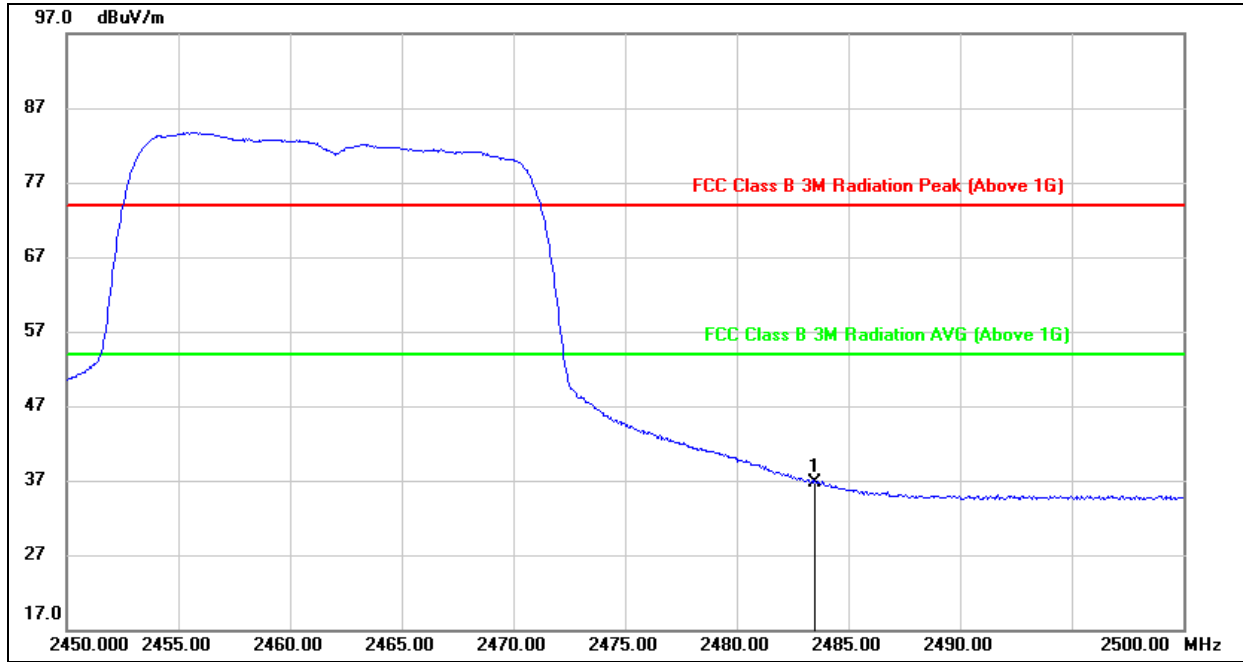

No.	Frequency (MHz)	Reading (dBuV)	Correct (dB/m)	Result (dBuV/m)	Limit (dBuV/m)	Margin (dB)	Remark
1	2483.500	3.92	32.88	36.80	54.00	-17.20	AVG

- Note: 1. Measurement = Reading Level + Correct Factor.  
 2. If Peak Result complies with AV limit, AV Result is deemed to comply with AV limit.  
 3. AVG:  $VBW=1/Ton$  where: ton is transmit duration.  
 4. For transmit duration, please refer to clause 8.1.  
 5. Only the worst case emission was recorded, if it complies with the limit, the other emissions deemed to comply with the limit.



### 9.1.4. 802.11n HT40 MODE

#### RESTRICTED BANDEDGE (LOW CHANNEL, HORIZONTAL)

#### PEAK

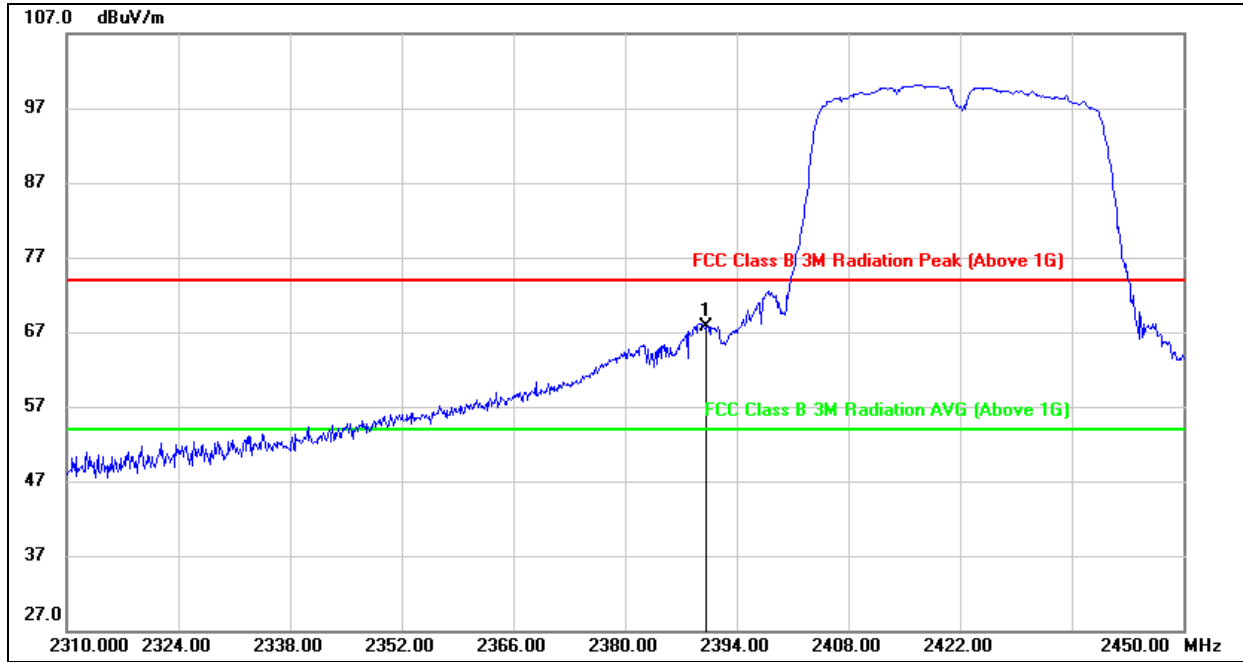

No.	Frequency (MHz)	Reading (dBuV)	Correct (dB/m)	Result (dBuV/m)	Limit (dBuV/m)	Margin (dB)	Remark
1	2390.000	34.52	33.14	67.66	74.00	-6.34	peak

- Note: 1. Measurement = Reading Level + Correct Factor.  
 2. If Peak Result complies with AV limit, AV Result is deemed to comply with AV limit.  
 3. Peak: Peak detector.  
 4. Only the worst case emission was recorded, if it complies with the limit, the other emissions deemed to comply with the limit.



**AVG**

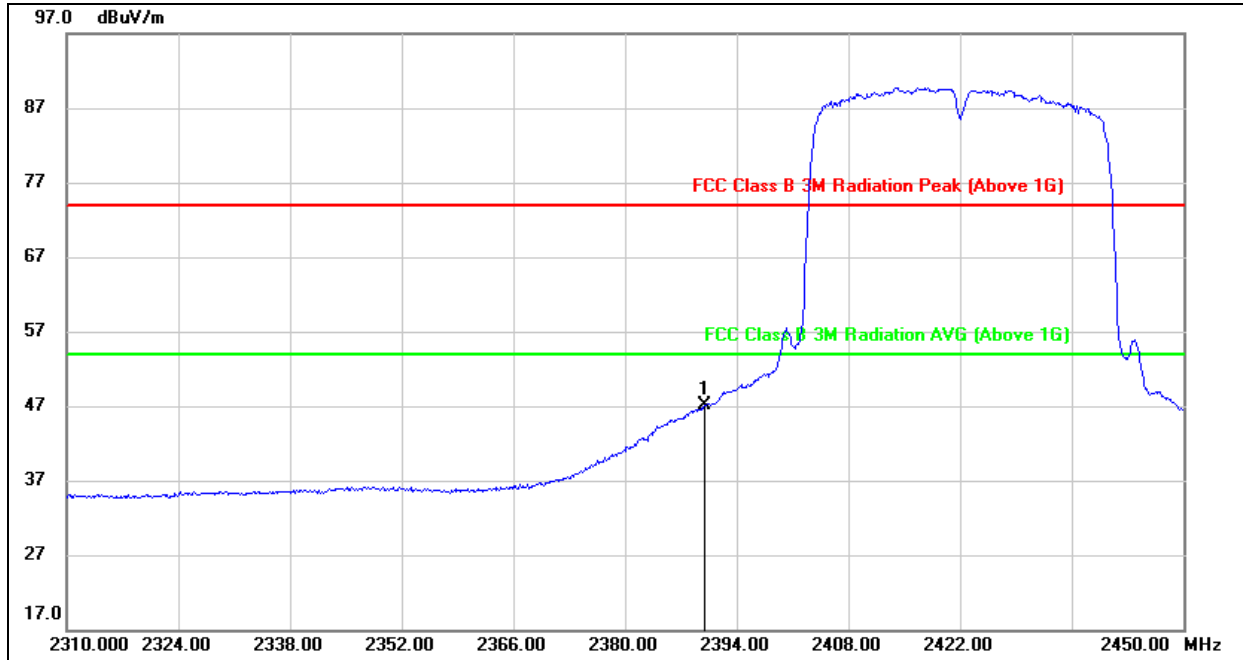

No.	Frequency (MHz)	Reading (dBuV)	Correct (dB/m)	Result (dBuV/m)	Limit (dBuV/m)	Margin (dB)	Remark
1	2390.000	13.92	33.14	47.06	54.00	-6.94	AVG

- Note:
1. Measurement = Reading Level + Correct Factor.
  2. If Peak Result complies with AV limit, AV Result is deemed to comply with AV limit.
  3. AVG:  $VBW=1/Ton$  where: ton is transmit duration.
  4. For transmit duration, please refer to clause 8.1.
  5. Only the worst case emission was recorded, if it complies with the limit, the other emissions deemed to comply with the limit.



**RESTRICTED BANDEDGE (LOW CHANNEL, VERTICAL)**

**PEAK**

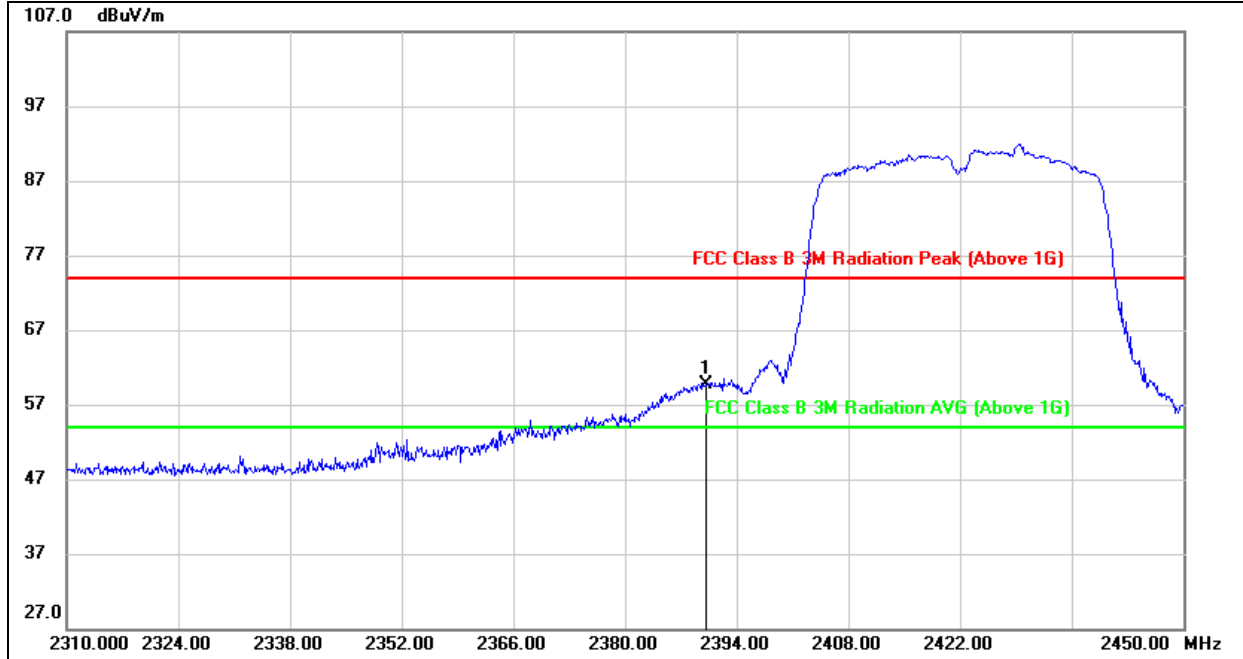

No.	Frequency (MHz)	Reading (dBuV)	Correct (dB/m)	Result (dBuV/m)	Limit (dBuV/m)	Margin (dB)	Remark
1	2390.000	26.44	33.24	59.68	74.00	-14.32	peak

- Note: 1. Measurement = Reading Level + Correct Factor.  
 2. If Peak Result complies with AV limit, AV Result is deemed to comply with AV limit.  
 3. Peak: Peak detector.  
 4. Only the worst case emission was recorded, if it complies with the limit, the other emissions deemed to comply with the limit.





**AVG**

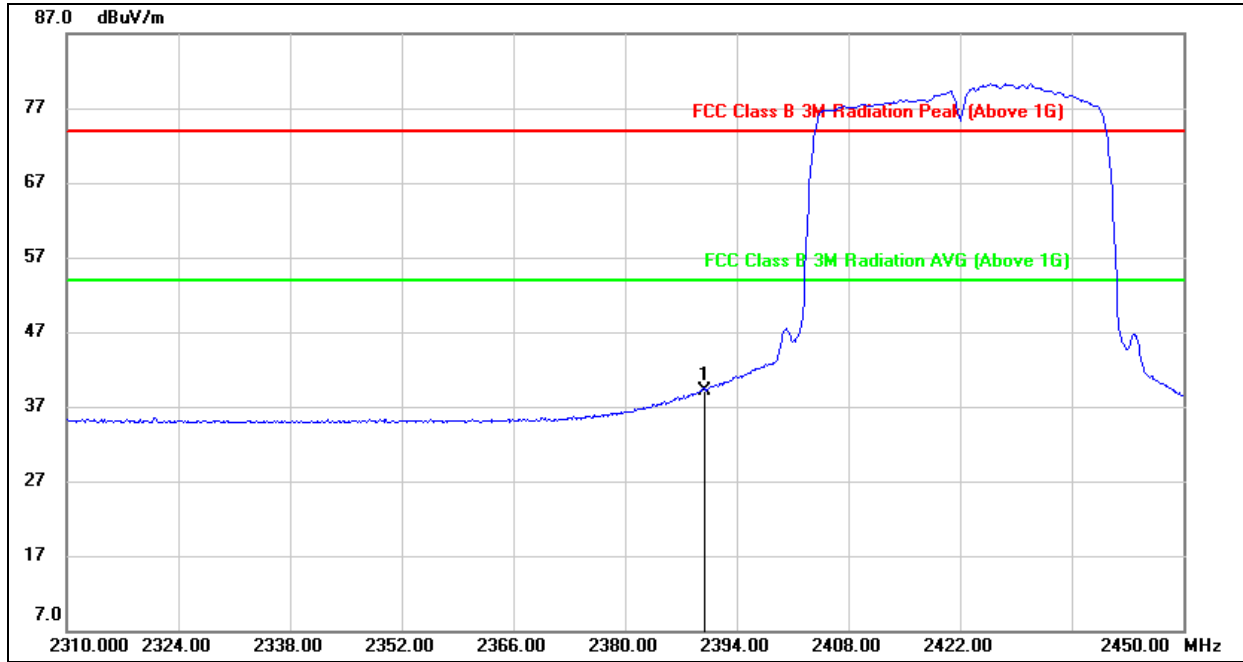

No.	Frequency (MHz)	Reading (dBuV)	Correct (dB/m)	Result (dBuV/m)	Limit (dBuV/m)	Margin (dB)	Remark
1	2390.000	5.95	33.24	39.19	54.00	-14.81	AVG

- Note:
1. Measurement = Reading Level + Correct Factor.
  2. If Peak Result complies with AV limit, AV Result is deemed to comply with AV limit.
  3. AVG:  $VBW=1/Ton$  where: ton is transmit duration.
  4. For transmit duration, please refer to clause 8.1.
  5. Only the worst case emission was recorded, if it complies with the limit, the other emissions deemed to comply with the limit.



**RESTRICTED BANDEDGE (HIGH CHANNEL, HORIZONTAL)**

**PEAK**

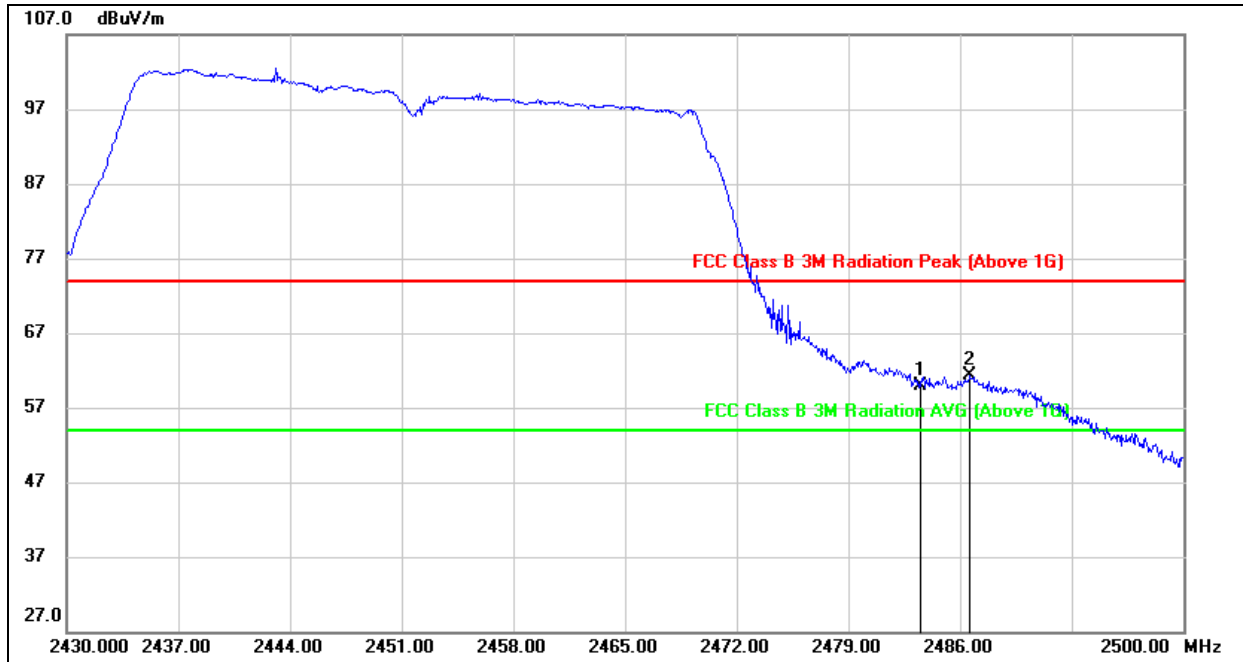

No.	Frequency (MHz)	Reading (dBuV)	Correct (dB/m)	Result (dBuV/m)	Limit (dBuV/m)	Margin (dB)	Remark
1	2483.500	27.14	32.78	59.92	74.00	-14.08	peak
2	2486.630	28.44	32.79	61.23	74.00	-12.77	peak

- Note: 1. Measurement = Reading Level + Correct Factor.  
 2. If Peak Result complies with AV limit, AV Result is deemed to comply with AV limit.  
 3. Peak: Peak detector.  
 4. Only the worst case emission was recorded, if it complies with the limit, the other emissions deemed to comply with the limit.



**AVG**

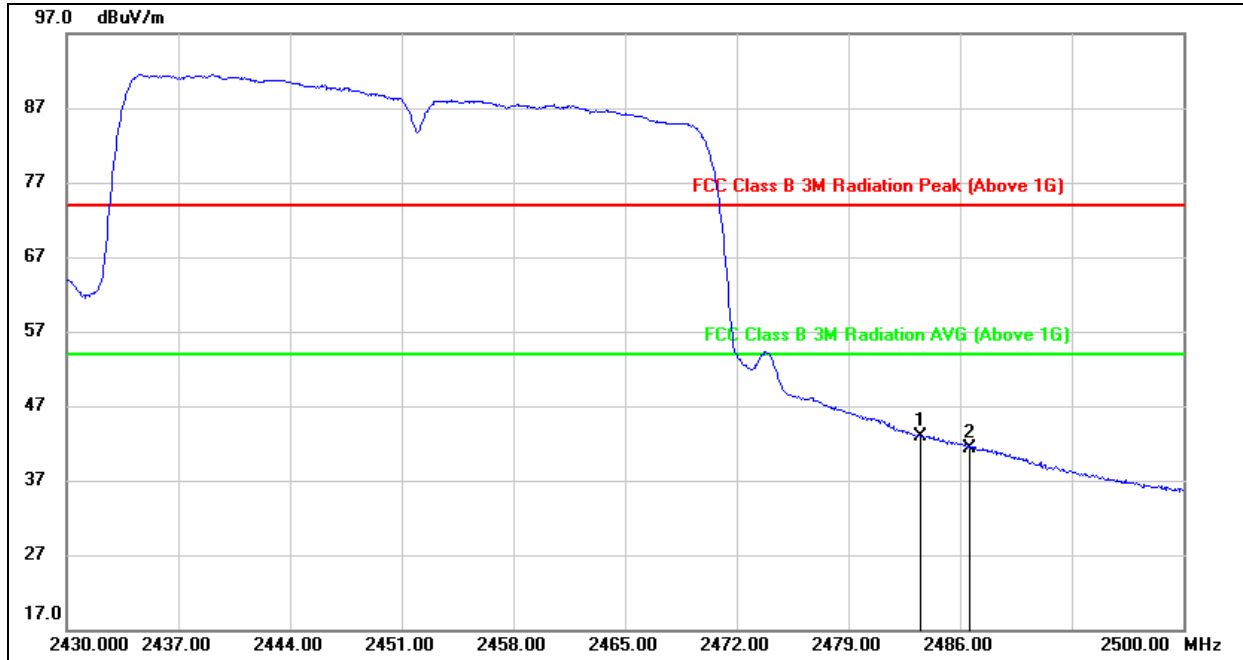

No.	Frequency (MHz)	Reading (dBuV)	Correct (dB/m)	Result (dBuV/m)	Limit (dBuV/m)	Margin (dB)	Remark
1	2483.500	10.11	32.78	42.89	54.00	-11.11	AVG
2	2486.630	8.50	32.79	41.29	54.00	-12.71	AVG

- Note:
1. Measurement = Reading Level + Correct Factor.
  2. If Peak Result complies with AV limit, AV Result is deemed to comply with AV limit.
  3. AVG:  $VBW=1/Ton$  where: ton is transmit duration.
  4. For transmit duration, please refer to clause 8.1.
  5. Only the worst case emission was recorded, if it complies with the limit, the other emissions deemed to comply with the limit.



**RESTRICTED BANDEDGE (HIGH CHANNEL, VERTICAL)**

**PEAK**

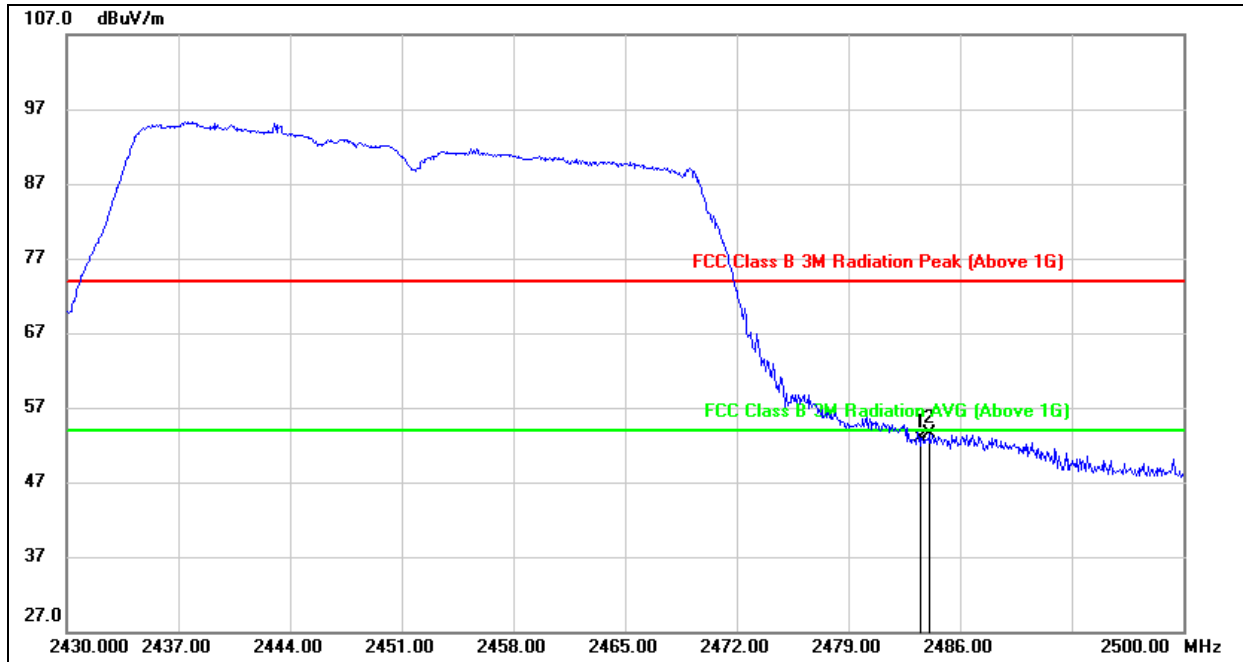

No.	Frequency (MHz)	Reading (dBuV)	Correct (dB/m)	Result (dBuV/m)	Limit (dBuV/m)	Margin (dB)	Remark
1	2483.500	20.10	32.88	52.98	74.00	-21.02	peak
2	2484.110	20.65	32.88	53.53	74.00	-20.47	peak

- Note: 1. Measurement = Reading Level + Correct Factor.  
 2. If Peak Result complies with AV limit, AV Result is deemed to comply with AV limit.  
 3. Peak: Peak detector.  
 4. Only the worst case emission was recorded, if it complies with the limit, the other emissions deemed to comply with the limit.



## 9.2. SPURIOUS EMISSIONS (1~3GHz)

### 9.2.1. 802.11b MODE

#### HARMONICS AND SPURIOUS EMISSIONS (LOW CHANNEL, HORIZONTAL)

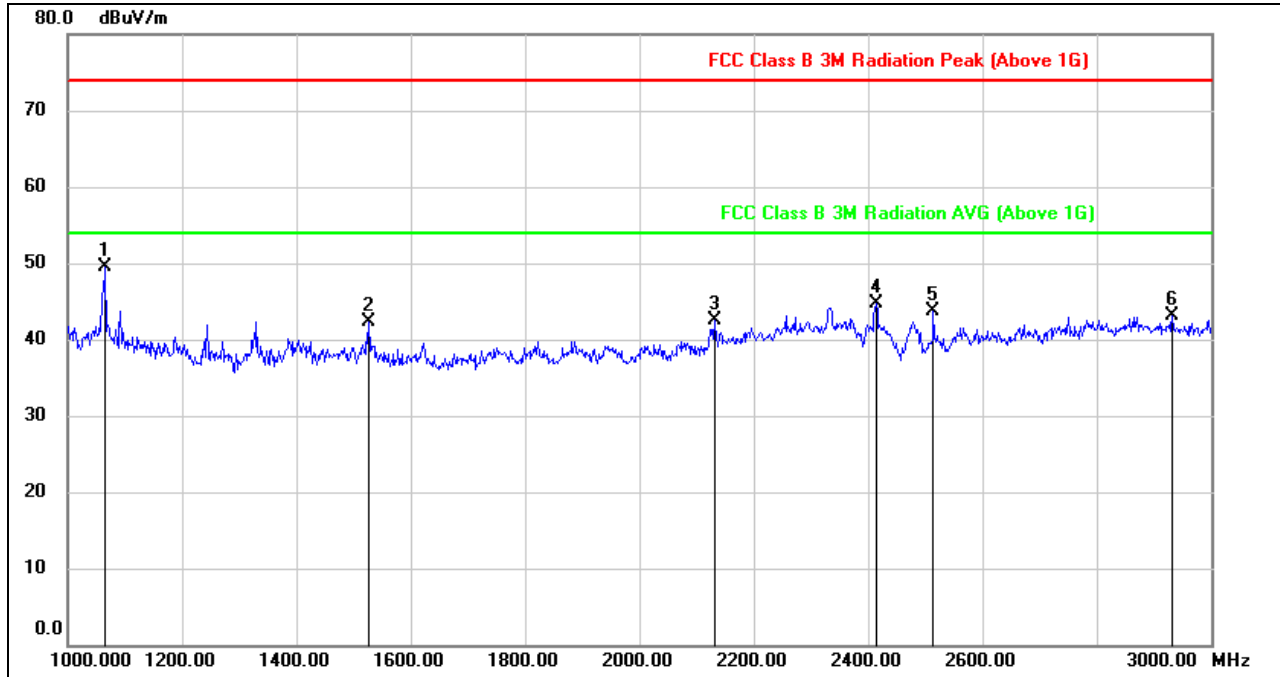

No.	Frequency (MHz)	Reading (dBuV)	Correct (dB/m)	Result (dBuV/m)	Limit (dBuV/m)	Margin (dB)	Remark
1	1066.000	63.18	-13.62	49.56	74.00	-24.44	peak
2	1526.000	54.63	-12.28	42.35	74.00	-31.65	peak
3	2132.000	51.60	-9.16	42.44	74.00	-31.56	peak
4	2414.000	52.80	-8.16	44.64	74.00	-29.36	peak
5	2514.000	52.06	-8.38	43.68	74.00	-30.32	peak
6	2932.000	49.57	-6.55	43.02	74.00	-30.98	peak

Note: 1. Measurement = Reading Level + Correct Factor.  
 2. If Peak Result complies with AV limit, AV Result is deemed to comply with AV limit.  
 3. Peak: Peak detector.



**HARMONICS AND SPURIOUS EMISSIONS (LOW CHANNEL, VERTICAL)**

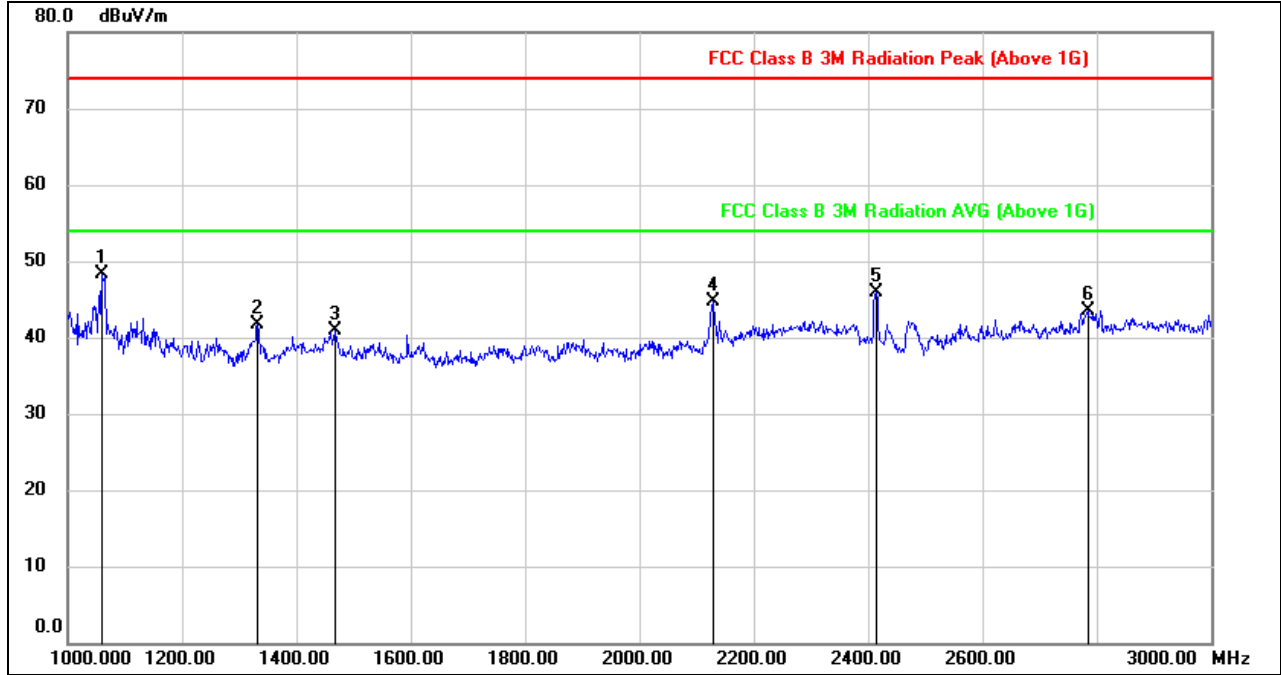

No.	Frequency (MHz)	Reading (dBuV)	Correct (dB/m)	Result (dBuV/m)	Limit (dBuV/m)	Margin (dB)	Remark
1	1060.000	62.18	-13.92	48.26	74.00	-25.74	peak
2	1332.000	54.22	-12.48	41.74	74.00	-32.26	peak
3	1468.000	53.15	-12.28	40.87	74.00	-33.13	peak
4	2130.000	53.91	-9.28	44.63	74.00	-29.37	peak
5	2414.000	54.04	-8.06	45.98	74.00	-28.02	peak
6	2784.000	50.56	-7.08	43.48	74.00	-30.52	peak

- Note: 1. Measurement = Reading Level + Correct Factor.  
 2. If Peak Result complies with AV limit, AV Result is deemed to comply with AV limit.  
 3. Peak: Peak detector.



**HARMONICS AND SPURIOUS EMISSIONS (MID CHANNEL, HORIZONTAL)**

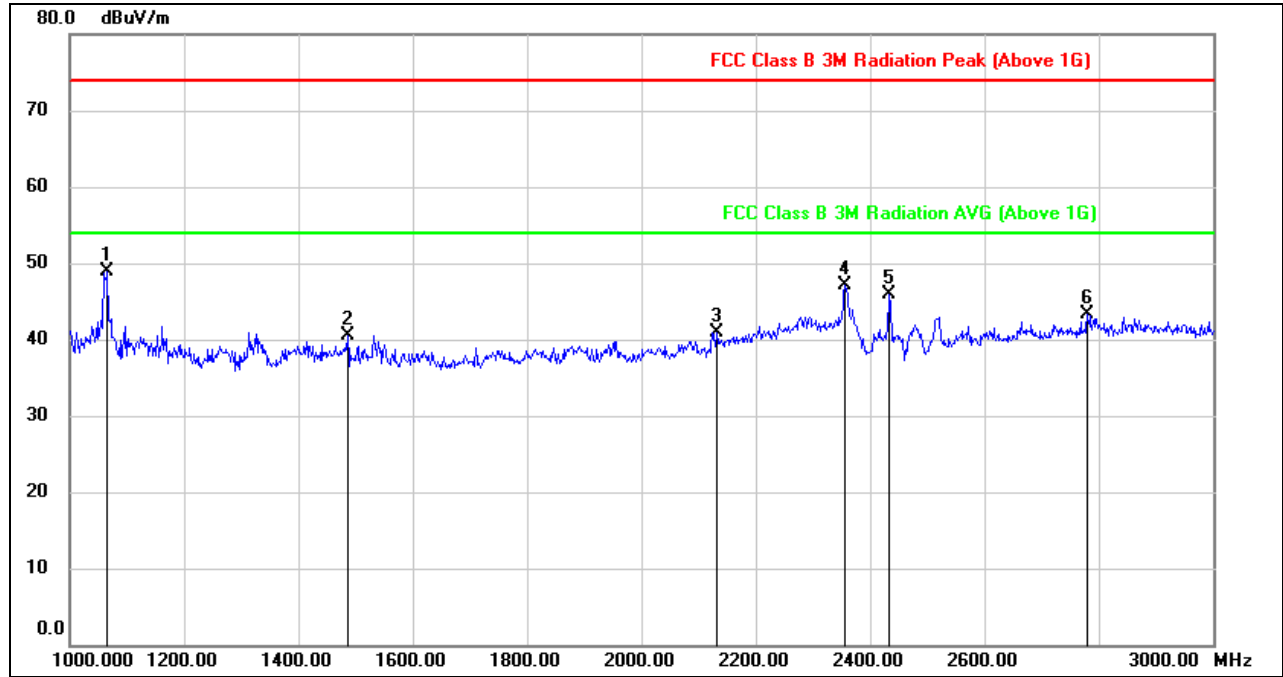

No.	Frequency (MHz)	Reading (dBuV)	Correct (dB/m)	Result (dBuV/m)	Limit (dBuV/m)	Margin (dB)	Remark
1	1066.000	62.59	-13.62	48.97	74.00	-25.03	peak
2	1486.000	52.73	-12.21	40.52	74.00	-33.48	peak
3	2132.000	50.08	-9.16	40.92	74.00	-33.08	peak
4	2356.000	54.82	-7.79	47.03	74.00	-26.97	peak
5	2434.000	54.11	-8.26	45.85	74.00	-28.15	peak
6	2780.000	50.46	-7.07	43.39	74.00	-30.61	peak

- Note: 1. Measurement = Reading Level + Correct Factor.  
2. If Peak Result complies with AV limit, AV Result is deemed to comply with AV limit.  
3. Peak: Peak detector.



**HARMONICS AND SPURIOUS EMISSIONS (MID CHANNEL, VERTICAL)**

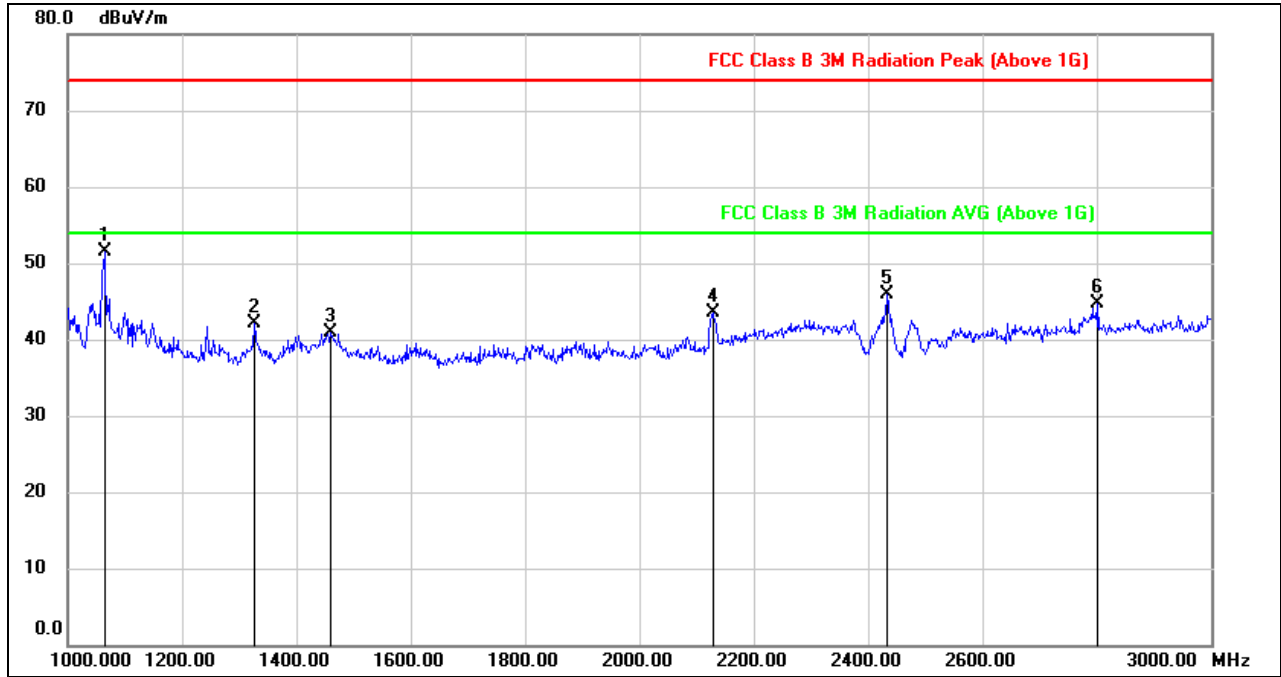

No.	Frequency (MHz)	Reading (dBuV)	Correct (dB/m)	Result (dBuV/m)	Limit (dBuV/m)	Margin (dB)	Remark
1	1064.000	65.33	-13.92	51.41	74.00	-22.59	peak
2	1326.000	54.63	-12.53	42.10	74.00	-31.90	peak
3	1460.000	53.13	-12.28	40.85	74.00	-33.15	peak
4	2128.000	52.81	-9.31	43.50	74.00	-30.50	peak
5	2434.000	54.10	-8.16	45.94	74.00	-28.06	peak
6	2802.000	51.61	-6.95	44.66	74.00	-29.34	peak

- Note: 1. Measurement = Reading Level + Correct Factor.  
 2. If Peak Result complies with AV limit, AV Result is deemed to comply with AV limit.  
 3. Peak: Peak detector.

Note: All the antennas had been tested, but only the worst data record in the report.





**HARMONICS AND SPURIOUS EMISSIONS (HIGH CHANNEL, HORIZONTAL)**

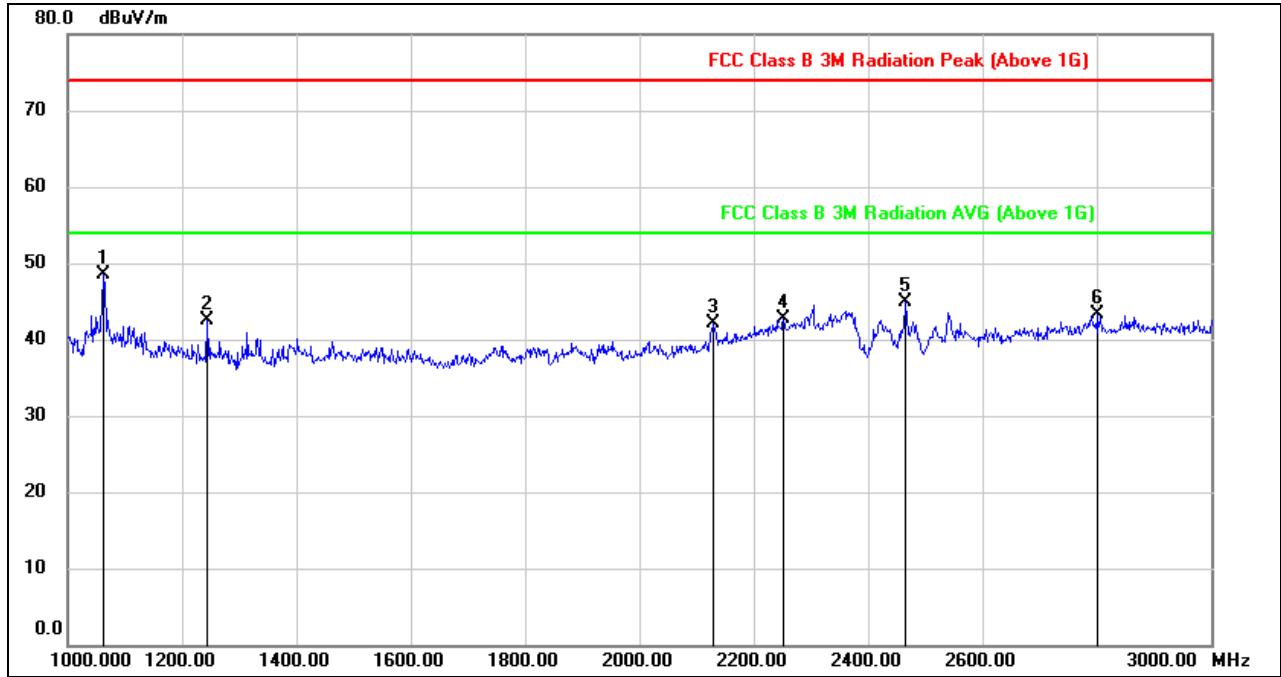

No.	Frequency (MHz)	Reading (dBuV)	Correct (dB/m)	Result (dBuV/m)	Limit (dBuV/m)	Margin (dB)	Remark
1	1062.000	62.10	-13.62	48.48	74.00	-25.52	peak
2	1244.000	55.28	-12.85	42.43	74.00	-31.57	peak
3	2130.000	51.28	-9.18	42.10	74.00	-31.90	peak
4	2252.000	50.21	-7.58	42.63	74.00	-31.37	peak
5	2464.000	53.31	-8.37	44.94	74.00	-29.06	peak
6	2802.000	50.19	-6.95	43.24	74.00	-30.76	peak

- Note: 1. Measurement = Reading Level + Correct Factor.  
 2. If Peak Result complies with AV limit, AV Result is deemed to comply with AV limit.  
 3. Peak: Peak detector.



**HARMONICS AND SPURIOUS EMISSIONS (HIGH CHANNEL, VERTICAL)**

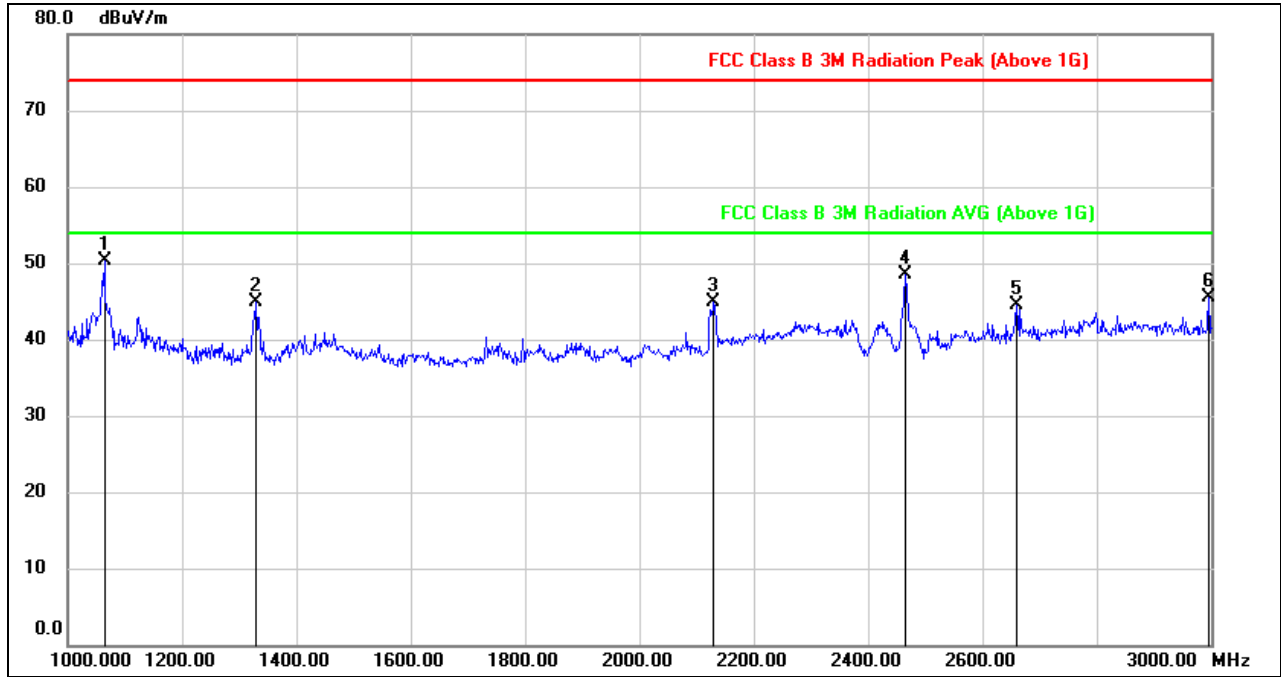

No.	Frequency (MHz)	Reading (dBuV)	Correct (dB/m)	Result (dBuV/m)	Limit (dBuV/m)	Margin (dB)	Remark
1	1064.000	64.29	-13.92	50.37	74.00	-23.63	peak
2	1330.000	57.36	-12.50	44.86	74.00	-29.14	peak
3	2130.000	54.17	-9.28	44.89	74.00	-29.11	peak
4	2466.000	56.84	-8.27	48.57	74.00	-25.43	peak
5	2660.000	52.46	-7.88	44.58	74.00	-29.42	peak
6	2996.000	52.12	-6.60	45.52	74.00	-28.48	peak

- Note: 1. Measurement = Reading Level + Correct Factor.  
 2. If Peak Result complies with AV limit, AV Result is deemed to comply with AV limit.  
 3. Peak: Peak detector.



### 9.2.2. 802.11g MODE

#### HARMONICS AND SPURIOUS EMISSIONS (LOW CHANNEL, HORIZONTAL)

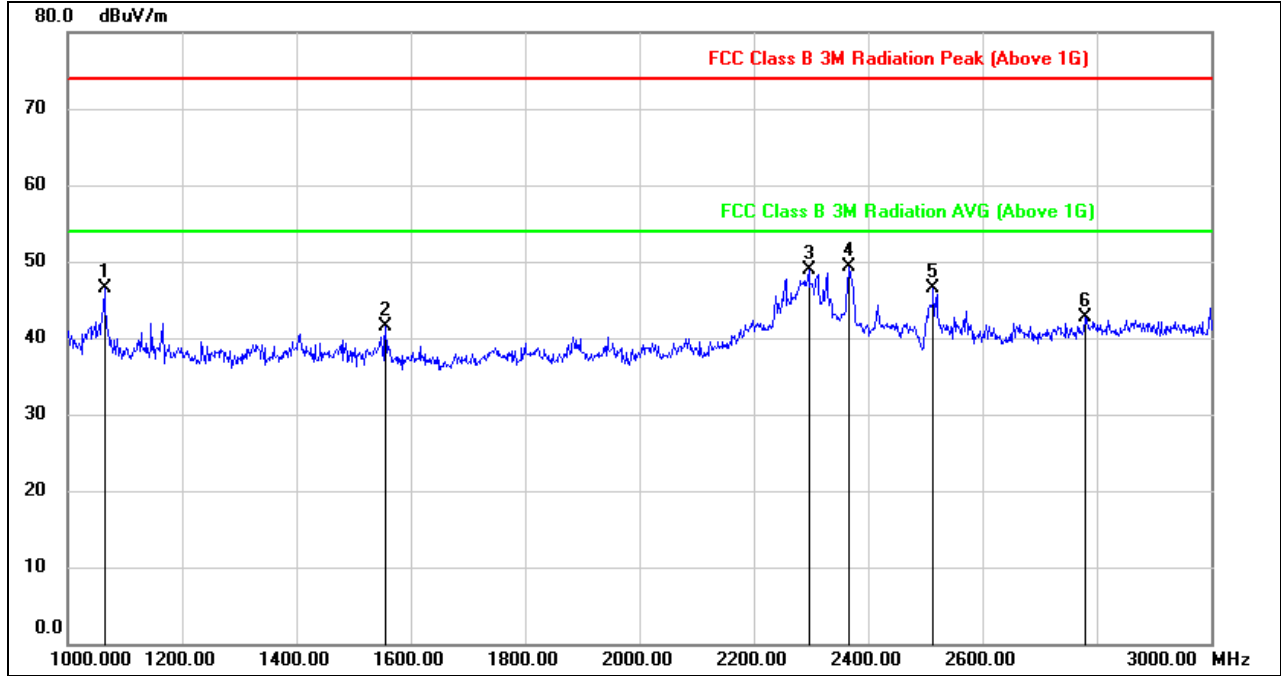

No.	Frequency (MHz)	Reading (dBuV)	Correct (dB/m)	Result (dBuV/m)	Limit (dBuV/m)	Margin (dB)	Remark
1	1064.000	60.05	-13.62	46.43	74.00	-27.57	peak
2	1556.000	53.82	-12.34	41.48	74.00	-32.52	peak
3	2296.000	56.36	-7.41	48.95	74.00	-25.05	peak
4	2366.000	57.10	-7.87	49.23	74.00	-24.77	peak
5	2514.000	54.85	-8.38	46.47	74.00	-27.53	peak
6	2780.000	49.85	-7.07	42.78	74.00	-31.22	peak

- Note: 1. Measurement = Reading Level + Correct Factor.  
 2. If Peak Result complies with AV limit, AV Result is deemed to comply with AV limit.  
 3. Peak: Peak detector.



**HARMONICS AND SPURIOUS EMISSIONS (LOW CHANNEL, VERTICAL)**

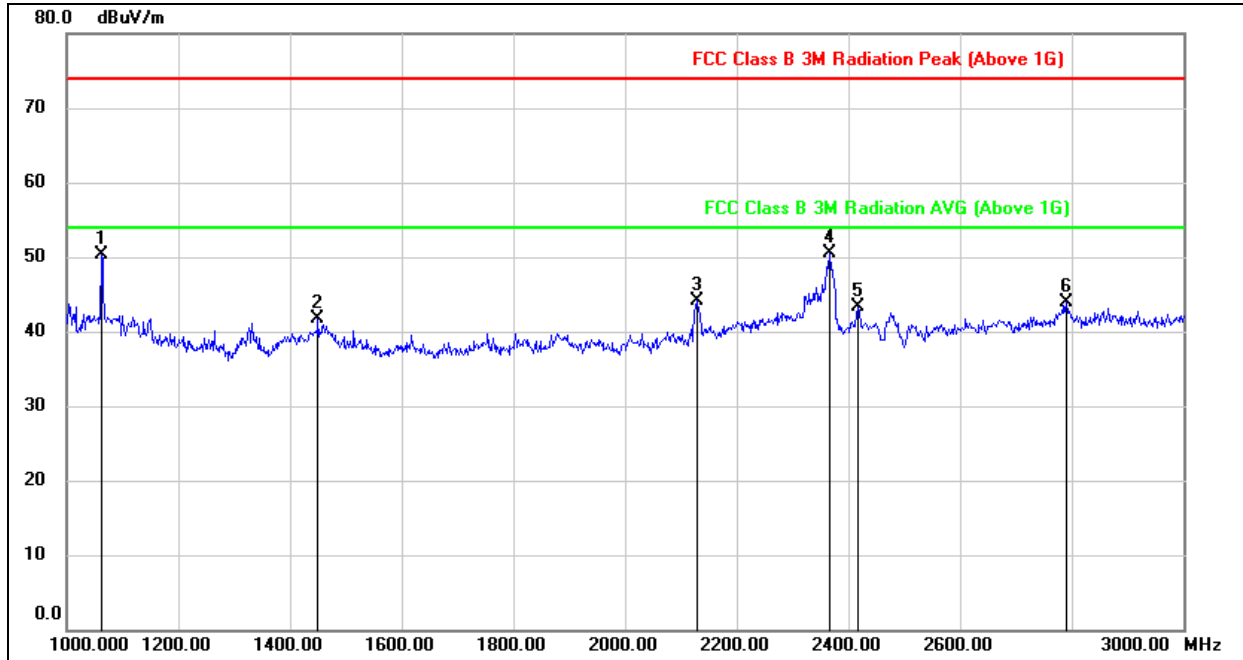

No.	Frequency (MHz)	Reading (dBuV)	Correct (dB/m)	Result (dBuV/m)	Limit (dBuV/m)	Margin (dB)	Remark
1	1062.000	64.29	-13.92	50.37	74.00	-23.63	peak
2	1450.000	53.92	-12.27	41.65	74.00	-32.35	peak
3	2128.000	53.45	-9.31	44.14	74.00	-29.86	peak
4	2366.000	58.18	-7.77	50.41	74.00	-23.59	peak
5	2416.000	51.46	-8.08	43.38	74.00	-30.62	peak
6	2790.000	50.95	-7.03	43.92	74.00	-30.08	peak

Note: 1. Measurement = Reading Level + Correct Factor.  
 2. If Peak Result complies with AV limit, AV Result is deemed to comply with AV limit.  
 3. Peak: Peak detector.



**HARMONICS AND SPURIOUS EMISSIONS (MID CHANNEL, HORIZONTAL)**

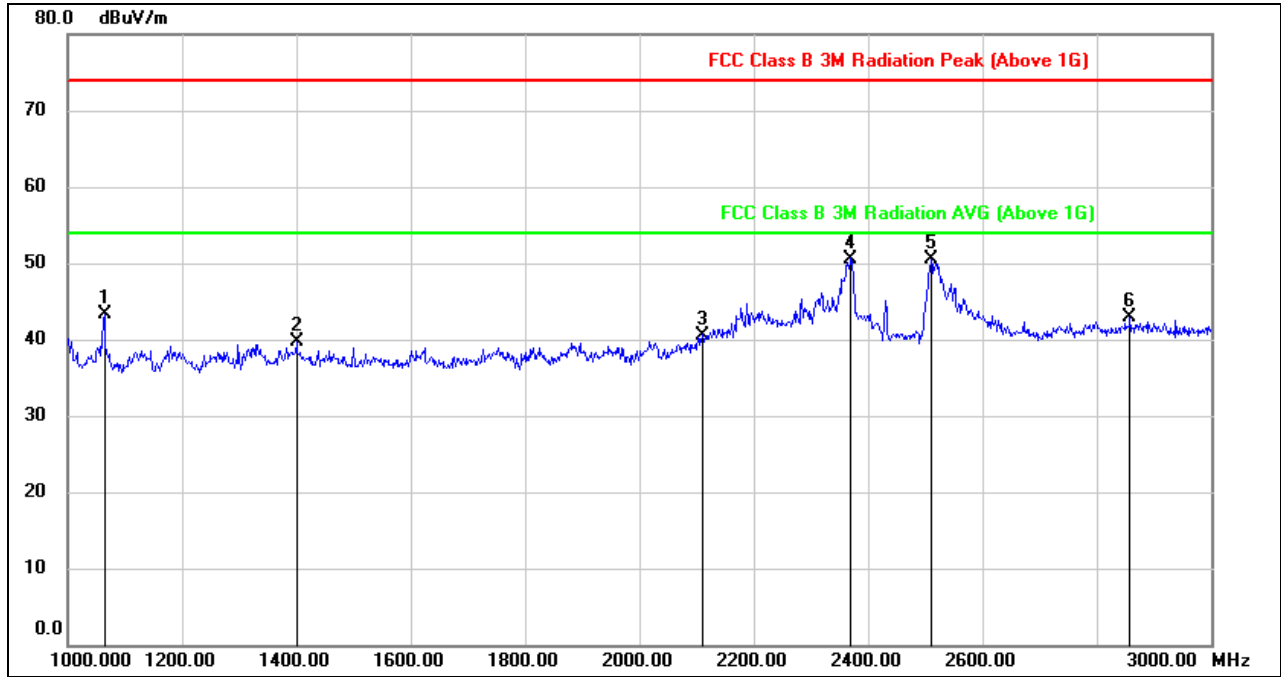

No.	Frequency (MHz)	Reading (dBuV)	Correct (dB/m)	Result (dBuV/m)	Limit (dBuV/m)	Margin (dB)	Remark
1	1064.000	56.94	-13.62	43.32	74.00	-30.68	peak
2	1400.000	51.68	-12.06	39.62	74.00	-34.38	peak
3	2110.000	50.04	-9.44	40.60	74.00	-33.40	peak
4	2370.000	58.49	-7.89	50.60	74.00	-23.40	peak
5	2510.000	58.91	-8.39	50.52	74.00	-23.48	peak
6	2858.000	49.65	-6.67	42.98	74.00	-31.02	peak

- Note: 1. Measurement = Reading Level + Correct Factor.  
 2. If Peak Result complies with AV limit, AV Result is deemed to comply with AV limit.  
 3. Peak: Peak detector.



**HARMONICS AND SPURIOUS EMISSIONS (MID CHANNEL, VERTICAL)**

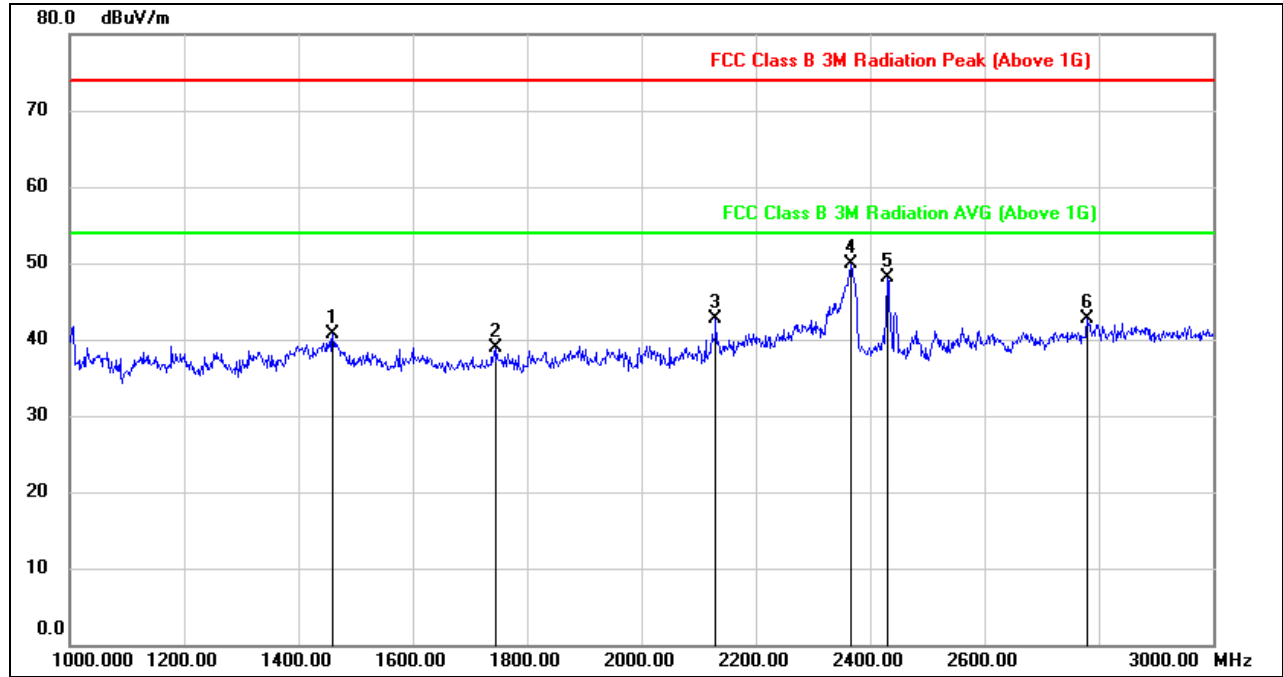

No.	Frequency (MHz)	Reading (dBuV)	Correct (dB/m)	Result (dBuV/m)	Limit (dBuV/m)	Margin (dB)	Remark
1	1460.000	52.95	-12.28	40.67	74.00	-33.33	peak
2	1746.000	50.15	-11.29	38.86	74.00	-35.14	peak
3	2130.000	52.01	-9.28	42.73	74.00	-31.27	peak
4	2366.000	57.60	-7.77	49.83	74.00	-24.17	peak
5	2430.000	56.25	-8.15	48.10	74.00	-25.90	peak
6	2780.000	49.90	-7.11	42.79	74.00	-31.21	peak

- Note: 1. Measurement = Reading Level + Correct Factor.  
 2. If Peak Result complies with AV limit, AV Result is deemed to comply with AV limit.  
 3. Peak: Peak detector.



**HARMONICS AND SPURIOUS EMISSIONS (HIGH CHANNEL, HORIZONTAL)**

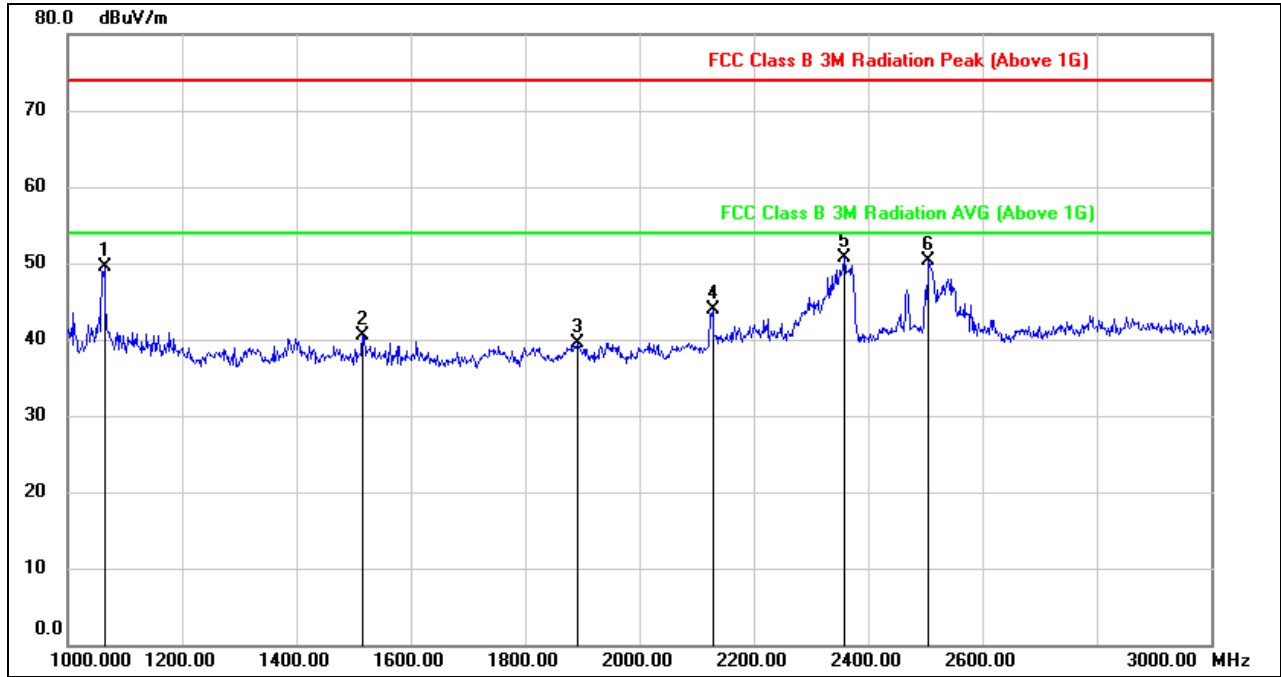

No.	Frequency (MHz)	Reading (dBuV)	Correct (dB/m)	Result (dBuV/m)	Limit (dBuV/m)	Margin (dB)	Remark
1	1064.000	63.03	-13.62	49.41	74.00	-24.59	peak
2	1516.000	52.78	-12.24	40.54	74.00	-33.46	peak
3	1892.000	50.32	-10.76	39.56	74.00	-34.44	peak
4	2128.000	53.21	-9.21	44.00	74.00	-30.00	peak
5	2358.000	58.53	-7.80	50.73	74.00	-23.27	peak
6	2506.000	58.80	-8.40	50.40	74.00	-23.60	peak

- Note: 1. Measurement = Reading Level + Correct Factor.  
 2. If Peak Result complies with AV limit, AV Result is deemed to comply with AV limit.  
 3. Peak: Peak detector.



**HARMONICS AND SPURIOUS EMISSIONS (HIGH CHANNEL, VERTICAL)**

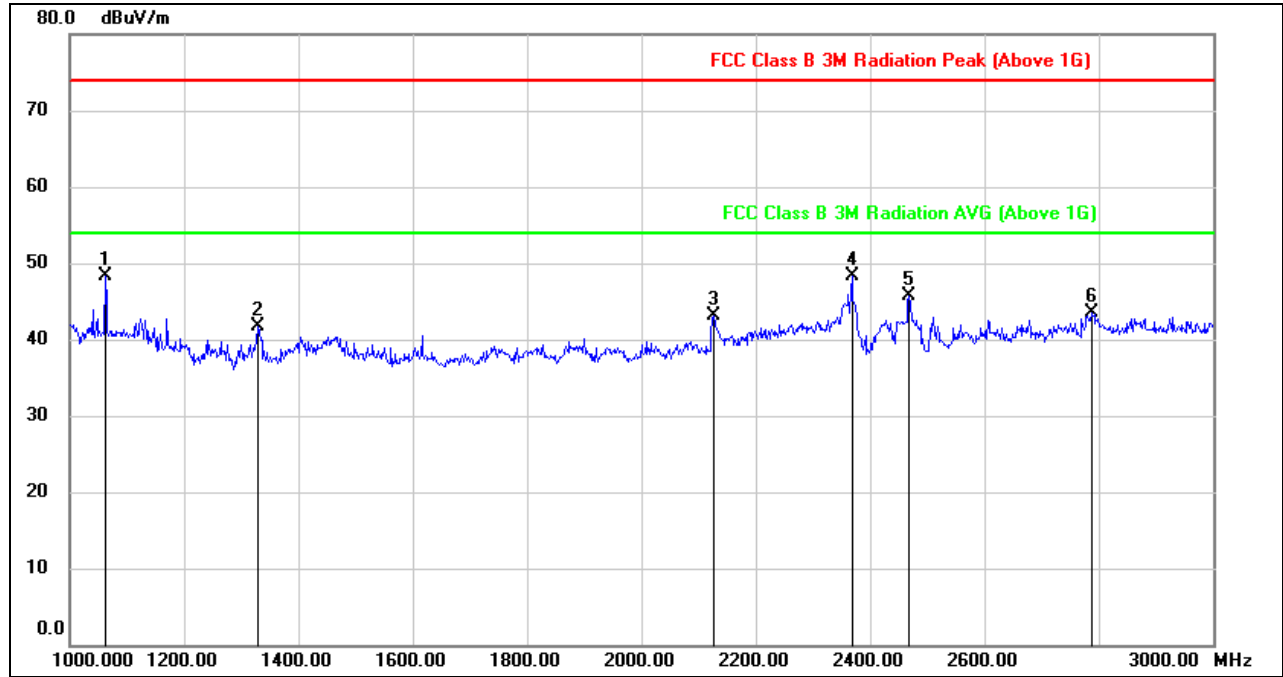

No.	Frequency (MHz)	Reading (dBuV)	Correct (dB/m)	Result (dBuV/m)	Limit (dBuV/m)	Margin (dB)	Remark
1	1062.000	62.27	-13.92	48.35	74.00	-25.65	peak
2	1330.000	54.27	-12.50	41.77	74.00	-32.23	peak
3	2126.000	52.52	-9.34	43.18	74.00	-30.82	peak
4	2368.000	56.05	-7.78	48.27	74.00	-25.73	peak
5	2468.000	53.93	-8.28	45.65	74.00	-28.35	peak
6	2788.000	50.50	-7.05	43.45	74.00	-30.55	peak

- Note: 1. Measurement = Reading Level + Correct Factor.  
2. If Peak Result complies with AV limit, AV Result is deemed to comply with AV limit.  
3. Peak: Peak detector.





### 9.2.3. 802.11n HT20 MODE

#### HARMONICS AND SPURIOUS EMISSIONS (LOW CHANNEL, HORIZONTAL)

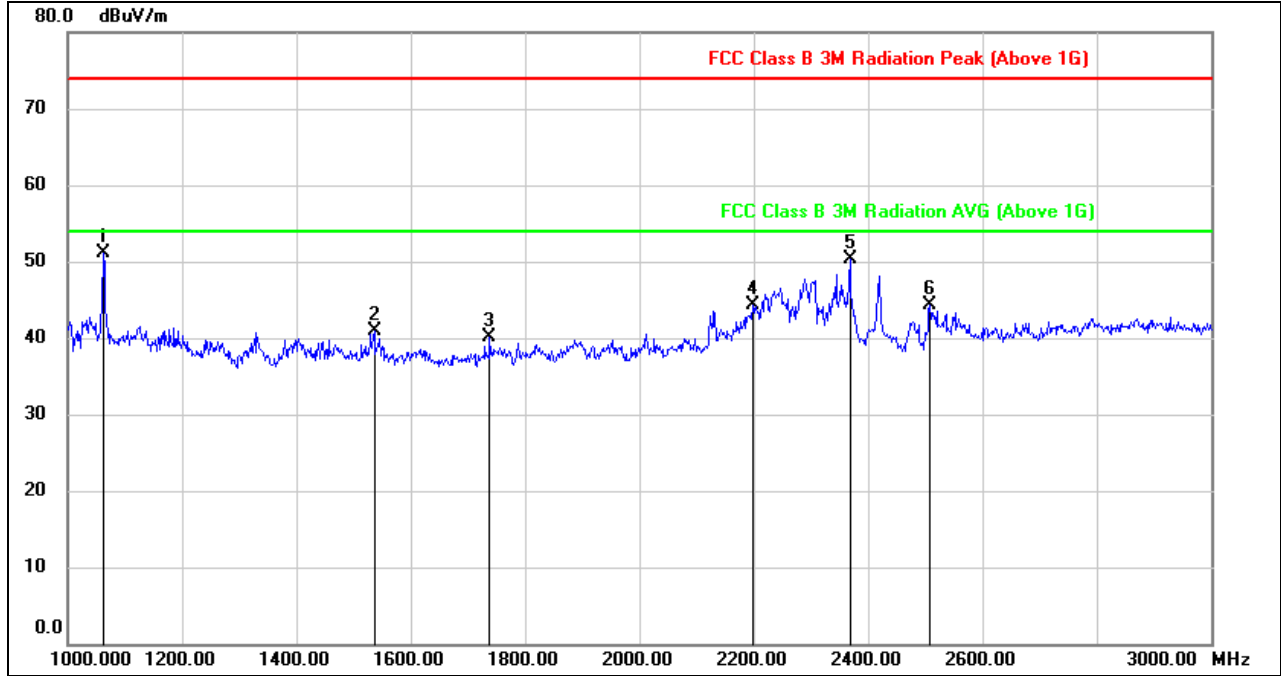

No.	Frequency (MHz)	Reading (dBuV)	Correct (dB/m)	Result (dBuV/m)	Limit (dBuV/m)	Margin (dB)	Remark
1	1062.000	64.69	-13.62	51.07	74.00	-22.93	peak
2	1536.000	53.19	-12.32	40.87	74.00	-33.13	peak
3	1738.000	51.46	-11.33	40.13	74.00	-33.87	peak
4	2198.000	52.70	-8.31	44.39	74.00	-29.61	peak
5	2368.000	58.18	-7.88	50.30	74.00	-23.70	peak
6	2508.000	52.68	-8.40	44.28	74.00	-29.72	peak

Note: 1. Measurement = Reading Level + Correct Factor.  
 2. If Peak Result complies with AV limit, AV Result is deemed to comply with AV limit.  
 3. Peak: Peak detector.



**HARMONICS AND SPURIOUS EMISSIONS (LOW CHANNEL, VERTICAL)**

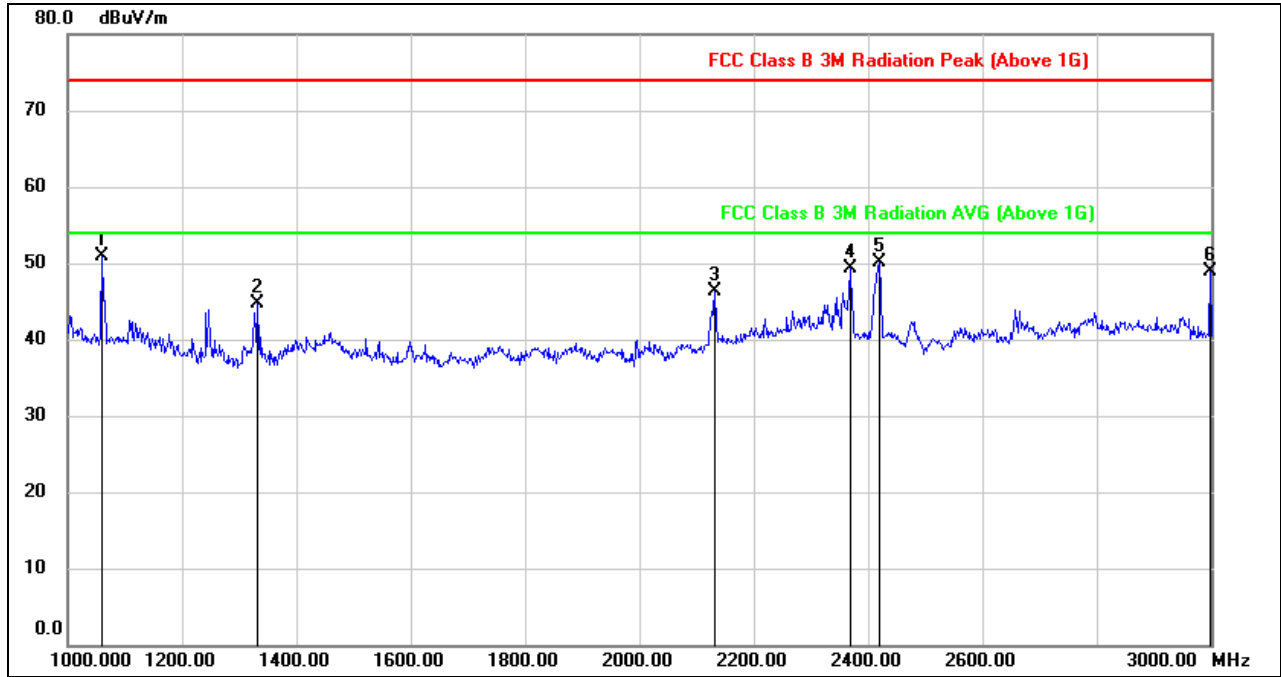

No.	Frequency (MHz)	Reading (dBuV)	Correct (dB/m)	Result (dBuV/m)	Limit (dBuV/m)	Margin (dB)	Remark
1	1060.000	64.92	-13.92	51.00	74.00	-23.00	peak
2	1332.000	57.23	-12.48	44.75	74.00	-29.25	peak
3	2132.000	55.65	-9.26	46.39	74.00	-27.61	peak
4	2368.000	57.05	-7.78	49.27	74.00	-24.73	peak
5	2420.000	58.11	-8.10	50.01	74.00	-23.99	peak
6	2998.000	55.46	-6.60	48.86	74.00	-25.14	peak

- Note: 1. Measurement = Reading Level + Correct Factor.  
 2. If Peak Result complies with AV limit, AV Result is deemed to comply with AV limit.  
 3. Peak: Peak detector.



**HARMONICS AND SPURIOUS EMISSIONS (MID CHANNEL, HORIZONTAL)**

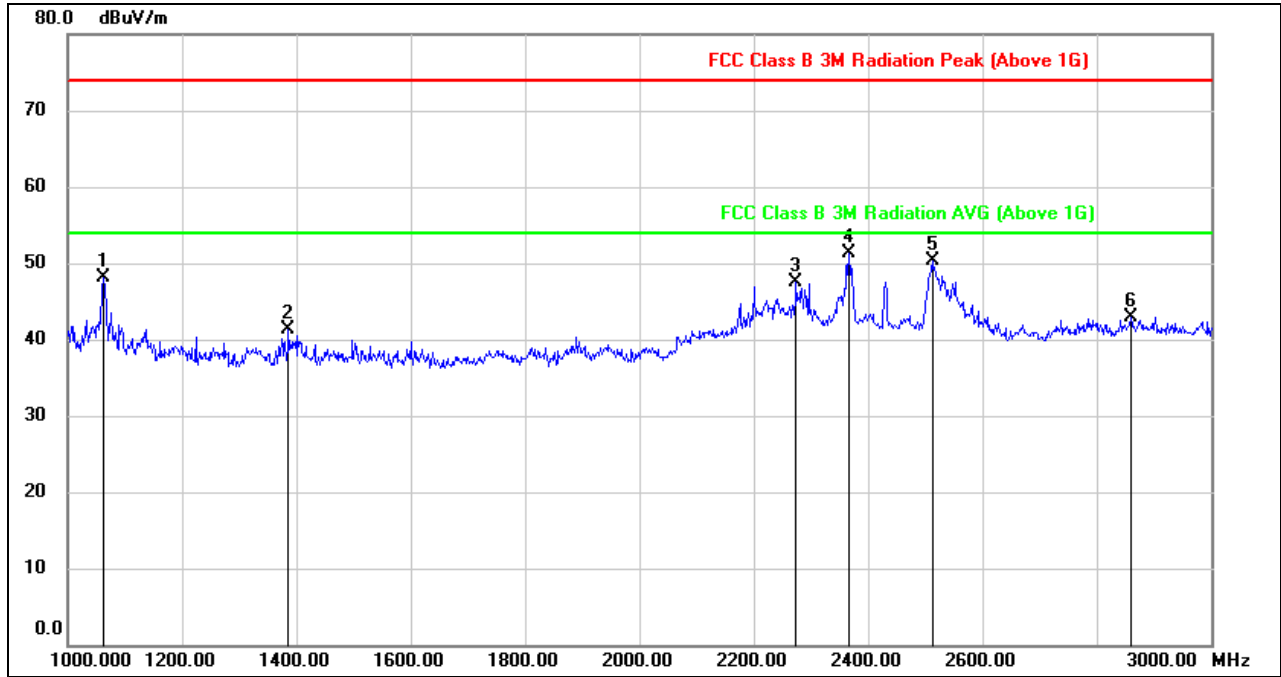

No.	Frequency (MHz)	Reading (dBuV)	Correct (dB/m)	Result (dBuV/m)	Limit (dBuV/m)	Margin (dB)	Remark
1	1062.000	61.74	-13.62	48.12	74.00	-25.88	peak
2	1386.000	53.55	-12.15	41.40	74.00	-32.60	peak
3	2274.000	55.03	-7.50	47.53	74.00	-26.47	peak
4	2366.000	59.17	-7.87	51.30	74.00	-22.70	peak
5	2512.000	58.74	-8.39	50.35	74.00	-23.65	peak
6	2860.000	49.58	-6.66	42.92	74.00	-31.08	peak

- Note: 1. Measurement = Reading Level + Correct Factor.  
 2. If Peak Result complies with AV limit, AV Result is deemed to comply with AV limit.  
 3. Peak: Peak detector.



**HARMONICS AND SPURIOUS EMISSIONS (MID CHANNEL, VERTICAL)**

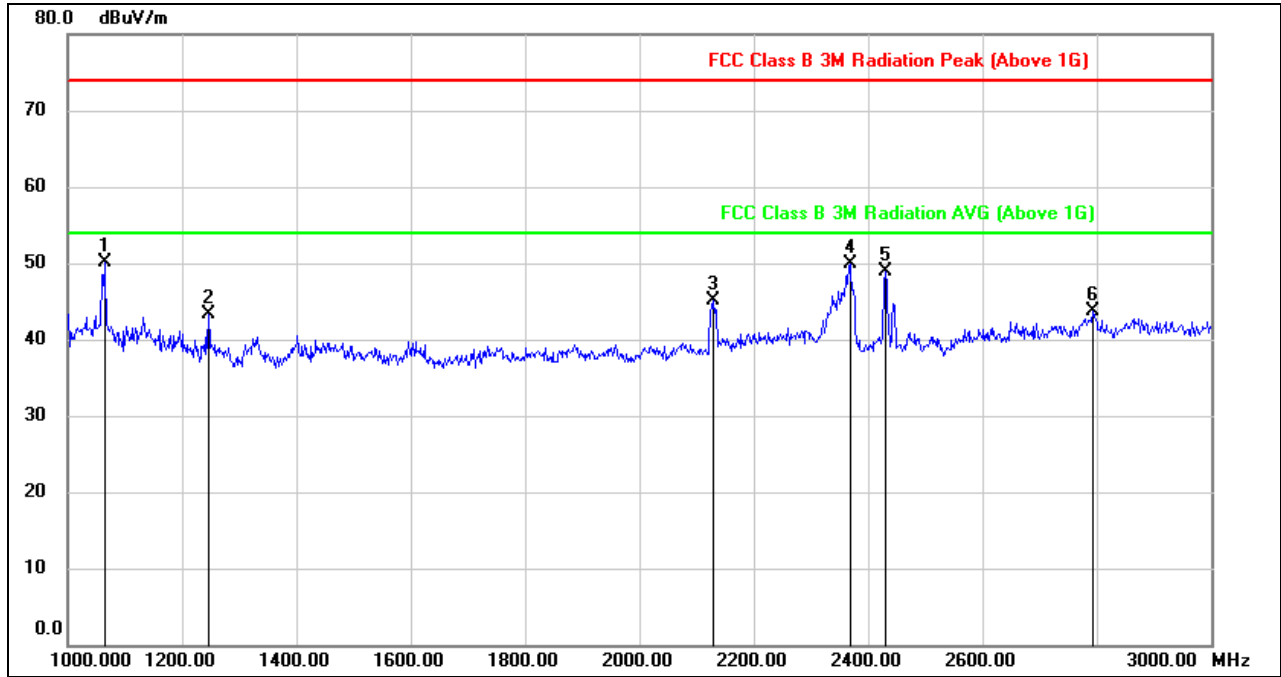

No.	Frequency (MHz)	Reading (dBuV)	Correct (dB/m)	Result (dBuV/m)	Limit (dBuV/m)	Margin (dB)	Remark
1	1064.000	64.03	-13.92	50.11	74.00	-23.89	peak
2	1246.000	56.15	-12.76	43.39	74.00	-30.61	peak
3	2130.000	54.31	-9.28	45.03	74.00	-28.97	peak
4	2368.000	57.62	-7.78	49.84	74.00	-24.16	peak
5	2430.000	57.09	-8.15	48.94	74.00	-25.06	peak
6	2792.000	50.73	-7.02	43.71	74.00	-30.29	peak

- Note: 1. Measurement = Reading Level + Correct Factor.  
2. If Peak Result complies with AV limit, AV Result is deemed to comply with AV limit.  
3. Peak: Peak detector.



**HARMONICS AND SPURIOUS EMISSIONS (HIGH CHANNEL, HORIZONTAL)**

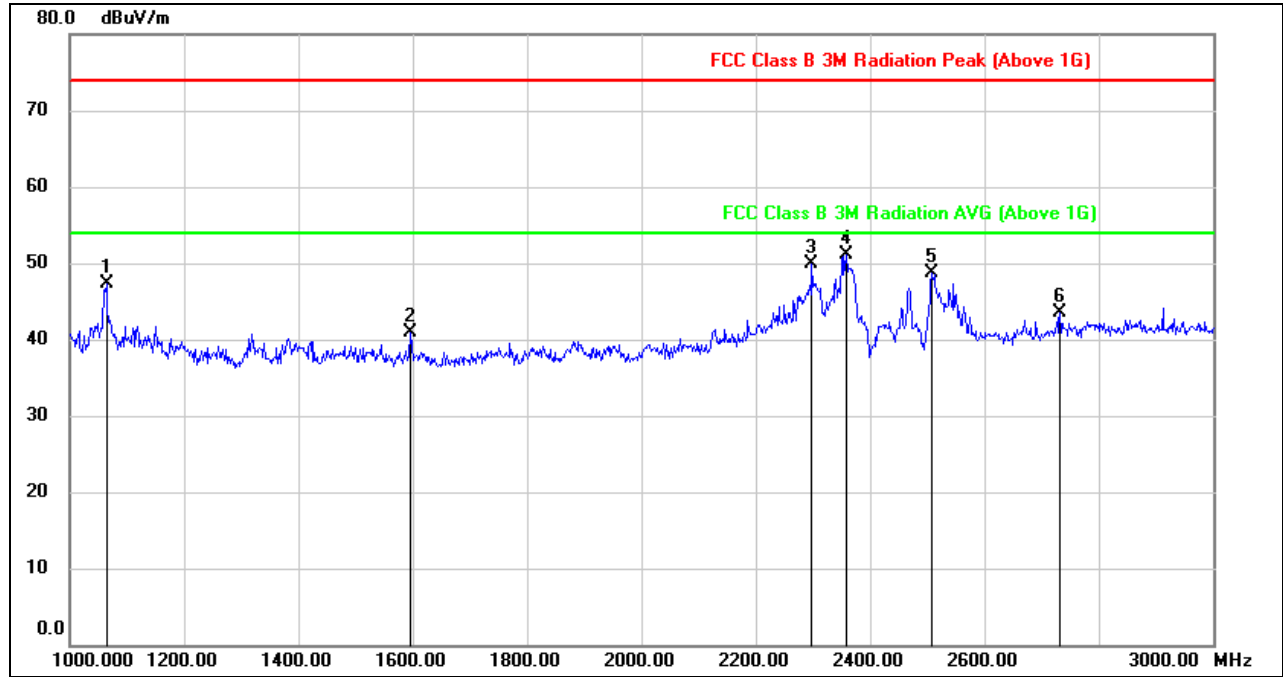

No.	Frequency (MHz)	Reading (dBuV)	Correct (dB/m)	Result (dBuV/m)	Limit (dBuV/m)	Margin (dB)	Remark
1	1064.000	60.99	-13.62	47.37	74.00	-26.63	peak
2	1596.000	53.06	-12.09	40.97	74.00	-33.03	peak
3	2298.000	57.22	-7.41	49.81	74.00	-24.19	peak
4	2358.000	58.81	-7.80	51.01	74.00	-22.99	peak
5	2508.000	57.05	-8.40	48.65	74.00	-25.35	peak
6	2732.000	50.85	-7.36	43.49	74.00	-30.51	peak

- Note: 1. Measurement = Reading Level + Correct Factor.  
 2. If Peak Result complies with AV limit, AV Result is deemed to comply with AV limit.  
 3. Peak: Peak detector.



**HARMONICS AND SPURIOUS EMISSIONS (HIGH CHANNEL, VERTICAL)**

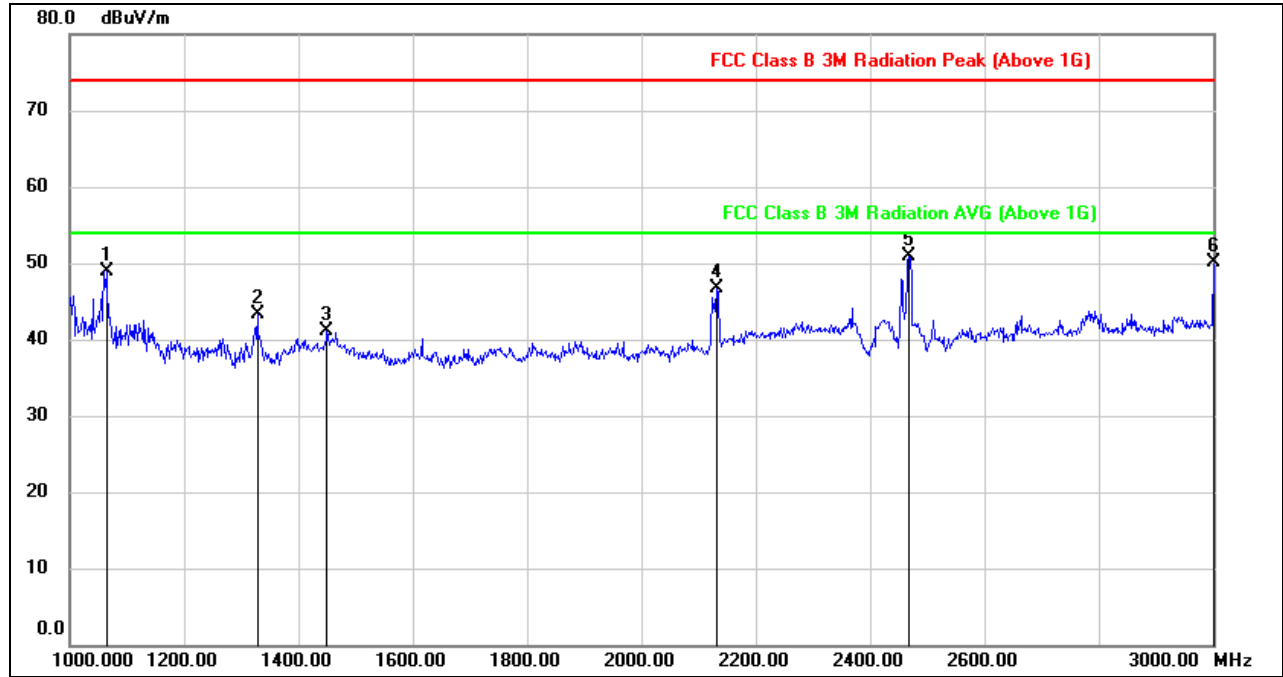

No.	Frequency (MHz)	Reading (dBuV)	Correct (dB/m)	Result (dBuV/m)	Limit (dBuV/m)	Margin (dB)	Remark
1	1064.000	62.91	-13.92	48.99	74.00	-25.01	peak
2	1328.000	55.75	-12.51	43.24	74.00	-30.76	peak
3	1450.000	53.41	-12.27	41.14	74.00	-32.86	peak
4	2132.000	55.89	-9.26	46.63	74.00	-27.37	peak
5	2468.000	59.13	-8.28	50.85	74.00	-23.15	peak
6	3000.000	56.67	-6.60	50.07	74.00	-23.93	peak

- Note: 1. Measurement = Reading Level + Correct Factor.  
 2. If Peak Result complies with AV limit, AV Result is deemed to comply with AV limit.  
 3. Peak: Peak detector.



### 9.2.4. 802.11n HT40 MODE

#### HARMONICS AND SPURIOUS EMISSIONS (LOW CHANNEL, HORIZONTAL)

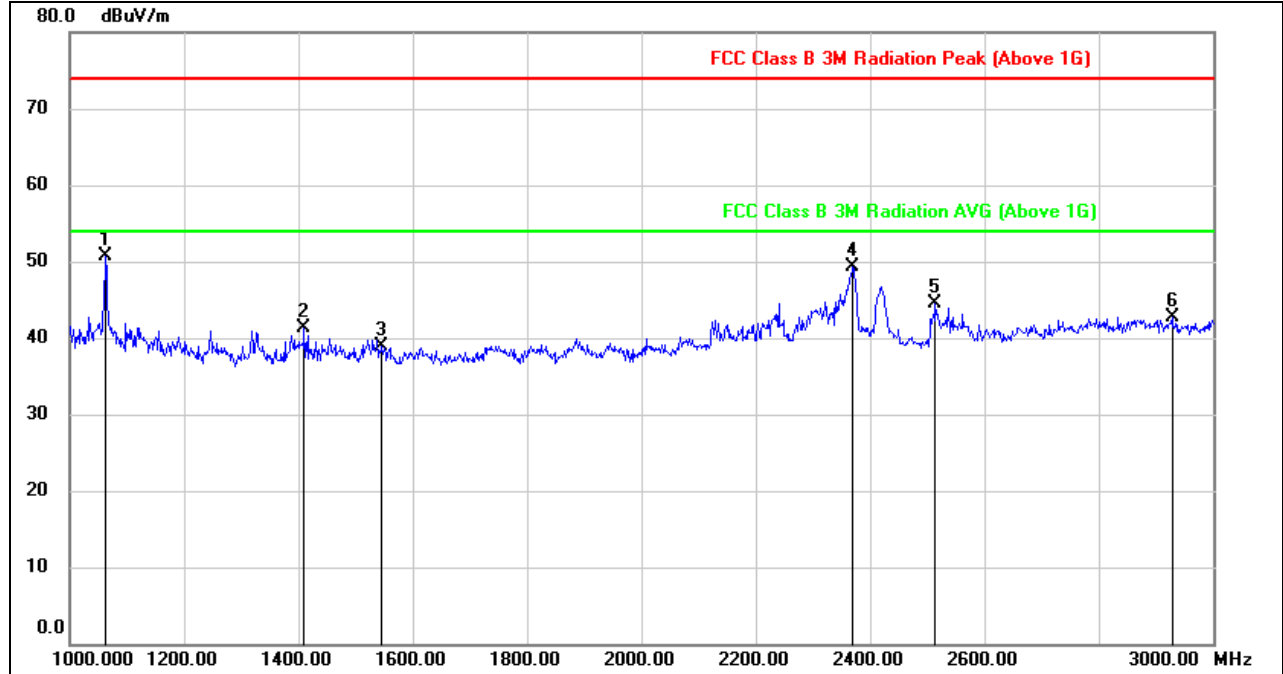

No.	Frequency (MHz)	Reading (dBuV)	Correct (dB/m)	Result (dBuV/m)	Limit (dBuV/m)	Margin (dB)	Remark
1	1062.000	64.41	-13.62	50.79	74.00	-23.21	peak
2	1410.000	53.38	-12.10	41.28	74.00	-32.72	peak
3	1546.000	51.33	-12.35	38.98	74.00	-35.02	peak
4	2370.000	57.22	-7.89	49.33	74.00	-24.67	peak
5	2514.000	52.87	-8.38	44.49	74.00	-29.51	peak
6	2928.000	49.25	-6.55	42.70	74.00	-31.30	peak

- Note: 1. Measurement = Reading Level + Correct Factor.  
 2. If Peak Result complies with AV limit, AV Result is deemed to comply with AV limit.  
 3. Peak: Peak detector.



**HARMONICS AND SPURIOUS EMISSIONS (LOW CHANNEL, VERTICAL)**

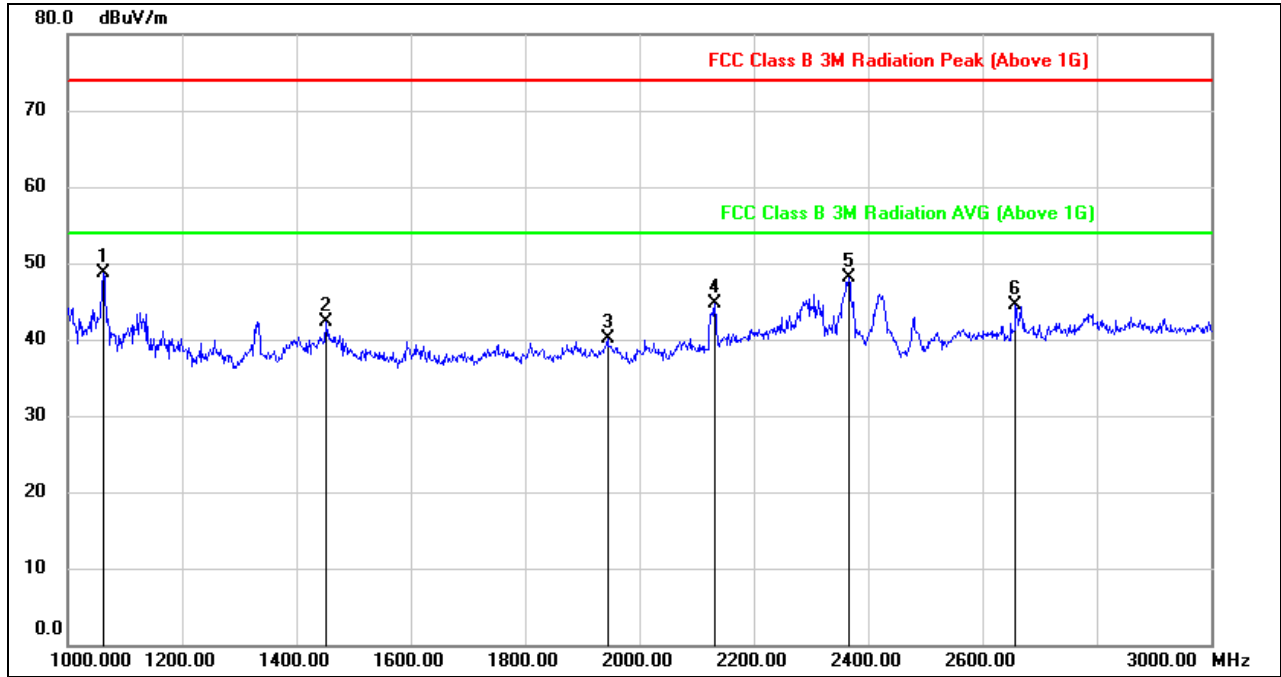

No.	Frequency (MHz)	Reading (dBuV)	Correct (dB/m)	Result (dBuV/m)	Limit (dBuV/m)	Margin (dB)	Remark
1	1062.000	62.62	-13.92	48.70	74.00	-25.30	peak
2	1452.000	54.67	-12.27	42.40	74.00	-31.60	peak
3	1944.000	50.90	-10.79	40.11	74.00	-33.89	peak
4	2132.000	53.87	-9.26	44.61	74.00	-29.39	peak
5	2366.000	55.87	-7.77	48.10	74.00	-25.90	peak
6	2658.000	52.34	-7.90	44.44	74.00	-29.56	peak

- Note: 1. Measurement = Reading Level + Correct Factor.  
 2. If Peak Result complies with AV limit, AV Result is deemed to comply with AV limit.  
 3. Peak: Peak detector.





**HARMONICS AND SPURIOUS EMISSIONS (MID CHANNEL, HORIZONTAL)**

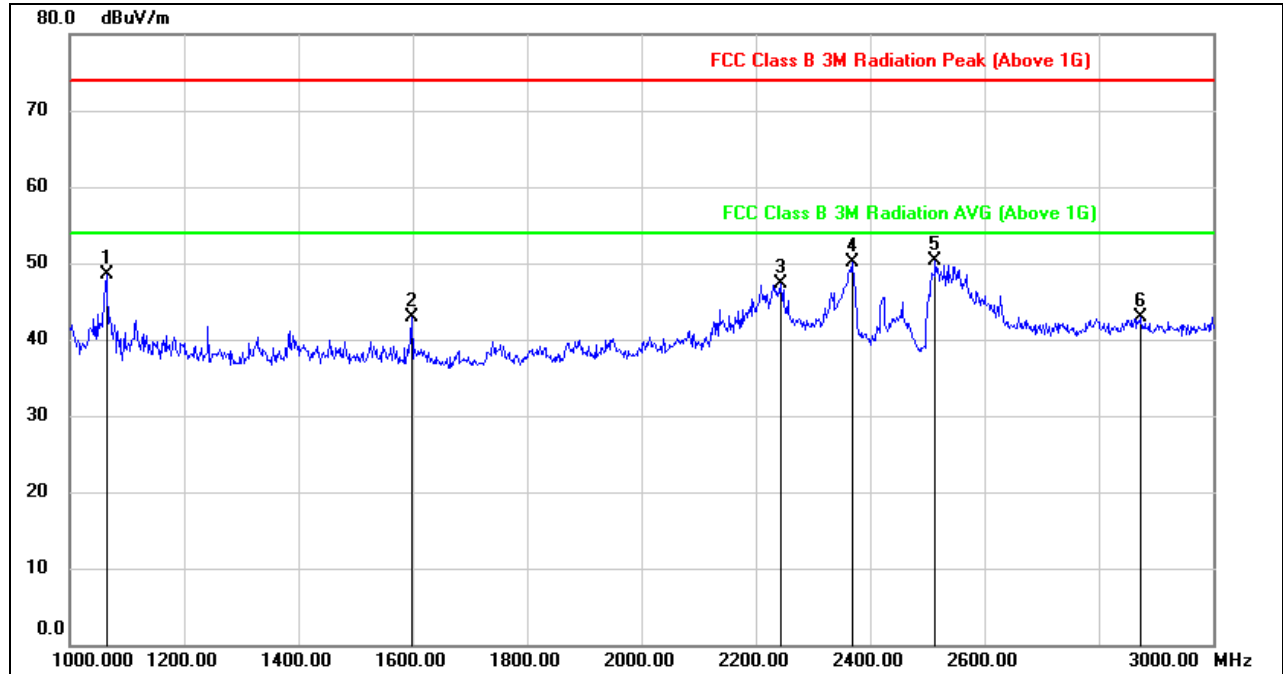

No.	Frequency (MHz)	Reading (dBuV)	Correct (dB/m)	Result (dBuV/m)	Limit (dBuV/m)	Margin (dB)	Remark
1	1064.000	62.03	-13.62	48.41	74.00	-25.59	peak
2	1598.000	54.99	-12.07	42.92	74.00	-31.08	peak
3	2244.000	55.00	-7.68	47.32	74.00	-26.68	peak
4	2368.000	58.07	-7.88	50.19	74.00	-23.81	peak
5	2514.000	58.67	-8.38	50.29	74.00	-23.71	peak
6	2872.000	49.52	-6.62	42.90	74.00	-31.10	peak

- Note: 1. Measurement = Reading Level + Correct Factor.  
 2. If Peak Result complies with AV limit, AV Result is deemed to comply with AV limit.  
 3. Peak: Peak detector.



**HARMONICS AND SPURIOUS EMISSIONS (MID CHANNEL, VERTICAL)**

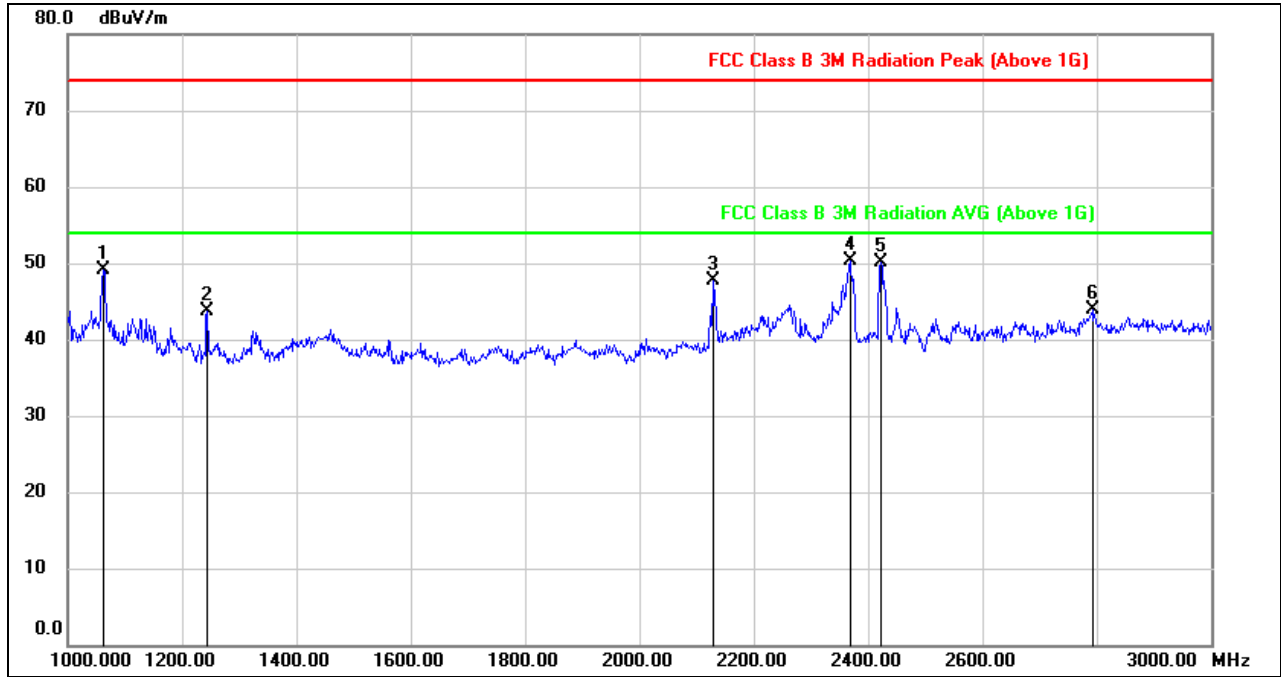

No.	Frequency (MHz)	Reading (dBuV)	Correct (dB/m)	Result (dBuV/m)	Limit (dBuV/m)	Margin (dB)	Remark
1	1062.000	63.09	-13.92	49.17	74.00	-24.83	peak
2	1244.000	56.53	-12.78	43.75	74.00	-30.25	peak
3	2128.000	57.08	-9.31	47.77	74.00	-26.23	peak
4	2368.000	58.06	-7.78	50.28	74.00	-23.72	peak
5	2422.000	58.20	-8.11	50.09	74.00	-23.91	peak
6	2792.000	50.98	-7.02	43.96	74.00	-30.04	peak

Note: 1. Measurement = Reading Level + Correct Factor.  
 2. If Peak Result complies with AV limit, AV Result is deemed to comply with AV limit.  
 3. Peak: Peak detector.



**HARMONICS AND SPURIOUS EMISSIONS (HIGH CHANNEL, HORIZONTAL)**

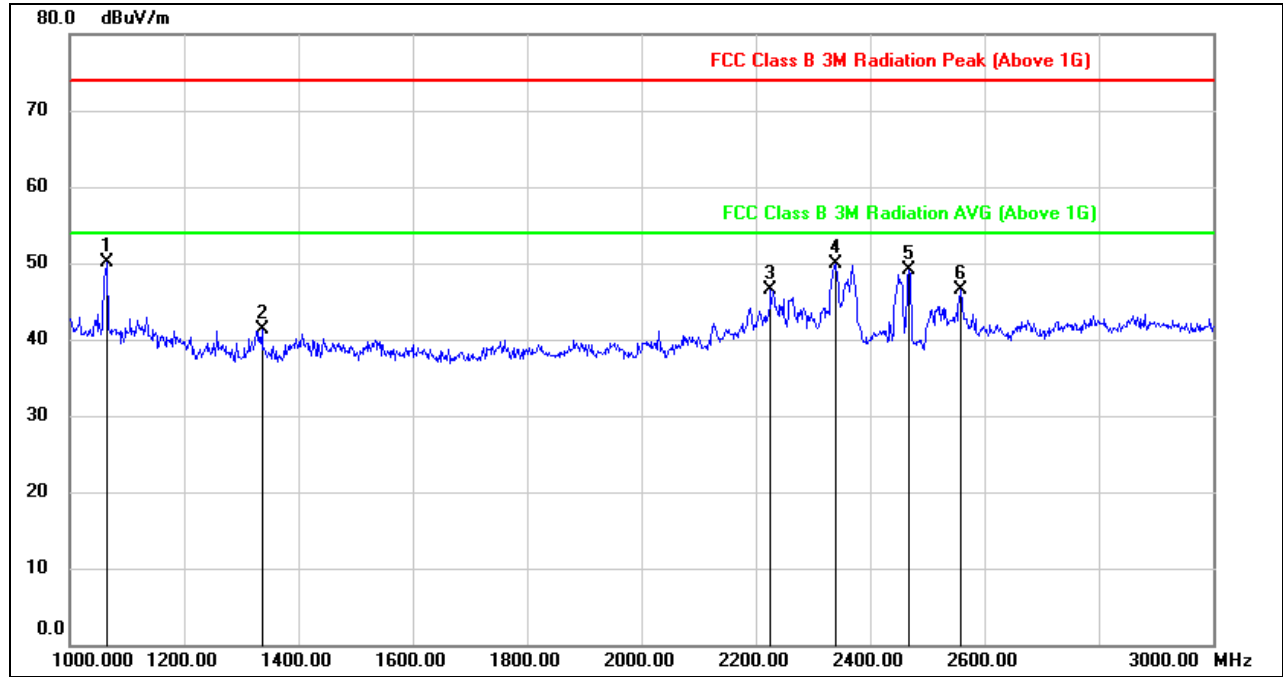

No.	Frequency (MHz)	Reading (dBuV)	Correct (dB/m)	Result (dBuV/m)	Limit (dBuV/m)	Margin (dB)	Remark
1	1066.000	63.64	-13.62	50.02	74.00	-23.98	peak
2	1336.000	53.70	-12.37	41.33	74.00	-32.67	peak
3	2226.000	54.39	-7.93	46.46	74.00	-27.54	peak
4	2340.000	57.49	-7.68	49.81	74.00	-24.19	peak
5	2468.000	57.48	-8.38	49.10	74.00	-24.90	peak
6	2558.000	54.77	-8.32	46.45	74.00	-27.55	peak

- Note: 1. Measurement = Reading Level + Correct Factor.  
 2. If Peak Result complies with AV limit, AV Result is deemed to comply with AV limit.  
 3. Peak: Peak detector.



**HARMONICS AND SPURIOUS EMISSIONS (HIGH CHANNEL, VERTICAL)**

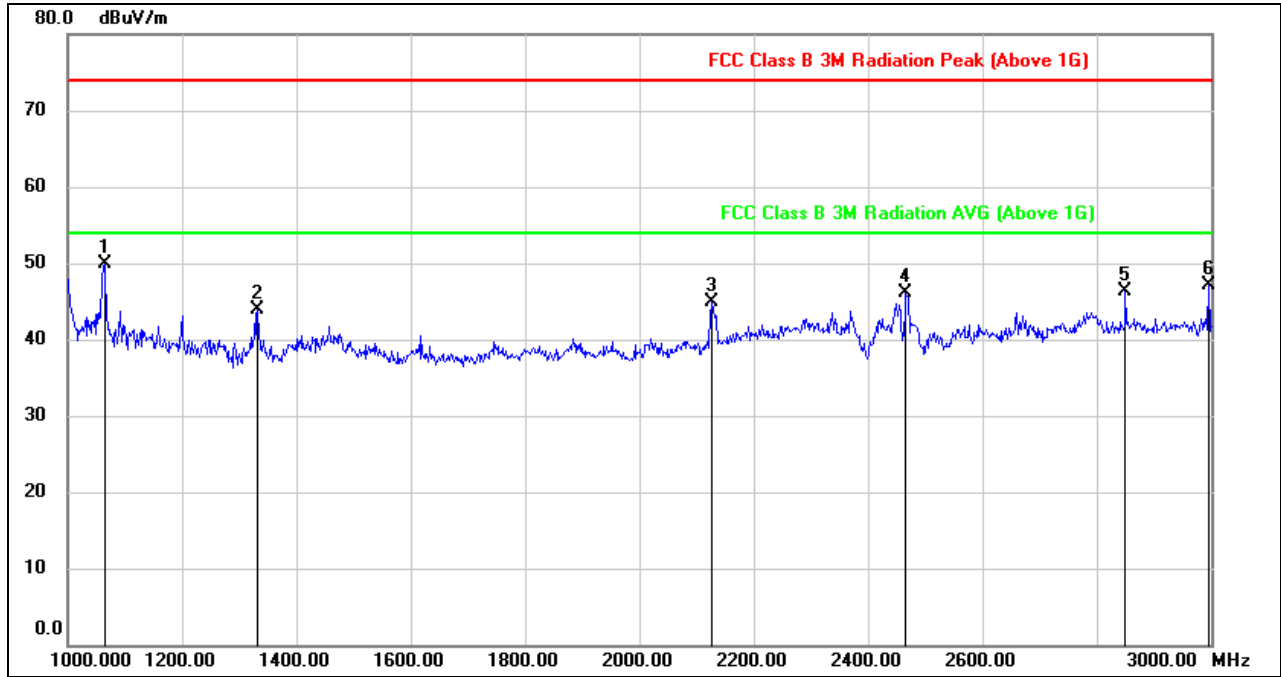

No.	Frequency (MHz)	Reading (dBuV)	Correct (dB/m)	Result (dBuV/m)	Limit (dBuV/m)	Margin (dB)	Remark
1	1064.000	63.89	-13.92	49.97	74.00	-24.03	peak
2	1332.000	56.41	-12.48	43.93	74.00	-30.07	peak
3	2126.000	54.18	-9.34	44.84	74.00	-29.16	peak
4	2466.000	54.37	-8.27	46.10	74.00	-27.90	peak
5	2850.000	52.91	-6.69	46.22	74.00	-27.78	peak
6	2996.000	53.77	-6.60	47.17	74.00	-26.83	peak

- Note: 1. Measurement = Reading Level + Correct Factor.  
 2. If Peak Result complies with AV limit, AV Result is deemed to comply with AV limit.  
 3. Peak: Peak detector.



### 9.3. SPURIOUS EMISSIONS (3~18GHz)

#### 9.3.1. 802.11b MODE

##### HARMONICS AND SPURIOUS EMISSIONS (LOW CHANNEL, HORIZONTAL)

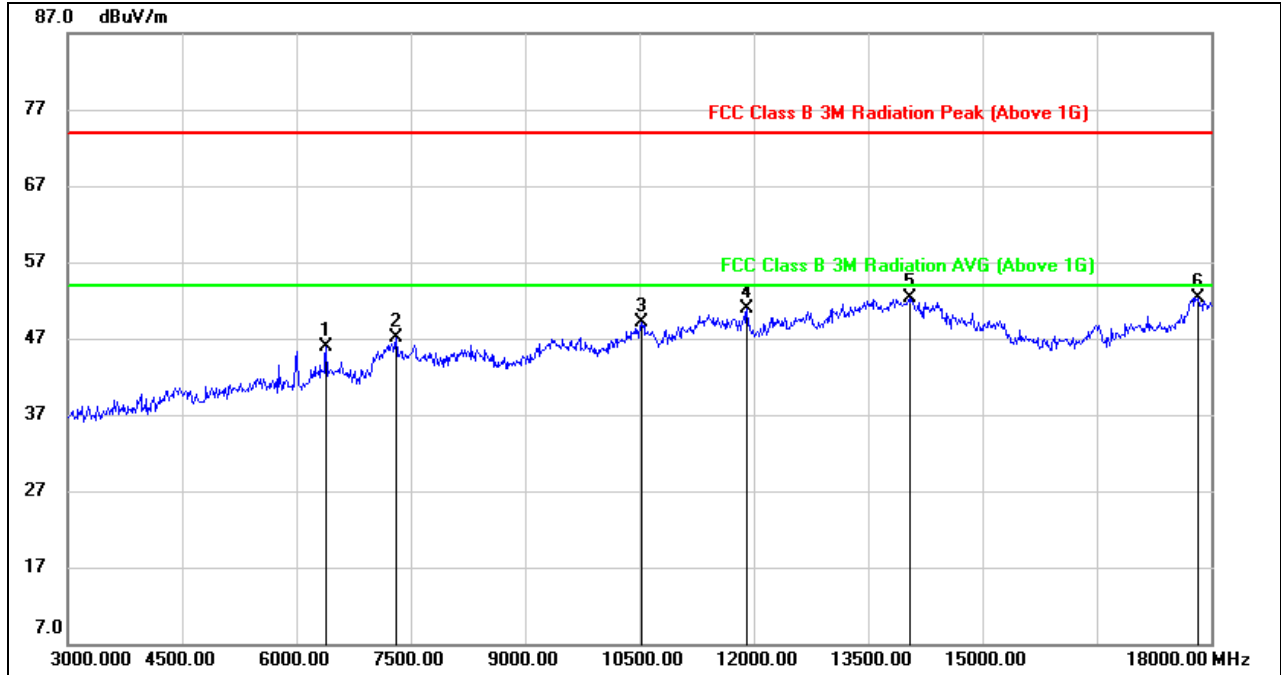

No.	Frequency (MHz)	Reading (dBuV)	Correct (dB/m)	Result (dBuV/m)	Limit (dBuV/m)	Margin (dB)	Remark
1	6390.000	41.25	4.65	45.90	74.00	-28.10	peak
2	7305.000	39.29	7.80	47.09	74.00	-26.91	peak
3	10530.000	35.30	13.76	49.06	74.00	-24.94	peak
4	11910.000	33.83	16.98	50.81	74.00	-23.19	peak
5	14040.000	31.75	20.64	52.39	74.00	-21.61	peak
6	17835.000	25.82	26.49	52.31	74.00	-21.69	peak

Note: 1. Measurement = Reading Level + Correct Factor.  
 2. If Peak Result complies with AV limit, AV Result is deemed to comply with AV limit.  
 3. Peak: Peak detector.



**HARMONICS AND SPURIOUS EMISSIONS (LOW CHANNEL, VERTICAL)**

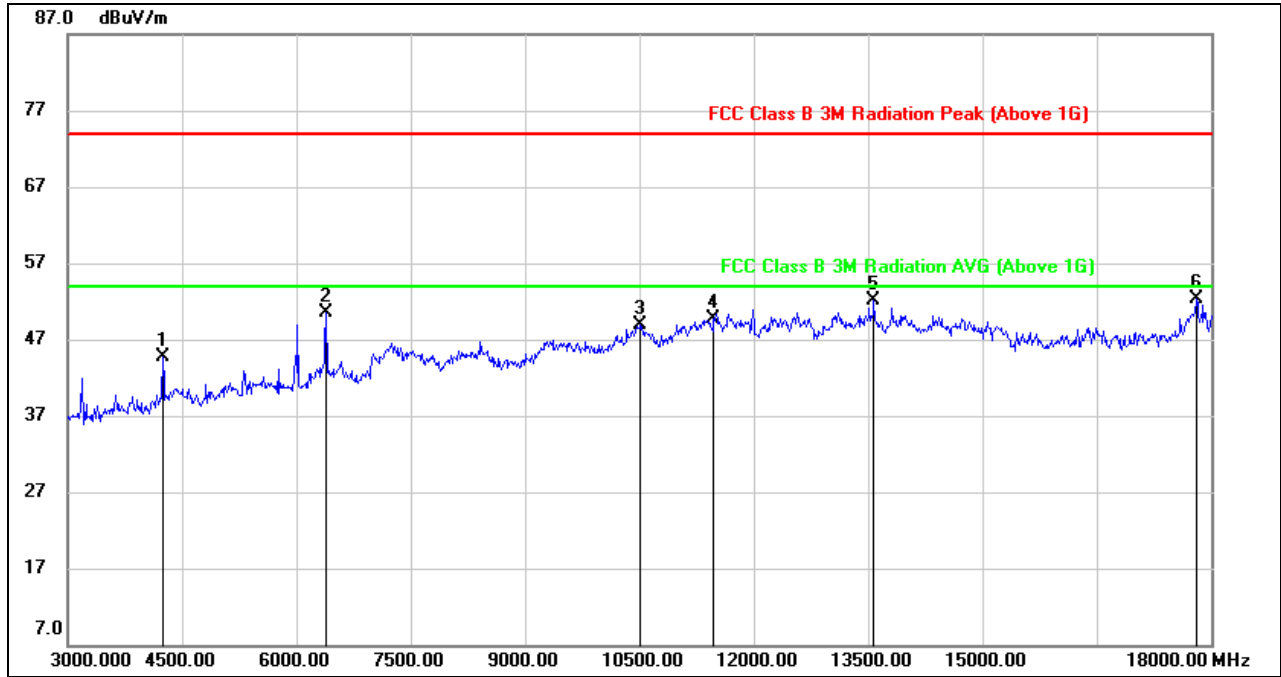

No.	Frequency (MHz)	Reading (dBuV)	Correct (dB/m)	Result (dBuV/m)	Limit (dBuV/m)	Margin (dB)	Remark
1	4245.000	46.54	-1.92	44.62	74.00	-29.38	peak
2	6390.000	45.77	4.73	50.50	74.00	-23.50	peak
3	10515.000	35.03	13.78	48.81	74.00	-25.19	peak
4	11475.000	33.76	15.85	49.61	74.00	-24.39	peak
5	13575.000	31.57	20.63	52.20	74.00	-21.80	peak
6	17805.000	25.56	26.80	52.36	74.00	-21.64	peak

- Note: 1. Measurement = Reading Level + Correct Factor.  
 2. If Peak Result complies with AV limit, AV Result is deemed to comply with AV limit.  
 3. Peak: Peak detector.



**HARMONICS AND SPURIOUS EMISSIONS (MID CHANNEL, HORIZONTAL)**

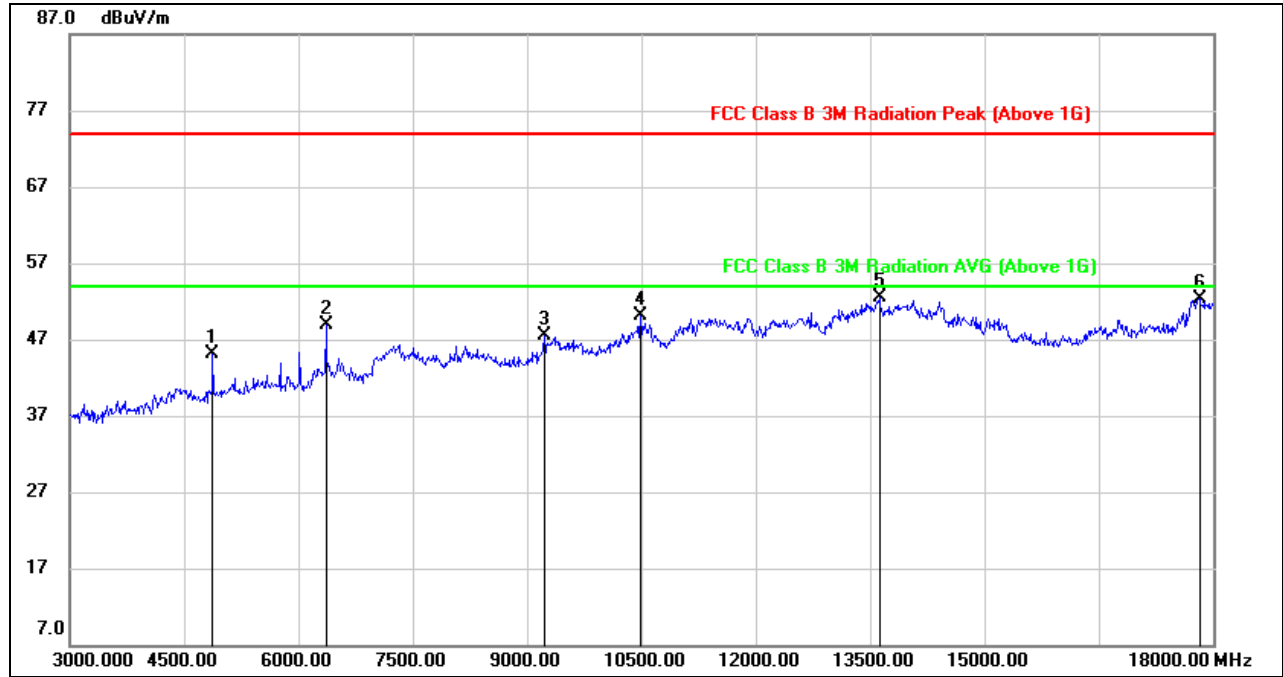

No.	Frequency (MHz)	Reading (dBuV)	Correct (dB/m)	Result (dBuV/m)	Limit (dBuV/m)	Margin (dB)	Remark
1	4875.000	44.70	0.38	45.08	74.00	-28.92	peak
2	6360.000	44.23	4.64	48.87	74.00	-25.13	peak
3	9225.000	37.12	10.30	47.42	74.00	-26.58	peak
4	10485.000	36.54	13.62	50.16	74.00	-23.84	peak
5	13620.000	31.96	20.51	52.47	74.00	-21.53	peak
6	17820.000	25.90	26.48	52.38	74.00	-21.62	peak

- Note: 1. Measurement = Reading Level + Correct Factor.  
 2. If Peak Result complies with AV limit, AV Result is deemed to comply with AV limit.  
 3. Peak: Peak detector.



**HARMONICS AND SPURIOUS EMISSIONS (MID CHANNEL, VERTICAL)**

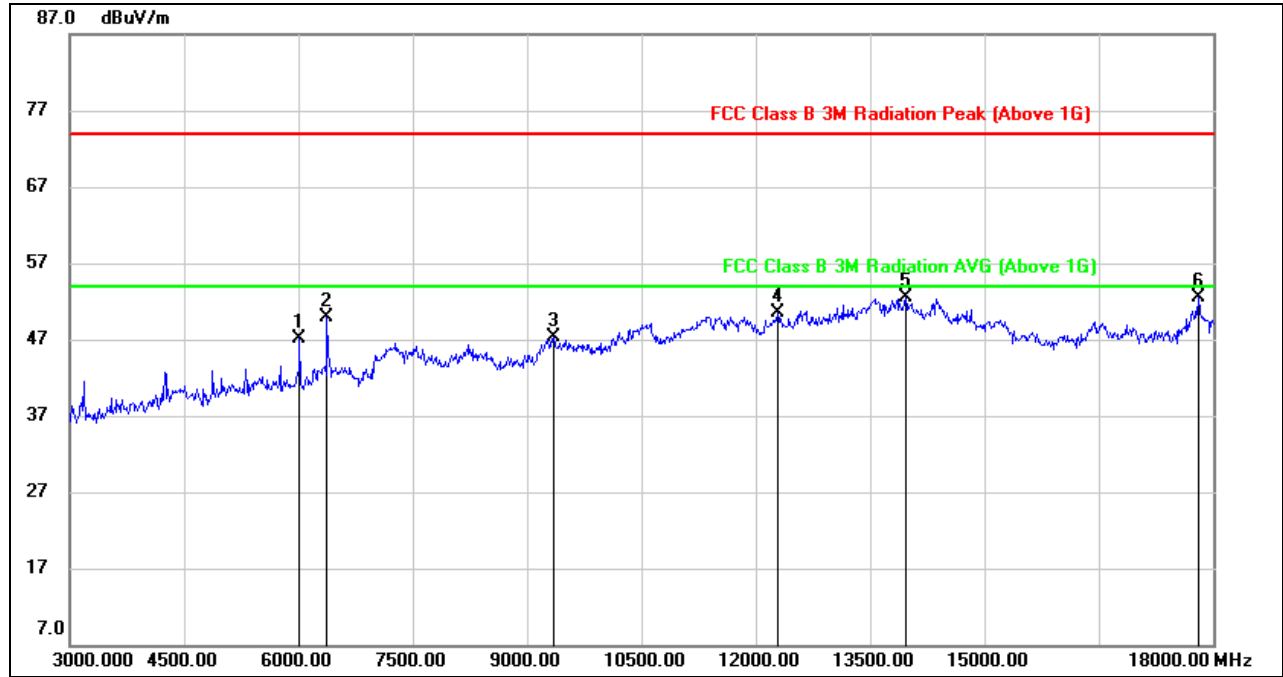

No.	Frequency (MHz)	Reading (dBuV)	Correct (dB/m)	Result (dBuV/m)	Limit (dBuV/m)	Margin (dB)	Remark
1	6015.000	43.66	3.35	47.01	74.00	-26.99	peak
2	6375.000	45.29	4.70	49.99	74.00	-24.01	peak
3	9345.000	36.46	10.93	47.39	74.00	-26.61	peak
4	12285.000	34.08	16.40	50.48	74.00	-23.52	peak
5	13965.000	31.72	20.76	52.48	74.00	-21.52	peak
6	17805.000	25.79	26.80	52.59	74.00	-21.41	peak

- Note: 1. Measurement = Reading Level + Correct Factor.  
 2. If Peak Result complies with AV limit, AV Result is deemed to comply with AV limit.  
 3. Peak: Peak detector.





**HARMONICS AND SPURIOUS EMISSIONS (HIGH CHANNEL, HORIZONTAL)**

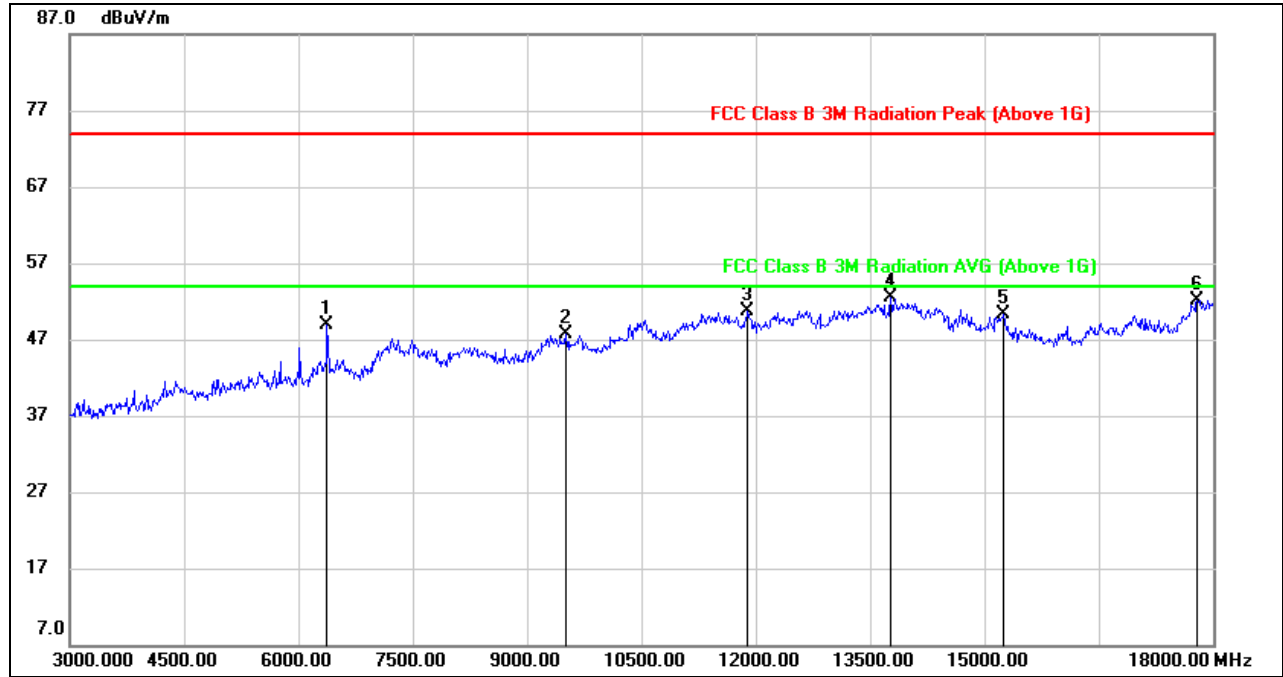

No.	Frequency (MHz)	Reading (dBuV)	Correct (dB/m)	Result (dBuV/m)	Limit (dBuV/m)	Margin (dB)	Remark
1	6375.000	44.23	4.65	48.88	74.00	-25.12	peak
2	9510.000	36.37	11.26	47.63	74.00	-26.37	peak
3	11895.000	33.74	17.04	50.78	74.00	-23.22	peak
4	13770.000	31.73	20.79	52.52	74.00	-21.48	peak
5	15255.000	32.68	17.60	50.28	74.00	-23.72	peak
6	17790.000	25.75	26.36	52.11	74.00	-21.89	peak

- Note: 1. Measurement = Reading Level + Correct Factor.  
 2. If Peak Result complies with AV limit, AV Result is deemed to comply with AV limit.  
 3. Peak: Peak detector.



**HARMONICS AND SPURIOUS EMISSIONS (HIGH CHANNEL, VERTICAL)**

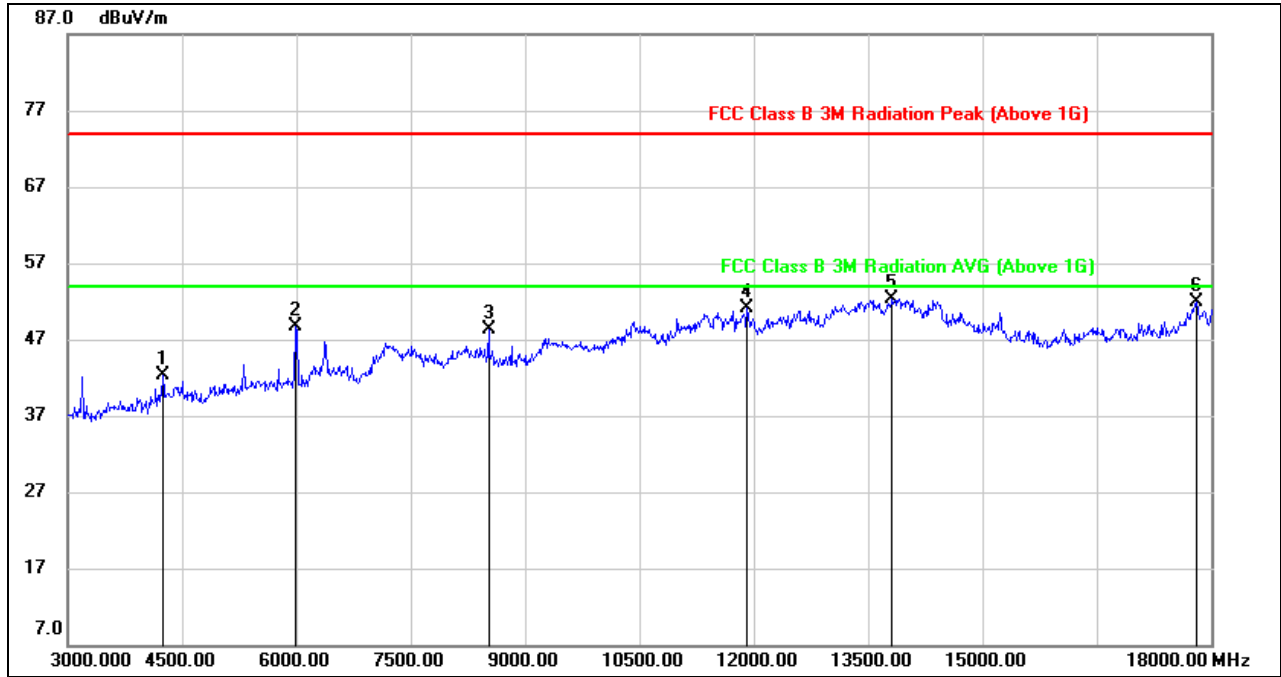

No.	Frequency (MHz)	Reading (dBuV)	Correct (dB/m)	Result (dBuV/m)	Limit (dBuV/m)	Margin (dB)	Remark
1	4245.000	44.28	-1.92	42.36	74.00	-31.64	peak
2	5985.000	45.37	3.28	48.65	74.00	-25.35	peak
3	8520.000	39.81	8.52	48.33	74.00	-25.67	peak
4	11910.000	34.53	16.64	51.17	74.00	-22.83	peak
5	13815.000	31.11	21.12	52.23	74.00	-21.77	peak
6	17805.000	25.07	26.80	51.87	74.00	-22.13	peak

- Note: 1. Measurement = Reading Level + Correct Factor.  
 2. If Peak Result complies with AV limit, AV Result is deemed to comply with AV limit.  
 3. Peak: Peak detector.



### 9.3.2. 802.11g MODE

#### HARMONICS AND SPURIOUS EMISSIONS (LOW CHANNEL, HORIZONTAL)

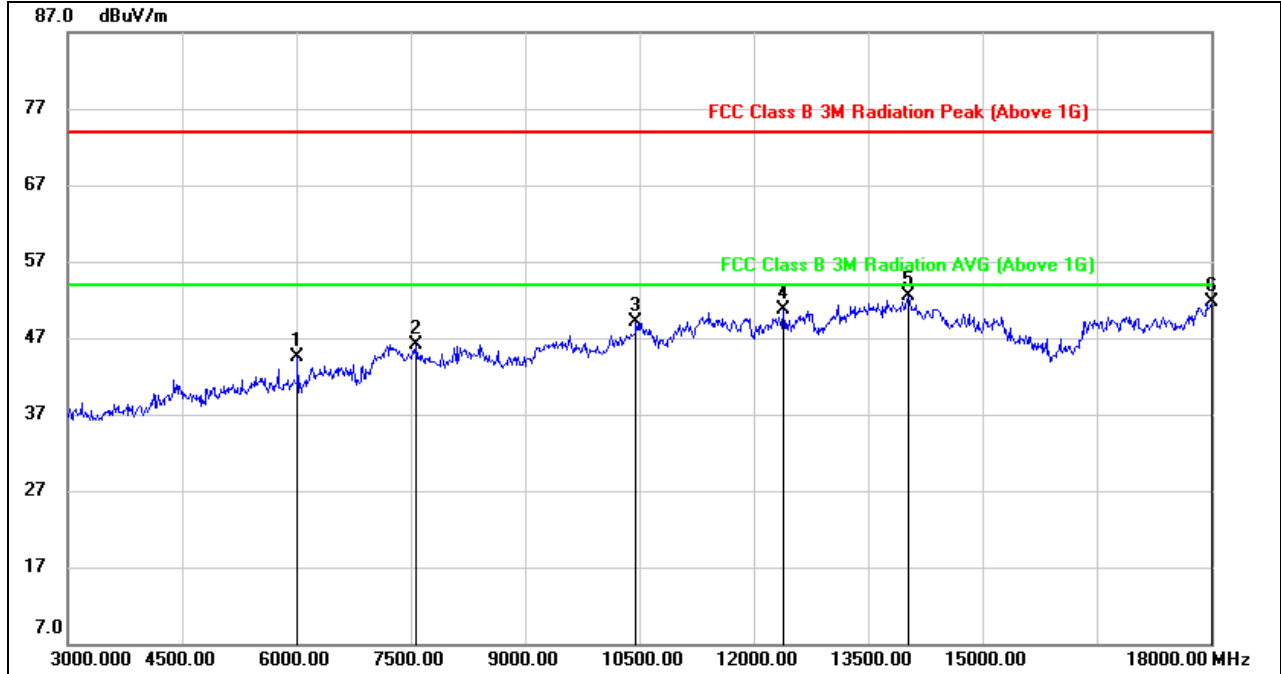

No.	Frequency (MHz)	Reading (dBuV)	Correct (dB/m)	Result (dBuV/m)	Limit (dBuV/m)	Margin (dB)	Remark
1	6015.000	41.23	3.25	44.48	74.00	-29.52	peak
2	7575.000	37.88	8.17	46.05	74.00	-27.95	peak
3	10455.000	35.66	13.44	49.10	74.00	-24.90	peak
4	12390.000	34.33	16.47	50.80	74.00	-23.20	peak
5	14025.000	31.86	20.62	52.48	74.00	-21.52	peak
6	18000.000	24.63	27.06	51.69	74.00	-22.31	peak

- Note: 1. Measurement = Reading Level + Correct Factor.  
 2. If Peak Result complies with AV limit, AV Result is deemed to comply with AV limit.  
 3. Peak: Peak detector.



**HARMONICS AND SPURIOUS EMISSIONS (LOW CHANNEL, VERTICAL)**

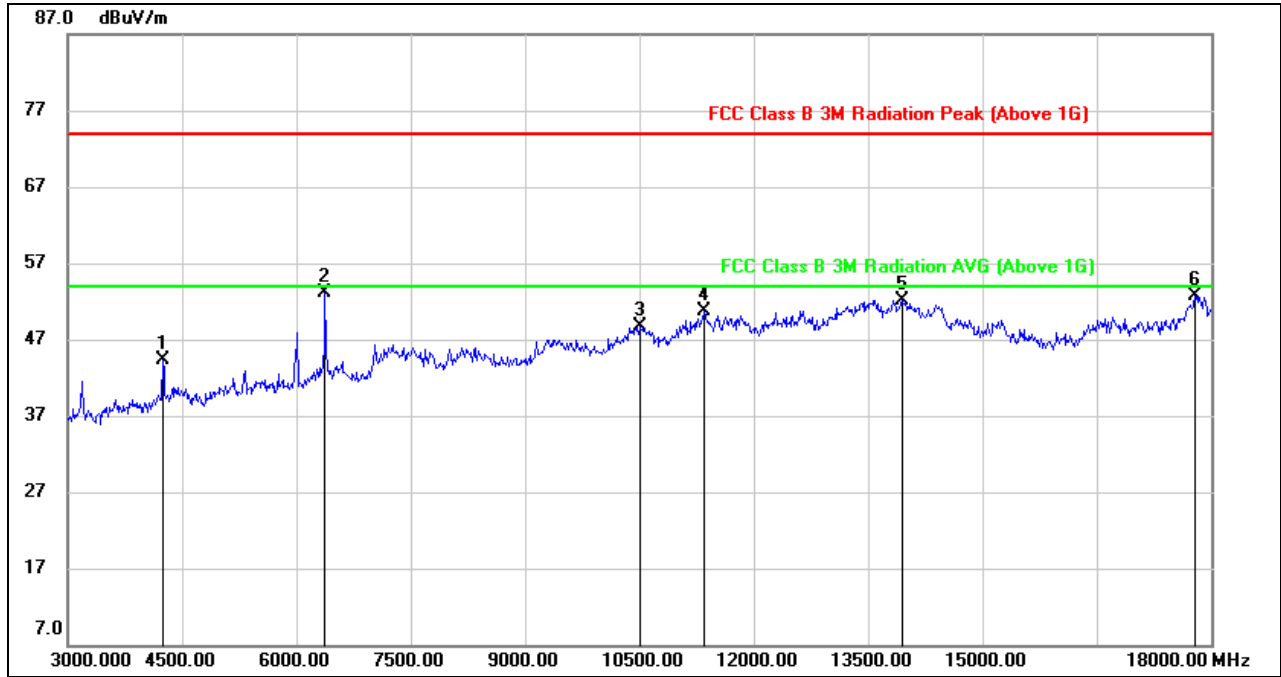

No.	Frequency (MHz)	Reading (dBuV)	Correct (dB/m)	Result (dBuV/m)	Limit (dBuV/m)	Margin (dB)	Remark
1	4245.000	46.21	-1.92	44.29	74.00	-29.71	peak
2	6375.000	48.33	4.70	53.03	74.00	-20.97	peak
3	10500.000	34.90	13.81	48.71	74.00	-25.29	peak
4	11355.000	35.19	15.54	50.73	74.00	-23.27	peak
5	13950.000	31.36	20.78	52.14	74.00	-21.86	peak
6	17790.000	25.95	26.76	52.71	74.00	-21.29	peak

- Note: 1. Measurement = Reading Level + Correct Factor.  
 2. If Peak Result complies with AV limit, AV Result is deemed to comply with AV limit.  
 3. Peak: Peak detector.



**HARMONICS AND SPURIOUS EMISSIONS (MID CHANNEL, HORIZONTAL)**

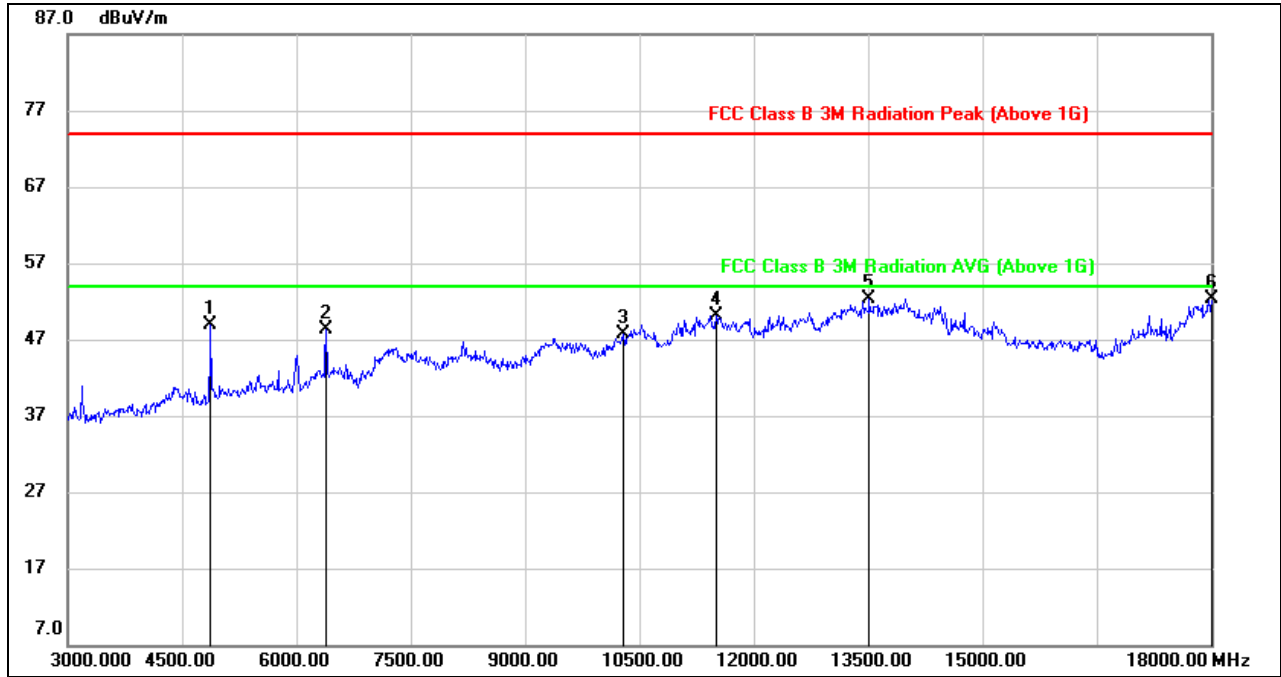

No.	Frequency (MHz)	Reading (dBuV)	Correct (dB/m)	Result (dBuV/m)	Limit (dBuV/m)	Margin (dB)	Remark
1	4875.000	48.55	0.38	48.93	74.00	-25.07	peak
2	6390.000	43.62	4.65	48.27	74.00	-25.73	peak
3	10290.000	35.10	12.56	47.66	74.00	-26.34	peak
4	11505.000	34.50	15.68	50.18	74.00	-23.82	peak
5	13515.000	32.10	20.14	52.24	74.00	-21.76	peak
6	18000.000	25.24	27.06	52.30	74.00	-21.70	peak

- Note: 1. Measurement = Reading Level + Correct Factor.  
 2. If Peak Result complies with AV limit, AV Result is deemed to comply with AV limit.  
 3. Peak: Peak detector.



**HARMONICS AND SPURIOUS EMISSIONS (MID CHANNEL, VERTICAL)**

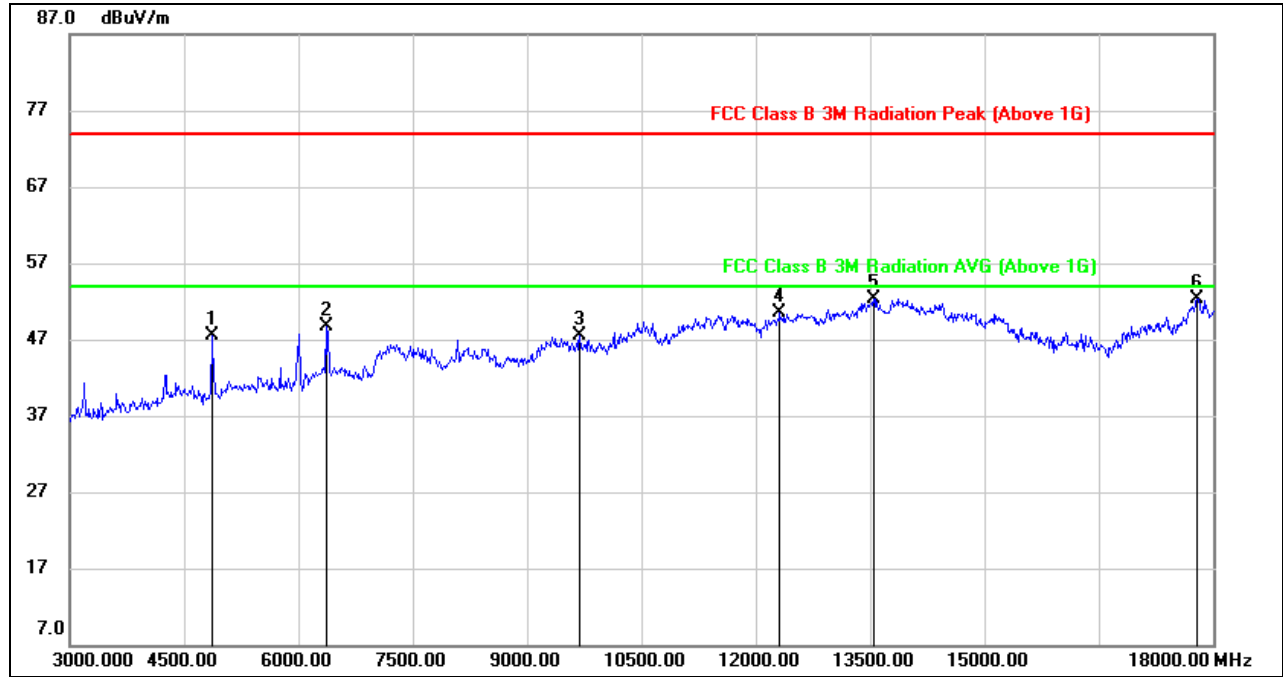

No.	Frequency (MHz)	Reading (dBuV)	Correct (dB/m)	Result (dBuV/m)	Limit (dBuV/m)	Margin (dB)	Remark
1	4860.000	47.34	0.18	47.52	74.00	-26.48	peak
2	6360.000	44.03	4.66	48.69	74.00	-25.31	peak
3	9690.000	35.93	11.51	47.44	74.00	-26.56	peak
4	12315.000	34.10	16.40	50.50	74.00	-23.50	peak
5	13545.000	31.52	20.88	52.40	74.00	-21.60	peak
6	17790.000	25.63	26.76	52.39	74.00	-21.61	peak

- Note: 1. Measurement = Reading Level + Correct Factor.  
 2. If Peak Result complies with AV limit, AV Result is deemed to comply with AV limit.  
 3. Peak: Peak detector.



**HARMONICS AND SPURIOUS EMISSIONS (HIGH CHANNEL, HORIZONTAL)**

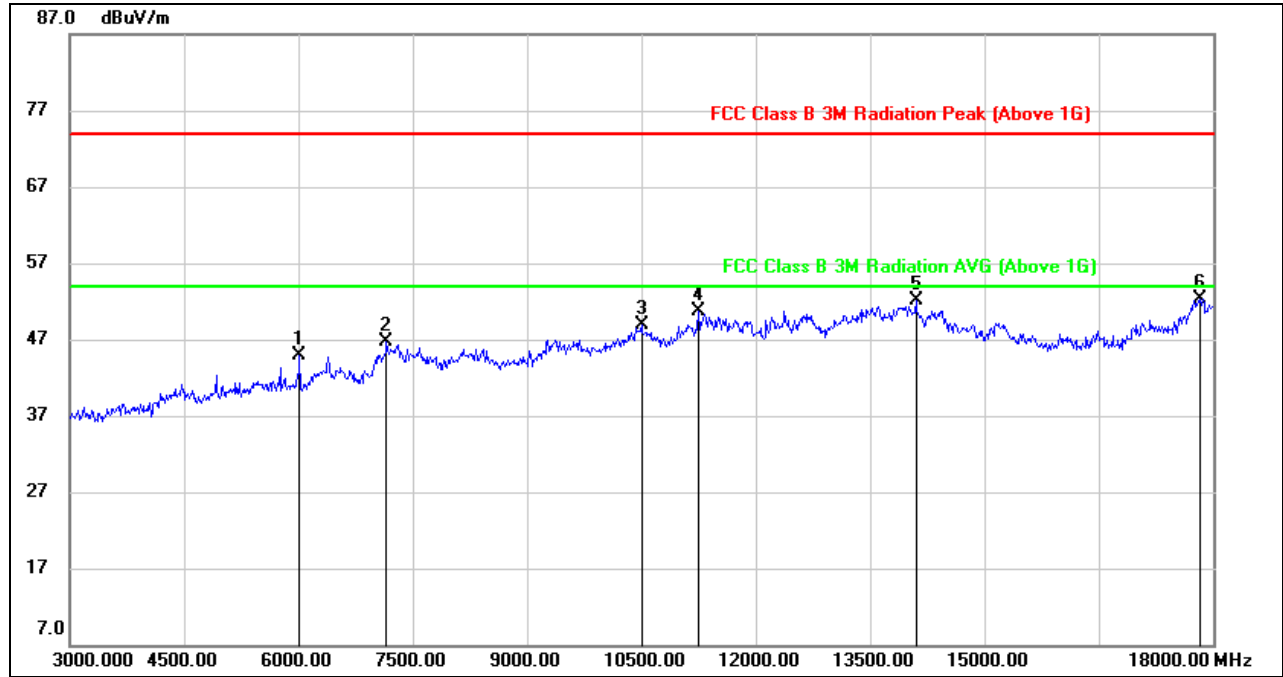

No.	Frequency (MHz)	Reading (dBuV)	Correct (dB/m)	Result (dBuV/m)	Limit (dBuV/m)	Margin (dB)	Remark
1	6015.000	41.59	3.25	44.84	74.00	-29.16	peak
2	7155.000	38.95	7.70	46.65	74.00	-27.35	peak
3	10500.000	35.20	13.71	48.91	74.00	-25.09	peak
4	11250.000	35.51	15.14	50.65	74.00	-23.35	peak
5	14100.000	31.46	20.67	52.13	74.00	-21.87	peak
6	17820.000	25.79	26.48	52.27	74.00	-21.73	peak

- Note: 1. Measurement = Reading Level + Correct Factor.  
 2. If Peak Result complies with AV limit, AV Result is deemed to comply with AV limit.  
 3. Peak: Peak detector.



**HARMONICS AND SPURIOUS EMISSIONS (HIGH CHANNEL, VERTICAL)**

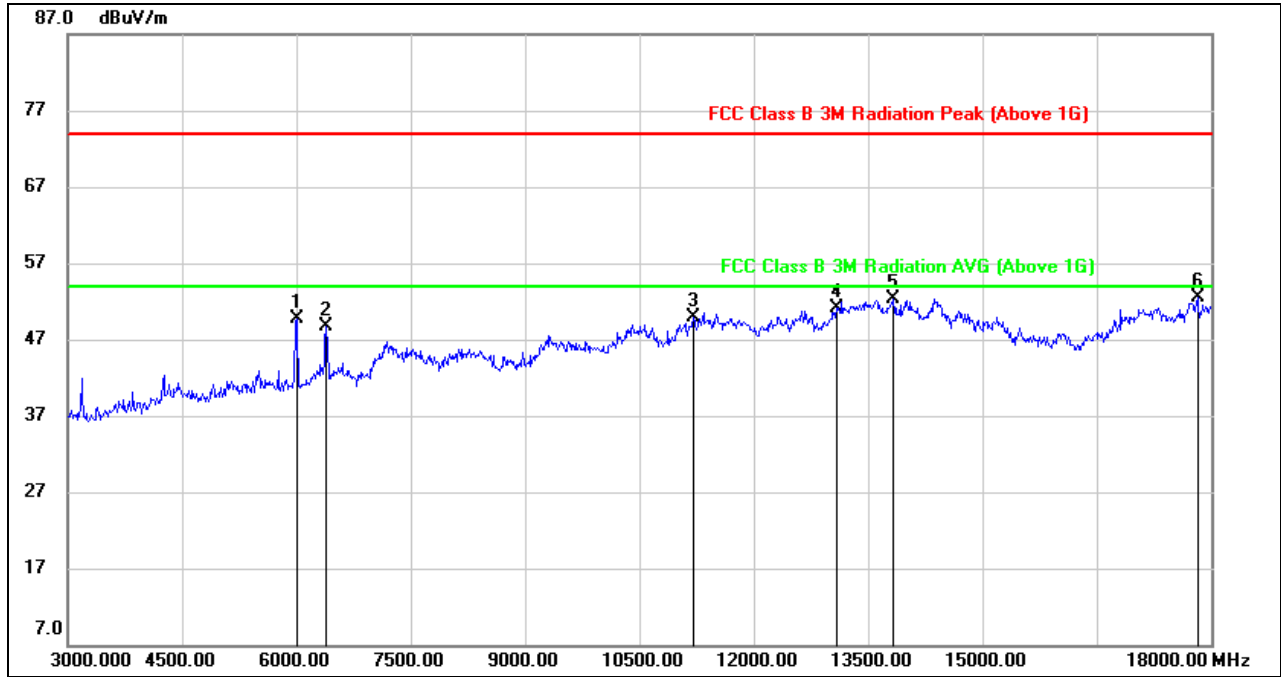

No.	Frequency (MHz)	Reading (dBuV)	Correct (dB/m)	Result (dBuV/m)	Limit (dBuV/m)	Margin (dB)	Remark
1	6000.000	46.30	3.32	49.62	74.00	-24.38	peak
2	6390.000	44.00	4.73	48.73	74.00	-25.27	peak
3	11205.000	34.45	15.40	49.85	74.00	-24.15	peak
4	13080.000	32.75	18.42	51.17	74.00	-22.83	peak
5	13830.000	31.31	21.04	52.35	74.00	-21.65	peak
6	17820.000	25.88	26.56	52.44	74.00	-21.56	peak

- Note: 1. Measurement = Reading Level + Correct Factor.  
 2. If Peak Result complies with AV limit, AV Result is deemed to comply with AV limit.  
 3. Peak: Peak detector.





### 9.3.3. 802.11n HT20 MODE

#### HARMONICS AND SPURIOUS EMISSIONS (LOW CHANNEL, HORIZONTAL)

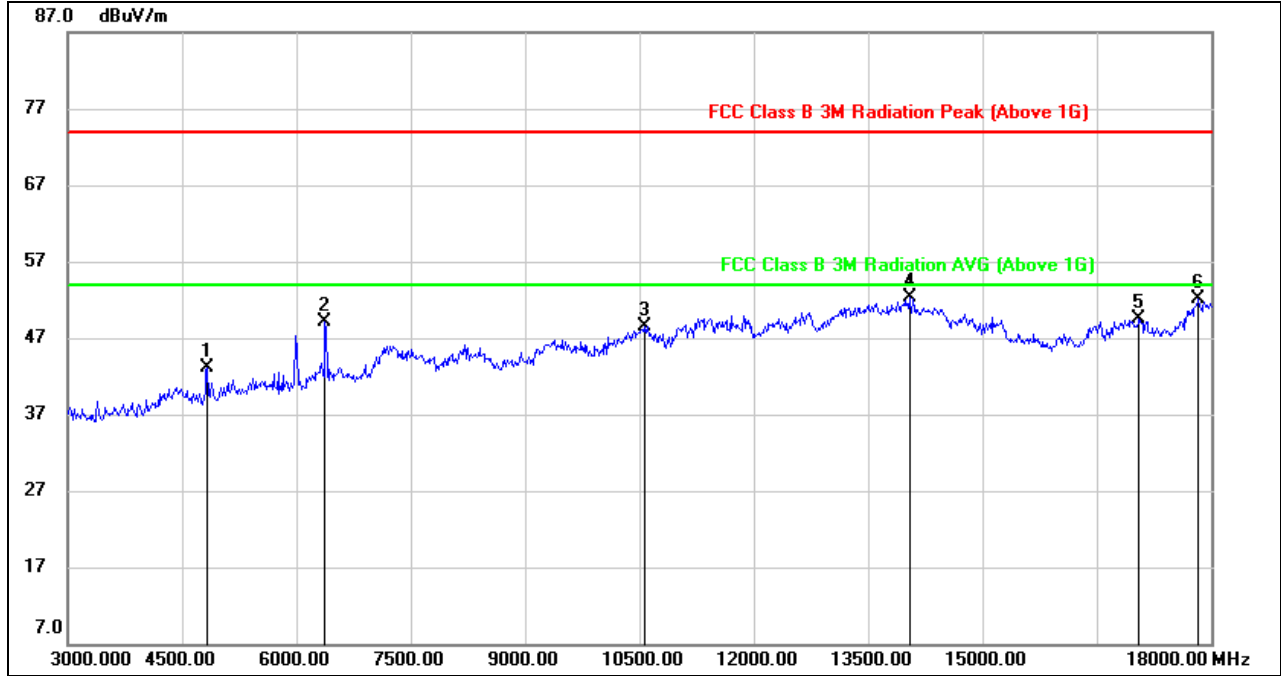

No.	Frequency (MHz)	Reading (dBuV)	Correct (dB/m)	Result (dBuV/m)	Limit (dBuV/m)	Margin (dB)	Remark
1	4830.000	43.19	-0.18	43.01	74.00	-30.99	peak
2	6375.000	44.44	4.65	49.09	74.00	-24.91	peak
3	10560.000	34.72	13.76	48.48	74.00	-25.52	peak
4	14040.000	31.74	20.64	52.38	74.00	-21.62	peak
5	17055.000	27.28	22.17	49.45	74.00	-24.55	peak
6	17835.000	25.64	26.49	52.13	74.00	-21.87	peak

Note: 1. Measurement = Reading Level + Correct Factor.  
 2. If Peak Result complies with AV limit, AV Result is deemed to comply with AV limit.  
 3. Peak: Peak detector.



**HARMONICS AND SPURIOUS EMISSIONS (LOW CHANNEL, VERTICAL)**

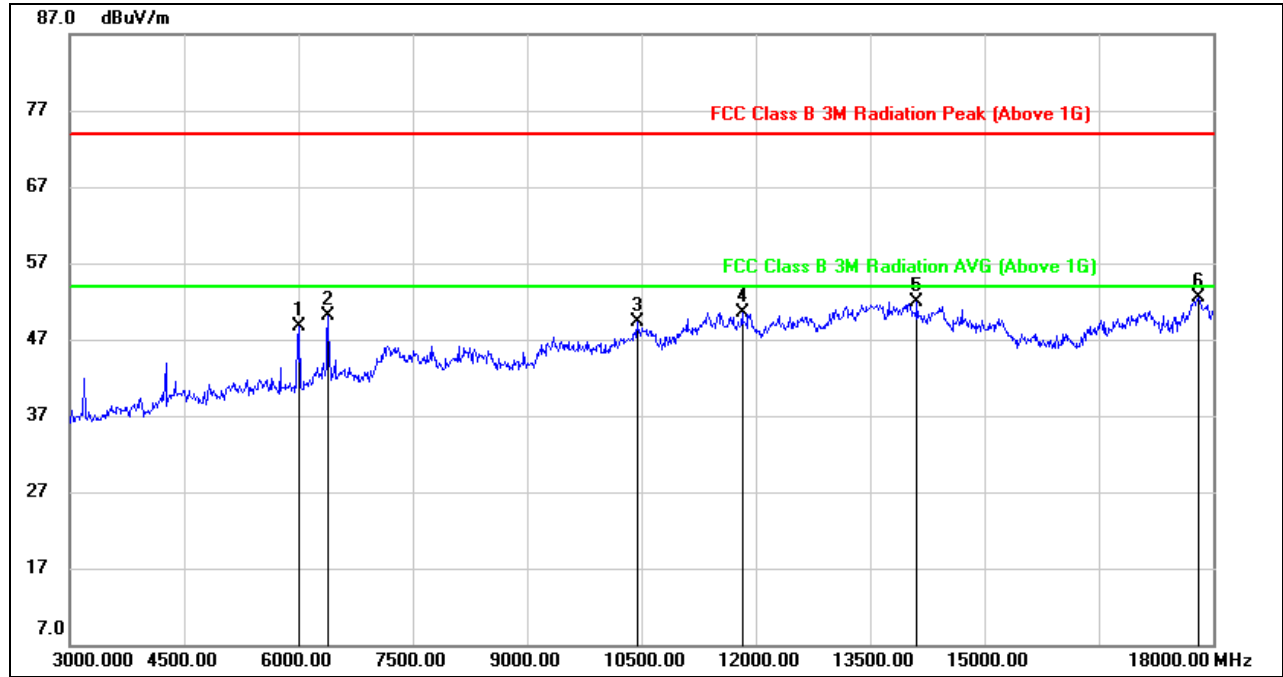

No.	Frequency (MHz)	Reading (dBuV)	Correct (dB/m)	Result (dBuV/m)	Limit (dBuV/m)	Margin (dB)	Remark
1	6015.000	45.41	3.35	48.76	74.00	-25.24	peak
2	6390.000	45.29	4.73	50.02	74.00	-23.98	peak
3	10440.000	35.90	13.44	49.34	74.00	-24.66	peak
4	11820.000	33.95	16.58	50.53	74.00	-23.47	peak
5	14115.000	31.37	20.59	51.96	74.00	-22.04	peak
6	17805.000	25.78	26.80	52.58	74.00	-21.42	peak

- Note: 1. Measurement = Reading Level + Correct Factor.  
 2. If Peak Result complies with AV limit, AV Result is deemed to comply with AV limit.  
 3. Peak: Peak detector.



**HARMONICS AND SPURIOUS EMISSIONS (MID CHANNEL, HORIZONTAL)**

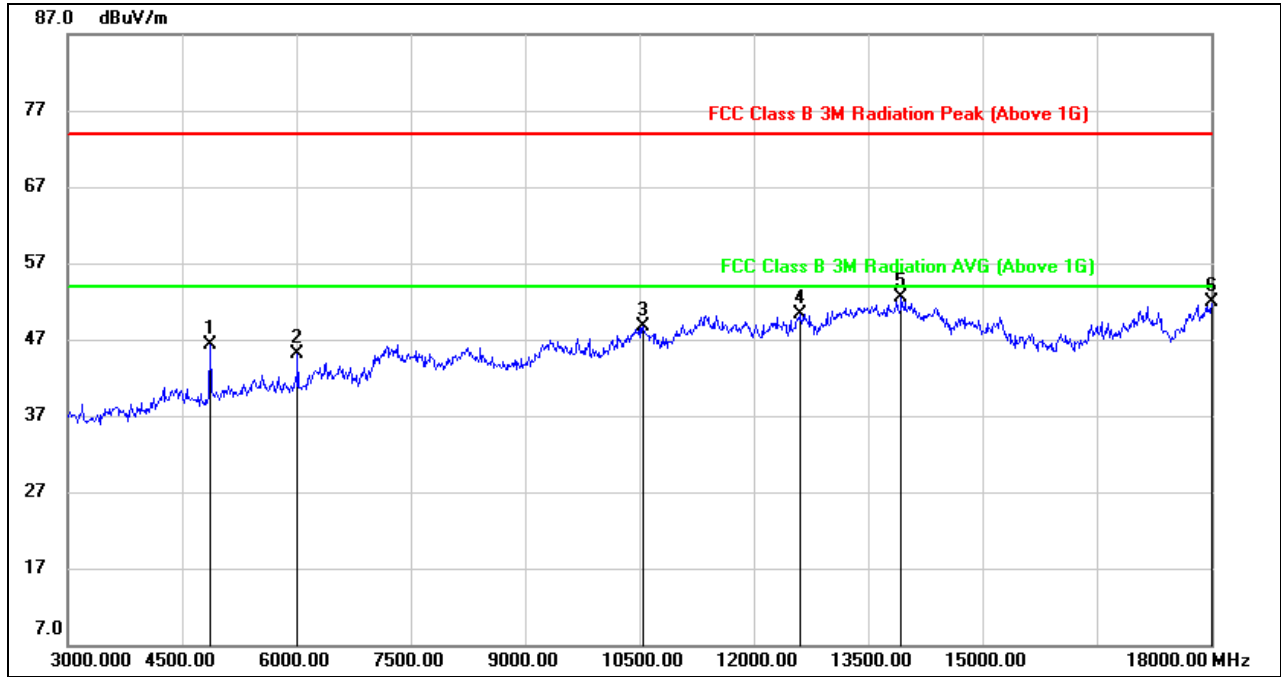

No.	Frequency (MHz)	Reading (dBuV)	Correct (dB/m)	Result (dBuV/m)	Limit (dBuV/m)	Margin (dB)	Remark
1	4875.000	45.93	0.38	46.31	74.00	-27.69	peak
2	6015.000	41.82	3.25	45.07	74.00	-28.93	peak
3	10545.000	34.83	13.79	48.62	74.00	-25.38	peak
4	12615.000	33.19	17.12	50.31	74.00	-23.69	peak
5	13935.000	31.82	20.67	52.49	74.00	-21.51	peak
6	18000.000	24.83	27.06	51.89	74.00	-22.11	peak

- Note: 1. Measurement = Reading Level + Correct Factor.  
 2. If Peak Result complies with AV limit, AV Result is deemed to comply with AV limit.  
 3. Peak: Peak detector.



**HARMONICS AND SPURIOUS EMISSIONS (MID CHANNEL, VERTICAL)**

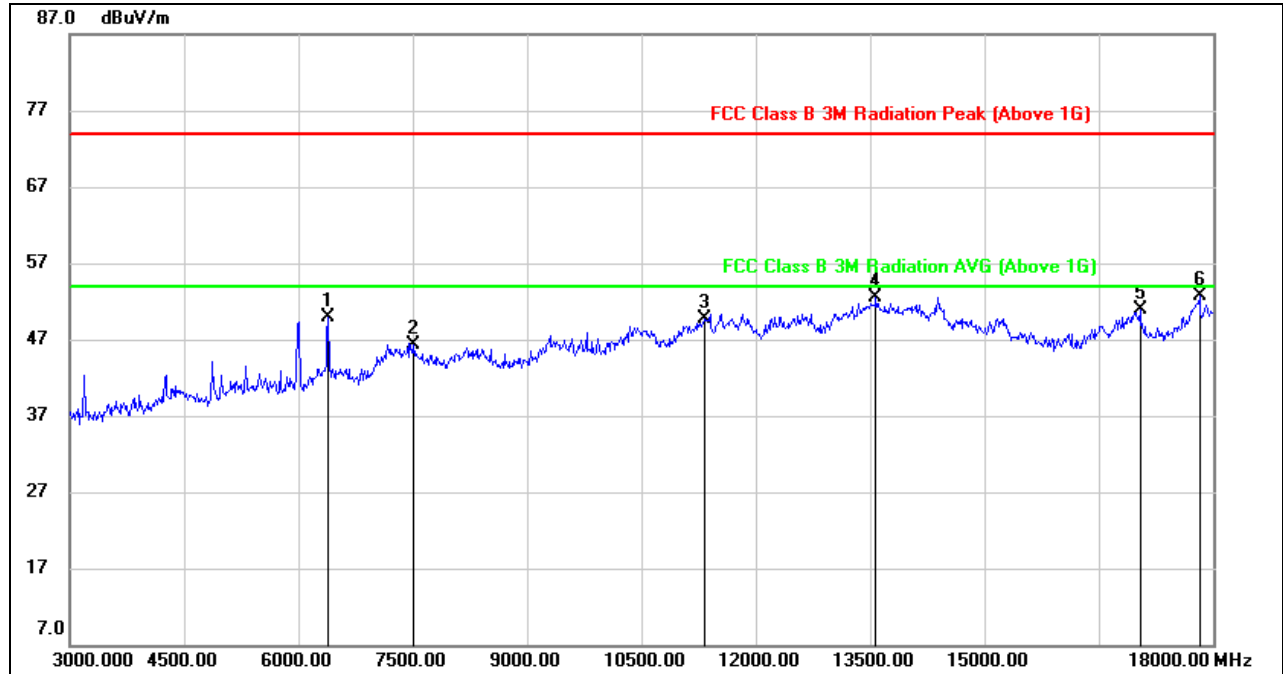

No.	Frequency (MHz)	Reading (dBuV)	Correct (dB/m)	Result (dBuV/m)	Limit (dBuV/m)	Margin (dB)	Remark
1	6390.000	45.22	4.73	49.95	74.00	-24.05	peak
2	7515.000	38.05	8.31	46.36	74.00	-27.64	peak
3	11325.000	34.33	15.30	49.63	74.00	-24.37	peak
4	13575.000	31.85	20.63	52.48	74.00	-21.52	peak
5	17040.000	28.38	22.59	50.97	74.00	-23.03	peak
6	17820.000	26.13	26.56	52.69	74.00	-21.31	peak

- Note: 1. Measurement = Reading Level + Correct Factor.  
 2. If Peak Result complies with AV limit, AV Result is deemed to comply with AV limit.  
 3. Peak: Peak detector.



**HARMONICS AND SPURIOUS EMISSIONS (HIGH CHANNEL, HORIZONTAL)**

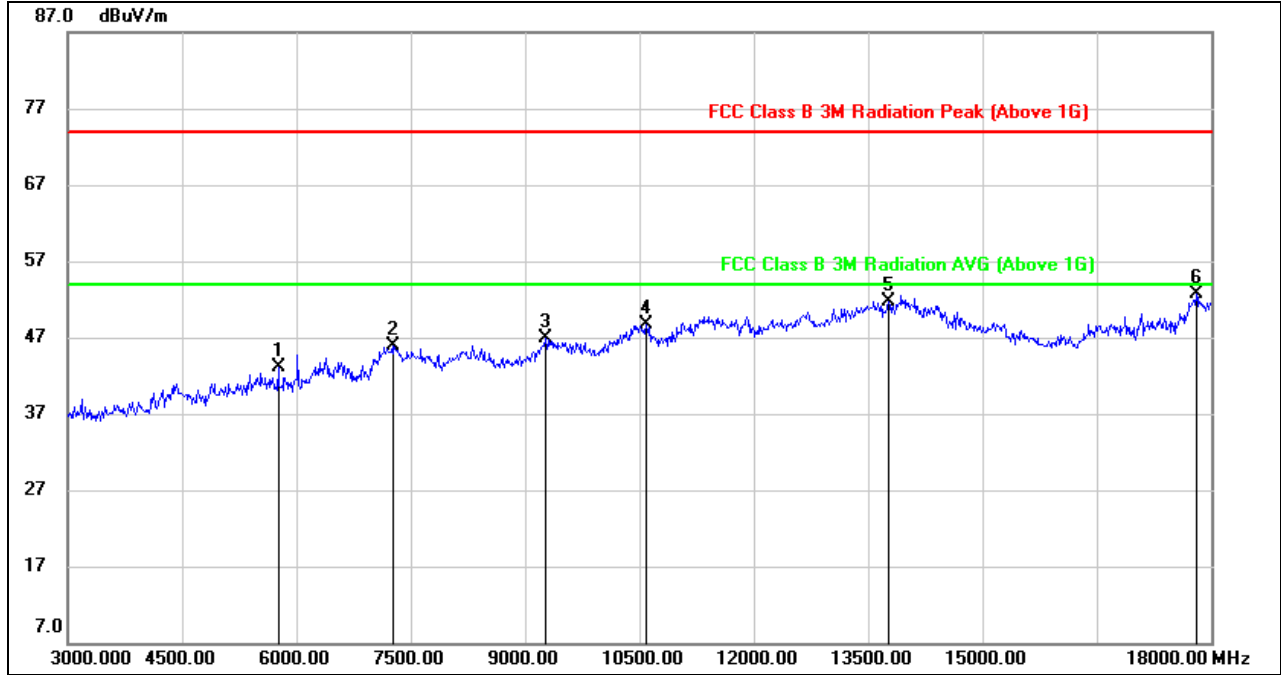

No.	Frequency (MHz)	Reading (dBuV)	Correct (dB/m)	Result (dBuV/m)	Limit (dBuV/m)	Margin (dB)	Remark
1	5760.000	40.60	2.48	43.08	74.00	-30.92	peak
2	7260.000	38.02	7.86	45.88	74.00	-28.12	peak
3	9270.000	36.46	10.49	46.95	74.00	-27.05	peak
4	10590.000	35.04	13.63	48.67	74.00	-25.33	peak
5	13770.000	31.01	20.79	51.80	74.00	-22.20	peak
6	17805.000	26.20	26.48	52.68	74.00	-21.32	peak

- Note: 1. Measurement = Reading Level + Correct Factor.  
 2. If Peak Result complies with AV limit, AV Result is deemed to comply with AV limit.  
 3. Peak: Peak detector.



**HARMONICS AND SPURIOUS EMISSIONS (HIGH CHANNEL, VERTICAL)**

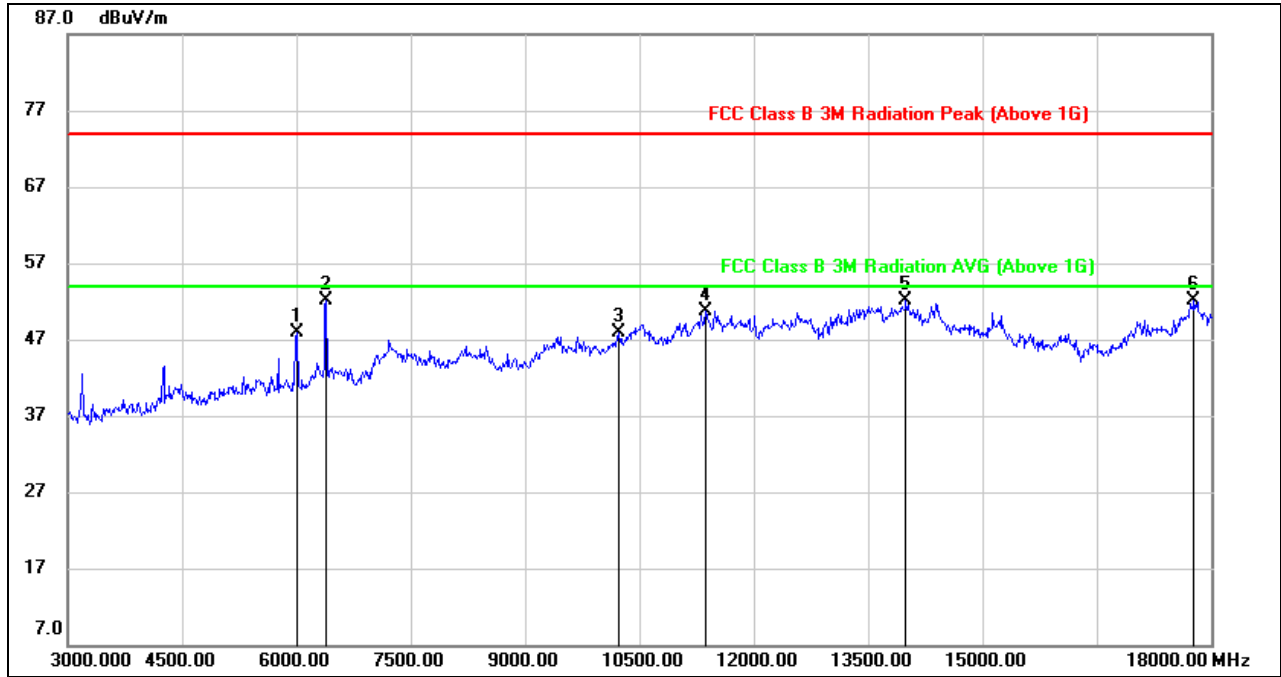

No.	Frequency (MHz)	Reading (dBuV)	Correct (dB/m)	Result (dBuV/m)	Limit (dBuV/m)	Margin (dB)	Remark
1	6000.000	44.66	3.32	47.98	74.00	-26.02	peak
2	6390.000	47.45	4.73	52.18	74.00	-21.82	peak
3	10230.000	35.17	12.72	47.89	74.00	-26.11	peak
4	11370.000	35.14	15.55	50.69	74.00	-23.31	peak
5	13995.000	31.42	20.72	52.14	74.00	-21.86	peak
6	17775.000	25.52	26.57	52.09	74.00	-21.91	peak

- Note: 1. Measurement = Reading Level + Correct Factor.  
 2. If Peak Result complies with AV limit, AV Result is deemed to comply with AV limit.  
 3. Peak: Peak detector.



### 9.3.4. 802.11n HT40 MODE

#### HARMONICS AND SPURIOUS EMISSIONS (LOW CHANNEL, HORIZONTAL)

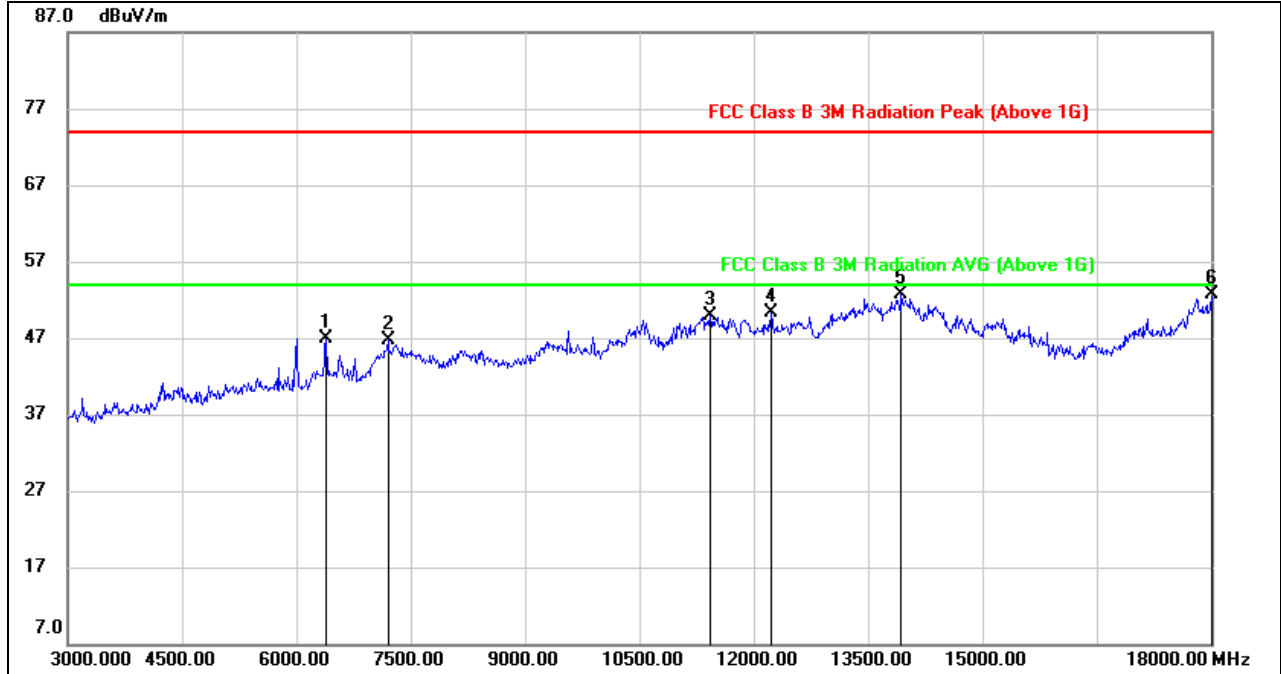

No.	Frequency (MHz)	Reading (dBuV)	Correct (dB/m)	Result (dBuV/m)	Limit (dBuV/m)	Margin (dB)	Remark
1	6390.000	42.29	4.65	46.94	74.00	-27.06	peak
2	7200.000	38.90	7.75	46.65	74.00	-27.35	peak
3	11430.000	33.98	15.83	49.81	74.00	-24.19	peak
4	12225.000	34.16	16.19	50.35	74.00	-23.65	peak
5	13935.000	31.99	20.67	52.66	74.00	-21.34	peak
6	18000.000	25.63	27.06	52.69	74.00	-21.31	peak

- Note: 1. Measurement = Reading Level + Correct Factor.  
 2. If Peak Result complies with AV limit, AV Result is deemed to comply with AV limit.  
 3. Peak: Peak detector.



**HARMONICS AND SPURIOUS EMISSIONS (LOW CHANNEL, VERTICAL)**

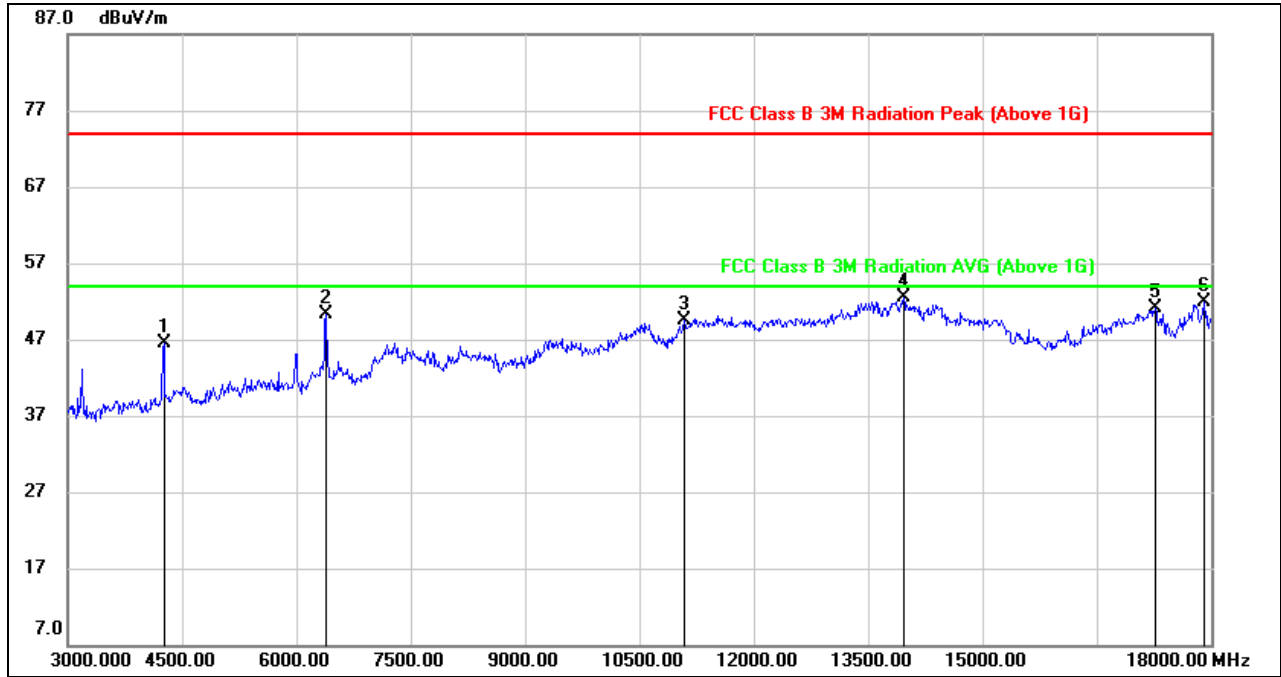

No.	Frequency (MHz)	Reading (dBuV)	Correct (dB/m)	Result (dBuV/m)	Limit (dBuV/m)	Margin (dB)	Remark
1	4260.000	48.32	-1.80	46.52	74.00	-27.48	peak
2	6390.000	45.63	4.73	50.36	74.00	-23.64	peak
3	11085.000	34.58	14.95	49.53	74.00	-24.47	peak
4	13965.000	31.67	20.76	52.43	74.00	-21.57	peak
5	17265.000	27.91	23.17	51.08	74.00	-22.92	peak
6	17910.000	25.47	26.37	51.84	74.00	-22.16	peak

- Note: 1. Measurement = Reading Level + Correct Factor.  
 2. If Peak Result complies with AV limit, AV Result is deemed to comply with AV limit.  
 3. Peak: Peak detector.





**HARMONICS AND SPURIOUS EMISSIONS (MID CHANNEL, HORIZONTAL)**

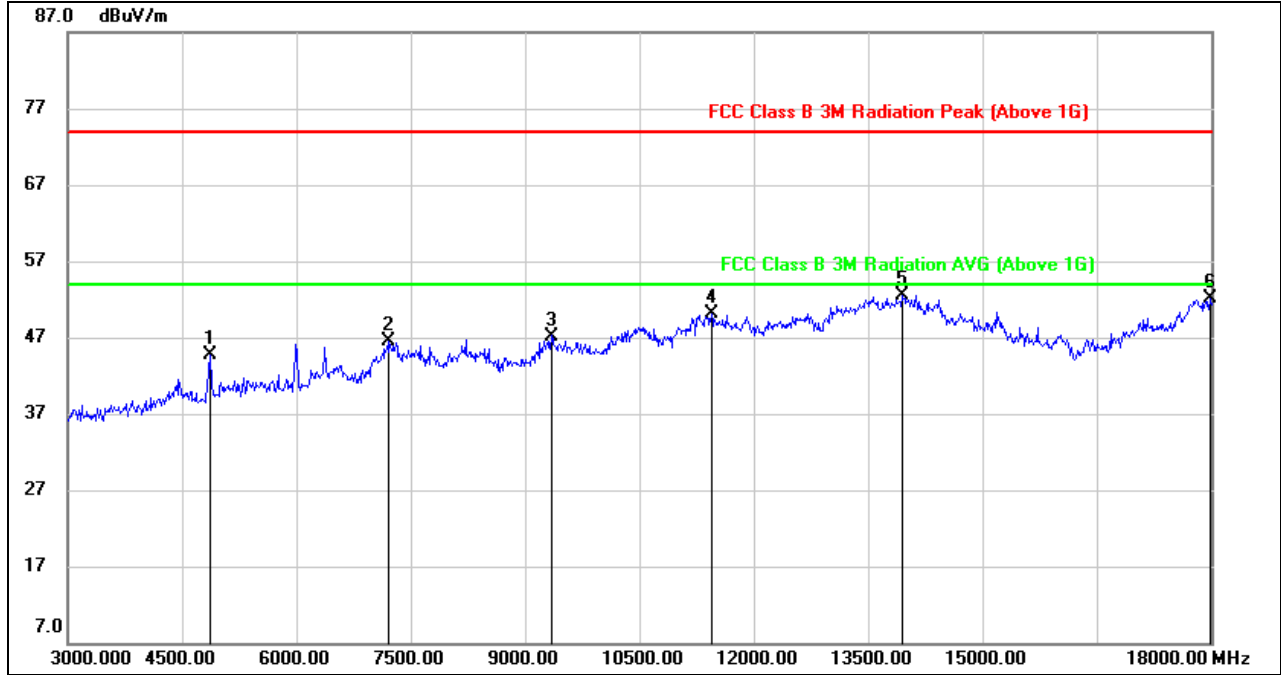

No.	Frequency (MHz)	Reading (dBuV)	Correct (dB/m)	Result (dBuV/m)	Limit (dBuV/m)	Margin (dB)	Remark
1	4860.000	44.46	0.20	44.66	74.00	-29.34	peak
2	7200.000	38.75	7.75	46.50	74.00	-27.50	peak
3	9345.000	36.38	10.82	47.20	74.00	-26.80	peak
4	11445.000	34.22	15.91	50.13	74.00	-23.87	peak
5	13950.000	31.91	20.68	52.59	74.00	-21.41	peak
6	17985.000	25.11	27.05	52.16	74.00	-21.84	peak

- Note: 1. Measurement = Reading Level + Correct Factor.  
 2. If Peak Result complies with AV limit, AV Result is deemed to comply with AV limit.  
 3. Peak: Peak detector.



**HARMONICS AND SPURIOUS EMISSIONS (MID CHANNEL, VERTICAL)**

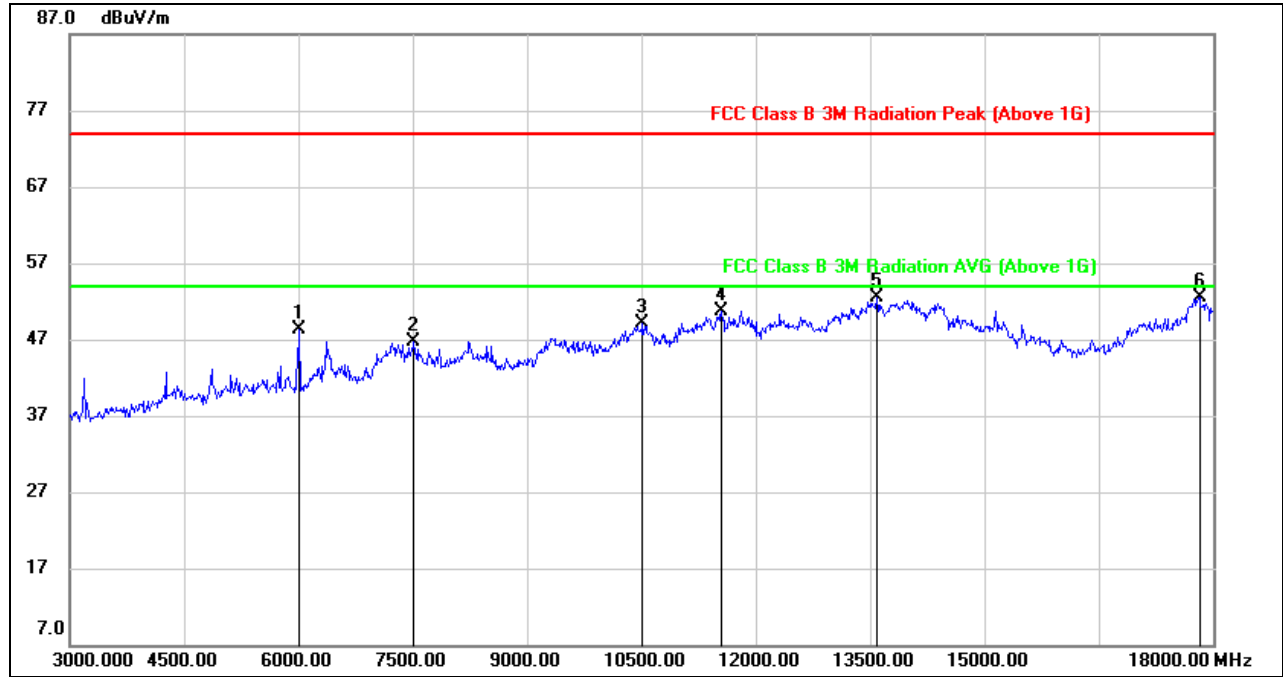

No.	Frequency (MHz)	Reading (dBuV)	Correct (dB/m)	Result (dBuV/m)	Limit (dBuV/m)	Margin (dB)	Remark
1	6015.000	44.92	3.35	48.27	74.00	-25.73	peak
2	7515.000	38.37	8.31	46.68	74.00	-27.32	peak
3	10515.000	35.24	13.78	49.02	74.00	-24.98	peak
4	11550.000	34.51	16.22	50.73	74.00	-23.27	peak
5	13590.000	32.01	20.47	52.48	74.00	-21.52	peak
6	17820.000	25.91	26.56	52.47	74.00	-21.53	peak

- Note: 1. Measurement = Reading Level + Correct Factor.  
 2. If Peak Result complies with AV limit, AV Result is deemed to comply with AV limit.  
 3. Peak: Peak detector.



**HARMONICS AND SPURIOUS EMISSIONS (HIGH CHANNEL, HORIZONTAL)**

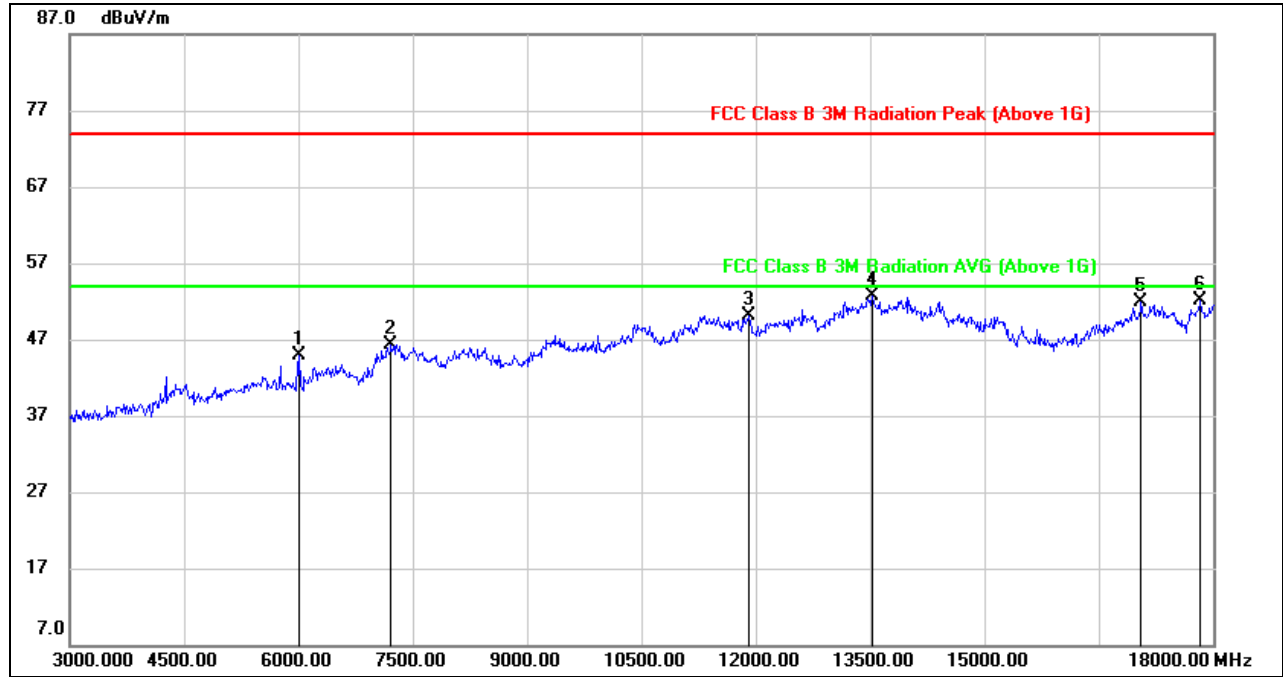

No.	Frequency (MHz)	Reading (dBuV)	Correct (dB/m)	Result (dBuV/m)	Limit (dBuV/m)	Margin (dB)	Remark
1	6015.000	41.62	3.25	44.87	74.00	-29.13	peak
2	7215.000	38.48	7.78	46.26	74.00	-27.74	peak
3	11910.000	33.18	16.98	50.16	74.00	-23.84	peak
4	13530.000	32.45	20.22	52.67	74.00	-21.33	peak
5	17055.000	29.81	22.17	51.98	74.00	-22.02	peak
6	17835.000	25.52	26.49	52.01	74.00	-21.99	peak

- Note: 1. Measurement = Reading Level + Correct Factor.  
 2. If Peak Result complies with AV limit, AV Result is deemed to comply with AV limit.  
 3. Peak: Peak detector.



**HARMONICS AND SPURIOUS EMISSIONS (HIGH CHANNEL, VERTICAL)**

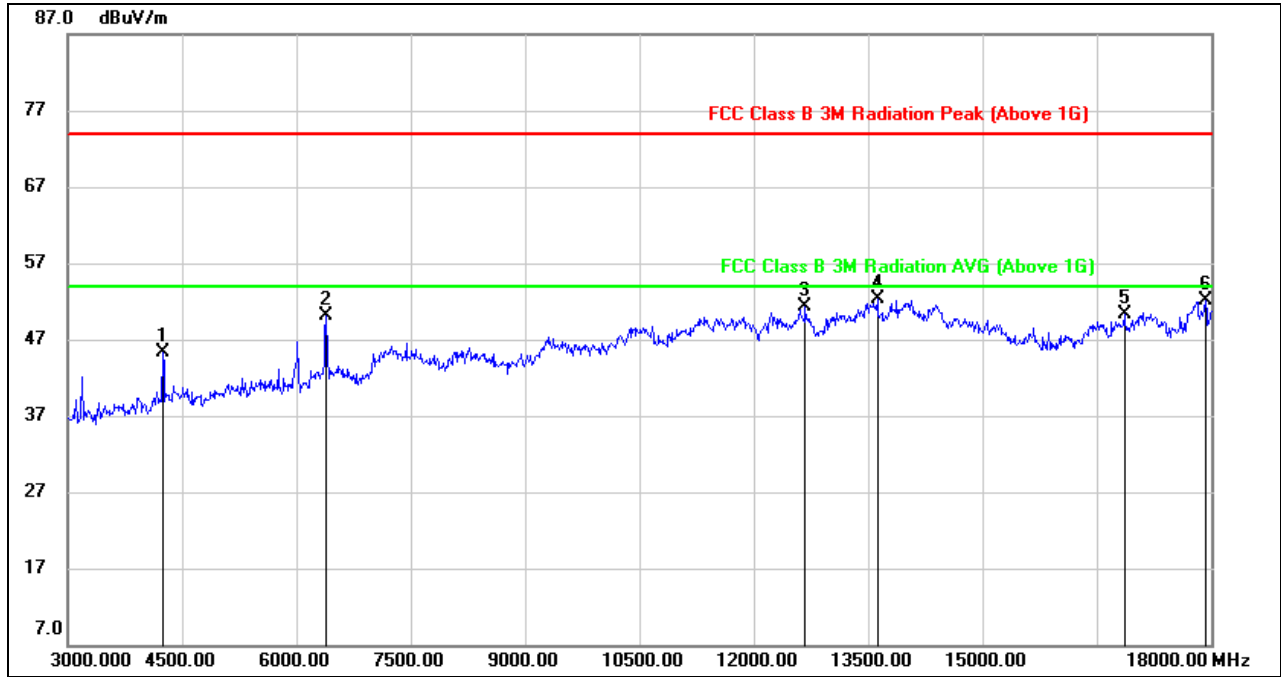

No.	Frequency (MHz)	Reading (dBuV)	Correct (dB/m)	Result (dBuV/m)	Limit (dBuV/m)	Margin (dB)	Remark
1	4245.000	47.18	-1.92	45.26	74.00	-28.74	peak
2	6390.000	45.32	4.73	50.05	74.00	-23.95	peak
3	12675.000	33.85	17.37	51.22	74.00	-22.78	peak
4	13620.000	31.87	20.51	52.38	74.00	-21.62	peak
5	16860.000	29.38	20.99	50.37	74.00	-23.63	peak
6	17925.000	25.93	26.17	52.10	74.00	-21.90	peak

- Note: 1. Measurement = Reading Level + Correct Factor.  
 2. If Peak Result complies with AV limit, AV Result is deemed to comply with AV limit.  
 3. Peak: Peak detector.



## 9.4. SPURIOUS EMISSIONS (18~26GHz)

### 9.4.1. 802.11b MODE

#### SPURIOUS EMISSIONS (MID CHANNEL, WORST-CASE CONFIGURATION, HORIZONTAL)

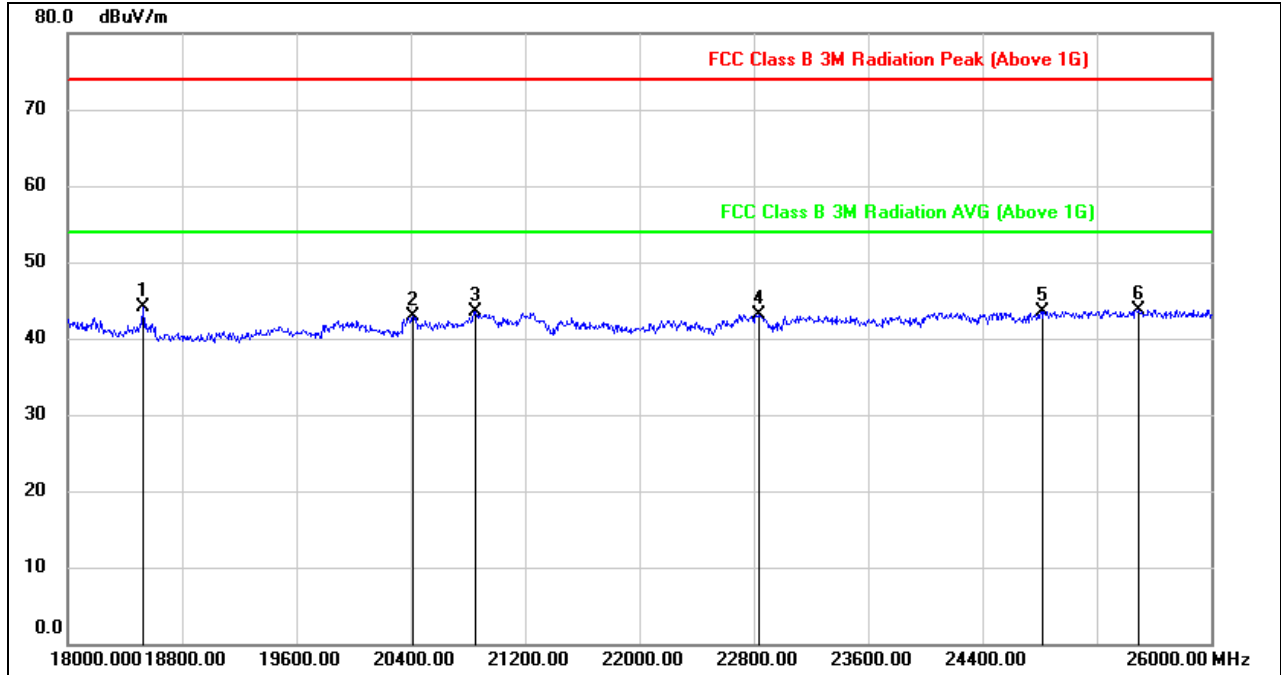

No.	Frequency (MHz)	Reading (dBuV)	Correct (dB/m)	Result (dBuV/m)	Limit (dBuV/m)	Margin (dB)	Remark
1	18528.000	49.41	-5.26	44.15	74.00	-29.85	peak
2	20416.000	48.30	-5.45	42.85	74.00	-31.15	peak
3	20856.000	48.55	-5.01	43.54	74.00	-30.46	peak
4	22840.000	46.76	-3.60	43.16	74.00	-30.84	peak
5	24816.000	45.86	-2.27	43.59	74.00	-30.41	peak
6	25488.000	45.45	-1.77	43.68	74.00	-30.32	peak

Note: 1. Measurement = Reading Level + Correct Factor.  
2. If Peak Result complies with AV limit, AV Result is deemed to comply with AV limit.  
3. Peak: Peak detector.



**SPURIOUS EMISSIONS (MID CHANNEL, WORST-CASE CONFIGURATION, VERTICAL)**

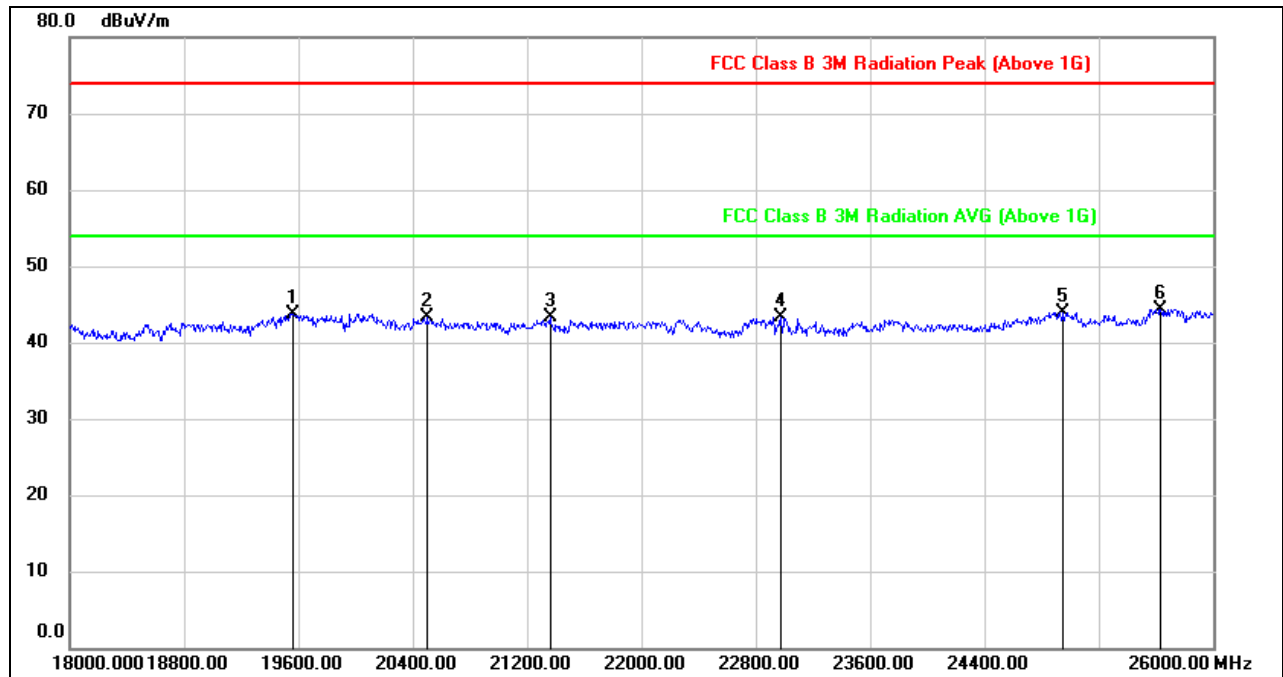

No.	Frequency (MHz)	Reading (dBuV)	Correct (dB/m)	Result (dBuV/m)	Limit (dBuV/m)	Margin (dB)	Remark
1	19560.000	49.14	-5.48	43.66	74.00	-30.34	peak
2	20504.000	48.73	-5.35	43.38	74.00	-30.62	peak
3	21360.000	48.02	-4.73	43.29	74.00	-30.71	peak
4	22976.000	46.76	-3.46	43.30	74.00	-30.70	peak
5	24944.000	46.05	-2.15	43.90	74.00	-30.10	peak
6	25632.000	45.56	-1.16	44.40	74.00	-29.60	peak

Note: 1. Measurement = Reading Level + Correct Factor.  
 2. If Peak Result complies with AV limit, AV Result is deemed to comply with AV limit.  
 3. Peak: Peak detector.



## 9.5. SPURIOUS EMISSIONS (0.03 ~ 1 GHz)

### 9.5.1. 802.11b MODE

#### SPURIOUS EMISSIONS (MID CHANNEL, WORST-CASE CONFIGURATION, HORIZONTAL)

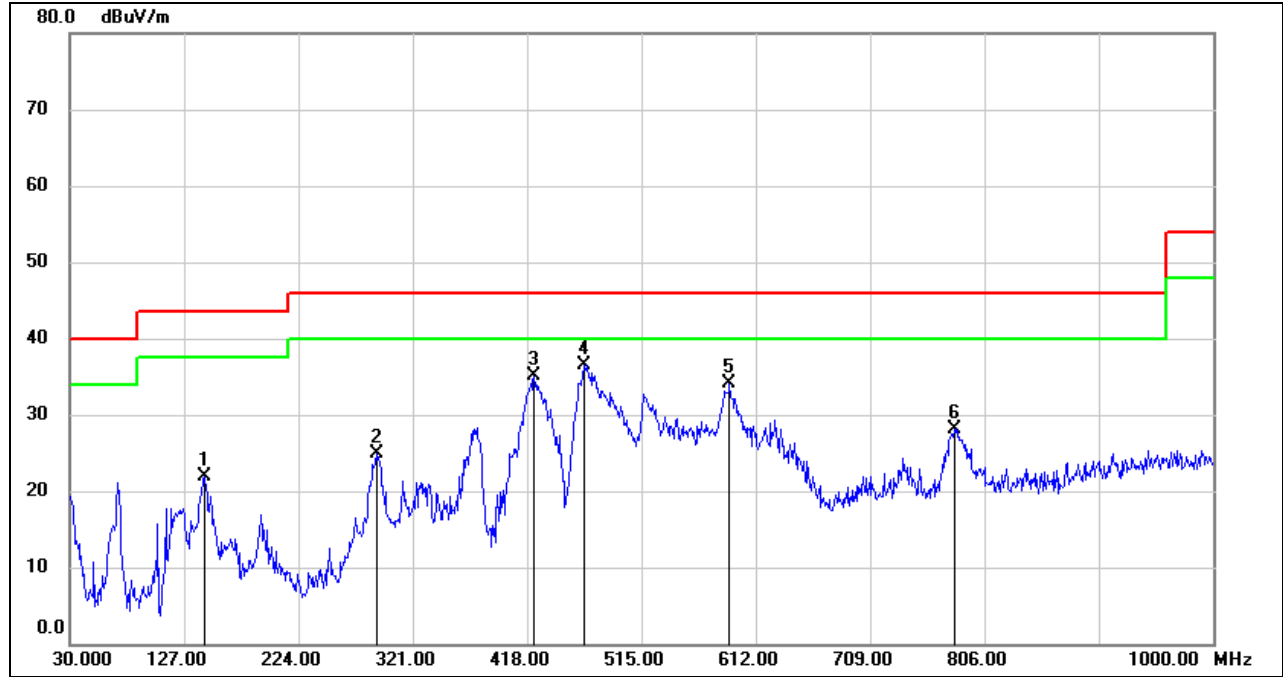

No.	Frequency (MHz)	Reading (dBuV)	Correct (dB/m)	Result (dBuV/m)	Limit (dBuV/m)	Margin (dB)	Remark
1	144.4600	40.59	-18.68	21.91	43.50	-21.59	QP
2	289.9600	39.55	-14.73	24.82	46.00	-21.18	QP
3	423.8200	47.26	-12.22	35.04	46.00	-10.96	QP
4	466.5000	48.11	-11.51	36.60	46.00	-9.40	QP
5	589.6900	43.08	-9.07	34.01	46.00	-11.99	QP
6	780.7800	34.02	-5.87	28.15	46.00	-17.85	QP

- Note: 1. Result Level = Read Level + Correct Factor.  
 2. If Peak Result complies with QP limit, QP Result is deemed to comply with QP limit.  
 3. Test setup: RBW: 120 kHz, VBW: 300 kHz, Sweep time: auto.



**SPURIOUS EMISSIONS (MID CHANNEL, WORST-CASE CONFIGURATION, VERTICAL)**

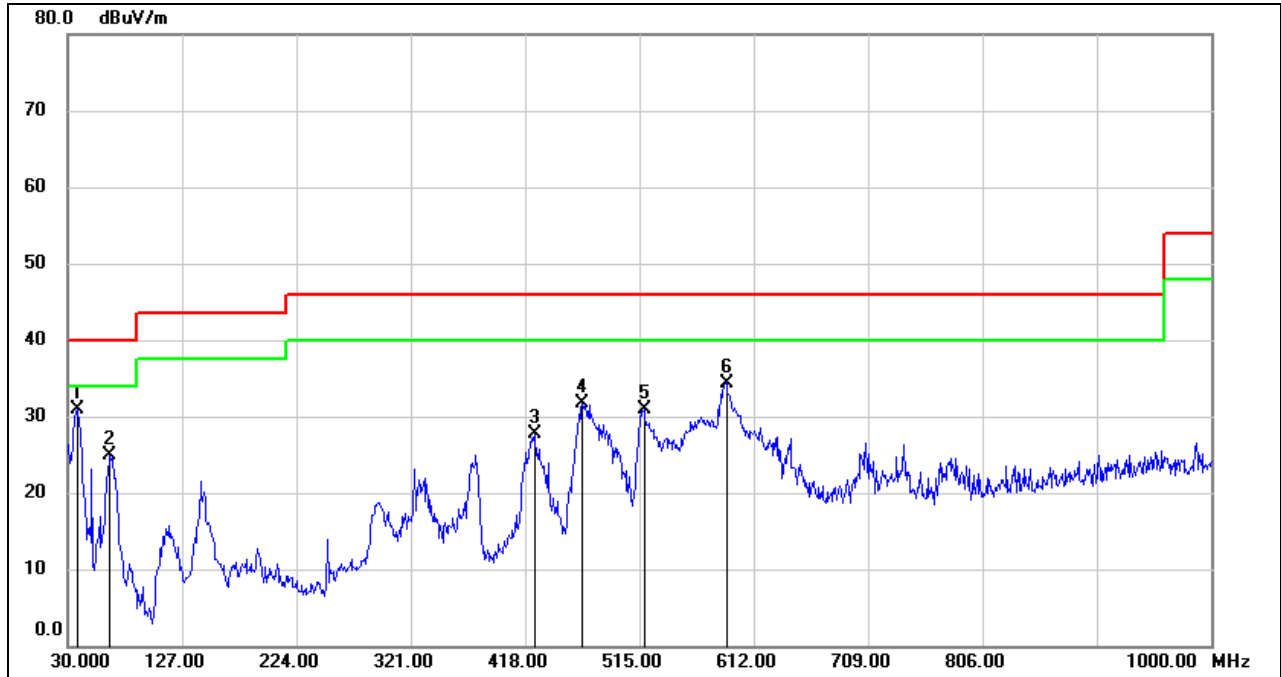

No.	Frequency (MHz)	Reading (dBuV)	Correct (dB/m)	Result (dBuV/m)	Limit (dBuV/m)	Margin (dB)	Remark
1	37.7599	48.73	-17.83	30.90	40.00	-9.10	QP
2	65.8900	44.58	-19.77	24.81	40.00	-15.19	QP
3	425.7600	39.87	-12.18	27.69	46.00	-18.31	QP
4	466.5000	43.23	-11.51	31.72	46.00	-14.28	QP
5	518.8800	41.26	-10.38	30.88	46.00	-15.12	QP
6	588.7199	43.47	-9.07	34.40	46.00	-11.60	QP

- Note: 1. Result Level = Read Level + Correct Factor.  
2. If Peak Result complies with QP limit, QP Result is deemed to comply with QP limit.  
3. Test setup: RBW: 120 kHz, VBW: 300 kHz, Sweep time: auto





## 9.6. SPURIOUS EMISSIONS BELOW 30M

### 9.6.1. 802.11b MODE

#### SPURIOUS EMISSIONS (MID CHANNEL, WORST-CASE CONFIGURATION, VERTICAL)

0.09kHz~ 150kHz

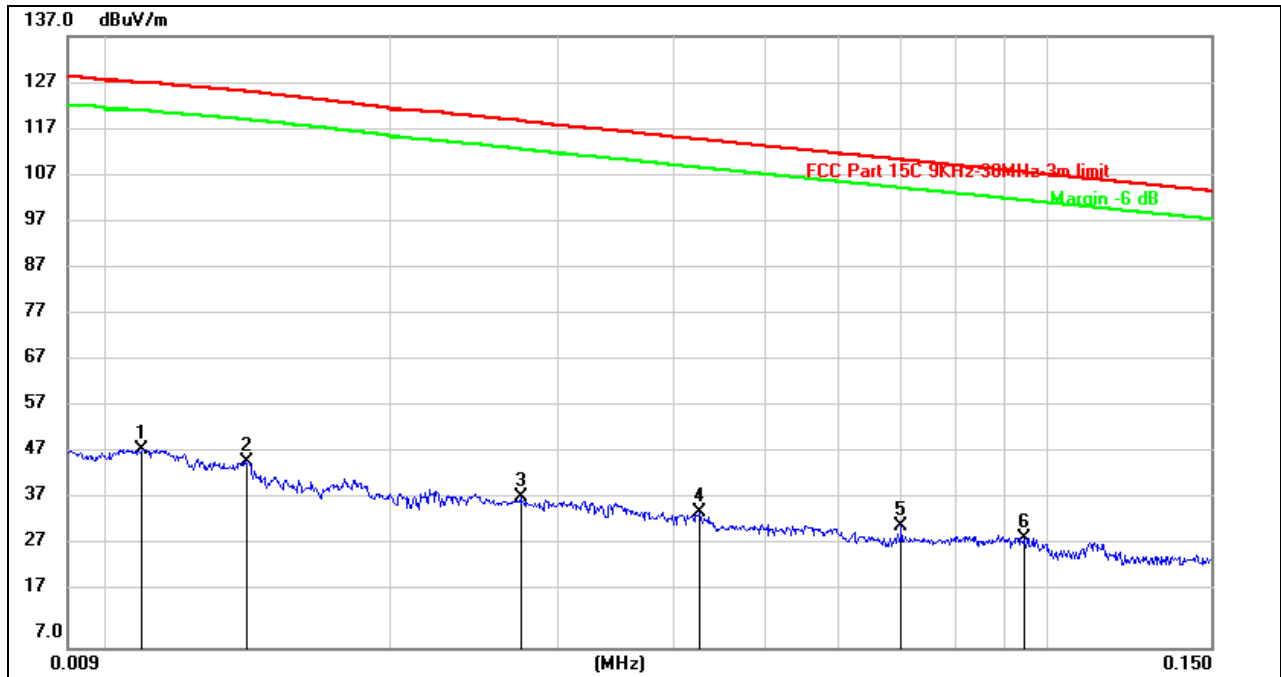

No.	Frequency (KHz)	Reading (dBuV)	Correct (dB/m)	Result (dBuV/m)	Limit (dBuV/m)	Margin (dB)	Remark
1	0.0108	29.00	20.22	49.22	127.12	-77.90	peak
2	0.0140	26.26	20.25	46.51	125.19	-78.68	peak
3	0.0274	18.60	20.31	38.91	118.98	-80.07	peak
4	0.0427	15.46	20.31	35.77	115.04	-79.27	peak
5	0.0700	12.40	20.31	32.71	110.70	-77.99	peak
6	0.0946	10.15	20.24	30.39	108.10	-77.71	peak

Note: 1. Measurement = Reading Level + Correct Factor.

2. If Peak Result complies with AV and QP limit, AV and QP Result are deemed to comply with AV limit.



**150kHz ~ 30MHz**

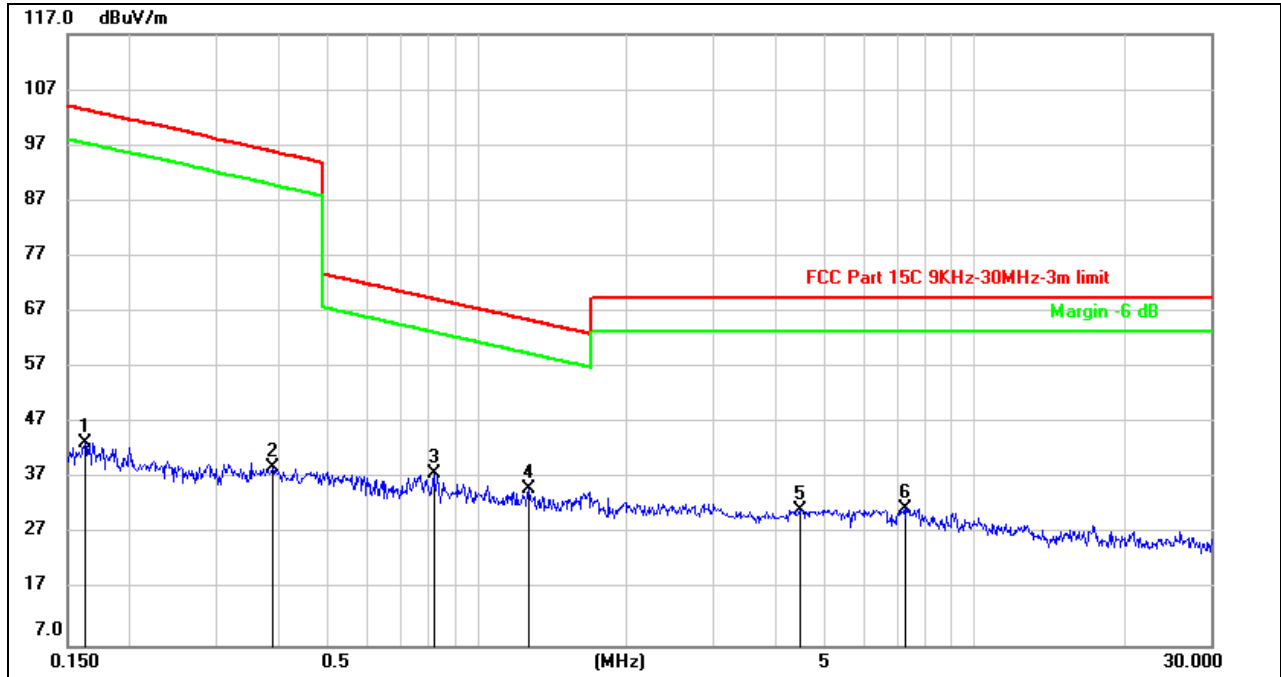

No.	Frequency (MHz)	Reading (dBuV)	Correct (dB/m)	Result (dBuV/m)	Limit (dBuV/m)	Margin (dB)	Remark
1	0.1621	23.11	20.41	43.52	103.41	-59.89	peak
2	0.3870	18.65	20.27	38.92	95.89	-56.97	peak
3	0.8174	17.46	20.36	37.82	69.36	-31.54	peak
4	1.2681	14.69	20.47	35.16	65.55	-30.39	peak
5	4.4537	10.43	20.95	31.38	69.54	-38.16	peak
6	7.2518	10.82	20.93	31.75	69.54	-37.79	peak

Note: 1. Measurement = Reading Level + Correct Factor.  
2. If Peak Result complies with AV and QP limit, AV and QP Result are deemed to comply with AV limit.



**SPURIOUS EMISSIONS (MID CHANNEL, WORST-CASE CONFIGURATION, HORIZONTAL)**

**0.09~ 150kHz**

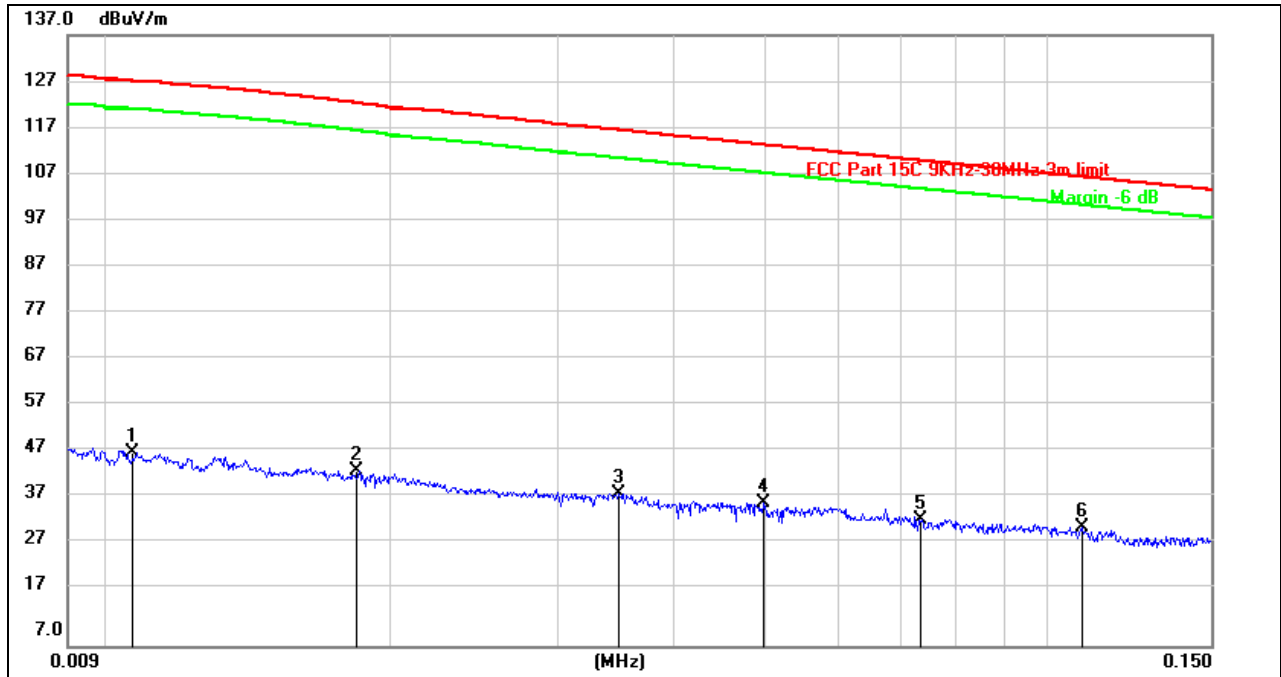

No.	Frequency (KHz)	Reading (dBuV)	Correct (dB/m)	Result (dBuV/m)	Limit (dBuV/m)	Margin (dB)	Remark
1	0.0106	27.89	20.22	48.11	127.24	-79.13	peak
2	0.0183	24.07	20.29	44.36	122.60	-78.24	peak
3	0.0349	19.17	20.31	39.48	116.84	-77.36	peak
4	0.0497	17.01	20.31	37.32	113.68	-76.36	peak
5	0.0734	13.64	20.31	33.95	110.31	-76.36	peak
6	0.1091	11.94	20.26	32.20	106.85	-74.65	peak

Note: 1. Measurement = Reading Level + Correct Factor.  
2. If Peak Result complies with AV and QP limit, AV and QP Result are deemed to comply with AV limit.



**150kHz ~ 30M**

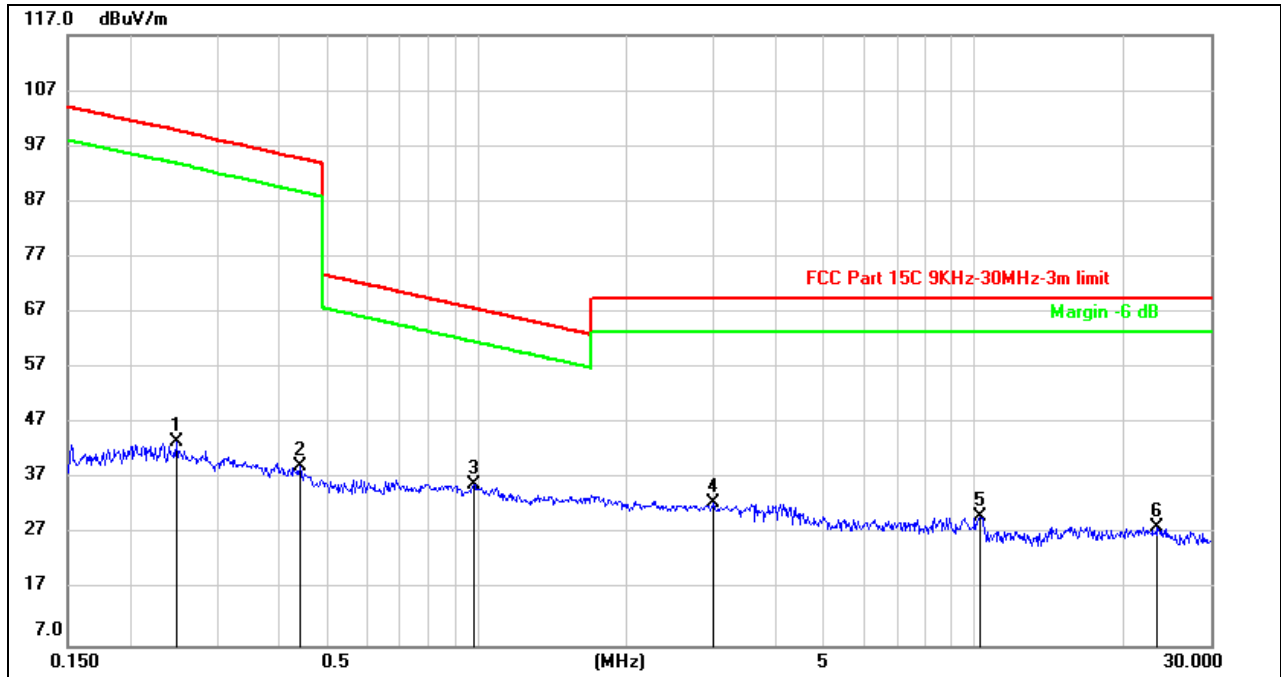

No.	Frequency (MHz)	Reading (dBuV)	Correct (dB/m)	Result (dBuV/m)	Limit (dBuV/m)	Margin (dB)	Remark
1	0.2479	23.41	20.32	43.73	99.89	-56.16	peak
2	0.4395	18.95	20.26	39.21	94.79	-55.58	peak
3	0.9838	15.76	20.37	36.13	67.75	-31.62	peak
4	2.9935	11.70	20.90	32.60	69.54	-36.94	peak
5	10.2873	9.15	21.05	30.20	69.54	-39.34	peak
6	23.3869	6.94	21.40	28.34	69.54	-41.20	peak

Note: 1. Measurement = Reading Level + Correct Factor.  
2. If Peak Result complies with AV and QP limit, AV and QP Result are deemed to comply with AV limit.

## 10. AC POWER LINE CONDUCTED EMISSIONS

### LIMITS

Please refer to CFR 47 FCC §15.207 (a) and ISED RSS-Gen Clause 8.8

FREQUENCY (MHz)	Class A (dBuV)		Class B (dBuV)	
	Quasi-peak	Average	Quasi-peak	Average
0.15 -0.5	79.00	66.00	66 - 56 *	56 - 46 *
0.50 -5.0	73.00	60.00	56.00	46.00
5.0 -30.0	73.00	60.00	60.00	50.00

### TEST SETUP AND PROCEDURE

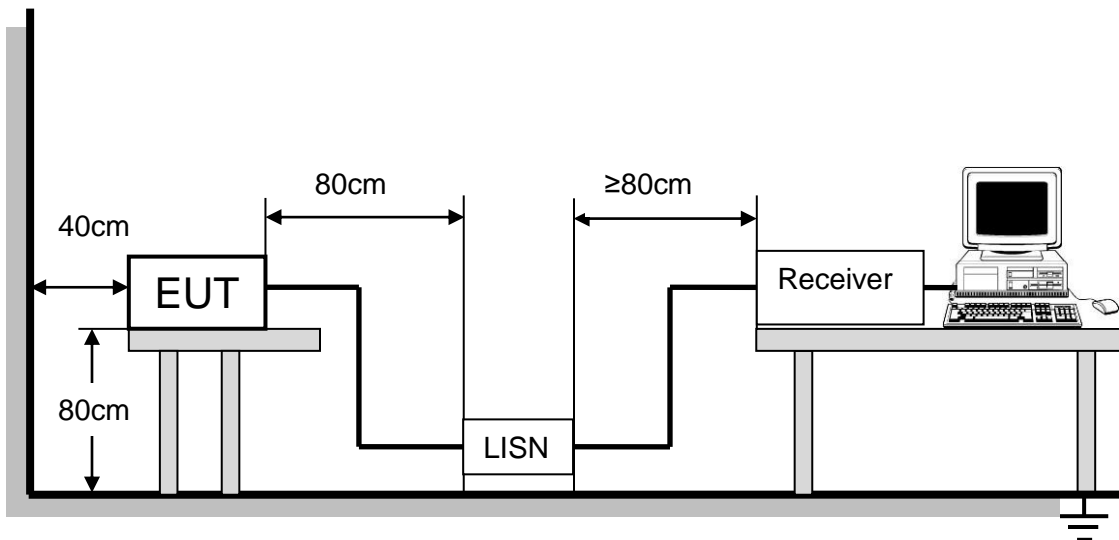

The EUT is put on a table of non-conducting material that is 80cm high. The vertical conducting wall of shielding is located 40cm to the rear of the EUT. The power line of the EUT is connected to the AC mains through a Artificial Mains Network (A.M.N.). A EMI Measurement Receiver (R&S Test Receiver ESR3) is used to test the emissions from both sides of AC line. According to the requirements in Section 7 and 13 of ANSI C63.10-2013. Conducted emissions from the EUT measured in the frequency range between 0.15 MHz and 30MHz using CISPR Quasi-Peak and average detector mode. The bandwidth of EMI test receiver is set at 9kHz.

The arrangement of the equipment is installed to meet the standards and operating in a manner, which tends to maximize its emission characteristics in a normal application.

### TEST ENVIRONMENT

Temperature	24.5°C	Relative Humidity	59%
Atmosphere Pressure	101kPa	Test Voltage	AC120V



**TEST RESULTS**

**10.1. 802.11b MODE**

**LINE N RESULTS (HIGH CHANNEL, WORST-CASE CONFIGURATION)**

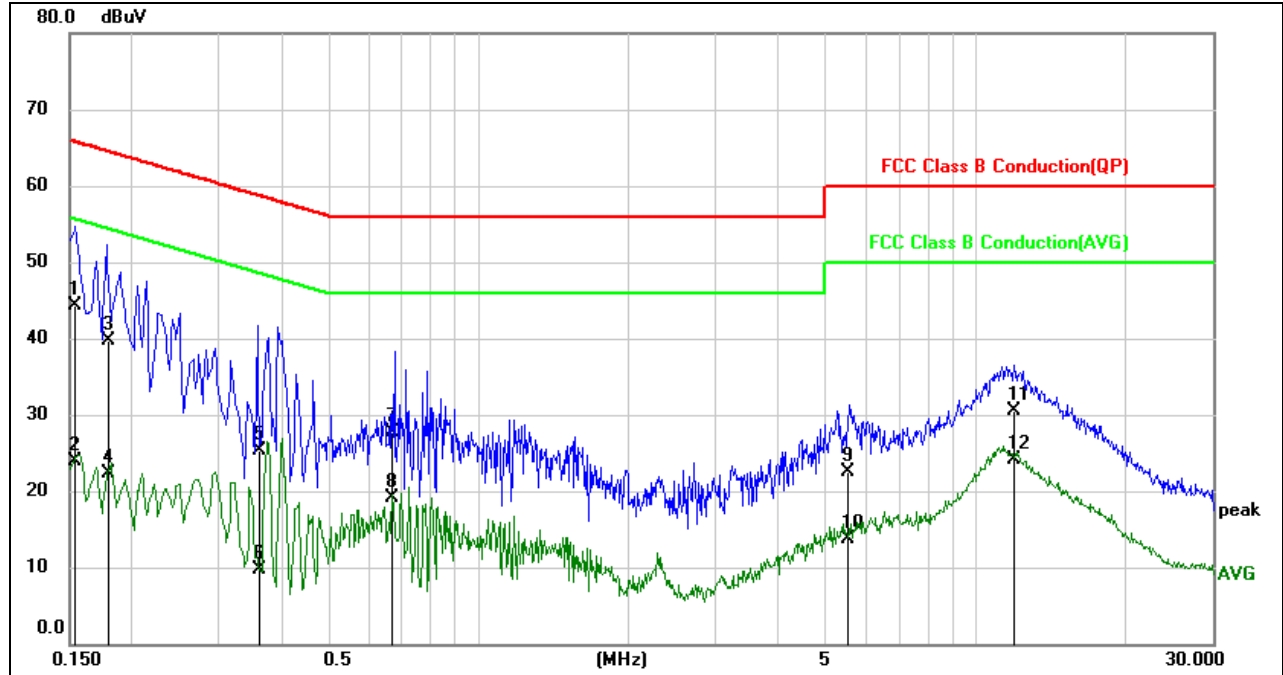

No.	Frequency (MHz)	Reading (dBuV)	Correct (dB)	Result (dBuV)	Limit (dBuV)	Margin (dB)	Remark
1	0.1532	34.68	9.62	44.30	65.82	-21.52	QP
2	0.1532	14.25	9.62	23.87	55.82	-31.95	AVG
3	0.1805	30.14	9.62	39.76	64.46	-24.70	QP
4	0.1805	12.70	9.62	22.32	54.46	-32.14	AVG
5	0.3620	15.61	9.63	25.24	58.68	-33.44	QP
6	0.3620	0.17	9.63	9.80	48.68	-38.88	AVG
7	0.6710	17.98	9.63	27.61	56.00	-28.39	QP
8	0.6710	9.40	9.63	19.03	46.00	-26.97	AVG
9	5.5347	12.75	9.72	22.47	60.00	-37.53	QP
10	5.5347	3.98	9.72	13.70	50.00	-36.30	AVG
11	11.9514	20.50	10.01	30.51	60.00	-29.49	QP
12	11.9514	14.02	10.01	24.03	50.00	-25.97	AVG

- Note: 1. Result = Reading +Correct Factor.  
 2. If QP Result complies with AV limit, AV Result is deemed to comply with AV limit.  
 3. Test setup: RBW: 200 Hz (9 kHz—150 kHz), 9 kHz (150 kHz—30 MHz).  
 4. Step size: 80Hz (0.009MHz-0.15MHz), 4 kHz (0.15MHz-30MHz), Scan time: auto.



**LINE L RESULTS (HIGH CHANNEL, WORST-CASE CONFIGURATION)**

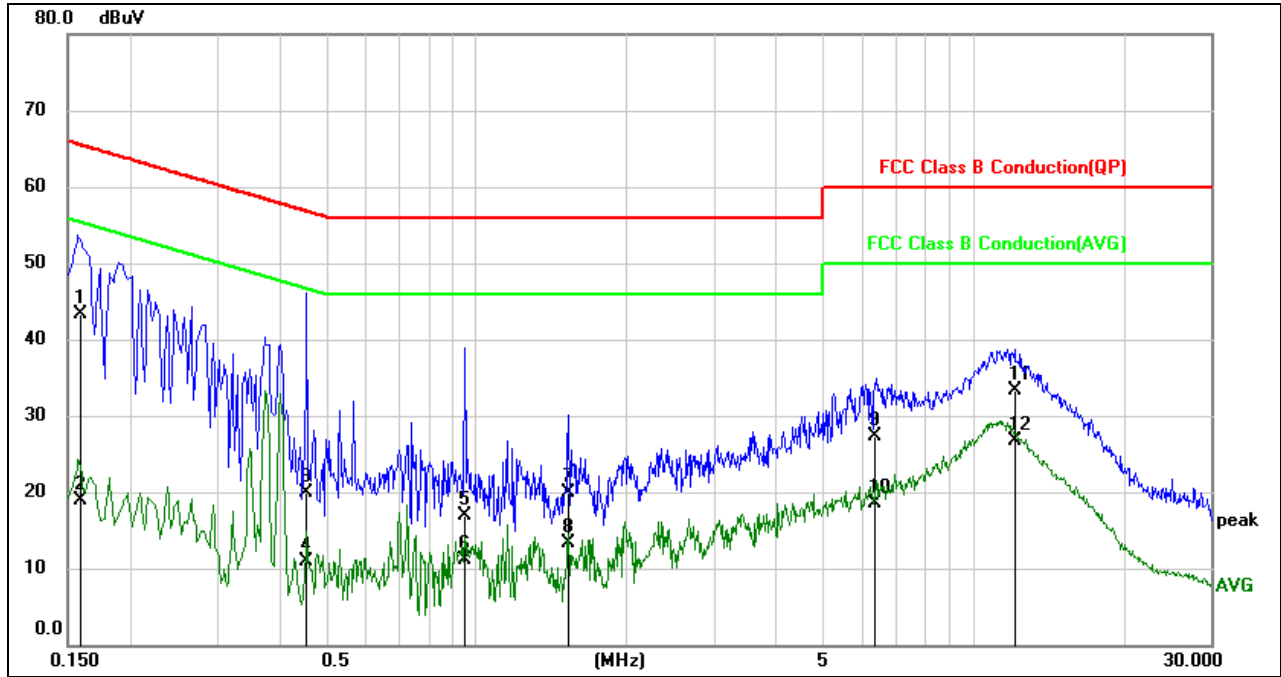

No.	Frequency (MHz)	Reading (dBuV)	Correct (dB)	Result (dBuV)	Limit (dBuV)	Margin (dB)	Remark
1	0.1594	33.74	9.62	43.36	65.50	-22.14	QP
2	0.1594	9.37	9.62	18.99	55.50	-36.51	AVG
3	0.4507	10.25	9.63	19.88	56.86	-36.98	QP
4	0.4507	1.30	9.63	10.93	46.86	-35.93	AVG
5	0.9433	7.35	9.64	16.99	56.00	-39.01	QP
6	0.9433	1.43	9.64	11.07	46.00	-34.93	AVG
7	1.5253	10.19	9.65	19.84	56.00	-36.16	QP
8	1.5253	3.74	9.65	13.39	46.00	-32.61	AVG
9	6.3221	17.49	9.75	27.24	60.00	-32.76	QP
10	6.3221	8.79	9.75	18.54	50.00	-31.46	AVG
11	12.0583	23.39	10.00	33.39	60.00	-26.61	QP
12	12.0583	16.76	10.00	26.76	50.00	-23.24	AVG

- Note: 1. Result = Reading +Correct Factor.  
 2. If QP Result complies with AV limit, AV Result is deemed to comply with AV limit.  
 3. Test setup: RBW: 200 Hz (9 kHz—150 kHz), 9 kHz (150 kHz—30 MHz).  
 4. Step size: 80Hz (0.009MHz-0.15MHz), 4 kHz (0.15MHz-30MHz), Scan time: auto.



## 11. ANTENNA REQUIREMENTS

### APPLICABLE REQUIREMENTS

Please refer to FCC §15.203

An intentional radiator shall be designed to ensure that no antenna other than that furnished by the responsible party shall be used with the device. The use of a permanently attached antenna or of an antenna that uses a unique coupling to the intentional radiator shall be considered sufficient to comply with the provisions of this section. The manufacturer may design the unit so that a broken antenna can be replaced by the user, but the use of a standard antenna jack or electrical connector is prohibited.

Please refer to FCC §15.247(b)(4)

The conducted output power limit specified in paragraph (b) of this section is based on the use of antennas with directional gains that do not exceed 6 dBi. Except as shown in paragraph (c) of this section, if transmitting antennas of directional gain greater than 6 dBi are used, the conducted output power from the intentional radiator shall be reduced below the stated values in paragraphs (b)(1), (b)(2), and (b)(3) of this section, as appropriate, by the amount in dB that the directional gain of the antenna exceeds 6 dBi.

### RESULTS

Complies

**END OF REPORT**