

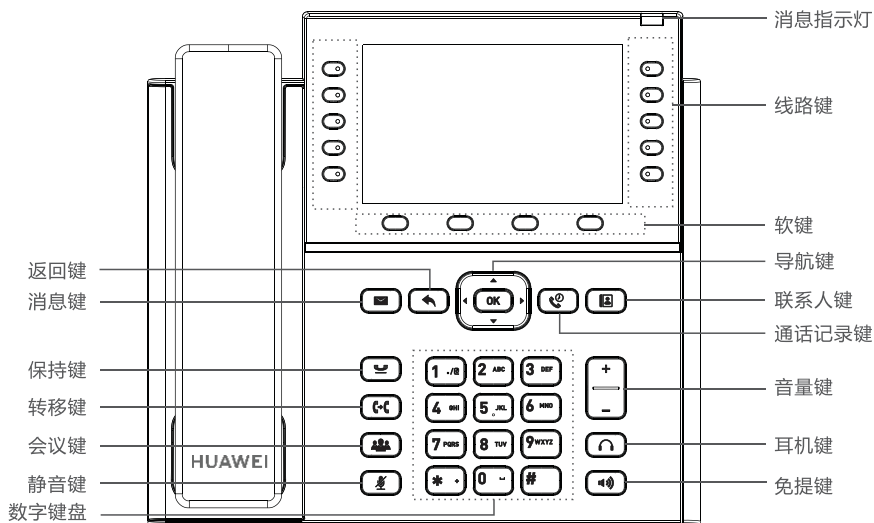

HUAWEI IP Phone 7960

快速入门





HUAWEI IP Phone 7960

Quick Start Guide

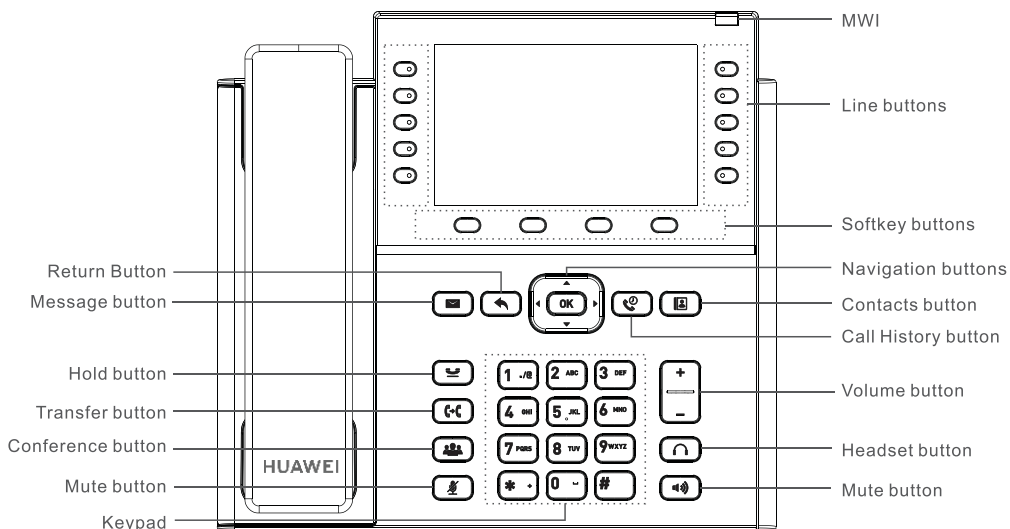

资料获取路径

请登录<http://support.huawei.com/enterprise> 网站，搜索关键字“CloudLink Phone 7960”，获取最新支持信息，包括用户指南、管理员指南。

HUAWEI IP Phone 7960

- 10线路，5英寸真彩大屏
- 支持蓝牙耳机
- 2个千兆以太网接口，支持以太网供电
- 支持USB可扩展接口，支持外接扩展模块

装箱清单

打开产品包装后，请对照以下列表检查各组件是否齐备。若有遗漏，请与经销商联系。

- 主机 x 1
- 手柄 x 1
- 快速入门 x 1
- 手柄 x 1
- 直通网线 x 1
- 支架 x 1

说明

电源适配器和耳麦独立包装，需要单独购买。

连接线缆

注意

- 请使用华为专用+12V电源适配器。由于使用其他电源适配器而造成的故障或损坏不在保修范围内。或者请使用交换机POE Class3供电 但是同一台话机不建议使用华为专用+12V电源适配器和交换机POE Class3同时供电。
- PC接口只能连接计算机，请勿将PC接口连接其他IP话机或者直接接入网络，以免导致IP话机功能或者网络异常。

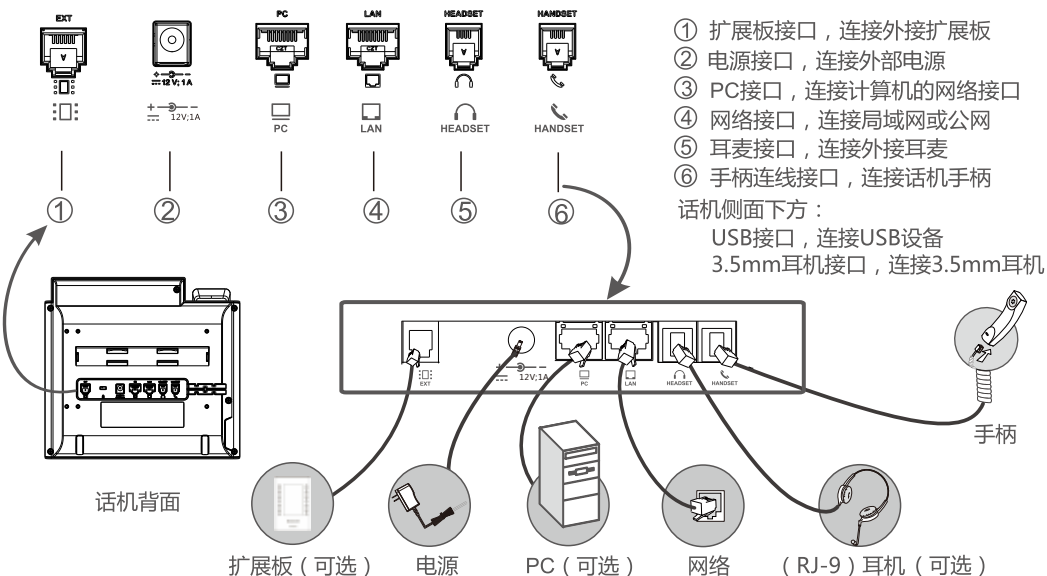

登录

您可以按照以下步骤登录话机主界面：

1. 话机上电后，进入登录界面。
2. 输入号码（Number）、密码（Password），按<登录（Log In）>软键进入话机主界面。

说明

- 登录时，请确认话机已经正常连接网络，即登录界面右上角未出现 图标。若仍无法成功登录，请咨询系统管理员。
- 话机出厂默认显示语言为英语，您可以选择“More（更多）> Language（语言）”进入语言界面，设置话机显示语言。

Additional Guides Available

For Additional support for the HUAWEI IP Phone 7960, visit <http://support.huawei.com/enterprise>. On the home page, search **CloudLink Phone 7960** to obtain the latest documentation including the user guide and administrator guide.

HUAWEI IP Phone 7960

- 10-line business IP phone, with a 5-inch true-color screen;
- Bluetooth headset ready
- 2 GE ports, support for power over Ethernet (PoE)
- 1 USB port; expansion module support

Packing List

Open the product package and check the items against the following checklist.
Contact your supplier if there are any discrepancies.

- Phone body x 1
- Handset cord x 1
- Quick Start Guide x 1
- Handset x 1
- Straight-through network cable x 1

NOTE

The power adapter and the headset must be purchased separately.

Connecting Cables

CAUTION

- The Huawei +12 VDC power adapter and PoE Class 3 (36-57Vdc) must be supply by LPS. A Huawei warranty does not cover any damage caused by the use of other power adapters. Alternatively, you can use the PoE Class3 supply, but using the Huawei +12 V DC power adapter and PoE. Class3 at the same time for the same phone is not recommended.
- The PC port can be connected only to a PC. If you connect the PC port to another IP phone or directly to the network, the IP phone may encounter function or network exceptions.

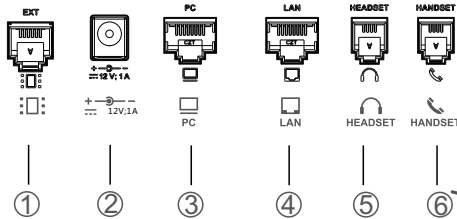

- ① Expansion port, connected to the expansion module
- ② Power port, connected to the power adapter
- ③ PC port, connected to the Ethernet port of a PC
- ④ LAN port (Internet port), connected to a local area network (LAN) or public network
- ⑤ Headset port, connected to an external headset
- ⑥ Handset port, connected to the handset cord

Lower part on the side surface of the IP phone:
USB port and 3.5mm headset port

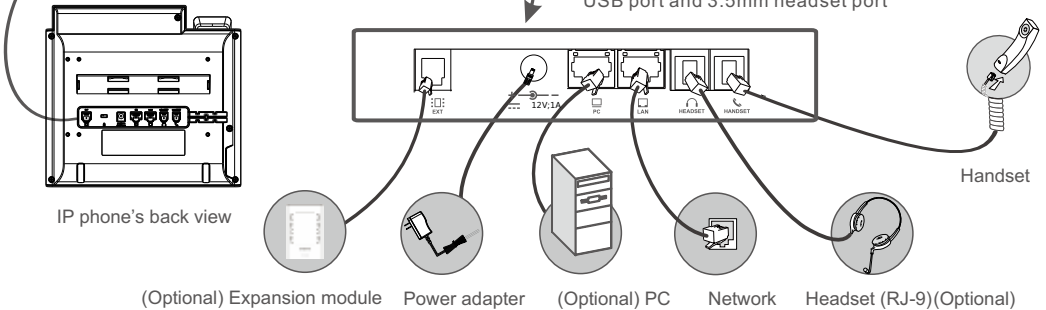

Logging In to Your Phone

Follow the steps below to log in to the home screen of your phone:





1. Power on your phone. The login screen is displayed.
2. Enter your account and password, and press the **Log In** softkey for login.

NOTE

- During a login, ensure that the CloudLink Phone 7960 is properly connected to the network (that is, the  icon is not displayed at the upper right corner of the login screen). If you still fail to log in, contact your system administrator.
- From the login screen, choose **More > Lang.**, the **Language** screen is displayed. You can select a language on this screen.

拨打电话

您可以通过以下方式拨打电话：

- 直接拨打：
 - 拿起手柄或按  进入拨号界面。
 - 输入电话号码，按  或<呼叫>软键。
 - 先输入电话号码，再拿起手柄或按 .
- 通话记录拨打：
按 , 选择相应记录，按<呼叫>软键。
- 联系人拨打：
按 , 选择相应联系人，按<呼叫>软键。

接听电话

您可以在有新来电时进行以下操作：

- 接听来电：拿起手柄或按  或<接听>软键。
- 转移来电：按<转移>软键，输入号码后再按<完成转移>软键。
- 拒绝来电：按<拒绝>软键。
- 忽略来电：按<忽略>软键。







呼叫保持

您可以在通话过程中进行以下操作：

按<保持>软键，将通话置于呼叫保持状态。
再按<恢复通话>软键，恢复保持的通话。

呼叫转移

您可以在通话过程中，将电话转移给第三方接听。

- 盲转：
按  或<转移>软键，输入号码后再按  或<完成转移>软键。
- 半咨询转：
按  或<转移>软键，输入号码后再按<呼叫>软键呼出，听到回铃音后，再按  或<完成转移>软键。
- 咨询转：
按  或<转移>软键，输入号码后再按<呼叫>软键呼出，对方接听后，再按  或<完成转移>软键。



呼叫前转

您可以在不方便接电话的情况下，将来电前转至其他电话号码。

1. 按<导航键>在主界面选择“应用程序>个性化>呼叫业务”，进入呼叫业务界面。
2. 选择“呼叫前转”，按<修改>软键。
3. 选择一种前转方式，按<选择>软键。
4. 选择“转接号码”，输入转接号码。
5. 按<选择>软键。

免打扰

若您不希望有来电打扰，可以使用免打扰功能，拒绝所有来电。

- 开启免打扰：
在主界面按<免打扰>软键，话机状态栏显示 , 主界面下方显示“ 电话已设置免打扰”。
- 关闭免打扰：
在主界面再按一次<免打扰>软键，话机状态栏的  和界面下方的提示信息消失。

本地会议

您可以发起本地会议，进行三方通话。如果帐号支持，可实现最多六方通话。

1. A与B正在通话过程中，A（发起方）按  或<会议>软键，输入C的号码后呼出。
2. A与C建立通话后，A按<加入会议>软键，实现三方通话。

A可以再按<添加>软键，输入D的号码呼出，建立通话后，按<加入会议>软键，实现多方通话。A还可以对与会者进行禁止发言、请出与会者等操作。

其他功能

- 通讯录
配置通讯录功能后，话机能够查询实时更新的海量通讯录信息。
- 一键切换
话机支持一键切换功能，允许用户将通话转移到其他话机或手机，也可取回通话。

说明

更多内容请参见话机用户指南或咨询系统管理员。

疑问与解答

- 问：免提通话有声音，摘机后无声音？
答：请检查手柄线是否正确连接到手柄线接口，或连接处水晶头是否松动。
- 问：如何查看话机的基本信息，如IP地址？
答：请在主界面中，选择“应用程序>状态”进入状态信息界面，查看话机的基本信息。

合格证

检验员： _____



Placing a Call

You can place a call in any of the following ways:

- Directly dialing a number
 - Pick up the handset or press .
 - Dial a number and press or the **Call** softkey.
 - Dial a number and pick up the handset or press .
- Using the call history
 - Press ,select a record, and press the **Call** softkey.
- Using contacts
 - Press ,select a record, and press the **Call** softkey.

Answering a Call

You can respond to a call in any of the following ways:

- Answering a call: Pick up the handset or press or the **Answer** softkey.
- Transferring a call: Press the **Transfer** softkey, enter the destination number, and press the **Done** softkey .
- Rejecting a call: Press the **Reject** softkey.
- Ignoring a call: Press the **Ignore** softkey.

Call Hold

You can perform the following operations during a call:

- Press the **Hold** softkey to hold a call.
- Press the **Resume** softkey to resume a call.

Call Transfer

You can transfer an ongoing call to a third-party.

- Blind transfer
 - Press or the **Transfer** softkey, enter the destination number and press or the **Done** softkey.
- Semi-consult transfer
 - Press or the **Transfer** softkey, enter the destination number, and press the **Call** softkey. After hearing a ringback tone,press or the **Done** softkey.
- Consult transfer
 - Press or the **Transfer** softkey, enter the destination number, and press the **Call** softkey. After the other party picks up the phone, press or the **Done** softkey.

Call Forward

You can forward a call to a preset forward-to number whenever necessary. To set call forward:

1. Press the navigation buttons and choose **Apps > Pref. > Call Settings** on the home screen of the phone.
- 2.Select **Call Forward** and press the **Modify** softkey.
- 3.Select the desired call forward mode and press the **Select** softkey.
- 4.Select **Number** and enter the destination number.
5. Press the **Select** softkey.

DND

You can use the Do Not Disturb (DND) feature to prevent incoming calls from ringing your phone.

- To enable DND
 - Press the **DND** softkey. The phone screen displays and the message" DND enabled".
- To disable DND
 - Press the **DND** softkey again. The phone screen no longer displays or the message" DND enabled".

Local Conference

You can hold a three-party local conference call. A local conference call involving a maximum of six participants is supported.

1. During a call (for example, with user B), press or the **Conf** softkey and dial the number of another user (for example, user C).
2. After a call with user C is set up, press the **Join** softkey to implement a three-party conference call.

After a three-party conference call is set up, you can invite more users to the conference. Specifically, press the **Add** softkey, dial the number of another user (for example, user D), and after a call with user D is set up, press the **Join** softkey.

You can also perform conference control operations such as muting a participant, removing a participant from a conference, and ending a conference.

Other Functions

- Directory
 - After the directory is configured, you can use your phone to query the corporate contact information in real time.
- One-Key Switch
 - The IP Phone supports one-key switch, allowing users to switch calls between the IP Phone and any other bound IP phone or mobile phone.

NOTE

For details, see the *IP Phone User Guide* or contact your system administrator.

Q&A

- Q: I can hear a voice coming from the speakerphone but I cannot hear anything from the handset. Why?
- A: The handset cord may be connected to the incorrect port or the connection between the handset cord and the handset port may be loose.
- Q: How can I view basic phone information, such as the IP address?
- A: Choose **Apps > Status** on the home screen of the phone. You can view basic phone information on this screen.

Qualification Card

Inspector: _____





保修卡

Warranty Card

尊敬的用户，感谢您使用华为技术有限公司的产品。

Thank you for choosing Huawei.

为了更好地为您服务，在购买产品后，请您阅读、填写并妥善保存此保修卡。

For better services, please read this warranty card carefully, fill in the required information and keep the card properly.

信息登记Registry

用户公司Your Name (or company name): _____

联系人Contact: _____

通信地址Address: _____

联系电话Telephone: _____

产品型号Product Model: _____

产品序号Serial Number: _____

发票号码Invoice Number: _____

保修截止日期Expiration Date: _____

销售单位名称Dealer Name: _____

销售单位地址Dealer's Address: _____

销售单位电话Dealer's Telephone: _____

用户保存 遗失不补 Keep the card properly, no replacement for card loss

销售单位（盖章有效）：

Dealer's Seal:



■ 保修说明 Limited Warranty

消费者通过合法渠道购买的华为技术有限公司产品，在保修期内如果出现非人为原因造成的故障，可以享受产品保修服务。为保证您的合法权益，请注意以下事项：

Huawei warrants its products to be free from defects in materials and workmanship under proper use in normal conditions during the warranty period.

Special Notice:

1. 若在购买合同中已规定相关保修策略，请以合同为准，此保修卡仅作保修凭证。
The warranty terms in the purchase contract enjoy higher validity and this card is solely used as warranty certificate.
2. 保修卡应由用户妥善保管，遗失不补，涂改无效。
The warranty card must be preserved in good condition and free of any scratch or alteration.
3. 本产品若发生非人为原因造成的故障，用户可凭保修卡在保修期内联系销售单位进行免费维修。
The warranty card shall be presented when the product is returned for repair.

在用户使用过程中，符合下列情况之一者不在保修范围：

This warranty card is inapplicable to defects caused by:

1. 由于擅自拆机、改装等人为原因造成的故障。
Modifications that is not performed by Huawei authorized service partner on the warranted product
2. 由于使用环境不符合产品要求造成的故障。
Improper operating environment of the product
3. 由于不可抗因素（如火灾、地震、雷击等）而造成的故障或损坏。
Force majeure including but not limited to fire, earthquake, lightning and tsunami
4. 未按产品手册中的要求使用、维护、保养而造成的损坏。
Operations that are performed without following the User Guide
5. 使用过程中引起的产品外壳、电源等的破损。
Normal wear and tear of components, including but not limited to the shell and the power module
6. 保修卡与产品序列号不一致或者保修卡被涂改。
The warranty card is altered or illegible, or the product serial number recorded on the warranty card is inconsistent with the actual one imprinted or labeled on the product.

凡不在免费保修范围内，并且可以维修的产品，均提供有偿维修服务。

In any case that is not covered by this limited warranty or should the warranty expire, Huawei shall charge for the service(s) claimed for the products if the product is still remediable.

本保修卡内容的最终解释权归华为技术有限公司所有。

Huawei preserves the right for interpretation of this limited warranty.

■ 联系方式 Contact Information

华为技术有限公司
深圳市龙岗区坂田华为总部办公楼
邮编：518129
网址：<http://www.huawei.com>

Huawei Technologies Co., Ltd
Huawei Industrial Base
Bantian, Longgang, Shenzhen 518129
People's Republic of China
Website: <http://www.huawei.com>



电子电气产品有害物质声明

部件名称	有毒有害物质或元素					
	铅 (Pb)	汞 (Hg)	镉 (Cd)	六价铬 (Cr6+)	多溴联苯 (PBB)	多溴二苯醚 (PBDE)
结构件	○	○	○	○	○	○
单板/电路 模块	X	○	○	○	○	○
电线电缆	○	○	○	○	○	○
配套设备	○	○	○	○	○	○

本表格依据SJ/T 11364的规定编制。

- ：表示该有害物质在该部件所有均质材料中的含量均在GB/T 26572规定的限量要求以下。
- X：表示该有害物质至少在该部件的某一均质材料中的含量超出GB/T 26572规定的限量要求，且目前没有成熟的替代方案。

说明

单板/电路模块：

- 部分元器件管脚含铅
- 焊料含铅



本产品的环保使用期限为20年，标识如左图所示。某些可更换的零部件会有一个不同的环保使用期贴在其产品上。此环保使用期限只适用于产品是在产品手册中所规定的条件下工作。

开源声明

您可以登录话机Web页面，选择“状态查看 > 关于话机”，查看“法律声明”。



Disposal and Recycling Information



This symbol on the device and any included batteries indicates that they should not be disposed of as normal household garbage. Do not dispose of your device or batteries as unsorted municipal waste. They should be handed over to a certified collection point for recycling or proper disposal when they can no longer be used.

For more detailed information about the recycling of the device or batteries, contact your local city office, the household waste disposal service, or the retail store where you purchased this device.

The disposal of this device is subject to the Waste from Electrical and Electronic Equipment (WEEE) Directive of the European Union. The purpose for separating WEEE and batteries from other waste is to minimize any environmental impact and health hazards due to the presence of hazardous substances.

Reduction of Hazardous Substances

This device is compliant with the EU Registration, Evaluation, Authorization and Restriction of Chemicals (REACH) Regulation (Regulation No 1907/2006/EC of the European Parliament and of the Council) and the EU Restriction of Hazardous Substances (RoHS) Directive (Directive 2011/65/EU of the European Parliament and of the Council). For more information about the REACH compliance of the device, visit www.huaweidevice.com/certification. You are recommended to visit the website regularly for up-to-date information.



This product has an Environment-friendly Use Period (EFUP) of 20 years as shown in the figure. Some replaceable components have EFUP labels of their own. The EFUP is suitable for the products that work in the conditions that are specified in the product manual.

Open source software statement

You can log in to the phone web page and choose **View Status** > **About Phone** to check related information in Legal Statement.



1506-18KT000



Federal Communication Commission Interference Statement

This device has been tested and found to comply with the limits for a **Class B** digital device, pursuant to Part 15 of the FCC Rules. These limits are designed to provide reasonable protection against harmful interference in a residential installation. This device generates, uses and can radiate radio frequency energy and, if not installed and used in accordance with the instructions, may cause harmful interference to radio communications. However, there is no guarantee that interference will not occur in a particular installation. If this device does cause harmful interference to radio or television reception, which can be determined by turning the device off and on, the user is encouraged to try to correct the interference by one or more of the following measures:

- Reorient or relocate the receiving antenna.
- Increase the separation between the device and receiver.
- Connect the device into an outlet on a circuit different from that to which the receiver is connected.
- Consult the dealer or an experienced radio/TV technician for help.

FCC Caution: Any changes or modifications not expressly approved by the party responsible for compliance could void the user's authority to operate this device.

This device complies with Part 15 of the FCC Rules. Operation is subject to the following two conditions: (1) This device may not cause harmful interference, and (2) this device must accept any interference received, including interference that may cause undesired operation.

This device and its antenna(s) must not be co-located or operating in conjunction with any other antenna or transmitter.

IMPORTANT NOTE:

FCC Radiation Exposure Statement:

This device complies with FCC radiation exposure limits set forth for an uncontrolled environment. This device should be installed and operated with minimum distance 20cm between the radiator & your body.

IC User's Manual:

This device contains licence-exempt transmitter(s)/receiver(s) that comply with Innovation, Science and Economic Development Canada's licence-exempt RSS(s). Operation is subject to the following two conditions:

1. This device may not cause interference.
2. This device must accept any interference, including interference that may cause undesired operation of the device.

L'émetteur/récepteur exempt de licence contenu dans le présent appareil est conforme aux CNR d'Innovation, Sciences et Développement économique Canada applicables aux appareils radio exempts de licence. L'exploitation est autorisée aux deux conditions suivantes :

1. L'appareil ne doit pas produire de brouillage;
2. L'appareil doit accepter tout brouillage radioélectrique subi, même si le brouillage est susceptible d'en compromettre le fonctionnement.

IMPORTANT NOTE:

IC Radiation Exposure Statement:

This equipment complies with IC RSS-102 radiation exposure limits set forth for an uncontrolled environment. This device should be installed and operated with minimum distance 20cm between the radiator & your body.

Cet équipement est conforme aux limites d'exposition aux rayonnements IC établies pour un environnement non contrôlé. Cet dispositif doit être installé et utilisé avec un minimum de 20cm de distance entre la source de rayonnement et votre corps

Co-located

The transmitter module may not be co-located with any other transmitter or antenna.
Le module émetteur peut ne pas être coïmplanté avec un autre émetteur ou antenne.

Digital apparatus (ICES003)

CAN ICES-3 (B)/NMB-3(B)

This device complies with Industry Canada CS-03.

Cet appareil est également conforme à dispose de la certification CS- 03 d'Industrie Canada

CE User's Manual:

CE RF Exposure Compliance

In order to comply with human exposure to radiofrequency standards this Product should be installed and operated with 20cm minimum distance between the radiator and your body.

Radio operating frequency :2400~2483.5MHz : Max EIRP 13 dBm(20mW)