



LTE Outdoor CPE B2338-168
(Package includes B2338-168ODU & B2338-168IDU)
V100R001C00
Quick Start Guide

Issue **Draft A**
Date **2016-10-18**

Copyright © Huawei Technologies Co., Ltd. 2016. All rights reserved.

No part of this document may be reproduced or transmitted in any form or by any means without prior written consent of Huawei Technologies Co., Ltd.

Trademarks and Permissions



and other Huawei trademarks are trademarks of Huawei Technologies Co., Ltd.

All other trademarks and trade names mentioned in this document are the property of their respective holders.

Notice

The purchased products, services and features are stipulated by the contract made between Huawei and the customer. All or part of the products, services and features described in this document may not be within the purchase scope or the usage scope. Unless otherwise specified in the contract, all statements, information, and recommendations in this document are provided "AS IS" without warranties, guarantees or representations of any kind, either express or implied.

The information in this document is subject to change without notice. Every effort has been made in the preparation of this document to ensure accuracy of the contents, but all statements, information, and recommendations in this document do not constitute a warranty of any kind, express or implied.

Huawei Technologies Co., Ltd.

Address: Huawei Industrial Base
Bantian, Longgang
Shenzhen 518129
People's Republic of China

Website: <http://www.huawei.com>

Email: support@huawei.com

About This Document

Change History

Changes between document issues are cumulative.

The latest document issue contains all the changes made in earlier issues.





Draft A (2016-10-18)

This issue is the first release.

Contents

About This Document	ii
1 What You Need	1
2 ODU and IDU Panels	2
2.1 ODU Panel.....	2
2.2 IDU Rear Panel.....	3
2.3 IDU Front Panel.....	4
3 Installation	6
3.1 Select a Location.....	6
3.2 Mounting the Device	6
4 Connect to the Internet	10
4.1 Login in the web GUI	10
4.2 Operation in the web GUI.....	11
5 Europe - EU Declaration of Conformity	錯誤! 尚未定義書籤。

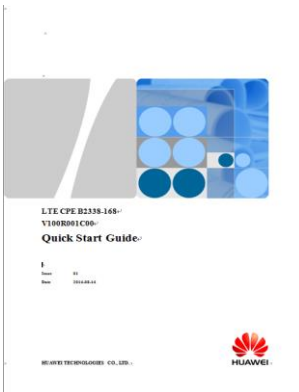
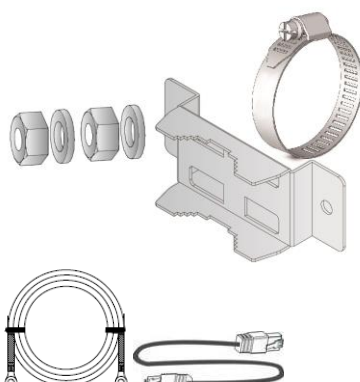
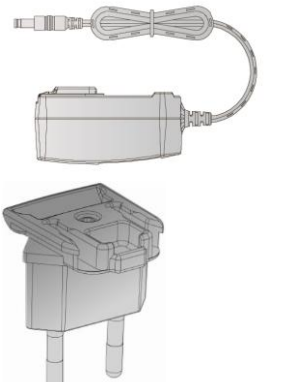
1 What You Need

LTE Outdoor CPE	LTE IDU Device	Quick Start Guide
		
<p>Mount Kit: Washer*2, Metal Strap*2, Bracket One ground cable and one RJ-45 cable for connecting IDU and computer</p>	<p>Power Adapter & Power Plug</p>	<p>CAT5 Outdoor Shielded Patch Ethernet cable for connecting IDU and ODU (not included in the package)</p>
		



2 ODU and IDU Panels

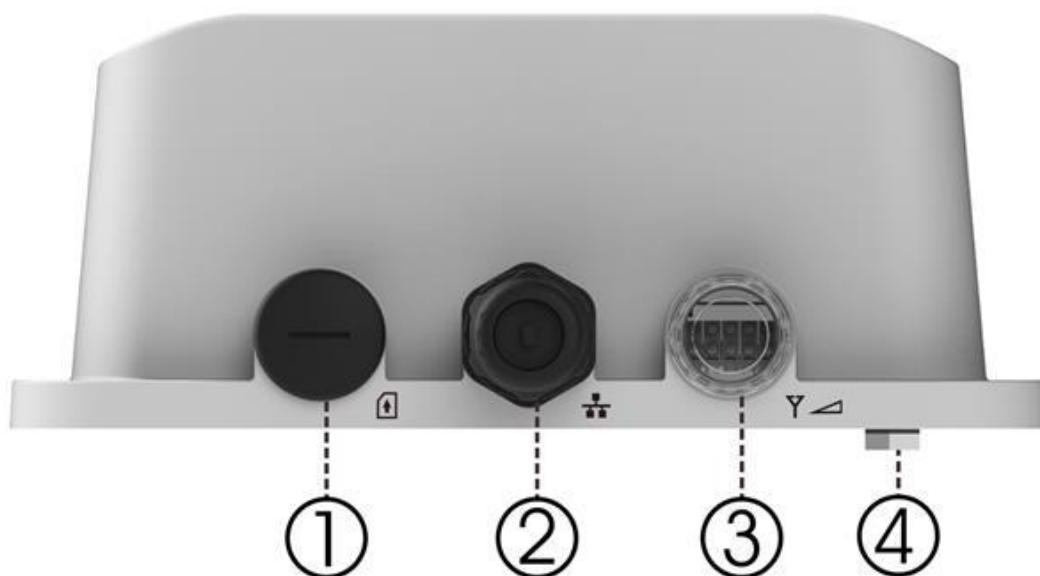





2.1 ODU Panel

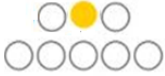
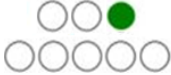

1. One SIM card slot for inserting SIM card.
2. One RJ-45 connector for connecting to the IDU POE port.
3. LED indicator inside.
4. A grounding screw on the rear panel.

ODU LED Indicators as the following table.

LED name	Location	Color	LED Behavior	Status Indication
LED list		-	-	-
Main Power		Blue	ON	Power On
			Blinking	Factory Reset
			OFF	Power Off

LED name	Location	Color	LED Behavior	Status Indication
Ethernet Status		Yellow	Steady ON	Ethernet connected
			Blinking	Upgrading
			OFF	No Ethernet action
SIM status		Green	Steady ON	SIM Detected
			Blinking when On-hook	PUK / PIN Code
			OFF	No SIM Detected
4G Status LED : Link Status		When CPE is power on, each LED indicates each link status		
4G-Signal		Blue	Chasing light	Searching
		Blue	Blinking	Network Entry
4G-1		Blue	Steady ON	SINR < 0dB
4G-2		Blue	Steady ON	0dB ≤ SINR < 4dB
4G-3		Blue	Steady ON	4dB ≤ SINR < 9dB
4G-4		Blue	Steady ON	9dB ≤ SINR < 16dB
4G-5		Blue	Steady ON	16dB ≤ SINR

2.2 IDU Rear Panel

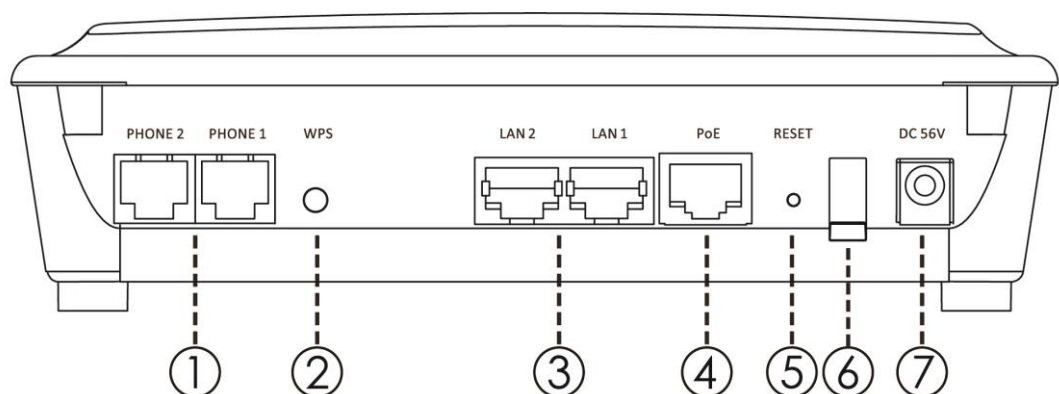

1. Phone: Connect your telephone to indoor device with an RJ-11 telephone cable.
2. WPS button: Enable the user to configure WiFi security on WPS-enabled devices.
3. LAN ports: Connect PC, Hub, switch or other network equipment by using RJ-45 Ethernet cable.
4. PoE port: Connect with ODU RJ-45 connector.
5. Reset button: To reboot the device, press and hold the reset button less than 5 seconds. To reset the device to factory defaults, press and hold the reset button more than 5 seconds.
6. Power switch: Power on or power off.
7. Power port: Connect the power adapter.

2.3 IDU Front Panel

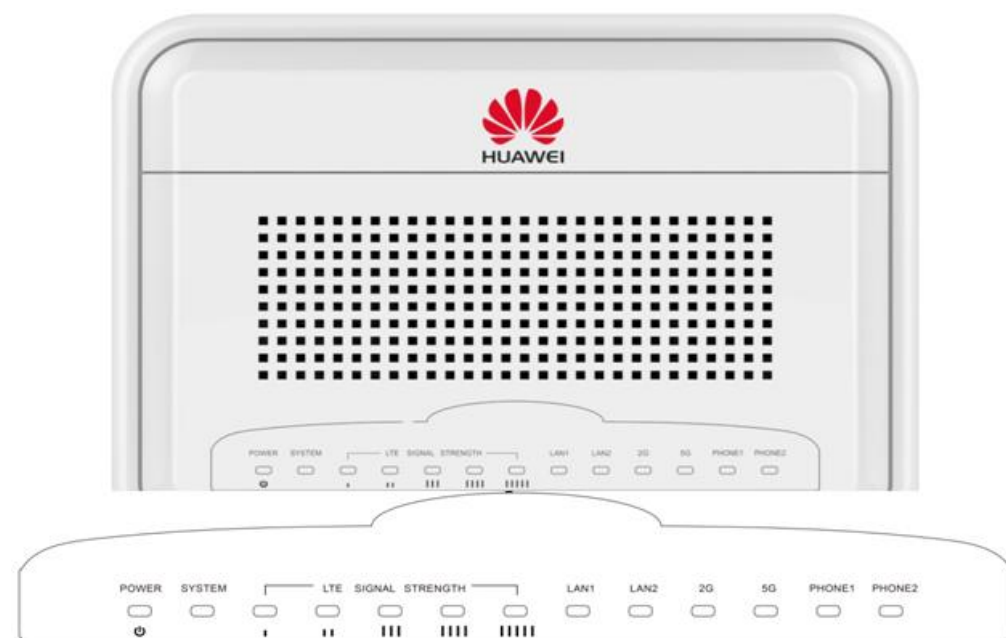

IDU LED Indicators as the following table.

No.	LED name	Color	LED Behavior	Status Indication
1	Main Power	Green	On	Power On
			Off	Power Off
2	System	Green	On	System is connected
			Blinking	System is upgrading
			Off	System is disconnected
3	LTE SIGNAL STRENGTH	Green	On	Display signal Strength 1 LED: SINR < 0dB 2 LEDs: 0dB ≤ SINR < 4dB 3 LEDs: 4dB ≤ SINR < 9dB

No.	LED name	Color	LED Behavior	Status Indication
				4 LEDs: $9\text{dB} \leq \text{SINR} < 16\text{dB}$ 5 LEDs: $16\text{dB} \leq \text{SINR}$
			Off	No signal
			Chasing light	Searching
			Blinking	Network Entry
4	LAN 1 & 2	Green	Blinking	Ethernet connected
			Off	No Ethernet connected
5	2G	Green	On	Enable 2.4G WiFi
			Blinking	Data Transmission
			Off	Disable 2.4G WiFi
6	5G	Green	On	Enable 5G WiFi
			Blinking	Data transmission
			Off	Disable 5G WiFi
7	Phone 1 & 2	Green	On	Registered
			Blinking	Busy
			Off	De-registered

3 Installation

Before installing the ODU, please verify that you have all the items listed in 1 What You Need. If any of the items is missing or damaged, please contact your LTE service provider.

3.1 Select a Location.

The ODU should be pole-mounted outdoors and aligned so its antenna faces the nearest LTE base station. When selecting a suitable location for the unit, consider these guidelines:

1. When choosing a location to install the ODU, please note that the ODU's front panel should point towards your service provider's nearest base station.
You do not need to be able to see the base station from the ODU's position. However, if you experience the difficulties with signal reception, a Line of Sight (LoS) connection may have better result.
2. Place the ODU away from power and telephone lines.
3. Avoid placing the ODU nearby any metallic reflective surfaces.
4. Be sure to ground the ODU with an appropriate grounding wire by attaching it to the grounding screw on the unit and to a good ground connection.

3.2 Mounting the Device

Step 1 Preparation.

1. SIM card is inserted in the SIM slot by following the direction mark.
2. Make sure the grounding screw on the rear panel.
3. Connect a Grounding cable between the ground terminal of the ODU (marked \oplus) and a ground connection. (Suggest to with Ethernet lightning protector between Ethernet cable and indoor PoE supplier for better lightning and surge protection).
4. For additional lightning protection, it is recommended to use a lightning arrestor immediately before the Ethernet cable enters the building.

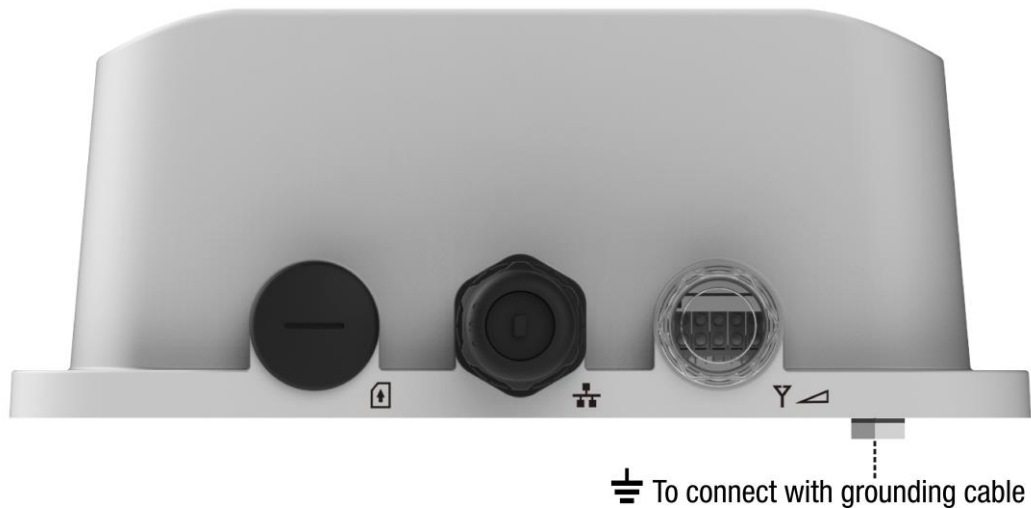

Step 2 Connect the cable with waterproof node.

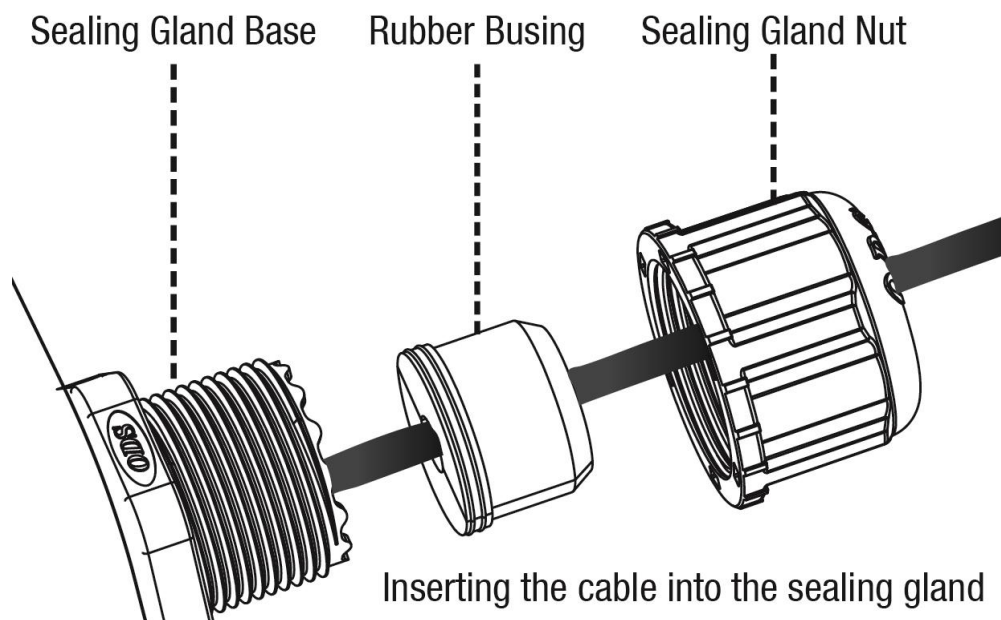

1. Remove the sealing gland plug from the gland nut.
2. Open the sealing gland nut and remove it. Do not disassemble the gland base from the bracket.
3. Insert the cable into the sealing gland base and connect it to the RJ-45 connector at the bottom of the ODU, labeled. Make sure that the connector is completely inserted and tightened.
4. Insert the rubber bushing on the cable into the gland base.
5. Gently twist the body into the ODU.

Step 3 Mounting the Device: Installing Pole Mount.

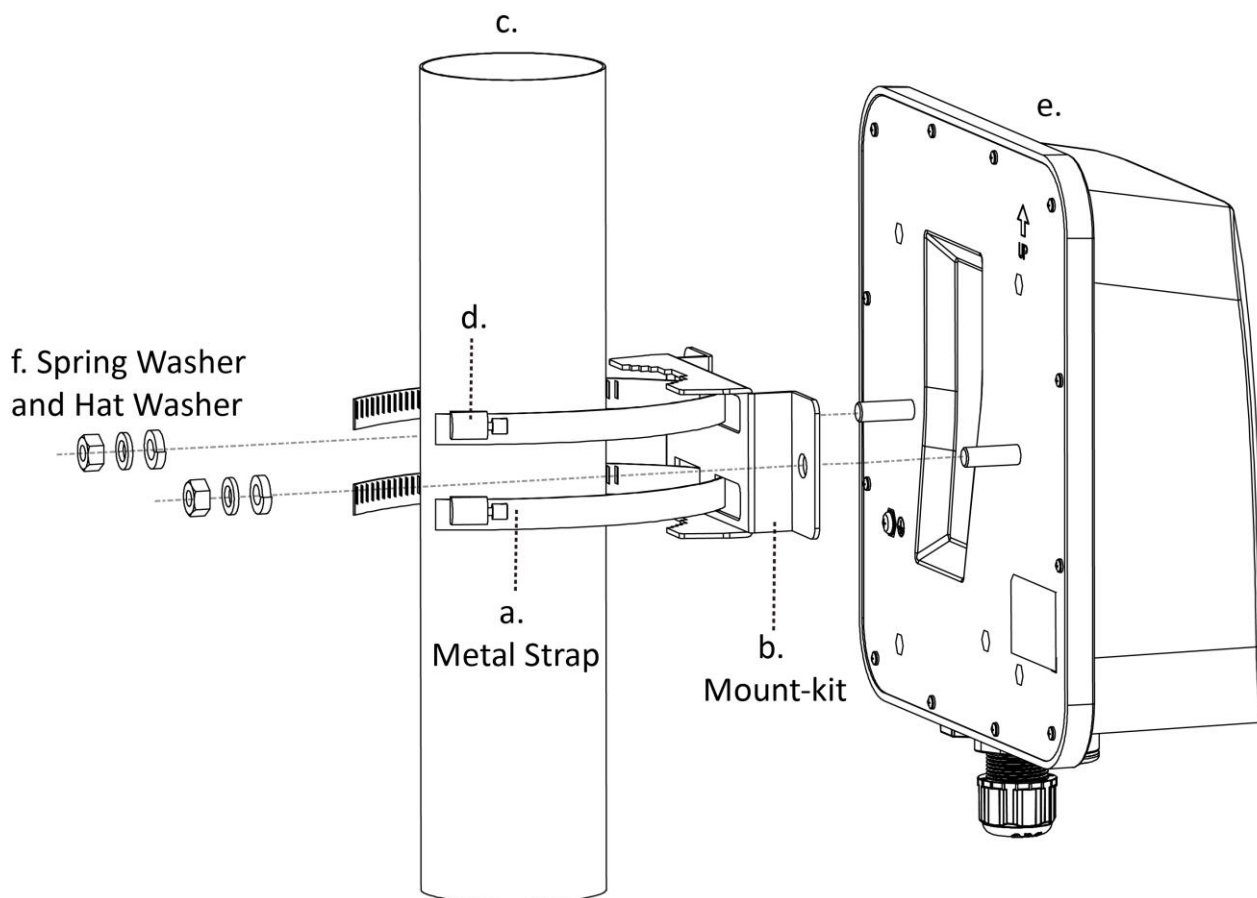

1. Loosen the locking mechanism of metal strap by hand or screwdriver. (a)
2. Wrap the metal strap with Pole-Mount Bracket. (a and b)
3. Attach the Pole-Mount bracket to the other side of the pole. (a, b, and d)
(The metal straps need to be installed on the pole whose maximized diameter is 90mm and minimized diameter is 65 mm.)
4. Tighten the locking mechanism of metal strap by screwdriver. (d)
5. Thread the M8 x 23mm bolts through a spring washer, hat washer and ODU. Tighten the nuts. (e and f)

Step 4 Set up the IDU.

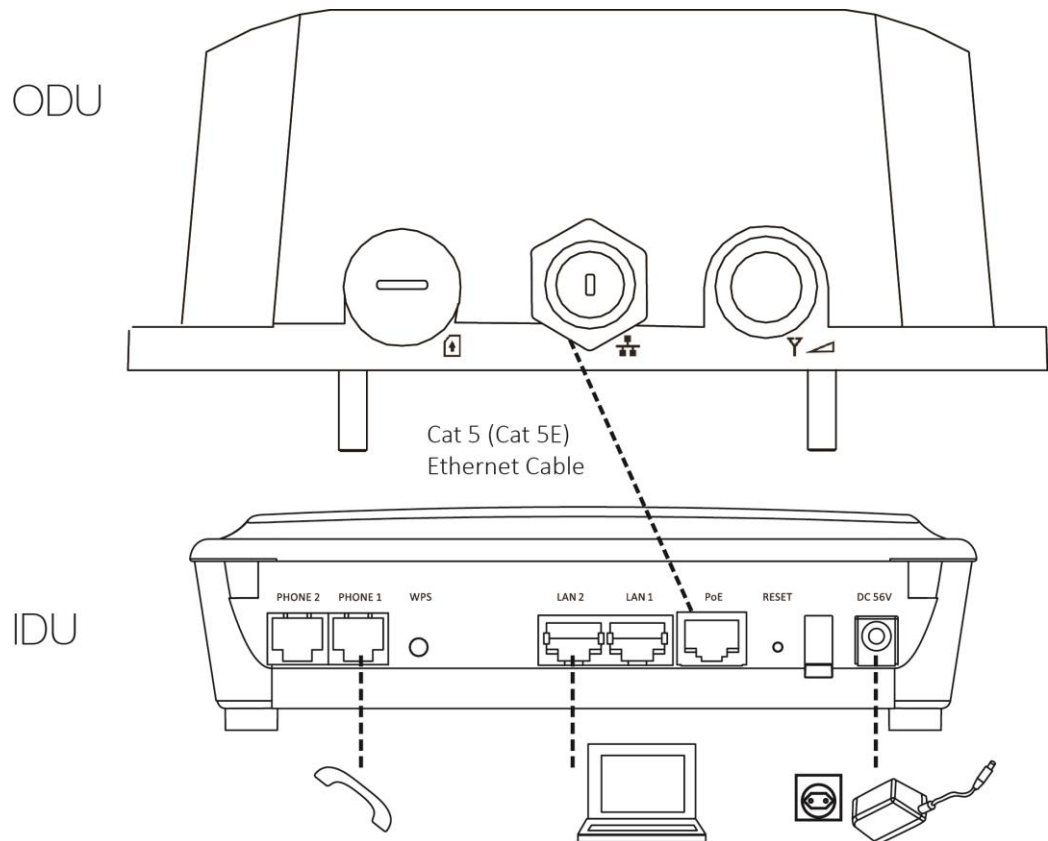

1. Connect the Ethernet cable between the computer and one of the Ethernet ports on IDU.
2. Insert power plug to the power adapter and then plug in power adapter to DC 56V port of IDU. The PWR LED would shine as steady green light when the device is power on.

4 Connect to the Internet

4.1 Login in the web GUI.

Step 1 Make sure the physical connection is OK

Step 2 PC will get default IP **192.168.1.x** (x: 2-254). Open a web browser and go to **https://192.168.1.1**. If your web browser is IE8.0/IE9.0, or 10.0, please choose **use TLS1.2** from the **IE > Internet Options** before log in.

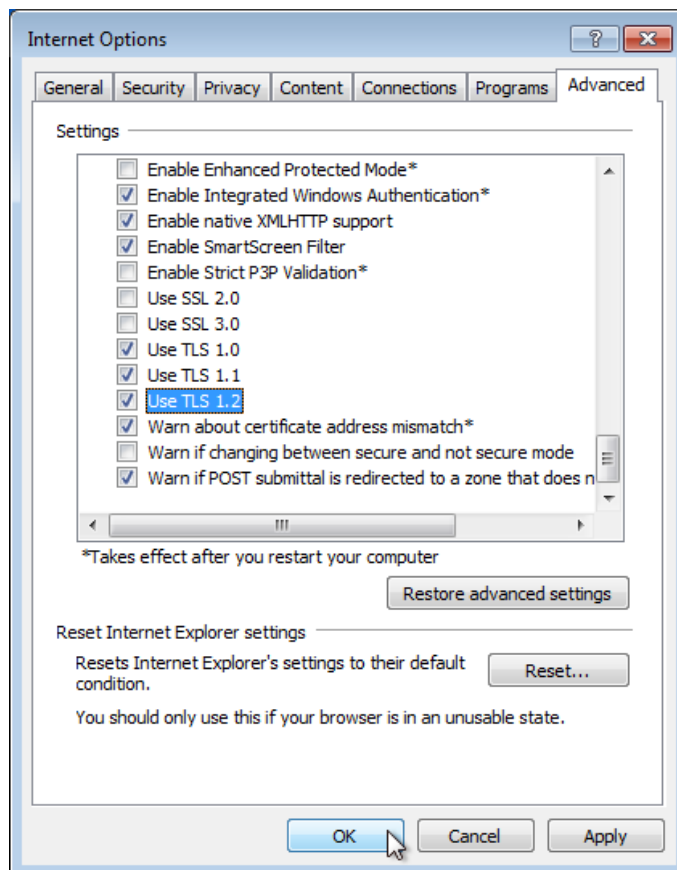

Step 3 Enter the default Username (**user**) and Password (**Enduser**), and then click **Login**.

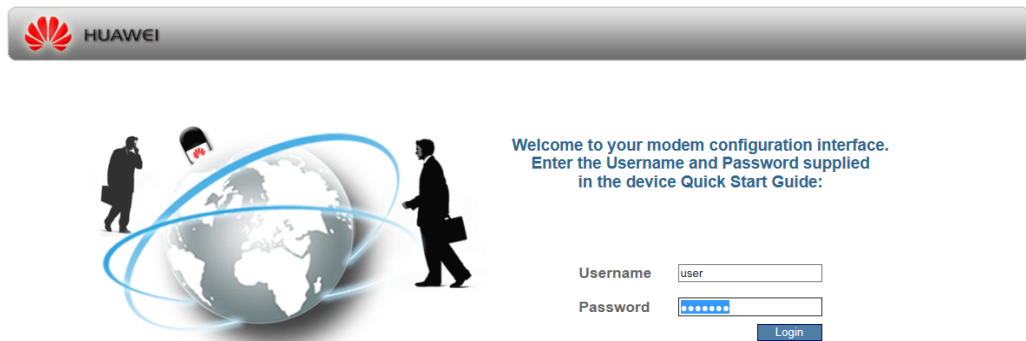

NOTICE

For your internet security, we recommend you to change the "default Wi-Fi password" while the first time log-in. Please go **Management > Setup Wizard** or **Management > Wi-Fi setup** to change the Wi-Fi password.

Try to enter a new password, retype it to confirm, and click **Apply**. Alternatively click Undo to proceed to the main menu if you do not want to change the password.

----End

4.2 Operation in the web GUI.

Step 1 Chang Password.

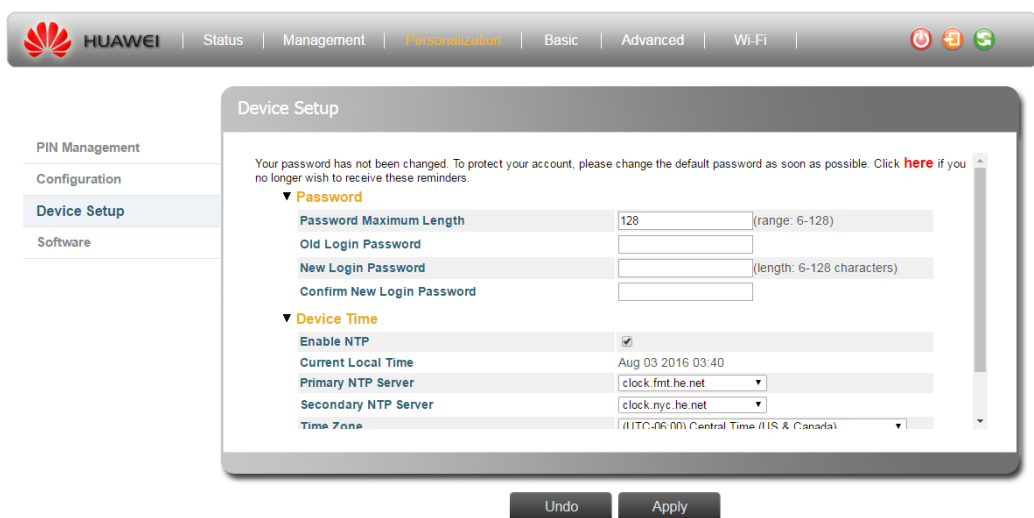

Step 2 Status Page.

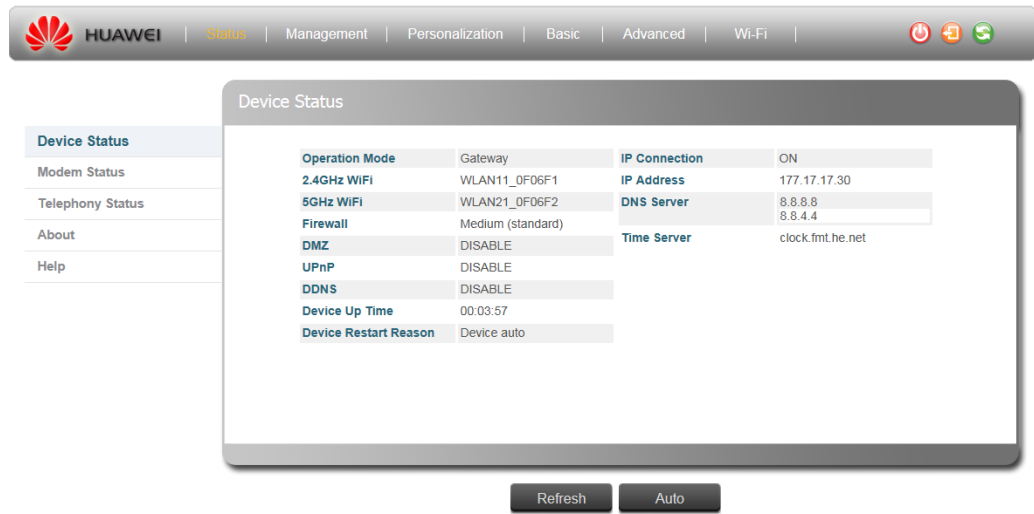

Step 3 Setting for APN.

If the **LTE SIGNAL STRENGTH** light keeps **BLINKING**, which means the LTE connection is fail, please try to manually configure the Internet connection. Click **Management > Modem Setup**. If the APN (Access Point Name) is not the same as what you were given, click the **Manual** icon, and revise the APN what you want, apply it.

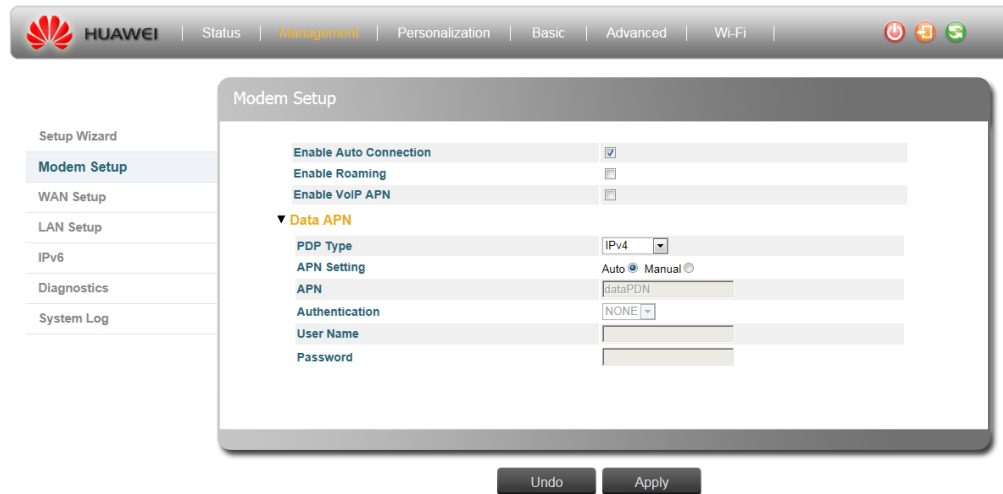

Step 4 Setting for PIN.

If a PIN code is required, click **Personalization** > **PIN Management** > **USIM's PIN/PUK Verification**. Enter it and then click **Verify**.

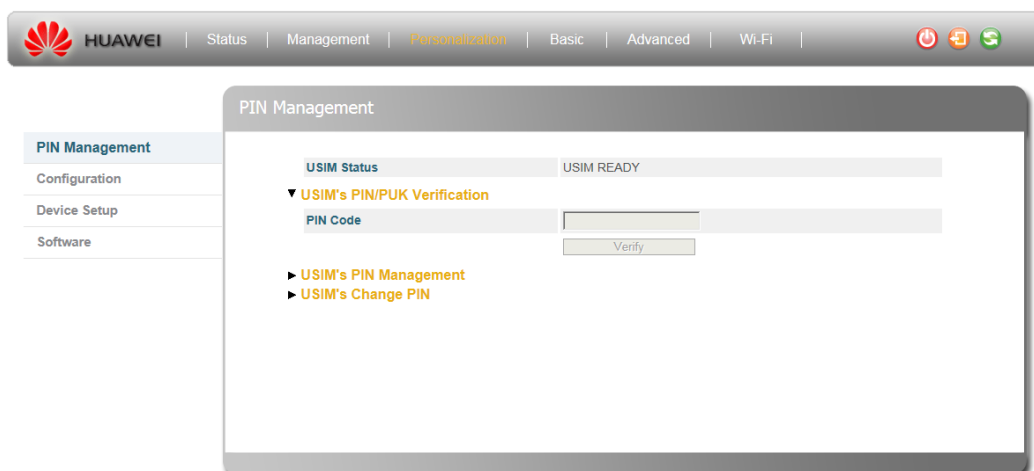

After LTE SIGNAL STRENGTH is steady on, you can start to browse the website. For more information, go to **Status** > **Help** page to **check the details**.

Step 5 WIFI Setting.

1. Turn the Wireless On or Off.

You can go to **Wi-Fi** > **Basic** in the Web GUI, select **Enable Wi-Fi**, and configure wireless settings and then click **Apply**. Go to Status > Help page for more information.

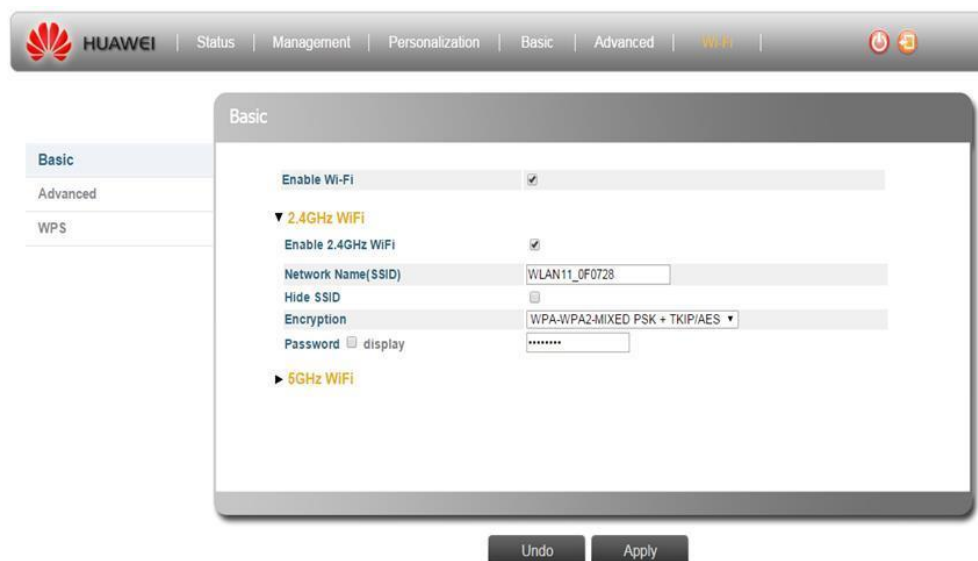

2. Activate WPS.

You can set up a wireless network with WPS (WiFi Protected Setup) or manually add a client to your wireless network. Activating WPS helps you quickly set up a wireless network with strong security.

Using the physical WPS button:

- a. Make sure the Power LED is on (not blinking).
- b. Press the WPS button more than one second and release it. The WPS LED would flash while the LTE Device sets up a WPS connection with the wireless device.

Using the WPS Button in the Web Configuration:

- a. Click **WiFi > WPS**.
- b. Choose the **PBC** or **PIN** and click **Start**.

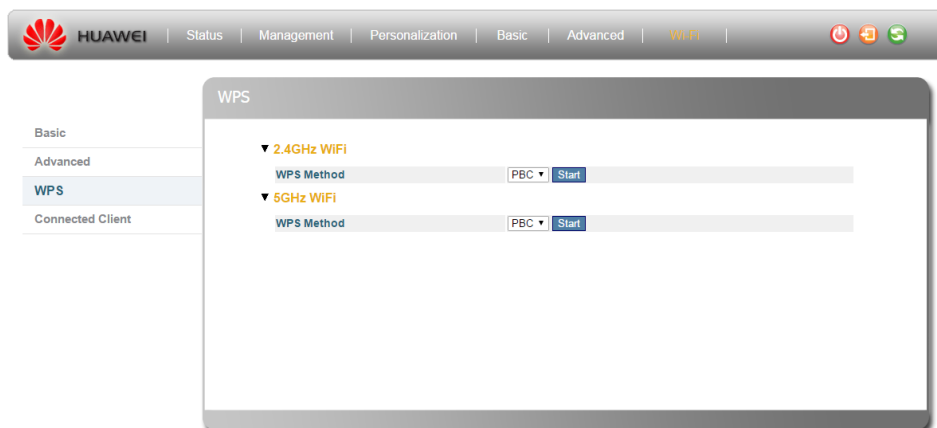

5 Certification Statement

5.1 Europe - EU Declaration of Conformity

This device complies with the essential requirements of the R&TTE Directive 1999/5/EC. The following test methods have been applied in order to prove presumption of conformity with the essential requirements of the R&TTE Directive 1999/5/EC:

- EN 301 908-1 V7.1.1
- EN 301 908-13 V6. 2.1
- EN 300 328 V1.9.1
- EN 301 893 V1.8.1
- EN 62311:2008; EN 50385:2002
- EN 301 489-1 V1.9.2
- EN 301 489-17 V2.2.1
- EN 301 489-24 V1.5.1
- EN55032: 2012/AC:2013, Class B
- EN 55024: 2010
- EN 60950-1:2006+A11:2009+A1:2010+A12:2011+A2:2013
- EN 60950-22: 2006+A11:2008

The minimum distance between the user and/or any bystander and the radiating structure of the transmitter is **40cm**.

In Italy the end-user should apply for a license at the national spectrum authorities in order to obtain authorization to use the device for setting up outdoor radio links and/or for supplying public access to telecommunications and/or network services.



[cs] Česky [Czech]	[Jméno výrobce] tímto prohlašuje, že tento [typ zařízení] je ve shodě se základními požadavky a dalšími příslušnými ustanoveními směrnice 1999/5/ES.
[da] Dansk [Danish]	Undertegnede [fabrikantens navn] erklærer herved, at følgende udstyr [udstyrets typebetegnelse] overholder de væsentlige krav og øvrige relevante krav i direktiv 1999/5/EF.
[de] Deutsch [German]	Hiermit erkläre [Name des Herstellers], dass sich das Gerät [Gerätetyp] in Übereinstimmung mit den grundlegenden Anforderungen und den übrigen einschlägigen Bestimmungen der Richtlinie 1999/5/EG befindet.
[et] Eesti [Estonian]	Käesolevaga kinnitab [tootja nimi = name of manufacturer] seadme [seadme tüüp = type of equipment] vastavust direktiivi 1999/5/EÜ põhinõuetele ja nimetatud direktiivist tulenevatele teistele asjakohastele sätetele.
[en] English	Hereby, [name of manufacturer], declares that this [type of equipment] is in compliance with the essential requirements and other relevant provisions of Directive 1999/5/EC.
[es] Español [Spanish]	Por medio de la presente [nombre del fabricante] declara que el [clase de equipo] cumple con los requisitos esenciales y cualesquiera otras disposiciones aplicables o exigibles de la Directiva 1999/5/CE.
[el] Ελληνική [Greek]	ΜΕ ΤΗΝ ΠΑΡΟΥΣΑ [name of manufacturer] ΔΗΛΩΝΕΙ ΟΤΙ [type of equipment] ΣΥΜΜΟΡΦΩΝΕΤΑΙ ΠΡΟΣ ΤΙΣ ΟΥΣΙΩΔΕΙΣ ΑΠΑΙΤΗΣΕΙΣ ΚΑΙ ΤΙΣ ΛΟΙΠΕΣ ΣΧΕΤΙΚΕΣ ΔΙΑΤΑΞΕΙΣ ΤΗΣ ΟΔΗΓΙΑΣ 1999/5/EK.
[fr] Français [French]	Par la présente [nom du fabricant] déclare que l'appareil [type d'appareil] est conforme aux exigences essentielles et aux autres dispositions pertinentes de la directive 1999/5/CE.
[it] Italiano [Italian]	Con la presente [nome del costruttore] dichiara che questo [tipo di apparecchio] è conforme ai requisiti essenziali ed alle altre disposizioni pertinenti stabilite dalla direttiva 1999/5/CE.
[lv] Latviski [Latvian]	Ar šo [name of manufacturer / izgatavotāja nosaukums] deklarē, ka [type of equipment / iekārtas tips] atbilst Direktīvas 1999/5/EK būtiskajām prasībām un citiem ar to saistītajiem noteikumiem.
[lt] Lietuvių [Lithuanian]	Šiuo [manufacturer name] deklaruojama, kad šis [equipment type] atitinka esminius reikalavimus ir kitas 1999/5/EB Direktyvos nuostatas.
[nl] Nederlands [Dutch]	Hierbij verklaart [naam van de fabrikant] dat het toestel [type van toestel] in overeenstemming is met de essentiële eisen en de andere relevante bepalingen van richtlijn 1999/5/EG.
[mt] Malti [Maltese]	Hawnhekk, [isem tal-manifattur], jiddikjara li dan [il-mudell tal-prodott] jikkonforma mal-htigijiet essenzjali u ma provvedimenti oħrajn rilevanti li hemm fid-Dirrettiva 1999/5/EC.

[hu] Magyar [Hungarian]	Alulírott, [gyártó neve] nyilatkozom, hogy a [... típus] megfelel a vonatkozó alapvető követelményeknek és az 1999/5/EC irányelv egyéb előírásainak.
[pl] Polski [Polish]	Niniejszym [nazwa producenta] oświadczam, że [nazwa wyrobu] jest zgodny z zasadniczymi wymogami oraz pozostałymi stosownymi postanowieniami Dyrektywy 1999/5/EC.
[pt] Português [Portuguese]	[Nome do fabricante] declara que este [tipo de equipamento] está conforme com os requisitos essenciais e outras disposições da Directiva 1999/5/CE.
[sl] Slovensko [Slovenian]	[Ime proizvajalca] izjavlja, da je ta [tip opreme] v skladu z bistvenimi zahtevami in ostalimi relevantnimi določili direktive 1999/5/ES.
[sk] Slovensky [Slovak]	[Meno výrobcu] týmto vyhlasuje, že [typ zariadenia] spĺňa základné požiadavky a všetky príslušné ustanovenia Smernice 1999/5/ES.
[fi] Suomi [Finnish]	[Valmistaja = manufacturer] vakuuttaa täten että [type of equipment = laitteen tyyppimerkintä] tyyppinen laite on direktiivin 1999/5/EY oleellisten vaatimusten ja sitä koskevien direktiivin muiden ehtojen mukainen.

5.2 Innovation, Science and Economic Development Canada statement

This device complies with Innovation, Science and Economic Development Canada's licence-exempt RSSs. Operation is subject to the following two conditions:

- (1) This device may not cause interference; and
- (2) This device must accept any interference, including interference that may cause undesired operation of the device.

Le présent appareil est conforme aux CNR d'Industrie Canada applicables aux appareils radio exempts de licence. L'exploitation est autorisée aux deux conditions suivantes:

- 1) l'appareil ne doit pas produire de brouillage;*
- 2) l'utilisateur de l'appareil doit accepter tout brouillage radioélectrique subi, même si le brouillage est susceptible d'en compromettre le fonctionnement.*

Caution:

- (i) the device for operation in the band 5150–5250 MHz is only for indoor use to reduce the potential for harmful interference to co-channel mobile satellite systems;
- (ii) for devices with detachable antenna(s), the maximum antenna gain permitted for devices in the band 5725-5850 MHz shall be such that the equipment still complies with the e.i.r.p. limits specified for point-to-point and non-point-to-point operation as appropriate; and

Avertissement:

- (i) les dispositifs fonctionnant dans la bande de 5150 à 5250MHz sont réservés uniquement pour une utilisation à l'intérieur afin de réduire les risques de brouillage préjudiciable aux systèmes de satellites mobiles utilisant les mêmes canaux;
- (ii) pour les dispositifs munis d'antennes amovibles, le gain maximal d'antenne permis (pour les dispositifs utilisant la bande de 5725 à 5850 MHz) doit être conforme à la limite de la p.i.r.e. spécifiée pour l'exploitation point à point et l'exploitation non point à point, selon le cas;

Radiation Exposure Statement:

This equipment complies with Canada radiation exposure limits set forth for an uncontrolled environment. This equipment should be installed and operated with minimum distance 40cm between the radiator & your body.

Déclaration d'exposition aux radiations:

Cet équipement est conforme Canada limites d'exposition aux radiations dans un environnement non contrôlé. Cet équipement doit être installé et utilisé à distance minimum de 40cm entre le radiateur et votre corps.

5.2.1 Professional installation instruction

Please be advised that due to the unique function supplied by this product, the device is intended for use with our interactive entertainment software and licensed third-party only. The product will be distributed through controlled distribution channel and installed by trained professional and will not be sold directly to the general public through retail store.

1. Installation personal

This product is designed for specific application and needs to be installed by a qualified personal who has RF and related rule knowledge. The general user shall not attempt to install or change the setting.

2. Installation location

The product shall be installed at a location where the radiating antenna can be kept 40cm from nearby person in normal operation condition to meet regulatory RF exposure requirement.

3. External antenna

Use only the antennas which have been approved by Huawei. The non-approved antenna(s) may produce unwanted spurious or excessive RF transmitting power which may lead to the violation of FCC/ IC limit and is prohibited.

4. Installation procedure

Please refer to user's manual for the detail.

5. Warning

Please carefully select the installation position and make sure that the final output power does not exceed the limit set force in relevant rules. The violation of the rule could lead to serious federal penalty.

5.2.2 Instructions d'installation professionnelle

Veillez noter que l'appareil étant dédié à une fonction unique, il doit être utilisé avec notre logiciel propriétaire de divertissement interactif. Ce produit sera proposé par un réseau de distribution contrôlé et installé par des professionnels; il ne sera pas proposé au grand public par le réseau de la grande distribution.

1. Installation

Ce produit est destiné à un usage spécifique et doit être installé par un personnel qualifié maîtrisant les radiofréquences et les règles s'y rapportant. L'installation et les réglages ne doivent pas être modifiés par l'utilisateur final.

2. Emplacement d'installation

En usage normal, afin de respecter les exigences réglementaires concernant l'exposition aux radiofréquences, ce produit doit être installé de façon à respecter une distance de 40 cm entre l'antenne émettrice et les personnes.

3. Antenne externe

Utiliser uniquement les antennes approuvées par le fabricant. L'utilisation d'autres antennes peut conduire à un niveau de rayonnement essentiel ou non essentiel dépassant les niveaux limites définis par FCC, IC, ce qui est interdit.

4. Procédure d'installation

Consulter le manuel d'utilisation.

5. Avertissement

Choisir avec soin la position d'installation et s'assurer que la puissance de sortie ne dépasse pas les limites en vigueur. La violation de cette règle peut conduire à de sérieuses pénalités fédérales.

5.3 Federal Communication Commission Interference Statement

This equipment has been tested and found to comply with the limits for a Class B digital device, pursuant to Part 15 of the FCC Rules. These limits are designed to provide reasonable protection against harmful interference in a residential installation. This equipment generates, uses and can radiate radio frequency energy and, if not installed and used in accordance with the instructions, may cause harmful interference to radio communications. However, there is no guarantee that interference will not occur in a particular installation. If this equipment does cause harmful interference to radio or television reception, which can be determined by turning the equipment off and on, the user is encouraged to try to correct the interference by one of the following measures:

- Reorient or relocate the receiving antenna.
- Increase the separation between the equipment and receiver.
- Connect the equipment into an outlet on a circuit different from that to which the receiver is connected.
- Consult the dealer or an experienced radio/TV technician for help.

FCC Caution: Any changes or modifications not expressly approved by the party responsible for compliance could void the user's authority to operate this equipment.

This device complies with Part 15 of the FCC Rules. Operation is subject to the following two conditions: (1) This device may not cause harmful interference, and (2) this device must accept any interference received, including interference that may cause undesired operation.

IMPORTANT NOTE:

Radiation Exposure Statement:

This equipment complies with FCC radiation exposure limits set forth for an uncontrolled environment. This equipment should be installed and operated with minimum distance 40cm between the radiator & your body.

This transmitter must not be co-located or operating in conjunction with any other antenna or transmitter.

Country Code selection feature to be disabled for products marketed to the US/CANADA.

Operation of B2338-168IDU is restricted to indoor use only.