



中国认可
国际互认
检测
TESTING
CNAS L2264

RF TEST REPORT

Applicant Huawei Technologies Co., Ltd.

FCC ID QIS-AR-SA-U-BC/QIS-AR-SA-LA-BC/
QIS-AR-SA-LA-MC/QIS-AR-SE-MC

Product Access Router

Model AR-Sa-U-BC/AR-Sa-La-BC/
AR-Sa-La-MC/AR-Se-MC

Report No. RHA1705-0051RF01R2

Issue Date June 5, 2017

TA Technology (Shanghai) Co., Ltd. tested the above equipment in accordance with the requirements in **FCC CFR47 Part 15C (2016)**. The test results show that the equipment tested is capable of demonstrating compliance with the requirements as documented in this report.

Performed by: Xianqing Li

Approved by: Kai Xu

TA Technology (Shanghai) Co., Ltd.

No.145, Jintang Rd, Tangzhen Industry Park, Pudong Shanghai, China

TEL: +86-021-50791141/2/3

FAX: +86-021-50791141/2/3-8000



TABLE OF CONTENT

- 1. Test Laboratory 4
 - 1.1. Notes of the test report..... 4
 - 1.2. Test facility 4
 - 1.3. Testing Location..... 5
- 2. General Description of Equipment under Test..... 6
- 3. Applied Standards 8
- 4. Test Configuration 9
- 5. Test Case Results 10
 - 5.1. Average Power Output –Conducted..... 10
 - 5.2. 6dB Bandwidth 12
 - 5.3. Band Edge 14
 - 5.4. Power Spectral Density 16
 - 5.5. Spurious RF Conducted Emissions..... 18
 - 5.6. Radiated Emissions in the Restricted Band 20
 - 5.7. Radiates Emission 23
 - 5.8. Conducted Emission 38
- 6. Main Test Instruments 41
- ANNEX A: EUT Appearance and Test Setup 42
 - A.1 EUT Appearance 42
 - A.2 Test Setup 44



Summary of measurement results

Number	Summary of measurements of results	Clause in FCC rules	Verdict
1	Maximum Average conducted output power	15.247(b)(3)	PASS
2	6 dB bandwidth	15.247(a)(2)	PASS
3	Power spectral density	15.247(e)	PASS
4	Band Edge	15.247(d)	PASS
5	Spurious RF Conducted Emissions	15.247(d)	PASS
6	Radiated Emissions in restricted frequency bands	15.247(d),15.205,15.209	PASS
7	Radiated Emissions	15.247(d),15.205,15.209	PASS
8	Conducted Emissions	15.207	PASS
Date of Testing: May 28, 2017~ June 2, 2017			

1. Test Laboratory

1.1. Notes of the test report

This report shall not be reproduced in full or partial, without the written approval of **TA technology (shanghai) co., Ltd.** The results documented in this report apply only to the tested sample, under the conditions and modes of operation as described herein .Measurement Uncertainties were not taken into account and are published for informational purposes only. This report is written to support regulatory compliance of the applicable standards stated above. This report must not be used by the client to claim product certification, approval, or endorsement by any government agencies.

1.2. Test facility

CNAS (accreditation number: L2264)

TA Technology (Shanghai) Co., Ltd. has obtained the accreditation of China National Accreditation Service for Conformity Assessment (CNAS).

FCC (recognition number is 428261)

TA Technology (Shanghai) Co., Ltd. has been listed on the US Federal Communications Commission list of test facilities recognized to perform electromagnetic emissions measurements.

IC (recognition number is 8510A)

TA Technology (Shanghai) Co., Ltd. has been listed by industry Canada to perform electromagnetic emission measurement.

VCCI (recognition number is C-4595, T-2154, R-4113, G-10766)

TA Technology (Shanghai) Co., Ltd. has been listed by industry Japan to perform electromagnetic emission measurement.

A2LA (Certificate Number: 3857.01)

TA Technology (Shanghai) Co., Ltd. has been listed by American Association for Laboratory Accreditation to perform electromagnetic emission measurement.



1.3. Testing Location

Company: TA Technology (Shanghai) Co., Ltd.
Address: No.145, Jintang Rd, Tangzhen Industry Park, Pudong
City: Shanghai
Post code: 201201
Country: P. R. China
Contact: Xu Kai
Telephone: +86-021-50791141/2/3
Fax: +86-021-50791141/2/3-8000
Website: <http://www.ta-shanghai.com>
E-mail: xukai@ta-shanghai.com

2. General Description of Equipment under Test

Client Information

Applicant	Huawei Technologies Co., Ltd.
Applicant address	Administration Building, Headquarters of Huawei Technologies Co., Ltd., Bantian, Longgang District Shenzhen, P.R.China
Manufacturer	Huawei Technologies Co., Ltd.
Manufacturer address	Administration Building, Headquarters of Huawei Technologies Co., Ltd., Bantian, Longgang District Shenzhen, P.R.China

General information

EUT Description	
Model:	AR-Sa-U-BC/AR-Sa-La-BC/AR-Sa-La-MC/AR-Se-MC
Hardware Version:	Ver A
Software Version:	V200R009C00
Power Supply:	AC adapter
Antenna Type:	Internal Antenna
Antenna Connector:	A permanently attached antenna (meet with the standard FCC Part 15.203 requirement)
Antenna Gain:	3.3 dBi
additional beamforming gain:	0 dB
Test Mode:	Bluetooth(Low Energy)
Modulation Type:	BLE :GFSK
Max. Conducted Power	BLE : -3.45 dBm
Operating Frequency Range(s)	BLE: 2402 ~2480 MHz
Note: The information of the EUT is declared by the manufacturer. Please refer to the specifications or user manual for details.	

Difference Statement

Model	Features										
	Ethernet	DI/DO	USB 2.0	SD Slot	TPM	FXS	RS 232	RS 485	CAN	LTE Module	BLE
AR-Sa-U-BC	YES	YES	YES	YES	TPM1.2	YES	*1	*1	*1	EC-25A	YES
AR-Sa-La-BC	YES	YES	YES	YES	TPM1.2	YES	*1	*1	*1	EC-25A	YES
AR-Sa-La-MC	YES	YES	YES	YES	TPM1.2	YES	*2	NO	*2	EC-25A	YES
AR-Se-MC	YES	YES	YES	YES	TPM1.2	YES	*2	NO	*2	NO	YES

FCC ID: QIS-AR-SA-U-BC/QIS-AR-SA-LA-BC/QIS-AR-SA-LA-MC/QIS-AR-SE-MC

The difference of the four model is digital port and the existence of LTE Module.

The AR-Sa-U-BC and AR-Sa-La-BC have the same hardware with 1*RS232+1*RS485+1*CAN while AR-Sa-La-MC and AR-Se-MC have the port of 2*RS232+2*CAN.

But the AR-Se-MC is the WAN version without LTE module.

This report only refer to the model of AR-Sa-La-BC (FCC ID: QIS-AR-SA-LA-BC).



3. Applied Standards

According to the specifications of the manufacturer, it must comply with the requirements of the following standards:

Test standards

- **FCC CFR47 Part 15C (2016) Radio Frequency Devices**
- **ANSI C63.10 (2013)**
- **KDB 558074 D01 DTS Meas Guidance v04**

4. Test Configuration

Test Mode

The EUT was programmed to be in continuously transmitting mode and the transmit duty cycle is not less than 98%.

The EUT has been associated with peripherals and configuration operated in a manner tended to maximize its emission characteristics in a typical application.

The radiated emission was measured in the following position: EUT stand-up position (Z axis), lie-down position (X, Y axis). The worst emission was found in stand-up position (Z axis) and the worst case was recorded.

In order to find the worst case condition, Pre-tests are needed at the presence of different data rate. Preliminary tests have been done on all the configuration for confirming worst case. Data rate below means worst-case rate of each test item.

Worst-case data rates are shown as following table.

Band	Data Rate
Bluetooth(Low Energy)	1Mbps

5. Test Case Results

5.1. Average Power Output –Conducted

Ambient condition

Temperature	Relative humidity	Pressure
23°C ~25°C	45%~50%	101.5kPa

Methods of Measurement

During the process of the testing, The EUT was connected to Spectrum Analyzer with a known loss. The EUT is max power transmission with proper modulation. The Average detector is used. We use Maximum Average Conducted Output Power Level Method in KDB 558074 D01 for this test.

Test Setup

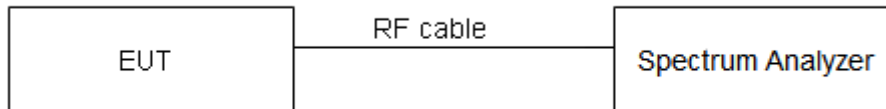

Limits

Rule Part 15.247 (b) (3) specifies that " For systems using digital modulation in the 902–928 MHz, 2400–2483.5 MHz: 1 Watt."

Average Output Power	$\leq 1W$ (30dBm)
----------------------	-------------------

Measurement Uncertainty

The assessed measurement uncertainty to ensure 95% confidence level for the normal distribution is with the coverage factor $k = 2$, $U = 0.44$ dB.

Test Results

Network Standards	Carrier frequency (MHz)	Average Output Power (dBm)	Limit (dBm)	Conclusion
Bluetooth (Low Energy)	2402	-3.45	30	PASS
	2440	-3.91	30	PASS
	2480	-4.35	30	PASS

BLE Carrier frequency (MHz): 2402

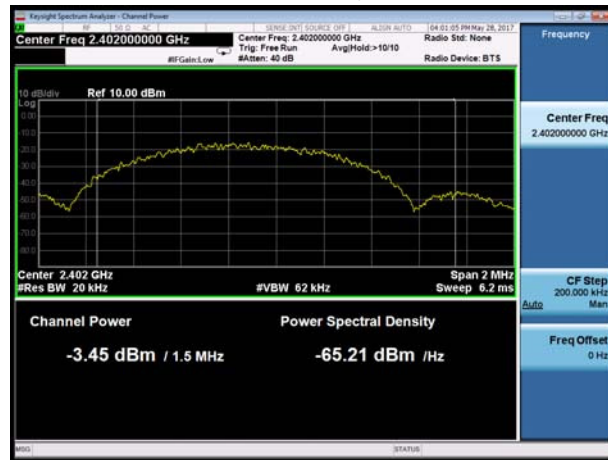

BLE Carrier frequency (MHz): 2440



BLE Carrier frequency (MHz): 2480

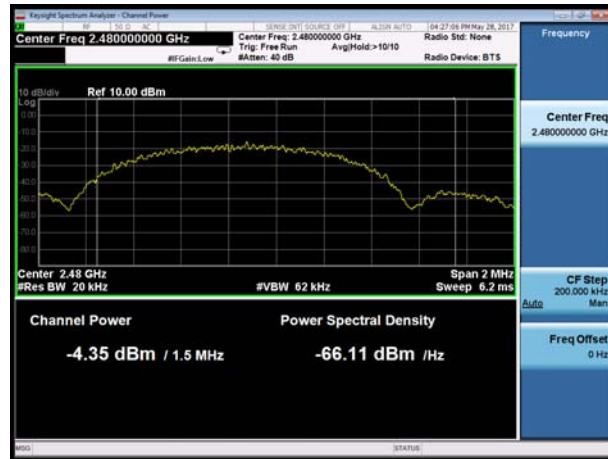

5.2. 6dB Bandwidth

Ambient condition

Temperature	Relative humidity	Pressure
23°C ~25°C	45%~50%	101.5kPa

Method of Measurement

The EUT was connected to the spectrum analyzer through an external attenuator (20dB) and a known loss cable. RBW is set to 100 kHz; VBW is set to 300 kHz on spectrum analyzer.

Test Setup

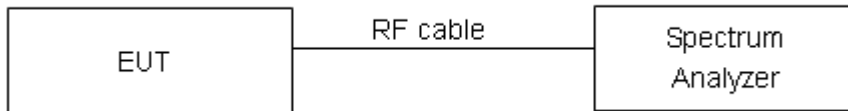

Limits

Rule Part 15.247 (a) (2) specifies that “Systems using digital modulation techniques may operate in the 902–928 MHz, 2400–2483.5 MHz bands. The minimum 6 dB bandwidth shall be at least 500 kHz.”

minimum 6 dB bandwidth	≥ 500 kHz
------------------------	-----------

Measurement Uncertainty

The assessed measurement uncertainty to ensure 95% confidence level for the normal distribution is with the coverage factor $k = 2$, $U = 936$ Hz.



Test Results:

Network Standards	Carrier frequency (MHz)	99% bandwidth (MHz)	Minimum 6 dB bandwidth (MHz)	Limit (kHz)	Conclusion
Bluetooth (Low Energy)	2402	1.0709	701.4	500	PASS
	2440	1.0741	717.6	500	PASS
	2480	1.0782	735.1	500	PASS

BLE Carrier frequency (MHz): 2402



BLE Carrier frequency (MHz): 2440



BLE Carrier frequency (MHz): 2480



5.3. Band Edge

Ambient condition

Temperature	Relative humidity	Pressure
23°C ~25°C	45%~50%	101.5kPa

Method of Measurement

The EUT was connected to the spectrum analyzer through an external attenuator (20dB) and a known loss cable the band edge of the lowest and highest channels were measured. The peak detector is used and RBW is set to 100 kHz and VBW is set to 300 kHz on spectrum analyzer. Spectrum analyzer plots are included on the following pages.

Test Setup

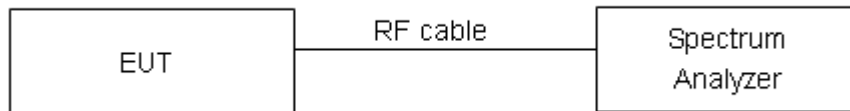

Limits

Rule Part 15.247(d) specifies that “In any 100 kHz bandwidth outside the frequency band in which the spread spectrum or digitally modulated intentional radiator is operating, the radio frequency power that is produced by the intentional radiator shall be at least 20 dB below that in the 100 kHz bandwidth within the band that contains the highest level of the desired power, based on either an RF conducted or a radiated measurement, provided the transmitter demonstrates compliance with the peak conducted power limits. If the transmitter complies with the conducted power limits based on the use of RMS averaging over a time interval, as permitted under paragraph (b)(3) of this section, the attenuation required under this paragraph shall be 30 dB instead of 20 dB.”

Measurement Uncertainty

The assessed measurement uncertainty to ensure 95% confidence level for the normal distribution is with the coverage factor $k = 1.96$.

Frequency	Uncertainty
2GHz-3GHz	1.407 dB



Test Results: PASS

BLE, Channel No.: 0

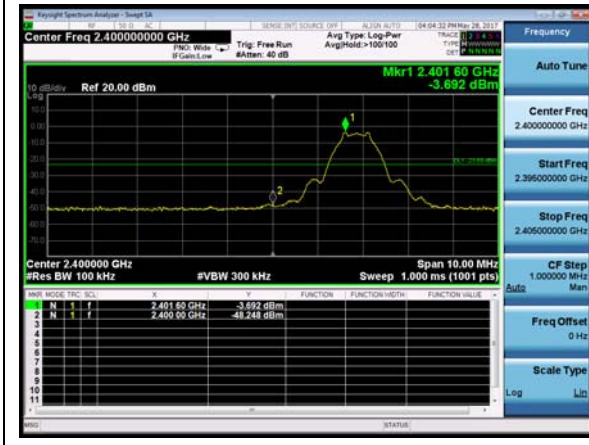

BLE, Channel No.: 39

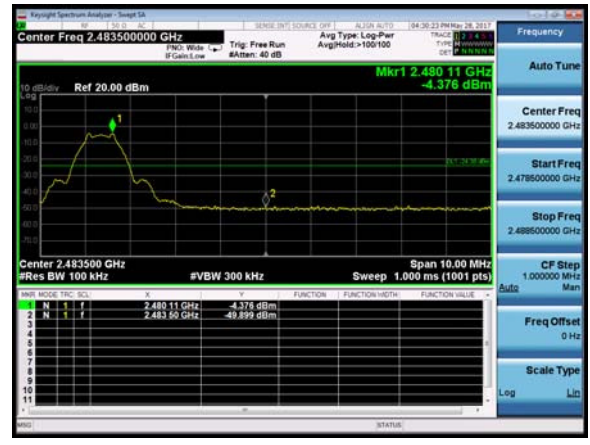

5.4. Power Spectral Density

Ambient condition

Temperature	Relative humidity	Pressure
23°C ~25°C	45%~50%	101.5kPa

Method of Measurement

The EUT was connected to the spectrum analyzer through an external attenuator (20dB) and a known loss cable.

RBW is set to 3 kHz and VBW is set to 10 kHz for BLE/ Wi-Fi 2.4G on spectrum analyzer.

Set the span to 1.5 times the DTS channel bandwidth. Sweep time = auto couple. Trace mode = max hold. The Average power spectral density is recorded.

Test setup

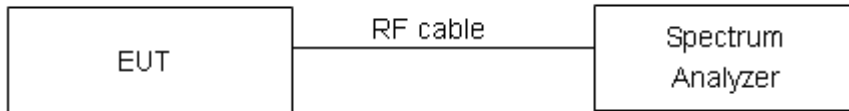

Limits

Rule Part 15.247(e) specifies that” For digitally modulated systems, the power spectral density conducted from the intentional radiator to the antenna shall not be greater than 8 dBm in any 3 kHz band during any time interval of continuous transmission. ”

Limits	≤ 8 dBm / 3kHz
--------	----------------

Measurement Uncertainty

The assessed measurement uncertainty to ensure 95% confidence level for the normal distribution is with the coverage factor $k = 2$, $U = 0.75\text{dB}$.



Test Results:

Network Standards	Channel Number	Power Spectral Density (dBm / 3kHz)	Limit (dBm / 3kHz)	Conclusion
Bluetooth (Low Energy)	0	-25.533	8	PASS
	19	-25.788	8	PASS
	39	-26.293	8	PASS

BLE, Channel No.: 0



BLE, Channel No.: 19



BLE, Channel No.: 39



5.5. Spurious RF Conducted Emissions

Ambient condition

Temperature	Relative humidity	Pressure
23°C ~25°C	45%~50%	101.5kPa

Method of Measurement

The EUT was connected to the spectrum analyzer with a known loss. The spectrum analyzer scans from 30MHz to the 10th harmonic of the carrier. The peak detector is used. RBW and VBW are set to 100 kHz, Sweep is set to ATUO.

The test is in transmitting mode.

Test setup



Limits

Rule Part 15.247(d) pacifies that “In any 100 kHz bandwidth outside the frequency band in which the spread spectrum or digitally modulated intentional radiator is operating, the radio frequency power that is produced by the intentional radiator shall be at least 20 dB below that in the 100 kHz bandwidth within the band that contains the highest level of the desired power, based on either an RF conducted or a radiated measurement, provided the transmitter demonstrates compliance with the peak conducted power limits. If the transmitter complies with the conducted power limits based on the use of RMS averaging over a time interval, as permitted under paragraph (b)(3) of this section, the attenuation required under this paragraph shall be 30 dB instead of 20 dB.”

Network Standards	Carrier frequency (MHz)	Reference value (dBm)	Limit
Bluetooth (Low Energy)	2402	-8.437	-28.437
	2440	-22.498	-42.498
	2480	-16.487	-36.487

Measurement Uncertainty

The assessed measurement uncertainty to ensure 95% confidence level for the normal distribution is with the coverage factor $k = 1.96$.

Frequency	Uncertainty
100kHz-2GHz	0.684 dB
2GHz-26GHz	1.407 dB



Test Results:

If disturbances were found more than 20dB below limit line, the mark is not required for the EUT.
The signal beyond the limit is carrier.

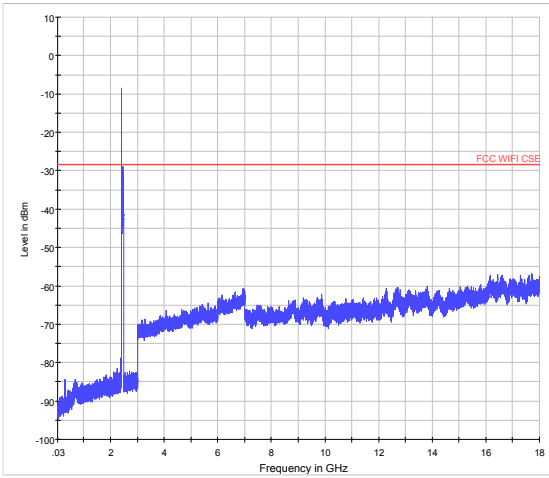

BLE CH0 30MHz to 18GHz

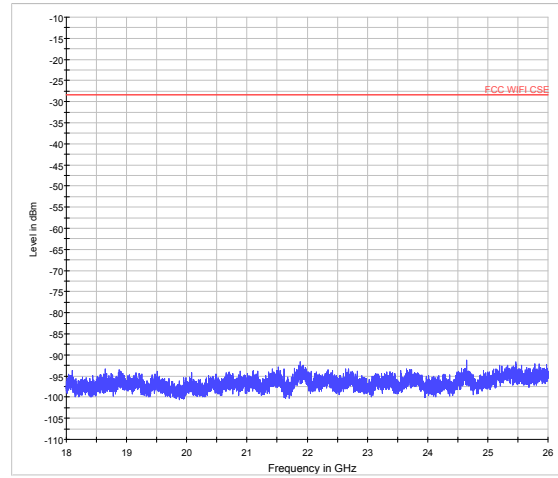

BLE CH0 18GHz to 26.5GHz

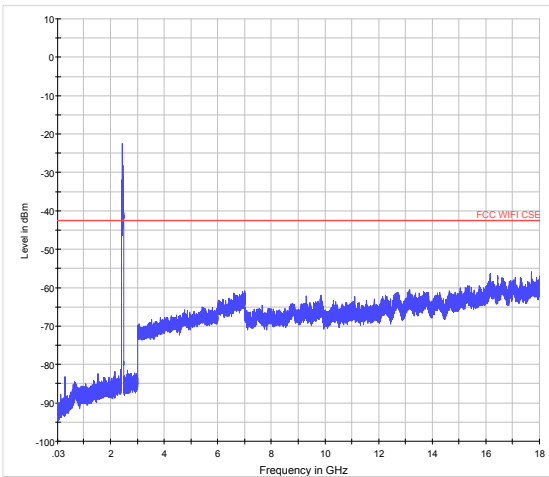

BLE CH19 30MHz to 18GHz

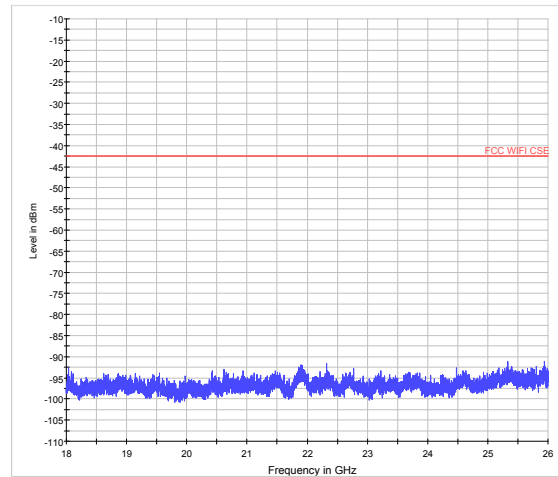

BLE CH19 18GHz to 26.5GHz

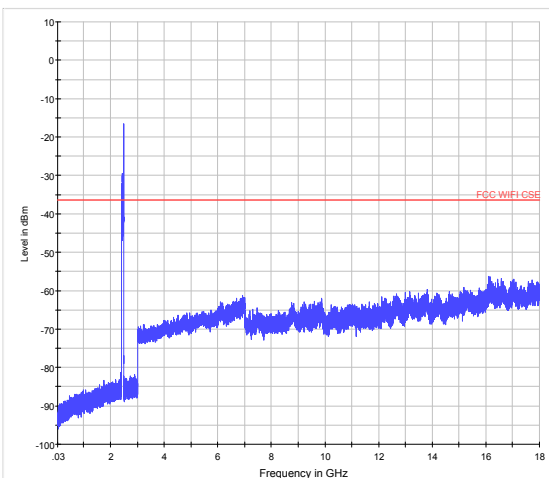

BLE CH39 30MHz to 18GHz

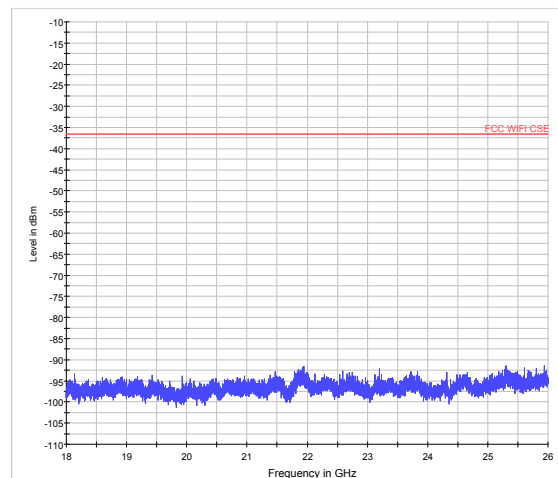

BLE CH39 3GHz to 18GHz

5.6. Radiated Emissions in the Restricted Band

Ambient condition

Temperature	Relative humidity	Pressure
23°C ~25°C	45%~50%	101.5kPa

Method of Measurement

The Equipment Under Test (EUT) was set up on a non-conductive table in the semi-anechoic chamber. The test was performed at the distance of 3 m between the EUT and the receiving antenna. The turntable shall be rotated from 0 to 360 degrees for detecting the maximum of radiated spurious signal level. The measurements shall be repeated with orthogonal polarization of the test antenna. The data of cable loss and antenna factor has been calibrated in full testing frequency range before the testing. Sweep the whole frequency band through the range from 9kHz to the 10th harmonic of the carrier, and the emissions less than 20 dB below the permissible value are reported.

Set the spectrum analyzer in the following:

- (a) PEAK: RBW=1MHz / VBW=3MHz / Sweep=AUTO
- (b) AVERAGE: RBW=1MHz / VBW=3MHz / Sweep=AUTO

This setting method can refer to **KDB 558074**.

The field strength of spurious emission was measured in the following position: EUT stand-up position (Z axis), lie-down position (X, Y axis). The worst emission was found in stand-up position (Y axis) and the antenna is vertical.

The test is in transmitting mode.

Test setup

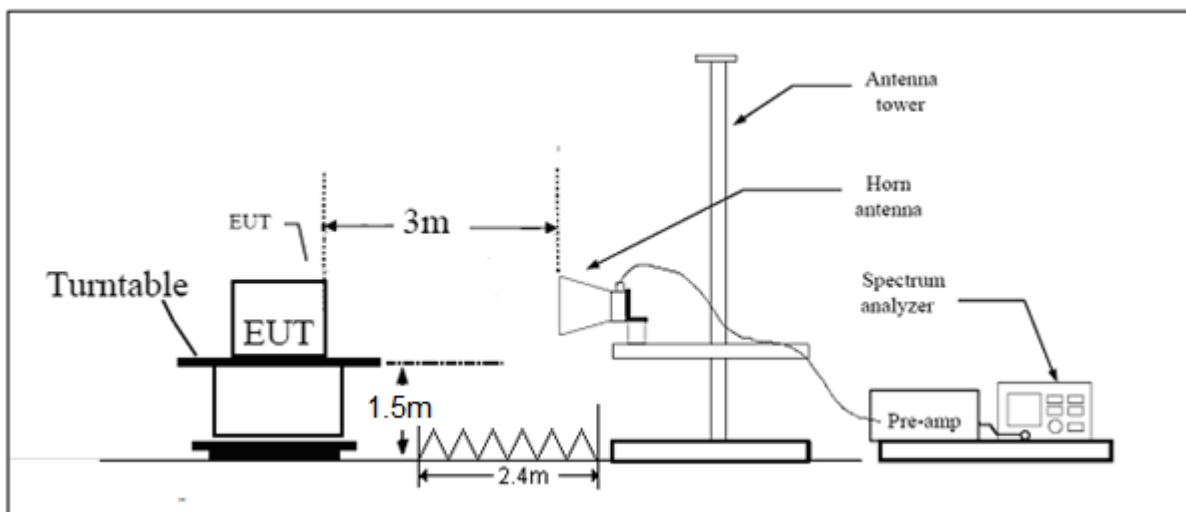

Note: Area side: 2.4mX3.6m

Limits

Spurious Radiated Emissions are permitted in any of the frequency bands listed below:

MHz	MHz	MHz	GHz
0.090 - 0.110	16.42 - 16.423	399.9 - 410	4.5 - 5.15
¹ 0.495 - 0.505	16.69475 - 16.69525	608 - 614	5.35 - 5.46
2.1735 - 2.1905	16.80425 - 16.80475	960 - 1240	7.25 - 7.75
4.125 - 4.128	25.5 - 25.67	1300 - 1427	8.025 - 8.5
4.17725 - 4.17775	37.5 - 38.25	1435 - 1626.5	9.0 - 9.2
4.20725 - 4.20775	73 - 74.6	1645.5 - 1646.5	9.3 - 9.5
6.215 - 6.218	74.8 - 75.2	1660 - 1710	10.6 - 12.7
6.26775 - 6.26825	108 - 121.94	1718.8 - 1722.2	13.25 - 13.4
6.31175 - 6.31225	123 - 138	2200 - 2300	14.47 - 14.5
8.291 - 8.294	149.9 - 150.05	2310 - 2390	15.35 - 16.2
8.362 - 8.366	156.52475 - 156.52525	2483.5 - 2500	17.7 - 21.4
8.37625 - 8.38675	156.7 - 156.9	2690 - 2900	22.01 - 23.12
8.41425 - 8.41475	162.0125 - 167.17	3260 - 3267	23.6 - 24.0
12.29 - 12.293	167.72 - 173.2	3332 - 3339	31.2 - 31.8
12.51975 - 12.52025	240 - 285	3345.8 - 3358	36.43 - 36.5
12.57675 - 12.57725	322 - 335.4	3600 - 4400	(²)
13.36 - 13.41			

Limit in restricted band

Frequency of emission (MHz)	Field strength(uV/m)	Field strength(dBuV/m)
30-88	100	40
88-216	150	43.5
216-960	200	46
Above960	500	54

§15.35(b)

There is also a limit on the radio frequency emissions, as measured using instrumentation with a peak detector function, corresponding to 20 dB above the maximum permitted average limit.

Peak Limit=74 dBuV/m

Average Limit=54 dBuV/m

Measurement Uncertainty

The assessed measurement uncertainty to ensure 95% confidence level for the normal distribution is with the coverage factor $k = 1.96$, $U = 3.55$ dB.



Test Results:

PASS

The signal beyond the limit is carrier.

BLE -Channel 0: Peak

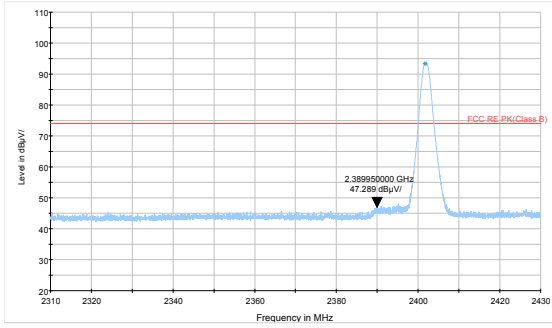

BLE -Channel 39: Peak

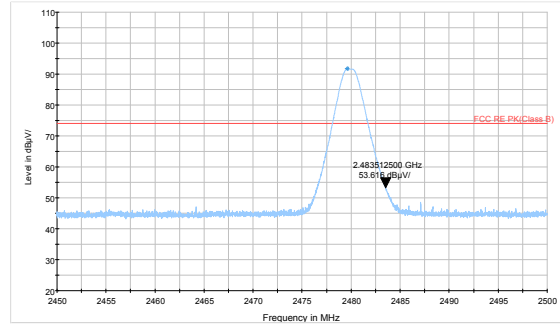

BLE -Channel 0: Average

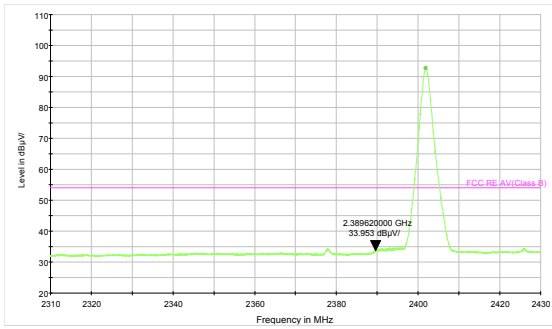

BLE -Channel 39: Average

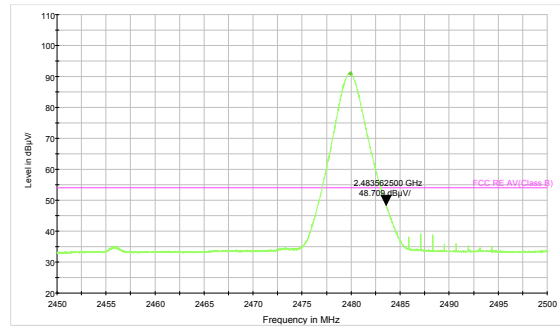

5.7. Radiates Emission

Ambient condition

Temperature	Relative humidity	Pressure
23°C ~25°C	45%~50%	102.5kPa

Method of Measurement

The test set-up was made in accordance to the general provisions of ANSI C63.10-2013. The Equipment Under Test (EUT) was set up on a non-conductive table in the semi-anechoic chamber. The test was performed at the distance of 3 m between the EUT and the receiving antenna. The radiated emissions measurements were made in a typical installation configuration.

Sweep the whole frequency band through the range from 9 kHz to the 10th harmonic of the carrier, and the emissions less than 20 dB below the permissible value are reported.

During the test, below 30MHz, the center of the loop shall be 1 meters; above 30MHz, the height of receive antenna shall be moved from 1 to 4 meters, and the antenna shall be performed under horizontal and vertical polarization. The turntable shall be rotated from 0 to 360 degrees for detecting the maximum of radiated spurious signal level. The measurements shall be repeated with orthogonal polarization of the test antenna. The data of cable loss and antenna factor has been calibrated in full testing frequency range before the testing.

Set the spectrum analyzer in the following:

Below 1GHz (detector: Peak and Quasi-Peak)

RBW=100 kHz / VBW=300 kHz / Sweep=AUTO

Above 1GHz (detector: Peak):

(a) PEAK: RBW=1MHz VBW=3MHz/ Sweep=AUTO

(b) AVERAGE: RBW=1MHz / VBW=3MHz / Sweep=AUTO

The radiated emission was measured in the following position: EUT stand-up position (Z axis), lie-down position (X, Y axis). The worst emission was found in stand-up position (Z axis) and the worst case was recorded.

The test is in transmitting mode.

Test setup

9KHz ~ 30MHz

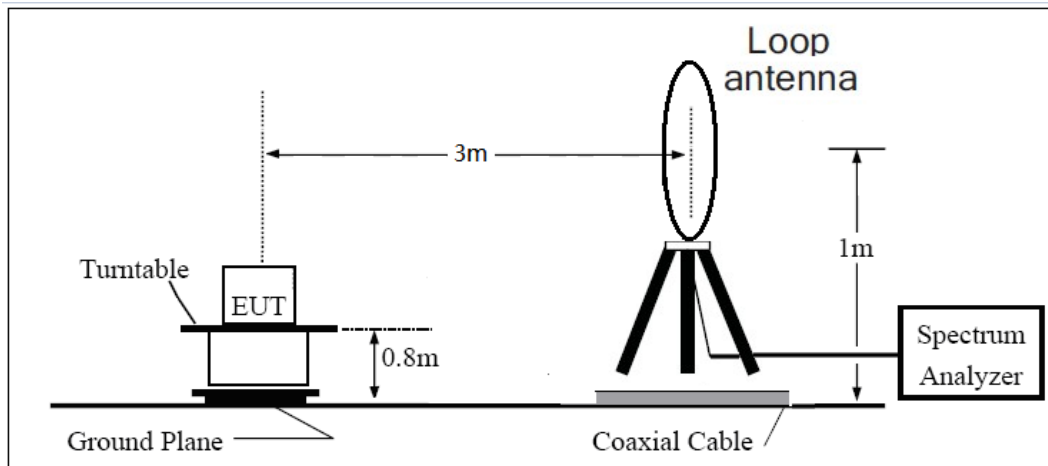

30MHz ~ 1GHz

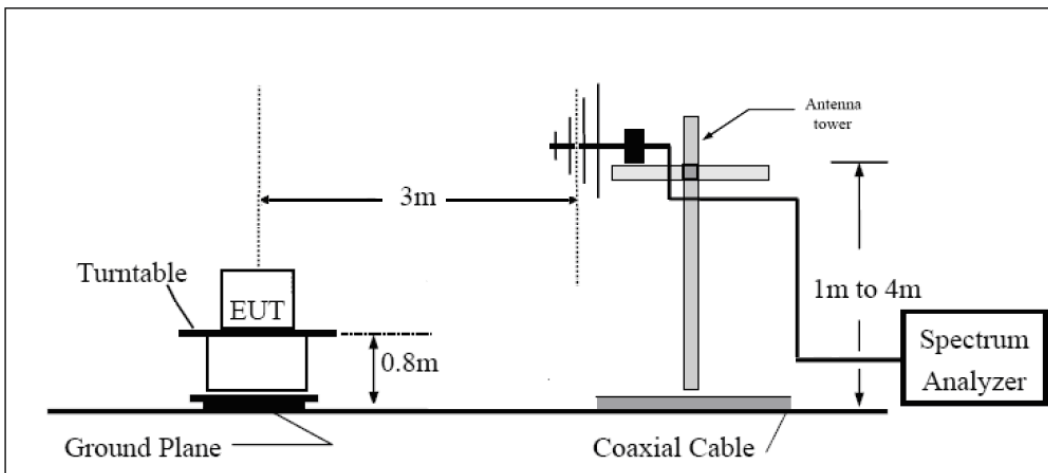

Above 1GHz

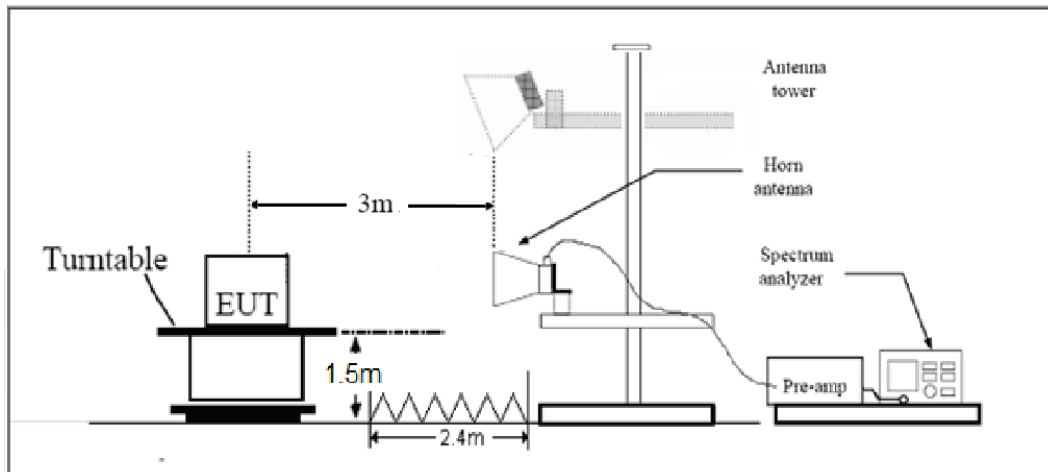

Note: Area side:2.4mX3.6m

Limits

Rule Part 15.247(d) specifies that “In addition, radiated emissions which fall in the restricted bands, as defined in § 15.205(a), must also comply with the radiated emission limits specified in § 15.209(a) (see § 15.205(c)).”

Limit in restricted band

Frequency of emission (MHz)	Field strength(uV/m)	Field strength(dBuV/m)
0.009–0.490	2400/F(kHz)	/
0.490–1.705	24000/F(kHz)	/
1.705–30.0	30	/
30-88	100	40
88-216	150	43.5
216-960	200	46
Above960	500	54

§15.35(b)

There is also a limit on the radio frequency emissions, as measured using instrumentation with a peak detector function, corresponding to 20 dB above the maximum permitted average limit.

Measurement Uncertainty

The assessed measurement uncertainty to ensure 95% confidence level for the normal distribution is with the coverage factor $k = 1.96$.

Frequency	Uncertainty
9KHz-30MHz	3.55 dB
30MHz-200MHz	4.19 dB
200MHz-1GHz	3.63 dB
Above 1GHz	3.68 dB



Test result

Sweep from 9 kHz to 30MHz, and the emissions more than 20 dB below the permissible value are not reported.

The following graphs display the maximum values of horizontal and vertical by software.

For above 1GHz, Blue trace uses the peak detection, Green trace uses the average detection.

BLE-Channel 0

FCC RE 0.03-1GHz QP Class B

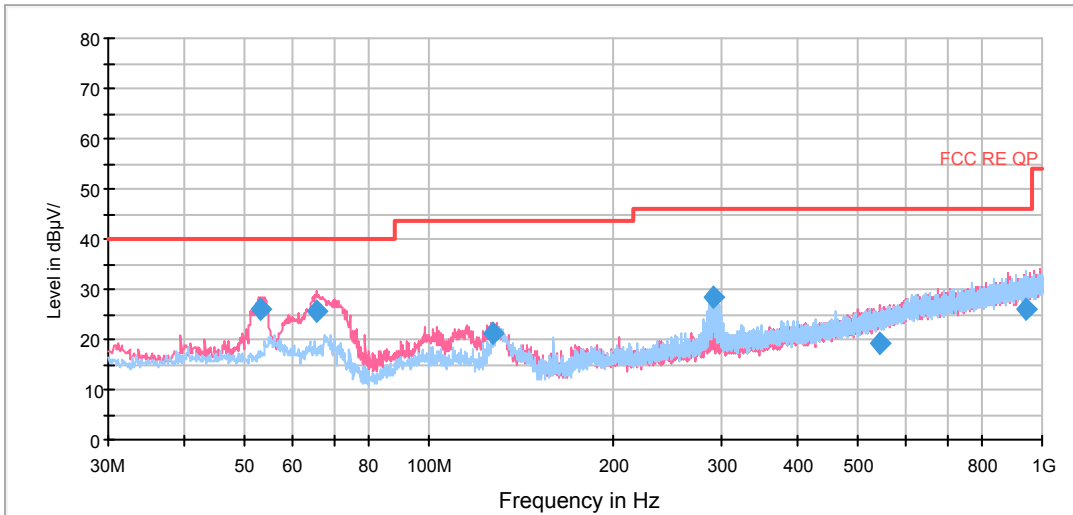

Radiates Emission from 30MHz to 1GHz

Frequency (MHz)	Quasi-Peak (dBuV/m)	Height (cm)	Polarization	Azimuth (deg)	Reading value (dBuV/m)	Correct Factor (dB)	Margin (dB)	Limit (dBuV/m)
53.278750	25.8	100.0	V	237.0	38.6	-12.8	14.2	40.0
65.687500	25.4	100.0	V	89.0	35.7	-10.3	14.6	40.0
126.993750	21.2	100.0	V	353.0	31.1	-9.9	22.3	43.5
292.102500	28.3	114.0	H	288.0	43.5	-15.2	17.7	46.0
543.045000	19.2	100.0	V	0.0	40.1	-20.9	26.8	46.0
939.980000	25.9	100.0	H	22.0	53.0	-27.1	20.1	46.0

Remark: 1. Quasi-Peak = Reading value + Correction factor

2. Correction Factor = Antenna factor+ Insertion loss(cable loss+amplifier gain)

3. Margin = Limit – Quasi-Peak

RE 1G-3GHz PK+AV

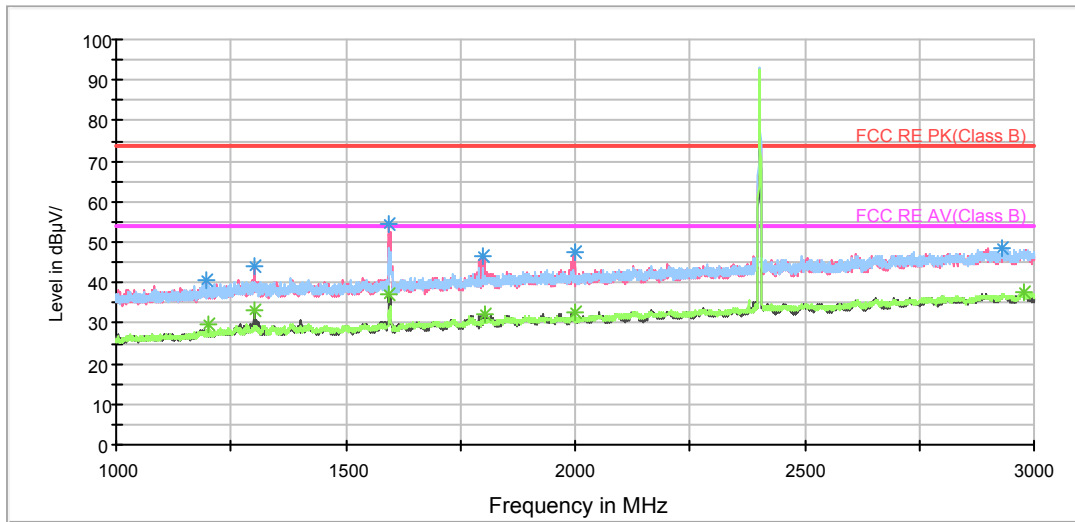

Note: The signal beyond the limit is carrier.

Radiates Emission from 1GHz to 3GHz

Frequency (MHz)	Peak (dBuV/m)	Height (cm)	Polarization	Azimuth (deg)	Reading value (dBuV/m)	Correct Factor (dB)	Margin (dB)	Limit (dBuV/m)
1195.500000	40.4	160.0	V	0.0	48.6	-8.2	33.6	74
1300.750000	43.9	160.0	V	71.0	51.8	-7.9	30.1	74
1594.500000	54.5	160.0	V	283.0	60.9	-6.4	19.5	74
1797.500000	46.7	160.0	V	313.0	50.8	-4.1	27.3	74
1998.000000	47.6	160.0	V	36.0	51.0	-3.4	26.4	74
2931.750000	48.7	160.0	H	184.0	46.9	1.8	25.3	74

Remark: 1. Correction Factor = Antenna factor+ Insertion loss (cable loss + amplifier gain)

Frequency (MHz)	Average (dBuV/m)	Height (cm)	Polarization	Azimuth (deg)	Reading value (dBuV/m)	Correct Factor (dB)	Margin (dB)	Limit (dBuV/m)
1200.000000	29.7	160.0	V	25.0	37.9	-8.2	24.3	54
1299.500000	33.0	160.0	V	71.0	40.9	-7.9	21.0	54
1594.500000	37.0	160.0	V	283.0	43.4	-6.4	17.0	54
1804.500000	32.0	160.0	V	54.0	36.0	-4.0	22.0	54
1998.000000	32.6	160.0	V	36.0	36.0	-3.4	21.4	54
2977.500000	37.5	160.0	V	261.0	35.3	2.2	16.5	54

Remark: 1. Correction Factor = Antenna factor+ Insertion loss (cable loss + amplifier gain)



RE 3-18GHz PK+AV

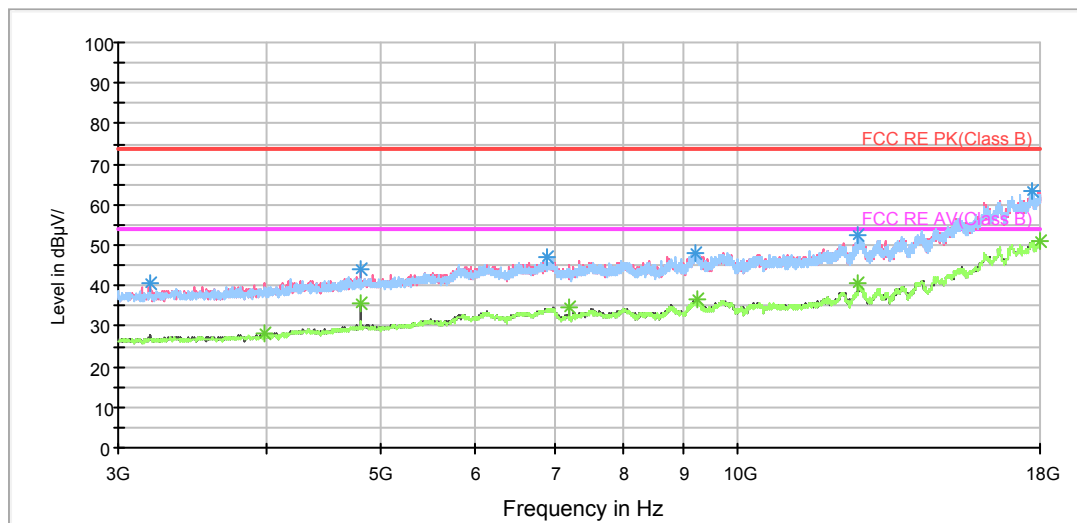

Radiates Emission from 3GHz to 18GHz

Frequency (MHz)	Peak (dBuV/m)	Height (cm)	Polarization	Azimuth (deg)	Reading value (dBuV/m)	Correct Factor (dB)	Margin (dB)	Limit (dBuV/m)
3195.000000	40.7	160.0	V	255.0	43.6	-2.9	33.3	74
4803.750000	44.0	160.0	V	345.0	42.7	1.3	30.0	74
6909.375000	47.1	160.0	H	18.0	40.9	6.2	26.9	74
9225.000000	48.1	160.0	H	40.0	38.2	9.9	25.9	74
12641.250000	52.4	160.0	H	131.0	37.9	14.5	21.6	74
17731.875000	63.1	160.0	V	117.0	38.8	24.3	10.9	74

Remark: 1. Correction Factor = Antenna factor+ Insertion loss (cable loss + amplifier gain)

Frequency (MHz)	Average (dBuV/m)	Height (cm)	Polarization	Azimuth (deg)	Reading value (dBuV/m)	Correct Factor (dB)	Margin (dB)	Limit (dBuV/m)
3984.375000	28.1	160.0	V	301.0	29.1	-1.0	25.9	54
4803.750000	35.5	160.0	V	345.0	34.2	1.3	18.5	54
7205.625000	34.8	160.0	V	345.0	28.4	6.4	19.2	54
9232.500000	36.5	160.0	V	301.0	26.6	9.9	17.5	54
12639.375000	40.5	160.0	V	163.0	26.0	14.5	13.5	54
18000.000000	51.2	160.0	V	0.0	25.7	25.5	2.8	54

Remark: 1. Correction Factor = Antenna factor+ Insertion loss (cable loss + amplifier gain)

BELL_RE 18-26.5GHz PK+AV

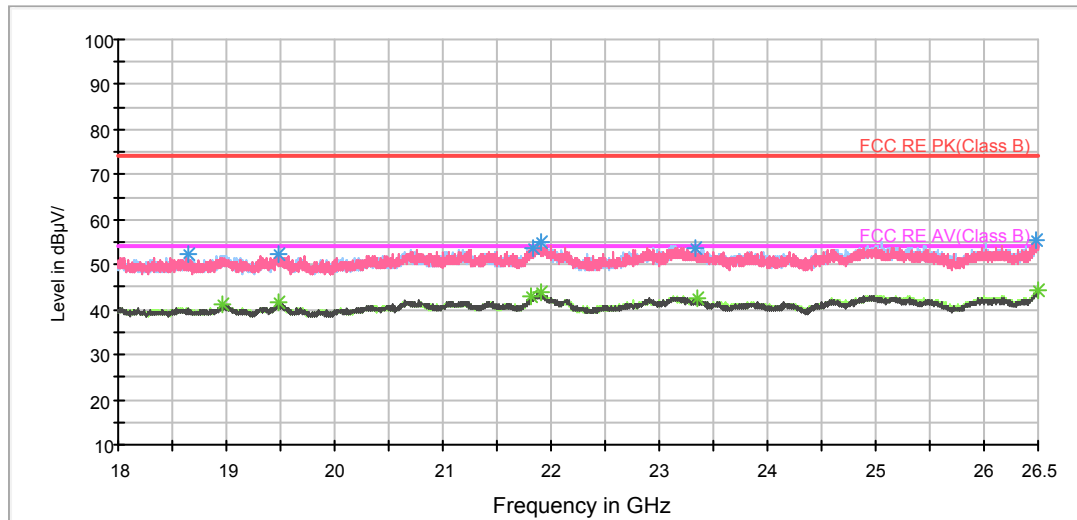

Radiates Emission from 18GHz to 26.5GHz

Frequency (MHz)	Peak (dBuV/m)	Polarization	Azimuth (deg)	Reading value (dBuV/m)	Correct Factor (dB)	Margin (dB)	Limit (dBuV/m)
18652.375000	52.5	H	157.0	52.4	0.1	21.5	74
19483.250000	52.3	H	249.0	52.2	0.1	21.7	74
21833.500000	53.5	V	14.0	55.4	-1.9	20.5	74
21900.437500	55.1	V	116.0	56.7	-1.6	18.9	74
23324.187500	53.7	H	240.0	53.7	0.0	20.3	74
26486.187500	55.3	H	232.0	54.2	1.1	18.7	74

Remark: 1. Correction Factor = Antenna factor+ Insertion loss (cable loss + amplifier gain)

Frequency (MHz)	Average (dBuV/m)	Polarization	Azimuth (deg)	Reading value (dBuV/m)	Correct Factor (dB)	Margin (dB)	Limit (dBuV/m)
18971.125000	41.1	H	300.0	41.2	-0.1	12.9	54
19482.187500	41.4	V	175.0	41.3	0.1	12.6	54
21819.687500	42.9	H	0.0	44.9	-2.0	11.1	54
21910.000000	43.7	H	0.0	45.2	-1.5	10.3	54
23345.437500	42.4	H	208.0	42.4	0.0	11.6	54
26494.687500	44.3	H	157.0	43.2	1.1	9.7	54

Remark: 1. Correction Factor = Antenna factor+ Insertion loss (cable loss + amplifier gain)

BLE-Channel 19

FCC RE 0.03-1GHz QP Class B

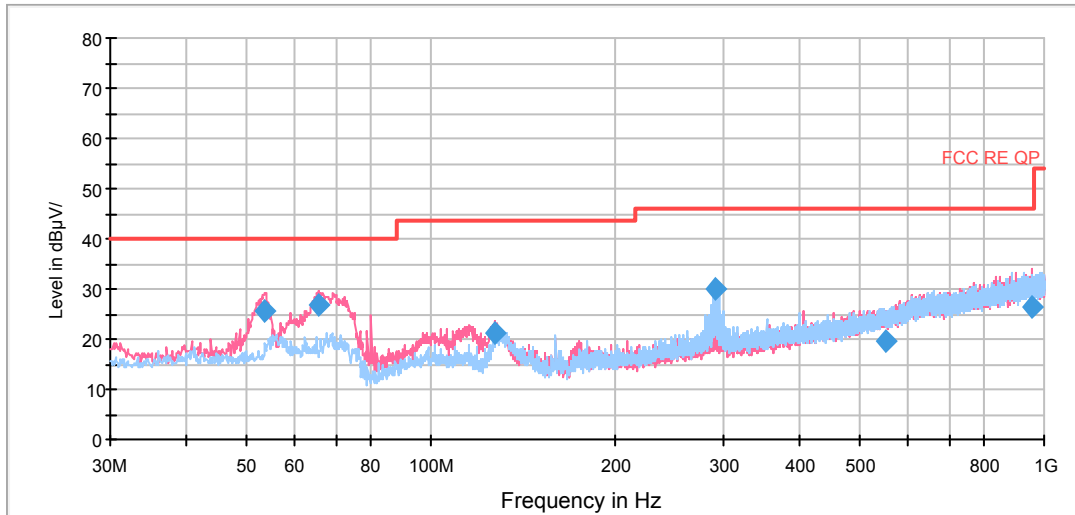

Radiates Emission from 30MHz to 1GHz

Frequency (MHz)	Quasi-Peak (dBuV/m)	Height (cm)	Polarization	Azimuth (deg)	Reading value (dBuV/m)	Correct Factor (dB)	Margin (dB)	Limit (dBuV/m)
53.443750	25.8	100.0	V	237.0	38.6	-12.8	14.2	40.0
65.687500	26.8	100.0	V	278.0	37.1	-10.3	13.2	40.0
127.000000	21.0	125.0	V	356.0	30.9	-9.9	22.5	43.5
291.172500	29.9	100.0	H	290.0	45.1	-15.2	16.1	46.0
549.996250	19.5	100.0	V	105.0	41.1	-21.6	26.5	46.0
955.505000	26.2	114.0	V	171.0	53.5	-27.3	19.8	46.0

- Remark:**
1. Quasi-Peak = Reading value + Correction factor
 2. Correction Factor = Antenna factor+ Insertion loss(cable loss+amplifier gain)
 3. Margin = Limit – Quasi-Peak

RE 1G-3GHz PK+AV

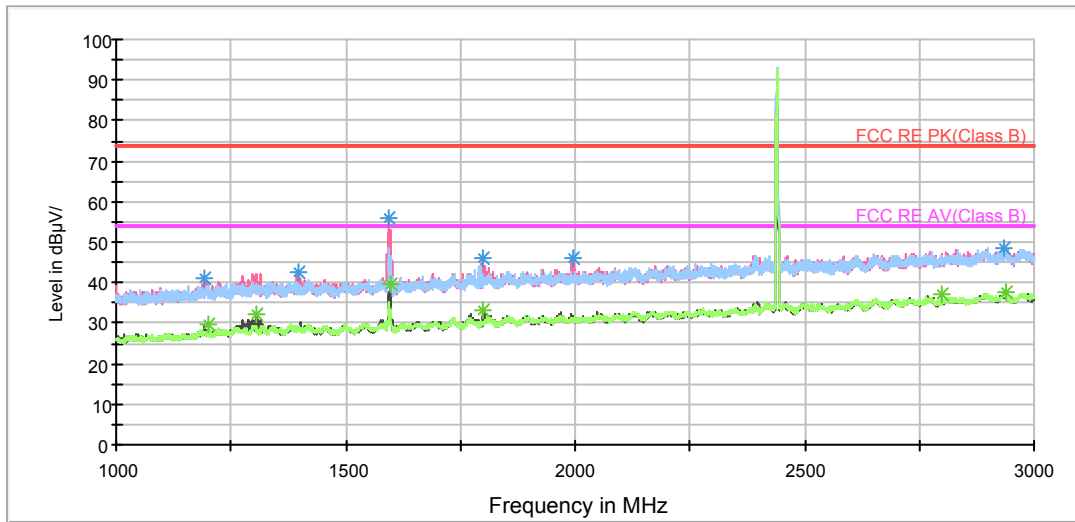

Note: The signal beyond the limit is carrier.

Radiates Emission from 1GHz to 3GHz

Frequency (MHz)	Peak (dBuV/m)	Height (cm)	Polarization	Azimuth (deg)	Reading value (dBuV/m)	Correct Factor (dB)	Margin (dB)	Limit (dBuV/m)
1193.750000	41.1	160.0	V	252.0	49.3	-8.2	32.9	74
1396.750000	42.4	160.0	V	0.0	49.5	-7.1	31.6	74
1594.000000	56.0	160.0	V	282.0	62.4	-6.4	18.0	74
1800.500000	46.1	160.0	V	318.0	50.0	-3.9	27.9	74
1996.500000	46.2	160.0	V	259.0	49.5	-3.3	27.8	74
2935.500000	48.5	160.0	H	110.0	46.7	1.8	25.5	74

Remark: 1. Correction Factor = Antenna factor+ Insertion loss (cable loss + amplifier gain)

Frequency (MHz)	Average (dBuV/m)	Height (cm)	Polarization	Azimuth (deg)	Reading value (dBuV/m)	Correct Factor (dB)	Margin (dB)	Limit (dBuV/m)
1200.000000	29.8	160.0	H	0.0	38.0	-8.2	24.2	54
1304.750000	32.3	160.0	V	69.0	40.1	-7.8	21.7	54
1597.250000	39.6	160.0	V	324.0	46.0	-6.4	14.4	54
1800.250000	33.2	160.0	V	318.0	37.1	-3.9	20.8	54
2800.000000	37.0	160.0	V	0.0	35.9	1.1	17.0	54
2937.250000	37.5	160.0	V	346.0	35.6	1.9	16.5	54

Remark: 1. Correction Factor = Antenna factor+ Insertion loss (cable loss + amplifier gain)

RE 3-18GHz PK+AV

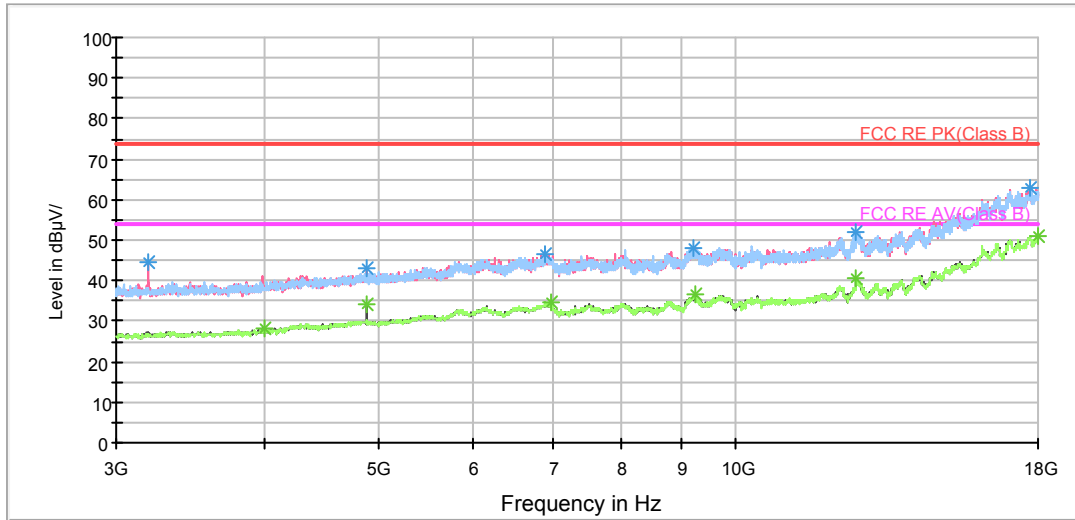

Radiates Emission from 3GHz to 18GHz

Frequency (MHz)	Peak (dBuV/m)	Height (cm)	Polarization	Azimuth (deg)	Reading value (dBuV/m)	Correct Factor (dB)	Margin (dB)	Limit (dBuV/m)
3193.125000	44.5	160.0	V	276.0	47.4	-2.9	29.5	74
4878.750000	43.3	160.0	V	347.0	41.5	1.8	30.7	74
6907.500000	46.3	160.0	V	0.0	40.1	6.2	27.7	74
9210.000000	48.0	160.0	V	299.0	37.9	10.1	26.0	74
12641.250000	52.0	160.0	H	0.0	37.5	14.5	22.0	74
17709.375000	62.9	160.0	H	293.0	38.2	24.7	11.1	74

Remark: 1. Correction Factor = Antenna factor+ Insertion loss (cable loss + amplifier gain)

Frequency (MHz)	Average (dBuV/m)	Height (cm)	Polarization	Azimuth (deg)	Reading value (dBuV/m)	Correct Factor (dB)	Margin (dB)	Limit (dBuV/m)
3997.500000	28.1	160.0	V	299.0	29.2	-1.1	25.9	54
4878.750000	34.0	160.0	V	347.0	32.2	1.8	20.0	54
6997.500000	34.6	160.0	V	276.0	28.1	6.5	19.4	54
9236.250000	36.4	160.0	V	347.0	26.5	9.9	17.6	54
12641.250000	40.7	160.0	V	208.0	26.2	14.5	13.3	54
18000.000000	51.2	160.0	H	223.0	25.7	25.5	2.8	54

Remark: 1. Correction Factor = Antenna factor+ Insertion loss (cable loss + amplifier gain)

BELL_RE 18-26.5GHz PK+AV

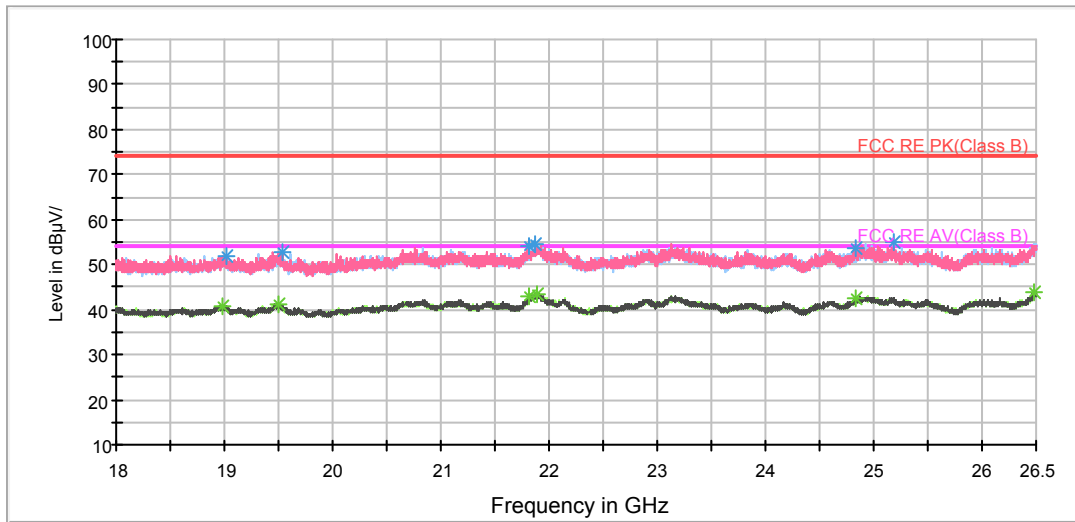

Radiates Emission from 18GHz to 26.5GHz

Frequency (MHz)	Peak (dBuV/m)	Polarization	Azimuth (deg)	Reading value (dBuV/m)	Correct Factor (dB)	Margin (dB)	Limit (dBuV/m)
19010.437500	51.9	H	0.0	52.1	-0.2	22.1	74
19539.562500	52.9	V	56.0	52.9	0.0	21.1	74
21814.375000	54.0	V	240.0	56.0	-2.0	20.0	74
21862.187500	54.7	H	241.0	56.5	-1.8	19.3	74
24838.250000	53.5	V	265.0	53.2	0.3	20.5	74
25187.812500	54.9	H	352.0	54.2	0.7	19.1	74

Remark: 1. Correction Factor = Antenna factor+ Insertion loss (cable loss + amplifier gain)

Frequency (MHz)	Average (dBuV/m)	Polarization	Azimuth (deg)	Reading value (dBuV/m)	Correct Factor (dB)	Margin (dB)	Limit (dBuV/m)
18975.375000	40.8	V	0.0	40.9	-0.1	13.2	54
19500.250000	41.3	H	88.0	41.2	0.1	12.7	54
21823.937500	42.8	V	0.0	44.8	-2.0	11.2	54
21882.375000	43.5	V	14.0	45.2	-1.7	10.5	54
24825.500000	42.4	V	122.0	42.2	0.2	11.6	54
26486.187500	43.9	V	311.0	42.8	1.1	10.1	54

Remark: 1. Correction Factor = Antenna factor+ Insertion loss (cable loss + amplifier gain)



BLE-Channel 39

FCC RE 0.03-1GHz QP Class B

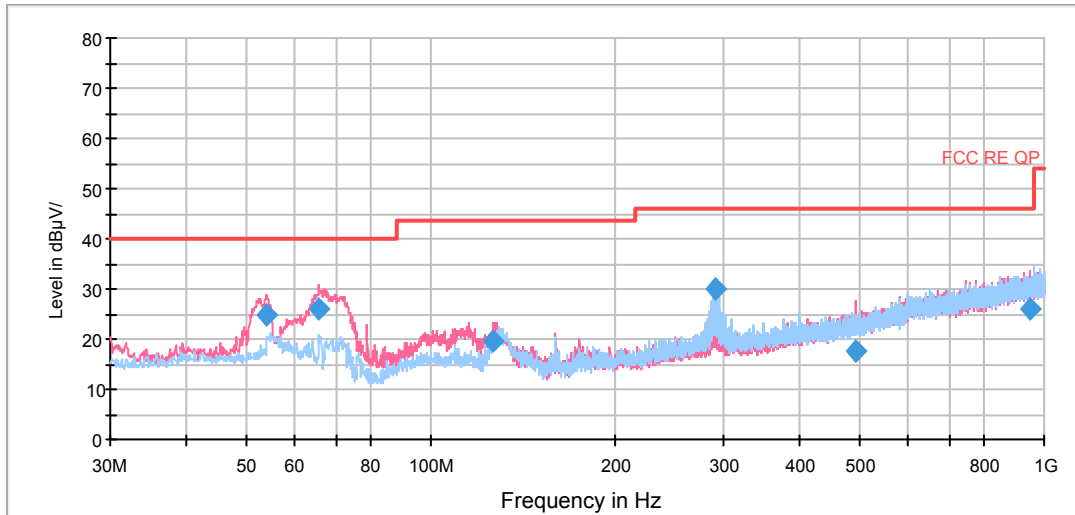

Radiates Emission from 30MHz to 1GHz

Frequency (MHz)	Quasi-Peak (dBuV/m)	Height (cm)	Polarization	Azimuth (deg)	Reading value (dBuV/m)	Correct Factor (dB)	Margin (dB)	Limit (dBuV/m)
53.845000	24.8	100.0	V	189.0	37.6	-12.8	15.2	40.0
65.687500	25.9	100.0	V	146.0	36.2	-10.3	14.1	40.0
126.712500	19.8	125.0	V	356.0	29.7	-9.9	23.7	43.5
291.212500	29.9	100.0	H	292.0	45.1	-15.2	16.1	46.0
493.981250	17.7	100.0	V	10.0	38.1	-20.4	28.3	46.0
949.035000	26.1	100.0	V	167.0	53.2	-27.1	19.9	46.0

- Remark: 1. Quasi-Peak = Reading value + Correction factor
 2. Correction Factor = Antenna factor+ Insertion loss(cable loss+amplifier gain)
 3. Margin = Limit – Quasi-Peak

RE 1G-3GHz PK+AV

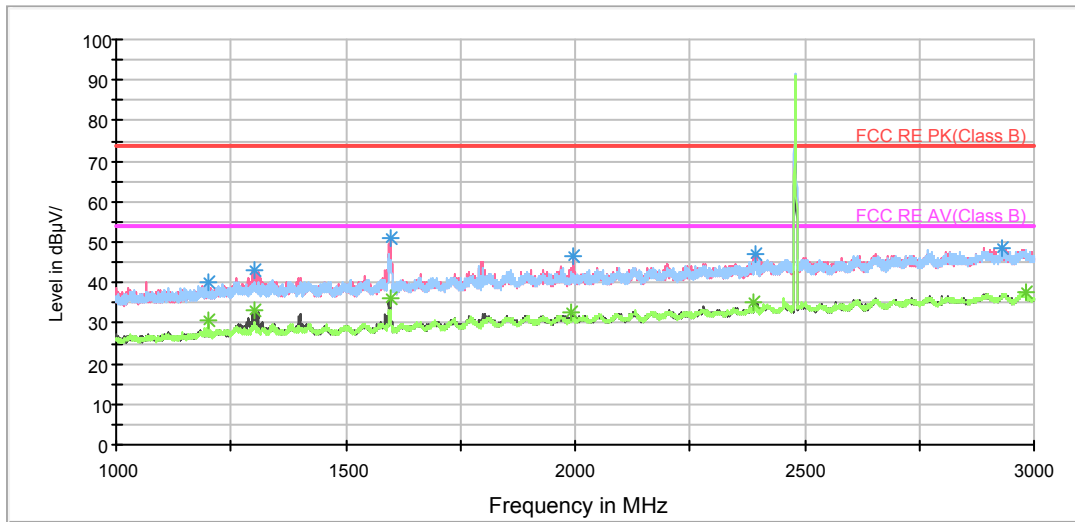

Note: The signal beyond the limit is carrier.

Radiates Emission from 1GHz to 3GHz

Frequency (MHz)	Peak (dBuV/m)	Height (cm)	Polarization	Azimuth (deg)	Reading value (dBuV/m)	Correct Factor (dB)	Margin (dB)	Limit (dBuV/m)
1200.500000	40.2	160.0	H	156.0	48.4	-8.2	33.8	74
1303.250000	43.3	160.0	V	65.0	51.1	-7.8	30.7	74
1596.750000	51.1	160.0	V	280.0	57.5	-6.4	22.9	74
1994.000000	46.6	160.0	V	265.0	49.8	-3.2	27.4	74
2394.750000	47.2	160.0	V	331.0	48.5	-1.3	26.8	74
2929.500000	48.3	160.0	H	25.0	46.6	1.7	25.7	74

Remark: 1. Correction Factor = Antenna factor+ Insertion loss (cable loss + amplifier gain)

Frequency (MHz)	Average (dBuV/m)	Height (cm)	Polarization	Azimuth (deg)	Reading value (dBuV/m)	Correct Factor (dB)	Margin (dB)	Limit (dBuV/m)
1200.250000	30.5	160.0	H	156.0	38.7	-8.2	23.5	54
1303.250000	33.1	160.0	V	65.0	40.9	-7.8	20.9	54
1596.750000	36.0	160.0	V	280.0	42.4	-6.4	18.0	54
1991.250000	32.7	160.0	V	331.0	36.0	-3.3	21.3	54
2390.750000	35.3	160.0	V	337.0	36.7	-1.4	18.7	54
2982.250000	37.5	160.0	V	331.0	35.3	2.2	16.5	54

Remark: 1. Correction Factor = Antenna factor+ Insertion loss (cable loss + amplifier gain)

RE 3-18GHz PK+AV

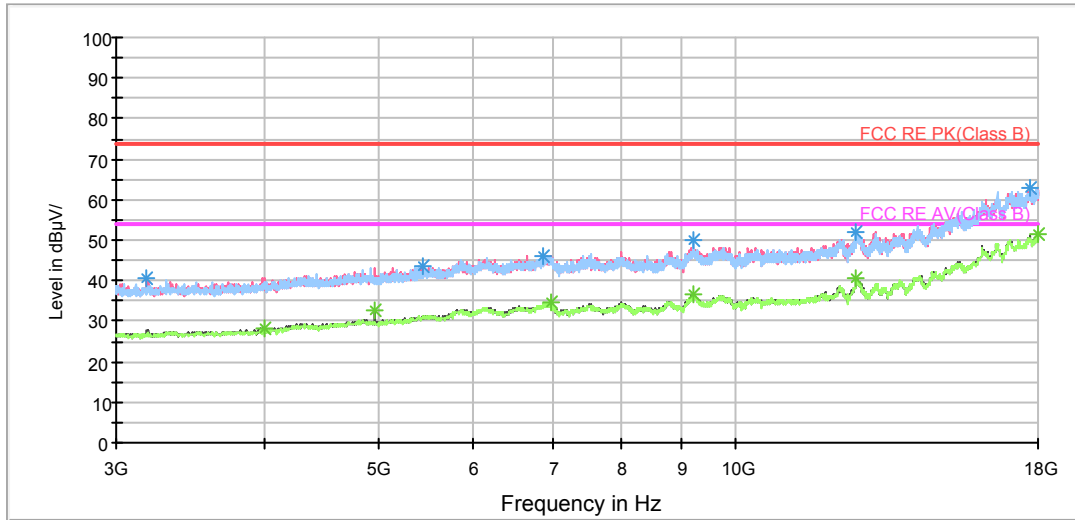

Radiates Emission from 3GHz to 18GHz

Frequency (MHz)	Peak (dBuV/m)	Height (cm)	Polarization	Azimuth (deg)	Reading value (dBuV/m)	Correct Factor (dB)	Margin (dB)	Limit (dBuV/m)
3185.625000	40.8	160.0	V	250.0	43.7	-2.9	33.2	74
5433.750000	43.5	160.0	V	340.0	40.7	2.8	30.5	74
6866.250000	46.2	160.0	V	0.0	40.3	5.9	27.8	74
9225.000000	49.8	160.0	H	0.0	39.9	9.9	24.2	74
12635.625000	51.9	160.0	H	19.0	37.8	14.1	22.1	74
17716.875000	62.8	160.0	H	0.0	38.2	24.6	11.2	74

Remark: 1. Correction Factor = Antenna factor+ Insertion loss (cable loss + amplifier gain)

Frequency (MHz)	Average (dBuV/m)	Height (cm)	Polarization	Azimuth (deg)	Reading value (dBuV/m)	Correct Factor (dB)	Margin (dB)	Limit (dBuV/m)
3995.625000	28.1	160.0	V	295.0	29.2	-1.1	25.9	54
4959.375000	32.5	160.0	V	136.0	30.7	1.8	21.5	54
6997.500000	34.4	160.0	V	136.0	27.9	6.5	19.6	54
9217.500000	36.5	160.0	V	340.0	26.5	10.0	17.5	54
12639.375000	40.6	160.0	V	159.0	26.1	14.5	13.4	54
17998.125000	51.3	160.0	V	340.0	25.9	25.4	2.7	54

Remark: 1. Correction Factor = Antenna factor+ Insertion loss (cable loss + amplifier gain)

BELL_RE 18-26.5GHz PK+AV

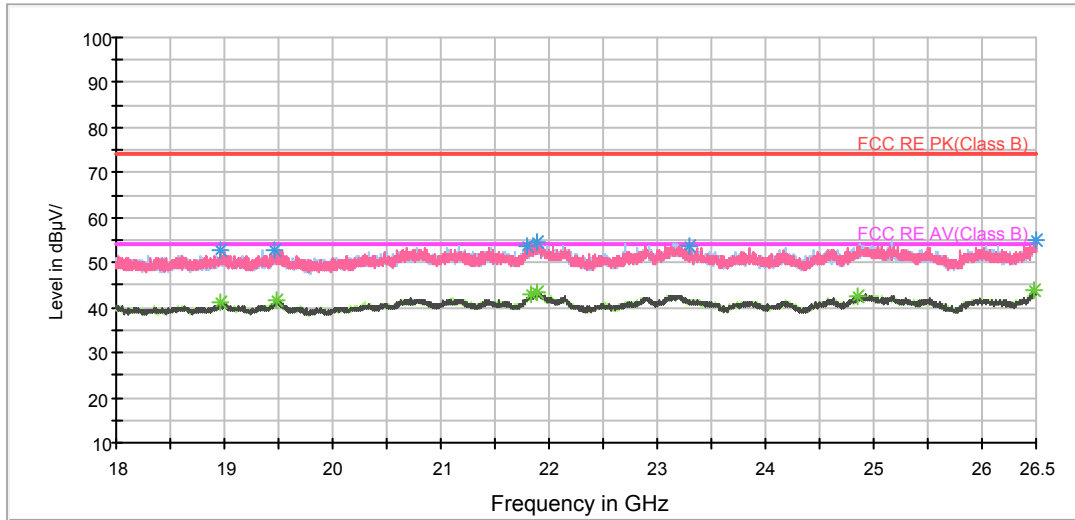

Radiates Emission from 18GHz to 26.5GHz

Frequency (MHz)	Peak (dBuV/m)	Polarization	Azimuth (deg)	Reading value (dBuV/m)	Correct Factor (dB)	Margin (dB)	Limit (dBuV/m)
18971.125000	52.6	V	35.0	52.7	-0.1	21.4	74
19467.312500	52.9	H	342.0	52.8	0.1	21.1	74
21797.375000	53.7	V	84.0	55.8	-2.1	20.3	74
21893.000000	54.5	V	51.0	56.1	-1.6	19.5	74
23299.750000	53.5	H	71.0	53.5	0.0	20.5	74
26496.812500	55.0	V	0.0	53.9	1.1	19.0	74

Remark: 1. Correction Factor = Antenna factor+ Insertion loss (cable loss + amplifier gain)

Frequency (MHz)	Average (dBuV/m)	Polarization	Azimuth (deg)	Reading value (dBuV/m)	Correct Factor (dB)	Margin (dB)	Limit (dBuV/m)
18971.125000	41.2	V	35.0	41.3	-0.1	12.8	54
19488.562500	41.5	V	2.0	41.4	0.1	12.5	54
21834.562500	42.9	V	93.0	44.8	-1.9	11.1	54
21885.562500	43.5	H	290.0	45.1	-1.6	10.5	54
24843.562500	42.4	H	256.0	42.1	0.3	11.6	54
26490.437500	43.8	V	158.0	42.7	1.1	10.2	54

Remark: 1. Correction Factor = Antenna factor+ Insertion loss (cable loss + amplifier gain)

5.8. Conducted Emission

Ambient condition

Temperature	Relative humidity	Pressure
23°C ~25°C	45%~50%	101.5kPa

Methods of Measurement

The EUT is placed on a non-metallic table of 80cm height above the horizontal metal reference ground plane. During the test, the EUT was operating in its typical mode. The test method is according to ANSI C63.10-2013. Connect the AC power line of the EUT to the L.I.S.N. Use EMI receiver to detect the average and Quasi-peak value. RBW is set to 9 kHz, VBW is set to 30kHz. The measurement result should include both L line and N line.

The test is in transmitting mode.

Test Setup

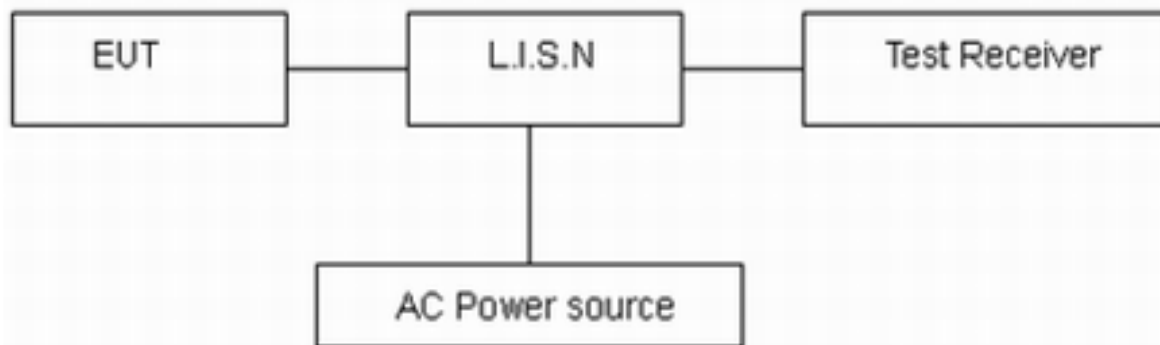

Note: AC Power source is used to change the voltage 110V/60Hz.

Limits

Frequency (MHz)	Conducted Limits(dBμV)	
	Quasi-peak	Average
0.15 - 0.5	66 to 56 *	56 to 46*
0.5 - 5	56	46
5 - 30	60	50

*: Decreases with the logarithm of the frequency.

Measurement Uncertainty

The assessed measurement uncertainty to ensure 95% confidence level for the normal distribution is with the coverage factor $k = 1.96$, $U = 2.69$ dB.



Test Results:

Following plots, Blue trace uses the peak detection and Green trace uses the average detection.

BLE, Channel No.: 0

L Line

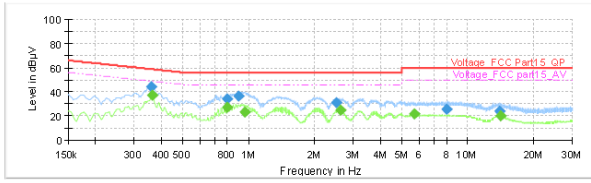

Final Result

Table with 11 columns: Frequency (MHz), QuasiPeak (dBµV), Average (dBµV), Limit (dBµV), Margin (dB), Meas. Time (ms), Bandwidth (kHz), Line, Filter, Corr. (dB). Contains 13 rows of test data.

N Line

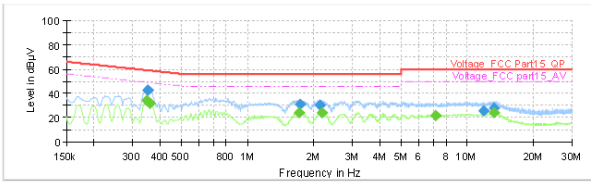

Final Result

Table with 11 columns: Frequency (MHz), QuasiPeak (dBµV), Average (dBµV), Limit (dBµV), Margin (dB), Meas. Time (ms), Bandwidth (kHz), Line, Filter, Corr. (dB). Contains 13 rows of test data.

BLE, Channel No.: 19

L Line

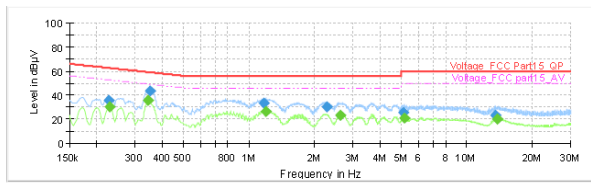

Final Result

Table with 11 columns: Frequency (MHz), QuasiPeak (dBµV), Average (dBµV), Limit (dBµV), Margin (dB), Meas. Time (ms), Bandwidth (kHz), Line, Filter, Corr. (dB). Contains 13 rows of test data.

N Line

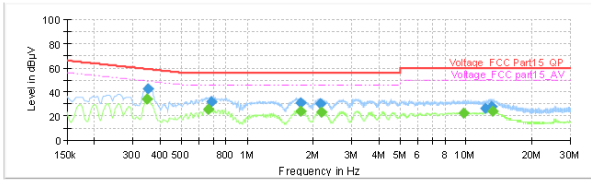

Final Result

Table with 11 columns: Frequency (MHz), QuasiPeak (dBµV), Average (dBµV), Limit (dBµV), Margin (dB), Meas. Time (ms), Bandwidth (kHz), Line, Filter, Corr. (dB). Contains 13 rows of test data.



BLE, Channel No.: 39

L Line

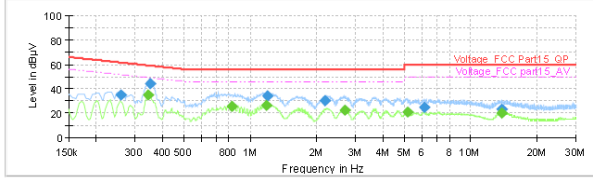

Final Result

Frequency (MHz)	QuasiPeak (dBµV)	Average (dBµV)	Limit (dBµV)	Margin (dB)	Meas. Time (ms)	Bandwidth (kHz)	Line	Filter	Corr. (dB)
0.258000	35.13	---	61.50	26.36	1000.0	9.000	L1	ON	19.1
0.343500	---	34.96	49.12	14.16	1000.0	9.000	L1	ON	19.2
0.350250	43.92	---	58.96	15.03	1000.0	9.000	L1	ON	19.2
0.822750	---	25.46	46.00	20.54	1000.0	9.000	L1	ON	19.2
1.187250	---	25.99	46.00	20.01	1000.0	9.000	L1	ON	19.2
1.189500	33.78	---	56.00	22.22	1000.0	9.000	L1	ON	19.2
2.190750	29.87	---	56.00	26.13	1000.0	9.000	L1	ON	19.1
2.697000	---	22.59	46.00	23.41	1000.0	9.000	L1	ON	19.0
5.172000	---	20.78	50.00	29.22	1000.0	9.000	L1	ON	19.1
6.135000	24.71	---	60.00	35.29	1000.0	9.000	L1	ON	19.1
13.767000	---	20.24	50.00	29.76	1000.0	9.000	L1	ON	19.5
13.834500	23.45	---	60.00	36.55	1000.0	9.000	L1	ON	19.5

N Line

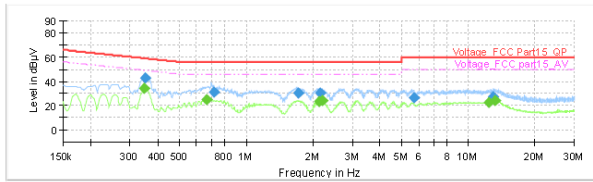

Final Result

Frequency (MHz)	QuasiPeak (dBµV)	Average (dBµV)	Limit (dBµV)	Margin (dB)	Meas. Time (ms)	Bandwidth (kHz)	Line	Filter	Corr. (dB)
0.348000	---	33.95	49.01	15.06	1000.0	9.000	N	ON	19.2
0.352500	42.68	---	58.90	16.22	1000.0	9.000	N	ON	19.2
0.663000	---	25.03	46.00	20.98	1000.0	9.000	N	ON	19.3
0.719250	31.38	---	56.00	24.62	1000.0	9.000	N	ON	19.3
1.725000	30.18	---	56.00	25.82	1000.0	9.000	N	ON	19.2
2.139000	---	23.57	46.00	22.43	1000.0	9.000	N	ON	19.1
2.157000	30.38	---	56.00	25.62	1000.0	9.000	N	ON	19.1
2.195250	---	24.00	46.00	22.00	1000.0	9.000	N	ON	19.1
5.669750	26.07	---	60.00	33.93	1000.0	9.000	N	ON	19.1
12.405750	---	22.72	50.00	27.28	1000.0	9.000	N	ON	19.4
12.905250	27.16	---	60.00	32.84	1000.0	9.000	N	ON	19.5
13.206750	---	24.04	50.00	25.96	1000.0	9.000	N	ON	19.5



6. Main Test Instruments

Name	Type	Manufacturer	Serial Number	Calibration Date	Expiration Time
Spectrum Analyzer	FSV30	R&S	100815	2016-12-16	2017-12-15
EMI Test Receiver	ESCI	R&S	100948	2016-12-16	2017-12-15
TRILOG Broadband Antenna	VULB 9163	Schwarzbeck	9163-201	2014-12-06	2017-12-05
Double Ridged Waveguide Horn Antenna	HF907	R&S	100126	2014-12-06	2017-12-05
Loop Antenna	FMZB1519	SCHWARZBECK	1519-047	2017-02-18	2020-02-17
Standard Gain Horn	3160-09	ETS-Lindgren	00102644	2015-01-30	2018-01-29
EMI Test Receiver	ESCS30	R&S	100138	2016-12-16	2017-12-15
LISN	ENV216	R&S	101171	2016-12-16	2019-12-15
Spectrum Analyzer	N9010A	Agilent	MY47191109	2017-05-20	2018-05-19
RF Cable	SMA 15cm	Agilent	0001	2017-02-06	2017-08-05

*****END OF REPORT *****

ANNEX A: EUT Appearance and Test Setup

A.1 EUT Appearance





a: EUT

Picture 1 EUT and Accessory

A.2 Test Setup

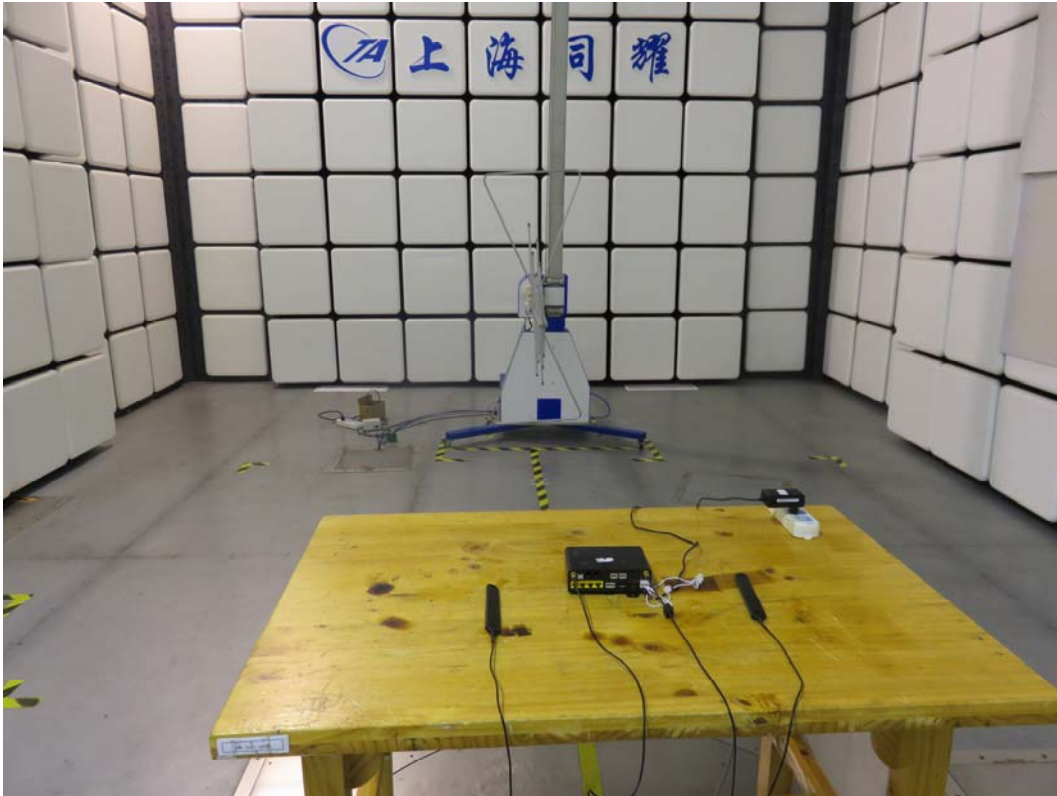

30M Hz-1GHz

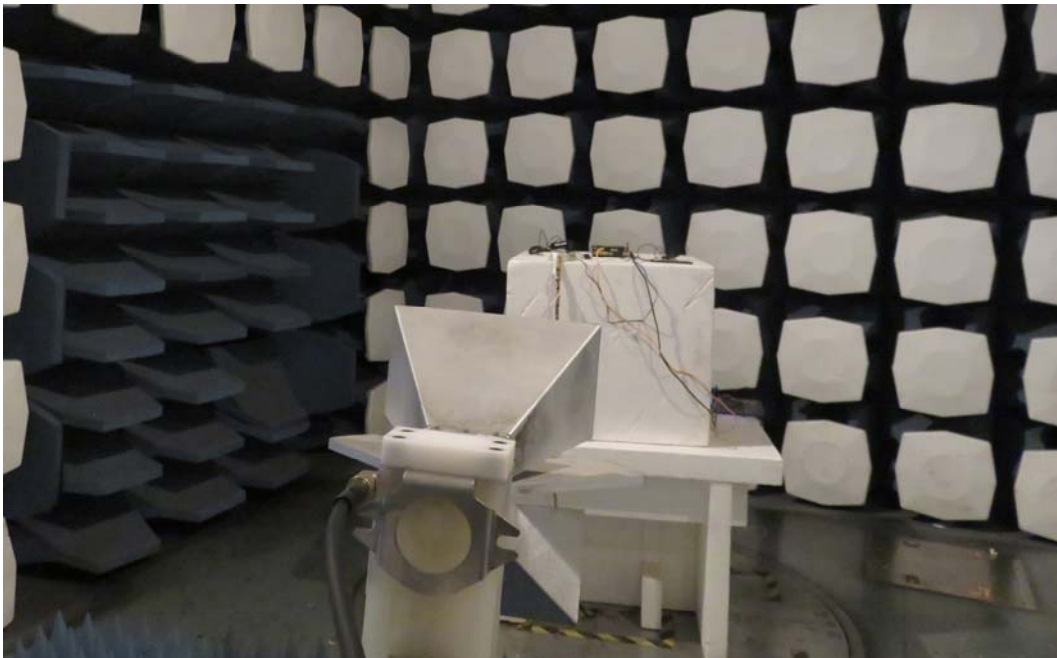

Above 1GHz

Picture 2 Radiated Emission Test Setup



Picture 3 Conducted Emission Test Setup