

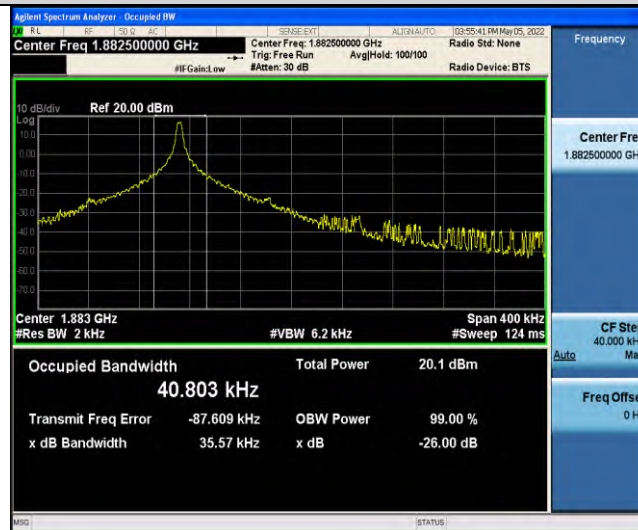

Band25-Stand-Alone-NaN-BPSK-26042-1 @0-3.75kHz-0.0381-PASS

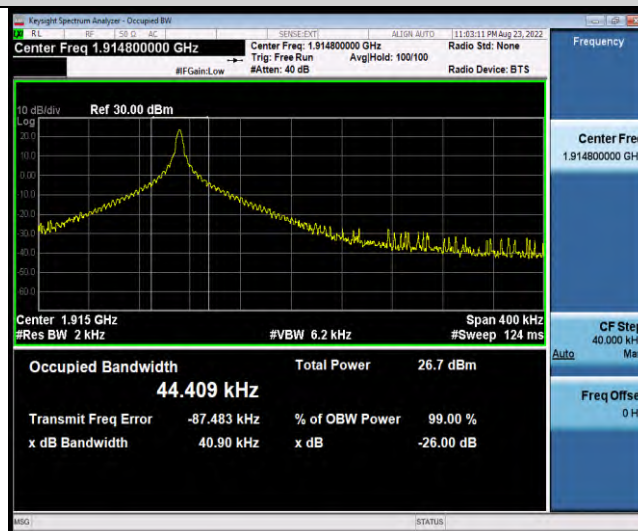

Band25-Stand-Alone-NaN-BPSK-26365-1 @0-3.75kHz-0.0356-PASS



Band25-Stand-Alone-NaN-BPSK-26688-1 @0-3.75kHz-0.0409-PASS



Band25-Stand-Alone-NaN-QPSK-26042-1 @0-3.75kHz-0.0411-PASS

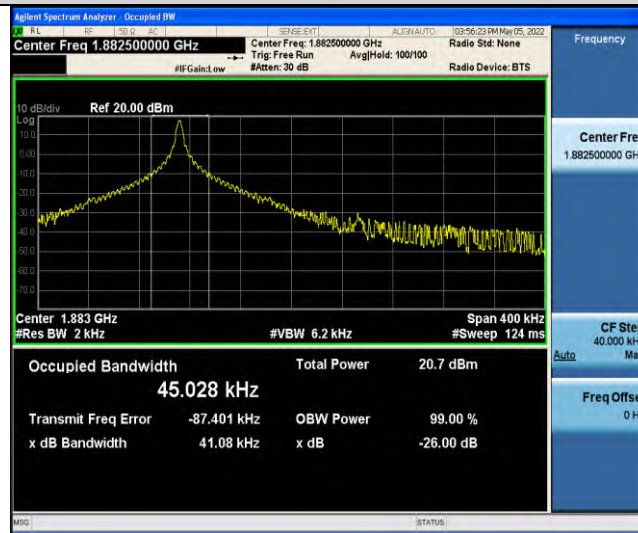

Band25-Stand-Alone-NaN-QPSK-26365-1 @0-3.75kHz-0.0411-PASS

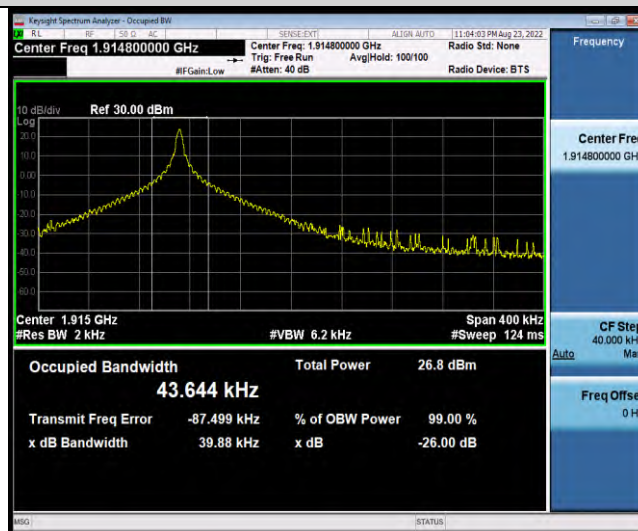

Band25-Stand-Alone-NaN-QPSK-26688-1 @0-3.75kHz-0.0399-PASS

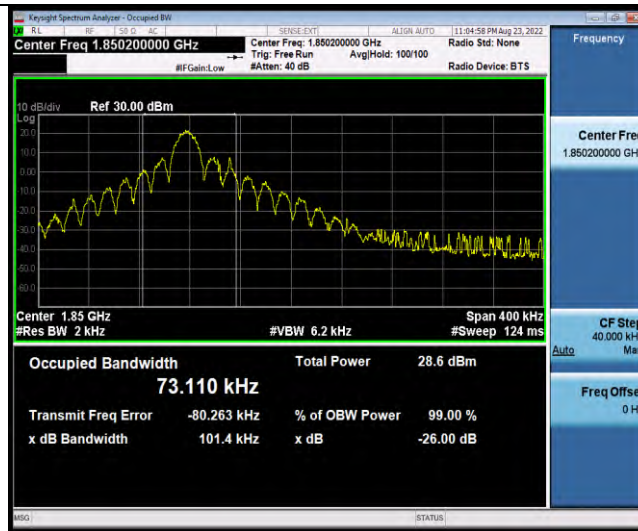

Band25-Stand-Alone-NaN-BPSK-26042-1@0-15kHz-0.1014-PASS

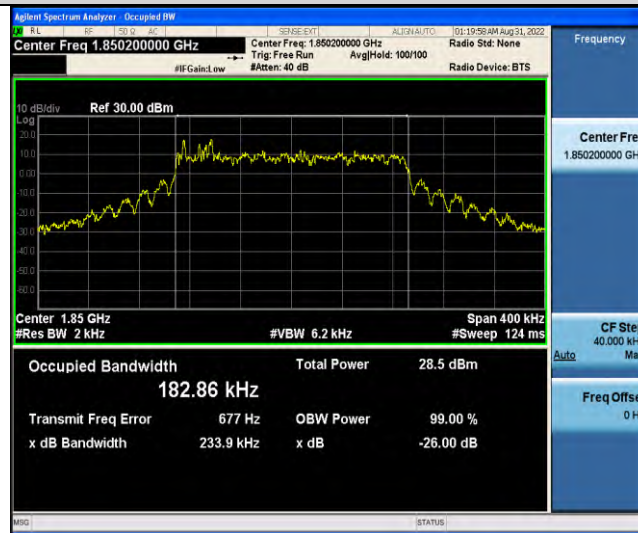

Band25-Stand-Alone-NaN-BPSK-26042-12@0-15kHz-0.2339-PASS

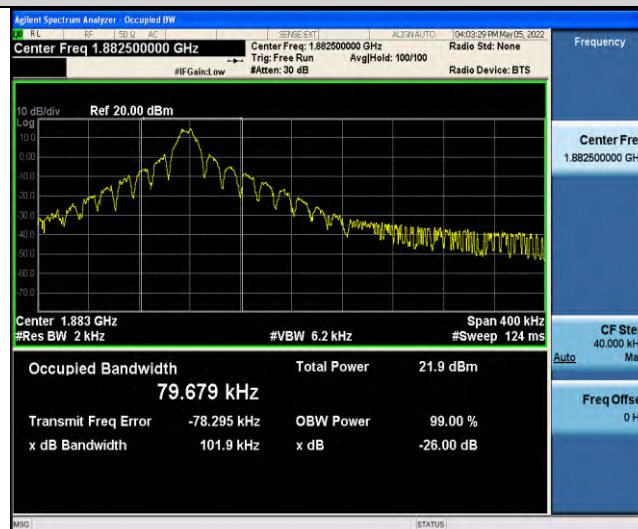

Band25-Stand-Alone-NaN-BPSK-26365-1@0-15kHz-0.1019-PASS

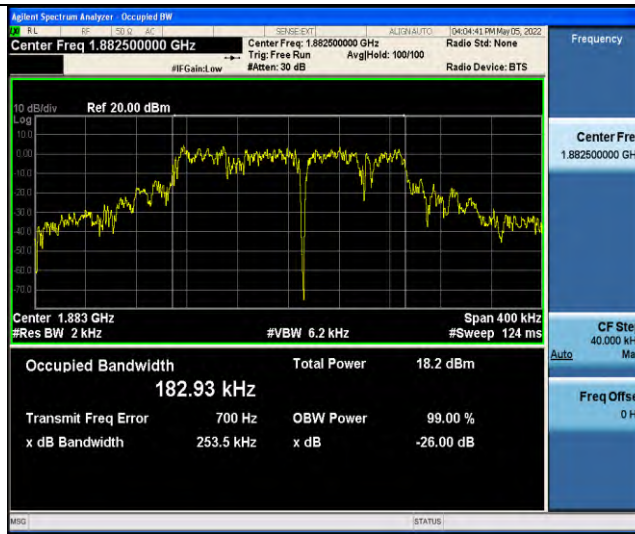

Band25-Stand-Alone-NaN-BPSK-26365-12@0-15kHz-0.2535-PASS

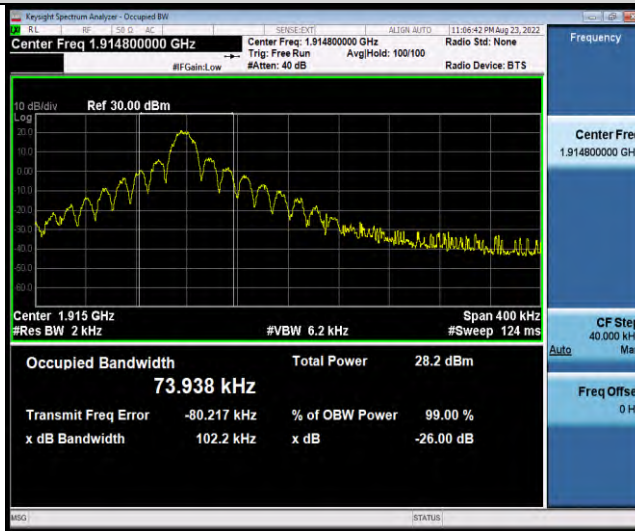

Band25-Stand-Alone-NaN-BPSK-26688-1@0-15kHz-0.1022-PASS

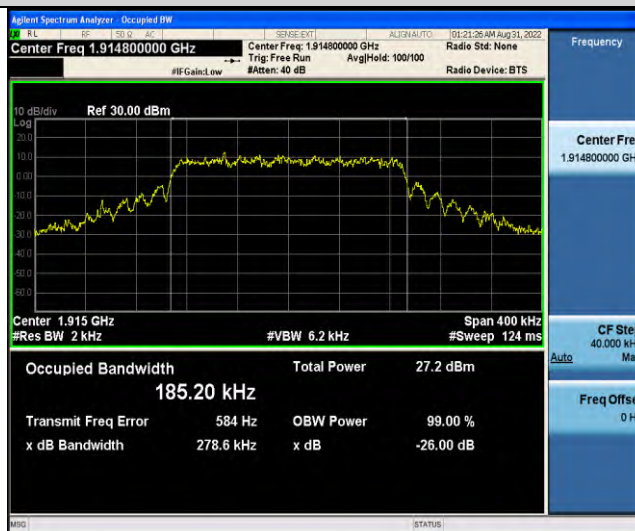

Band25-Stand-Alone-NaN-BPSK-26688-12@0-15kHz-0.2786-PASS

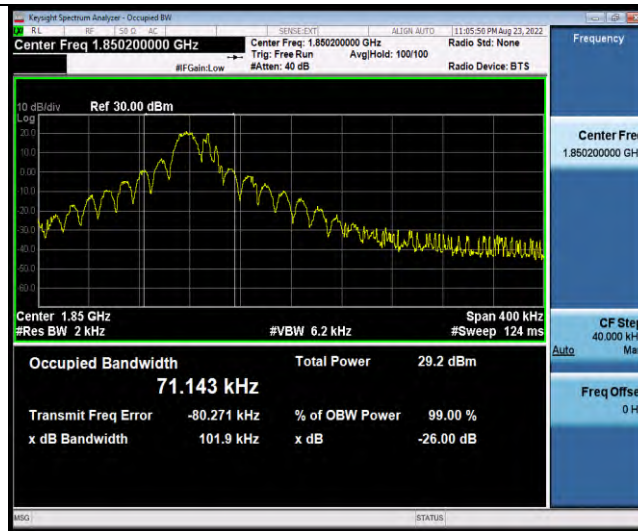

Band25-Stand-Alone-NaN-QPSK-26042-1 @0-15kHz-0.1019-PASS

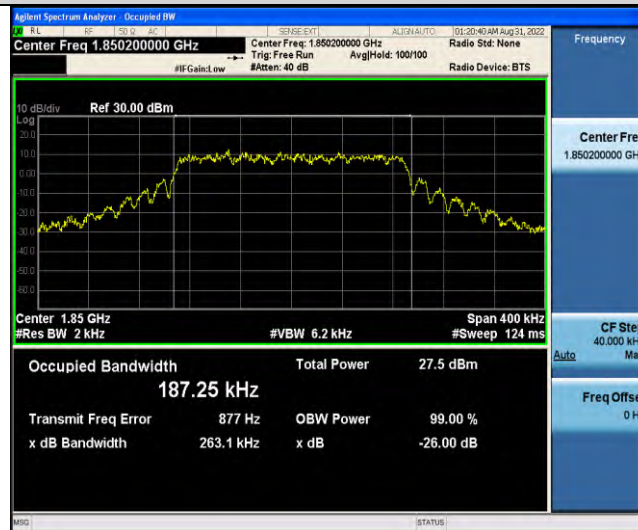

Band25-Stand-Alone-NaN-QPSK-26042-12 @0-15kHz-0.2631-PASS

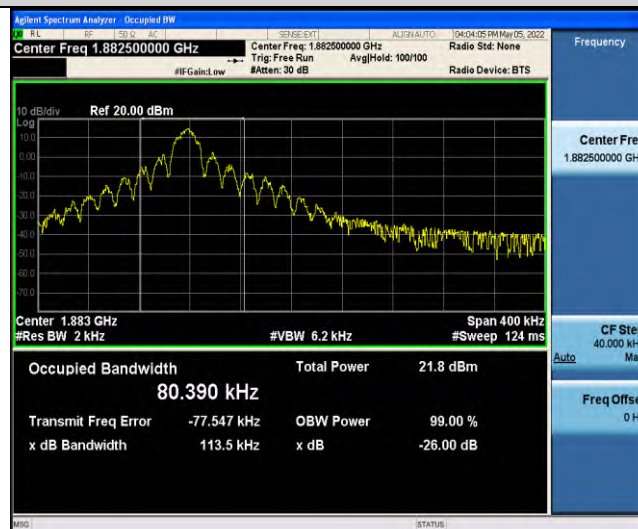

Band25-Stand-Alone-NaN-QPSK-26365-1 @0-15kHz-0.1135-PASS

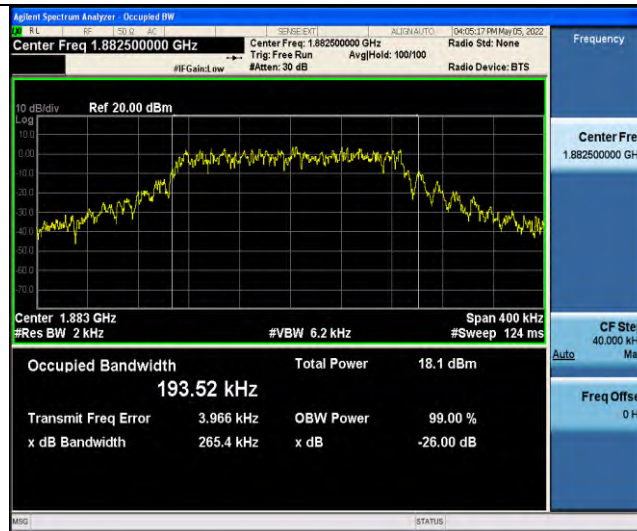

Band25-Stand-Alone-NaN-QPSK-26365-12@0-15kHz-0.2654-PASS

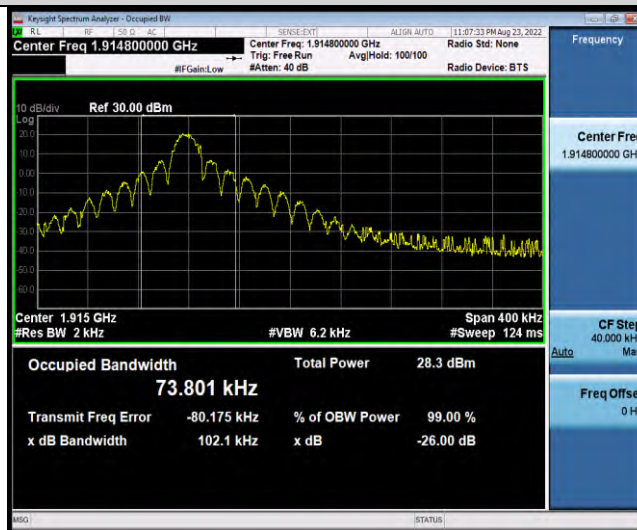

Band25-Stand-Alone-NaN-QPSK-26688-1@0-15kHz-0.1021-PASS

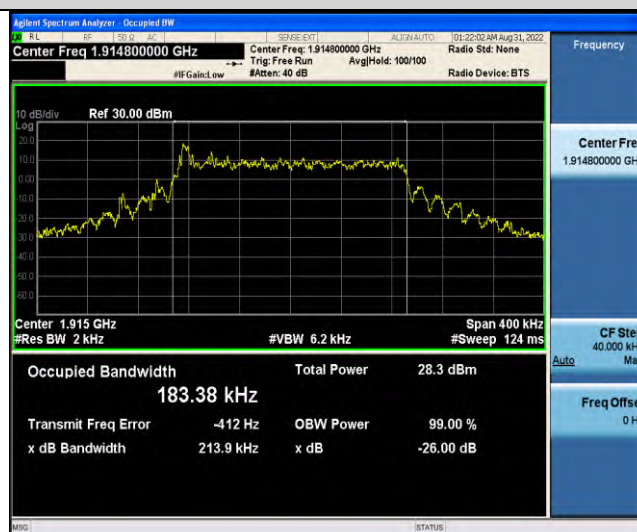

Band25-Stand-Alone-NaN-QPSK-26688-12@0-15kHz-0.2139-PASS



Band26-Stand-Alone-NaN-BPSK-26692-1 @0-3.75kHz-0.0346-PASS



Band26-Stand-Alone-NaN-BPSK-26740-1 @0-3.75kHz-0.0362-PASS

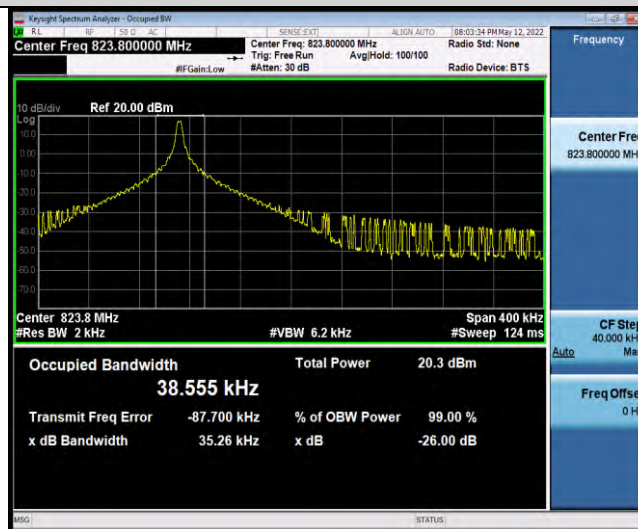

Band26-Stand-Alone-NaN-BPSK-26788-1 @0-3.75kHz-0.0353-PASS



Band26-Stand-Alone-NaN-QPSK-26692-1 @ 0-3.75kHz-0.0400-PASS

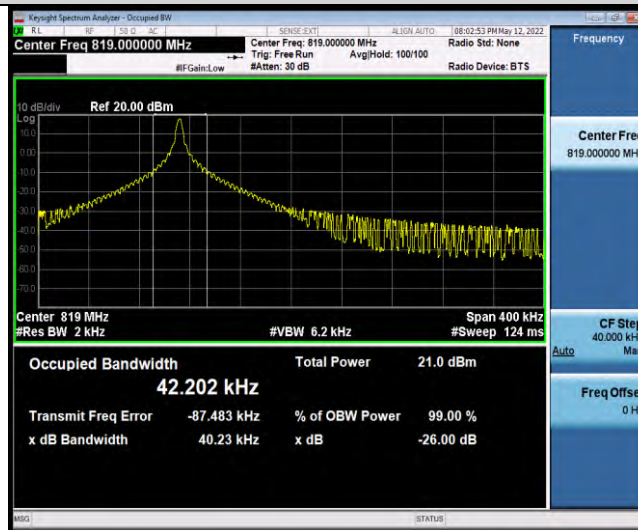

Band26-Stand-Alone-NaN-QPSK-26740-1 @ 0-3.75kHz-0.0402-PASS



Band26-Stand-Alone-NaN-QPSK-26788-1 @ 0-3.75kHz-0.0412-PASS





Band26-Stand-Alone-NaN-BPSK-26692-1@0-15kHz-0.1007-PASS

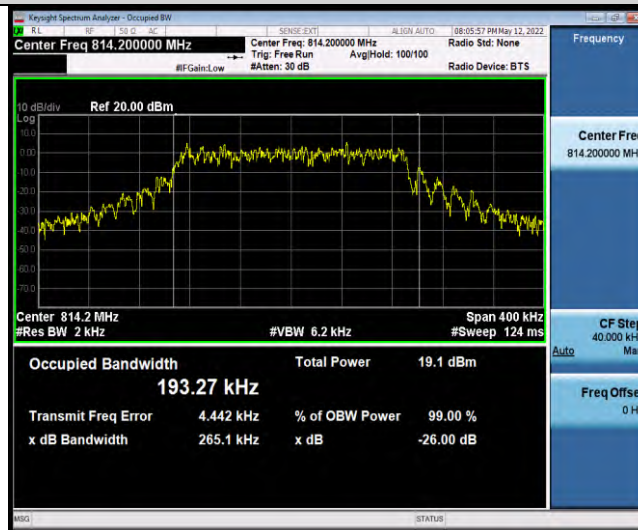

Band26-Stand-Alone-NaN-BPSK-26692-12@0-15kHz-0.2651-PASS

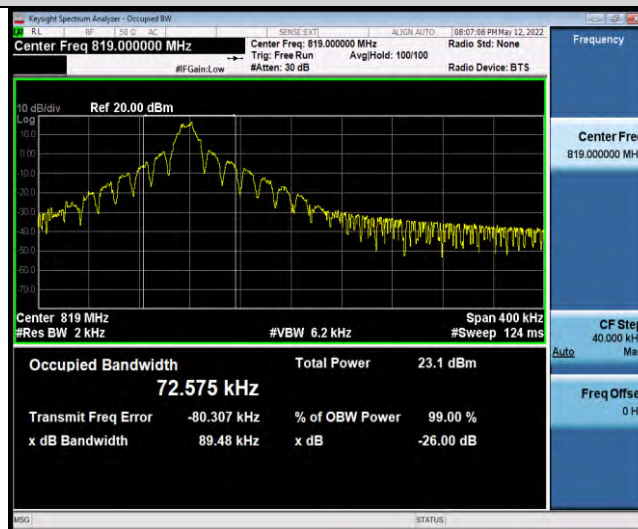

Band26-Stand-Alone-NaN-BPSK-26740-1@0-15kHz-0.0895-PASS

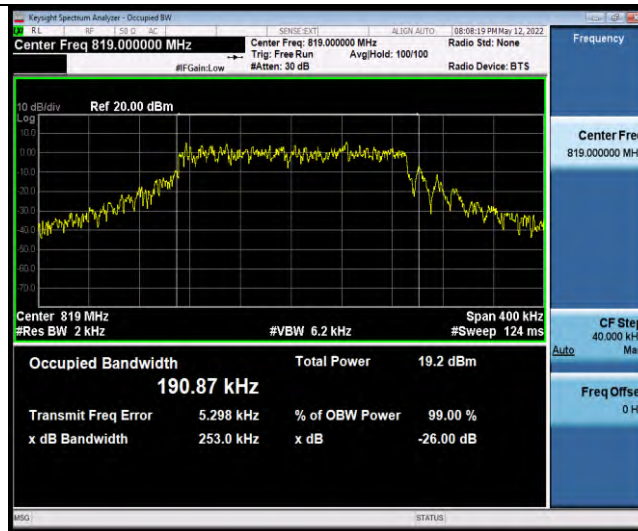

Band26-Stand-Alone-NaN-BPSK-26740-12@0-15kHz-0.2530-PASS

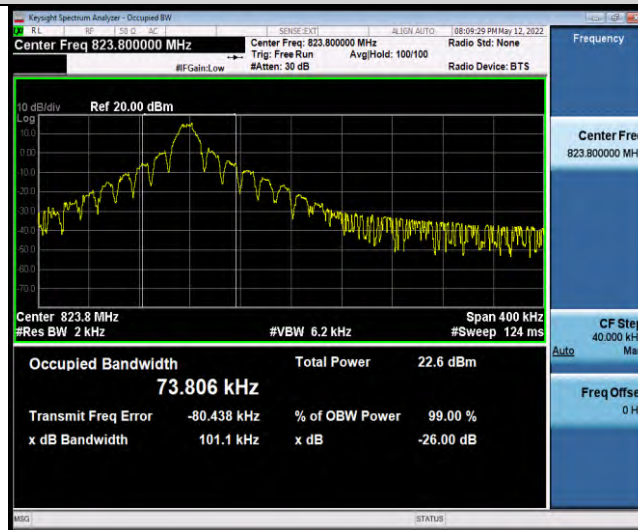

Band26-Stand-Alone-NaN-BPSK-26788-1@0-15kHz-0.1011-PASS

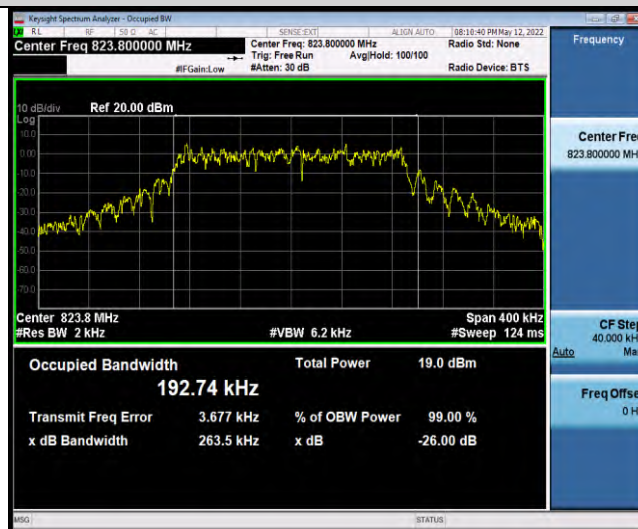

Band26-Stand-Alone-NaN-BPSK-26788-12@0-15kHz-0.2635-PASS



Band26-Stand-Alone-NaN-QPSK-26692-1 @0-15kHz-0.0885-PASS

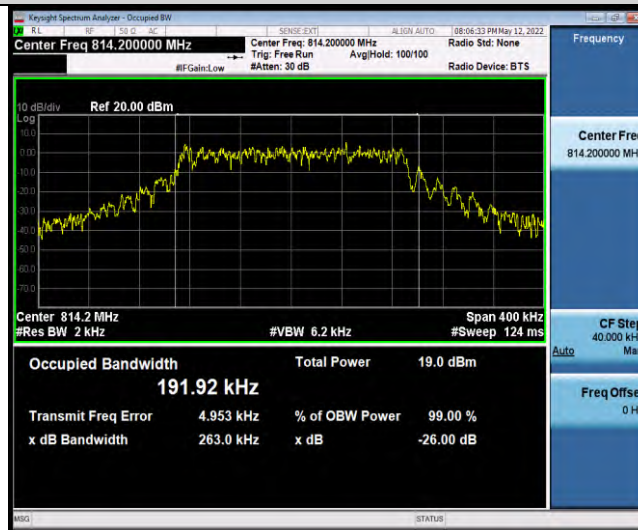

Band26-Stand-Alone-NaN-QPSK-26692-12 @0-15kHz-0.2630-PASS

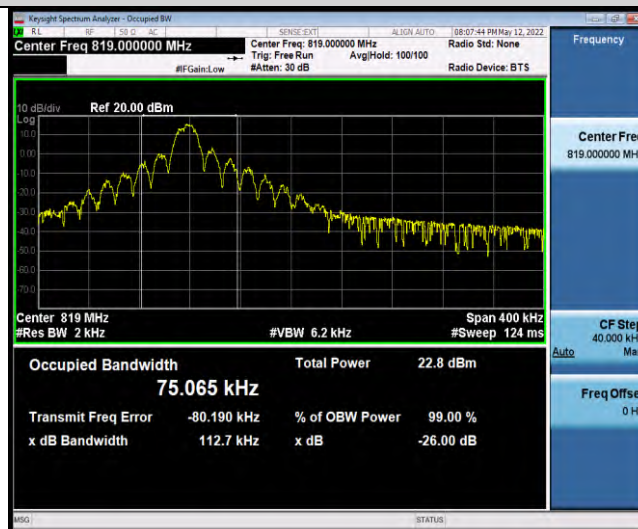

Band26-Stand-Alone-NaN-QPSK-26740-1 @0-15kHz-0.1127-PASS

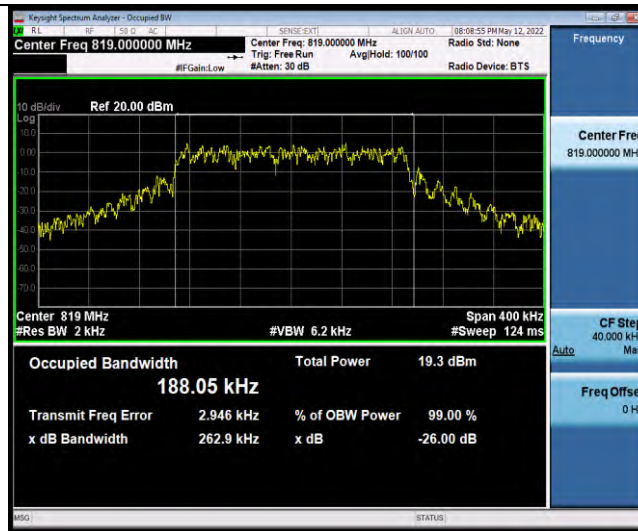

Band26-Stand-Alone-NaN-QPSK-26740-12@0-15kHz-0.2629-PASS

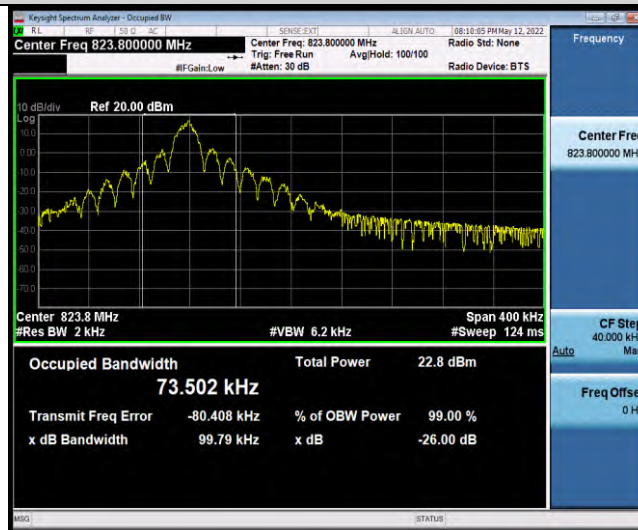

Band26-Stand-Alone-NaN-QPSK-26788-1 @0-15kHz-0.0998-PASS

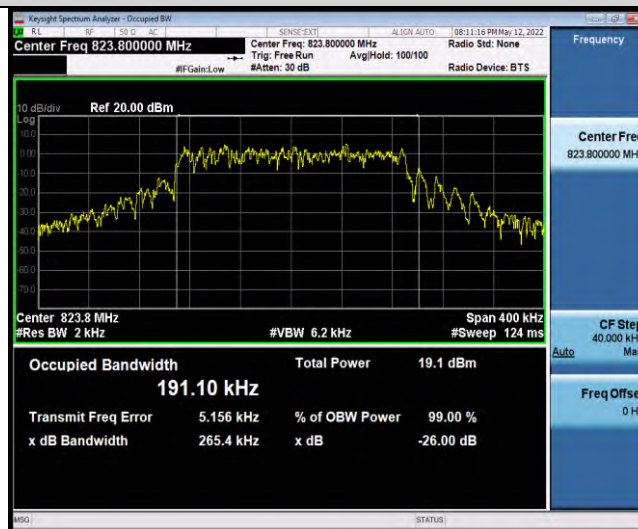

Band26-Stand-Alone-NaN-QPSK-26788-12@0-15kHz-0.2654-PASS



Band26-Stand-Alone-NaN-BPSK-26792-1 @0-3.75kHz-0.0360-PASS

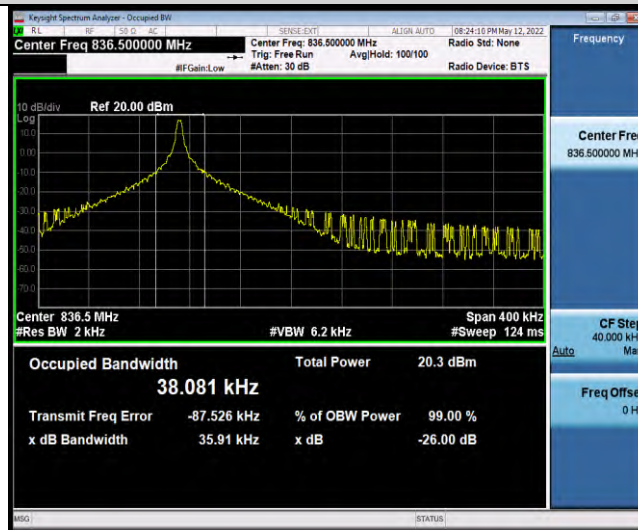

Band26-Stand-Alone-NaN-BPSK-26915-1 @0-3.75kHz-0.0359-PASS



Band26-Stand-Alone-NaN-BPSK-27038-1 @0-3.75kHz-0.0348-PASS

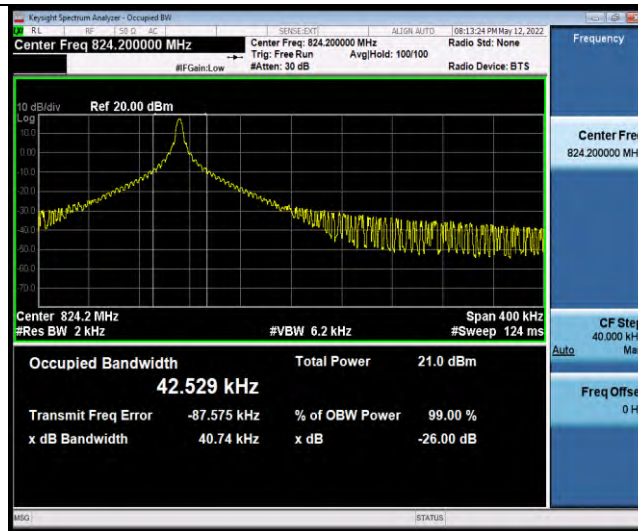

Band26-Stand-Alone-NaN-QPSK-26792-1 @ 0-3.75kHz-0.0407-PASS



Band26-Stand-Alone-NaN-QPSK-26915-1 @ 0-3.75kHz-0.0410-PASS



Band26-Stand-Alone-NaN-QPSK-27038-1 @ 0-3.75kHz-0.0403-PASS



Band26-Stand-Alone-NaN-BPSK-26792-1@0-15kHz-0.0922-PASS

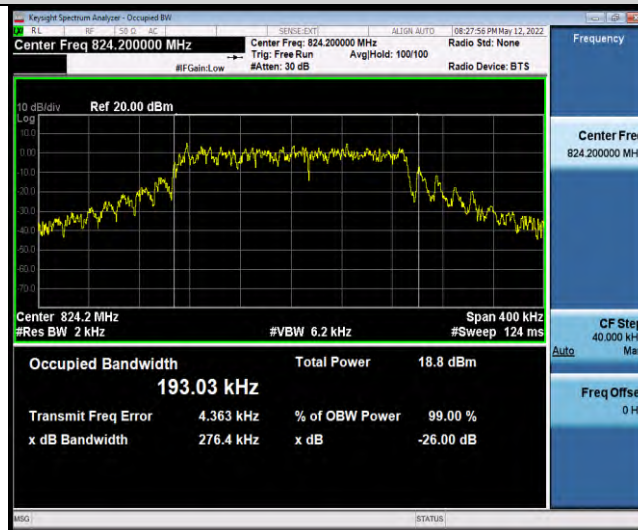

Band26-Stand-Alone-NaN-BPSK-26792-12@0-15kHz-0.2764-PASS

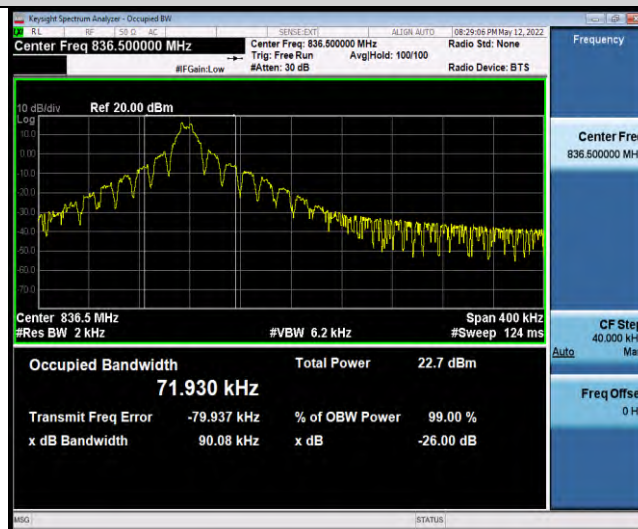

Band26-Stand-Alone-NaN-BPSK-26915-1@0-15kHz-0.0901-PASS

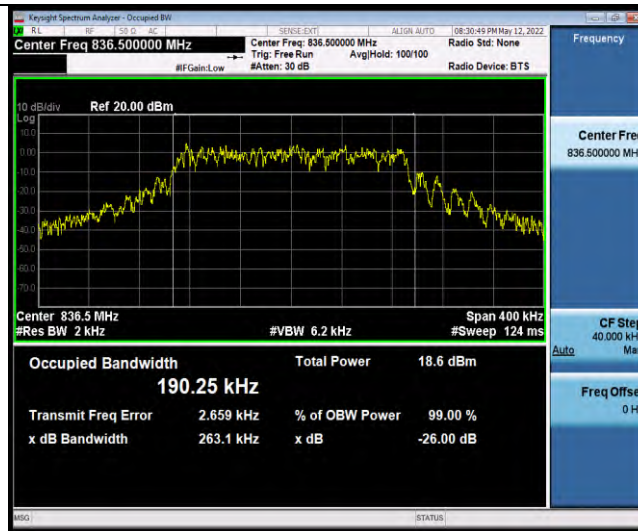

Band26-Stand-Alone-NaN-BPSK-26915-12@0-15kHz-0.2631-PASS

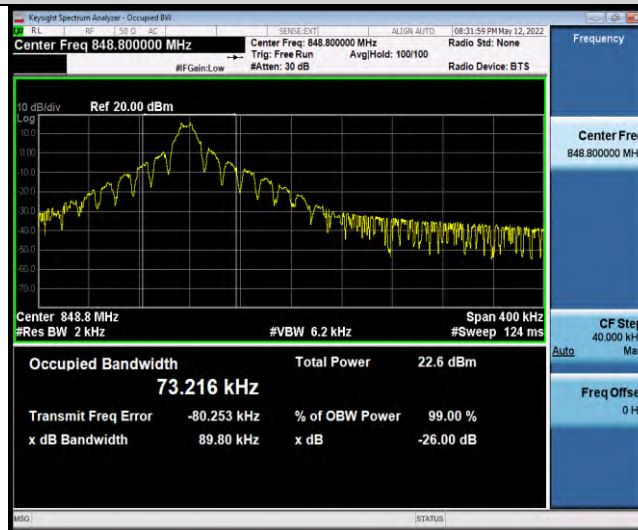

Band26-Stand-Alone-NaN-BPSK-27038-1@0-15kHz-0.0898-PASS

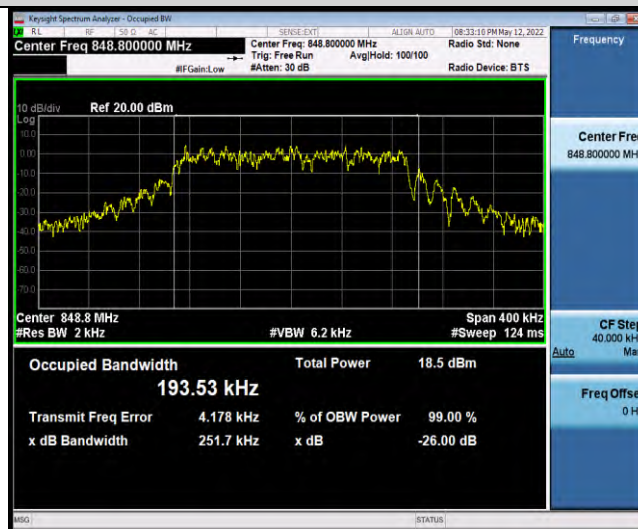

Band26-Stand-Alone-NaN-BPSK-27038-12@0-15kHz-0.2517-PASS



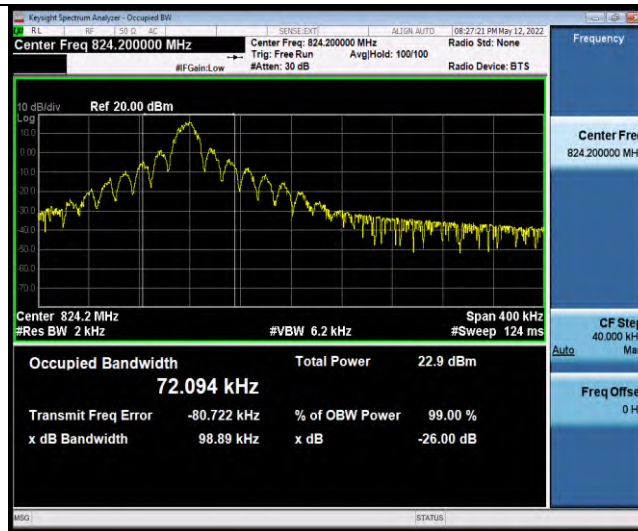

Band26-Stand-Alone-NaN-QPSK-26792-1 @ 0-15kHz-0.0989-PASS

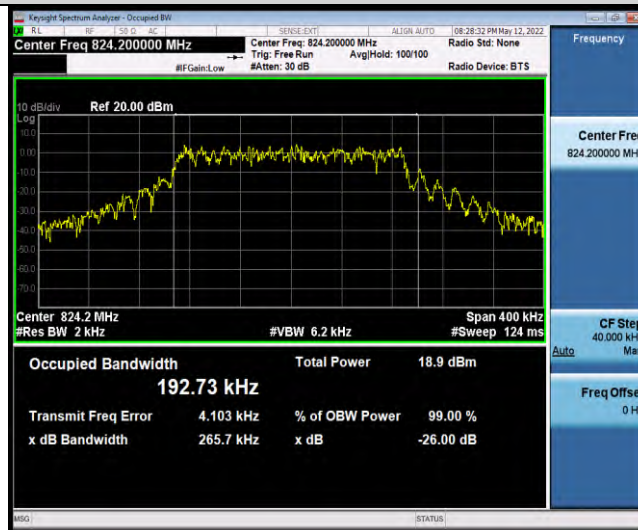

Band26-Stand-Alone-NaN-QPSK-26792-12 @ 0-15kHz-0.2657-PASS



Band26-Stand-Alone-NaN-QPSK-26915-1 @ 0-15kHz-0.0994-PASS

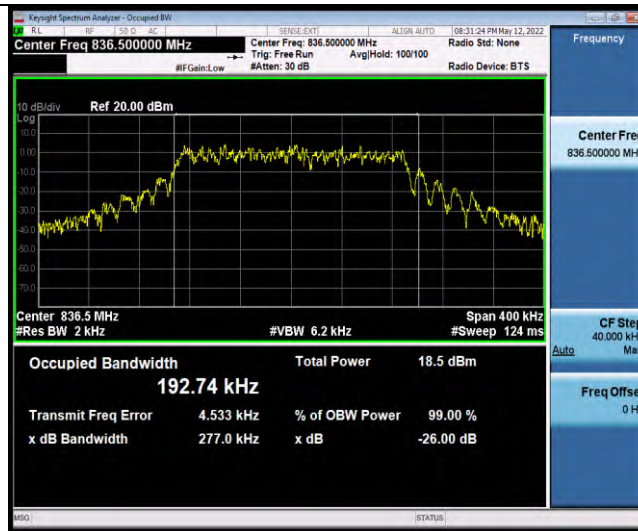

Band26-Stand-Alone-NaN-QPSK-26915-12@0-15kHz-0.2770-PASS



Band26-Stand-Alone-NaN-QPSK-27038-1@0-15kHz-0.0906-PASS

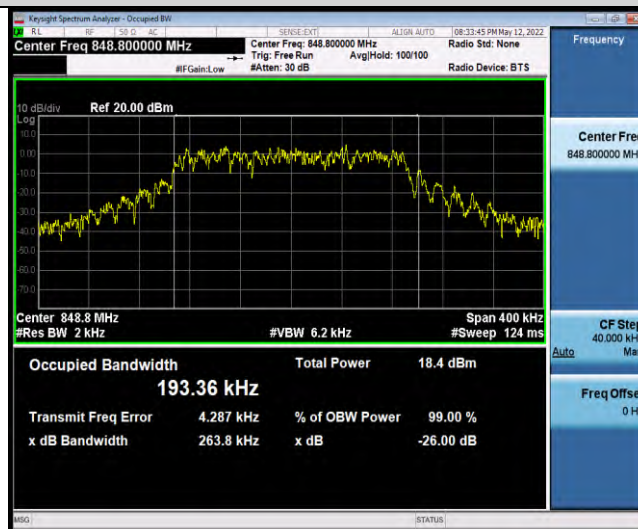

Band26-Stand-Alone-NaN-QPSK-27038-12@0-15kHz-0.2638-PASS

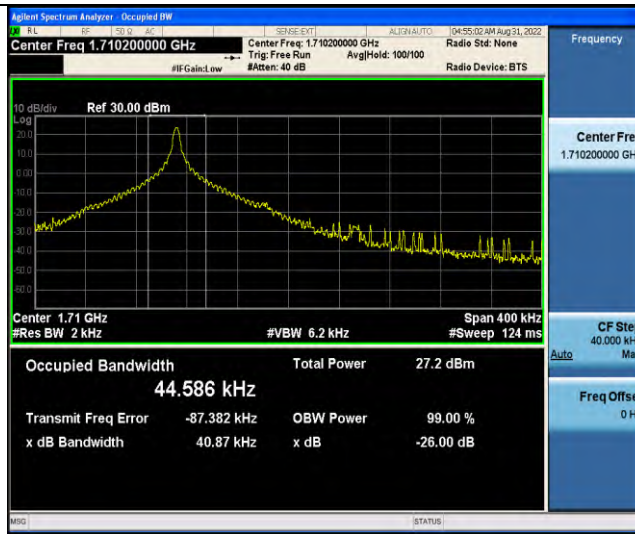

Band66-Stand-Alone-NaN-BPSK-131974-1 @ 0-3.75kHz-0.0409-PASS

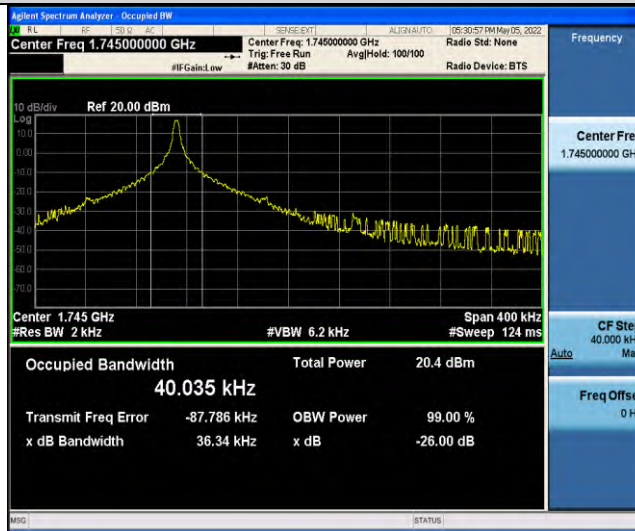

Band66-Stand-Alone-NaN-BPSK-132322-1 @ 0-3.75kHz-0.0363-PASS

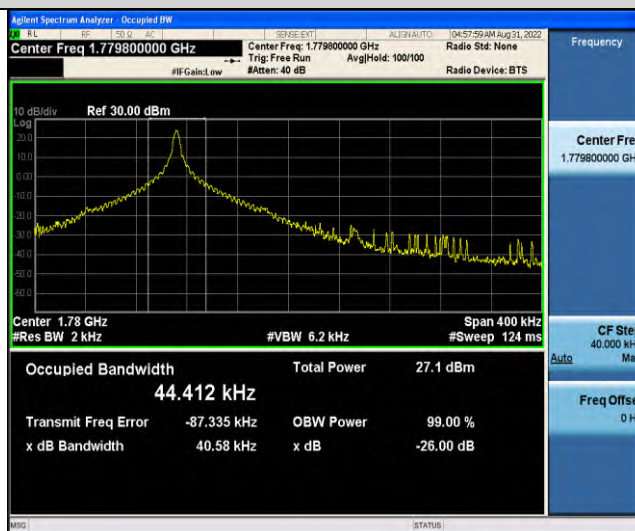

Band66-Stand-Alone-NaN-BPSK-132670-1 @ 0-3.75kHz-0.0406-PASS

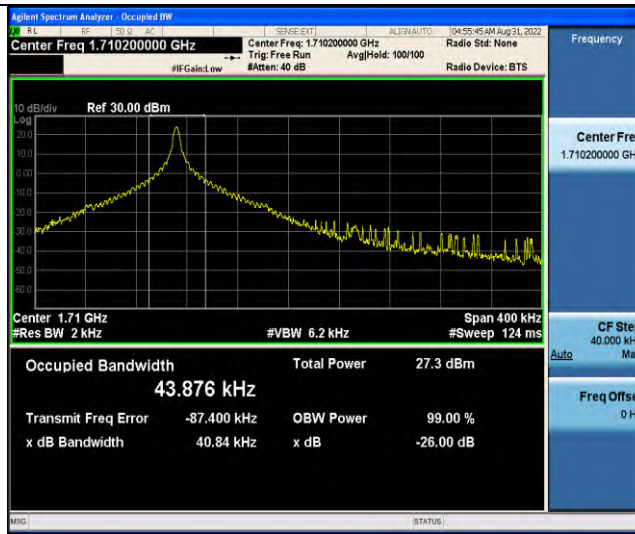

Band66-Stand-Alone-NaN-QPSK-131974-1 @ 0-3.75kHz-0.0408-PASS

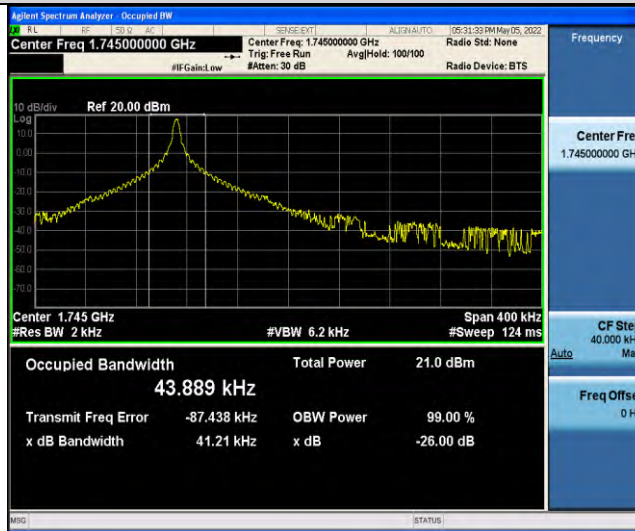

Band66-Stand-Alone-NaN-QPSK-132322-1 @ 0-3.75kHz-0.0412-PASS

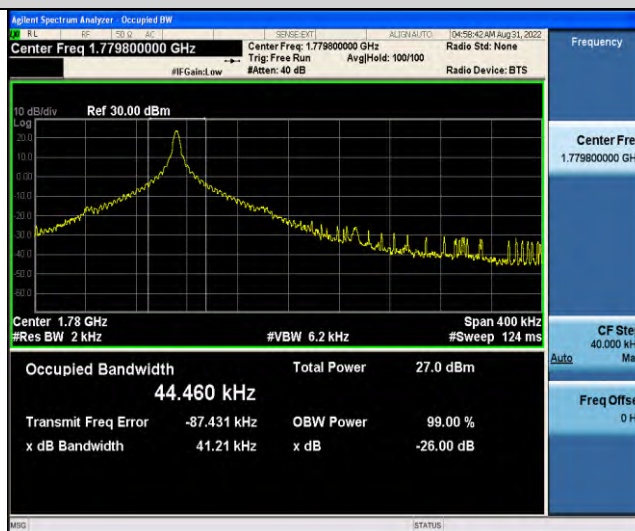

Band66-Stand-Alone-NaN-QPSK-132670-1 @ 0-3.75kHz-0.0412-PASS

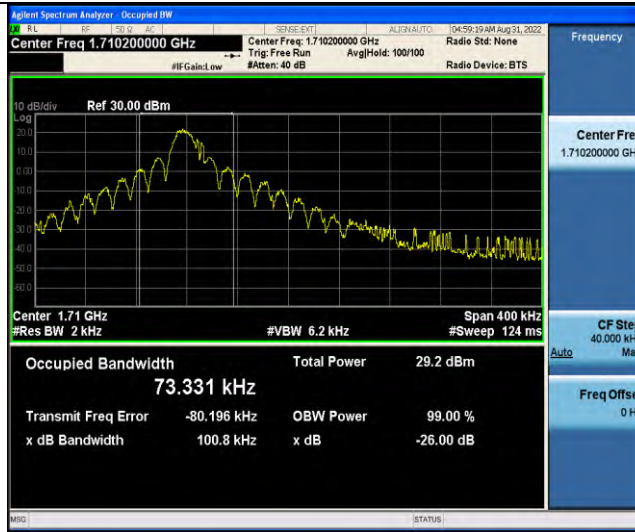

Band66-Stand-Alone-NaN-BPSK-131974-1@0-15kHz-0.1008-PASS



Band66-Stand-Alone-NaN-BPSK-131974-12@0-15kHz-0.2393-PASS



Band66-Stand-Alone-NaN-BPSK-132322-1@0-15kHz-0.0886-PASS

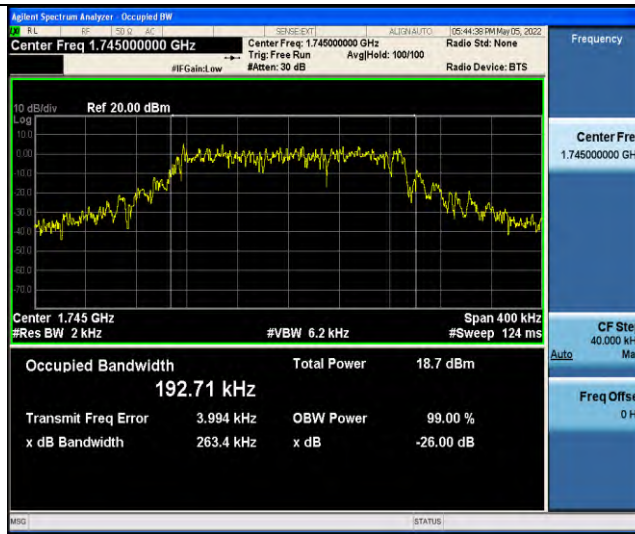

Band66-Stand-Alone-NaN-BPSK-132322-12@0-15kHz-0.2634-PASS

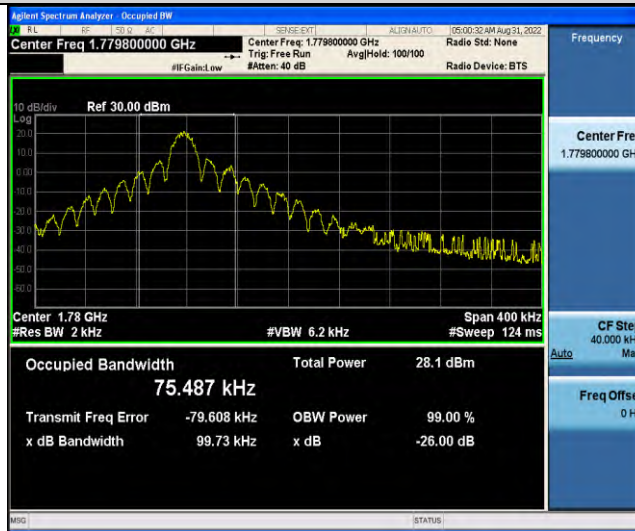

Band66-Stand-Alone-NaN-BPSK-132670-1@0-15kHz-0.0997-PASS

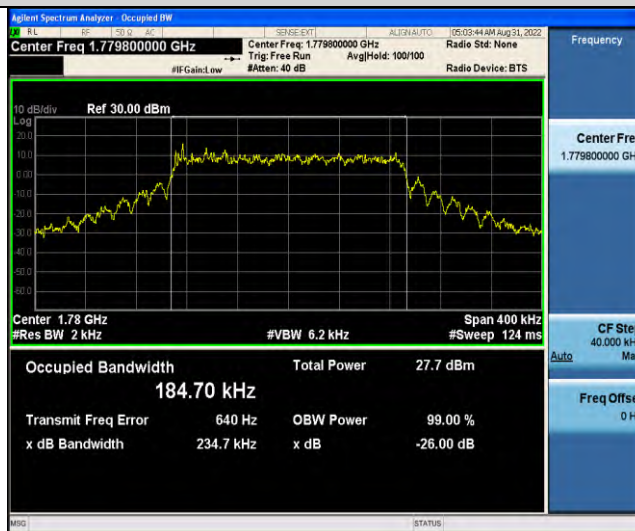

Band66-Stand-Alone-NaN-BPSK-132670-12@0-15kHz-0.2347-PASS

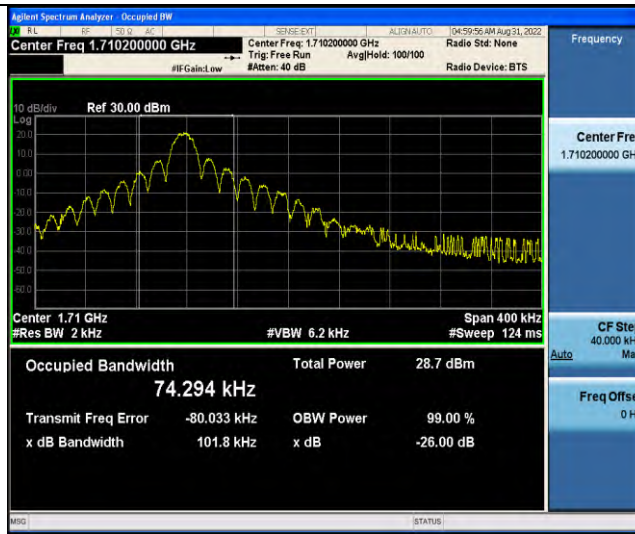

Band66-Stand-Alone-NaN-QPSK-131974-1@0-15kHz-0.1018-PASS

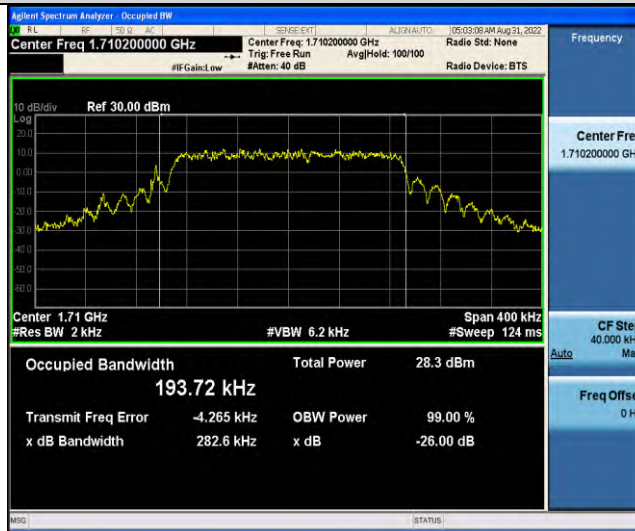

Band66-Stand-Alone-NaN-QPSK-131974-12@0-15kHz-0.2826-PASS



Band66-Stand-Alone-NaN-QPSK-132322-1@0-15kHz-0.1035-PASS

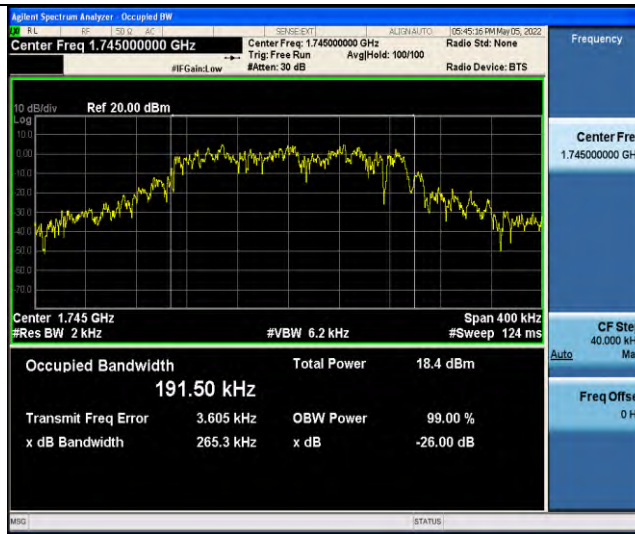

Band66-Stand-Alone-NaN-QPSK-132322-12@0-15kHz-0.2653-PASS

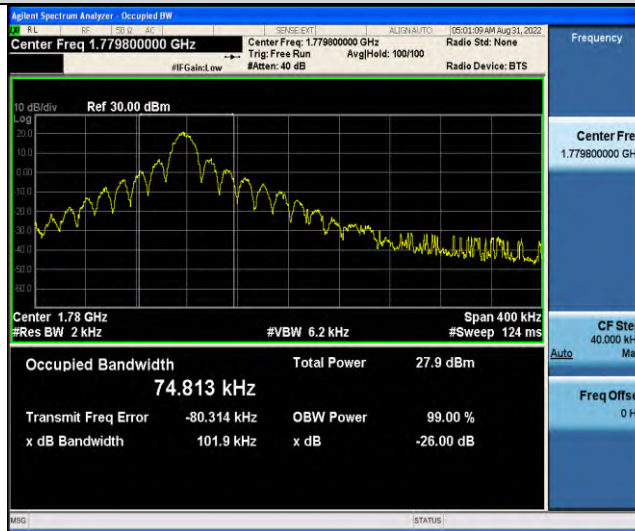

Band66-Stand-Alone-NaN-QPSK-132670-1@0-15kHz-0.1019-PASS



Band66-Stand-Alone-NaN-QPSK-132670-12@0-15kHz-0.2393-PASS



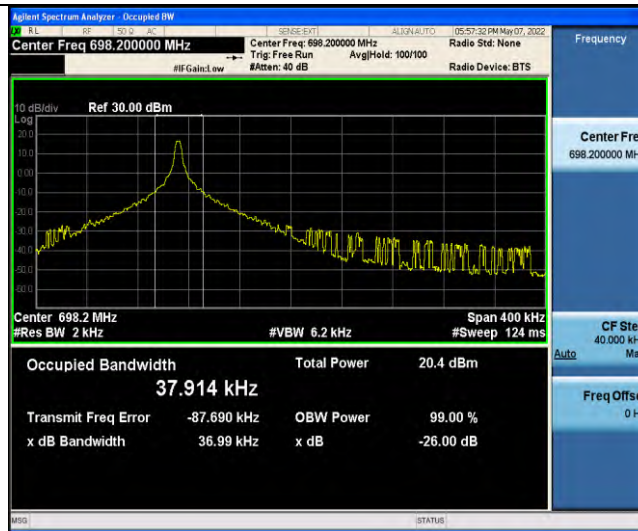

Band85-Stand-Alone-NaN-BPSK-134004-1 @0-3.75kHz-0.0370-PASS

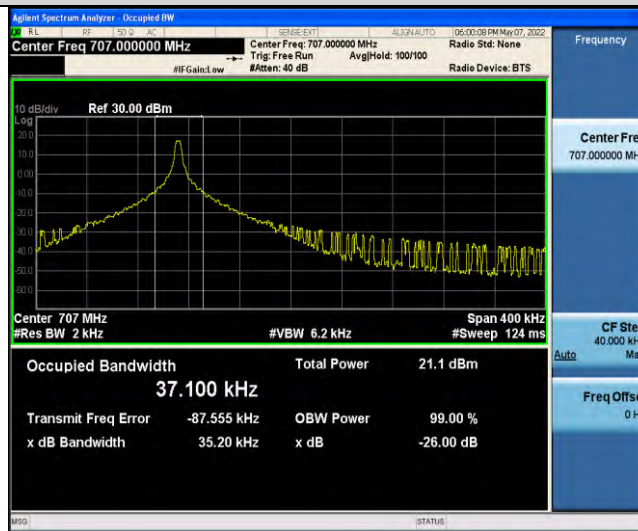

Band85-Stand-Alone-NaN-BPSK-134092-1 @0-3.75kHz-0.0352-PASS

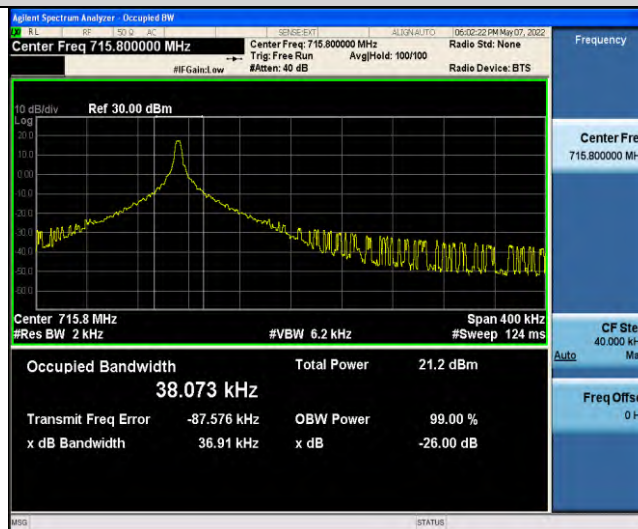

Band85-Stand-Alone-NaN-BPSK-134180-1 @0-3.75kHz-0.0369-PASS

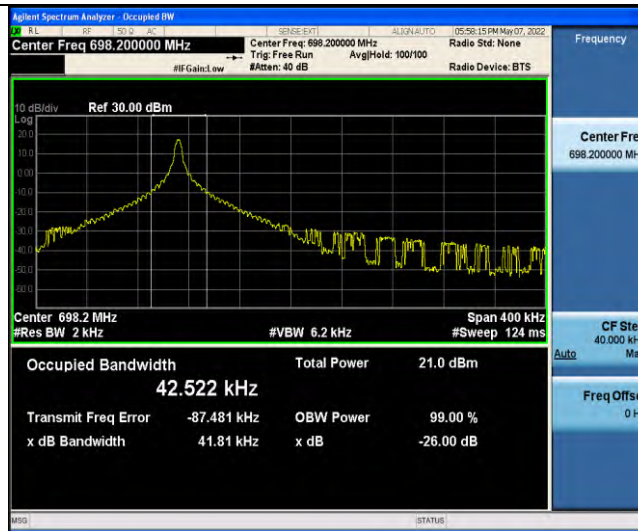

Band85-Stand-Alone-NaN-QPSK-134004-1 @0-3.75kHz-0.0418-PASS

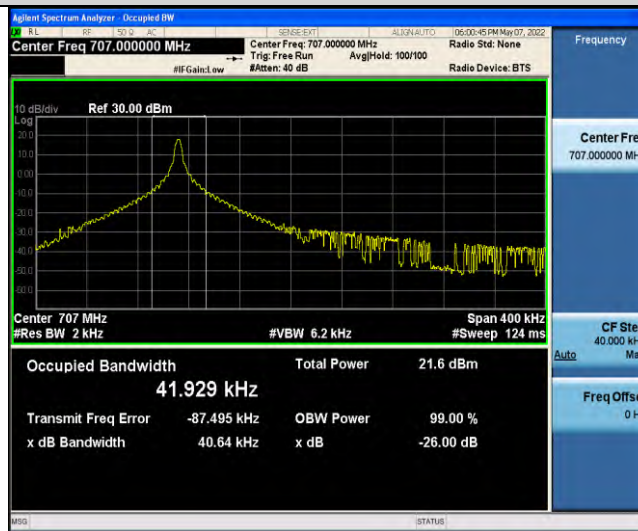

Band85-Stand-Alone-NaN-QPSK-134092-1 @0-3.75kHz-0.0406-PASS

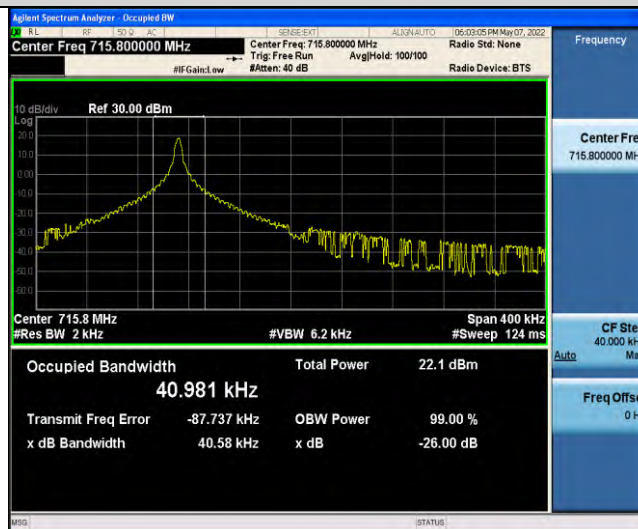

Band85-Stand-Alone-NaN-QPSK-134180-1 @0-3.75kHz-0.0406-PASS

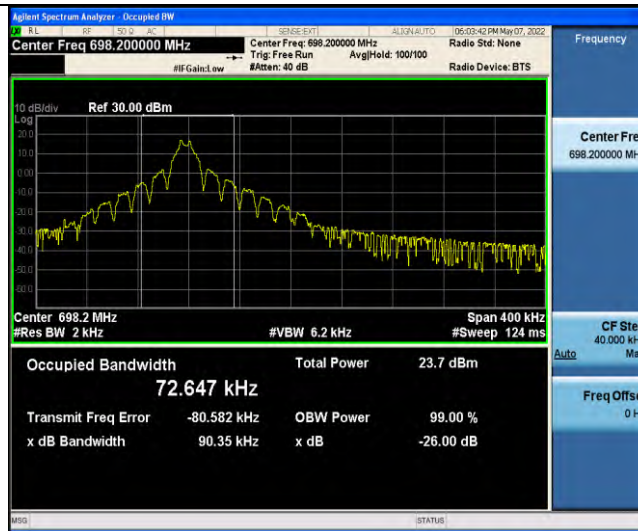

Band85-Stand-Alone-NaN-BPSK-134004-1 @0-15kHz-0.0904-PASS

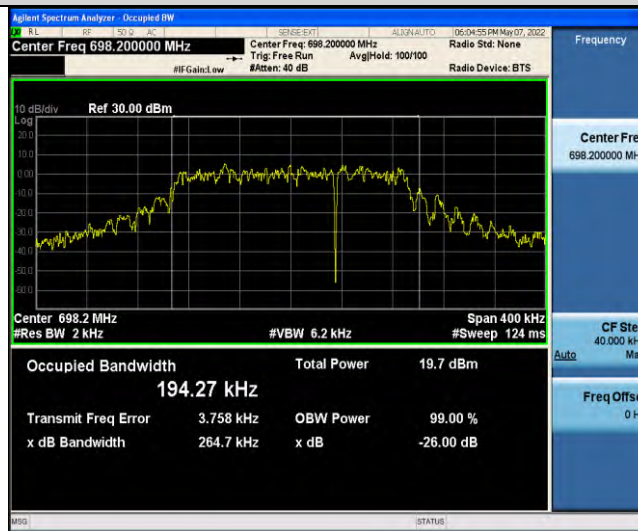

Band85-Stand-Alone-NaN-BPSK-134004-12 @0-15kHz-0.2647-PASS

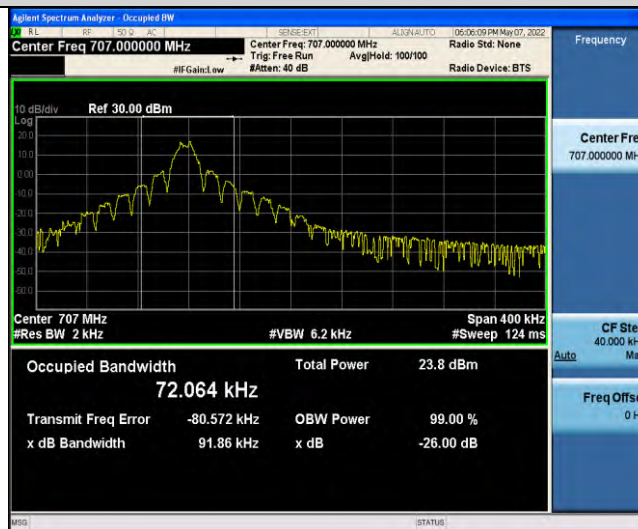

Band85-Stand-Alone-NaN-BPSK-134092-1 @0-15kHz-0.0919-PASS

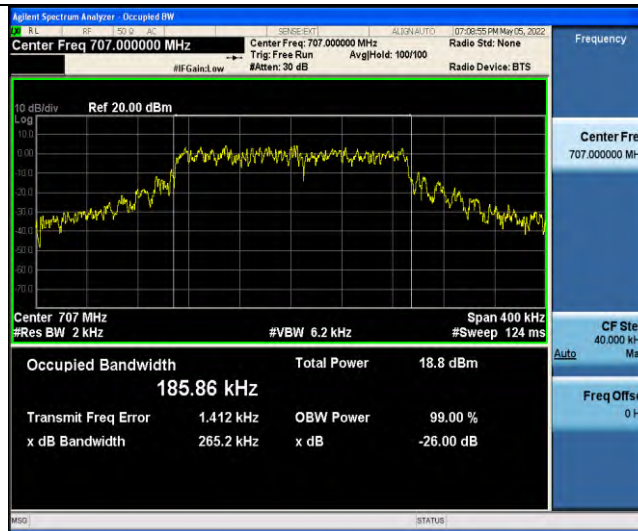

Band85-Stand-Alone-NaN-BPSK-134092-12@0-15kHz-0.2652-PASS

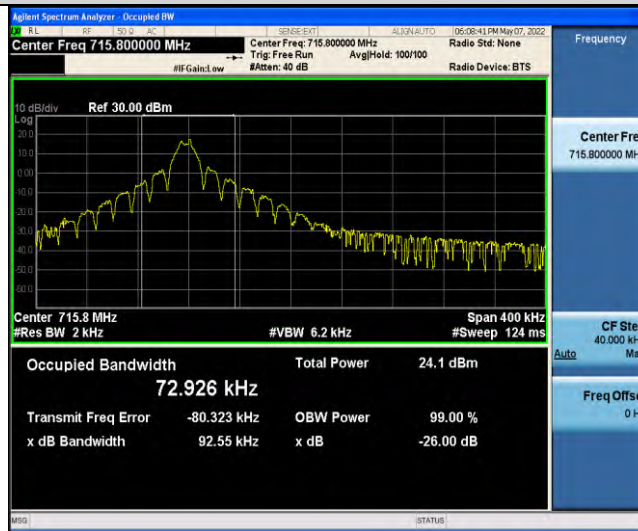

Band85-Stand-Alone-NaN-BPSK-134180-1@0-15kHz-0.0926-PASS

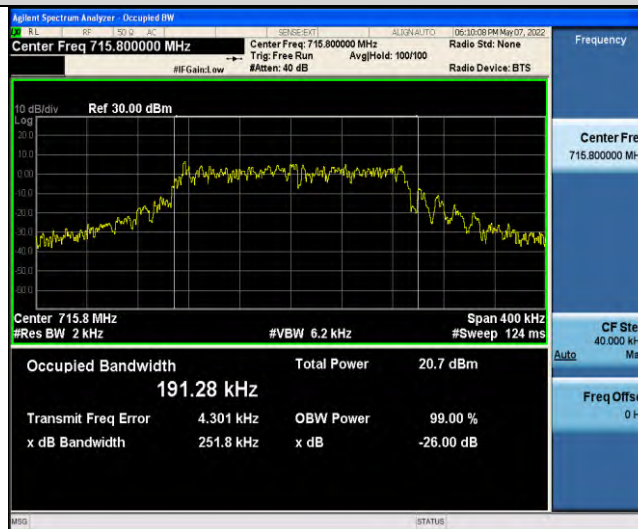

Band85-Stand-Alone-NaN-BPSK-134180-12@0-15kHz-0.2518-PASS



Band85-Stand-Alone-NaN-QPSK-134004-1 @ 0-15kHz-0.0894-PASS

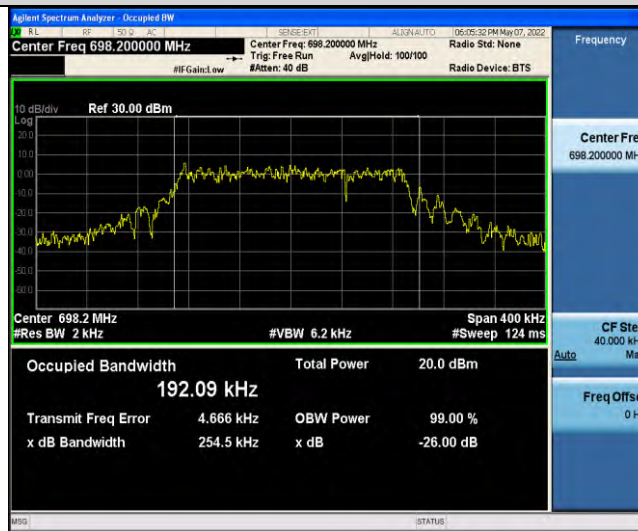

Band85-Stand-Alone-NaN-QPSK-134004-12 @ 0-15kHz-0.2545-PASS

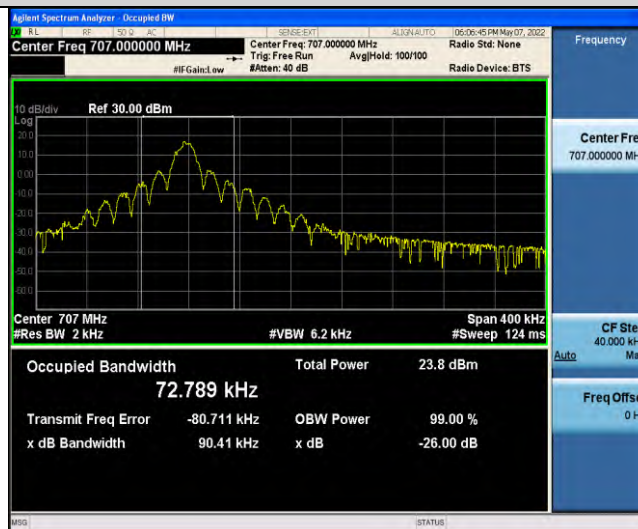

Band85-Stand-Alone-NaN-QPSK-134092-1 @ 0-15kHz-0.0904-PASS

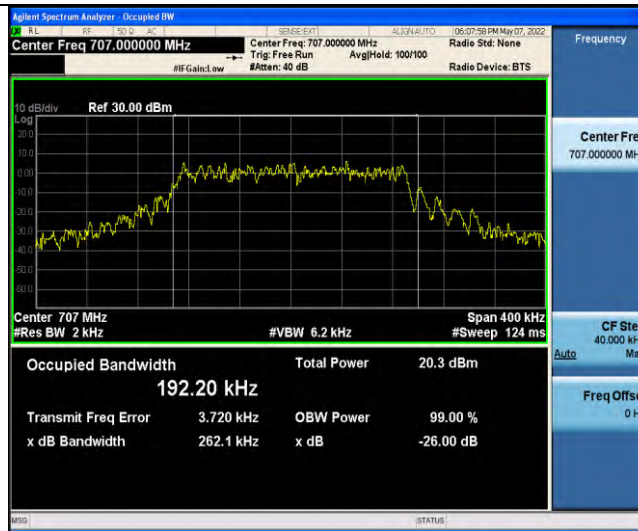

Band85-Stand-Alone-NaN-QPSK-134092-12@0-15kHz-0.2621-PASS

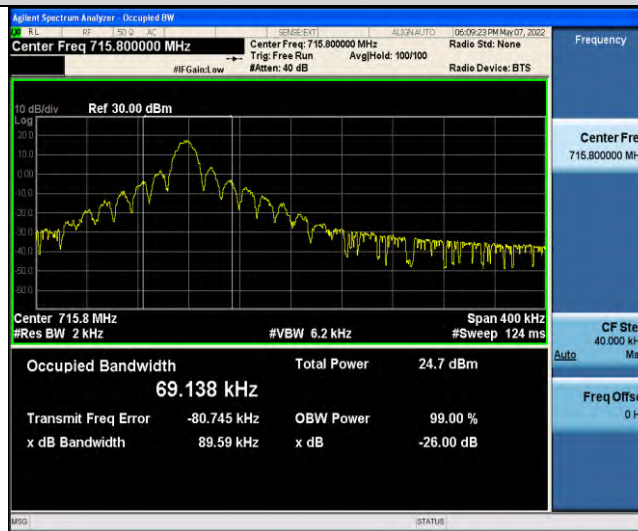

Band85-Stand-Alone-NaN-QPSK-134180-1@0-15kHz-0.0896-PASS

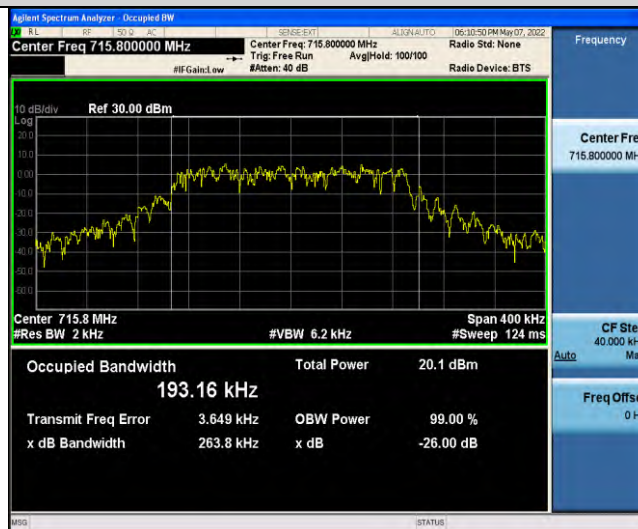

Band85-Stand-Alone-NaN-QPSK-134180-12@0-15kHz-0.2638-PASS

<b>4.5 Spurious Emissions at antenna terminals</b>	<b>VERDICT: PASS</b>
--	----------------------

4.5.1 Limit	
NB-IoT Band	Standard
5/18/19/26	FCC §2.1051: The radio frequency voltage or powers generated within the equipment and appearing on a spurious frequency shall be checked at the equipment output terminals when properly loaded with a suitable artificial antenna.
	FCC §22.917: The power of any emission outside of the authorized operating frequency ranges must be attenuated below the transmitting power (P) by a factor of at least 43 + 10 log(P) dB.
	FCC §90.691: For any frequency removed from the EA licensee's frequency block greater than 37.5 kHz, the power of any emission shall be attenuated below the transmitter power (P) in watts by at least 43 + 10Log <sub>10</sub> (P) decibels or 80 decibels, whichever is the lesser attenuation, where f is the frequency removed from the center of the outer channel in the block in kilohertz and where f is greater than 37.5 kHz.
2/25	FCC §2.1051: The radio frequency voltage or powers generated within the equipment and appearing on a spurious frequency shall be checked at the equipment output terminals when properly loaded with a suitable artificial antenna.
	FCC §24.238: The power of any emission outside of the authorized operating frequency ranges must be attenuated below the transmitting power (P) by a factor of at least 43 + 10 log(P) dB.
12/13/17 /85	FCC §2.1051: The radio frequency voltage or powers generated within the equipment and appearing on a spurious frequency shall be checked at the equipment output terminals when properly loaded with a suitable artificial antenna.
	FCC §27.53(g): For operations in the 600 MHz band and the 698-746 MHz band, the power of any emission outside a licensee's frequency band(s) of operation shall be attenuated below the transmitter power (P) within the licensed band(s) of operation, measured in watts, by at least 43 + 10 log (P) dB. Compliance with this provision is based on the use of measurement instrumentation employing a resolution bandwidth of 100 kilohertz or greater. However, in the 100 kilohertz bands immediately outside and adjacent to a licensee's frequency block, a resolution bandwidth of at least 30 kHz may be employed.
	FCC §27.53(c): On any frequency outside the 776-788 MHz band, the power of any emission shall be attenuated outside the band below the transmitter power (P) by at least 43 + 10 log (P) dB. On all frequencies between 763-775 MHz and 793-805 MHz, by a factor not less than 65 + 10 log (P) dB in a 6.25 kHz band segment, for mobile and portable stations.
4/66	FCC §2.1051: The radio frequency voltage or powers generated within the equipment and appearing on a spurious frequency shall be checked at the equipment output terminals when properly loaded with a suitable artificial antenna.
	FCC §27.53(h): The power of any emission outside a licensee's frequency block shall be attenuated below the transmitter power (P) in watts by at least 43 + 10 log <sub>10</sub> (P) dB.

#### 4.5.2 Test Setup

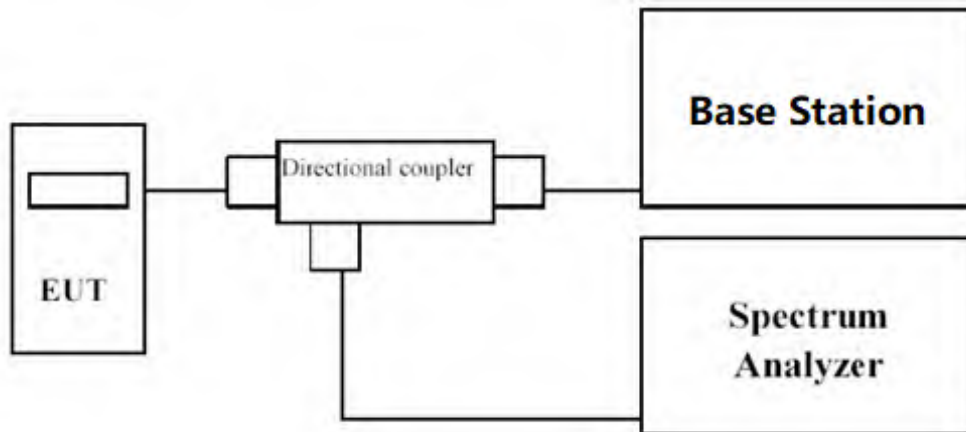

#### 4.5.3 Test Procedure

References Rule	Chapter	Description
<input checked="" type="checkbox"/> ANSI C63.26	5.7	Unwanted (out-of-band and spurious) conducted emissions measurement procedures (conducted test at antenna port)

The EUT RF output connector was connected to a spectrum analyser and to the Universal Radio Communication tester R&S CMW500 (selecting maximum transmission power of the EUT and different modes of modulation) using directional coupler.

The spectrum was investigated from 9 kHz to the 10th harmonic of the highest frequency generated within the equipment.

The reading of the spectrum analyser is corrected with the attenuation loss of connection between output terminal of EUT and input of the spectrum analyser.

According to specification, the power of emissions shall be attenuated below the transmitter power (P) by a factor of at least  $X + 10 \log (P)$  dB. P in watts. The specification can be interpreted as an absolute limit when the specified attenuation is actually subtracted from the maximum permissible transmitter power [i.e.,  $10 \log P - \{X + 10 \log P\}$ ], resulting in an absolute level of -X dBW [or (-X + 30) dBm].

The configuration of tones and modulation which is the worst case for conducted power was used.



### 4.5.4 Test Data

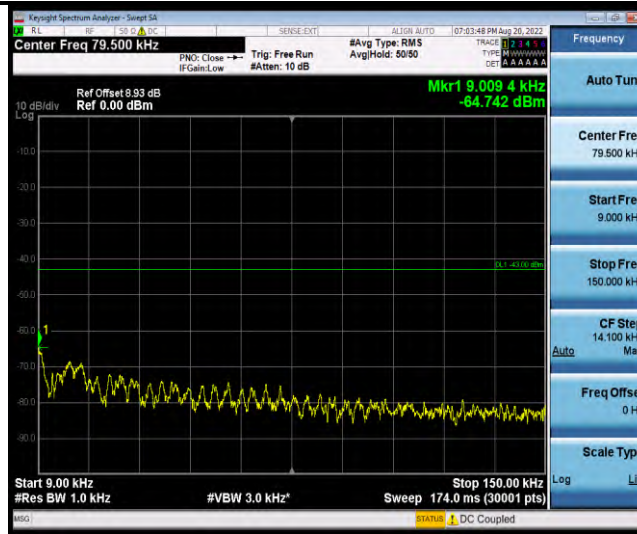

Band2-Stand-Alone-NaN-QPSK-18602-1 @0-3.75kHz-0.009-0.15-0.009~0.15MHz @-64.74dBm--43-PASS

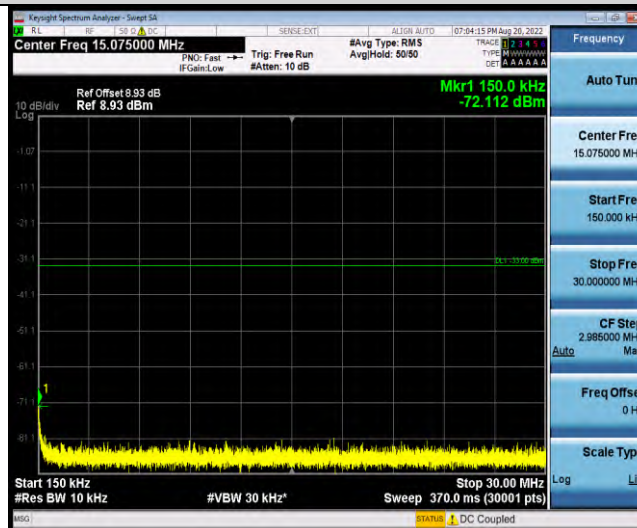

Band2-Stand-Alone-NaN-QPSK-18602-1 @0-3.75kHz-0.15-30-0.15~30MHz @-72.11dBm--33-PASS

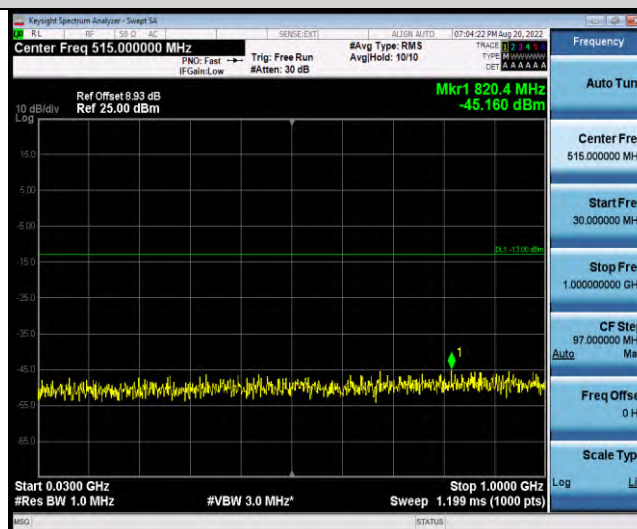

Band2-Stand-Alone-NaN-QPSK-18602-1 @0-3.75kHz-30-1000-30~1000MHz @-45.16dBm--13-PASS

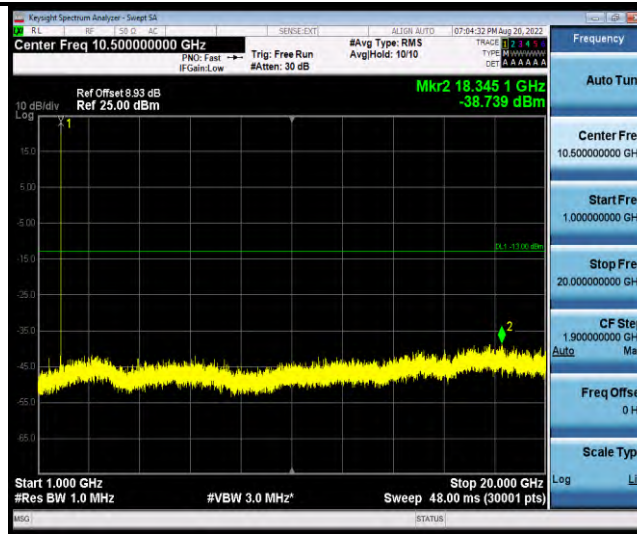

Band2-Stand-Alone-NaN-QPSK-18602-1 @0-3.75kHz-1000-20000-1000~20000MHz @-38.74dBm--13-PASS

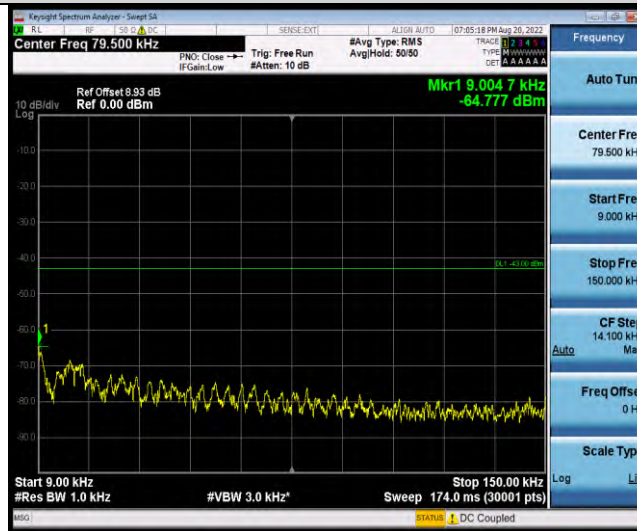

Band2-Stand-Alone-NaN-QPSK-18602-1 @47-3.75kHz-0.009-0.15-0.009~0.15MHz @-64.78dBm--43-PASS

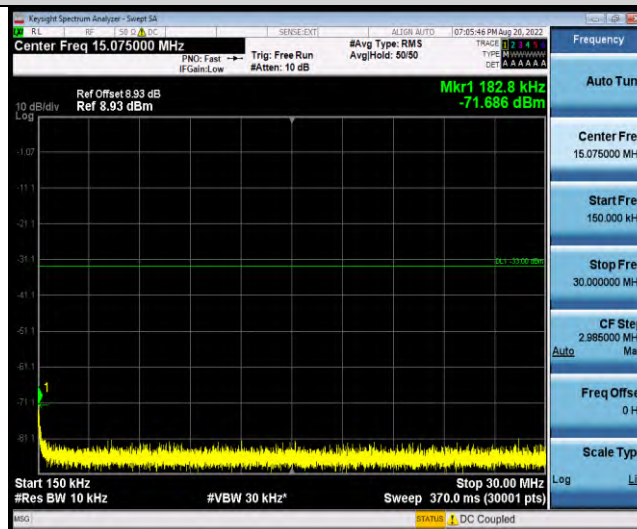

Band2-Stand-Alone-NaN-QPSK-18602-1 @47-3.75kHz-0.15-30-0.15~30MHz @-71.69dBm--33-PASS

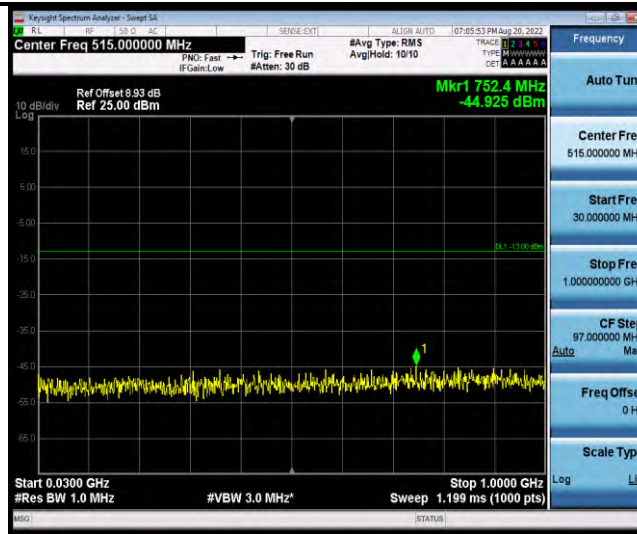

Band2-Stand-Alone-NaN-QPSK-18602-1 @ 47-3.75kHz-30-1000-30~1000MHz @ -44.93dBm--13-PASS

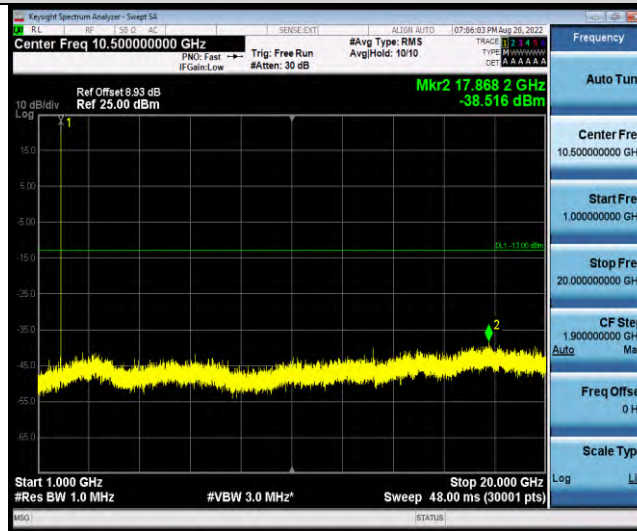

Band2-Stand-Alone-NaN-QPSK-18602-1 @ 47-3.75kHz-1000-20000-1000~2000MHz @ -38.52dBm--13-PASS

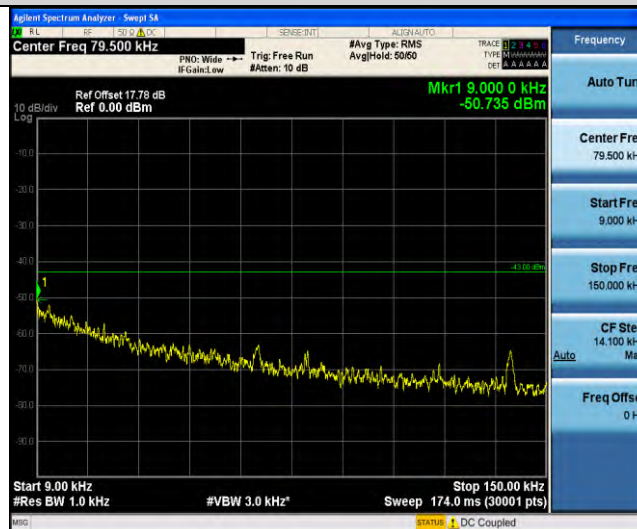

Band2-Stand-Alone-NaN-QPSK-18876-1 @ 0-3.75kHz-0.009-0.15-0.009~0.15MHz @ -50.74dBm--43-PASS

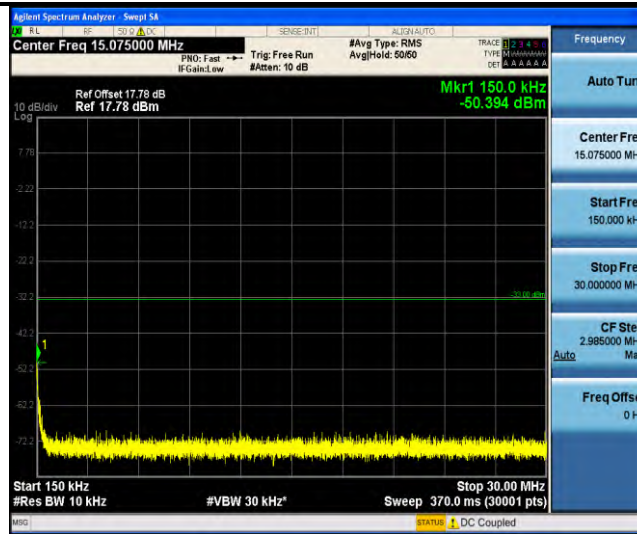

Band2-Stand-Alone-NaN-QPSK-18876-1 @0-3.75kHz-0.15-30-0.15~30MHz@-50.39dBm--33-PASS

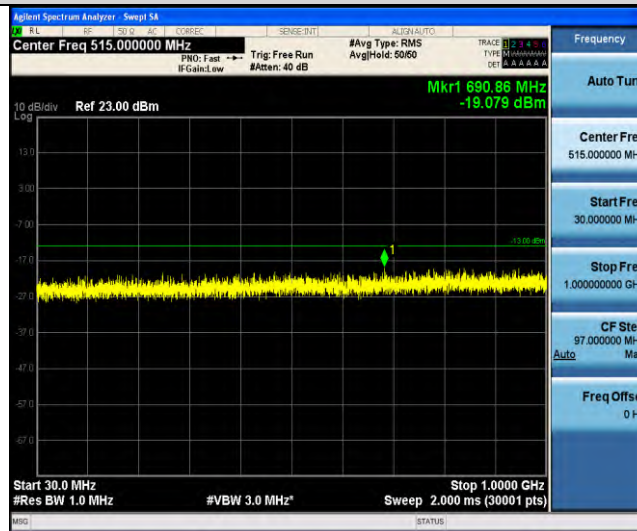

Band2-Stand-Alone-NaN-QPSK-18876-1 @0-3.75kHz-30-1000-30~1000MHz@-19.08dBm--13-PASS

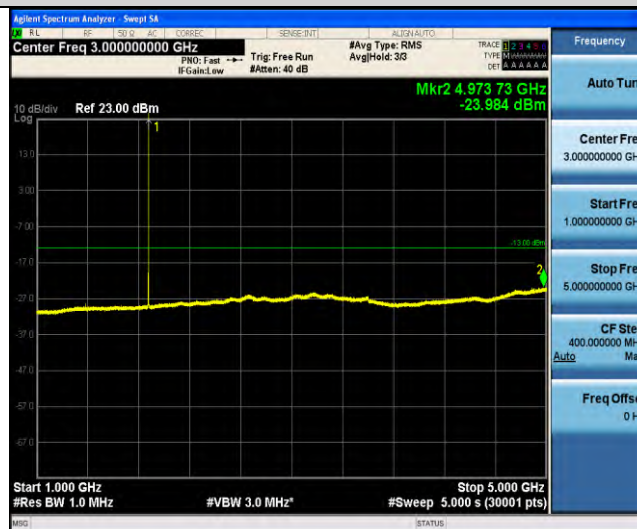

Band2-Stand-Alone-NaN-QPSK-18876-1 @0-3.75kHz-1000-5000-1000~5000MHz@-23.98dBm--13-PASS



Band2-Stand-Alone-NaN-QPSK-18876-1 @0-3.75kHz-5000-12000-5000~12000MHz @ -43.96dBm--13-PASS



Band2-Stand-Alone-NaN-QPSK-18876-1 @0-3.75kHz-12000-26500-12000~26500MHz @ -31.01dBm--13-PASS

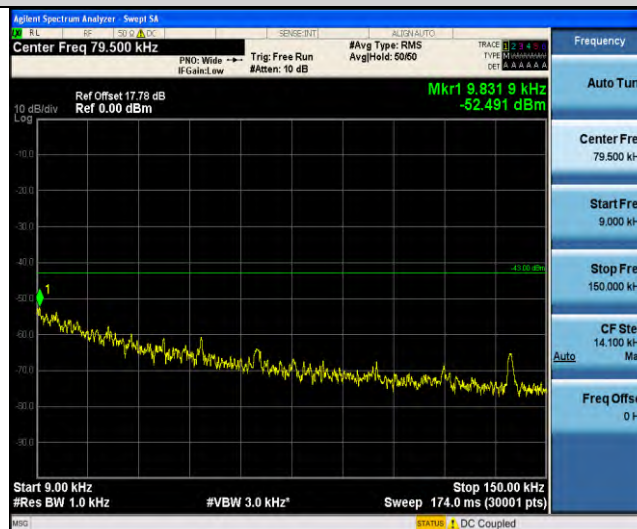

Band2-Stand-Alone-NaN-QPSK-18876-1 @47-3.75kHz-0.009-0.15-0.009~0.15MHz @ -52.49dBm--43-PASS

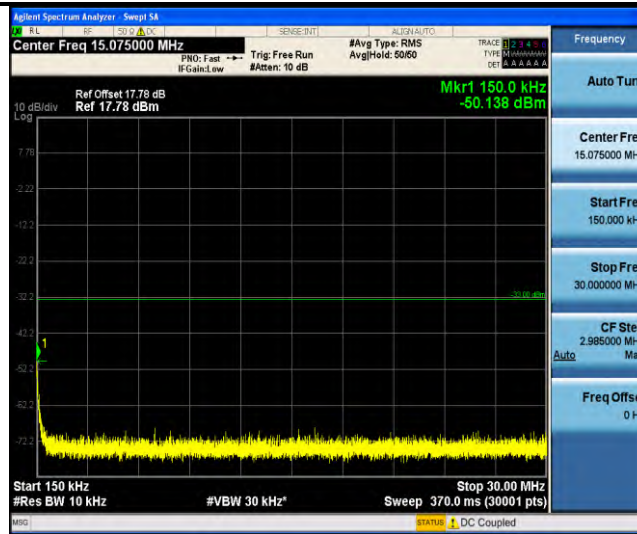

Band2-Stand-Alone-Na-N-QPSK-18876-1 @ 47-3.75kHz-0.15-30-0.15~30MHz @ -50.14dBm--33-PASS

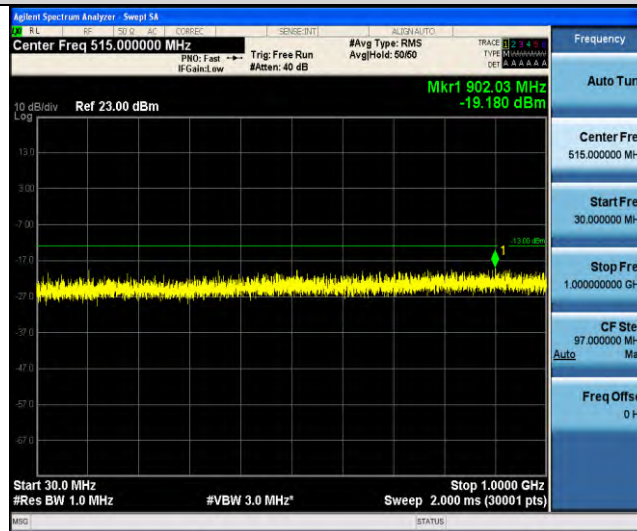

Band2-Stand-Alone-Na-N-QPSK-18876-1 @ 47-3.75kHz-30-1000-30~1000MHz @ -19.18dBm--13-PASS

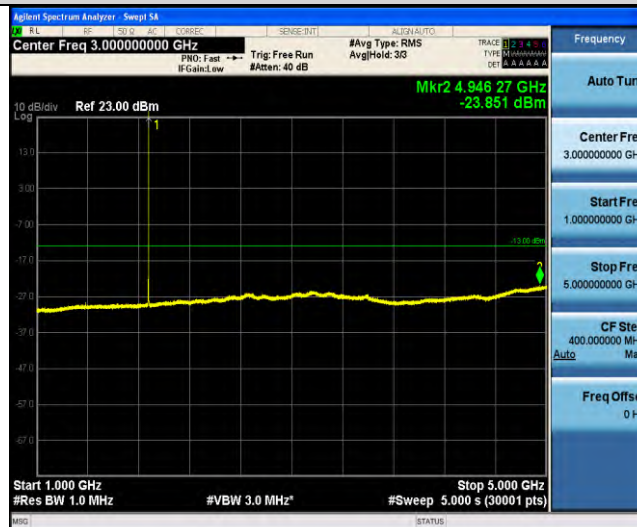

Band2-Stand-Alone-Na-N-QPSK-18876-1 @ 47-3.75kHz-1000-5000-1000~5000MHz @ -23.85dBm--13-PASS



Band2-Stand-Alone-NaN-QPSK-18876-1 @47-3.75kHz-5000-12000-5000~12000MHz@-42.36dBm--13-PASS



Band2-Stand-Alone-NaN-QPSK-18876-1 @47-3.75kHz-12000-26500-12000~26500MHz@-30.96dBm--13-PASS



Band2-Stand-Alone-NaN-QPSK-19198-1 @0-3.75kHz-0.009-0.15-0.009~0.15MHz@-65.87dBm--43-PASS

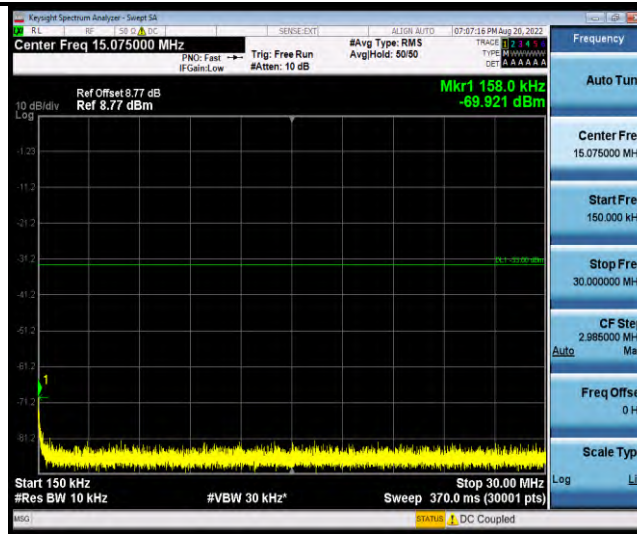

Band2-Stand-Alone-NaN-QPSK-19198-1 @0-3.75kHz-0.15-30-0.15~30MHz @ -69.92dBm--33-PASS

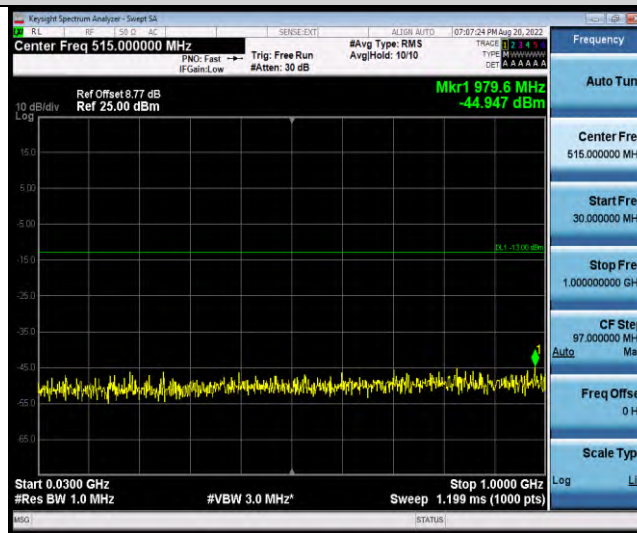

Band2-Stand-Alone-NaN-QPSK-19198-1 @0-3.75kHz-30-1000-30~1000MHz @ -44.95dBm--13-PASS

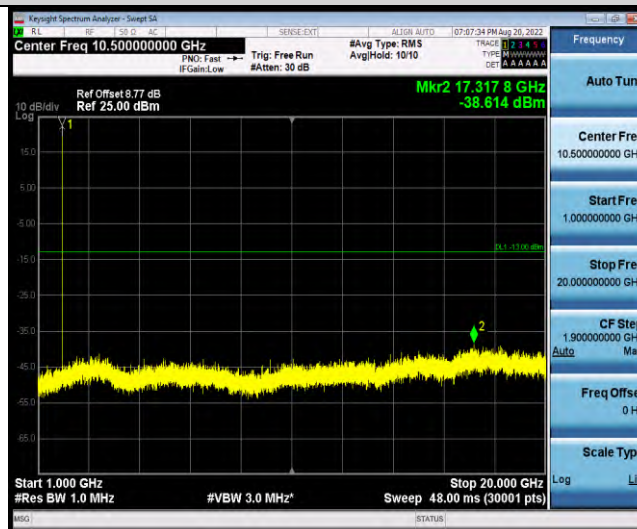

Band2-Stand-Alone-NaN-QPSK-19198-1 @0-3.75kHz-1000-20000-1000~20000MHz @ -38.61dBm--13-PASS



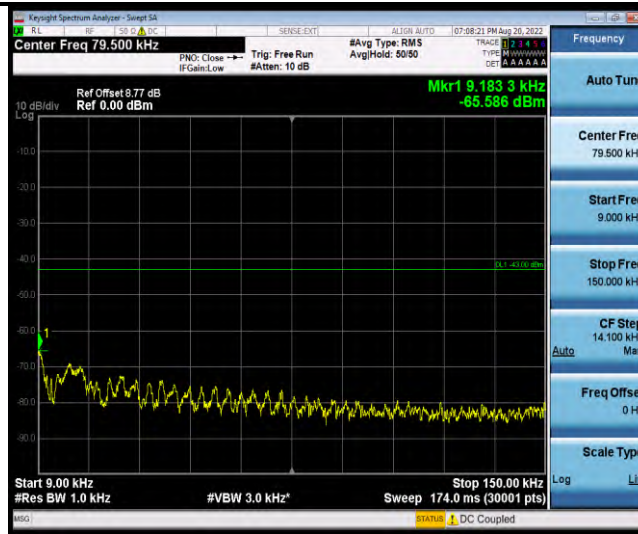

Band2-Stand-Alone-NaN-QPSK-19198-1 @ 47-3.75kHz-0.009-0.15-0.009~0.15MHz @ -65.59dBm--43-PASS

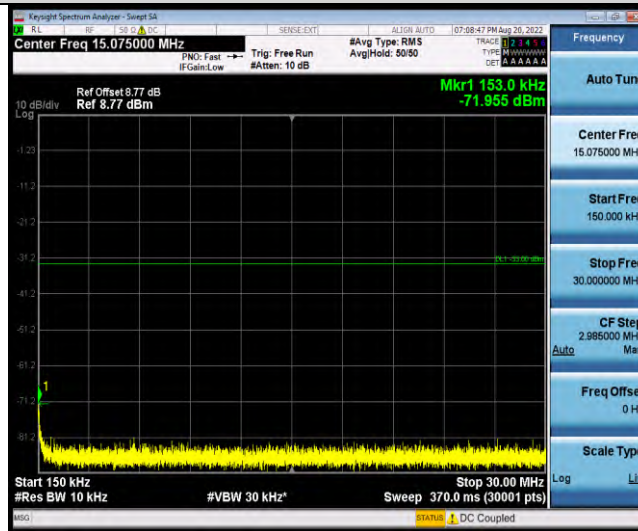

Band2-Stand-Alone-NaN-QPSK-19198-1 @ 47-3.75kHz-0.15-30-0.15~30MHz @ -71.96dBm--33-PASS

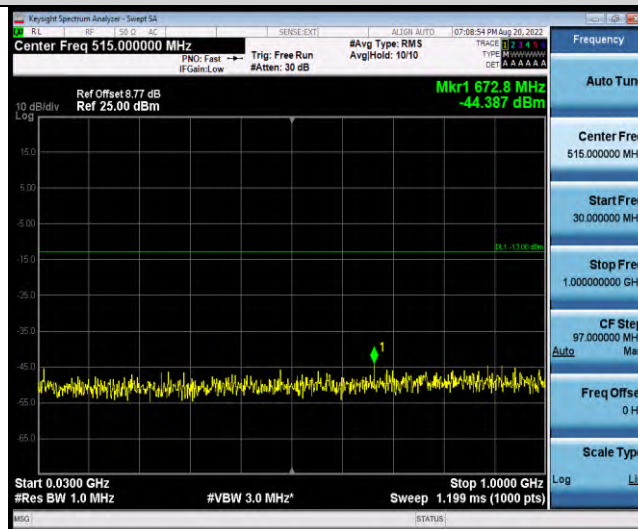

Band2-Stand-Alone-NaN-QPSK-19198-1 @ 47-3.75kHz-30-1000-30~1000MHz @ -44.39dBm--13-PASS

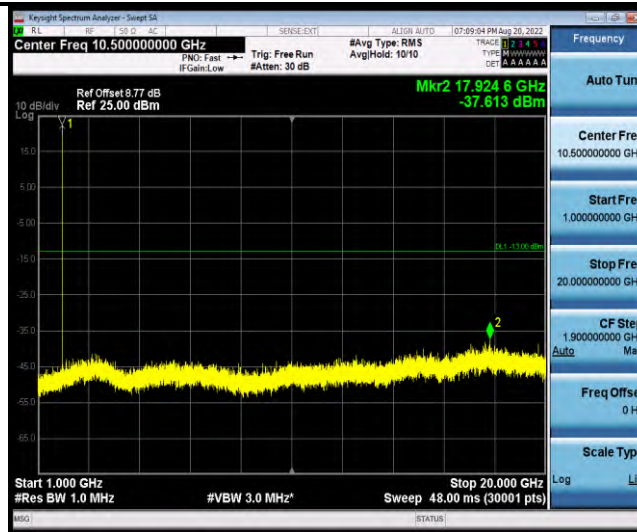

Band2-Stand-Alone-NaN-QPSK-19198-1 @47-3.75kHz-1000-20000-1000~2000MHz @-37.61dBm--13-PASS



Band2-Stand-Alone-NaN-BPSK-18602-1 @0-15kHz-0.009-0.15-0.009~0.15MHz @-64.24dBm--43-PASS



Band2-Stand-Alone-NaN-BPSK-18602-1 @0-15kHz-0.15-30-0.15~30MHz @-71.14dBm--33-PASS

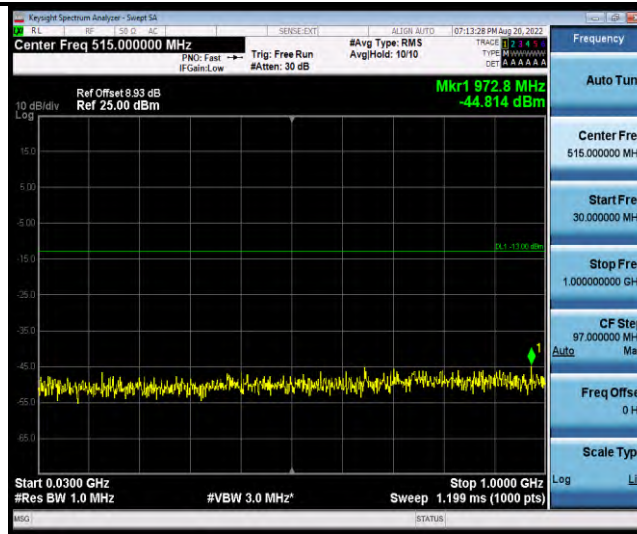

Band2-Stand-Alone-NaN-BPSK-18602-1 @0-15kHz-30-1000-30~1000MHz @-44.81dBm--13-PASS

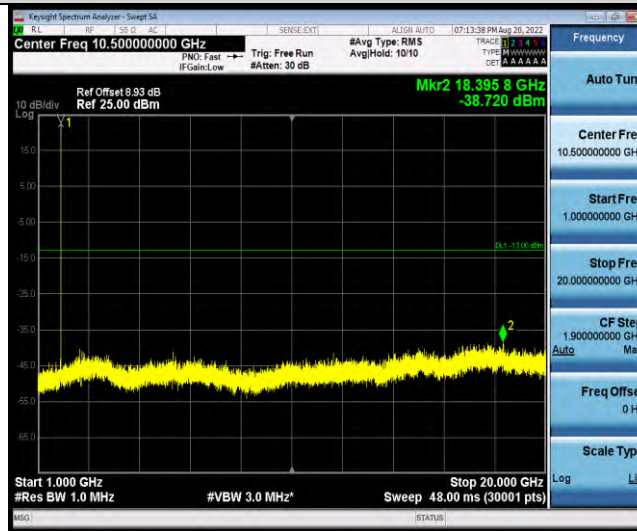

Band2-Stand-Alone-NaN-BPSK-18602-1 @0-15kHz-1000-20000-1000~20000MHz @-38.72dBm--13-PASS



Band2-Stand-Alone-NaN-BPSK-18602-1 @11-15kHz-0.009-0.15-0.009~0.15MHz @-63.92dBm--43-PASS

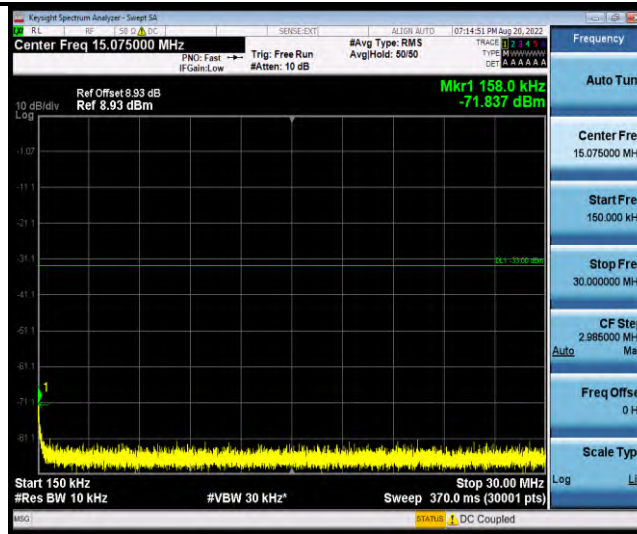

Band2-Stand-Alone-NaN-BPSK-18602-1 @ 11-15kHz-0.15-30-0.15~30MHz @ -71.84dBm--33-PASS

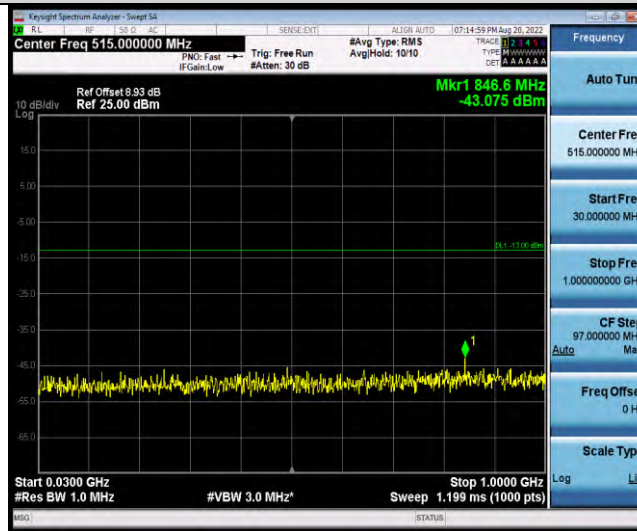

Band2-Stand-Alone-NaN-BPSK-18602-1 @ 11-15kHz-30-1000-30~1000MHz @ -43.08dBm--13-PASS

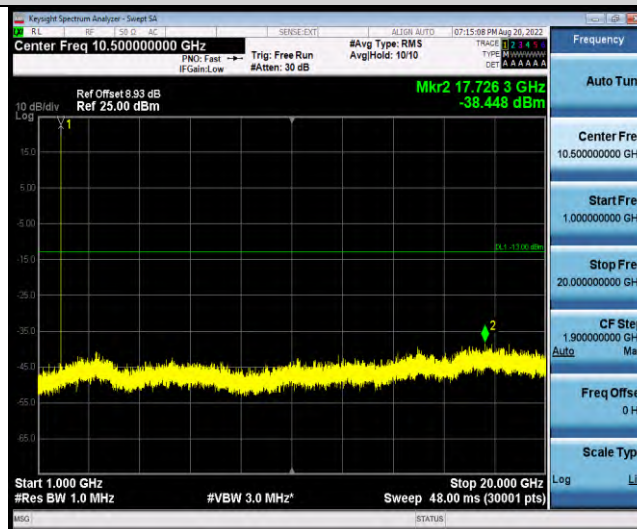

Band2-Stand-Alone-NaN-BPSK-18602-1 @ 11-15kHz-1000-20000-1000~20000MHz @ -38.45dBm--13-PASS



Band2-Stand-Alone-NaN-BPSK-18876-1@0-15kHz-0.009-0.15-0.009~0.15MHz@-50.9dBm--43-PASS



Band2-Stand-Alone-NaN-BPSK-18876-1@0-15kHz-0.15-30-0.15~30MHz@-49.99dBm--33-PASS

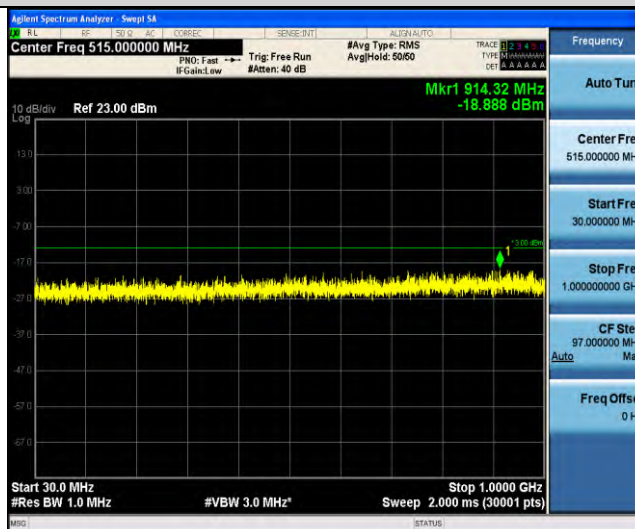

Band2-Stand-Alone-NaN-BPSK-18876-1@0-15kHz-30-1000-30~1000MHz@-18.89dBm--13-PASS



Band2-Stand-Alone-NaN-BPSK-18876-1 @0-15kHz-1000-5000-1000~5000MHz @ -23.85dBm--13-PASS



Band2-Stand-Alone-NaN-BPSK-18876-1 @0-15kHz-5000-12000-5000~12000MHz @ -43.01dBm--13-PASS



Band2-Stand-Alone-NaN-BPSK-18876-1 @0-15kHz-12000-26500-12000~26500MHz @ -30.89dBm--13-PASS



Band2-Stand-Alone-NaN-BPSK-18876-1 @ 11-15kHz-0.009-0.15-0.009~0.15MHz @ -52.24dBm--43-PASS



Band2-Stand-Alone-NaN-BPSK-18876-1 @ 11-15kHz-0.15-30-0.15~30MHz @ -52.09dBm--33-PASS

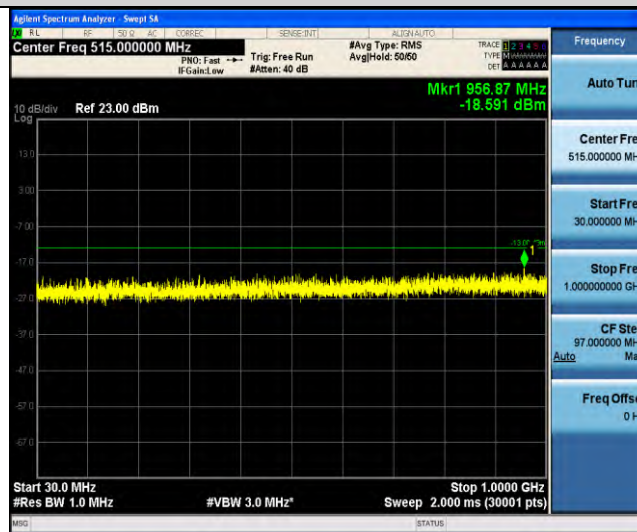

Band2-Stand-Alone-NaN-BPSK-18876-1 @ 11-15kHz-30-1000-30~1000MHz @ -18.59dBm--13-PASS



Band2-Stand-Alone-NaN-BPSK-18876-1 @ 11-15kHz-1000-5000-1000~5000MHz@ -23.79dBm--13-PASS



Band2-Stand-Alone-NaN-BPSK-18876-1 @ 11-15kHz-5000-12000-5000~12000MHz@ -43.87dBm--13-PASS



Band2-Stand-Alone-NaN-BPSK-18876-1 @ 11-15kHz-12000-26500-12000~26500MHz@ -30.97dBm--13-PASS





Band2-Stand-Alone-NaN-BPSK-19198-1 @0-15kHz-0.009-0.15-0.009~0.15MHz@-63.4dBm--43-PASS

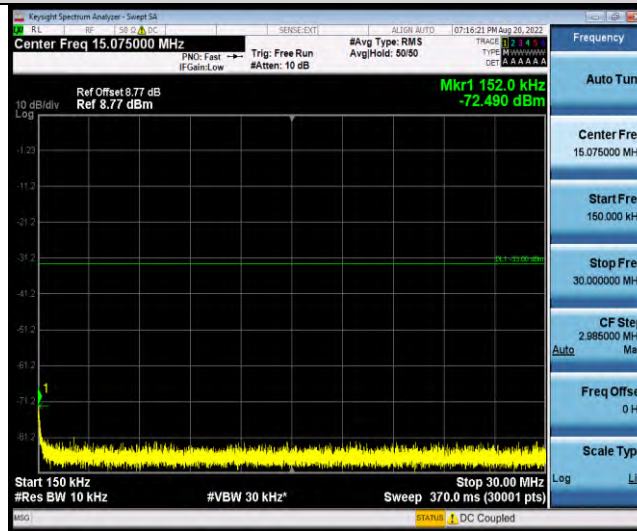

Band2-Stand-Alone-NaN-BPSK-19198-1 @0-15kHz-0.15-30-0.15~30MHz@-72.49dBm--33-PASS

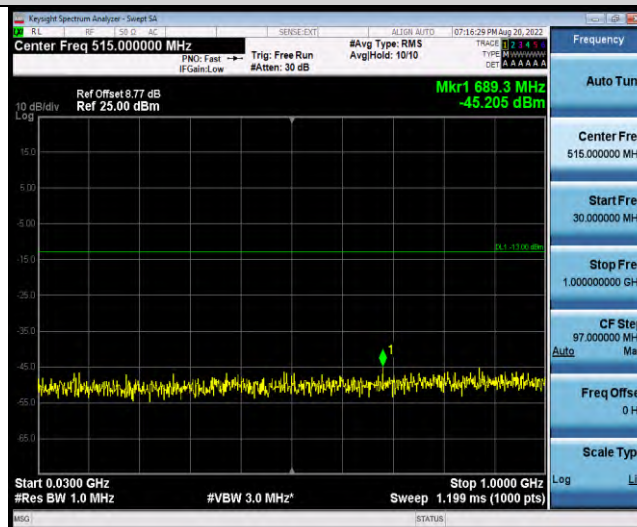

Band2-Stand-Alone-NaN-BPSK-19198-1 @0-15kHz-30-1000-30~1000MHz@-45.21dBm--13-PASS

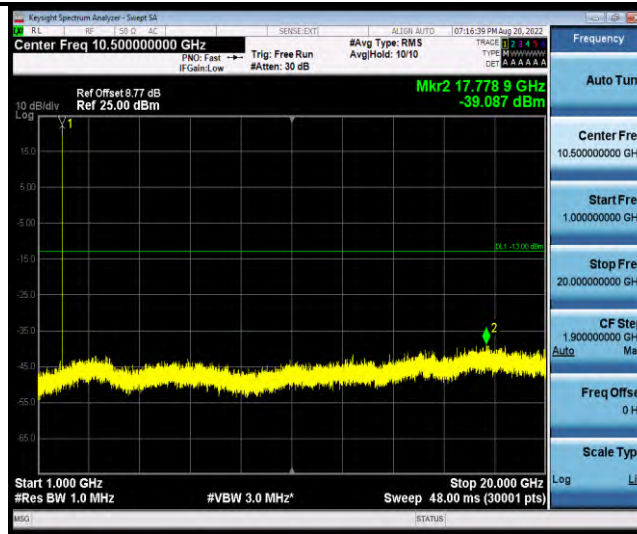

Band2-Stand-Alone-NaN-BPSK-19198-1 @ 0-15kHz-1000-20000-1000~20000MHz @ -39.09dBm--13-PASS

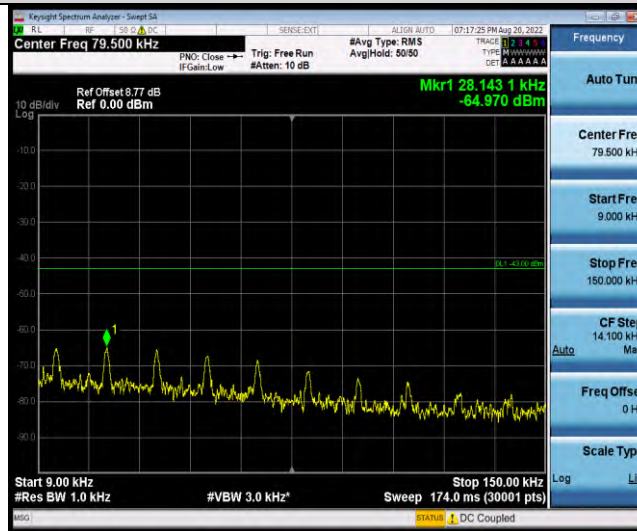

Band2-Stand-Alone-NaN-BPSK-19198-1 @ 11-15kHz-0.009-0.15-0.009~0.15MHz @ -64.97dBm--43-PASS

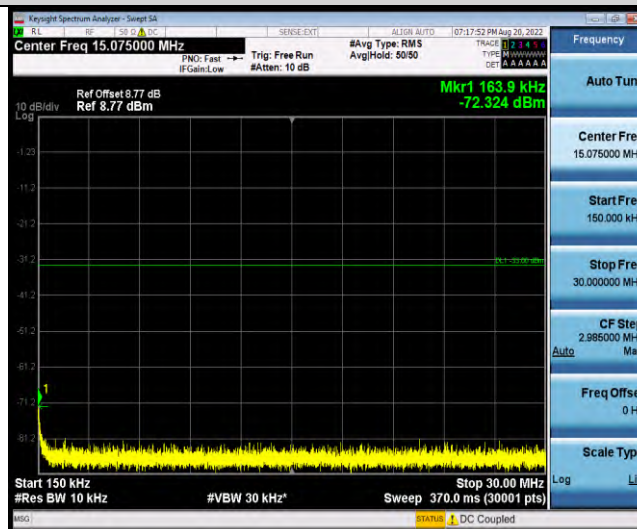

Band2-Stand-Alone-NaN-BPSK-19198-1 @ 11-15kHz-0.15-30-0.15~30MHz @ -72.32dBm--33-PASS

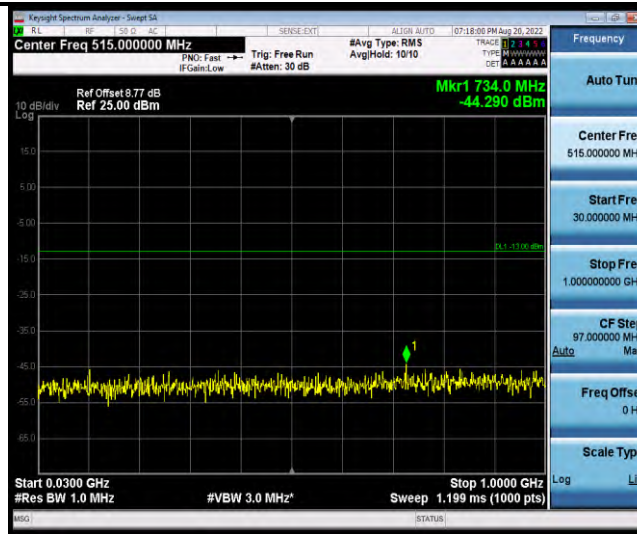

Band2-Stand-Alone-NaN-BPSK-19198-1 @ 11-15kHz-30-1000-30~1000MHz @ -44.29dBm--13-PASS

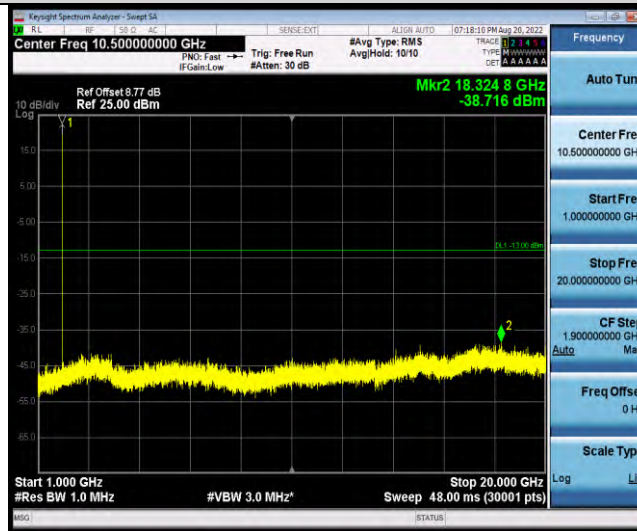

Band2-Stand-Alone-NaN-BPSK-19198-1 @ 11-15kHz-1000-20000-1000~20000MHz @ -38.72dBm--13-PASS



Band2-Stand-Alone-NaN-QPSK-18602-12 @ 0-15kHz-0.009-0.15-0.009~0.15MHz @ -64.78dBm--43-PASS

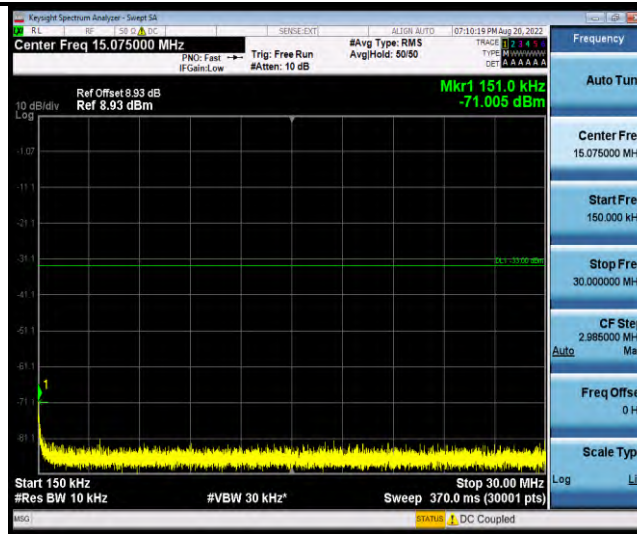

Band2-Stand-Alone-NaN-QPSK-18602-12@0-15kHz-0.15-30-0.15~30MHz@-71.01dBm--33-PASS

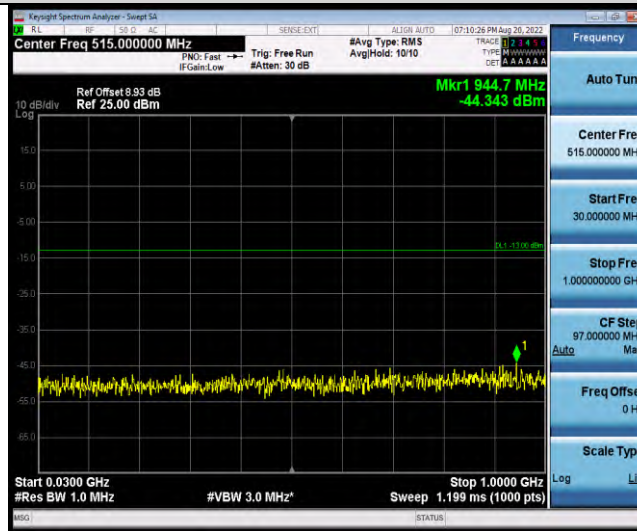

Band2-Stand-Alone-NaN-QPSK-18602-12@0-15kHz-30-1000-30~1000MHz@-44.34dBm--13-PASS



Band2-Stand-Alone-NaN-QPSK-18602-12@0-15kHz-1000-20000-1000~20000MHz@-37.7dBm--13-PASS



Band2-Stand-Alone-Na-N-QPSK-18876-12@0-15kHz-0.009-0.15-0.009~0.15MHz@-52.52dBm--43-PASS

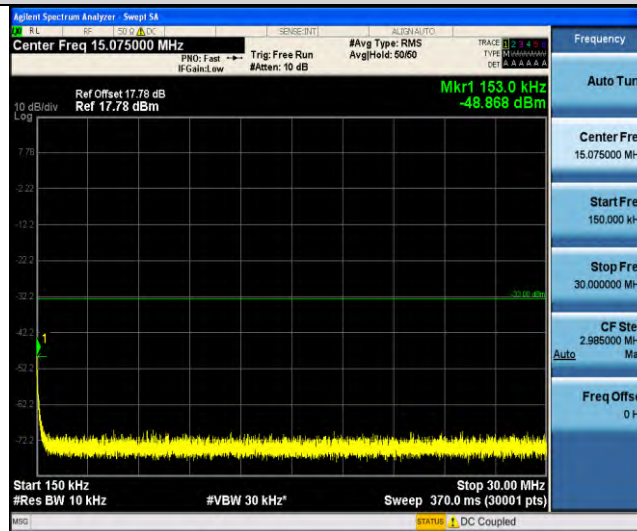

Band2-Stand-Alone-Na-N-QPSK-18876-12@0-15kHz-0.15-30-0.15~30MHz@-48.87dBm--33-PASS

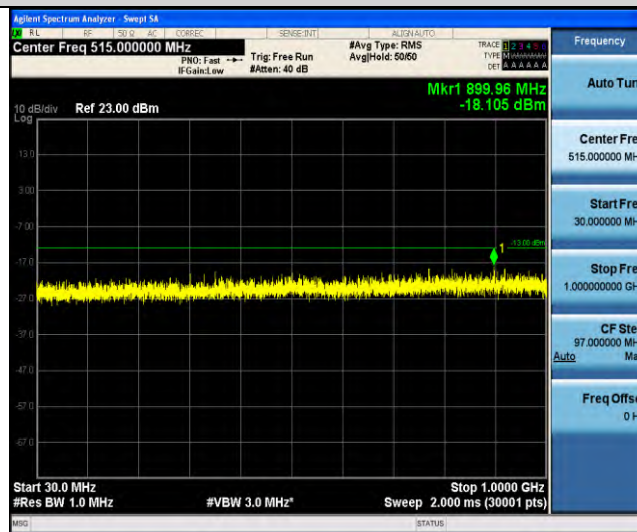

Band2-Stand-Alone-Na-N-QPSK-18876-12@0-15kHz-30-1000-30~1000MHz@-18.11dBm--13-PASS



Band2-Stand-Alone-Na-N-QPSK-18876-12@0-15kHz-1000-5000-1000~5000MHz@-24.02dBm--13-PASS



Band2-Stand-Alone-Na-N-QPSK-18876-12@0-15kHz-5000-12000-5000~12000MHz@-42.54dBm--13-PASS



Band2-Stand-Alone-Na-N-QPSK-18876-12@0-15kHz-12000-26500-12000~26500MHz@-30.86dBm--13-PASS