

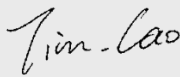
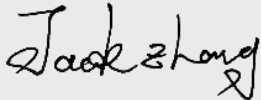

Test report No:  
21C0074R-RF-US-P40V01

## FCC TEST REPORT

Product Name	LTE Cat.NB1/2 Data-Only Module
Trademark	CINTERION
FCC ID	QIPTN23-W
Model and /or type reference	TN23-W
Applicant's name / address	THALES DIS AIS Deutschland GmbH Werinherstr. 81, 81541 Munich, Germany
Test method requested, standard	FCC CFR Title 47 Part 22 & 24 & 27 & 90 ANSI C63.26: 2015 KDB971168 D01 v03r01, KDB971168 D02 v02r01 ANSI/TIA-603-E: 2016
Verdict Summary	IN COMPLIANCE
Documented by (name / position & signature)	Tim Cao/ Project Engineer 
Approved by (name / position & signature)	Jack Zhang/ Manager 
Date of issue	2022-09-08
Report Version	V3.0
Report template No	Template_Part 22&24&27&90-RF-V1.0

## INDEX

	page
General conditions .....	4
Environmental conditions .....	4
Possible test case verdicts .....	5
Abbreviations .....	5
Document History .....	6
Remarks and Comments.....	6
Used Equipment .....	7
Uncertainty .....	9
1 General Information.....	10
1.1 General Description of the Item(s) .....	10
1.2 Antenna Information .....	12
1.3 Channel List .....	13
2 Description of Test Setup .....	14
2.1 Auxiliary equipment / Test software for the EUT.....	14
2.2 Test Configuration / Block diagram used for tests .....	15
2.3 Testing process.....	16
3 Verdict summary section .....	17
3.1 Standards.....	17
3.2 Deviation(s) from the Standard(s) / Test Specification(s).....	17
3.3 Overview of results.....	18
3.4 Test Facility.....	19
4 Test Results .....	20
4.1 Effective (Isotropic) Radiated Power Output.....	20
4.1.1 Limit .....	20
4.1.2 Test Setup.....	20
4.1.3 Test Procedure.....	21
4.1.4 Test Data .....	22
4.2 Peak-to-Average Ratio(CCDF) .....	31
4.2.1 Limit .....	31
4.2.2 Test Setup.....	31
4.2.3 Test Procedure.....	31
4.2.4 Test Data .....	32
4.3 Frequency Stability.....	78
4.3.1 Limit .....	78

---

4.3.2	Test Setup.....	78
4.3.3	Test Procedure.....	79
4.3.4	Test Data .....	80
4.4	Occupied Bandwidth.....	112
4.4.1	Limit .....	112
4.4.2	Test Setup.....	112
4.4.3	Test Procedure.....	112
4.4.4	Test Data .....	113
4.5	Spurious Emissions at antenna terminals .....	209
4.5.1	Limit .....	209
4.5.2	Test Setup.....	210
4.5.3	Test Procedure.....	210
4.5.4	Test Data .....	211
4.6	Spurious Emissions at antenna terminals at Block Edges .....	586
4.6.1	Limit .....	586
4.6.2	Test Setup.....	587
4.6.3	Test Procedure.....	587
4.6.4	Test Data .....	588
4.7	Radiated Emissions.....	687
4.7.1	Limit .....	687
4.7.2	Test Setup.....	688
4.7.3	Test Procedure.....	688
4.7.4	Test Data .....	689
4.8	Test setup photo and EUT Photo.....	696

## COMPETENCES AND GUARANTEES

DEKRA is a testing laboratory competent to carry out the tests described in this report.

In order to assure the traceability to other national and international laboratories, DEKRA has a calibration and maintenance program for its measurement equipment.

DEKRA guarantees the reliability of the data presented in this report, which is the result of the measurements and the tests performed to the item under test on the date and under the conditions stated in the report and it is based on the knowledge and technical facilities available at DEKRA at the time of performance of the test.

DEKRA is liable to the client for the maintenance of the confidentiality of all information related to the item under test and the results of the test.

The results presented in this Test Report apply only to the particular item under test established in this document.

**IMPORTANT:** No parts of this report may be reproduced or quoted out of context, in any form or by any means, except in full, without the previous written permission of DEKRA.

## GENERAL CONDITIONS

Test Location	No. 99, Hongye Road, Suzhou Industrial Park Suzhou, 215006, P.R. China
Date(receive sample)	Dec. 02, 2021
Date (start test)	Dec. 20, 2021
Date (finish test)	Aug. 29, 2022

1. This report is only referred to the item that has undergone the test.
2. This report does not constitute or imply on its own an approval of the product by the Certification Bodies or Competent Authorities.
3. This document is only valid if complete; no partial reproduction can be made without previous written permission of DEKRA.
4. This test report cannot be used partially or in full for publicity and/or promotional purposes without previous written permission of DEKRA.

## ENVIRONMENTAL CONDITIONS

The climatic conditions during the tests are within the limits specified by the manufacturer for the operation of the EUT and the test equipment. The climatic conditions during the tests were within the following limits:

Ambient temperature	15 °C – 35 °C
Relative Humidity air	30% - 60%

If explicitly required in the basic standard or applied product / product family standard the climatic values are recorded and documented separately in this test report.

## POSSIBLE TEST CASE VERDICTS

Test case does not apply to test object	N/A
Test object does meet requirement	P (Pass) / PASS
Test object does not meet requirement	F (Fail) / FAIL
Not measured	N/M

## ABBREVIATIONS

For the purposes of the present document, the following abbreviations apply:

EUT	: Equipment Under Test
QP	: Quasi-Peak
CAV	: CISPR Average
AV	: Average
CDN	: Coupling Decoupling Network
SAC	: Semi-Anechoic Chamber
OATS	: Open Area Test Site
BW	: Bandwidth
AM	: Amplitude Modulation
PM	: Pulse Modulation
HCP	: Horizontal Coupling Plane
VCP	: Vertical Coupling Plane
$U_N$	: Nominal voltage
$T_x$	: Transmitter
$R_x$	: Receiver
N/A	: Not Applicable
N/M	: Not Measured

## DOCUMENT HISTORY

Report No.	Version	Description	Issued Date
21C0074R-RF-US-P40V01	V1.0	Initial issue of report.	2022-02-22
21C0074R-RF-US-P40V01	V1.1	Section 4.4.4, 4.6.4: Update test data.	2022-04-21
21C0074R-RF-US-P40V01	V1.2	Page 12: Update channel list and add description about remove edge channel. Section 4: Update test data.	2022-05-13
21C0074R-RF-US-P40V01	V1.3	Page 583~585, 648~654: Update band26 (part 90) block edge data.	2022-05-20
21C0074R-RF-US-P40V01	V1.4	Page 117, 193: Update bandwidth test data.	2022-06-02
21C0074R-RF-US-P40V01	V2.0	Page 9: Update tempature range and supplementary software and hardware version; Page 10: Update voltage range; Page 12: Revised notes; Page 17: Add note about data shown in this report.	2022-07-15
21C0074R-RF-US-P40V01	V3.0	Section 4: Update test data. (The test report No.: 21C0074R-RF-US-P40V01 V3.0 is to replace the test report No.: 21C0074R-RF-US-P40V01 V2.0, and all previous version are obsoleted.)	2022-09-08

## REMARKS AND COMMENTS

1. The equipment under test (EUT) does meet the essential requirements of the stated standard(s)/test(s).
2. These test results on a sample of the device are for the purpose of demonstrating Compliance with FCC Part 22,24,27,90.
3. The measurement result is considered in conformance with the requirement if it is within the prescribed limit, It is not necessary to account the uncertainty associated with the measurement result.
4. The test results relate only to the samples tested.
5. The test report shall not be reproduced without the written approval of DEKRA Testing and Certification (Suzhou) Co., Ltd.
6. This report will not be used for social proof function in China market.
7. DEKRA declines any responsibility with the following test data provided by customer that may affect the validity of result:
  - Chapter 1.1 General Description of the Item(s);
  - Chapter 1.2 Antenna Information;
  - Chapter 1.3 Channel List.

## USED EQUIPMENT

RF Output Power/Frequency Stability/Occupied Bandwidth/Spurious Emissions at antenna terminals/Spurious Emissions at antenna terminals at Block Edges / TR7

Instrument	Manufacturer	Model No.	Serial No.	Cal. Date	Next Cal. Date
Spectrum Analyzer	Agilent	N9010A	MY48030494	2021.12.15	2022.12.14
Wideband Radio Communication Tester	R&S	CMW 500	1201.0002K50-158243-jb	2021.10.20	2022.10.19
Directional Coupler	Midwest Microwave	CPL-5231-16-001	-	N/A	N/A
Dual Directional Coupler	Agilent	778D	20160	2021.07.11	2022.07.10
Dual Directional Coupler	Agilent	778D	20160	2022.07.01	2023.06.30
High and low temperature and fast temperature change test box	ASTD	ASTD-FBT-225K	N/A	2021.08.18	2022.08.17
High and low temperature and fast temperature change test box	ASTD	ASTD-FBT-225K	N/A	2022.07.13	2023.07.12
Temperature/Humidity Meter	RTS	RTS-8S	RF07	2021.07.09	2022.07.08
Temperature/Humidity Meter	RTS	RTS-8S	RF07	2022.07.07	2023.07.06

## Radiated Emissions (1GHz-40GHz)/ AC5

Instrument	Manufacturer	Model No.	Serial No.	Cal. Date	Next Cal. Date
Signal analyzer	R&S	FSV	104212	2021.11.18	2022.11.17
Wideband Radio Communication Tester	R&S	CMW 500	1201.0002K50-158243-jb	2021.10.20	2022.10.19
ESG Vector Signal Generator	Agilent	E4438C	MY49070163	2021.07.11	2022.07.10
ESG Vector Signal Generator	Agilent	E4438C	MY49070163	2022.07.01	2023.06.30
Pre-Amplifier	EMCI	EMC184045SE	980263	2021.07.22	2022.07.21
Pre-Amplifier	EMCI	EMC184045SE	980263	2022.07.19	2023.07.18
Pre-Amplifier	SKET	LNPA_0118G-45	SK2021090101	2021.12.13	2022.12.12
DRG Horn Antenna	ETS-Lindgren	3117	167055	2021.09.06	2022.09.05
DRG Horn Antenna	ETS-Lindgren	3117	167055	2022.08.29	2023.08.28
Broad-Band Horn Antenna	Schwarzbeck	BBHA9170	294	2021.04.19	2023.04.18
Coaxial Cable	Huber+Suhner	SUCOFLEX 106	AC5-C2	2021.05.22	2022.05.21
Coaxial Cable	Huber+Suhner	SUCOFLEX 106	AC5-C2	2022.03.30	2023.03.29
Coaxial Cable	ROSENBERGER	LA1-C011-2000/3000	AC5-40G-2	2021.05.22	2022.05.21
Coaxial Cable	ROSENBERGER	LA1-C011-2000/3000	AC5-40G-2	2022.05.26	2023.05.25
Temperature/Humidity Meter	RTS	RTS-8S	AC5-TH	2021.07.09	2022.07.08
Temperature/Humidity Meter	RTS	RTS-8S	AC5-TH	2022.07.07	2023.07.06
Dekra test software	Dekra	-	-	-	-



## UNCERTAINTY

Uncertainties have been calculated according to the DEKRA internal document. The reported expanded uncertainties are based on a standard uncertainty multiplied by a coverage factor of  $k=2$ , providing a level of confidence of approximately 95%. The Uncertainties is comply with standard required as below.

Test item	Uncertainty
RF Output Power	$\pm 1.2$ dB
Frequency Stability	$\pm 10$ Hz
Occupied Bandwidth	$\pm 10$ Hz
Spurious Emissions at antenna terminals	$\pm 1.2$ dB
Spurious Emissions at antenna terminals at Block Edges	$\pm 1.2$ dB
Radiated Emissions	$\pm 3.2$ dB

# 1 GENERAL INFORMATION

## 1.1 General Description of the Item(s)

Product Name .....	LTE Cat.NB1/2 Data-Only Module
Model No. ....	TN23-W
Trademark.....	CINTERION
Software version .....	00.028
Hardware version .....	Rev4.2
Operating Temperature Range .....	-40~80°C
Manufacturer .....	THALES DIS AIS Deutschland GmbH.
Manufacturer Address .....	Werinherstr. 81, 81541 Munich, Germany

Wireless specification.....	LTE Cat NB1 & NB2
Support Band(s)	2/4/5/12/13/17/18/19/25/26/66/85
Uplink Frequency	Band 2: 1850-1910 MHz Band 4: 1710-1755 MHz Band 5: 824-849 MHz Band 12: 699-716 MHz Band 13: 777-787 MHz Band 17: 704-716 MHz Band 18: 815-830 MHz Band 19: 830-845 MHz Band 25: 1850-1915 MHz Band 26: 814-849 MHz Band 66: 1710-1780 MHz Band 85: 698-716 MHz
Downlink Frequency	Band 2: 1930-1990 MHz Band 4: 2110-2155 MHz Band 5: 869-894 MHz Band 12: 729-746 MHz Band 13: 746-756 MHz Band 17: 734-746 MHz Band 18: 860-875 MHz Band 19: 875-890 MHz Band 25: 1930-1995 MHz Band 26: 859-894 MHz Band 66: 2110-2200 MHz Band 85: 728-746 MHz
Type of Modulation.....	BPSK, QPSK

Rated power supply..... :	Voltage and Frequency	
	<input type="checkbox"/>	AC: 220 – 240 V, 50/60 Hz
	<input type="checkbox"/>	AC: 100 – 120 V, 50/60 Hz
	<input checked="" type="checkbox"/>	DC: 2.8-4.5 Vdc
	<input type="checkbox"/>	Battery: 3.7V
Mounting position ..... :	<input type="checkbox"/>	Table top equipment
	<input type="checkbox"/>	Wall/Ceiling mounted equipment
	<input type="checkbox"/>	Floor standing equipment
	<input type="checkbox"/>	Hand-held equipment
	<input checked="" type="checkbox"/>	Other: Module

## 1.2 Antenna Information

Antenna model / type number.....:	MiniMag		
Antenna serial number .....	N/A		
Antenna Delivery .....	<input checked="" type="checkbox"/>	1TX + 1RX	
	<input type="checkbox"/>	2TX + 2RX	
Antenna technology.....:	<input checked="" type="checkbox"/>	SISO	
	<input type="checkbox"/>	MIMO	<input type="checkbox"/> CDD
			<input type="checkbox"/> Beam-forming
Antenna Type.....:	<input checked="" type="checkbox"/>	External	<input checked="" type="checkbox"/> Dipole
			<input type="checkbox"/> Sectorized
	<input type="checkbox"/>	Internal	<input type="checkbox"/> PIFA
			<input type="checkbox"/> PCB
			<input type="checkbox"/> Ceramic Chip
			<input type="checkbox"/> Others.....
Antenna Gain.....:	617 ~ 803 MHz: 3.17 dBi 824 ~ 960 MHz: 5.17 dBi 1710 ~ 2170 MHz: 2.17 dBi		

Note: The antenna is only used for certification testing, not for market sales.

### 1.3 Channel List

NB-IoT Band	Channel & Frequency(MHz)		
	Lowest	Middle	Highest
2	18602	18876	19198
	1850.2	1877.6	1909.8
4	19952	20175	20398
	1710.2	1732.5	1754.8
5	20402	20525	20648
	824.2	836.5	848.8
12	23012	23095	23178
	699.2	707.5	715.8
13	23182	23230	23278
	777.2	778.5	778.8
17	23732	23790	23848
	704.2	710.0	715.8
18	23852	23925	23998
	815.2	822.5	829.8
19	24002	24075	24148
	830.2	837.5	844.8
25	26042	26365	26688
	1850.2	1882.5	1914.8
26(Part 90)	26692	26740	26788
	814.2	819.0	823.8
26(Part 22)	26792	26915	27038
	824.2	836.5	848.8
66	131974	132322	132670
	1710.2	1745.0	1779.8
85	134004	134092	134180
	698.2	707.0	715.8

Note 1: For each frequency band, TN23-W's firmware locks the channel closest to the edge of the frequency band in order to meet the standard requirements of different countries and regions. The provided modules will thus not support the channel closest to the edge of each band. Channel locked up has no effect to RF performance.

Note 2: In this report, the test frequency is shown in the table above, and this frequency range can completely cover the frequency range of the final product. Since the test results were passed within the frequency range of this report, the final product also complies with FCC requirements.

Note 3: The General Description of the Item , antenna information, Data Rate, Channel List and Test Software for the EUT in clause 1 are provided and confirmed by the client.

## 2 DESCRIPTION OF TEST SETUP

### 2.1 Auxiliary equipment / Test software for the EUT

No.	Auxiliary equipment	Model No.	Manufacturer	Supplied by
1	DC Power Supply	CD-035-020PR	IDRC	N/A
2	Wideband Radio Communication Tester	CMW 500	R&S	N/A

No.	Signal Cable Type	Signal Cable Description
A	Control Cable	Non-Shielded, 2m
B	Coaxial Cable	Shielded, 1.5m
C	Coaxial Cable	Shielded, 10m

## 2.2 Test Configuration / Block diagram used for tests

Conducted Connection Diagram

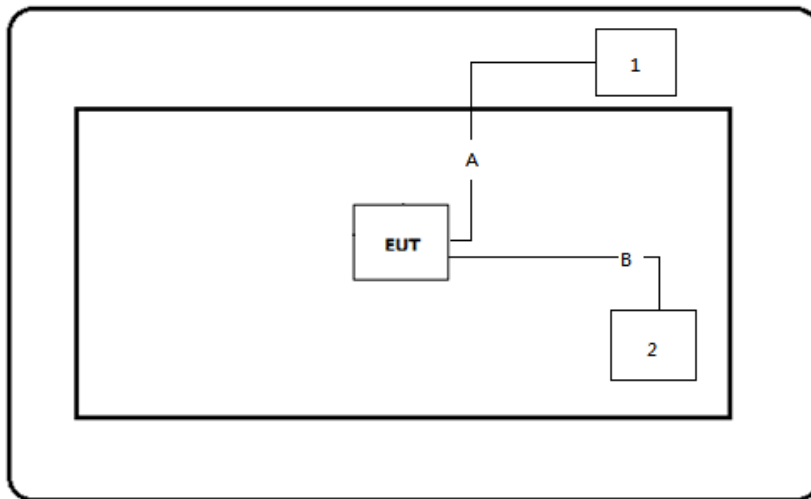

Radiated Connection Diagram

Chamber

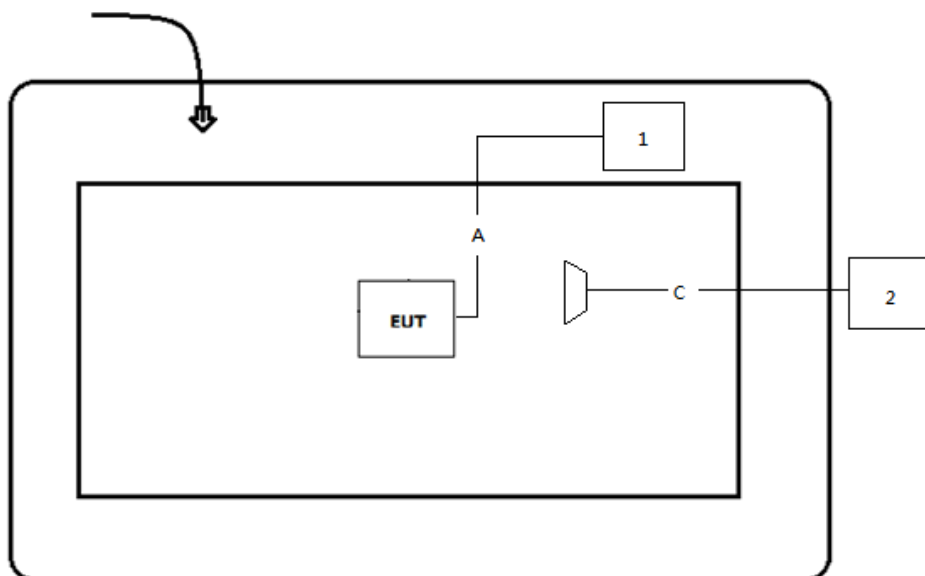

1	Base Station
2	Signal Analyzer

### 2.3 Testing process

1	Setup the EUT and simulators as shown on above.
2	Turn on the power of all equipment.
3	EUT Communicate with CMW 500, then select mode and channel to test.



### 3 VERDICT SUMMARY SECTION

This chapter presents an overview of standards and results. Refer to the next chapters for details of measured test results and applied test levels.

#### 3.1 Standards

Standard	Year	Description
FCC CFR Title 47 Part 2	2020	FREQUENCY ALLOCATIONS AND RADIO TREATY MATTERS; GENERAL RULES AND REGULATIONS
FCC CFR Title 47 Part 22	2020	PUBLIC MOBILE SERVICES
FCC CFR Title 47 Part 24	2020	PERSONAL COMMUNICATIONS SERVICES
FCC CFR Title 47 Part 27	2020	MISCELLANEOUS WIRELESS COMMUNICATIONS SERVICES
FCC CFR Title 47 Part 90	2020	PRIVATE LAND MOBILE RADIO SERVICES

#### 3.2 Deviation(s) from the Standard(s) / Test Specification(s)

The following deviation(s) was / were made from the published requirements of the listed standards: N/A.

*(Please define the deviations from the standard(s) if applicable)*

### 3.3 Overview of results

FCC Part 22			
Requirement – Test case	Basic standard(s)	Verdict	Remark
RF Output Power	Section 22.913	PASS	
Frequency Stability	Section 22.355	PASS	
Occupied Bandwidth	Section 2.1049	PASS	
Spurious Emissions at antenna terminals	Section 22.917	PASS	
Radiated Emissions	Section 22.917	PASS	

FCC Part 90			
Requirement – Test case	Basic standard(s)	Verdict	Remark
RF Output Power	Section 90.635(b)	PASS	
Frequency Stability	Section 90.213	PASS	
Occupied Bandwidth	Section 2.1049	PASS	
Spurious Emissions at antenna terminals	Section 90.691	PASS	
Radiated Emissions	Section 90.691	PASS	

FCC Part 24			
Requirement – Test case	Basic standard(s)	Verdict	Remark
RF Output Power	Section 24.232	PASS	
Frequency Stability	Section 24.235	PASS	
Occupied Bandwidth	Section 2.1049	PASS	
Spurious Emissions at antenna terminals	Section 24.238	PASS	
Radiated Emissions	Section 24.238	PASS	

FCC Part 27			
Requirement – Test case	Basic standard(s)	Verdict	Remark
RF Output Power	Section 27.50	PASS	
Frequency Stability	Section 27.54	PASS	
Occupied Bandwidth	Section 2.1049	PASS	
Spurious Emissions at antenna terminals	Section 27.53	PASS	
Radiated Emissions	Section 27.53	PASS	

Note: This product supports LTE Cat NB1 and NB2. Since the test data of NB1 and NB2 are similar, this report only shows the worst data.

---

### 3.4 Test Facility

**USA** : **FCC Designation Number: CN1199**

## 4 TEST RESULTS

<b>4.1 Effective (Isotropic) Radiated Power Output</b>	<b>VERDICT: PASS</b>
--	----------------------

4.1.1 Limit	
NB-IoT Band	Standard
5/18/19 /26	FCC §2.1046 and §22.913: The ERP of mobile transmitters and auxiliary test transmitters must not exceed 7 watts.
	FCC §90.635: The maximum output power of the transmitter for mobile stations is 100 watts (20 dBw).
2/25	FCC §2.1046 and §24.232: Mobile and portable stations are limited to 2 watts EIRP. The peak-to-average ratio (PAR) of the transmission may not exceed 13 dB.
12/13/17 /85	FCC §27.50(c)(10): Portable stations (hand-held devices) in the 600 MHz uplink band and the 698-746 MHz band, and fixed and mobile stations in the 600 MHz uplink band are limited to 3 watts ERP.
	FCC §27.50(b)(10): Portable stations (hand-held devices) transmitting in the 746-757 MHz, 776-788 MHz, and 805-806 MHz bands are limited to 3 watts ERP.
4/66	FCC §27.50(d)(4): Fixed, mobile, and portable (hand-held) stations operating in the 1710-1755 MHz band and mobile and portable stations operating in the 1695-1710 MHz and 1755-1780 MHz bands are limited to 1 watt EIRP. Fixed stations operating in the 1710-1755 MHz band are limited to a maximum antenna height of 10 meters above ground. Mobile and portable stations operating in these bands must employ a means for limiting power to the minimum necessary for successful communications.

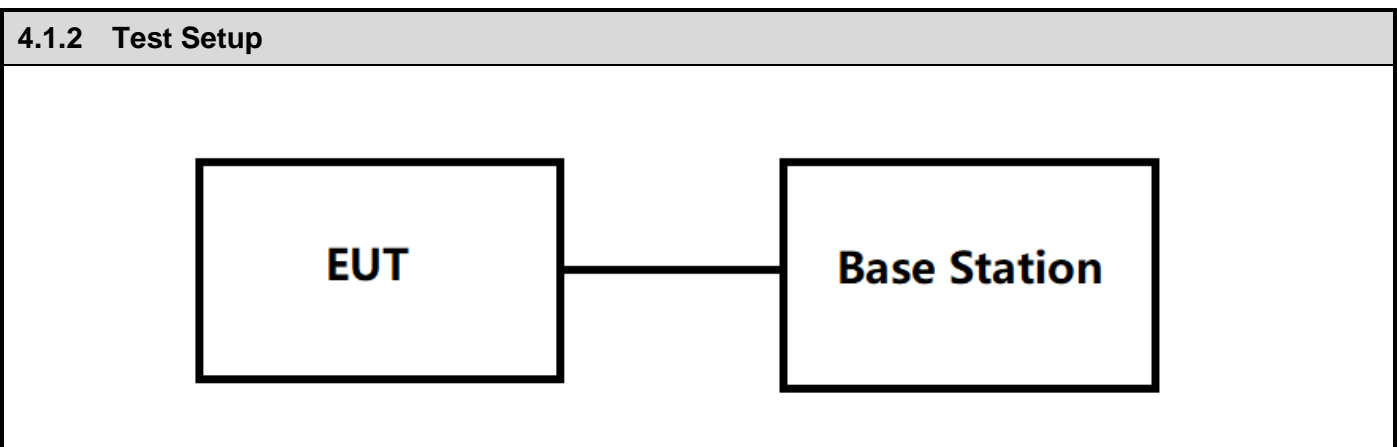

**4.1.3 Test Procedure**

	References Rule	Chapter	Item
<input checked="" type="checkbox"/>	ANSI C63.26-2015	5.2	RF output power measurement procedures

The conducted RF Output Power measurements were made at the RF output terminals of the EUT using the power meter of the Universal Radio Communication tester R&S CMW500, selecting maximum transmission power of the EUT and different modes of modulation.

Peak to average ratio(PAPR) is used equation  $PAPR(dB)=PPK(dBm)-PAVG(dBm)$ , where PPK is measured peak power, and PAVG is measured average power.

The maximum equivalent isotropically radiated power(e.i.r.p.) is calculated by adding the declared maximum antenna gain(dBi).

The maximum effective radiated power e.r.p. is calculated form the maximum equivalent isotropically radiated power(e.i.r.p.) by subtracting 2.15 dB:  $E.R.P = E.I.R.P. - 2.15 dB$

#### 4.1.4 Test Data

Band	OpMode	SCS	BW	Modu	Channel	Tones	Result (dBm)	Verdict
Band2	Stand-Alone	3.75kHz	NaN	BPSK	18602	1@0	23.24	PASS
Band2	Stand-Alone	3.75kHz	NaN	BPSK	18602	1@47	23.23	PASS
Band2	Stand-Alone	3.75kHz	NaN	BPSK	18876	1@0	23.19	PASS
Band2	Stand-Alone	3.75kHz	NaN	BPSK	18876	1@47	23.20	PASS
Band2	Stand-Alone	3.75kHz	NaN	BPSK	19198	1@0	22.87	PASS
Band2	Stand-Alone	3.75kHz	NaN	BPSK	19198	1@47	22.85	PASS
Band2	Stand-Alone	3.75kHz	NaN	QPSK	18602	1@0	23.29	PASS
Band2	Stand-Alone	3.75kHz	NaN	QPSK	18602	1@47	23.30	PASS
Band2	Stand-Alone	3.75kHz	NaN	QPSK	18876	1@0	23.22	PASS
Band2	Stand-Alone	3.75kHz	NaN	QPSK	18876	1@47	23.22	PASS
Band2	Stand-Alone	3.75kHz	NaN	QPSK	19198	1@0	22.93	PASS
Band2	Stand-Alone	3.75kHz	NaN	QPSK	19198	1@47	22.91	PASS
Band2	Stand-Alone	15kHz	NaN	BPSK	18602	1@0	22.64	PASS
Band2	Stand-Alone	15kHz	NaN	BPSK	18602	1@11	22.57	PASS
Band2	Stand-Alone	15kHz	NaN	BPSK	18602	3@3	22.47	PASS
Band2	Stand-Alone	15kHz	NaN	BPSK	18876	1@0	22.45	PASS
Band2	Stand-Alone	15kHz	NaN	BPSK	18876	1@11	22.44	PASS
Band2	Stand-Alone	15kHz	NaN	BPSK	18876	3@3	22.48	PASS
Band2	Stand-Alone	15kHz	NaN	BPSK	19198	1@0	22.37	PASS
Band2	Stand-Alone	15kHz	NaN	BPSK	19198	1@11	22.50	PASS
Band2	Stand-Alone	15kHz	NaN	BPSK	19198	3@3	22.25	PASS
Band2	Stand-Alone	15kHz	NaN	QPSK	18602	1@0	22.49	PASS
Band2	Stand-Alone	15kHz	NaN	QPSK	18602	1@11	22.60	PASS
Band2	Stand-Alone	15kHz	NaN	QPSK	18602	3@3	22.49	PASS
Band2	Stand-Alone	15kHz	NaN	QPSK	18876	1@0	22.36	PASS
Band2	Stand-Alone	15kHz	NaN	QPSK	18876	1@11	22.33	PASS
Band2	Stand-Alone	15kHz	NaN	QPSK	18876	3@3	22.51	PASS
Band2	Stand-Alone	15kHz	NaN	QPSK	19198	1@0	22.41	PASS
Band2	Stand-Alone	15kHz	NaN	QPSK	19198	1@11	22.24	PASS
Band2	Stand-Alone	15kHz	NaN	QPSK	19198	3@3	22.28	PASS
Band4	Stand-Alone	3.75kHz	NaN	BPSK	19952	1@0	22.28	PASS
Band4	Stand-Alone	3.75kHz	NaN	BPSK	19952	1@47	22.31	PASS
Band4	Stand-Alone	3.75kHz	NaN	BPSK	20175	1@0	23.34	PASS
Band4	Stand-Alone	3.75kHz	NaN	BPSK	20175	1@47	23.36	PASS
Band4	Stand-Alone	3.75kHz	NaN	BPSK	20398	1@0	23.44	PASS
Band4	Stand-Alone	3.75kHz	NaN	BPSK	20398	1@47	23.45	PASS
Band4	Stand-Alone	3.75kHz	NaN	QPSK	19952	1@0	22.35	PASS
Band4	Stand-Alone	3.75kHz	NaN	QPSK	19952	1@47	22.38	PASS
Band4	Stand-Alone	3.75kHz	NaN	QPSK	20175	1@0	23.36	PASS
Band4	Stand-Alone	3.75kHz	NaN	QPSK	20175	1@47	23.35	PASS
Band4	Stand-Alone	3.75kHz	NaN	QPSK	20398	1@0	23.52	PASS

Band4	Stand-Alone	3.75kHz	NaN	QPSK	20398	1@47	23.36	PASS
Band4	Stand-Alone	15kHz	NaN	BPSK	19952	1@0	22.20	PASS
Band4	Stand-Alone	15kHz	NaN	BPSK	19952	1@11	22.20	PASS
Band4	Stand-Alone	15kHz	NaN	BPSK	19952	3@3	22.09	PASS
Band4	Stand-Alone	15kHz	NaN	BPSK	20175	1@0	22.81	PASS
Band4	Stand-Alone	15kHz	NaN	BPSK	20175	1@11	22.80	PASS
Band4	Stand-Alone	15kHz	NaN	BPSK	20175	3@3	22.81	PASS
Band4	Stand-Alone	15kHz	NaN	BPSK	20398	1@0	22.86	PASS
Band4	Stand-Alone	15kHz	NaN	BPSK	20398	1@11	22.80	PASS
Band4	Stand-Alone	15kHz	NaN	BPSK	20398	3@3	22.73	PASS
Band4	Stand-Alone	15kHz	NaN	QPSK	19952	1@0	22.18	PASS
Band4	Stand-Alone	15kHz	NaN	QPSK	19952	1@11	22.12	PASS
Band4	Stand-Alone	15kHz	NaN	QPSK	19952	3@3	22.09	PASS
Band4	Stand-Alone	15kHz	NaN	QPSK	20175	1@0	22.64	PASS
Band4	Stand-Alone	15kHz	NaN	QPSK	20175	1@11	22.66	PASS
Band4	Stand-Alone	15kHz	NaN	QPSK	20175	3@3	22.81	PASS
Band4	Stand-Alone	15kHz	NaN	QPSK	20398	1@0	22.79	PASS
Band4	Stand-Alone	15kHz	NaN	QPSK	20398	1@11	22.78	PASS
Band4	Stand-Alone	15kHz	NaN	QPSK	20398	3@3	22.77	PASS
Band5	Stand-Alone	3.75kHz	NaN	BPSK	20402	1@0	23.05	PASS
Band5	Stand-Alone	3.75kHz	NaN	BPSK	20402	1@47	23.04	PASS
Band5	Stand-Alone	3.75kHz	NaN	BPSK	20525	1@0	23.42	PASS
Band5	Stand-Alone	3.75kHz	NaN	BPSK	20525	1@47	23.43	PASS
Band5	Stand-Alone	3.75kHz	NaN	BPSK	20648	1@0	23.40	PASS
Band5	Stand-Alone	3.75kHz	NaN	BPSK	20648	1@47	23.39	PASS
Band5	Stand-Alone	3.75kHz	NaN	QPSK	20402	1@0	23.08	PASS
Band5	Stand-Alone	3.75kHz	NaN	QPSK	20402	1@47	23.08	PASS
Band5	Stand-Alone	3.75kHz	NaN	QPSK	20525	1@0	23.44	PASS
Band5	Stand-Alone	3.75kHz	NaN	QPSK	20525	1@47	23.41	PASS
Band5	Stand-Alone	3.75kHz	NaN	QPSK	20648	1@0	23.42	PASS
Band5	Stand-Alone	3.75kHz	NaN	QPSK	20648	1@47	23.41	PASS
Band5	Stand-Alone	15kHz	NaN	BPSK	20402	1@0	23.17	PASS
Band5	Stand-Alone	15kHz	NaN	BPSK	20402	1@11	23.06	PASS
Band5	Stand-Alone	15kHz	NaN	BPSK	20402	3@3	22.85	PASS
Band5	Stand-Alone	15kHz	NaN	BPSK	20525	1@0	22.76	PASS
Band5	Stand-Alone	15kHz	NaN	BPSK	20525	1@11	22.57	PASS
Band5	Stand-Alone	15kHz	NaN	BPSK	20525	3@3	22.77	PASS
Band5	Stand-Alone	15kHz	NaN	BPSK	20648	1@0	22.83	PASS
Band5	Stand-Alone	15kHz	NaN	BPSK	20648	1@11	22.84	PASS
Band5	Stand-Alone	15kHz	NaN	BPSK	20648	3@3	22.49	PASS
Band5	Stand-Alone	15kHz	NaN	QPSK	20402	1@0	22.96	PASS
Band5	Stand-Alone	15kHz	NaN	QPSK	20402	1@11	23.00	PASS
Band5	Stand-Alone	15kHz	NaN	QPSK	20402	3@3	22.85	PASS
Band5	Stand-Alone	15kHz	NaN	QPSK	20525	1@0	22.47	PASS
Band5	Stand-Alone	15kHz	NaN	QPSK	20525	1@11	22.53	PASS
Band5	Stand-Alone	15kHz	NaN	QPSK	20525	3@3	22.77	PASS

Band5	Stand-Alone	15kHz	NaN	QPSK	20648	1@0	22.69	PASS
Band5	Stand-Alone	15kHz	NaN	QPSK	20648	1@11	22.54	PASS
Band5	Stand-Alone	15kHz	NaN	QPSK	20648	3@3	22.49	PASS
Band12	Stand-Alone	3.75kHz	NaN	BPSK	23012	1@0	22.67	PASS
Band12	Stand-Alone	3.75kHz	NaN	BPSK	23012	1@47	22.70	PASS
Band12	Stand-Alone	3.75kHz	NaN	BPSK	23095	1@0	22.33	PASS
Band12	Stand-Alone	3.75kHz	NaN	BPSK	23095	1@47	22.37	PASS
Band12	Stand-Alone	3.75kHz	NaN	BPSK	23178	1@0	21.85	PASS
Band12	Stand-Alone	3.75kHz	NaN	BPSK	23178	1@47	21.91	PASS
Band12	Stand-Alone	3.75kHz	NaN	QPSK	23012	1@0	22.78	PASS
Band12	Stand-Alone	3.75kHz	NaN	QPSK	23012	1@47	22.78	PASS
Band12	Stand-Alone	3.75kHz	NaN	QPSK	23095	1@0	22.30	PASS
Band12	Stand-Alone	3.75kHz	NaN	QPSK	23095	1@47	22.43	PASS
Band12	Stand-Alone	3.75kHz	NaN	QPSK	23178	1@0	21.96	PASS
Band12	Stand-Alone	3.75kHz	NaN	QPSK	23178	1@47	21.92	PASS
Band12	Stand-Alone	15kHz	NaN	BPSK	23012	1@0	23.51	PASS
Band12	Stand-Alone	15kHz	NaN	BPSK	23012	1@11	23.39	PASS
Band12	Stand-Alone	15kHz	NaN	BPSK	23012	3@3	22.93	PASS
Band12	Stand-Alone	15kHz	NaN	BPSK	23095	1@0	21.99	PASS
Band12	Stand-Alone	15kHz	NaN	BPSK	23095	1@11	22.02	PASS
Band12	Stand-Alone	15kHz	NaN	BPSK	23095	3@3	22.49	PASS
Band12	Stand-Alone	15kHz	NaN	BPSK	23178	1@0	21.40	PASS
Band12	Stand-Alone	15kHz	NaN	BPSK	23178	1@11	21.23	PASS
Band12	Stand-Alone	15kHz	NaN	BPSK	23178	3@3	21.96	PASS
Band12	Stand-Alone	15kHz	NaN	QPSK	23012	1@0	23.24	PASS
Band12	Stand-Alone	15kHz	NaN	QPSK	23012	1@11	23.14	PASS
Band12	Stand-Alone	15kHz	NaN	QPSK	23012	3@3	23.02	PASS
Band12	Stand-Alone	15kHz	NaN	QPSK	23095	1@0	21.86	PASS
Band12	Stand-Alone	15kHz	NaN	QPSK	23095	1@11	21.69	PASS
Band12	Stand-Alone	15kHz	NaN	QPSK	23095	3@3	22.53	PASS
Band12	Stand-Alone	15kHz	NaN	QPSK	23178	1@0	21.19	PASS
Band12	Stand-Alone	15kHz	NaN	QPSK	23178	1@11	21.08	PASS
Band12	Stand-Alone	15kHz	NaN	QPSK	23178	3@3	21.88	PASS
Band13	Stand-Alone	3.75kHz	NaN	BPSK	23182	1@0	23.03	PASS
Band13	Stand-Alone	3.75kHz	NaN	BPSK	23182	1@47	23.08	PASS
Band13	Stand-Alone	3.75kHz	NaN	BPSK	23230	1@0	22.71	PASS
Band13	Stand-Alone	3.75kHz	NaN	BPSK	23230	1@47	22.73	PASS
Band13	Stand-Alone	3.75kHz	NaN	BPSK	23278	1@0	22.27	PASS
Band13	Stand-Alone	3.75kHz	NaN	BPSK	23278	1@47	22.25	PASS
Band13	Stand-Alone	3.75kHz	NaN	QPSK	23182	1@0	23.04	PASS
Band13	Stand-Alone	3.75kHz	NaN	QPSK	23182	1@47	23.10	PASS
Band13	Stand-Alone	3.75kHz	NaN	QPSK	23230	1@0	22.66	PASS
Band13	Stand-Alone	3.75kHz	NaN	QPSK	23230	1@47	22.73	PASS
Band13	Stand-Alone	3.75kHz	NaN	QPSK	23278	1@0	22.30	PASS
Band13	Stand-Alone	3.75kHz	NaN	QPSK	23278	1@47	22.27	PASS
Band13	Stand-Alone	15kHz	NaN	BPSK	23182	1@0	22.68	PASS



Band13	Stand-Alone	15kHz	NaN	BPSK	23182	1@11	22.53	PASS
Band13	Stand-Alone	15kHz	NaN	BPSK	23182	3@3	23.23	PASS
Band13	Stand-Alone	15kHz	NaN	BPSK	23230	1@0	21.84	PASS
Band13	Stand-Alone	15kHz	NaN	BPSK	23230	1@11	21.77	PASS
Band13	Stand-Alone	15kHz	NaN	BPSK	23230	3@3	22.64	PASS
Band13	Stand-Alone	15kHz	NaN	BPSK	23278	1@0	22.35	PASS
Band13	Stand-Alone	15kHz	NaN	BPSK	23278	1@11	22.34	PASS
Band13	Stand-Alone	15kHz	NaN	BPSK	23278	3@3	22.05	PASS
Band13	Stand-Alone	15kHz	NaN	QPSK	23182	1@0	22.54	PASS
Band13	Stand-Alone	15kHz	NaN	QPSK	23182	1@11	22.43	PASS
Band13	Stand-Alone	15kHz	NaN	QPSK	23182	3@3	23.29	PASS
Band13	Stand-Alone	15kHz	NaN	QPSK	23230	1@0	21.78	PASS
Band13	Stand-Alone	15kHz	NaN	QPSK	23230	1@11	21.79	PASS
Band13	Stand-Alone	15kHz	NaN	QPSK	23230	3@3	22.61	PASS
Band13	Stand-Alone	15kHz	NaN	QPSK	23278	1@0	22.22	PASS
Band13	Stand-Alone	15kHz	NaN	QPSK	23278	1@11	22.23	PASS
Band13	Stand-Alone	15kHz	NaN	QPSK	23278	3@3	21.99	PASS
Band17	Stand-Alone	3.75kHz	NaN	BPSK	23732	1@0	23.37	PASS
Band17	Stand-Alone	3.75kHz	NaN	BPSK	23732	1@47	23.40	PASS
Band17	Stand-Alone	3.75kHz	NaN	BPSK	23790	1@0	23.15	PASS
Band17	Stand-Alone	3.75kHz	NaN	BPSK	23790	1@47	23.14	PASS
Band17	Stand-Alone	3.75kHz	NaN	BPSK	23848	1@0	23.02	PASS
Band17	Stand-Alone	3.75kHz	NaN	BPSK	23848	1@47	23.07	PASS
Band17	Stand-Alone	3.75kHz	NaN	QPSK	23732	1@0	23.45	PASS
Band17	Stand-Alone	3.75kHz	NaN	QPSK	23732	1@47	23.43	PASS
Band17	Stand-Alone	3.75kHz	NaN	QPSK	23790	1@0	23.22	PASS
Band17	Stand-Alone	3.75kHz	NaN	QPSK	23790	1@47	23.22	PASS
Band17	Stand-Alone	3.75kHz	NaN	QPSK	23848	1@0	23.09	PASS
Band17	Stand-Alone	3.75kHz	NaN	QPSK	23848	1@47	23.07	PASS
Band17	Stand-Alone	15kHz	NaN	BPSK	23732	1@0	23.95	PASS
Band17	Stand-Alone	15kHz	NaN	BPSK	23732	1@11	23.92	PASS
Band17	Stand-Alone	15kHz	NaN	BPSK	23732	3@3	23.55	PASS
Band17	Stand-Alone	15kHz	NaN	BPSK	23790	1@0	22.59	PASS
Band17	Stand-Alone	15kHz	NaN	BPSK	23790	1@11	22.50	PASS
Band17	Stand-Alone	15kHz	NaN	BPSK	23790	3@3	23.23	PASS
Band17	Stand-Alone	15kHz	NaN	BPSK	23848	1@0	22.53	PASS
Band17	Stand-Alone	15kHz	NaN	BPSK	23848	1@11	22.49	PASS
Band17	Stand-Alone	15kHz	NaN	BPSK	23848	3@3	23.19	PASS
Band17	Stand-Alone	15kHz	NaN	QPSK	23732	1@0	22.78	PASS
Band17	Stand-Alone	15kHz	NaN	QPSK	23732	1@11	23.68	PASS
Band17	Stand-Alone	15kHz	NaN	QPSK	23732	3@3	23.58	PASS
Band17	Stand-Alone	15kHz	NaN	QPSK	23790	1@0	22.44	PASS
Band17	Stand-Alone	15kHz	NaN	QPSK	23790	1@11	22.37	PASS
Band17	Stand-Alone	15kHz	NaN	QPSK	23790	3@3	23.24	PASS
Band17	Stand-Alone	15kHz	NaN	QPSK	23848	1@0	22.36	PASS
Band17	Stand-Alone	15kHz	NaN	QPSK	23848	1@11	22.31	PASS

Band17	Stand-Alone	15kHz	NaN	QPSK	23848	3@3	23.17	PASS
Band18	Stand-Alone	3.75kHz	NaN	BPSK	23852	1@0	22.74	PASS
Band18	Stand-Alone	3.75kHz	NaN	BPSK	23852	1@47	22.73	PASS
Band18	Stand-Alone	3.75kHz	NaN	BPSK	23925	1@0	23.90	PASS
Band18	Stand-Alone	3.75kHz	NaN	BPSK	23925	1@47	23.90	PASS
Band18	Stand-Alone	3.75kHz	NaN	BPSK	23998	1@0	23.15	PASS
Band18	Stand-Alone	3.75kHz	NaN	BPSK	23998	1@47	23.15	PASS
Band18	Stand-Alone	3.75kHz	NaN	QPSK	23852	1@0	22.73	PASS
Band18	Stand-Alone	3.75kHz	NaN	QPSK	23852	1@47	22.72	PASS
Band18	Stand-Alone	3.75kHz	NaN	QPSK	23925	1@0	23.90	PASS
Band18	Stand-Alone	3.75kHz	NaN	QPSK	23925	1@47	23.92	PASS
Band18	Stand-Alone	3.75kHz	NaN	QPSK	23998	1@0	23.06	PASS
Band18	Stand-Alone	3.75kHz	NaN	QPSK	23998	1@47	23.07	PASS
Band18	Stand-Alone	15kHz	NaN	BPSK	23852	1@0	23.11	PASS
Band18	Stand-Alone	15kHz	NaN	BPSK	23852	1@11	23.15	PASS
Band18	Stand-Alone	15kHz	NaN	BPSK	23852	3@3	22.93	PASS
Band18	Stand-Alone	15kHz	NaN	BPSK	23925	1@0	23.12	PASS
Band18	Stand-Alone	15kHz	NaN	BPSK	23925	1@11	23.17	PASS
Band18	Stand-Alone	15kHz	NaN	BPSK	23925	3@3	23.33	PASS
Band18	Stand-Alone	15kHz	NaN	BPSK	23998	1@0	23.01	PASS
Band18	Stand-Alone	15kHz	NaN	BPSK	23998	1@11	22.96	PASS
Band18	Stand-Alone	15kHz	NaN	BPSK	23998	3@3	22.73	PASS
Band18	Stand-Alone	15kHz	NaN	QPSK	23852	1@0	22.99	PASS
Band18	Stand-Alone	15kHz	NaN	QPSK	23852	1@11	23.01	PASS
Band18	Stand-Alone	15kHz	NaN	QPSK	23852	3@3	22.91	PASS
Band18	Stand-Alone	15kHz	NaN	QPSK	23925	1@0	23.13	PASS
Band18	Stand-Alone	15kHz	NaN	QPSK	23925	1@11	23.08	PASS
Band18	Stand-Alone	15kHz	NaN	QPSK	23925	3@3	23.35	PASS
Band18	Stand-Alone	15kHz	NaN	QPSK	23998	1@0	22.78	PASS
Band18	Stand-Alone	15kHz	NaN	QPSK	23998	1@11	22.82	PASS
Band18	Stand-Alone	15kHz	NaN	QPSK	23998	3@3	22.71	PASS
Band19	Stand-Alone	3.75kHz	NaN	BPSK	24002	1@0	23.01	PASS
Band19	Stand-Alone	3.75kHz	NaN	BPSK	24002	1@47	23.01	PASS
Band19	Stand-Alone	3.75kHz	NaN	BPSK	24075	1@0	23.87	PASS
Band19	Stand-Alone	3.75kHz	NaN	BPSK	24075	1@47	23.88	PASS
Band19	Stand-Alone	3.75kHz	NaN	BPSK	24148	1@0	23.37	PASS
Band19	Stand-Alone	3.75kHz	NaN	BPSK	24148	1@47	23.35	PASS
Band19	Stand-Alone	3.75kHz	NaN	QPSK	24002	1@0	23.09	PASS
Band19	Stand-Alone	3.75kHz	NaN	QPSK	24002	1@47	23.04	PASS
Band19	Stand-Alone	3.75kHz	NaN	QPSK	24075	1@0	23.89	PASS
Band19	Stand-Alone	3.75kHz	NaN	QPSK	24075	1@47	23.87	PASS
Band19	Stand-Alone	3.75kHz	NaN	QPSK	24148	1@0	23.38	PASS
Band19	Stand-Alone	3.75kHz	NaN	QPSK	24148	1@47	23.39	PASS
Band19	Stand-Alone	15kHz	NaN	BPSK	24002	1@0	22.93	PASS
Band19	Stand-Alone	15kHz	NaN	BPSK	24002	1@11	22.98	PASS
Band19	Stand-Alone	15kHz	NaN	BPSK	24002	3@3	22.70	PASS

Band19	Stand-Alone	15kHz	NaN	BPSK	24075	1@0	22.96	PASS
Band19	Stand-Alone	15kHz	NaN	BPSK	24075	1@11	23.00	PASS
Band19	Stand-Alone	15kHz	NaN	BPSK	24075	3@3	23.15	PASS
Band19	Stand-Alone	15kHz	NaN	BPSK	24148	1@0	22.84	PASS
Band19	Stand-Alone	15kHz	NaN	BPSK	24148	1@11	22.75	PASS
Band19	Stand-Alone	15kHz	NaN	BPSK	24148	3@3	22.57	PASS
Band19	Stand-Alone	15kHz	NaN	QPSK	24002	1@0	22.78	PASS
Band19	Stand-Alone	15kHz	NaN	QPSK	24002	1@11	22.74	PASS
Band19	Stand-Alone	15kHz	NaN	QPSK	24002	3@3	22.73	PASS
Band19	Stand-Alone	15kHz	NaN	QPSK	24075	1@0	22.92	PASS
Band19	Stand-Alone	15kHz	NaN	QPSK	24075	1@11	22.93	PASS
Band19	Stand-Alone	15kHz	NaN	QPSK	24075	3@3	23.13	PASS
Band19	Stand-Alone	15kHz	NaN	QPSK	24148	1@0	22.61	PASS
Band19	Stand-Alone	15kHz	NaN	QPSK	24148	1@11	22.64	PASS
Band19	Stand-Alone	15kHz	NaN	QPSK	24148	3@3	22.58	PASS
Band25	Stand-Alone	3.75kHz	NaN	BPSK	26042	1@0	23.22	PASS
Band25	Stand-Alone	3.75kHz	NaN	BPSK	26042	1@47	23.21	PASS
Band25	Stand-Alone	3.75kHz	NaN	BPSK	26365	1@0	23.17	PASS
Band25	Stand-Alone	3.75kHz	NaN	BPSK	26365	1@47	23.21	PASS
Band25	Stand-Alone	3.75kHz	NaN	BPSK	26688	1@0	22.86	PASS
Band25	Stand-Alone	3.75kHz	NaN	BPSK	26688	1@47	22.86	PASS
Band25	Stand-Alone	3.75kHz	NaN	QPSK	26042	1@0	23.29	PASS
Band25	Stand-Alone	3.75kHz	NaN	QPSK	26042	1@47	23.27	PASS
Band25	Stand-Alone	3.75kHz	NaN	QPSK	26365	1@0	23.22	PASS
Band25	Stand-Alone	3.75kHz	NaN	QPSK	26365	1@47	23.18	PASS
Band25	Stand-Alone	3.75kHz	NaN	QPSK	26688	1@0	22.92	PASS
Band25	Stand-Alone	3.75kHz	NaN	QPSK	26688	1@47	22.93	PASS
Band25	Stand-Alone	15kHz	NaN	BPSK	26042	1@0	22.60	PASS
Band25	Stand-Alone	15kHz	NaN	BPSK	26042	1@11	22.60	PASS
Band25	Stand-Alone	15kHz	NaN	BPSK	26042	3@3	22.48	PASS
Band25	Stand-Alone	15kHz	NaN	BPSK	26365	1@0	22.56	PASS
Band25	Stand-Alone	15kHz	NaN	BPSK	26365	1@11	22.57	PASS
Band25	Stand-Alone	15kHz	NaN	BPSK	26365	3@3	22.64	PASS
Band25	Stand-Alone	15kHz	NaN	BPSK	26688	1@0	22.52	PASS
Band25	Stand-Alone	15kHz	NaN	BPSK	26688	1@11	22.47	PASS
Band25	Stand-Alone	15kHz	NaN	BPSK	26688	3@3	22.41	PASS
Band25	Stand-Alone	15kHz	NaN	QPSK	26042	1@0	22.63	PASS
Band25	Stand-Alone	15kHz	NaN	QPSK	26042	1@11	22.49	PASS
Band25	Stand-Alone	15kHz	NaN	QPSK	26042	3@3	22.46	PASS
Band25	Stand-Alone	15kHz	NaN	QPSK	26365	1@0	22.43	PASS
Band25	Stand-Alone	15kHz	NaN	QPSK	26365	1@11	22.40	PASS
Band25	Stand-Alone	15kHz	NaN	QPSK	26365	3@3	22.57	PASS
Band25	Stand-Alone	15kHz	NaN	QPSK	26688	1@0	22.46	PASS
Band25	Stand-Alone	15kHz	NaN	QPSK	26688	1@11	22.41	PASS
Band25	Stand-Alone	15kHz	NaN	QPSK	26688	3@3	22.39	PASS
Band26	Stand-Alone	3.75kHz	NaN	BPSK	26692	1@0	22.05	PASS

Band26	Stand-Alone	3.75kHz	NaN	BPSK	26692	1@47	22.05	PASS
Band26	Stand-Alone	3.75kHz	NaN	BPSK	26740	1@0	21.85	PASS
Band26	Stand-Alone	3.75kHz	NaN	BPSK	26740	1@47	21.84	PASS
Band26	Stand-Alone	3.75kHz	NaN	BPSK	26788	1@0	22.03	PASS
Band26	Stand-Alone	3.75kHz	NaN	BPSK	26788	1@47	22.17	PASS
Band26	Stand-Alone	3.75kHz	NaN	QPSK	26692	1@0	22.06	PASS
Band26	Stand-Alone	3.75kHz	NaN	QPSK	26692	1@47	22.03	PASS
Band26	Stand-Alone	3.75kHz	NaN	QPSK	26740	1@0	21.91	PASS
Band26	Stand-Alone	3.75kHz	NaN	QPSK	26740	1@47	21.87	PASS
Band26	Stand-Alone	3.75kHz	NaN	QPSK	26788	1@0	22.07	PASS
Band26	Stand-Alone	3.75kHz	NaN	QPSK	26788	1@47	22.07	PASS
Band26	Stand-Alone	15kHz	NaN	BPSK	26692	1@0	22.25	PASS
Band26	Stand-Alone	15kHz	NaN	BPSK	26692	1@11	22.12	PASS
Band26	Stand-Alone	15kHz	NaN	BPSK	26692	3@3	21.83	PASS
Band26	Stand-Alone	15kHz	NaN	BPSK	26740	1@0	22.07	PASS
Band26	Stand-Alone	15kHz	NaN	BPSK	26740	1@11	21.94	PASS
Band26	Stand-Alone	15kHz	NaN	BPSK	26740	3@3	21.78	PASS
Band26	Stand-Alone	15kHz	NaN	BPSK	26788	1@0	22.14	PASS
Band26	Stand-Alone	15kHz	NaN	BPSK	26788	1@11	22.08	PASS
Band26	Stand-Alone	15kHz	NaN	BPSK	26788	3@3	21.87	PASS
Band26	Stand-Alone	15kHz	NaN	QPSK	26692	1@0	21.99	PASS
Band26	Stand-Alone	15kHz	NaN	QPSK	26692	1@11	21.99	PASS
Band26	Stand-Alone	15kHz	NaN	QPSK	26692	3@3	21.88	PASS
Band26	Stand-Alone	15kHz	NaN	QPSK	26740	1@0	21.98	PASS
Band26	Stand-Alone	15kHz	NaN	QPSK	26740	1@11	21.84	PASS
Band26	Stand-Alone	15kHz	NaN	QPSK	26740	3@3	22.77	PASS
Band26	Stand-Alone	15kHz	NaN	QPSK	26788	1@0	23.00	PASS
Band26	Stand-Alone	15kHz	NaN	QPSK	26788	1@11	23.00	PASS
Band26	Stand-Alone	15kHz	NaN	QPSK	26788	3@3	22.86	PASS
Band26	Stand-Alone	3.75kHz	NaN	BPSK	26792	1@0	22.07	PASS
Band26	Stand-Alone	3.75kHz	NaN	BPSK	26792	1@47	22.08	PASS
Band26	Stand-Alone	3.75kHz	NaN	BPSK	26915	1@0	24.04	PASS
Band26	Stand-Alone	3.75kHz	NaN	BPSK	26915	1@47	24.04	PASS
Band26	Stand-Alone	3.75kHz	NaN	BPSK	27038	1@0	23.33	PASS
Band26	Stand-Alone	3.75kHz	NaN	BPSK	27038	1@47	23.32	PASS
Band26	Stand-Alone	3.75kHz	NaN	QPSK	26792	1@0	22.11	PASS
Band26	Stand-Alone	3.75kHz	NaN	QPSK	26792	1@47	22.13	PASS
Band26	Stand-Alone	3.75kHz	NaN	QPSK	26915	1@0	24.09	PASS
Band26	Stand-Alone	3.75kHz	NaN	QPSK	26915	1@47	24.09	PASS
Band26	Stand-Alone	3.75kHz	NaN	QPSK	27038	1@0	23.41	PASS
Band26	Stand-Alone	3.75kHz	NaN	QPSK	27038	1@47	23.34	PASS
Band26	Stand-Alone	15kHz	NaN	BPSK	26792	1@0	22.19	PASS
Band26	Stand-Alone	15kHz	NaN	BPSK	26792	1@11	22.03	PASS
Band26	Stand-Alone	15kHz	NaN	BPSK	26792	3@3	21.88	PASS
Band26	Stand-Alone	15kHz	NaN	BPSK	26915	1@0	23.70	PASS
Band26	Stand-Alone	15kHz	NaN	BPSK	26915	1@11	23.78	PASS

Band26	Stand-Alone	15kHz	NaN	BPSK	26915	3@3	23.48	PASS
Band26	Stand-Alone	15kHz	NaN	BPSK	27038	1@0	22.65	PASS
Band26	Stand-Alone	15kHz	NaN	BPSK	27038	1@11	22.76	PASS
Band26	Stand-Alone	15kHz	NaN	BPSK	27038	3@3	22.50	PASS
Band26	Stand-Alone	15kHz	NaN	QPSK	26792	1@0	22.12	PASS
Band26	Stand-Alone	15kHz	NaN	QPSK	26792	1@11	22.01	PASS
Band26	Stand-Alone	15kHz	NaN	QPSK	26792	3@3	21.89	PASS
Band26	Stand-Alone	15kHz	NaN	QPSK	26915	1@0	23.67	PASS
Band26	Stand-Alone	15kHz	NaN	QPSK	26915	1@11	23.58	PASS
Band26	Stand-Alone	15kHz	NaN	QPSK	26915	3@3	23.46	PASS
Band26	Stand-Alone	15kHz	NaN	QPSK	27038	1@0	22.52	PASS
Band26	Stand-Alone	15kHz	NaN	QPSK	27038	1@11	22.58	PASS
Band26	Stand-Alone	15kHz	NaN	QPSK	27038	3@3	22.51	PASS
Band66	Stand-Alone	3.75kHz	NaN	BPSK	131974	1@0	23.12	PASS
Band66	Stand-Alone	3.75kHz	NaN	BPSK	131974	1@47	23.10	PASS
Band66	Stand-Alone	3.75kHz	NaN	BPSK	132322	1@0	23.43	PASS
Band66	Stand-Alone	3.75kHz	NaN	BPSK	132322	1@47	23.45	PASS
Band66	Stand-Alone	3.75kHz	NaN	BPSK	132670	1@0	23.46	PASS
Band66	Stand-Alone	3.75kHz	NaN	BPSK	132670	1@47	23.45	PASS
Band66	Stand-Alone	3.75kHz	NaN	QPSK	131974	1@0	23.19	PASS
Band66	Stand-Alone	3.75kHz	NaN	QPSK	131974	1@47	23.15	PASS
Band66	Stand-Alone	3.75kHz	NaN	QPSK	132322	1@0	23.45	PASS
Band66	Stand-Alone	3.75kHz	NaN	QPSK	132322	1@47	23.45	PASS
Band66	Stand-Alone	3.75kHz	NaN	QPSK	132670	1@0	23.50	PASS
Band66	Stand-Alone	3.75kHz	NaN	QPSK	132670	1@47	23.50	PASS
Band66	Stand-Alone	15kHz	NaN	BPSK	131974	1@0	22.55	PASS
Band66	Stand-Alone	15kHz	NaN	BPSK	131974	1@11	22.52	PASS
Band66	Stand-Alone	15kHz	NaN	BPSK	131974	3@3	22.42	PASS
Band66	Stand-Alone	15kHz	NaN	BPSK	132322	1@0	22.88	PASS
Band66	Stand-Alone	15kHz	NaN	BPSK	132322	1@11	22.86	PASS
Band66	Stand-Alone	15kHz	NaN	BPSK	132322	3@3	22.94	PASS
Band66	Stand-Alone	15kHz	NaN	BPSK	132670	1@0	22.59	PASS
Band66	Stand-Alone	15kHz	NaN	BPSK	132670	1@11	22.62	PASS
Band66	Stand-Alone	15kHz	NaN	BPSK	132670	3@3	22.53	PASS
Band66	Stand-Alone	15kHz	NaN	QPSK	131974	1@0	22.37	PASS
Band66	Stand-Alone	15kHz	NaN	QPSK	131974	1@11	22.39	PASS
Band66	Stand-Alone	15kHz	NaN	QPSK	131974	3@3	22.44	PASS
Band66	Stand-Alone	15kHz	NaN	QPSK	132322	1@0	22.75	PASS
Band66	Stand-Alone	15kHz	NaN	QPSK	132322	1@11	22.72	PASS
Band66	Stand-Alone	15kHz	NaN	QPSK	132322	3@3	22.88	PASS
Band66	Stand-Alone	15kHz	NaN	QPSK	132670	1@0	22.69	PASS
Band66	Stand-Alone	15kHz	NaN	QPSK	132670	1@11	22.56	PASS
Band66	Stand-Alone	15kHz	NaN	QPSK	132670	3@3	22.57	PASS
Band85	Stand-Alone	3.75kHz	NaN	BPSK	134004	1@0	22.58	PASS
Band85	Stand-Alone	3.75kHz	NaN	BPSK	134004	1@47	22.56	PASS
Band85	Stand-Alone	3.75kHz	NaN	BPSK	134092	1@0	22.14	PASS

Band85	Stand-Alone	3.75kHz	NaN	BPSK	134092	1@47	22.16	PASS
Band85	Stand-Alone	3.75kHz	NaN	BPSK	134180	1@0	21.95	PASS
Band85	Stand-Alone	3.75kHz	NaN	BPSK	134180	1@47	21.96	PASS
Band85	Stand-Alone	3.75kHz	NaN	QPSK	134004	1@0	22.66	PASS
Band85	Stand-Alone	3.75kHz	NaN	QPSK	134004	1@47	22.64	PASS
Band85	Stand-Alone	3.75kHz	NaN	QPSK	134092	1@0	22.25	PASS
Band85	Stand-Alone	3.75kHz	NaN	QPSK	134092	1@47	22.20	PASS
Band85	Stand-Alone	3.75kHz	NaN	QPSK	134180	1@0	22.01	PASS
Band85	Stand-Alone	3.75kHz	NaN	QPSK	134180	1@47	22.00	PASS
Band85	Stand-Alone	15kHz	NaN	BPSK	134004	1@0	23.43	PASS
Band85	Stand-Alone	15kHz	NaN	BPSK	134004	1@11	23.41	PASS
Band85	Stand-Alone	15kHz	NaN	BPSK	134004	3@3	23.02	PASS
Band85	Stand-Alone	15kHz	NaN	BPSK	134092	1@0	21.58	PASS
Band85	Stand-Alone	15kHz	NaN	BPSK	134092	1@11	21.50	PASS
Band85	Stand-Alone	15kHz	NaN	BPSK	134092	3@3	22.23	PASS
Band85	Stand-Alone	15kHz	NaN	BPSK	134180	1@0	21.46	PASS
Band85	Stand-Alone	15kHz	NaN	BPSK	134180	1@11	21.31	PASS
Band85	Stand-Alone	15kHz	NaN	BPSK	134180	3@3	22.06	PASS
Band85	Stand-Alone	15kHz	NaN	QPSK	134004	1@0	23.23	PASS
Band85	Stand-Alone	15kHz	NaN	QPSK	134004	1@11	23.12	PASS
Band85	Stand-Alone	15kHz	NaN	QPSK	134004	3@3	23.02	PASS
Band85	Stand-Alone	15kHz	NaN	QPSK	134092	1@0	21.47	PASS
Band85	Stand-Alone	15kHz	NaN	QPSK	134092	1@11	21.40	PASS
Band85	Stand-Alone	15kHz	NaN	QPSK	134092	3@3	22.26	PASS
Band85	Stand-Alone	15kHz	NaN	QPSK	134180	1@0	21.26	PASS
Band85	Stand-Alone	15kHz	NaN	QPSK	134180	1@11	21.18	PASS
Band85	Stand-Alone	15kHz	NaN	QPSK	134180	3@3	22.03	PASS

<b>4.2 Peak-to-Average Ratio(CCDF)</b>	<b>VERDICT: PASS</b>
--	----------------------

4.2.1 Limit	
NB-IoT Band	Standard
5/18/19/26	FCC §2.1046 and §22.913(d): The peak-to-average ratio (PAR) of the transmission must not exceed 13 dB. FCC §90.635: N/A
2/25	FCC §2.1046 and §24.2329(d): In measuring transmissions in this band using an average power technique, the peak-to-average ratio (PAR) of the transmission may not exceed 13 dB.
12/13/17/85	FCC §27.50(c)(10): N/A FCC §27.50(b)(10): N/A
4/66	FCC §27.50(d)(5): In measuring transmissions in this band using an average power technique, the peak-to-average ratio (PAR) of the transmission may not exceed 13 dB.

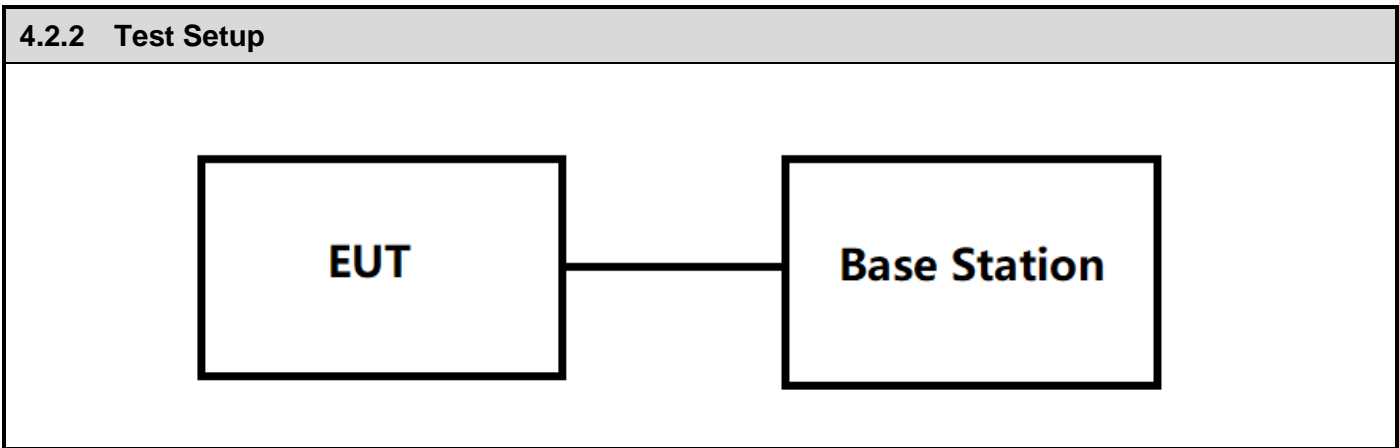

4.2.3 Test Procedure			
	References Rule	Chapter	Item
<input checked="" type="checkbox"/>	ANSI C63.26-2015	5.2	RF output power measurement procedures
<p>The conducted RF Output Power measurements were made at the RF output terminals of the EUT using the power meter of the Universal Radio Communication tester R&amp;S CMW500, selecting maximum transmission power of the EUT and different modes of modulation.</p> <p>Peak to average ratio(PAPR) is used equation <math>PAPR(dB)=PPK(dBm)-PAVG(dBm)</math>, where PPK is measured peak power, and PAVG is measured average power.</p> <p>The maximum equivalent isotropically radiated power(e.i.r.p.) is calculated by adding the declared maximum antenna gain(dBi).</p> <p>The maximum effective radiated power e.r.p. is calculated form the maximum equivalent isotropically radiated power(e.i.r.p.) by subtracting 2.15 dB: <math>E.R.P = E.I.R.P. - 2.15 dB</math></p>			

#### 4.2.4 Test Data

Band	OpMode	SCS	BW	Modu	Channel	Tones	Result (dBm)	Limit (dBm)	Verdict
Band2	Stand-Alone	3.75kHz	NaN	BPSK	18876	1@0	3.84	<=13	PASS
Band2	Stand-Alone	3.75kHz	NaN	BPSK	18876	1@47	3.79	<=13	PASS
Band2	Stand-Alone	3.75kHz	NaN	QPSK	18876	1@0	4.31	<=13	PASS
Band2	Stand-Alone	3.75kHz	NaN	QPSK	18876	1@47	3.72	<=13	PASS
Band2	Stand-Alone	15kHz	NaN	BPSK	18876	1@0	8.26	<=13	PASS
Band2	Stand-Alone	15kHz	NaN	BPSK	18876	1@11	7.72	<=13	PASS
Band2	Stand-Alone	15kHz	NaN	BPSK	18876	3@3	12.11	<=13	PASS
Band2	Stand-Alone	15kHz	NaN	QPSK	18876	1@0	8.33	<=13	PASS
Band2	Stand-Alone	15kHz	NaN	QPSK	18876	1@11	8.78	<=13	PASS
Band2	Stand-Alone	15kHz	NaN	QPSK	18876	3@3	12.58	<=13	PASS
Band4	Stand-Alone	3.75kHz	NaN	BPSK	20175	1@0	4.99	<=13	PASS
Band4	Stand-Alone	3.75kHz	NaN	BPSK	20175	1@47	4.03	<=13	PASS
Band4	Stand-Alone	3.75kHz	NaN	QPSK	20175	1@0	4.1	<=13	PASS
Band4	Stand-Alone	3.75kHz	NaN	QPSK	20175	1@47	4.63	<=13	PASS
Band4	Stand-Alone	15kHz	NaN	BPSK	20175	1@0	9.16	<=13	PASS
Band4	Stand-Alone	15kHz	NaN	BPSK	20175	1@11	6.96	<=13	PASS
Band4	Stand-Alone	15kHz	NaN	BPSK	20175	3@3	12.73	<=13	PASS
Band4	Stand-Alone	15kHz	NaN	QPSK	20175	1@0	9.08	<=13	PASS
Band4	Stand-Alone	15kHz	NaN	QPSK	20175	1@11	6.12	<=13	PASS
Band4	Stand-Alone	15kHz	NaN	QPSK	20175	3@3	12.2	<=13	PASS
Band5	Stand-Alone	3.75kHz	NaN	BPSK	20525	1@0	4.56	<=13	PASS
Band5	Stand-Alone	3.75kHz	NaN	BPSK	20525	1@47	4.51	<=13	PASS
Band5	Stand-Alone	3.75kHz	NaN	QPSK	20525	1@0	4.29	<=13	PASS
Band5	Stand-Alone	3.75kHz	NaN	QPSK	20525	1@47	4.65	<=13	PASS
Band5	Stand-Alone	15kHz	NaN	BPSK	20525	1@0	9.04	<=13	PASS
Band5	Stand-Alone	15kHz	NaN	BPSK	20525	1@11	7.33	<=13	PASS
Band5	Stand-Alone	15kHz	NaN	BPSK	20525	3@3	11.87	<=13	PASS
Band5	Stand-Alone	15kHz	NaN	QPSK	20525	1@0	8.28	<=13	PASS
Band5	Stand-Alone	15kHz	NaN	QPSK	20525	1@11	6.99	<=13	PASS
Band5	Stand-Alone	15kHz	NaN	QPSK	20525	3@3	12.92	<=13	PASS
Band12	Stand-Alone	3.75kHz	NaN	BPSK	23095	1@0	2.08	<=13	PASS
Band12	Stand-Alone	3.75kHz	NaN	BPSK	23095	1@47	2.13	<=13	PASS
Band12	Stand-Alone	3.75kHz	NaN	QPSK	23095	1@0	3.04	<=13	PASS
Band12	Stand-Alone	3.75kHz	NaN	QPSK	23095	1@47	2.01	<=13	PASS
Band12	Stand-Alone	15kHz	NaN	BPSK	23095	1@0	3.77	<=13	PASS
Band12	Stand-Alone	15kHz	NaN	BPSK	23095	1@11	3.65	<=13	PASS
Band12	Stand-Alone	15kHz	NaN	BPSK	23095	3@3	11.25	<=13	PASS
Band12	Stand-Alone	15kHz	NaN	QPSK	23095	1@0	7.3	<=13	PASS
Band12	Stand-Alone	15kHz	NaN	QPSK	23095	1@11	4.59	<=13	PASS
Band12	Stand-Alone	15kHz	NaN	QPSK	23095	3@3	12.04	<=13	PASS
Band13	Stand-Alone	3.75kHz	NaN	BPSK	23230	1@0	1.62	<=13	PASS



Band13	Stand-Alone	3.75kHz	NaN	BPSK	23230	1@47	1.93	<=13	PASS
Band13	Stand-Alone	3.75kHz	NaN	QPSK	23230	1@0	2.72	<=13	PASS
Band13	Stand-Alone	3.75kHz	NaN	QPSK	23230	1@47	2.28	<=13	PASS
Band13	Stand-Alone	15kHz	NaN	BPSK	23230	1@0	3.21	<=13	PASS
Band13	Stand-Alone	15kHz	NaN	BPSK	23230	1@11	3.29	<=13	PASS
Band13	Stand-Alone	15kHz	NaN	BPSK	23230	3@3	9.2	<=13	PASS
Band13	Stand-Alone	15kHz	NaN	QPSK	23230	1@0	4.45	<=13	PASS
Band13	Stand-Alone	15kHz	NaN	QPSK	23230	1@11	4.83	<=13	PASS
Band13	Stand-Alone	15kHz	NaN	QPSK	23230	3@3	9.4	<=13	PASS
Band17	Stand-Alone	3.75kHz	NaN	BPSK	23790	1@0	1.7	<=13	PASS
Band17	Stand-Alone	3.75kHz	NaN	BPSK	23790	1@47	2.47	<=13	PASS
Band17	Stand-Alone	3.75kHz	NaN	QPSK	23790	1@0	2.08	<=13	PASS
Band17	Stand-Alone	3.75kHz	NaN	QPSK	23790	1@47	2.17	<=13	PASS
Band17	Stand-Alone	15kHz	NaN	BPSK	23790	1@0	5.2	<=13	PASS
Band17	Stand-Alone	15kHz	NaN	BPSK	23790	1@11	5.71	<=13	PASS
Band17	Stand-Alone	15kHz	NaN	BPSK	23790	3@3	10.19	<=13	PASS
Band17	Stand-Alone	15kHz	NaN	QPSK	23790	1@0	3.83	<=13	PASS
Band17	Stand-Alone	15kHz	NaN	QPSK	23790	1@11	5.33	<=13	PASS
Band17	Stand-Alone	15kHz	NaN	QPSK	23790	3@3	10.08	<=13	PASS
Band18	Stand-Alone	3.75kHz	NaN	BPSK	23925	1@0	4.07	<=13	PASS
Band18	Stand-Alone	3.75kHz	NaN	BPSK	23925	1@47	3.9	<=13	PASS
Band18	Stand-Alone	3.75kHz	NaN	QPSK	23925	1@0	5.13	<=13	PASS
Band18	Stand-Alone	3.75kHz	NaN	QPSK	23925	1@47	4.78	<=13	PASS
Band18	Stand-Alone	15kHz	NaN	BPSK	23925	1@0	8.52	<=13	PASS
Band18	Stand-Alone	15kHz	NaN	BPSK	23925	1@11	8.63	<=13	PASS
Band18	Stand-Alone	15kHz	NaN	BPSK	23925	3@3	12.17	<=13	PASS
Band18	Stand-Alone	15kHz	NaN	QPSK	23925	1@0	8.62	<=13	PASS
Band18	Stand-Alone	15kHz	NaN	QPSK	23925	1@11	6.94	<=13	PASS
Band18	Stand-Alone	15kHz	NaN	QPSK	23925	3@3	12.88	<=13	PASS
Band19	Stand-Alone	3.75kHz	NaN	BPSK	24075	1@0	4.18	<=13	PASS
Band19	Stand-Alone	3.75kHz	NaN	BPSK	24075	1@47	4.86	<=13	PASS
Band19	Stand-Alone	3.75kHz	NaN	QPSK	24075	1@0	4.09	<=13	PASS
Band19	Stand-Alone	3.75kHz	NaN	QPSK	24075	1@47	3.74	<=13	PASS
Band19	Stand-Alone	15kHz	NaN	BPSK	24075	1@0	6.37	<=13	PASS
Band19	Stand-Alone	15kHz	NaN	BPSK	24075	1@11	6.93	<=13	PASS
Band19	Stand-Alone	15kHz	NaN	BPSK	24075	3@3	12.05	<=13	PASS
Band19	Stand-Alone	15kHz	NaN	QPSK	24075	1@0	10.33	<=13	PASS
Band19	Stand-Alone	15kHz	NaN	QPSK	24075	1@11	6.56	<=13	PASS
Band19	Stand-Alone	15kHz	NaN	QPSK	24075	3@3	12.96	<=13	PASS
Band25	Stand-Alone	3.75kHz	NaN	BPSK	26365	1@0	3.7	<=13	PASS
Band25	Stand-Alone	3.75kHz	NaN	BPSK	26365	1@47	4.1	<=13	PASS
Band25	Stand-Alone	3.75kHz	NaN	QPSK	26365	1@0	5.11	<=13	PASS
Band25	Stand-Alone	3.75kHz	NaN	QPSK	26365	1@47	4.02	<=13	PASS
Band25	Stand-Alone	15kHz	NaN	BPSK	26365	1@0	8.54	<=13	PASS
Band25	Stand-Alone	15kHz	NaN	BPSK	26365	1@11	8.73	<=13	PASS
Band25	Stand-Alone	15kHz	NaN	BPSK	26365	3@3	12.37	<=13	PASS

Band25	Stand-Alone	15kHz	NaN	QPSK	26365	1@0	9.1	<=13	PASS
Band25	Stand-Alone	15kHz	NaN	QPSK	26365	1@11	9.42	<=13	PASS
Band25	Stand-Alone	15kHz	NaN	QPSK	26365	3@3	11.66	<=13	PASS
Band26	Stand-Alone	3.75kHz	NaN	BPSK	26740	1@0	1.52	<=13	PASS
Band26	Stand-Alone	3.75kHz	NaN	BPSK	26740	1@47	1.47	<=13	PASS
Band26	Stand-Alone	3.75kHz	NaN	QPSK	26740	1@0	2.06	<=13	PASS
Band26	Stand-Alone	3.75kHz	NaN	QPSK	26740	1@47	1.24	<=13	PASS
Band26	Stand-Alone	15kHz	NaN	BPSK	26740	1@0	2.96	<=13	PASS
Band26	Stand-Alone	15kHz	NaN	BPSK	26740	1@11	3.18	<=13	PASS
Band26	Stand-Alone	15kHz	NaN	BPSK	26740	3@3	12.93	<=13	PASS
Band26	Stand-Alone	15kHz	NaN	QPSK	26740	1@0	5.45	<=13	PASS
Band26	Stand-Alone	15kHz	NaN	QPSK	26740	1@11	2.64	<=13	PASS
Band26	Stand-Alone	15kHz	NaN	QPSK	26740	3@3	11.5	<=13	PASS
Band26	Stand-Alone	3.75kHz	NaN	BPSK	26915	1@0	1.58	<=13	PASS
Band26	Stand-Alone	3.75kHz	NaN	BPSK	26915	1@47	1.72	<=13	PASS
Band26	Stand-Alone	3.75kHz	NaN	QPSK	26915	1@0	2.34	<=13	PASS
Band26	Stand-Alone	3.75kHz	NaN	QPSK	26915	1@47	3.09	<=13	PASS
Band26	Stand-Alone	15kHz	NaN	BPSK	26915	1@0	4.07	<=13	PASS
Band26	Stand-Alone	15kHz	NaN	BPSK	26915	1@11	3.52	<=13	PASS
Band26	Stand-Alone	15kHz	NaN	BPSK	26915	3@3	9.56	<=13	PASS
Band26	Stand-Alone	15kHz	NaN	QPSK	26915	1@0	6.88	<=13	PASS
Band26	Stand-Alone	15kHz	NaN	QPSK	26915	1@11	6.46	<=13	PASS
Band26	Stand-Alone	15kHz	NaN	QPSK	26915	3@3	10.52	<=13	PASS
Band66	Stand-Alone	3.75kHz	NaN	BPSK	132322	1@0	5.1	<=13	PASS
Band66	Stand-Alone	3.75kHz	NaN	BPSK	132322	1@47	3.89	<=13	PASS
Band66	Stand-Alone	3.75kHz	NaN	QPSK	132322	1@0	4.38	<=13	PASS
Band66	Stand-Alone	3.75kHz	NaN	QPSK	132322	1@47	4.08	<=13	PASS
Band66	Stand-Alone	15kHz	NaN	BPSK	132322	1@0	9.11	<=13	PASS
Band66	Stand-Alone	15kHz	NaN	BPSK	132322	1@11	9.99	<=13	PASS
Band66	Stand-Alone	15kHz	NaN	BPSK	132322	3@3	12.85	<=13	PASS
Band66	Stand-Alone	15kHz	NaN	QPSK	132322	1@0	8.84	<=13	PASS
Band66	Stand-Alone	15kHz	NaN	QPSK	132322	1@11	7.19	<=13	PASS
Band66	Stand-Alone	15kHz	NaN	QPSK	132322	3@3	12.44	<=13	PASS
Band85	Stand-Alone	3.75kHz	NaN	BPSK	134092	1@0	1.45	<=13	PASS
Band85	Stand-Alone	3.75kHz	NaN	BPSK	134092	1@47	1.79	<=13	PASS
Band85	Stand-Alone	3.75kHz	NaN	QPSK	134092	1@0	2.69	<=13	PASS
Band85	Stand-Alone	3.75kHz	NaN	QPSK	134092	1@47	2.92	<=13	PASS
Band85	Stand-Alone	15kHz	NaN	BPSK	134092	1@0	3.78	<=13	PASS
Band85	Stand-Alone	15kHz	NaN	BPSK	134092	1@11	3.72	<=13	PASS
Band85	Stand-Alone	15kHz	NaN	BPSK	134092	3@3	11.16	<=13	PASS
Band85	Stand-Alone	15kHz	NaN	QPSK	134092	1@0	4.97	<=13	PASS
Band85	Stand-Alone	15kHz	NaN	QPSK	134092	1@11	4.23	<=13	PASS
Band85	Stand-Alone	15kHz	NaN	QPSK	134092	3@3	10.71	<=13	PASS

Test Graphs

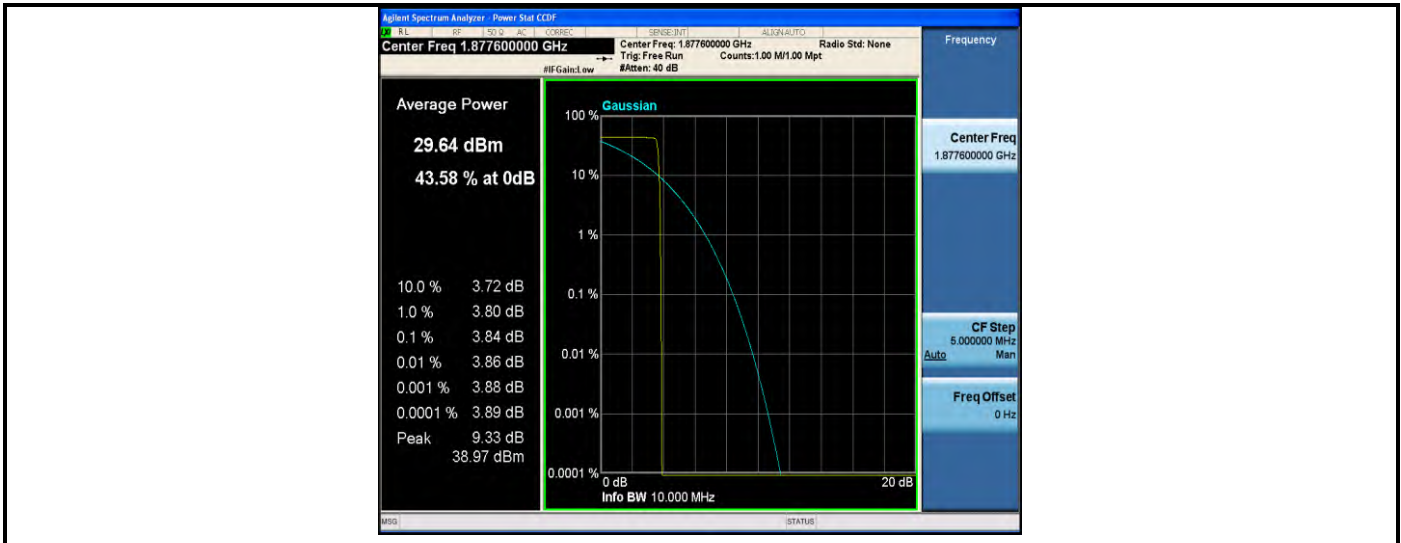

Band2-Stand-Alone-NaN-BPSK-18876-1 @0-3.75kHz-3.84-<=13-PASS

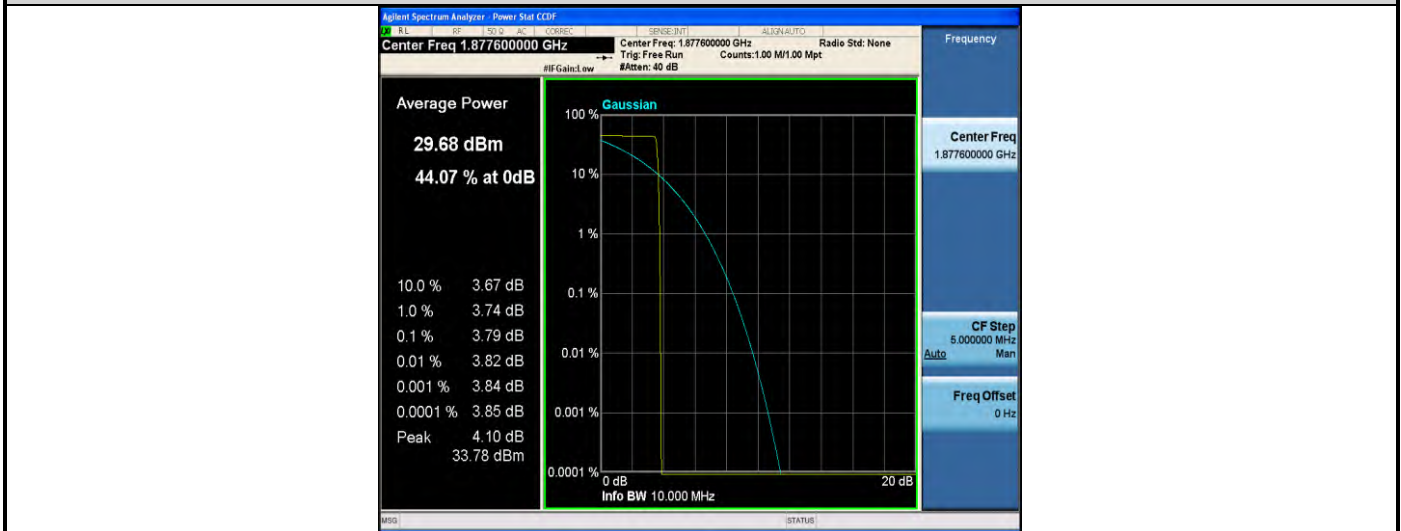

Band2-Stand-Alone-NaN-BPSK-18876-1 @47-3.75kHz-3.79-<=13-PASS

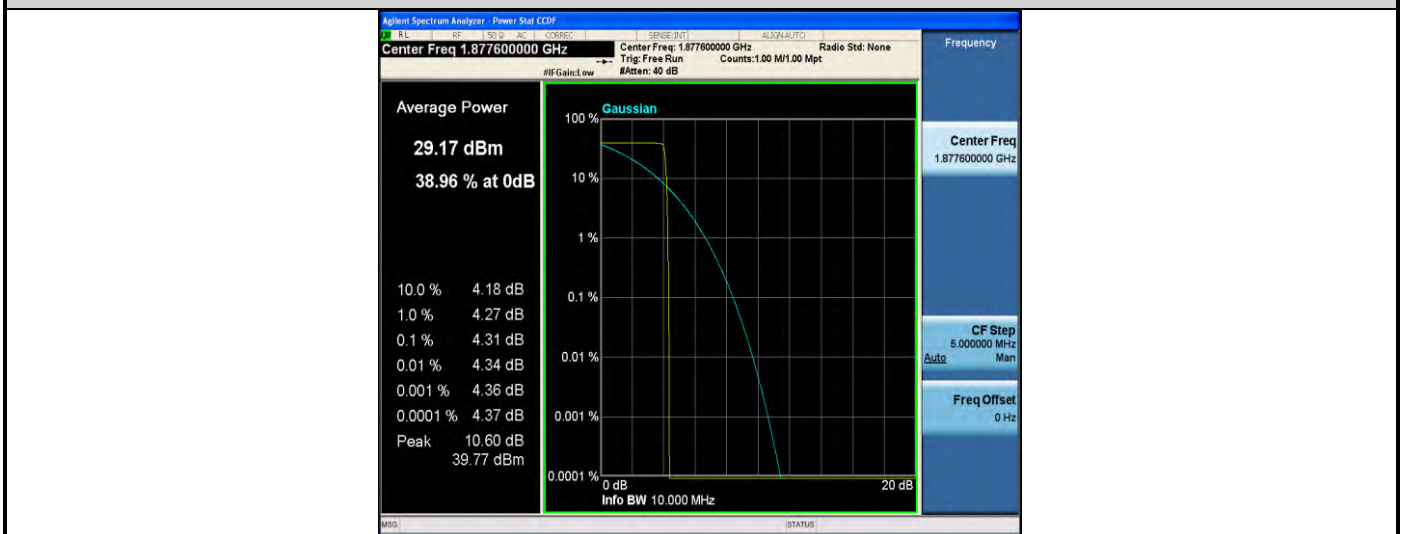

Band2-Stand-Alone-NaN-QPSK-18876-1 @0-3.75kHz-4.31-<=13-PASS



Band2-Stand-Alone-NaN-QPSK-18876-1@47-3.75kHz-3.72-<=13-PASS



Band2-Stand-Alone-NaN-BPSK-18876-1@0-15kHz-8.26-<=13-PASS



Band2-Stand-Alone-NaN-BPSK-18876-1@11-15kHz-7.72-<=13-PASS



Band2-Stand-Alone-NaN-BPSK-18876-3@3-15kHz-12.11-<=13-PASS



Band2-Stand-Alone-NaN-QPSK-18876-1@0-15kHz-8.33-<=13-PASS



Band2-Stand-Alone-NaN-QPSK-18876-1@11-15kHz-8.78-<=13-PASS



Band2-Stand-Alone-NaN-QPSK-18876-3@3-15kHz-12.58-<=13-PASS

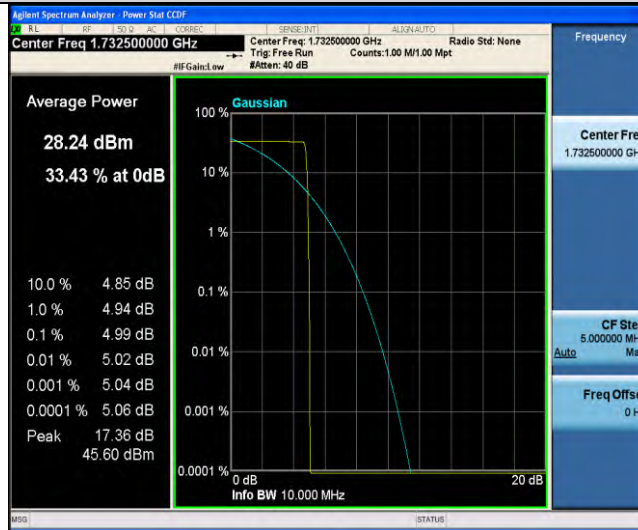

Band4-Stand-Alone-NaN-BPSK-20175-1@0-3.75kHz-4.99-<=13-PASS

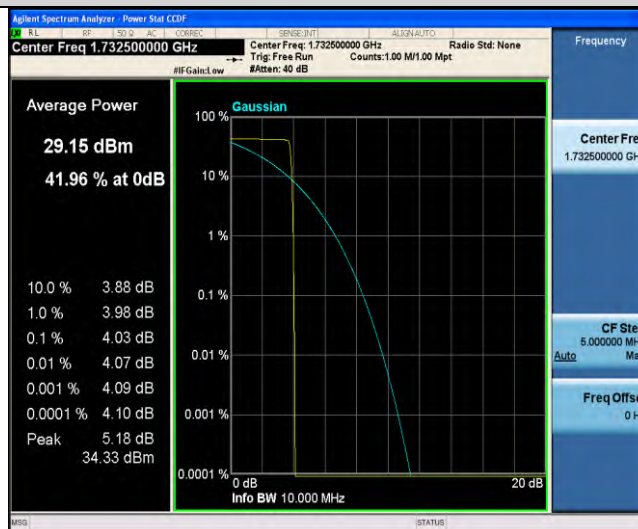

Band4-Stand-Alone-NaN-BPSK-20175-1@47-3.75kHz-4.03-<=13-PASS



Band4-Stand-Alone-Na-N-QPSK-20175-1@0-3.75kHz-4.1-<=13-PASS



Band4-Stand-Alone-Na-N-QPSK-20175-1@47-3.75kHz-4.63-<=13-PASS



Band4-Stand-Alone-Na-N-BPSK-20175-1@0-15kHz-9.16-<=13-PASS

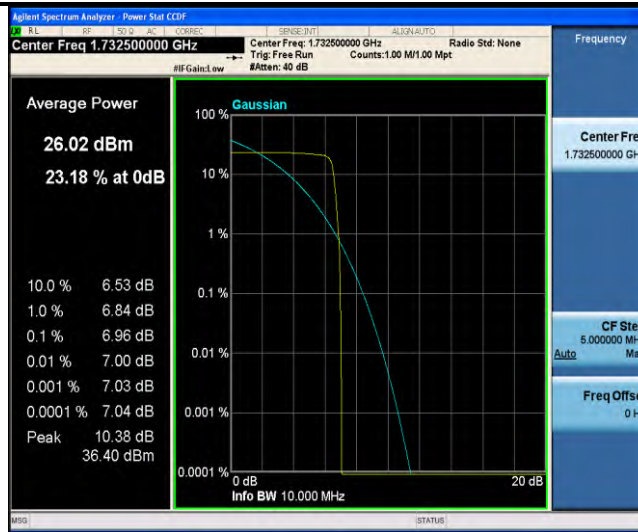

Band4-Stand-Alone-NaN-BPSK-20175-1 @ 11-15kHz-6.96-<=13-PASS



Band4-Stand-Alone-NaN-BPSK-20175-3 @ 3-15kHz-12.73-<=13-PASS

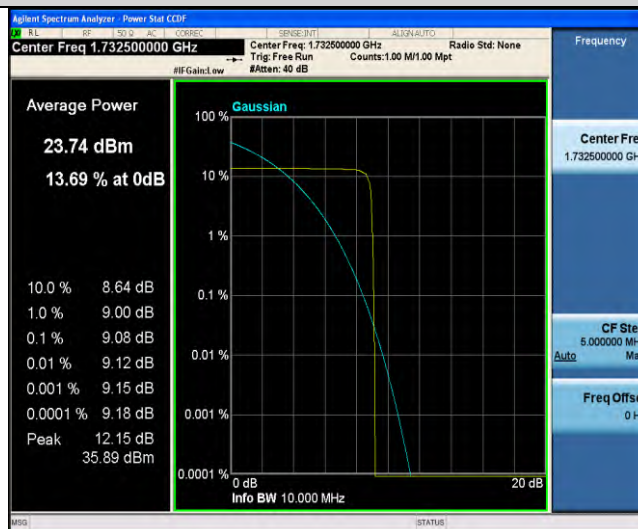

Band4-Stand-Alone-NaN-QPSK-20175-1 @ 0-15kHz-9.08-<=13-PASS





Band4-Stand-Alone-NaN-QPSK-20175-1 @ 11-15kHz-6.12-<=13-PASS



Band4-Stand-Alone-NaN-QPSK-20175-3 @ 3-15kHz-12.2-<=13-PASS

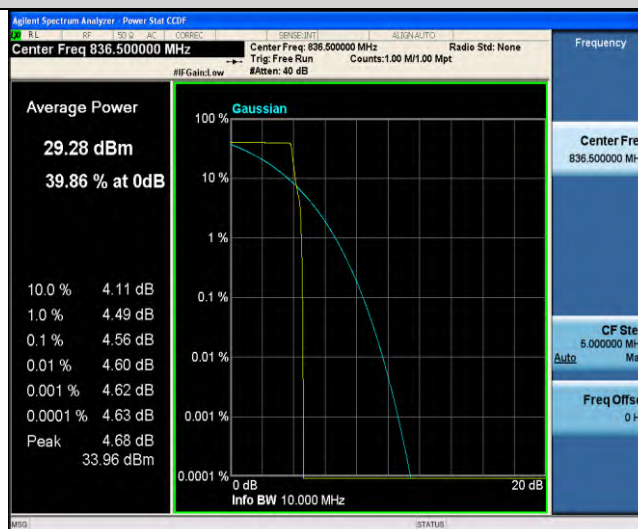

Band5-Stand-Alone-NaN-BPSK-20525-1 @ 0-3.75kHz-4.56-<=13-PASS

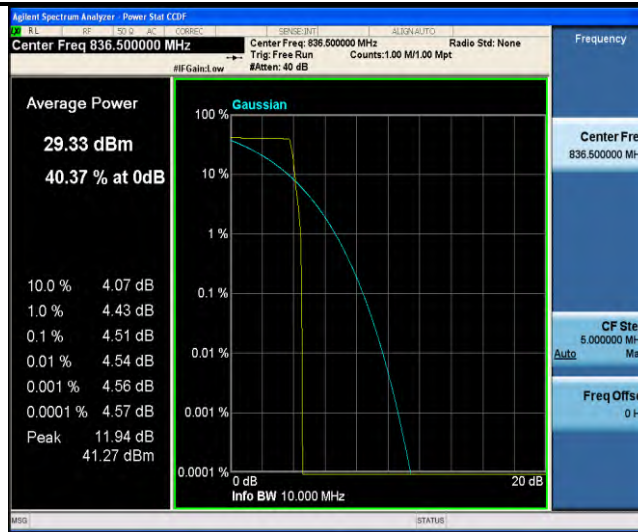

Band5-Stand-Alone-NaN-BPSK-20525-1 @47-3.75kHz-4.51-<=13-PASS



Band5-Stand-Alone-NaN-QPSK-20525-1 @0-3.75kHz-4.29-<=13-PASS



Band5-Stand-Alone-NaN-QPSK-20525-1 @47-3.75kHz-4.65-<=13-PASS



Band5-Stand-Alone-NaN-BPSK-20525-1 @ 0-15kHz-9.04-<=13-PASS



Band5-Stand-Alone-NaN-BPSK-20525-1 @ 11-15kHz-7.33-<=13-PASS



Band5-Stand-Alone-NaN-BPSK-20525-3 @ 3-15kHz-11.87-<=13-PASS



Band5-Stand-Alone-NaN-QPSK-20525-1 @ 0-15kHz-8.28-<=13-PASS



Band5-Stand-Alone-NaN-QPSK-20525-1 @ 11-15kHz-6.99-<=13-PASS



Band5-Stand-Alone-NaN-QPSK-20525-3 @ 3-15kHz-12.92-<=13-PASS

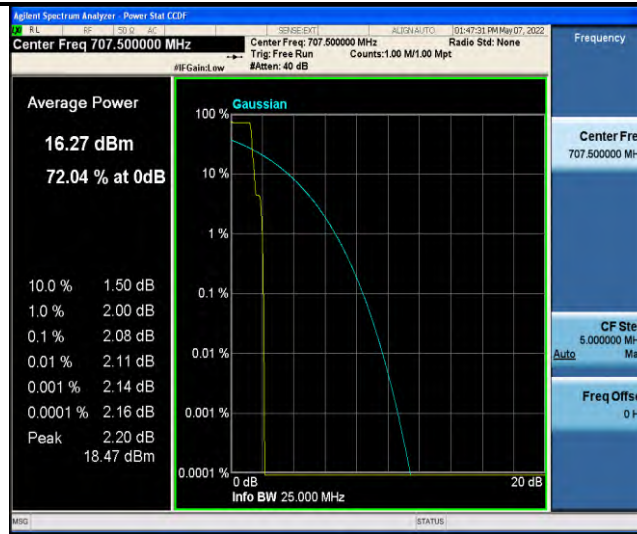

Band12-Stand-Alone-NaN-BPSK-23095-1 @0-3.75kHz-2.08-<=13-PASS



Band12-Stand-Alone-NaN-BPSK-23095-1 @47-3.75kHz-2.13-<=13-PASS

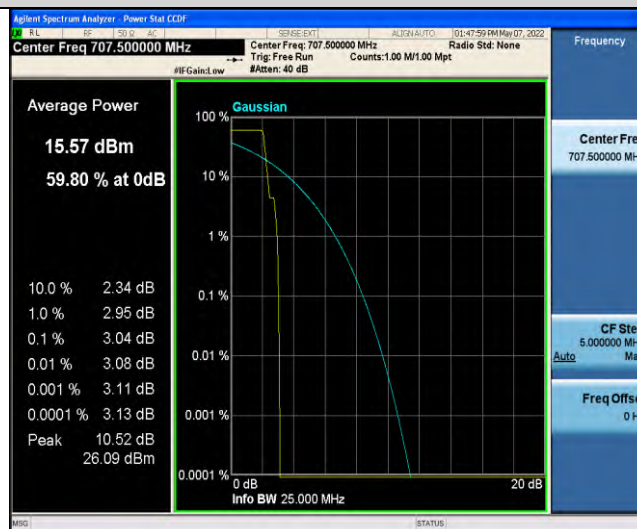

Band12-Stand-Alone-NaN-QPSK-23095-1 @0-3.75kHz-3.04-<=13-PASS



Band12-Stand-Alone-NaN-QPSK-23095-1 @47-3.75kHz-2.01-<=13-PASS



Band12-Stand-Alone-NaN-BPSK-23095-1 @0-15kHz-3.77-<=13-PASS



Band12-Stand-Alone-NaN-BPSK-23095-1 @ 11-15kHz-3.65-<=13-PASS



Band12-Stand-Alone-NaN-BPSK-23095-3@3-15kHz-11.25-<=13-PASS

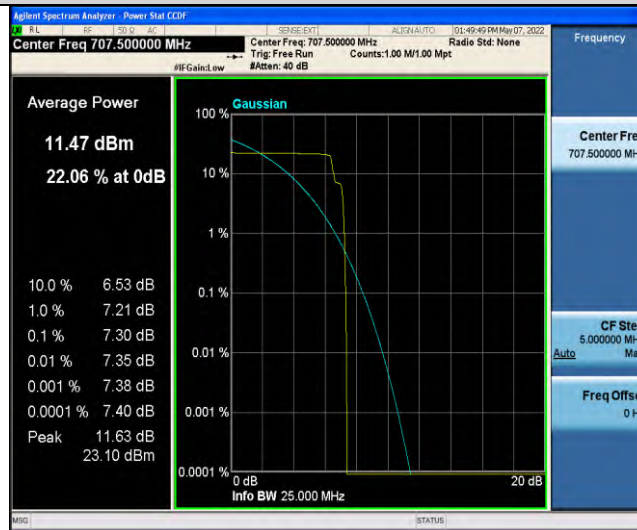

Band12-Stand-Alone-NaN-QPSK-23095-1@0-15kHz-7.3-<=13-PASS



Band12-Stand-Alone-NaN-QPSK-23095-1@11-15kHz-4.59-<=13-PASS



Band12-Stand-Alone-NaN-QPSK-23095-3@3-15kHz-12.04-<=13-PASS



Band13-Stand-Alone-NaN-BPSK-23230-1@0-3.75kHz-1.62-<=13-PASS

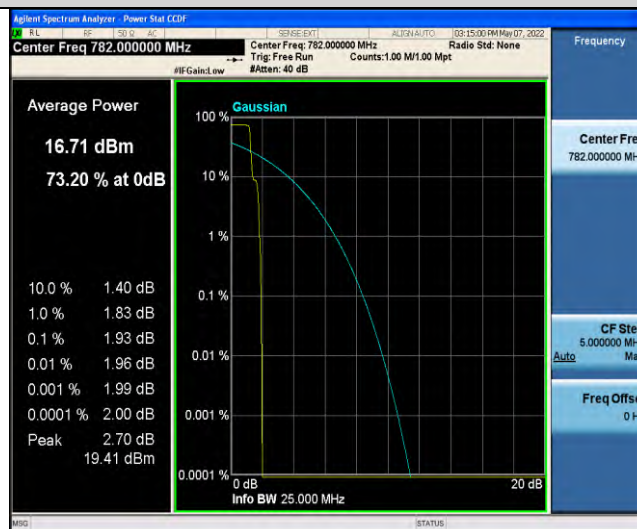

Band13-Stand-Alone-NaN-BPSK-23230-1@47-3.75kHz-1.93-<=13-PASS



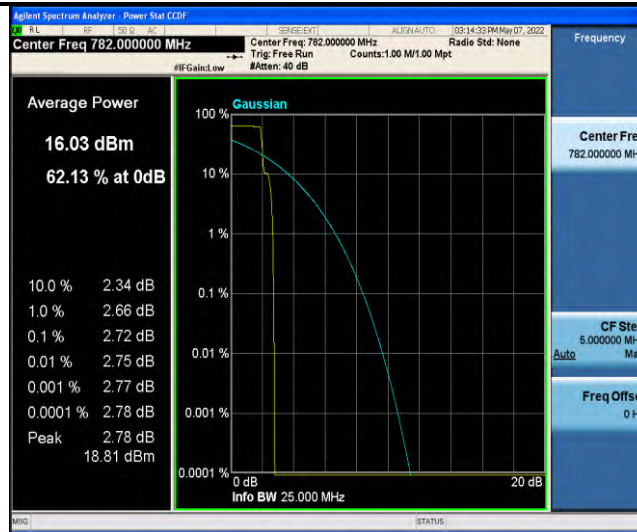

Band13-Stand-Alone-NaN-QPSK-23230-1 @0-3.75kHz-2.72-<=13-PASS



Band13-Stand-Alone-NaN-QPSK-23230-1 @47-3.75kHz-2.28-<=13-PASS

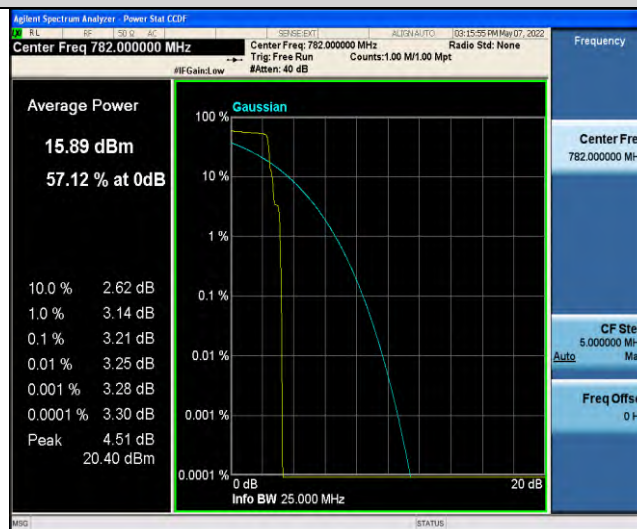

Band13-Stand-Alone-NaN-BPSK-23230-1 @0-15kHz-3.21-<=13-PASS

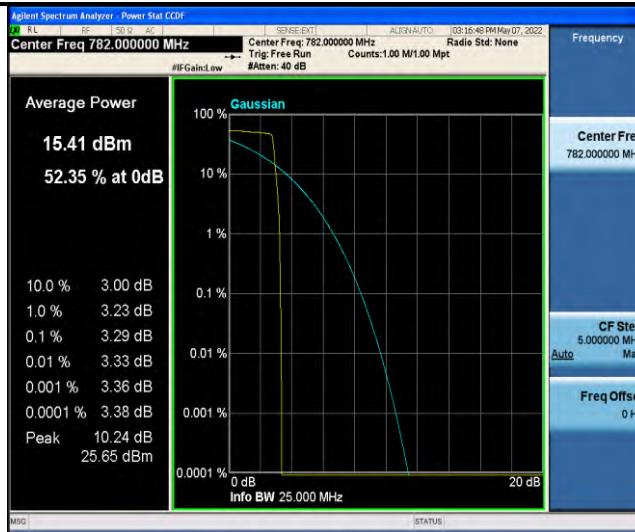

Band13-Stand-Alone-NaN-BPSK-23230-1 @ 11-15kHz-3.29-<=13-PASS



Band13-Stand-Alone-NaN-BPSK-23230-3 @ 3-15kHz-9.2-<=13-PASS



Band13-Stand-Alone-NaN-QPSK-23230-1 @ 0-15kHz-4.45-<=13-PASS



Band13-Stand-Alone-NaN-QPSK-23230-1 @ 11-15kHz-4.83-<=13-PASS

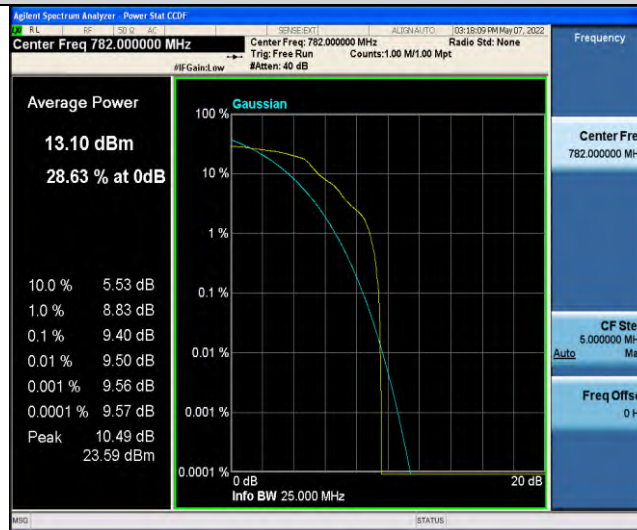

Band13-Stand-Alone-NaN-QPSK-23230-3 @ 3-15kHz-9.4-<=13-PASS

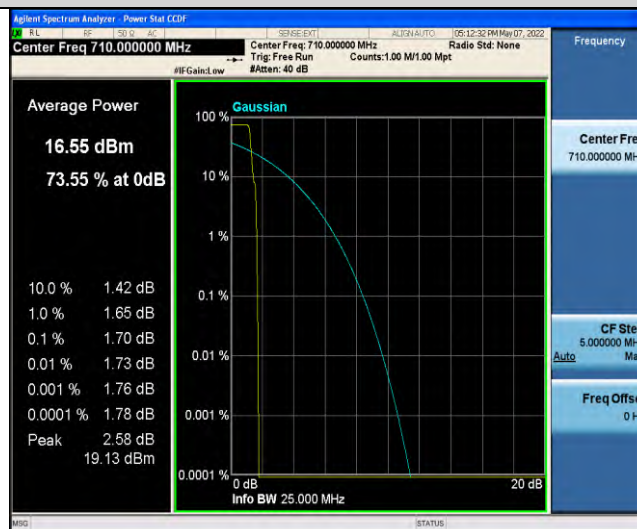

Band17-Stand-Alone-NaN-BPSK-23790-1 @ 0-3.75kHz-1.7-<=13-PASS



Band17-Stand-Alone-NaN-BPSK-23790-1 @47-3.75kHz-2.47-<=13-PASS

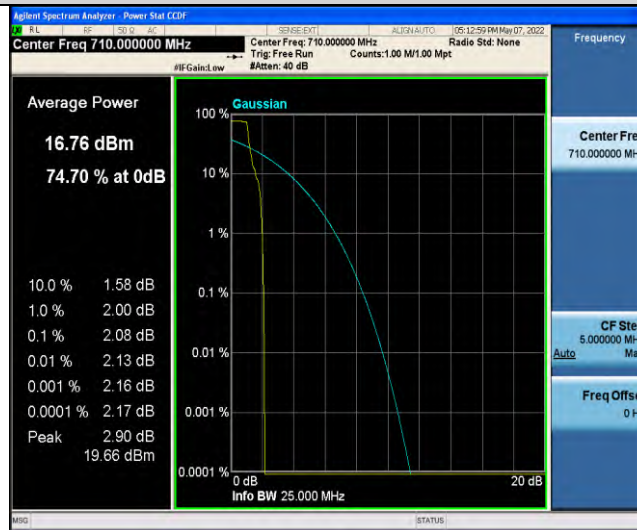

Band17-Stand-Alone-NaN-QPSK-23790-1 @0-3.75kHz-2.08-<=13-PASS

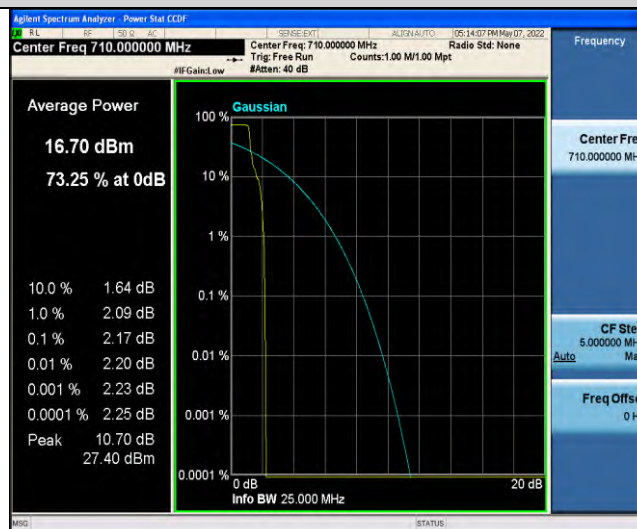

Band17-Stand-Alone-NaN-QPSK-23790-1 @47-3.75kHz-2.17-<=13-PASS

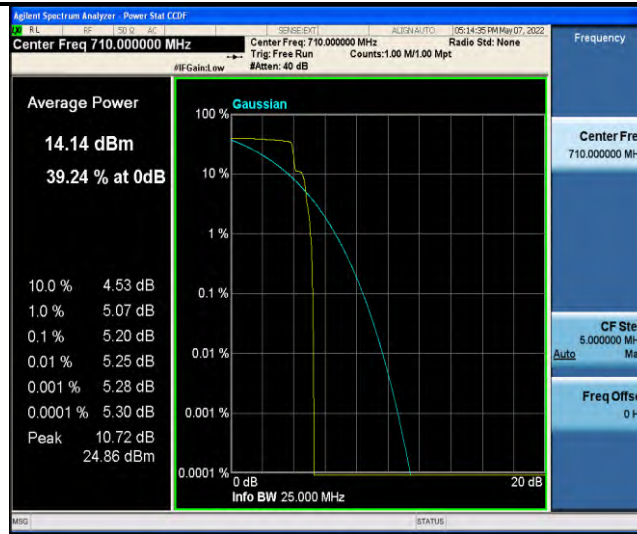

Band17-Stand-Alone-NaN-BPSK-23790-1 @ 0-15kHz-5.2-<=13-PASS

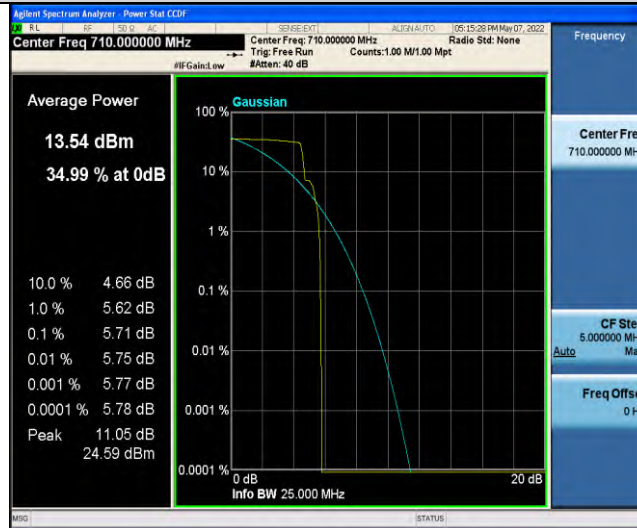

Band17-Stand-Alone-NaN-BPSK-23790-1 @ 11-15kHz-5.71-<=13-PASS

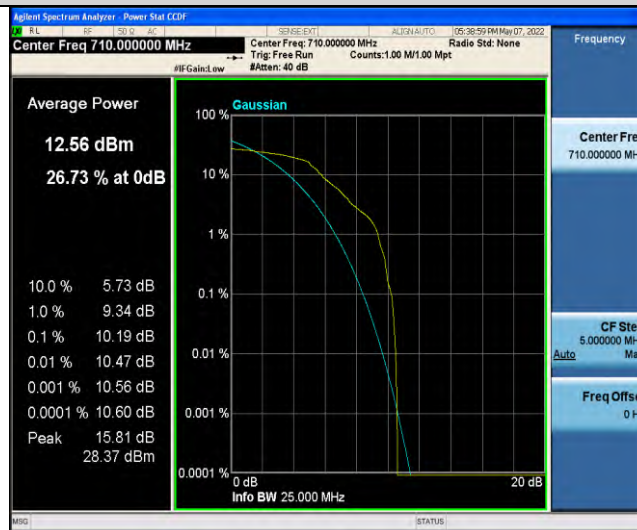

Band17-Stand-Alone-NaN-BPSK-23790-3 @ 3-15kHz-10.19-<=13-PASS



Band17-Stand-Alone-NaN-QPSK-23790-1 @0-15kHz-3.83-<=13-PASS

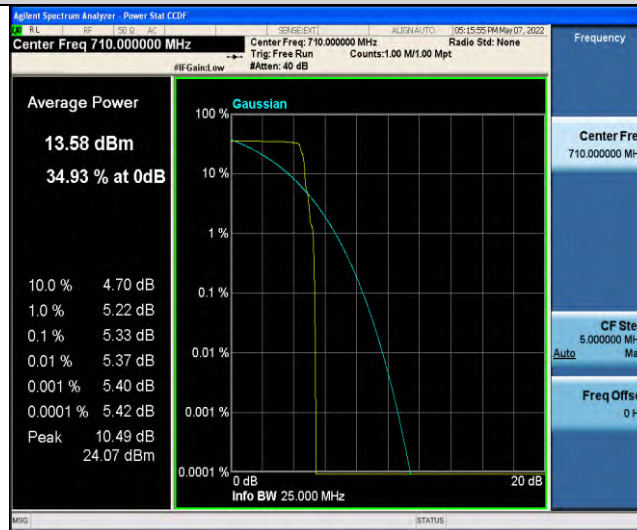

Band17-Stand-Alone-NaN-QPSK-23790-1 @11-15kHz-5.33-<=13-PASS

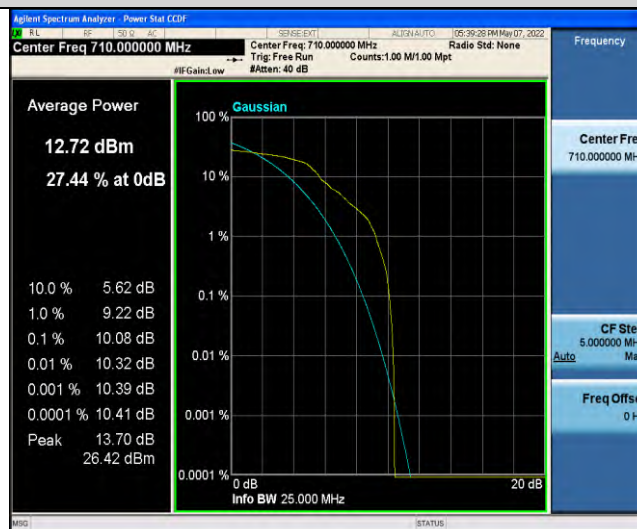

Band17-Stand-Alone-NaN-QPSK-23790-3 @3-15kHz-10.08-<=13-PASS



Band18-Stand-Alone-NaN-BPSK-23925-1 @0-3.75kHz-4.07-<=13-PASS



Band18-Stand-Alone-NaN-BPSK-23925-1 @47-3.75kHz-3.9-<=13-PASS



Band18-Stand-Alone-NaN-QPSK-23925-1 @0-3.75kHz-5.13-<=13-PASS



Band18-Stand-Alone-NaN-QPSK-23925-1 @47-3.75kHz-4.78-<=13-PASS

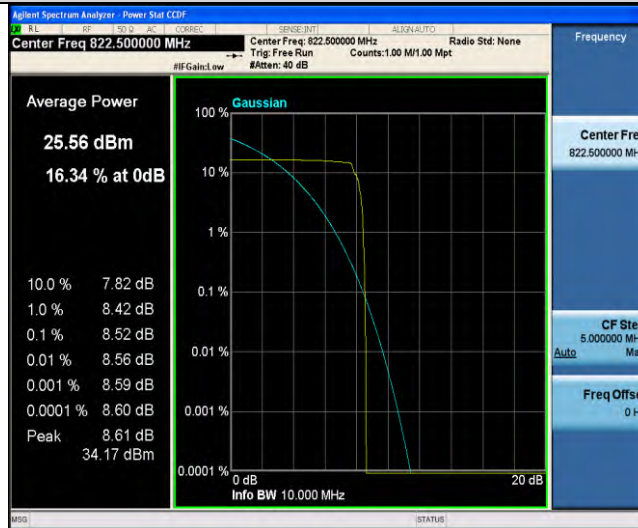

Band18-Stand-Alone-NaN-BPSK-23925-1 @0-15kHz-8.52-<=13-PASS



Band18-Stand-Alone-NaN-BPSK-23925-1 @11-15kHz-8.63-<=13-PASS





Band18-Stand-Alone-NaN-BPSK-23925-3@3-15kHz-12.17-<=13-PASS



Band18-Stand-Alone-NaN-QPSK-23925-1 @0-15kHz-8.62-<=13-PASS

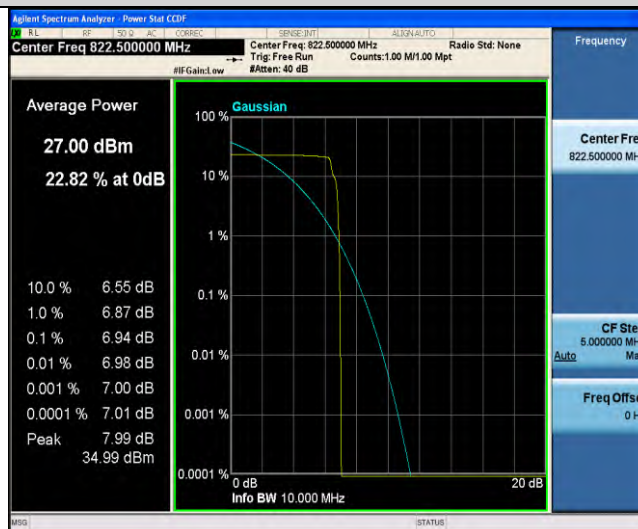

Band18-Stand-Alone-NaN-QPSK-23925-1 @11-15kHz-6.94-<=13-PASS



Band18-Stand-Alone-NaN-QPSK-23925-3@3-15kHz-12.88-<=13-PASS



Band19-Stand-Alone-NaN-BPSK-24075-1@0-3.75kHz-4.18-<=13-PASS

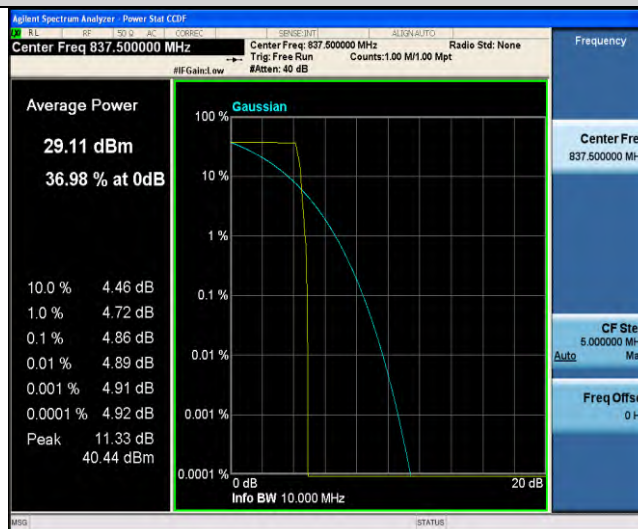

Band19-Stand-Alone-NaN-BPSK-24075-1@47-3.75kHz-4.86-<=13-PASS



Band19-Stand-Alone-NaN-QPSK-24075-1 @0-3.75kHz-4.09-<=13-PASS

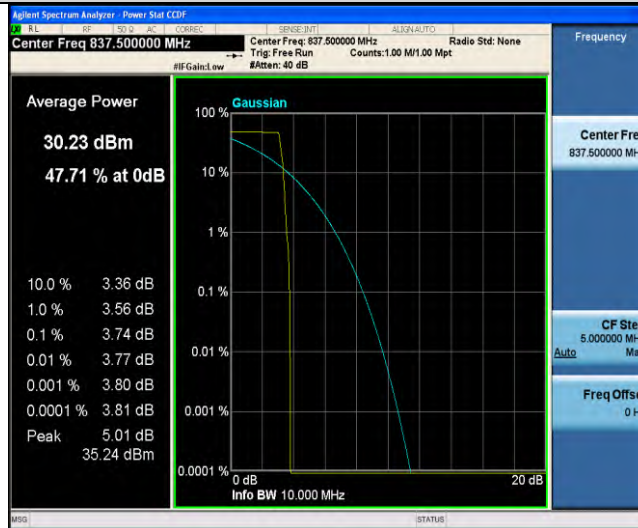

Band19-Stand-Alone-NaN-QPSK-24075-1 @47-3.75kHz-3.74-<=13-PASS

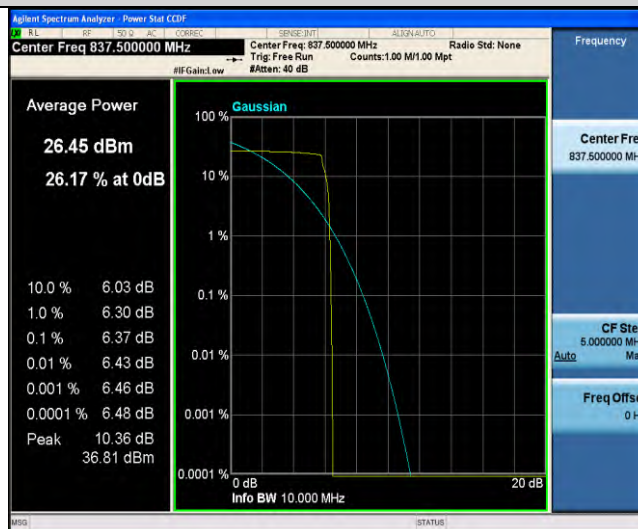

Band19-Stand-Alone-NaN-BPSK-24075-1 @0-15kHz-6.37-<=13-PASS



Band19-Stand-Alone-NaN-BPSK-24075-1 @ 11-15kHz-6.93-<=13-PASS



Band19-Stand-Alone-NaN-BPSK-24075-3 @ 3-15kHz-12.05-<=13-PASS

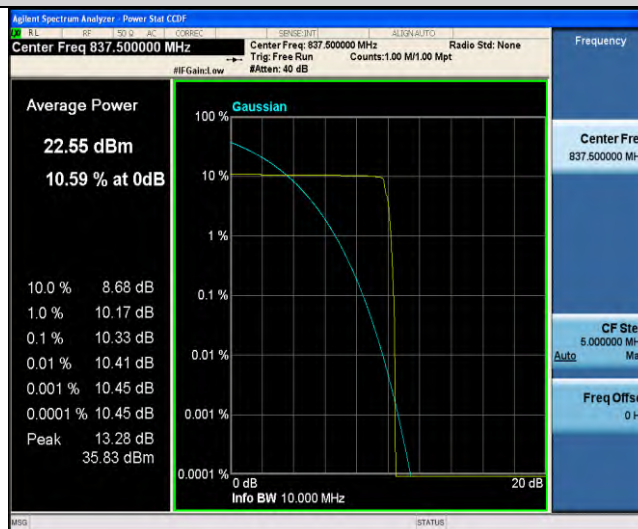

Band19-Stand-Alone-NaN-QPSK-24075-1 @ 0-15kHz-10.33-<=13-PASS



Band19-Stand-Alone-NaN-QPSK-24075-1 @ 11-15kHz-6.56-<=13-PASS



Band19-Stand-Alone-NaN-QPSK-24075-3 @ 3-15kHz-12.96-<=13-PASS

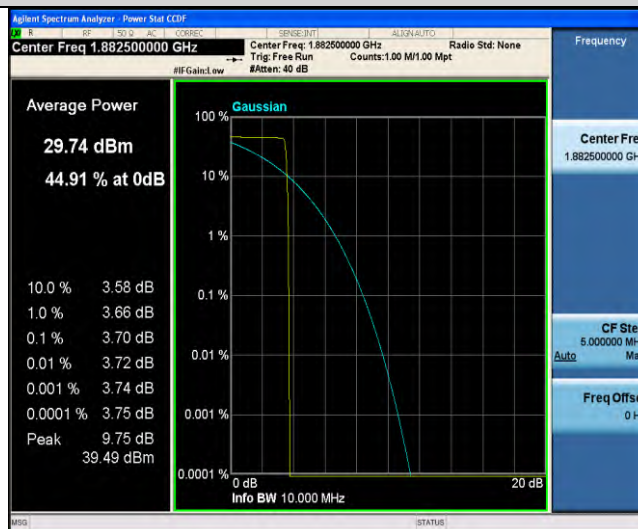

Band25-Stand-Alone-NaN-BPSK-26365-1 @ 0-3.75kHz-3.7-<=13-PASS



Band25-Stand-Alone-NaN-BPSK-26365-1 @47-3.75kHz-4.1-<=13-PASS

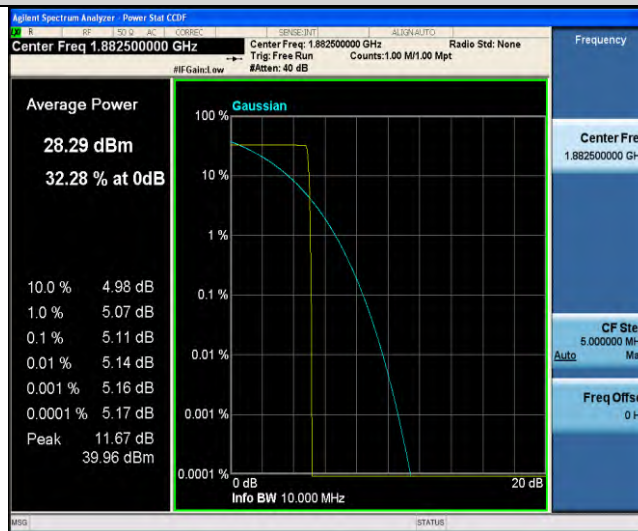

Band25-Stand-Alone-NaN-QPSK-26365-1 @0-3.75kHz-5.11-<=13-PASS



Band25-Stand-Alone-NaN-QPSK-26365-1 @47-3.75kHz-4.02-<=13-PASS



Band25-Stand-Alone-NaN-BPSK-26365-1 @ 0-15kHz-8.54-<=13-PASS

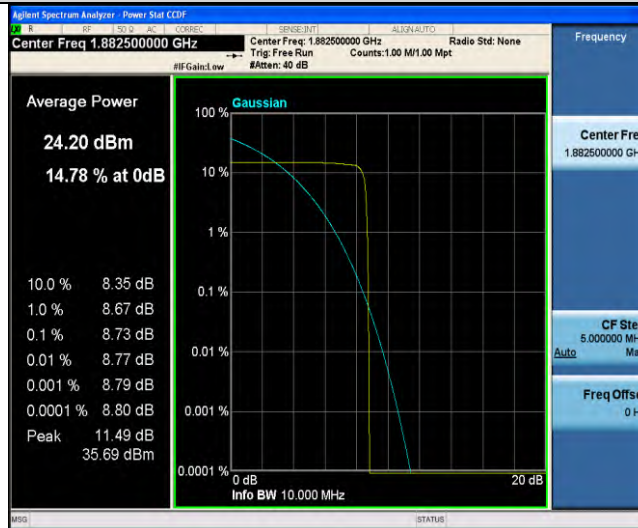

Band25-Stand-Alone-NaN-BPSK-26365-1 @ 11-15kHz-8.73-<=13-PASS

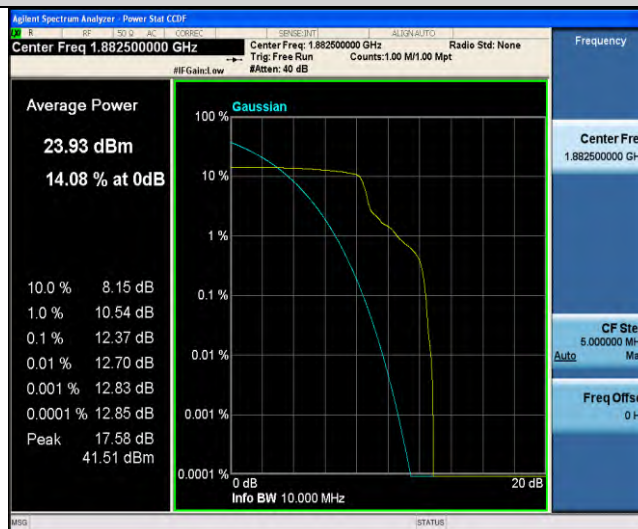

Band25-Stand-Alone-NaN-BPSK-26365-3 @ 3-15kHz-12.37-<=13-PASS

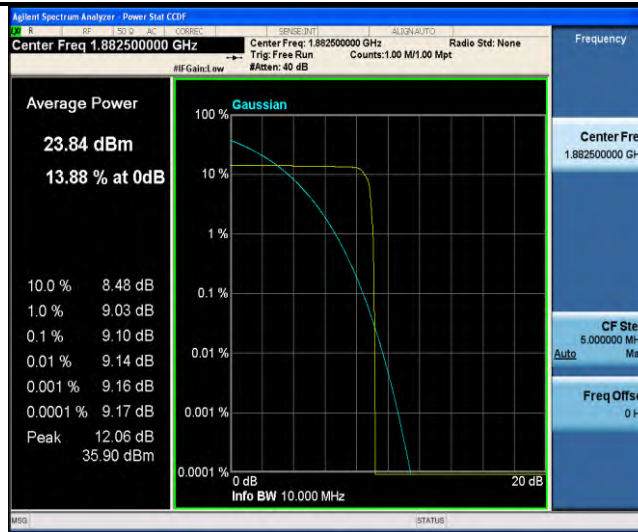

Band25-Stand-Alone-NaN-QPSK-26365-1 @ 0-15kHz-9.1-<=13-PASS

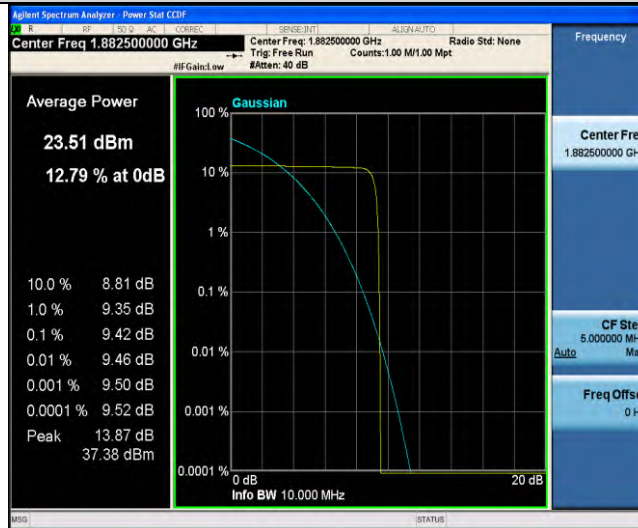

Band25-Stand-Alone-NaN-QPSK-26365-1 @ 11-15kHz-9.42-<=13-PASS



Band26-Stand-Alone-NaN-BPSK-26740-1 @ 0-3.75kHz-1.52-<=13-PASS





Band26-Stand-Alone-NaN-BPSK-26740-1 @47-3.75kHz-1.47-<=13-PASS

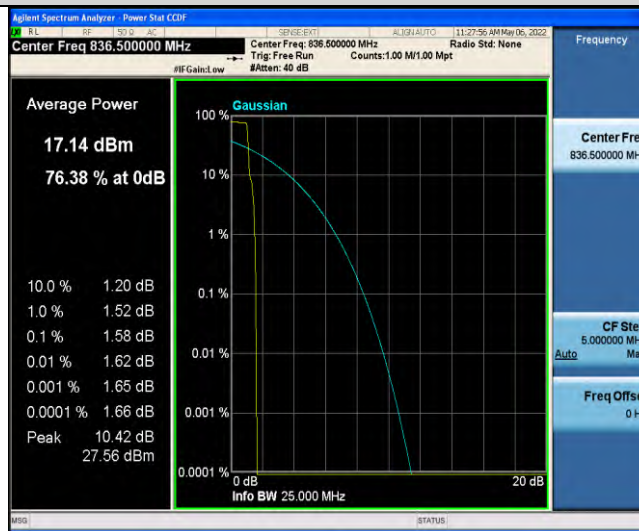

Band26-Stand-Alone-NaN-BPSK-26915-1 @0-3.75kHz-1.58-<=13-PASS



Band26-Stand-Alone-NaN-BPSK-26915-1 @47-3.75kHz-1.72-<=13-PASS

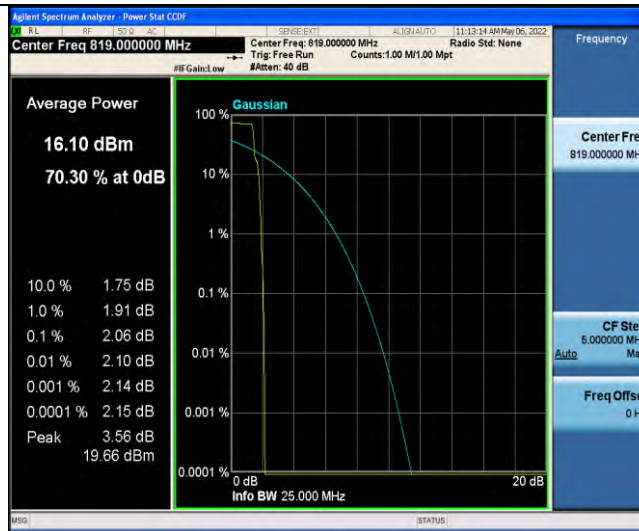

Band26-Stand-Alone-NaN-QPSK-26740-1 @0-3.75kHz-2.06-<=13-PASS

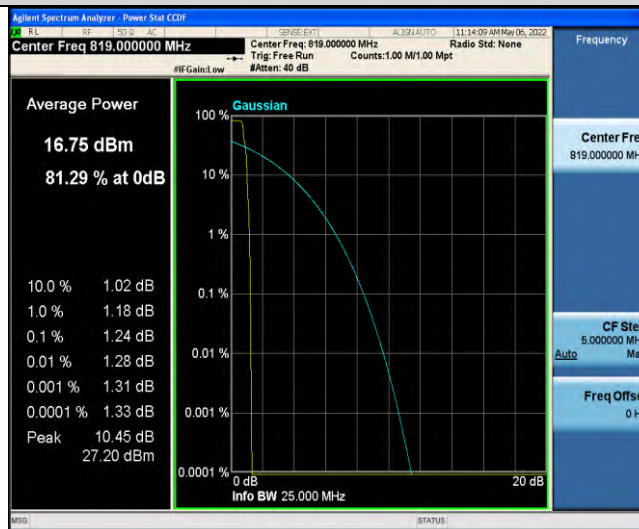

Band26-Stand-Alone-NaN-QPSK-26740-1 @47-3.75kHz-1.24-<=13-PASS

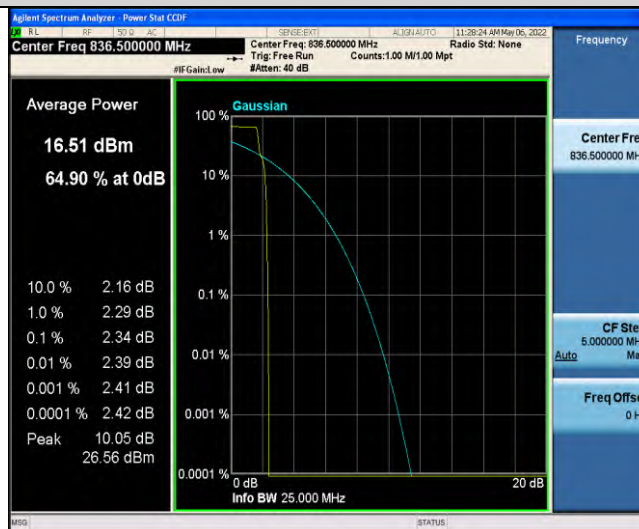

Band26-Stand-Alone-NaN-QPSK-26915-1 @0-3.75kHz-2.34-<=13-PASS

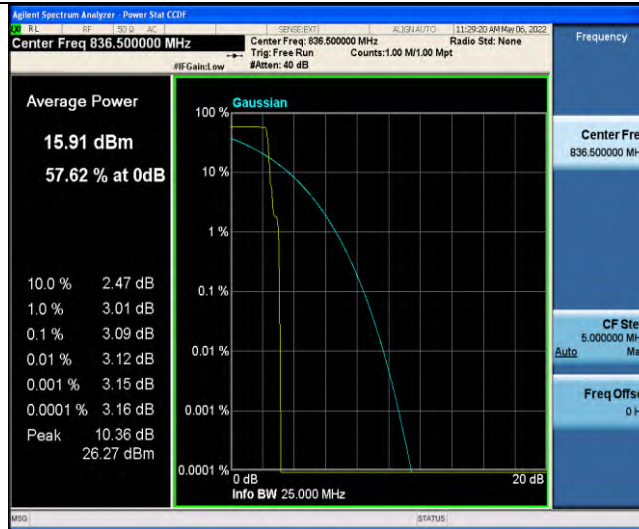

Band26-Stand-Alone-NaN-QPSK-26915-1 @47-3.75kHz-3.09-<=13-PASS



Band26-Stand-Alone-NaN-BPSK-26740-1 @0-15kHz-2.96-<=13-PASS

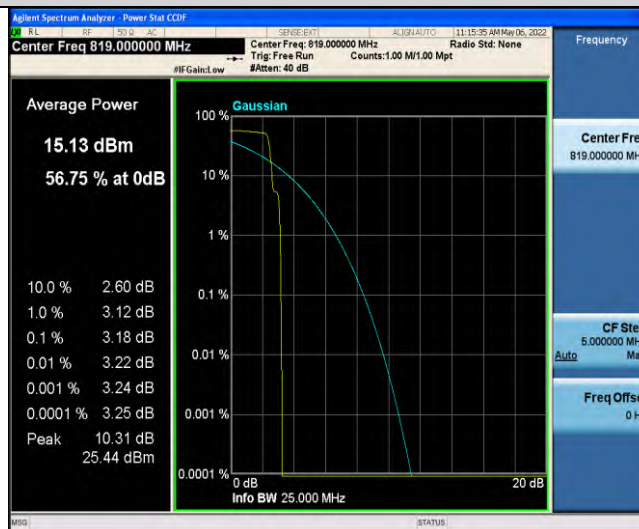

Band26-Stand-Alone-NaN-BPSK-26740-1 @ 11-15kHz-3.18-<=13-PASS



Band26-Stand-Alone-NaN-BPSK-26740-3@3-15kHz-12.93-<=13-PASS



Band26-Stand-Alone-NaN-BPSK-26915-1@0-15kHz-4.07-<=13-PASS



Band26-Stand-Alone-NaN-BPSK-26915-1@11-15kHz-3.52-<=13-PASS

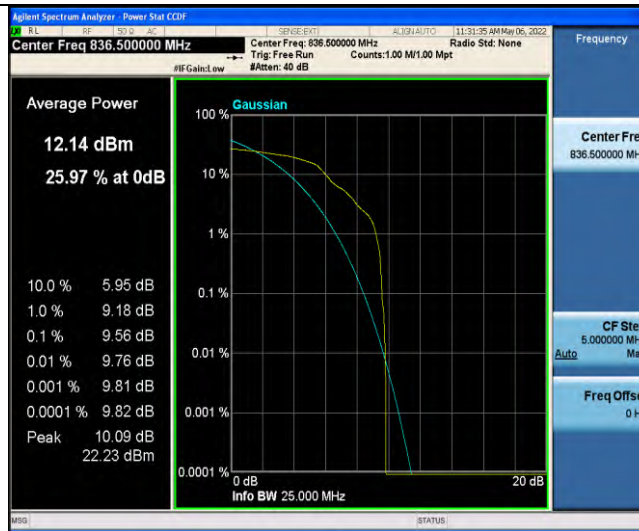

Band26-Stand-Alone-NaN-BPSK-26915-3@3-15kHz-9.56-<=13-PASS

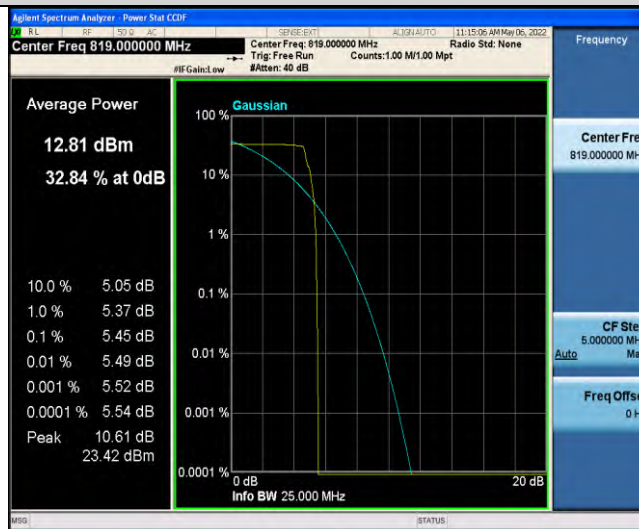

Band26-Stand-Alone-NaN-QPSK-26740-1@0-15kHz-5.45-<=13-PASS

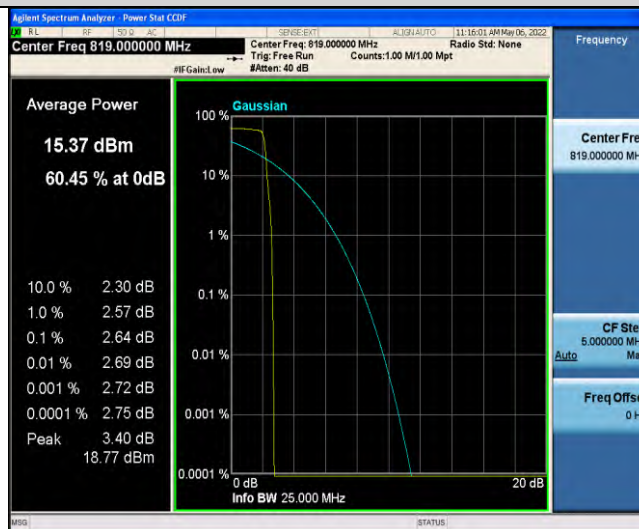

Band26-Stand-Alone-NaN-QPSK-26740-1@11-15kHz-2.64-<=13-PASS



Band26-Stand-Alone-NaN-QPSK-26740-3@3-15kHz-11.5-<=13-PASS



Band26-Stand-Alone-NaN-QPSK-26915-1@0-15kHz-6.88-<=13-PASS



Band26-Stand-Alone-NaN-QPSK-26915-1@11-15kHz-6.46-<=13-PASS



Band26-Stand-Alone-NaN-QPSK-26915-3@3-15kHz-10.52-<=13-PASS

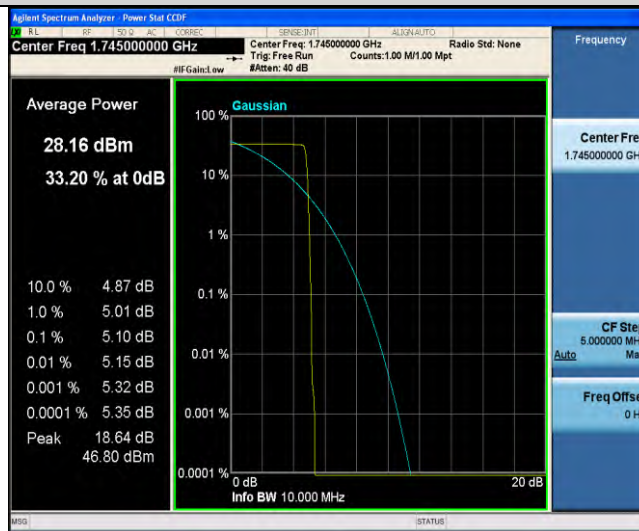

Band66-Stand-Alone-NaN-BPSK-132322-1@0-3.75kHz-5.1-<=13-PASS

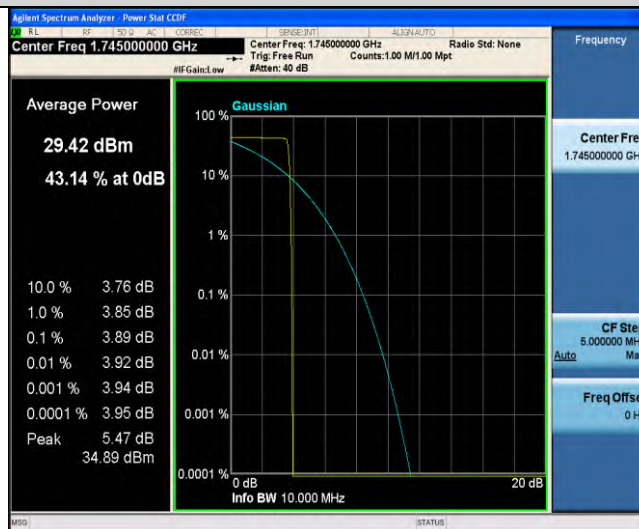

Band66-Stand-Alone-NaN-BPSK-132322-1@47-3.75kHz-3.89-<=13-PASS

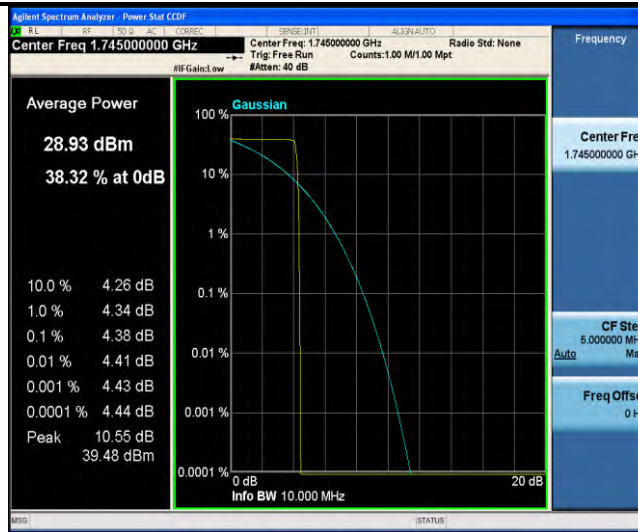

Band66-Stand-Alone-NaN-QPSK-132322-1 @0-3.75kHz-4.38-<=13-PASS

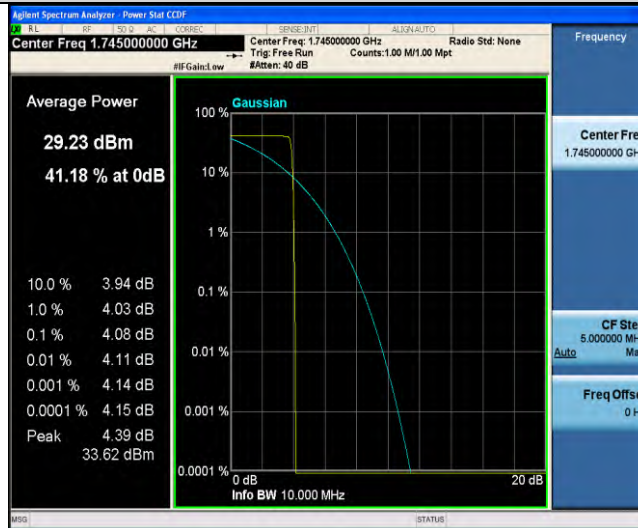

Band66-Stand-Alone-NaN-QPSK-132322-1 @47-3.75kHz-4.08-<=13-PASS



Band66-Stand-Alone-NaN-BPSK-132322-1 @0-15kHz-9.11-<=13-PASS





Band66-Stand-Alone-NaN-BPSK-132322-1 @ 11-15kHz-9.99-<=13-PASS



Band66-Stand-Alone-NaN-BPSK-132322-3 @ 3-15kHz-12.85-<=13-PASS



Band66-Stand-Alone-NaN-QPSK-132322-1 @ 0-15kHz-8.84-<=13-PASS

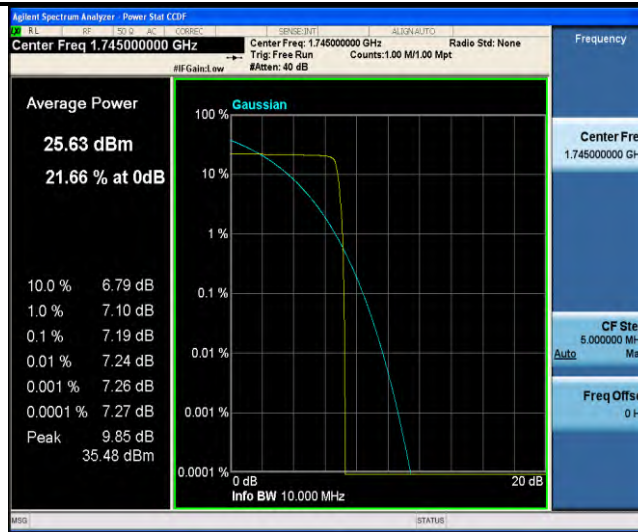

Band66-Stand-Alone-NaN-QPSK-132322-1 @ 11-15kHz-7.19-<=13-PASS



Band66-Stand-Alone-NaN-QPSK-132322-3 @ 3-15kHz-12.44-<=13-PASS



Band85-Stand-Alone-NaN-BPSK-134092-1 @ 0-3.75kHz-1.45-<=13-PASS

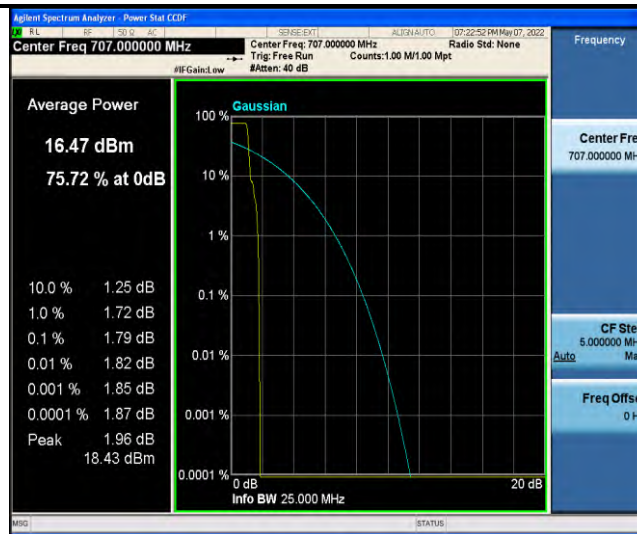

Band85-Stand-Alone-NaN-BPSK-134092-1 @ 47-3.75kHz-1.79-<=13-PASS



Band85-Stand-Alone-NaN-QPSK-134092-1 @ 0-3.75kHz-2.69-<=13-PASS

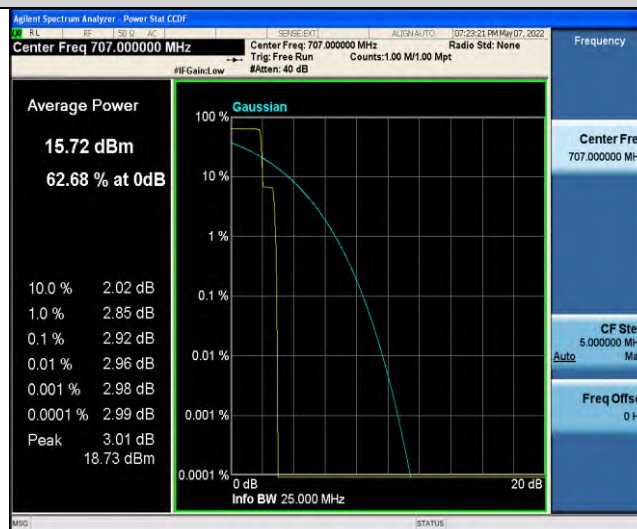

Band85-Stand-Alone-NaN-QPSK-134092-1 @ 47-3.75kHz-2.92-<=13-PASS



Band85-Stand-Alone-NaN-BPSK-134092-1 @ 0-15kHz-3.78-<=13-PASS

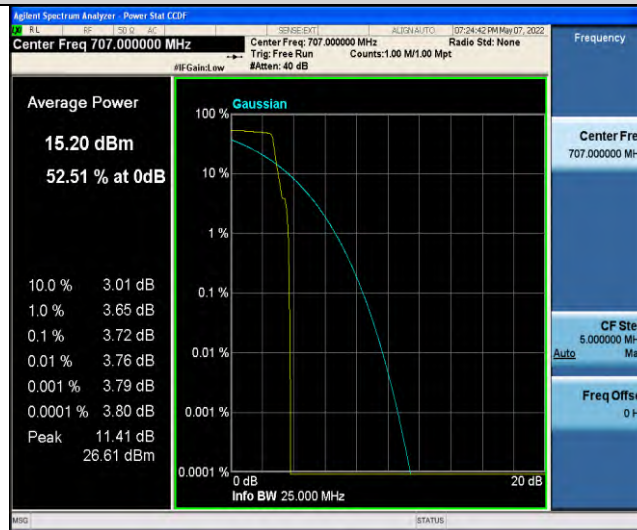

Band85-Stand-Alone-NaN-BPSK-134092-1 @ 11-15kHz-3.72-<=13-PASS



Band85-Stand-Alone-NaN-BPSK-134092-3 @ 3-15kHz-11.16-<=13-PASS

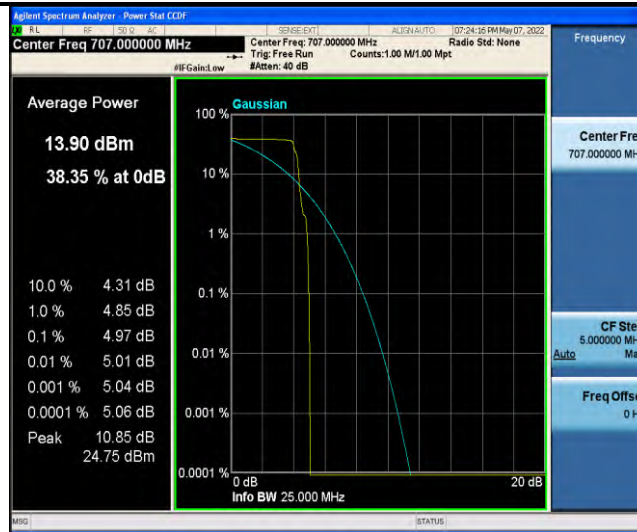

Band85-Stand-Alone-NaN-QPSK-134092-1 @ 0-15kHz-4.97-<=13-PASS

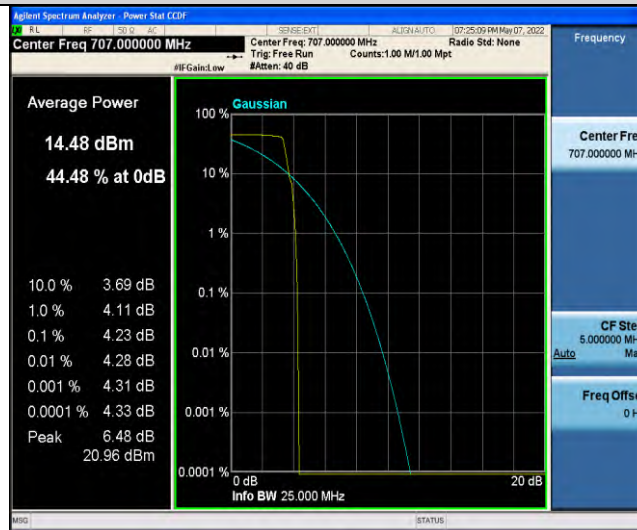

Band85-Stand-Alone-NaN-QPSK-134092-1 @ 11-15kHz-4.23-<=13-PASS

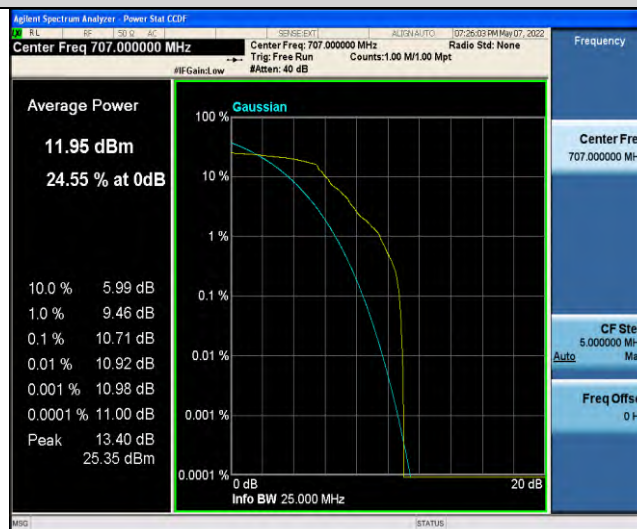

Band85-Stand-Alone-NaN-QPSK-134092-3 @ 3-15kHz-10.71-<=13-PASS

<b>4.3 Frequency Stability</b>	<b>VERDICT: PASS</b>
--------------------------------	----------------------

**4.3.1 Limit**

NB-IoT Band	Standard
5/18/19/26	FCC §2.1055 and §22.355: $\pm 2.5$ ppm for mobile stations operating in the range 821 to 896 MHz. FCC §2.1055 and §90.213: $\pm 2.5$ ppm for mobile stations operating in the range 809 to 824 MHz.
2/25	FCC §2.1055 and §24.235: The frequency stability shall be sufficient to ensure that the fundamental emission stays within the authorized frequency block.
12/13/17/85	FCC §2.1055 and §27.54: The frequency stability shall be sufficient to ensure that the fundamental emissions stay within the authorized bands of operation.
4/66	FCC §2.1055 and §27.54: The frequency stability shall be sufficient to ensure that the fundamental emissions stay within the authorized bands of operation.

**4.3.2 Test Setup**

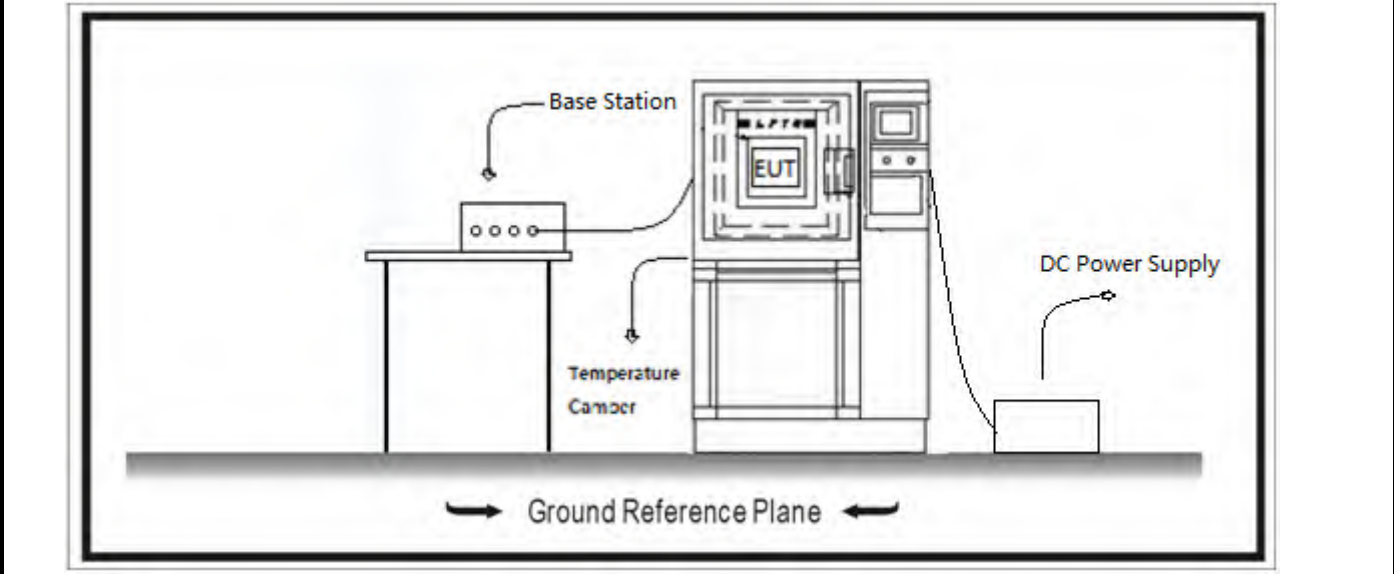

### 4.3.3 Test Procedure

	References Rule	Chapter	Description
<input checked="" type="checkbox"/>	ANSI C63.26	5.6	Frequency stability testing

The frequency tolerance measurements over temperature variations were made voer temperature range of -30°C to +50°C. The EUT was placed inside a environmental temperature chamber and the temperature was lowered hourly in 10°C steps from +50°C to -30°C.

The supply voltage was varied between 85% and 115% of nominal voltage.

The EUT was set in “Radio Resource Control (RRC) mode” in the middle channel using the Universal Radio Communication tester R&S CMW500 and the maximum frequency error was measured using the built-in calibrated frequency meter. The worst case NB-IoT mode for conducted power was used for the test.

In order to check that the frequency stability is sufficient such that the fundamental emissions stay within the authorized bands of operation. a reference point is established at the applicable unwanted emissions limit using a RBW equal to the RBW required by the unwanted emissions specification of the applicable regulatory standard. These reference points measured using the lowest and highest channel of operation are identified as fL and fH respectively. The worst-case frequency offset determined in the above methods is added or subtracted from the values of fL and fH to check that the resulting frequencies remain within the band.

The reference point measurements were made at the RF output terminals of the EUT using directional coupler and spectrum analyser. The EUT was controlled via the Universal Radio Communication tester R&S CMW500 selecting maximum transmission power of the EUT and different modes of modulation.

#### 4.3.4 Test Data

Voltage												
Band	OpMode	SCS	Bandwidth	Modulation	Channel	Tones	Voltage [Vdc]	Temperature (°C)	Deviation (Hz)	Deviation (ppm)	Limit (ppm)	Verdict
Band 2	Stand - Alone	3.75k Hz	NaN	QPSK	18876	1@0	VH	NT	2.60	0.001385	±2.5	PASS
Band 2	Stand - Alone	3.75k Hz	NaN	QPSK	18876	1@0	VL	NT	2.90	0.001545	±2.5	PASS
Band 2	Stand - Alone	3.75k Hz	NaN	QPSK	18876	1@0	VN	NT	-5.40	0.002876	±2.5	PASS
Band 2	Stand - Alone	3.75k Hz	NaN	QPSK	18876	1@47	VH	NT	-0.80	0.000426	±2.5	PASS
Band 2	Stand - Alone	3.75k Hz	NaN	QPSK	18876	1@47	VL	NT	0.30	0.000160	±2.5	PASS
Band 2	Stand - Alone	3.75k Hz	NaN	QPSK	18876	1@47	VN	NT	1.50	0.000799	±2.5	PASS
Band 2	Stand - Alone	15kHz	NaN	QPSK	18876	1@0	VH	NT	3.20	0.001704	±2.5	PASS
Band 2	Stand - Alone	15kHz	NaN	QPSK	18876	1@0	VL	NT	-6.00	0.003196	±2.5	PASS
Band 2	Stand - Alone	15kHz	NaN	QPSK	18876	1@0	VN	NT	-6.60	0.003515	±2.5	PASS
Band 2	Stand - Alone	15kHz	NaN	QPSK	18876	1@11	VH	NT	-12.20	0.006498	±2.5	PASS
Band 2	Stand - Alone	15kHz	NaN	QPSK	18876	1@11	VL	NT	-2.80	0.001491	±2.5	PASS
Band 2	Stand - Alone	15kHz	NaN	QPSK	18876	1@11	VN	NT	-4.90	0.002610	±2.5	PASS
Band 4	Stand - Alone	3.75k Hz	NaN	QPSK	20175	1@0	VN	NT	-1.50	0.000866	±2.5	PASS



Band 4	Stand - Alone	3.75k Hz	NaN	QPSK	2017 5	1@0	VH	NT	3.90	0.0022 51	±2.5	PAS S
Band 4	Stand - Alone	3.75k Hz	NaN	QPSK	2017 5	1@0	VL	NT	4.90	0.0028 28	±2.5	PAS S
Band 4	Stand - Alone	3.75k Hz	NaN	QPSK	2017 5	1@4 7	VN	NT	3.30	0.0019 05	±2.5	PAS S
Band 4	Stand - Alone	3.75k Hz	NaN	QPSK	2017 5	1@4 7	VL	NT	2.00	0.0011 54	±2.5	PAS S
Band 4	Stand - Alone	3.75k Hz	NaN	QPSK	2017 5	1@4 7	VH	NT	-0.30	- 0.0001 73	±2.5	PAS S
Band 4	Stand - Alone	15kHz	NaN	QPSK	2017 5	1@0	VN	NT	4.80	0.0027 71	±2.5	PAS S
Band 4	Stand - Alone	15kHz	NaN	QPSK	2017 5	1@0	VL	NT	-0.50	- 0.0002 89	±2.5	PAS S
Band 4	Stand - Alone	15kHz	NaN	QPSK	2017 5	1@0	VH	NT	-7.10	- 0.0040 98	±2.5	PAS S
Band 4	Stand - Alone	15kHz	NaN	QPSK	2017 5	1@1 1	VL	NT	-9.90	- 0.0057 14	±2.5	PAS S
Band 4	Stand - Alone	15kHz	NaN	QPSK	2017 5	1@1 1	VN	NT	-10.30	- 0.0059 45	±2.5	PAS S
Band 4	Stand - Alone	15kHz	NaN	QPSK	2017 5	1@1 1	VH	NT	-5.90	- 0.0034 05	±2.5	PAS S
Band 5	Stand - Alone	3.75k Hz	NaN	QPSK	2052 5	1@0	VL	NT	3.60	0.0043 04	±2.5	PAS S
Band 5	Stand - Alone	3.75k Hz	NaN	QPSK	2052 5	1@0	VH	NT	2.30	0.0027 50	±2.5	PAS S
Band 5	Stand - Alone	3.75k Hz	NaN	QPSK	2052 5	1@0	VN	NT	-4.60	- 0.0054 99	±2.5	PAS S
Band 5	Stand - Alone	3.75k Hz	NaN	QPSK	2052 5	1@4 7	VN	NT	2.30	0.0027 50	±2.5	PAS S

Band 5	Stand - Alone	3.75k Hz	NaN	QPSK	2052 5	1@4 7	VL	NT	1.70	0.0020 32	±2.5	PAS S
Band 5	Stand - Alone	3.75k Hz	NaN	QPSK	2052 5	1@4 7	VH	NT	1.50	0.0017 93	±2.5	PAS S
Band 5	Stand - Alone	15kHz	NaN	QPSK	2052 5	1@0	VN	NT	-0.20	- 0.0002 39	±2.5	PAS S
Band 5	Stand - Alone	15kHz	NaN	QPSK	2052 5	1@0	VH	NT	-1.20	- 0.0014 35	±2.5	PAS S
Band 5	Stand - Alone	15kHz	NaN	QPSK	2052 5	1@0	VL	NT	-0.60	- 0.0007 17	±2.5	PAS S
Band 5	Stand - Alone	15kHz	NaN	QPSK	2052 5	1@1 1	VN	NT	-1.90	- 0.0022 71	±2.5	PAS S
Band 5	Stand - Alone	15kHz	NaN	QPSK	2052 5	1@1 1	VL	NT	8.60	0.0102 81	±2.5	PAS S
Band 5	Stand - Alone	15kHz	NaN	QPSK	2052 5	1@1 1	VH	NT	1.20	0.0014 35	±2.5	PAS S
Band 12	Stand - Alone	3.75k Hz	NaN	QPSK	2309 5	1@0	VH	NT	5.12	0.0072 37	±2.5	PAS S
Band 12	Stand - Alone	3.75k Hz	NaN	QPSK	2309 5	1@0	VL	NT	-9.03	- 0.0127 63	±2.5	PAS S
Band 12	Stand - Alone	3.75k Hz	NaN	QPSK	2309 5	1@0	VN	NT	8.58	0.0121 27	±2.5	PAS S
Band 12	Stand - Alone	3.75k Hz	NaN	QPSK	2309 5	1@4 7	VH	NT	-5.30	- 0.0074 91	±2.5	PAS S
Band 12	Stand - Alone	3.75k Hz	NaN	QPSK	2309 5	1@4 7	VL	NT	-3.62	- 0.0051 17	±2.5	PAS S
Band 12	Stand - Alone	3.75k Hz	NaN	QPSK	2309 5	1@4 7	VN	NT	-3.22	- 0.0045 51	±2.5	PAS S
Band 12	Stand - Alone	15kHz	NaN	QPSK	2309 5	1@0	VH	NT	8.19	0.0115 76	±2.5	PAS S

Band 12	Stand - Alone	15kHz	NaN	QPSK	2309 5	1@0	VL	NT	8.98	0.0126 93	±2.5	PAS S
Band 12	Stand - Alone	15kHz	NaN	QPSK	2309 5	1@0	VN	NT	8.19	0.0115 76	±2.5	PAS S
Band 12	Stand - Alone	15kHz	NaN	QPSK	2309 5	1@1 1	VH	NT	12.64	0.0178 66	±2.5	PAS S
Band 12	Stand - Alone	15kHz	NaN	QPSK	2309 5	1@1 1	VL	NT	10.89	0.0153 92	±2.5	PAS S
Band 12	Stand - Alone	15kHz	NaN	QPSK	2309 5	1@1 1	VN	NT	12.28	0.0173 57	±2.5	PAS S
Band 13	Stand - Alone	3.75k Hz	NaN	QPSK	2323 0	1@0	VN	NT	3.70	0.0047 31	±2.5	PAS S
Band 13	Stand - Alone	3.75k Hz	NaN	QPSK	2323 0	1@0	VL	NT	-3.90	- 0.0049 87	±2.5	PAS S
Band 13	Stand - Alone	3.75k Hz	NaN	QPSK	2323 0	1@0	VH	NT	5.80	0.0074 17	±2.5	PAS S
Band 13	Stand - Alone	3.75k Hz	NaN	QPSK	2323 0	1@4 7	VN	NT	1.40	0.0017 90	±2.5	PAS S
Band 13	Stand - Alone	3.75k Hz	NaN	QPSK	2323 0	1@4 7	VL	NT	1.80	0.0023 02	±2.5	PAS S
Band 13	Stand - Alone	3.75k Hz	NaN	QPSK	2323 0	1@4 7	VH	NT	-0.90	- 0.0011 51	±2.5	PAS S
Band 13	Stand - Alone	15kHz	NaN	QPSK	2323 0	1@0	VN	NT	-1.50	- 0.0019 18	±2.5	PAS S
Band 13	Stand - Alone	15kHz	NaN	QPSK	2323 0	1@0	VL	NT	-4.20	- 0.0053 71	±2.5	PAS S
Band 13	Stand - Alone	15kHz	NaN	QPSK	2323 0	1@0	VH	NT	-4.80	- 0.0061 38	±2.5	PAS S
Band 13	Stand - Alone	15kHz	NaN	QPSK	2323 0	1@1 1	VN	NT	6.60	0.0084 40	±2.5	PAS S

Band 13	Stand - Alone	15kHz	NaN	QPSK	23230	1@11	VL	NT	6.90	0.008824	±2.5	PASS
Band 13	Stand - Alone	15kHz	NaN	QPSK	23230	1@11	VH	NT	-8.40	0.010742	±2.5	PASS
Band 17	Stand - Alone	3.75k Hz	NaN	QPSK	23790	1@0	VN	NT	6.80	0.009577	±2.5	PASS
Band 17	Stand - Alone	3.75k Hz	NaN	QPSK	23790	1@0	VL	NT	1.60	0.002254	±2.5	PASS
Band 17	Stand - Alone	3.75k Hz	NaN	QPSK	23790	1@0	VH	NT	3.80	0.005352	±2.5	PASS
Band 17	Stand - Alone	3.75k Hz	NaN	QPSK	23790	1@47	VL	NT	-4.20	0.005915	±2.5	PASS
Band 17	Stand - Alone	3.75k Hz	NaN	QPSK	23790	1@47	VH	NT	1.80	0.002535	±2.5	PASS
Band 17	Stand - Alone	3.75k Hz	NaN	QPSK	23790	1@47	VN	NT	0.80	0.001127	±2.5	PASS
Band 17	Stand - Alone	15kHz	NaN	QPSK	23790	1@0	VL	NT	-5.10	0.007183	±2.5	PASS
Band 17	Stand - Alone	15kHz	NaN	QPSK	23790	1@0	VH	NT	-3.90	0.005493	±2.5	PASS
Band 17	Stand - Alone	15kHz	NaN	QPSK	23790	1@0	VN	NT	-3.10	0.004366	±2.5	PASS
Band 17	Stand - Alone	15kHz	NaN	QPSK	23790	1@11	VN	NT	7.20	0.010141	±2.5	PASS
Band 17	Stand - Alone	15kHz	NaN	QPSK	23790	1@11	VL	NT	4.00	0.005634	±2.5	PASS
Band 17	Stand - Alone	15kHz	NaN	QPSK	23790	1@11	VH	NT	-9.00	0.012676	±2.5	PASS
Band 18	Stand - Alone	3.75k Hz	NaN	QPSK	23925	1@0	VN	NT	4.30	0.005228	±2.5	PASS

Band 18	Stand - Alone	3.75k Hz	NaN	QPSK	23925	1@0	VL	NT	15.00	0.018237	±2.5	PAS S
Band 18	Stand - Alone	3.75k Hz	NaN	QPSK	23925	1@0	VH	NT	3.50	0.004255	±2.5	PAS S
Band 18	Stand - Alone	3.75k Hz	NaN	QPSK	23925	1@47	VN	NT	6.00	0.007295	±2.5	PAS S
Band 18	Stand - Alone	3.75k Hz	NaN	QPSK	23925	1@47	VL	NT	0.40	0.000486	±2.5	PAS S
Band 18	Stand - Alone	3.75k Hz	NaN	QPSK	23925	1@47	VH	NT	-3.10	-0.003769	±2.5	PAS S
Band 18	Stand - Alone	15kHz	NaN	QPSK	23925	1@0	VN	NT	-5.80	-0.007052	±2.5	PAS S
Band 18	Stand - Alone	15kHz	NaN	QPSK	23925	1@0	VL	NT	-3.80	-0.004620	±2.5	PAS S
Band 18	Stand - Alone	15kHz	NaN	QPSK	23925	1@0	VH	NT	-5.70	-0.006930	±2.5	PAS S
Band 18	Stand - Alone	15kHz	NaN	QPSK	23925	1@11	VN	NT	1.50	0.001824	±2.5	PAS S
Band 18	Stand - Alone	15kHz	NaN	QPSK	23925	1@11	VL	NT	-9.00	-0.010942	±2.5	PAS S
Band 18	Stand - Alone	15kHz	NaN	QPSK	23925	1@11	VH	NT	-7.60	-0.009240	±2.5	PAS S
Band 19	Stand - Alone	3.75k Hz	NaN	QPSK	24075	1@0	VN	NT	4.40	0.005254	±2.5	PAS S
Band 19	Stand - Alone	3.75k Hz	NaN	QPSK	24075	1@0	VL	NT	4.20	0.005015	±2.5	PAS S
Band 19	Stand - Alone	3.75k Hz	NaN	QPSK	24075	1@0	VH	NT	2.10	0.002507	±2.5	PAS S
Band 19	Stand - Alone	3.75k Hz	NaN	QPSK	24075	1@47	VN	NT	-2.90	-0.003463	±2.5	PAS S

Band 19	Stand - Alone	3.75k Hz	NaN	QPSK	24075	1@47	VL	NT	1.70	0.002030	±2.5	PAS S
Band 19	Stand - Alone	3.75k Hz	NaN	QPSK	24075	1@47	VH	NT	-1.90	0.002269	±2.5	PAS S
Band 19	Stand - Alone	15kHz	NaN	QPSK	24075	1@0	VH	NT	-0.30	0.000358	±2.5	PAS S
Band 19	Stand - Alone	15kHz	NaN	QPSK	24075	1@0	VN	NT	-4.60	0.005493	±2.5	PAS S
Band 19	Stand - Alone	15kHz	NaN	QPSK	24075	1@0	VL	NT	1.00	0.001194	±2.5	PAS S
Band 19	Stand - Alone	15kHz	NaN	QPSK	24075	1@11	VH	NT	1.00	0.001194	±2.5	PAS S
Band 19	Stand - Alone	15kHz	NaN	QPSK	24075	1@11	VN	NT	1.30	0.001552	±2.5	PAS S
Band 19	Stand - Alone	15kHz	NaN	QPSK	24075	1@11	VL	NT	0.80	0.000955	±2.5	PAS S
Band 25	Stand - Alone	3.75k Hz	NaN	QPSK	26365	1@0	VH	NT	-3.10	0.001647	±2.5	PAS S
Band 25	Stand - Alone	3.75k Hz	NaN	QPSK	26365	1@0	VL	NT	1.60	0.000850	±2.5	PAS S
Band 25	Stand - Alone	3.75k Hz	NaN	QPSK	26365	1@0	VN	NT	-14.90	0.007915	±2.5	PAS S
Band 25	Stand - Alone	3.75k Hz	NaN	QPSK	26365	1@47	VH	NT	-3.90	0.002072	±2.5	PAS S
Band 25	Stand - Alone	3.75k Hz	NaN	QPSK	26365	1@47	VL	NT	-6.50	0.003453	±2.5	PAS S
Band 25	Stand - Alone	3.75k Hz	NaN	QPSK	26365	1@47	VN	NT	-2.80	0.001487	±2.5	PAS S
Band 25	Stand - Alone	15kHz	NaN	QPSK	26365	1@0	VH	NT	-1.10	0.000584	±2.5	PAS S

Band 25	Stand - Alone	15kHz	NaN	QPSK	2636 5	1@0	VL	NT	-10.20	- 0.0054 18	±2.5	PAS S
Band 25	Stand - Alone	15kHz	NaN	QPSK	2636 5	1@0	VN	NT	1.30	0.0006 91	±2.5	PAS S
Band 25	Stand - Alone	15kHz	NaN	QPSK	2636 5	1@1 1	VH	NT	0.80	0.0004 25	±2.5	PAS S
Band 25	Stand - Alone	15kHz	NaN	QPSK	2636 5	1@1 1	VN	NT	3.40	0.0018 06	±2.5	PAS S
Band 25	Stand - Alone	15kHz	NaN	QPSK	2636 5	1@1 1	VL	NT	-3.60	- 0.0019 12	±2.5	PAS S
Band 26	Stand - Alone	3.75k Hz	NaN	QPSK	2674 0	1@0	VH	NT	8.66	0.0105 74	±2.5	PAS S
Band 26	Stand - Alone	3.75k Hz	NaN	QPSK	2674 0	1@0	VL	NT	-2.83	- 0.0034 55	±2.5	PAS S
Band 26	Stand - Alone	3.75k Hz	NaN	QPSK	2674 0	1@0	VN	NT	5.89	0.0071 92	±2.5	PAS S
Band 26	Stand - Alone	3.75k Hz	NaN	QPSK	2674 0	1@4 7	VN	NT	-5.19	- 0.0063 37	±2.5	PAS S
Band 26	Stand - Alone	3.75k Hz	NaN	QPSK	2674 0	1@4 7	VL	NT	12.55	0.0153 24	±2.5	PAS S
Band 26	Stand - Alone	3.75k Hz	NaN	QPSK	2674 0	1@4 7	VH	NT	-4.17	- 0.0050 92	±2.5	PAS S
Band 26	Stand - Alone	15kHz	NaN	QPSK	2674 0	1@0	VH	NT	-11.94	- 0.0145 79	±2.5	PAS S
Band 26	Stand - Alone	15kHz	NaN	QPSK	2674 0	1@0	VL	NT	16.80	0.0205 13	±2.5	PAS S
Band 26	Stand - Alone	15kHz	NaN	QPSK	2674 0	1@0	VN	NT	-11.95	- 0.0145 91	±2.5	PAS S
Band 26	Stand - Alone	15kHz	NaN	QPSK	2674 0	1@1 1	VH	NT	14.64	0.0178 75	±2.5	PAS S

Band 26	Stand - Alone	15kHz	NaN	QPSK	26740	1@11	VN	NT	12.63	0.015421	±2.5	PAS S
Band 26	Stand - Alone	15kHz	NaN	QPSK	26740	1@11	VL	NT	12.42	0.015165	±2.5	PAS S
Band 26	Stand - Alone	3.75k Hz	NaN	QPSK	26915	1@0	VH	NT	2.36	0.002821	±2.5	PAS S
Band 26	Stand - Alone	3.75k Hz	NaN	QPSK	26915	1@0	VL	NT	2.51	0.003001	±2.5	PAS S
Band 26	Stand - Alone	3.75k Hz	NaN	QPSK	26915	1@0	VN	NT	3.39	0.004053	±2.5	PAS S
Band 26	Stand - Alone	3.75k Hz	NaN	QPSK	26915	1@47	VN	NT	4.52	0.005403	±2.5	PAS S
Band 26	Stand - Alone	3.75k Hz	NaN	QPSK	26915	1@47	VL	NT	5.55	0.006635	±2.5	PAS S
Band 26	Stand - Alone	3.75k Hz	NaN	QPSK	26915	1@47	VH	NT	2.74	0.003276	±2.5	PAS S
Band 26	Stand - Alone	15kHz	NaN	QPSK	26915	1@0	VH	NT	7.07	0.008452	±2.5	PAS S
Band 26	Stand - Alone	15kHz	NaN	QPSK	26915	1@0	VL	NT	9.21	0.011010	±2.5	PAS S
Band 26	Stand - Alone	15kHz	NaN	QPSK	26915	1@0	VN	NT	10.03	0.011990	±2.5	PAS S
Band 26	Stand - Alone	15kHz	NaN	QPSK	26915	1@11	VH	NT	11.75	0.014047	±2.5	PAS S
Band 26	Stand - Alone	15kHz	NaN	QPSK	26915	1@11	VN	NT	11.40	0.013628	±2.5	PAS S
Band 26	Stand - Alone	15kHz	NaN	QPSK	26915	1@11	VL	NT	12.10	0.014465	±2.5	PAS S
Band 66	Stand - Alone	3.75k Hz	NaN	QPSK	132322	1@0	VH	NT	-1.60	0.000917	±2.5	PAS S



Band 66	Stand - Alone	3.75k Hz	NaN	QPSK	1323 22	1@0	VL	NT	1.90	0.0010 89	±2.5	PAS S
Band 66	Stand - Alone	3.75k Hz	NaN	QPSK	1323 22	1@0	VN	NT	-0.80	0.0004 58	±2.5	PAS S
Band 66	Stand - Alone	3.75k Hz	NaN	QPSK	1323 22	1@4 7	VL	NT	-1.80	0.0010 32	±2.5	PAS S
Band 66	Stand - Alone	3.75k Hz	NaN	QPSK	1323 22	1@4 7	VH	NT	2.70	0.0015 47	±2.5	PAS S
Band 66	Stand - Alone	3.75k Hz	NaN	QPSK	1323 22	1@4 7	VN	NT	-3.30	0.0018 91	±2.5	PAS S
Band 66	Stand - Alone	15kHz	NaN	QPSK	1323 22	1@0	VN	NT	-3.60	0.0020 63	±2.5	PAS S
Band 66	Stand - Alone	15kHz	NaN	QPSK	1323 22	1@0	VH	NT	-5.70	0.0032 66	±2.5	PAS S
Band 66	Stand - Alone	15kHz	NaN	QPSK	1323 22	1@0	VL	NT	-7.30	0.0041 83	±2.5	PAS S
Band 66	Stand - Alone	15kHz	NaN	QPSK	1323 22	1@1 1	VN	NT	1.90	0.0010 89	±2.5	PAS S
Band 66	Stand - Alone	15kHz	NaN	QPSK	1323 22	1@1 1	VL	NT	3.00	0.0017 19	±2.5	PAS S
Band 66	Stand - Alone	15kHz	NaN	QPSK	1323 22	1@1 1	VH	NT	0.70	0.0004 01	±2.5	PAS S
Band 85	Stand - Alone	3.75k Hz	NaN	QPSK	1340 92	1@0	VN	NT	-1.50	0.0021 22	±2.5	PAS S
Band 85	Stand - Alone	3.75k Hz	NaN	QPSK	1340 92	1@0	VH	NT	-1.10	0.0015 56	±2.5	PAS S
Band 85	Stand - Alone	3.75k Hz	NaN	QPSK	1340 92	1@0	VL	NT	1.30	0.0018 39	±2.5	PAS S
Band 85	Stand - Alone	3.75k Hz	NaN	QPSK	1340 92	1@4 7	VH	NT	7.20	0.0101 84	±2.5	PAS S

Band 85	Stand - Alone	3.75k Hz	NaN	QPSK	1340 92	1@4 7	VN	NT	-0.10	- 0.0001 41	±2.5	PAS S
Band 85	Stand - Alone	3.75k Hz	NaN	QPSK	1340 92	1@4 7	VL	NT	-1.80	- 0.0025 46	±2.5	PAS S
Band 85	Stand - Alone	15kHz	NaN	QPSK	1340 92	1@0	VN	NT	-1.50	- 0.0021 22	±2.5	PAS S
Band 85	Stand - Alone	15kHz	NaN	QPSK	1340 92	1@0	VL	NT	10.70	0.0151 34	±2.5	PAS S
Band 85	Stand - Alone	15kHz	NaN	QPSK	1340 92	1@0	VH	NT	-2.70	- 0.0038 19	±2.5	PAS S
Band 85	Stand - Alone	15kHz	NaN	QPSK	1340 92	1@1 1	VN	NT	-6.40	- 0.0090 52	±2.5	PAS S
Band 85	Stand - Alone	15kHz	NaN	QPSK	1340 92	1@1 1	VL	NT	-6.10	- 0.0086 28	±2.5	PAS S
Band 85	Stand - Alone	15kHz	NaN	QPSK	1340 92	1@1 1	VH	NT	3.20	0.0045 26	±2.5	PAS S

Temperature												
Band	OpMode	Bandwidth	Modulation	Channel	Tones	SCS	Voltage [Vdc]	Temperature (°C)	Deviation (Hz)	Deviation (ppm)	Limit (ppm)	Verdict
Band 2	Stand - Alone	3.75kHz	NaN	QPSK	18876	1@0	NV	0	0.30	0.000160	±2.5	PASS
Band 2	Stand - Alone	3.75kHz	NaN	QPSK	18876	1@0	NV	-30	2.30	0.001225	±2.5	PASS
Band 2	Stand - Alone	3.75kHz	NaN	QPSK	18876	1@0	NV	10	-0.40	0.000213	±2.5	PASS
Band 2	Stand - Alone	3.75kHz	NaN	QPSK	18876	1@0	NV	-20	0.70	0.000373	±2.5	PASS
Band 2	Stand - Alone	3.75kHz	NaN	QPSK	18876	1@0	NV	20	-1.00	0.000533	±2.5	PASS
Band 2	Stand - Alone	3.75kHz	NaN	QPSK	18876	1@47	NV	0	7.30	0.003888	±2.5	PASS
Band 2	Stand - Alone	3.75kHz	NaN	QPSK	18876	1@47	NV	10	5.70	0.003036	±2.5	PASS
Band 2	Stand - Alone	3.75kHz	NaN	QPSK	18876	1@47	NV	-20	7.70	0.004101	±2.5	PASS
Band 2	Stand - Alone	3.75kHz	NaN	QPSK	18876	1@47	NV	-30	8.80	0.004687	±2.5	PASS
Band 2	Stand - Alone	3.75kHz	NaN	QPSK	18876	1@47	NV	20	4.90	0.002610	±2.5	PASS
Band 2	Stand - Alone	15kHz	NaN	QPSK	18876	1@0	NV	10	2.60	0.001385	±2.5	PASS
Band 2	Stand - Alone	15kHz	NaN	QPSK	18876	1@0	NV	0	1.70	0.000905	±2.5	PASS
Band 2	Stand - Alone	15kHz	NaN	QPSK	18876	1@0	NV	-20	2.10	0.001118	±2.5	PASS
Band 2	Stand - Alone	15kHz	NaN	QPSK	18876	1@0	NV	-30	-5.70	0.003036	±2.5	PASS

Band 2	Stand - Alone	15kHz	NaN	QPS K	1887 6	1@0	NV	20	-4.90	- 0.0026 10	±2.5	PAS S
Band 2	Stand - Alone	15kHz	NaN	QPS K	1887 6	1@1 1	NV	-20	-2.90	- 0.0015 45	±2.5	PAS S
Band 2	Stand - Alone	15kHz	NaN	QPS K	1887 6	1@1 1	NV	-30	-10.70	- 0.0056 99	±2.5	PAS S
Band 2	Stand - Alone	15kHz	NaN	QPS K	1887 6	1@1 1	NV	0	5.40	0.0028 76	±2.5	PAS S
Band 2	Stand - Alone	15kHz	NaN	QPS K	1887 6	1@1 1	NV	10	-2.80	- 0.0014 91	±2.5	PAS S
Band 2	Stand - Alone	15kHz	NaN	QPS K	1887 6	1@1 1	NV	20	-10.10	- 0.0053 79	±2.5	PAS S
Band 4	Stand - Alone	3.75kHz	NaN	QPS K	2017 5	1@0	NV	20	-5.00	- 0.0028 86	±2.5	PAS S
Band 4	Stand - Alone	3.75kHz	NaN	QPS K	2017 5	1@0	NV	-20	0.30	0.0001 73	±2.5	PAS S
Band 4	Stand - Alone	3.75kHz	NaN	QPS K	2017 5	1@0	NV	0	-1.50	- 0.0008 66	±2.5	PAS S
Band 4	Stand - Alone	3.75kHz	NaN	QPS K	2017 5	1@0	NV	10	-3.20	- 0.0018 47	±2.5	PAS S
Band 4	Stand - Alone	3.75kHz	NaN	QPS K	2017 5	1@0	NV	-30	1.40	0.0008 08	±2.5	PAS S
Band 4	Stand - Alone	3.75kHz	NaN	QPS K	2017 5	1@4 7	NV	10	-0.90	- 0.0005 19	±2.5	PAS S
Band 4	Stand - Alone	3.75kHz	NaN	QPS K	2017 5	1@4 7	NV	20	3.90	0.0022 51	±2.5	PAS S
Band 4	Stand - Alone	3.75kHz	NaN	QPS K	2017 5	1@4 7	NV	0	2.50	0.0014 43	±2.5	PAS S
Band 4	Stand - Alone	3.75kHz	NaN	QPS K	2017 5	1@4 7	NV	-20	6.90	0.0039 83	±2.5	PAS S

Band 4	Stand - Alone	3.75kHz z	NaN	QPS K	2017 5	1@4 7	NV	-30	0.20	0.0001 15	±2.5	PAS S
Band 4	Stand - Alone	15kHz	NaN	QPS K	2017 5	1@0	NV	-20	-2.80	- 0.0016 16	±2.5	PAS S
Band 4	Stand - Alone	15kHz	NaN	QPS K	2017 5	1@0	NV	0	-6.00	- 0.0034 63	±2.5	PAS S
Band 4	Stand - Alone	15kHz	NaN	QPS K	2017 5	1@0	NV	10	-4.40	- 0.0025 40	±2.5	PAS S
Band 4	Stand - Alone	15kHz	NaN	QPS K	2017 5	1@0	NV	20	-5.70	- 0.0032 90	±2.5	PAS S
Band 4	Stand - Alone	15kHz	NaN	QPS K	2017 5	1@0	NV	-30	-4.10	- 0.0023 67	±2.5	PAS S
Band 4	Stand - Alone	15kHz	NaN	QPS K	2017 5	1@1 1	NV	0	-6.10	- 0.0035 21	±2.5	PAS S
Band 4	Stand - Alone	15kHz	NaN	QPS K	2017 5	1@1 1	NV	10	-2.90	- 0.0016 74	±2.5	PAS S
Band 4	Stand - Alone	15kHz	NaN	QPS K	2017 5	1@1 1	NV	-30	-2.90	- 0.0016 74	±2.5	PAS S
Band 4	Stand - Alone	15kHz	NaN	QPS K	2017 5	1@1 1	NV	-20	1.00	0.0005 77	±2.5	PAS S
Band 4	Stand - Alone	15kHz	NaN	QPS K	2017 5	1@1 1	NV	20	0.30	0.0001 73	±2.5	PAS S
Band 5	Stand - Alone	3.75kHz z	NaN	QPS K	2052 5	1@0	NV	20	0.80	0.0009 56	±2.5	PAS S
Band 5	Stand - Alone	3.75kHz z	NaN	QPS K	2052 5	1@0	NV	10	1.20	0.0014 35	±2.5	PAS S
Band 5	Stand - Alone	3.75kHz z	NaN	QPS K	2052 5	1@0	NV	0	2.20	0.0026 30	±2.5	PAS S
Band 5	Stand - Alone	3.75kHz z	NaN	QPS K	2052 5	1@0	NV	-20	2.90	0.0034 67	±2.5	PAS S

Band 5	Stand - Alone	3.75kHz	NaN	QPS K	2052 5	1@0	NV	-30	-6.20	- 0.0074 12	±2.5	PAS S
Band 5	Stand - Alone	3.75kHz	NaN	QPS K	2052 5	1@4 7	NV	-30	1.00	0.0011 95	±2.5	PAS S
Band 5	Stand - Alone	3.75kHz	NaN	QPS K	2052 5	1@4 7	NV	-20	0.60	0.0007 17	±2.5	PAS S
Band 5	Stand - Alone	3.75kHz	NaN	QPS K	2052 5	1@4 7	NV	0	0.40	0.0004 78	±2.5	PAS S
Band 5	Stand - Alone	3.75kHz	NaN	QPS K	2052 5	1@4 7	NV	10	0.30	0.0003 59	±2.5	PAS S
Band 5	Stand - Alone	3.75kHz	NaN	QPS K	2052 5	1@4 7	NV	20	0.00	0.0000 00	±2.5	PAS S
Band 5	Stand - Alone	15kHz	NaN	QPS K	2052 5	1@0	NV	-30	-1.80	- 0.0021 52	±2.5	PAS S
Band 5	Stand - Alone	15kHz	NaN	QPS K	2052 5	1@0	NV	20	-3.20	- 0.0038 25	±2.5	PAS S
Band 5	Stand - Alone	15kHz	NaN	QPS K	2052 5	1@0	NV	10	-2.70	- 0.0032 28	±2.5	PAS S
Band 5	Stand - Alone	15kHz	NaN	QPS K	2052 5	1@0	NV	-20	-3.10	- 0.0037 06	±2.5	PAS S
Band 5	Stand - Alone	15kHz	NaN	QPS K	2052 5	1@0	NV	0	-1.90	- 0.0022 71	±2.5	PAS S
Band 5	Stand - Alone	15kHz	NaN	QPS K	2052 5	1@1 1	NV	0	-7.20	- 0.0086 07	±2.5	PAS S
Band 5	Stand - Alone	15kHz	NaN	QPS K	2052 5	1@1 1	NV	10	-4.10	- 0.0049 01	±2.5	PAS S
Band 5	Stand - Alone	15kHz	NaN	QPS K	2052 5	1@1 1	NV	20	-2.50	- 0.0029 89	±2.5	PAS S
Band 5	Stand - Alone	15kHz	NaN	QPS K	2052 5	1@1 1	NV	-20	-3.10	- 0.0037 06	±2.5	PAS S

Band 5	Stand - Alone	15kHz	NaN	QPS K	2052 5	1@1 1	NV	-30	-5.90	- 0.0070 53	±2.5	PAS S
Band 12	Stand - Alone	3.75kHz	NaN	QPS K	2309 5	1@0	NV	-20	5.50	0.0077 74	±2.5	PAS S
Band 12	Stand - Alone	3.75kHz	NaN	QPS K	2309 5	1@0	NV	-30	4.60	0.0065 02	±2.5	PAS S
Band 12	Stand - Alone	3.75kHz	NaN	QPS K	2309 5	1@0	NV	0	4.00	0.0056 54	±2.5	PAS S
Band 12	Stand - Alone	3.75kHz	NaN	QPS K	2309 5	1@0	NV	10	5.30	0.0074 91	±2.5	PAS S
Band 12	Stand - Alone	3.75kHz	NaN	QPS K	2309 5	1@0	NV	20	3.30	0.0046 64	±2.5	PAS S
Band 12	Stand - Alone	3.75kHz	NaN	QPS K	2309 5	1@4 7	NV	-20	8.00	0.0113 07	±2.5	PAS S
Band 12	Stand - Alone	3.75kHz	NaN	QPS K	2309 5	1@4 7	NV	0	9.00	0.0127 21	±2.5	PAS S
Band 12	Stand - Alone	3.75kHz	NaN	QPS K	2309 5	1@4 7	NV	10	8.50	0.0120 14	±2.5	PAS S
Band 12	Stand - Alone	3.75kHz	NaN	QPS K	2309 5	1@4 7	NV	20	7.60	0.0107 42	±2.5	PAS S
Band 12	Stand - Alone	3.75kHz	NaN	QPS K	2309 5	1@4 7	NV	-30	-0.20	- 0.0002 83	±2.5	PAS S
Band 12	Stand - Alone	15kHz	NaN	QPS K	2309 5	1@0	NV	-30	3.30	0.0046 64	±2.5	PAS S
Band 12	Stand - Alone	15kHz	NaN	QPS K	2309 5	1@0	NV	-20	2.20	0.0031 10	±2.5	PAS S
Band 12	Stand - Alone	15kHz	NaN	QPS K	2309 5	1@0	NV	0	3.80	0.0053 71	±2.5	PAS S
Band 12	Stand - Alone	15kHz	NaN	QPS K	2309 5	1@0	NV	10	1.50	0.0021 20	±2.5	PAS S

Band 12	Stand - Alone	15kHz	NaN	QPS K	2309 5	1@0	NV	20	3.80	0.0053 71	±2.5	PAS S
Band 12	Stand - Alone	15kHz	NaN	QPS K	2309 5	1@1 1	NV	-20	3.10	0.0043 82	±2.5	PAS S
Band 12	Stand - Alone	15kHz	NaN	QPS K	2309 5	1@1 1	NV	-30	5.00	0.0070 67	±2.5	PAS S
Band 12	Stand - Alone	15kHz	NaN	QPS K	2309 5	1@1 1	NV	0	-9.50	- 0.0134 28	±2.5	PAS S
Band 12	Stand - Alone	15kHz	NaN	QPS K	2309 5	1@1 1	NV	10	4.30	0.0060 78	±2.5	PAS S
Band 12	Stand - Alone	15kHz	NaN	QPS K	2309 5	1@1 1	NV	20	4.00	0.0056 54	±2.5	PAS S
Band 13	Stand - Alone	3.75kHz	NaN	QPS K	2323 0	1@0	NV	20	5.50	0.0070 33	±2.5	PAS S
Band 13	Stand - Alone	3.75kHz	NaN	QPS K	2323 0	1@0	NV	0	3.10	0.0039 64	±2.5	PAS S
Band 13	Stand - Alone	3.75kHz	NaN	QPS K	2323 0	1@0	NV	10	-6.50	- 0.0083 12	±2.5	PAS S
Band 13	Stand - Alone	3.75kHz	NaN	QPS K	2323 0	1@0	NV	-30	-6.60	- 0.0084 40	±2.5	PAS S
Band 13	Stand - Alone	3.75kHz	NaN	QPS K	2323 0	1@0	NV	-20	5.90	0.0075 45	±2.5	PAS S
Band 13	Stand - Alone	3.75kHz	NaN	QPS K	2323 0	1@4 7	NV	10	1.10	0.0014 07	±2.5	PAS S
Band 13	Stand - Alone	3.75kHz	NaN	QPS K	2323 0	1@4 7	NV	20	1.10	0.0014 07	±2.5	PAS S
Band 13	Stand - Alone	3.75kHz	NaN	QPS K	2323 0	1@4 7	NV	-20	-1.20	- 0.0015 35	±2.5	PAS S
Band 13	Stand - Alone	3.75kHz	NaN	QPS K	2323 0	1@4 7	NV	-30	1.60	0.0020 46	±2.5	PAS S



Band 13	Stand - Alone	3.75kHz z	NaN	QPS K	2323 0	1@4 7	NV	0	-1.20	- 0.0015 35	±2.5	PAS S
Band 13	Stand - Alone	15kHz	NaN	QPS K	2323 0	1@0	NV	-20	-7.80	- 0.0099 74	±2.5	PAS S
Band 13	Stand - Alone	15kHz	NaN	QPS K	2323 0	1@0	NV	0	-7.20	- 0.0092 07	±2.5	PAS S
Band 13	Stand - Alone	15kHz	NaN	QPS K	2323 0	1@0	NV	10	-4.80	- 0.0061 38	±2.5	PAS S
Band 13	Stand - Alone	15kHz	NaN	QPS K	2323 0	1@0	NV	20	-8.30	- 0.0106 14	±2.5	PAS S
Band 13	Stand - Alone	15kHz	NaN	QPS K	2323 0	1@0	NV	-30	-6.40	- 0.0081 84	±2.5	PAS S
Band 13	Stand - Alone	15kHz	NaN	QPS K	2323 0	1@1 1	NV	20	8.80	0.0112 53	±2.5	PAS S
Band 13	Stand - Alone	15kHz	NaN	QPS K	2323 0	1@1 1	NV	10	-10.60	- 0.0135 55	±2.5	PAS S
Band 13	Stand - Alone	15kHz	NaN	QPS K	2323 0	1@1 1	NV	-30	-5.60	- 0.0071 61	±2.5	PAS S
Band 13	Stand - Alone	15kHz	NaN	QPS K	2323 0	1@1 1	NV	-20	-5.20	- 0.0066 50	±2.5	PAS S
Band 13	Stand - Alone	15kHz	NaN	QPS K	2323 0	1@1 1	NV	0	-6.00	- 0.0076 73	±2.5	PAS S
Band 17	Stand - Alone	3.75kHz z	NaN	QPS K	2379 0	1@0	NV	40	0.60	0.0008 45	±2.5	PAS S
Band 17	Stand - Alone	3.75kHz z	NaN	QPS K	2379 0	1@0	NV	50	0.30	0.0004 23	±2.5	PAS S
Band 17	Stand - Alone	3.75kHz z	NaN	QPS K	2379 0	1@0	NV	30	-0.10	- 0.0001 41	±2.5	PAS S
Band 17	Stand - Alone	3.75kHz z	NaN	QPS K	2379 0	1@0	NV	20	1.60	0.0022 54	±2.5	PAS S

Band 17	Stand - Alone	3.75kHz	NaN	QPS K	23790	1@0	NV	0	-7.60	-	0.010704	±2.5	PASS
Band 17	Stand - Alone	3.75kHz	NaN	QPS K	23790	1@0	NV	-10	0.50	0.000704	±2.5	PASS	
Band 17	Stand - Alone	3.75kHz	NaN	QPS K	23790	1@0	NV	-20	2.20	0.003099	±2.5	PASS	
Band 17	Stand - Alone	3.75kHz	NaN	QPS K	23790	1@0	NV	-30	1.50	0.002113	±2.5	PASS	
Band 17	Stand - Alone	3.75kHz	NaN	QPS K	23790	1@0	NV	10	1.60	0.002254	±2.5	PASS	
Band 17	Stand - Alone	3.75kHz	NaN	QPS K	23790	1@47	NV	20	-8.90	-	0.012535	±2.5	PASS
Band 17	Stand - Alone	3.75kHz	NaN	QPS K	23790	1@47	NV	50	1.60	0.002254	±2.5	PASS	
Band 17	Stand - Alone	3.75kHz	NaN	QPS K	23790	1@47	NV	-30	1.20	0.001690	±2.5	PASS	
Band 17	Stand - Alone	3.75kHz	NaN	QPS K	23790	1@47	NV	30	0.50	0.000704	±2.5	PASS	
Band 17	Stand - Alone	3.75kHz	NaN	QPS K	23790	1@47	NV	10	4.50	0.006338	±2.5	PASS	
Band 17	Stand - Alone	3.75kHz	NaN	QPS K	23790	1@47	NV	0	3.10	0.004366	±2.5	PASS	
Band 17	Stand - Alone	3.75kHz	NaN	QPS K	23790	1@47	NV	-10	-5.40	-	0.007606	±2.5	PASS
Band 17	Stand - Alone	3.75kHz	NaN	QPS K	23790	1@47	NV	-20	-3.90	-	0.005493	±2.5	PASS
Band 17	Stand - Alone	3.75kHz	NaN	QPS K	23790	1@47	NV	40	2.10	0.002958	±2.5	PASS	
Band 17	Stand - Alone	15kHz	NaN	QPS K	23790	1@0	NV	40	-6.80	-	0.009577	±2.5	PASS

Band 17	Stand - Alone	15kHz	NaN	QPS K	2379 0	1@0	NV	-30	-2.30	- 0.0032 39	±2.5	PAS S
Band 17	Stand - Alone	15kHz	NaN	QPS K	2379 0	1@0	NV	-20	-6.70	- 0.0094 37	±2.5	PAS S
Band 17	Stand - Alone	15kHz	NaN	QPS K	2379 0	1@0	NV	-10	10.20	0.0143 66	±2.5	PAS S
Band 17	Stand - Alone	15kHz	NaN	QPS K	2379 0	1@0	NV	0	13.50	0.0190 14	±2.5	PAS S
Band 17	Stand - Alone	15kHz	NaN	QPS K	2379 0	1@0	NV	10	-2.20	- 0.0030 99	±2.5	PAS S
Band 17	Stand - Alone	15kHz	NaN	QPS K	2379 0	1@0	NV	20	-5.40	- 0.0076 06	±2.5	PAS S
Band 17	Stand - Alone	15kHz	NaN	QPS K	2379 0	1@0	NV	30	12.60	0.0177 46	±2.5	PAS S
Band 17	Stand - Alone	15kHz	NaN	QPS K	2379 0	1@0	NV	50	10.40	0.0146 48	±2.5	PAS S
Band 17	Stand - Alone	15kHz	NaN	QPS K	2379 0	1@1 1	NV	-30	-8.70	- 0.0122 54	±2.5	PAS S
Band 17	Stand - Alone	15kHz	NaN	QPS K	2379 0	1@1 1	NV	50	-10.30	- 0.0145 07	±2.5	PAS S
Band 17	Stand - Alone	15kHz	NaN	QPS K	2379 0	1@1 1	NV	40	-9.10	- 0.0128 17	±2.5	PAS S
Band 17	Stand - Alone	15kHz	NaN	QPS K	2379 0	1@1 1	NV	30	2.60	0.0036 62	±2.5	PAS S
Band 17	Stand - Alone	15kHz	NaN	QPS K	2379 0	1@1 1	NV	20	-2.90	- 0.0040 85	±2.5	PAS S
Band 17	Stand - Alone	15kHz	NaN	QPS K	2379 0	1@1 1	NV	10	-3.70	- 0.0052 11	±2.5	PAS S
Band 17	Stand - Alone	15kHz	NaN	QPS K	2379 0	1@1 1	NV	0	4.10	0.0057 75	±2.5	PAS S

Band 17	Stand - Alone	15kHz	NaN	QPS K	2379 0	1@1 1	NV	-10	2.80	0.0039 44	±2.5	PAS S
Band 17	Stand - Alone	15kHz	NaN	QPS K	2379 0	1@1 1	NV	-20	-5.30	- 0.0074 65	±2.5	PAS S
Band 18	Stand - Alone	3.75kHz	NaN	QPS K	2392 5	1@0	NV	20	9.00	0.0109 42	±2.5	PAS S
Band 18	Stand - Alone	3.75kHz	NaN	QPS K	2392 5	1@0	NV	10	-3.00	- 0.0036 47	±2.5	PAS S
Band 18	Stand - Alone	3.75kHz	NaN	QPS K	2392 5	1@0	NV	50	8.80	0.0106 99	±2.5	PAS S
Band 18	Stand - Alone	3.75kHz	NaN	QPS K	2392 5	1@0	NV	30	-3.70	- 0.0044 98	±2.5	PAS S
Band 18	Stand - Alone	3.75kHz	NaN	QPS K	2392 5	1@0	NV	0	7.60	0.0092 40	±2.5	PAS S
Band 18	Stand - Alone	3.75kHz	NaN	QPS K	2392 5	1@0	NV	-20	-1.50	- 0.0018 24	±2.5	PAS S
Band 18	Stand - Alone	3.75kHz	NaN	QPS K	2392 5	1@0	NV	-10	6.90	0.0083 89	±2.5	PAS S
Band 18	Stand - Alone	3.75kHz	NaN	QPS K	2392 5	1@0	NV	40	5.30	0.0064 44	±2.5	PAS S
Band 18	Stand - Alone	3.75kHz	NaN	QPS K	2392 5	1@0	NV	-30	0.10	0.0001 22	±2.5	PAS S
Band 18	Stand - Alone	3.75kHz	NaN	QPS K	2392 5	1@4 7	NV	0	2.40	0.0029 18	±2.5	PAS S
Band 18	Stand - Alone	3.75kHz	NaN	QPS K	2392 5	1@4 7	NV	50	-0.70	- 0.0008 51	±2.5	PAS S
Band 18	Stand - Alone	3.75kHz	NaN	QPS K	2392 5	1@4 7	NV	40	-10.50	- 0.0127 66	±2.5	PAS S
Band 18	Stand - Alone	3.75kHz	NaN	QPS K	2392 5	1@4 7	NV	30	0.10	0.0001 22	±2.5	PAS S

Band 18	Stand - Alone	3.75kHz	NaN	QPS K	2392 5	1@4 7	NV	10	11.40	0.0138 60	±2.5	PAS S
Band 18	Stand - Alone	3.75kHz	NaN	QPS K	2392 5	1@4 7	NV	-10	3.50	0.0042 55	±2.5	PAS S
Band 18	Stand - Alone	3.75kHz	NaN	QPS K	2392 5	1@4 7	NV	-20	4.80	0.0058 36	±2.5	PAS S
Band 18	Stand - Alone	3.75kHz	NaN	QPS K	2392 5	1@4 7	NV	-30	-5.80	- 0.0070 52	±2.5	PAS S
Band 18	Stand - Alone	3.75kHz	NaN	QPS K	2392 5	1@4 7	NV	20	-9.20	- 0.0111 85	±2.5	PAS S
Band 18	Stand - Alone	15kHz	NaN	QPS K	2392 5	1@0	NV	10	1.80	0.0021 88	±2.5	PAS S
Band 18	Stand - Alone	15kHz	NaN	QPS K	2392 5	1@0	NV	20	-9.10	- 0.0110 64	±2.5	PAS S
Band 18	Stand - Alone	15kHz	NaN	QPS K	2392 5	1@0	NV	50	4.60	0.0055 93	±2.5	PAS S
Band 18	Stand - Alone	15kHz	NaN	QPS K	2392 5	1@0	NV	30	-5.10	- 0.0062 01	±2.5	PAS S
Band 18	Stand - Alone	15kHz	NaN	QPS K	2392 5	1@0	NV	0	-7.50	- 0.0091 19	±2.5	PAS S
Band 18	Stand - Alone	15kHz	NaN	QPS K	2392 5	1@0	NV	-10	3.50	0.0042 55	±2.5	PAS S
Band 18	Stand - Alone	15kHz	NaN	QPS K	2392 5	1@0	NV	-20	4.10	0.0049 85	±2.5	PAS S
Band 18	Stand - Alone	15kHz	NaN	QPS K	2392 5	1@0	NV	40	3.00	0.0036 47	±2.5	PAS S
Band 18	Stand - Alone	15kHz	NaN	QPS K	2392 5	1@0	NV	-30	-3.30	- 0.0040 12	±2.5	PAS S
Band 18	Stand - Alone	15kHz	NaN	QPS K	2392 5	1@1 1	NV	-10	-5.20	- 0.0063 22	±2.5	PAS S

Band 18	Stand - Alone	15kHz	NaN	QPS K	2392 5	1@1 1	NV	20	-7.30	- 0.0088 75	±2.5	PAS S
Band 18	Stand - Alone	15kHz	NaN	QPS K	2392 5	1@1 1	NV	50	2.50	0.0030 40	±2.5	PAS S
Band 18	Stand - Alone	15kHz	NaN	QPS K	2392 5	1@1 1	NV	0	1.80	0.0021 88	±2.5	PAS S
Band 18	Stand - Alone	15kHz	NaN	QPS K	2392 5	1@1 1	NV	-20	4.90	0.0059 57	±2.5	PAS S
Band 18	Stand - Alone	15kHz	NaN	QPS K	2392 5	1@1 1	NV	-30	4.40	0.0053 50	±2.5	PAS S
Band 18	Stand - Alone	15kHz	NaN	QPS K	2392 5	1@1 1	NV	30	-4.20	- 0.0051 06	±2.5	PAS S
Band 18	Stand - Alone	15kHz	NaN	QPS K	2392 5	1@1 1	NV	10	-5.40	- 0.0065 65	±2.5	PAS S
Band 18	Stand - Alone	15kHz	NaN	QPS K	2392 5	1@1 1	NV	40	-4.50	- 0.0054 71	±2.5	PAS S
Band 19	Stand - Alone	3.75kHz	NaN	QPS K	2407 5	1@0	NV	20	-4.60	- 0.0054 93	±2.5	PAS S
Band 19	Stand - Alone	3.75kHz	NaN	QPS K	2407 5	1@0	NV	-30	0.20	0.0002 39	±2.5	PAS S
Band 19	Stand - Alone	3.75kHz	NaN	QPS K	2407 5	1@0	NV	-20	-0.70	- 0.0008 36	±2.5	PAS S
Band 19	Stand - Alone	3.75kHz	NaN	QPS K	2407 5	1@0	NV	-10	-2.50	- 0.0029 85	±2.5	PAS S
Band 19	Stand - Alone	3.75kHz	NaN	QPS K	2407 5	1@0	NV	10	-3.20	- 0.0038 21	±2.5	PAS S
Band 19	Stand - Alone	3.75kHz	NaN	QPS K	2407 5	1@0	NV	30	-0.90	- 0.0010 75	±2.5	PAS S
Band 19	Stand - Alone	3.75kHz	NaN	QPS K	2407 5	1@0	NV	40	-2.20	- 0.0026 27	±2.5	PAS S

Band 19	Stand - Alone	3.75kHz	NaN	QPS K	2407 5	1@0	NV	50	5.60	0.0066 87	±2.5	PAS S
Band 19	Stand - Alone	3.75kHz	NaN	QPS K	2407 5	1@0	NV	0	-2.50	0.0029 85	±2.5	PAS S
Band 19	Stand - Alone	3.75kHz	NaN	QPS K	2407 5	1@4 7	NV	10	3.50	0.0041 79	±2.5	PAS S
Band 19	Stand - Alone	3.75kHz	NaN	QPS K	2407 5	1@4 7	NV	-30	-1.70	0.0020 30	±2.5	PAS S
Band 19	Stand - Alone	3.75kHz	NaN	QPS K	2407 5	1@4 7	NV	-20	6.60	0.0078 81	±2.5	PAS S
Band 19	Stand - Alone	3.75kHz	NaN	QPS K	2407 5	1@4 7	NV	-10	5.00	0.0059 70	±2.5	PAS S
Band 19	Stand - Alone	3.75kHz	NaN	QPS K	2407 5	1@4 7	NV	0	4.40	0.0052 54	±2.5	PAS S
Band 19	Stand - Alone	3.75kHz	NaN	QPS K	2407 5	1@4 7	NV	20	2.80	0.0033 43	±2.5	PAS S
Band 19	Stand - Alone	3.75kHz	NaN	QPS K	2407 5	1@4 7	NV	30	2.30	0.0027 46	±2.5	PAS S
Band 19	Stand - Alone	3.75kHz	NaN	QPS K	2407 5	1@4 7	NV	40	1.80	0.0021 49	±2.5	PAS S
Band 19	Stand - Alone	3.75kHz	NaN	QPS K	2407 5	1@4 7	NV	50	1.40	0.0016 72	±2.5	PAS S
Band 19	Stand - Alone	15kHz	NaN	QPS K	2407 5	1@0	NV	-30	2.50	0.0029 85	±2.5	PAS S
Band 19	Stand - Alone	15kHz	NaN	QPS K	2407 5	1@0	NV	10	-9.20	0.0109 85	±2.5	PAS S
Band 19	Stand - Alone	15kHz	NaN	QPS K	2407 5	1@0	NV	-20	2.30	0.0027 46	±2.5	PAS S
Band 19	Stand - Alone	15kHz	NaN	QPS K	2407 5	1@0	NV	-10	1.70	0.0020 30	±2.5	PAS S

Band 19	Stand - Alone	15kHz	NaN	QPS K	2407 5	1@0	NV	50	-2.00	- 0.0023 88	±2.5	PAS S
Band 19	Stand - Alone	15kHz	NaN	QPS K	2407 5	1@0	NV	20	-1.40	- 0.0016 72	±2.5	PAS S
Band 19	Stand - Alone	15kHz	NaN	QPS K	2407 5	1@0	NV	0	2.20	0.0026 27	±2.5	PAS S
Band 19	Stand - Alone	15kHz	NaN	QPS K	2407 5	1@0	NV	40	-1.60	- 0.0019 10	±2.5	PAS S
Band 19	Stand - Alone	15kHz	NaN	QPS K	2407 5	1@0	NV	30	0.80	0.0009 55	±2.5	PAS S
Band 19	Stand - Alone	15kHz	NaN	QPS K	2407 5	1@1 1	NV	-30	0.90	0.0010 75	±2.5	PAS S
Band 19	Stand - Alone	15kHz	NaN	QPS K	2407 5	1@1 1	NV	-20	-3.30	- 0.0039 40	±2.5	PAS S
Band 19	Stand - Alone	15kHz	NaN	QPS K	2407 5	1@1 1	NV	-10	1.00	0.0011 94	±2.5	PAS S
Band 19	Stand - Alone	15kHz	NaN	QPS K	2407 5	1@1 1	NV	0	0.70	0.0008 36	±2.5	PAS S
Band 19	Stand - Alone	15kHz	NaN	QPS K	2407 5	1@1 1	NV	10	0.80	0.0009 55	±2.5	PAS S
Band 19	Stand - Alone	15kHz	NaN	QPS K	2407 5	1@1 1	NV	20	0.60	0.0007 16	±2.5	PAS S
Band 19	Stand - Alone	15kHz	NaN	QPS K	2407 5	1@1 1	NV	30	0.50	0.0005 97	±2.5	PAS S
Band 19	Stand - Alone	15kHz	NaN	QPS K	2407 5	1@1 1	NV	50	0.90	0.0010 75	±2.5	PAS S
Band 19	Stand - Alone	15kHz	NaN	QPS K	2407 5	1@1 1	NV	40	-2.70	- 0.0032 24	±2.5	PAS S
Band 25	Stand - Alone	3.75kHz	NaN	QPS K	2636 5	1@0	NV	-30	-5.00	- 0.0026 56	±2.5	PAS S



Band 25	Stand - Alone	3.75kHz	NaN	QPS K	26365	1@0	NV	10	-0.90	-	0.000478	±2.5	PASS
Band 25	Stand - Alone	3.75kHz	NaN	QPS K	26365	1@0	NV	0	2.90	-	0.001541	±2.5	PASS
Band 25	Stand - Alone	3.75kHz	NaN	QPS K	26365	1@0	NV	-20	3.10	-	0.001647	±2.5	PASS
Band 25	Stand - Alone	3.75kHz	NaN	QPS K	26365	1@0	NV	20	-0.50	-	0.000266	±2.5	PASS
Band 25	Stand - Alone	3.75kHz	NaN	QPS K	26365	1@47	NV	20	1.90	-	0.001009	±2.5	PASS
Band 25	Stand - Alone	3.75kHz	NaN	QPS K	26365	1@47	NV	-30	-9.30	-	0.004940	±2.5	PASS
Band 25	Stand - Alone	3.75kHz	NaN	QPS K	26365	1@47	NV	-20	-1.80	-	0.000956	±2.5	PASS
Band 25	Stand - Alone	3.75kHz	NaN	QPS K	26365	1@47	NV	0	-6.20	-	0.003293	±2.5	PASS
Band 25	Stand - Alone	3.75kHz	NaN	QPS K	26365	1@47	NV	10	-8.60	-	0.004568	±2.5	PASS
Band 25	Stand - Alone	15kHz	NaN	QPS K	26365	1@0	NV	0	-5.30	-	0.002815	±2.5	PASS
Band 25	Stand - Alone	15kHz	NaN	QPS K	26365	1@0	NV	-20	-6.10	-	0.003240	±2.5	PASS
Band 25	Stand - Alone	15kHz	NaN	QPS K	26365	1@0	NV	10	7.00	-	0.003718	±2.5	PASS
Band 25	Stand - Alone	15kHz	NaN	QPS K	26365	1@0	NV	20	-5.90	-	0.003134	±2.5	PASS
Band 25	Stand - Alone	15kHz	NaN	QPS K	26365	1@0	NV	-30	-3.10	-	0.001647	±2.5	PASS
Band 25	Stand - Alone	15kHz	NaN	QPS K	26365	1@11	NV	-30	-11.70	-	0.006215	±2.5	PASS

Band 25	Stand - Alone	15kHz	NaN	QPS K	2636 5	1@1 1	NV	-20	-8.00	- 0.0042 50	±2.5	PAS S
Band 25	Stand - Alone	15kHz	NaN	QPS K	2636 5	1@1 1	NV	0	0.80	0.0004 25	±2.5	PAS S
Band 25	Stand - Alone	15kHz	NaN	QPS K	2636 5	1@1 1	NV	10	1.50	0.0007 97	±2.5	PAS S
Band 25	Stand - Alone	15kHz	NaN	QPS K	2636 5	1@1 1	NV	20	-1.80	- 0.0009 56	±2.5	PAS S
Band 26	Stand - Alone	3.75kHz	NaN	QPS K	2674 0	1@0	NV	0	6.28	0.0076 68	±2.5	PAS S
Band 26	Stand - Alone	3.75kHz	NaN	QPS K	2674 0	1@0	NV	10	7.04	0.0085 96	±2.5	PAS S
Band 26	Stand - Alone	3.75kHz	NaN	QPS K	2674 0	1@0	NV	20	-4.29	- 0.0052 38	±2.5	PAS S
Band 26	Stand - Alone	3.75kHz	NaN	QPS K	2674 0	1@0	NV	-20	4.38	0.0053 48	±2.5	PAS S
Band 26	Stand - Alone	3.75kHz	NaN	QPS K	2674 0	1@0	NV	-30	4.68	0.0057 14	±2.5	PAS S
Band 26	Stand - Alone	3.75kHz	NaN	QPS K	2674 0	1@4 7	NV	-30	7.58	0.0092 55	±2.5	PAS S
Band 26	Stand - Alone	3.75kHz	NaN	QPS K	2674 0	1@4 7	NV	-20	10.26	0.0125 27	±2.5	PAS S
Band 26	Stand - Alone	3.75kHz	NaN	QPS K	2674 0	1@4 7	NV	0	9.85	0.0120 27	±2.5	PAS S
Band 26	Stand - Alone	3.75kHz	NaN	QPS K	2674 0	1@4 7	NV	10	9.38	0.0114 53	±2.5	PAS S
Band 26	Stand - Alone	3.75kHz	NaN	QPS K	2674 0	1@4 7	NV	20	10.67	0.0130 28	±2.5	PAS S
Band 26	Stand - Alone	15kHz	NaN	QPS K	2674 0	1@0	NV	-30	14.07	0.0171 79	±2.5	PAS S

Band 26	Stand - Alone	15kHz	NaN	QPS K	26740	1@0	NV	20	13.51	0.016496	±2.5	PAS S
Band 26	Stand - Alone	15kHz	NaN	QPS K	26740	1@0	NV	10	-11.33	0.013834	±2.5	PAS S
Band 26	Stand - Alone	15kHz	NaN	QPS K	26740	1@0	NV	-20	13.70	0.016728	±2.5	PAS S
Band 26	Stand - Alone	15kHz	NaN	QPS K	26740	1@0	NV	0	13.19	0.016105	±2.5	PAS S
Band 26	Stand - Alone	15kHz	NaN	QPS K	26740	1@11	NV	-30	14.50	0.017705	±2.5	PAS S
Band 26	Stand - Alone	15kHz	NaN	QPS K	26740	1@11	NV	-20	-13.87	0.016935	±2.5	PAS S
Band 26	Stand - Alone	15kHz	NaN	QPS K	26740	1@11	NV	0	14.41	0.017595	±2.5	PAS S
Band 26	Stand - Alone	15kHz	NaN	QPS K	26740	1@11	NV	10	-14.83	0.018107	±2.5	PAS S
Band 26	Stand - Alone	15kHz	NaN	QPS K	26740	1@11	NV	20	15.96	0.019487	±2.5	PAS S
Band 26	Stand - Alone	3.75kHz	NaN	QPS K	26915	1@0	NV	0	8.94	0.010687	±2.5	PAS S
Band 26	Stand - Alone	3.75kHz	NaN	QPS K	26915	1@0	NV	10	-5.38	0.006432	±2.5	PAS S
Band 26	Stand - Alone	3.75kHz	NaN	QPS K	26915	1@0	NV	20	-4.39	0.005248	±2.5	PAS S
Band 26	Stand - Alone	3.75kHz	NaN	QPS K	26915	1@0	NV	-20	-3.03	0.003622	±2.5	PAS S
Band 26	Stand - Alone	3.75kHz	NaN	QPS K	26915	1@0	NV	-30	-2.24	0.002678	±2.5	PAS S
Band 26	Stand - Alone	3.75kHz	NaN	QPS K	26915	1@47	NV	-30	-4.57	0.005463	±2.5	PAS S

Band 26	Stand - Alone	3.75kHz	NaN	QPS K	26915	1@47	NV	-20	12.01	0.014357	±2.5	PASS	
Band 26	Stand - Alone	3.75kHz	NaN	QPS K	26915	1@47	NV	0	2.15	0.002570	±2.5	PASS	
Band 26	Stand - Alone	3.75kHz	NaN	QPS K	26915	1@47	NV	10	12.85	0.015362	±2.5	PASS	
Band 26	Stand - Alone	3.75kHz	NaN	QPS K	26915	1@47	NV	20	10.93	0.013066	±2.5	PASS	
Band 26	Stand - Alone	15kHz	NaN	QPS K	26915	1@0	NV	-30	7.74	0.009253	±2.5	PASS	
Band 26	Stand - Alone	15kHz	NaN	QPS K	26915	1@0	NV	20	20.67	0.024710	±2.5	PASS	
Band 26	Stand - Alone	15kHz	NaN	QPS K	26915	1@0	NV	10	11.63	0.013903	±2.5	PASS	
Band 26	Stand - Alone	15kHz	NaN	QPS K	26915	1@0	NV	-20	21.43	0.025619	±2.5	PASS	
Band 26	Stand - Alone	15kHz	NaN	QPS K	26915	1@0	NV	0	7.95	0.009504	±2.5	PASS	
Band 26	Stand - Alone	15kHz	NaN	QPS K	26915	1@11	NV	-30	-13.71	-	0.016390	±2.5	PASS
Band 26	Stand - Alone	15kHz	NaN	QPS K	26915	1@11	NV	-20	13.09	0.015649	±2.5	PASS	
Band 26	Stand - Alone	15kHz	NaN	QPS K	26915	1@11	NV	0	10.46	0.012504	±2.5	PASS	
Band 26	Stand - Alone	15kHz	NaN	QPS K	26915	1@11	NV	10	-14.33	-	0.017131	±2.5	PASS
Band 26	Stand - Alone	15kHz	NaN	QPS K	26915	1@11	NV	20	10.49	0.012540	±2.5	PASS	
Band 66	Stand - Alone	3.75kHz	NaN	QPS K	132322	1@0	NV	-20	7.40	0.004241	±2.5	PASS	

Band 66	Stand - Alone	3.75kHz	NaN	QPS K	1323 22	1@0	NV	0	5.30	0.0030 37	±2.5	PAS S
Band 66	Stand - Alone	3.75kHz	NaN	QPS K	1323 22	1@0	NV	10	6.00	0.0034 38	±2.5	PAS S
Band 66	Stand - Alone	3.75kHz	NaN	QPS K	1323 22	1@0	NV	20	6.20	0.0035 53	±2.5	PAS S
Band 66	Stand - Alone	3.75kHz	NaN	QPS K	1323 22	1@0	NV	-30	-4.00	- 0.0022 92	±2.5	PAS S
Band 66	Stand - Alone	3.75kHz	NaN	QPS K	1323 22	1@4 7	NV	20	6.50	0.0037 25	±2.5	PAS S
Band 66	Stand - Alone	3.75kHz	NaN	QPS K	1323 22	1@4 7	NV	10	1.20	0.0006 88	±2.5	PAS S
Band 66	Stand - Alone	3.75kHz	NaN	QPS K	1323 22	1@4 7	NV	0	1.50	0.0008 60	±2.5	PAS S
Band 66	Stand - Alone	3.75kHz	NaN	QPS K	1323 22	1@4 7	NV	-30	-3.50	- 0.0020 06	±2.5	PAS S
Band 66	Stand - Alone	3.75kHz	NaN	QPS K	1323 22	1@4 7	NV	-20	4.40	0.0025 21	±2.5	PAS S
Band 66	Stand - Alone	15kHz	NaN	QPS K	1323 22	1@0	NV	0	-3.20	- 0.0018 34	±2.5	PAS S
Band 66	Stand - Alone	15kHz	NaN	QPS K	1323 22	1@0	NV	-30	1.90	0.0010 89	±2.5	PAS S
Band 66	Stand - Alone	15kHz	NaN	QPS K	1323 22	1@0	NV	-20	-0.10	- 0.0000 57	±2.5	PAS S
Band 66	Stand - Alone	15kHz	NaN	QPS K	1323 22	1@0	NV	20	6.40	0.0036 68	±2.5	PAS S
Band 66	Stand - Alone	15kHz	NaN	QPS K	1323 22	1@0	NV	10	6.20	0.0035 53	±2.5	PAS S
Band 66	Stand - Alone	15kHz	NaN	QPS K	1323 22	1@1 1	NV	-30	-3.50	- 0.0020 06	±2.5	PAS S

Band 66	Stand - Alone	15kHz	NaN	QPS K	1323 22	1@1 1	NV	-20	-6.30	- 0.0036 10	±2.5	PAS S
Band 66	Stand - Alone	15kHz	NaN	QPS K	1323 22	1@1 1	NV	0	-2.10	- 0.0012 03	±2.5	PAS S
Band 66	Stand - Alone	15kHz	NaN	QPS K	1323 22	1@1 1	NV	10	-6.90	- 0.0039 54	±2.5	PAS S
Band 66	Stand - Alone	15kHz	NaN	QPS K	1323 22	1@1 1	NV	20	-8.50	- 0.0048 71	±2.5	PAS S
Band 85	Stand - Alone	3.75kHz	NaN	QPS K	1340 92	1@0	NV	20	-1.40	- 0.0019 80	±2.5	PAS S
Band 85	Stand - Alone	3.75kHz	NaN	QPS K	1340 92	1@0	NV	-30	-4.80	- 0.0067 89	±2.5	PAS S
Band 85	Stand - Alone	3.75kHz	NaN	QPS K	1340 92	1@0	NV	10	0.40	- 0.0005 66	±2.5	PAS S
Band 85	Stand - Alone	3.75kHz	NaN	QPS K	1340 92	1@0	NV	0	-9.90	- 0.0140 03	±2.5	PAS S
Band 85	Stand - Alone	3.75kHz	NaN	QPS K	1340 92	1@0	NV	-20	4.70	- 0.0066 48	±2.5	PAS S
Band 85	Stand - Alone	3.75kHz	NaN	QPS K	1340 92	1@4 7	NV	0	-5.10	- 0.0072 14	±2.5	PAS S
Band 85	Stand - Alone	3.75kHz	NaN	QPS K	1340 92	1@4 7	NV	10	-2.90	- 0.0041 02	±2.5	PAS S
Band 85	Stand - Alone	3.75kHz	NaN	QPS K	1340 92	1@4 7	NV	-20	-1.90	- 0.0026 87	±2.5	PAS S
Band 85	Stand - Alone	3.75kHz	NaN	QPS K	1340 92	1@4 7	NV	-30	-3.50	- 0.0049 50	±2.5	PAS S
Band 85	Stand - Alone	3.75kHz	NaN	QPS K	1340 92	1@4 7	NV	20	4.10	- 0.0057 99	±2.5	PAS S
Band 85	Stand - Alone	15kHz	NaN	QPS K	1340 92	1@0	NV	-30	10.10	- 0.0142 86	±2.5	PAS S

Band 85	Stand - Alone	15kHz	NaN	QPS K	1340 92	1@0	NV	-20	9.20	0.0130 13	±2.5	PAS S
Band 85	Stand - Alone	15kHz	NaN	QPS K	1340 92	1@0	NV	0	-0.40	- 0.0005 66	±2.5	PAS S
Band 85	Stand - Alone	15kHz	NaN	QPS K	1340 92	1@0	NV	10	8.60	0.0121 64	±2.5	PAS S
Band 85	Stand - Alone	15kHz	NaN	QPS K	1340 92	1@0	NV	20	8.90	0.0125 88	±2.5	PAS S
Band 85	Stand - Alone	15kHz	NaN	QPS K	1340 92	1@1 1	NV	-30	-0.20	- 0.0002 83	±2.5	PAS S
Band 85	Stand - Alone	15kHz	NaN	QPS K	1340 92	1@1 1	NV	-20	-10.70	- 0.0151 34	±2.5	PAS S
Band 85	Stand - Alone	15kHz	NaN	QPS K	1340 92	1@1 1	NV	0	4.00	0.0056 58	±2.5	PAS S
Band 85	Stand - Alone	15kHz	NaN	QPS K	1340 92	1@1 1	NV	10	-9.70	- 0.0137 20	±2.5	PAS S
Band 85	Stand - Alone	15kHz	NaN	QPS K	1340 92	1@1 1	NV	20	4.00	0.0056 58	±2.5	PAS S

<b>4.4 Occupied Bandwidth</b>	<b>VERDICT: PASS</b>
-------------------------------	----------------------

4.4.1 Limit	
NB-IoT Band	Standard
2/4/5/12/13/17/18/19 /25/26/66/85	FCC §2.1049: The occupied bandwidth, that is the frequency bandwidth such that, below its lower and above its upper frequency limits, the mean powers radiated are each equal to 0.5 percent of the total mean power radiated by a given emission shall be measured.

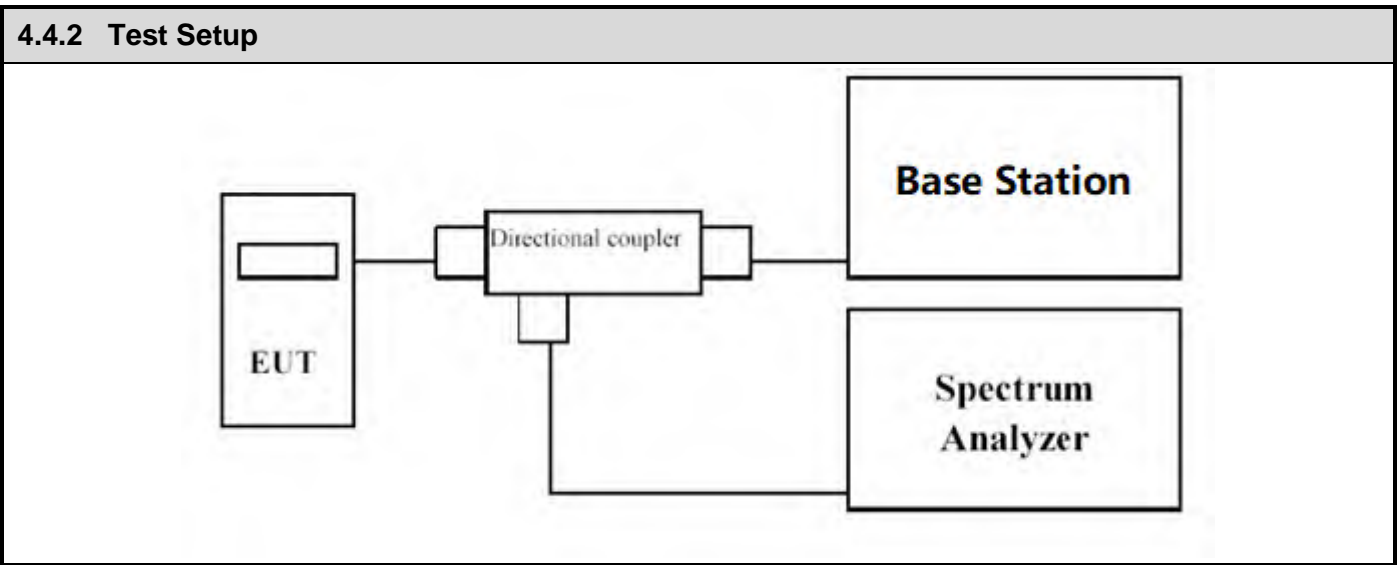

4.4.3 Test Procedure			
	References Rule	Chapter	Description
<input checked="" type="checkbox"/>	ANSI C63.26	5.4	Occupied bandwidth
<p>The occupied bandwidth measurement was performed at the output terminals of the EUT using directional coupler and spectrum analyser. The EUT was controller via the Universal Radio Communication tester R&amp;S CMW500 selecting maximum transmission power of the EUT and different modes of modulation. The 99% occupied bandwidth and the -26 dBc bandwidth were measured directly using the built-in bandwidth measuring option of spectrum analyser.</p>			



**4.4.4 Test Data**

Band	OpMode	SCS	BW	Modu	Channel	Tones	Result (MHz)		Verdict
							99% OB	-26dB BW	
Band2	Stand-Alone	3.75kHz	NaN	BPSK	18602	1@0	0.0440	0.0415	PASS
Band2	Stand-Alone	3.75kHz	NaN	BPSK	18876	1@0	0.0406	0.0374	PASS
Band2	Stand-Alone	3.75kHz	NaN	BPSK	19198	1@0	0.0439	0.0411	PASS
Band2	Stand-Alone	3.75kHz	NaN	QPSK	18602	1@0	0.0445	0.0416	PASS
Band2	Stand-Alone	3.75kHz	NaN	QPSK	18876	1@0	0.0450	0.0414	PASS
Band2	Stand-Alone	3.75kHz	NaN	QPSK	19198	1@0	0.0438	0.0409	PASS
Band2	Stand-Alone	15kHz	NaN	BPSK	18602	1@0	0.0746	0.0988	PASS
Band2	Stand-Alone	15kHz	NaN	BPSK	18602	12@0	0.1853	0.2543	PASS
Band2	Stand-Alone	15kHz	NaN	BPSK	18876	1@0	0.0763	0.0926	PASS
Band2	Stand-Alone	15kHz	NaN	BPSK	18876	12@0	0.1909	0.2630	PASS
Band2	Stand-Alone	15kHz	NaN	BPSK	19198	1@0	0.0736	0.1021	PASS
Band2	Stand-Alone	15kHz	NaN	BPSK	19198	12@0	0.1844	0.2649	PASS
Band2	Stand-Alone	15kHz	NaN	QPSK	18602	1@0	0.0724	0.1008	PASS
Band2	Stand-Alone	15kHz	NaN	QPSK	18602	12@0	0.1855	0.2632	PASS
Band2	Stand-Alone	15kHz	NaN	QPSK	18876	1@0	0.0719	0.0889	PASS
Band2	Stand-Alone	15kHz	NaN	QPSK	18876	12@0	0.1900	0.2626	PASS
Band2	Stand-Alone	15kHz	NaN	QPSK	19198	1@0	0.0743	0.1016	PASS
Band2	Stand-Alone	15kHz	NaN	QPSK	19198	12@0	0.1853	0.2649	PASS
Band4	Stand-Alone	3.75kHz	NaN	BPSK	19952	1@0	0.0433	0.0409	PASS
Band4	Stand-Alone	3.75kHz	NaN	BPSK	20175	1@0	0.0397	0.0362	PASS
Band4	Stand-Alone	3.75kHz	NaN	BPSK	20398	1@0	0.0429	0.0408	PASS
Band4	Stand-Alone	3.75kHz	NaN	QPSK	19952	1@0	0.0439	0.0415	PASS
Band4	Stand-Alone	3.75kHz	NaN	QPSK	20175	1@0	0.0441	0.0412	PASS
Band4	Stand-Alone	3.75kHz	NaN	QPSK	20398	1@0	0.0436	0.0418	PASS
Band4	Stand-Alone	15kHz	NaN	BPSK	19952	1@0	0.0745	0.1007	PASS
Band4	Stand-Alone	15kHz	NaN	BPSK	19952	12@0	0.1858	0.2639	PASS
Band4	Stand-Alone	15kHz	NaN	BPSK	20175	1@0	0.0755	0.1006	PASS
Band4	Stand-Alone	15kHz	NaN	BPSK	20175	12@0	0.1911	0.2648	PASS
Band4	Stand-Alone	15kHz	NaN	BPSK	20398	1@0	0.0726	0.1021	PASS
Band4	Stand-Alone	15kHz	NaN	BPSK	20398	12@0	0.1845	0.2617	PASS
Band4	Stand-Alone	15kHz	NaN	QPSK	19952	1@0	0.0731	0.1035	PASS
Band4	Stand-Alone	15kHz	NaN	QPSK	19952	12@0	0.1849	0.2639	PASS
Band4	Stand-Alone	15kHz	NaN	QPSK	20175	1@0	0.0722	0.0975	PASS
Band4	Stand-Alone	15kHz	NaN	QPSK	20175	12@0	0.1924	0.2489	PASS
Band4	Stand-Alone	15kHz	NaN	QPSK	20398	1@0	0.0757	0.1009	PASS
Band4	Stand-Alone	15kHz	NaN	QPSK	20398	12@0	0.1854	0.2506	PASS
Band5	Stand-Alone	3.75kHz	NaN	BPSK	20402	1@0	0.0428	0.0409	PASS
Band5	Stand-Alone	3.75kHz	NaN	BPSK	20525	1@0	0.0383	0.0353	PASS
Band5	Stand-Alone	3.75kHz	NaN	BPSK	20648	1@0	0.0424	0.0408	PASS
Band5	Stand-Alone	3.75kHz	NaN	QPSK	20402	1@0	0.0426	0.0405	PASS

Band5	Stand-Alone	3.75kHz	NaN	QPSK	20525	1@0	0.0429	0.0411	PASS
Band5	Stand-Alone	3.75kHz	NaN	QPSK	20648	1@0	0.0421	0.0377	PASS
Band5	Stand-Alone	15kHz	NaN	BPSK	20402	1@0	0.0730	0.1014	PASS
Band5	Stand-Alone	15kHz	NaN	BPSK	20402	12@0	0.1844	0.2538	PASS
Band5	Stand-Alone	15kHz	NaN	BPSK	20525	1@0	0.0734	0.0959	PASS
Band5	Stand-Alone	15kHz	NaN	BPSK	20525	12@0	0.1936	0.2647	PASS
Band5	Stand-Alone	15kHz	NaN	BPSK	20648	1@0	0.0732	0.1013	PASS
Band5	Stand-Alone	15kHz	NaN	BPSK	20648	12@0	0.1819	0.2231	PASS
Band5	Stand-Alone	15kHz	NaN	QPSK	20402	1@0	0.0744	0.1016	PASS
Band5	Stand-Alone	15kHz	NaN	QPSK	20402	12@0	0.1873	0.2490	PASS
Band5	Stand-Alone	15kHz	NaN	QPSK	20525	1@0	0.0707	0.1009	PASS
Band5	Stand-Alone	15kHz	NaN	QPSK	20525	12@0	0.1919	0.2645	PASS
Band5	Stand-Alone	15kHz	NaN	QPSK	20648	1@0	0.0782	0.1011	PASS
Band5	Stand-Alone	15kHz	NaN	QPSK	20648	12@0	0.1858	0.2208	PASS
Band12	Stand-Alone	3.75kHz	NaN	BPSK	23012	1@0	0.0372	0.0357	PASS
Band12	Stand-Alone	3.75kHz	NaN	BPSK	23095	1@0	0.0378	0.0355	PASS
Band12	Stand-Alone	3.75kHz	NaN	BPSK	23178	1@0	0.0374	0.0349	PASS
Band12	Stand-Alone	3.75kHz	NaN	QPSK	23012	1@0	0.0423	0.0413	PASS
Band12	Stand-Alone	3.75kHz	NaN	QPSK	23095	1@0	0.0421	0.0402	PASS
Band12	Stand-Alone	3.75kHz	NaN	QPSK	23178	1@0	0.0414	0.0384	PASS
Band12	Stand-Alone	15kHz	NaN	BPSK	23012	1@0	0.0736	0.0968	PASS
Band12	Stand-Alone	15kHz	NaN	BPSK	23012	12@0	0.1894	0.2635	PASS
Band12	Stand-Alone	15kHz	NaN	BPSK	23095	1@0	0.0709	0.0901	PASS
Band12	Stand-Alone	15kHz	NaN	BPSK	23095	12@0	0.1867	0.2513	PASS
Band12	Stand-Alone	15kHz	NaN	BPSK	23178	1@0	0.0735	0.0923	PASS
Band12	Stand-Alone	15kHz	NaN	BPSK	23178	12@0	0.1925	0.2509	PASS
Band12	Stand-Alone	15kHz	NaN	QPSK	23012	1@0	0.0704	0.0998	PASS
Band12	Stand-Alone	15kHz	NaN	QPSK	23012	12@0	0.1902	0.2499	PASS
Band12	Stand-Alone	15kHz	NaN	QPSK	23095	1@0	0.0699	0.0898	PASS
Band12	Stand-Alone	15kHz	NaN	QPSK	23095	12@0	0.1911	0.2599	PASS
Band12	Stand-Alone	15kHz	NaN	QPSK	23178	1@0	0.0721	0.1013	PASS
Band12	Stand-Alone	15kHz	NaN	QPSK	23178	12@0	0.1940	0.2775	PASS
Band13	Stand-Alone	3.75kHz	NaN	BPSK	23182	1@0	0.0383	0.0359	PASS
Band13	Stand-Alone	3.75kHz	NaN	BPSK	23230	1@0	0.0387	0.0369	PASS
Band13	Stand-Alone	3.75kHz	NaN	BPSK	23278	1@0	0.0385	0.0370	PASS
Band13	Stand-Alone	3.75kHz	NaN	QPSK	23182	1@0	0.0430	0.0409	PASS
Band13	Stand-Alone	3.75kHz	NaN	QPSK	23230	1@0	0.0419	0.0408	PASS
Band13	Stand-Alone	3.75kHz	NaN	QPSK	23278	1@0	0.0427	0.0412	PASS
Band13	Stand-Alone	15kHz	NaN	BPSK	23182	1@0	0.0741	0.0930	PASS
Band13	Stand-Alone	15kHz	NaN	BPSK	23182	12@0	0.1910	0.2525	PASS
Band13	Stand-Alone	15kHz	NaN	BPSK	23230	1@0	0.0736	0.0862	PASS
Band13	Stand-Alone	15kHz	NaN	BPSK	23230	12@0	0.1916	0.2522	PASS
Band13	Stand-Alone	15kHz	NaN	BPSK	23278	1@0	0.0721	0.0892	PASS
Band13	Stand-Alone	15kHz	NaN	BPSK	23278	12@0	0.1923	0.2545	PASS
Band13	Stand-Alone	15kHz	NaN	QPSK	23182	1@0	0.0742	0.1020	PASS
Band13	Stand-Alone	15kHz	NaN	QPSK	23182	12@0	0.1919	0.2763	PASS

Band13	Stand-Alone	15kHz	NaN	QPSK	23230	1@0	0.0748	0.1028	PASS
Band13	Stand-Alone	15kHz	NaN	QPSK	23230	12@0	0.1911	0.2483	PASS
Band13	Stand-Alone	15kHz	NaN	QPSK	23278	1@0	0.0720	0.1006	PASS
Band13	Stand-Alone	15kHz	NaN	QPSK	23278	12@0	0.1841	0.2524	PASS
Band17	Stand-Alone	3.75kHz	NaN	BPSK	23732	1@0	0.0378	0.0351	PASS
Band17	Stand-Alone	3.75kHz	NaN	BPSK	23790	1@0	0.0373	0.0353	PASS
Band17	Stand-Alone	3.75kHz	NaN	BPSK	23848	1@0	0.0383	0.0361	PASS
Band17	Stand-Alone	3.75kHz	NaN	QPSK	23732	1@0	0.0430	0.0414	PASS
Band17	Stand-Alone	3.75kHz	NaN	QPSK	23790	1@0	0.0434	0.0416	PASS
Band17	Stand-Alone	3.75kHz	NaN	QPSK	23848	1@0	0.0419	0.0357	PASS
Band17	Stand-Alone	15kHz	NaN	BPSK	23732	1@0	0.0731	0.0897	PASS
Band17	Stand-Alone	15kHz	NaN	BPSK	23732	12@0	0.1929	0.2659	PASS
Band17	Stand-Alone	15kHz	NaN	BPSK	23790	1@0	0.0730	0.0926	PASS
Band17	Stand-Alone	15kHz	NaN	BPSK	23790	12@0	0.1869	0.2634	PASS
Band17	Stand-Alone	15kHz	NaN	BPSK	23848	1@0	0.0720	0.0903	PASS
Band17	Stand-Alone	15kHz	NaN	BPSK	23848	12@0	0.1930	0.2777	PASS
Band17	Stand-Alone	15kHz	NaN	QPSK	23732	1@0	0.0718	0.0996	PASS
Band17	Stand-Alone	15kHz	NaN	QPSK	23732	12@0	0.1915	0.2646	PASS
Band17	Stand-Alone	15kHz	NaN	QPSK	23790	1@0	0.0708	0.1011	PASS
Band17	Stand-Alone	15kHz	NaN	QPSK	23790	12@0	0.1856	0.2611	PASS
Band17	Stand-Alone	15kHz	NaN	QPSK	23848	1@0	0.0717	0.1004	PASS
Band17	Stand-Alone	15kHz	NaN	QPSK	23848	12@0	0.1929	0.2524	PASS
Band18	Stand-Alone	3.75kHz	NaN	BPSK	23852	1@0	0.0419	0.0403	PASS
Band18	Stand-Alone	3.75kHz	NaN	BPSK	23925	1@0	0.0382	0.0354	PASS
Band18	Stand-Alone	3.75kHz	NaN	BPSK	23998	1@0	0.0412	0.0402	PASS
Band18	Stand-Alone	3.75kHz	NaN	QPSK	23852	1@0	0.0425	0.0406	PASS
Band18	Stand-Alone	3.75kHz	NaN	QPSK	23925	1@0	0.0431	0.0413	PASS
Band18	Stand-Alone	3.75kHz	NaN	QPSK	23998	1@0	0.0421	0.0416	PASS
Band18	Stand-Alone	15kHz	NaN	BPSK	23852	1@0	0.0706	0.0996	PASS
Band18	Stand-Alone	15kHz	NaN	BPSK	23852	12@0	0.1940	0.2657	PASS
Band18	Stand-Alone	15kHz	NaN	BPSK	23925	1@0	0.0718	0.0888	PASS
Band18	Stand-Alone	15kHz	NaN	BPSK	23925	12@0	0.1918	0.2500	PASS
Band18	Stand-Alone	15kHz	NaN	BPSK	23998	1@0	0.0724	0.1017	PASS
Band18	Stand-Alone	15kHz	NaN	BPSK	23998	12@0	0.1966	0.2478	PASS
Band18	Stand-Alone	15kHz	NaN	QPSK	23852	1@0	0.0726	0.1010	PASS
Band18	Stand-Alone	15kHz	NaN	QPSK	23852	12@0	0.1880	0.2673	PASS
Band18	Stand-Alone	15kHz	NaN	QPSK	23925	1@0	0.0730	0.0898	PASS
Band18	Stand-Alone	15kHz	NaN	QPSK	23925	12@0	0.1907	0.2482	PASS
Band18	Stand-Alone	15kHz	NaN	QPSK	23998	1@0	0.0720	0.1016	PASS
Band18	Stand-Alone	15kHz	NaN	QPSK	23998	12@0	0.1824	0.2377	PASS
Band19	Stand-Alone	3.75kHz	NaN	BPSK	24002	1@0	0.0419	0.0411	PASS
Band19	Stand-Alone	3.75kHz	NaN	BPSK	24075	1@0	0.0379	0.0359	PASS
Band19	Stand-Alone	3.75kHz	NaN	BPSK	24148	1@0	0.0424	0.0413	PASS
Band19	Stand-Alone	3.75kHz	NaN	QPSK	24002	1@0	0.0421	0.0414	PASS
Band19	Stand-Alone	3.75kHz	NaN	QPSK	24075	1@0	0.0422	0.0416	PASS
Band19	Stand-Alone	3.75kHz	NaN	QPSK	24148	1@0	0.0414	0.0377	PASS

Band19	Stand-Alone	15kHz	NaN	BPSK	24002	1@0	0.0706	0.0913	PASS
Band19	Stand-Alone	15kHz	NaN	BPSK	24002	12@0	0.1840	0.2511	PASS
Band19	Stand-Alone	15kHz	NaN	BPSK	24075	1@0	0.0737	0.0962	PASS
Band19	Stand-Alone	15kHz	NaN	BPSK	24075	12@0	0.1918	0.2665	PASS
Band19	Stand-Alone	15kHz	NaN	BPSK	24148	1@0	0.0718	0.0905	PASS
Band19	Stand-Alone	15kHz	NaN	BPSK	24148	12@0	0.1930	0.2826	PASS
Band19	Stand-Alone	15kHz	NaN	QPSK	24002	1@0	0.0692	0.0973	PASS
Band19	Stand-Alone	15kHz	NaN	QPSK	24002	12@0	0.1858	0.2351	PASS
Band19	Stand-Alone	15kHz	NaN	QPSK	24075	1@0	0.0705	0.0866	PASS
Band19	Stand-Alone	15kHz	NaN	QPSK	24075	12@0	0.1929	0.2479	PASS
Band19	Stand-Alone	15kHz	NaN	QPSK	24148	1@0	0.0736	0.1149	PASS
Band19	Stand-Alone	15kHz	NaN	QPSK	24148	12@0	0.1881	0.2690	PASS
Band25	Stand-Alone	3.75kHz	NaN	BPSK	26042	1@0	0.0445	0.0381	PASS
Band25	Stand-Alone	3.75kHz	NaN	BPSK	26365	1@0	0.0408	0.0356	PASS
Band25	Stand-Alone	3.75kHz	NaN	BPSK	26688	1@0	0.0444	0.0409	PASS
Band25	Stand-Alone	3.75kHz	NaN	QPSK	26042	1@0	0.0443	0.0411	PASS
Band25	Stand-Alone	3.75kHz	NaN	QPSK	26365	1@0	0.0450	0.0411	PASS
Band25	Stand-Alone	3.75kHz	NaN	QPSK	26688	1@0	0.0436	0.0399	PASS
Band25	Stand-Alone	15kHz	NaN	BPSK	26042	1@0	0.0731	0.1014	PASS
Band25	Stand-Alone	15kHz	NaN	BPSK	26042	12@0	0.1829	0.2339	PASS
Band25	Stand-Alone	15kHz	NaN	BPSK	26365	1@0	0.0797	0.1019	PASS
Band25	Stand-Alone	15kHz	NaN	BPSK	26365	12@0	0.1829	0.2535	PASS
Band25	Stand-Alone	15kHz	NaN	BPSK	26688	1@0	0.0739	0.1022	PASS
Band25	Stand-Alone	15kHz	NaN	BPSK	26688	12@0	0.1852	0.2786	PASS
Band25	Stand-Alone	15kHz	NaN	QPSK	26042	1@0	0.0711	0.1019	PASS
Band25	Stand-Alone	15kHz	NaN	QPSK	26042	12@0	0.1873	0.2631	PASS
Band25	Stand-Alone	15kHz	NaN	QPSK	26365	1@0	0.0804	0.1135	PASS
Band25	Stand-Alone	15kHz	NaN	QPSK	26365	12@0	0.1935	0.2654	PASS
Band25	Stand-Alone	15kHz	NaN	QPSK	26688	1@0	0.0738	0.1021	PASS
Band25	Stand-Alone	15kHz	NaN	QPSK	26688	12@0	0.1834	0.2139	PASS
Band26	Stand-Alone	3.75kHz	NaN	BPSK	26692	1@0	0.0385	0.0346	PASS
Band26	Stand-Alone	3.75kHz	NaN	BPSK	26740	1@0	0.0384	0.0362	PASS
Band26	Stand-Alone	3.75kHz	NaN	BPSK	26788	1@0	0.0386	0.0353	PASS
Band26	Stand-Alone	3.75kHz	NaN	QPSK	26692	1@0	0.0421	0.0400	PASS
Band26	Stand-Alone	3.75kHz	NaN	QPSK	26740	1@0	0.0422	0.0402	PASS
Band26	Stand-Alone	3.75kHz	NaN	QPSK	26788	1@0	0.0430	0.0412	PASS
Band26	Stand-Alone	15kHz	NaN	BPSK	26692	1@0	0.0729	0.1007	PASS
Band26	Stand-Alone	15kHz	NaN	BPSK	26692	12@0	0.1933	0.2651	PASS
Band26	Stand-Alone	15kHz	NaN	BPSK	26740	1@0	0.0726	0.0895	PASS
Band26	Stand-Alone	15kHz	NaN	BPSK	26740	12@0	0.1909	0.2530	PASS
Band26	Stand-Alone	15kHz	NaN	BPSK	26788	1@0	0.0738	0.1011	PASS
Band26	Stand-Alone	15kHz	NaN	BPSK	26788	12@0	0.1927	0.2635	PASS
Band26	Stand-Alone	15kHz	NaN	QPSK	26692	1@0	0.0715	0.0885	PASS
Band26	Stand-Alone	15kHz	NaN	QPSK	26692	12@0	0.1919	0.2630	PASS
Band26	Stand-Alone	15kHz	NaN	QPSK	26740	1@0	0.0751	0.1127	PASS
Band26	Stand-Alone	15kHz	NaN	QPSK	26740	12@0	0.1881	0.2629	PASS

Band26	Stand-Alone	15kHz	NaN	QPSK	26788	1@0	0.0735	0.0998	PASS
Band26	Stand-Alone	15kHz	NaN	QPSK	26788	12@0	0.1911	0.2654	PASS
Band26	Stand-Alone	3.75kHz	NaN	BPSK	26792	1@0	0.0387	0.0360	PASS
Band26	Stand-Alone	3.75kHz	NaN	BPSK	26915	1@0	0.0381	0.0359	PASS
Band26	Stand-Alone	3.75kHz	NaN	BPSK	27038	1@0	0.0387	0.0348	PASS
Band26	Stand-Alone	3.75kHz	NaN	QPSK	26792	1@0	0.0425	0.0407	PASS
Band26	Stand-Alone	3.75kHz	NaN	QPSK	26915	1@0	0.0418	0.0410	PASS
Band26	Stand-Alone	3.75kHz	NaN	QPSK	27038	1@0	0.0415	0.0403	PASS
Band26	Stand-Alone	15kHz	NaN	BPSK	26792	1@0	0.0734	0.0922	PASS
Band26	Stand-Alone	15kHz	NaN	BPSK	26792	12@0	0.1930	0.2764	PASS
Band26	Stand-Alone	15kHz	NaN	BPSK	26915	1@0	0.0719	0.0901	PASS
Band26	Stand-Alone	15kHz	NaN	BPSK	26915	12@0	0.1903	0.2631	PASS
Band26	Stand-Alone	15kHz	NaN	BPSK	27038	1@0	0.0732	0.0898	PASS
Band26	Stand-Alone	15kHz	NaN	BPSK	27038	12@0	0.1935	0.2517	PASS
Band26	Stand-Alone	15kHz	NaN	QPSK	26792	1@0	0.0721	0.0989	PASS
Band26	Stand-Alone	15kHz	NaN	QPSK	26792	12@0	0.1927	0.2657	PASS
Band26	Stand-Alone	15kHz	NaN	QPSK	26915	1@0	0.0726	0.0994	PASS
Band26	Stand-Alone	15kHz	NaN	QPSK	26915	12@0	0.1927	0.2770	PASS
Band26	Stand-Alone	15kHz	NaN	QPSK	27038	1@0	0.0725	0.0906	PASS
Band26	Stand-Alone	15kHz	NaN	QPSK	27038	12@0	0.1934	0.2638	PASS
Band66	Stand-Alone	3.75kHz	NaN	BPSK	131974	1@0	0.0446	0.0409	PASS
Band66	Stand-Alone	3.75kHz	NaN	BPSK	132322	1@0	0.0400	0.0363	PASS
Band66	Stand-Alone	3.75kHz	NaN	BPSK	132670	1@0	0.0444	0.0406	PASS
Band66	Stand-Alone	3.75kHz	NaN	QPSK	131974	1@0	0.0439	0.0408	PASS
Band66	Stand-Alone	3.75kHz	NaN	QPSK	132322	1@0	0.0439	0.0412	PASS
Band66	Stand-Alone	3.75kHz	NaN	QPSK	132670	1@0	0.0445	0.0412	PASS
Band66	Stand-Alone	15kHz	NaN	BPSK	131974	1@0	0.0733	0.1008	PASS
Band66	Stand-Alone	15kHz	NaN	BPSK	131974	12@0	0.1865	0.2393	PASS
Band66	Stand-Alone	15kHz	NaN	BPSK	132322	1@0	0.0721	0.0886	PASS
Band66	Stand-Alone	15kHz	NaN	BPSK	132322	12@0	0.1927	0.2634	PASS
Band66	Stand-Alone	15kHz	NaN	BPSK	132670	1@0	0.0755	0.0997	PASS
Band66	Stand-Alone	15kHz	NaN	BPSK	132670	12@0	0.1847	0.2347	PASS
Band66	Stand-Alone	15kHz	NaN	QPSK	131974	1@0	0.0743	0.1018	PASS
Band66	Stand-Alone	15kHz	NaN	QPSK	131974	12@0	0.1937	0.2826	PASS
Band66	Stand-Alone	15kHz	NaN	QPSK	132322	1@0	0.0726	0.1035	PASS
Band66	Stand-Alone	15kHz	NaN	QPSK	132322	12@0	0.1915	0.2653	PASS
Band66	Stand-Alone	15kHz	NaN	QPSK	132670	1@0	0.0748	0.1019	PASS
Band66	Stand-Alone	15kHz	NaN	QPSK	132670	12@0	0.1957	0.2393	PASS
Band85	Stand-Alone	3.75kHz	NaN	BPSK	134004	1@0	0.0379	0.0370	PASS
Band85	Stand-Alone	3.75kHz	NaN	BPSK	134092	1@0	0.0371	0.0352	PASS
Band85	Stand-Alone	3.75kHz	NaN	BPSK	134180	1@0	0.0381	0.0369	PASS
Band85	Stand-Alone	3.75kHz	NaN	QPSK	134004	1@0	0.0425	0.0418	PASS
Band85	Stand-Alone	3.75kHz	NaN	QPSK	134092	1@0	0.0419	0.0406	PASS
Band85	Stand-Alone	3.75kHz	NaN	QPSK	134180	1@0	0.0410	0.0406	PASS
Band85	Stand-Alone	15kHz	NaN	BPSK	134004	1@0	0.0727	0.0904	PASS
Band85	Stand-Alone	15kHz	NaN	BPSK	134004	12@0	0.1943	0.2647	PASS

Band85	Stand-Alone	15kHz	NaN	BPSK	134092	1@0	0.0721	0.0919	PASS
Band85	Stand-Alone	15kHz	NaN	BPSK	134092	12@0	0.1859	0.2652	PASS
Band85	Stand-Alone	15kHz	NaN	BPSK	134180	1@0	0.0729	0.0926	PASS
Band85	Stand-Alone	15kHz	NaN	BPSK	134180	12@0	0.1913	0.2518	PASS
Band85	Stand-Alone	15kHz	NaN	QPSK	134004	1@0	0.0701	0.0894	PASS
Band85	Stand-Alone	15kHz	NaN	QPSK	134004	12@0	0.1921	0.2545	PASS
Band85	Stand-Alone	15kHz	NaN	QPSK	134092	1@0	0.0728	0.0904	PASS
Band85	Stand-Alone	15kHz	NaN	QPSK	134092	12@0	0.1922	0.2621	PASS
Band85	Stand-Alone	15kHz	NaN	QPSK	134180	1@0	0.0691	0.0896	PASS
Band85	Stand-Alone	15kHz	NaN	QPSK	134180	12@0	0.1932	0.2638	PASS

### Test Graphs

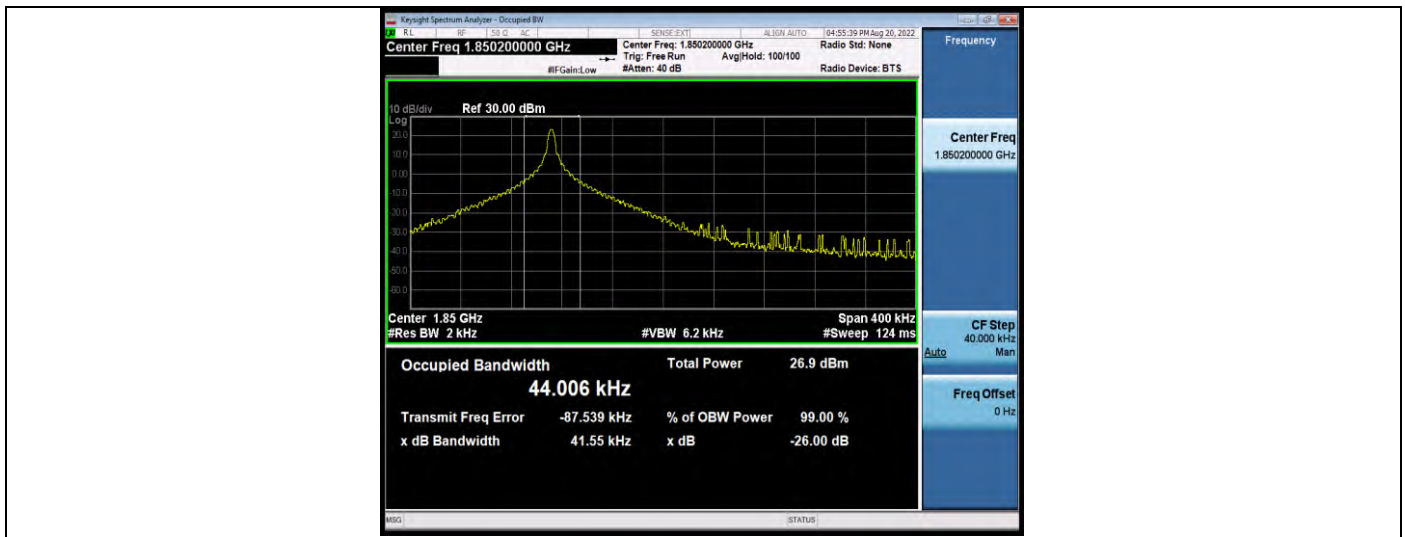

Band2-Stand-Alone-NaN-BPSK-18602-1 @ 0-3.75kHz-0.0415-PASS

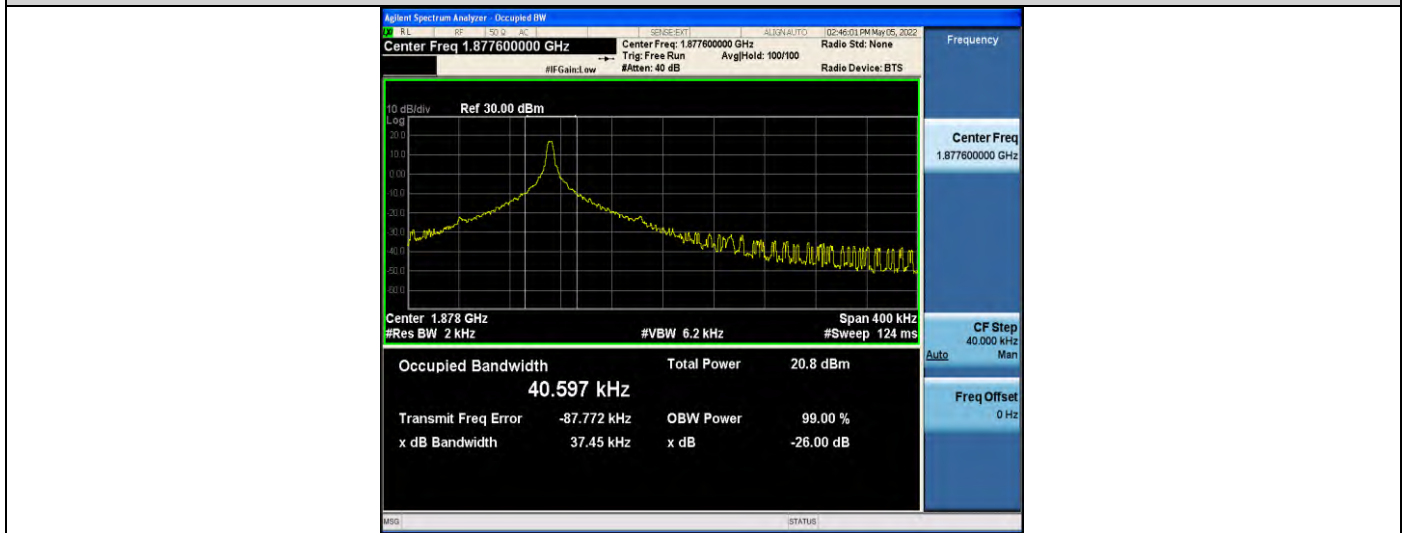

Band2-Stand-Alone-NaN-BPSK-18876-1 @ 0-3.75kHz-0.0374-PASS

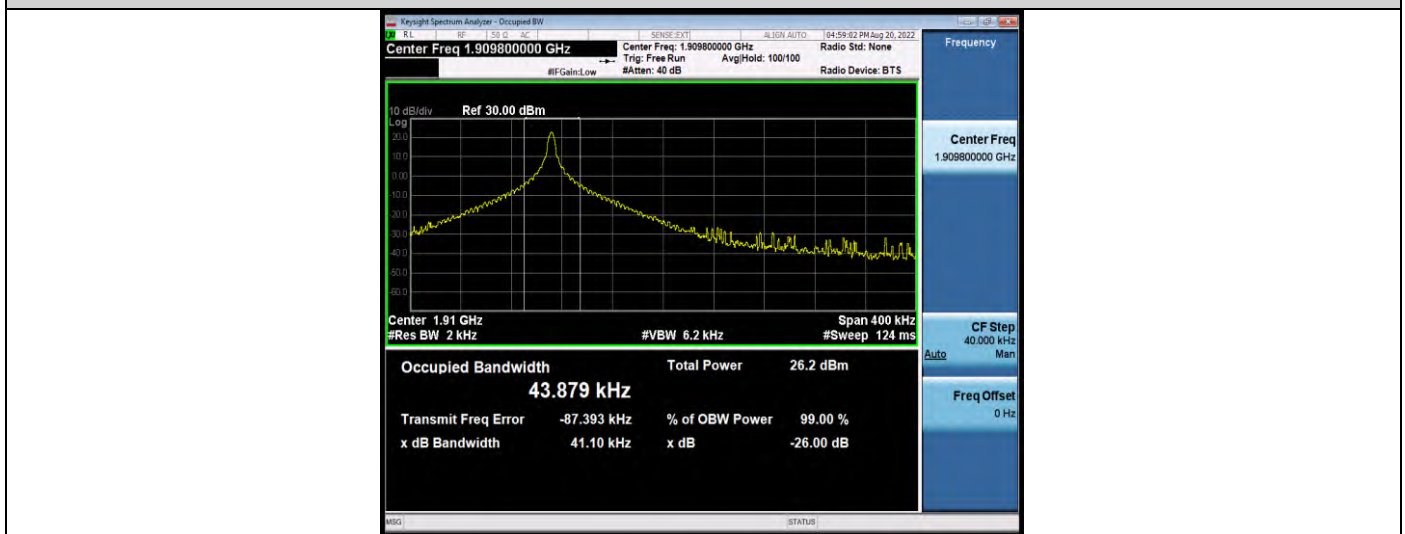

Band2-Stand-Alone-NaN-BPSK-19198-1 @ 0-3.75kHz-0.0411-PASS



Band2-Stand-Alone-NaN-QPSK-18602-1@0-3.75kHz-0.0416-PASS

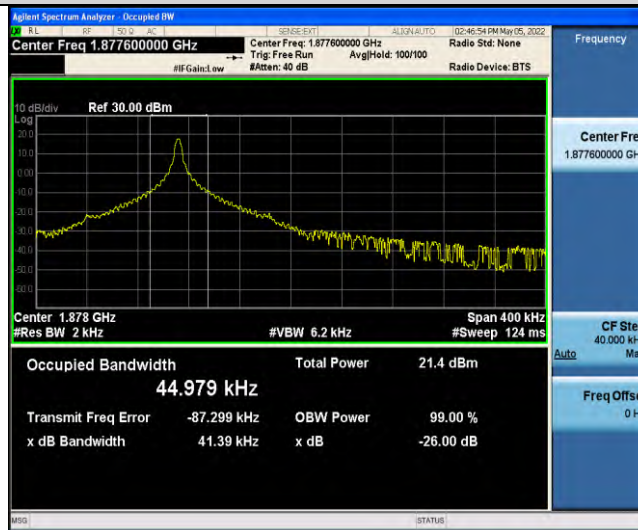

Band2-Stand-Alone-NaN-QPSK-18876-1@0-3.75kHz-0.0414-PASS

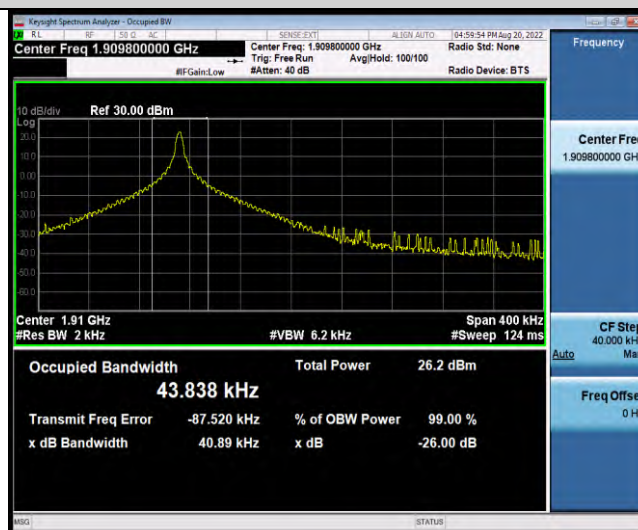

Band2-Stand-Alone-NaN-QPSK-19198-1@0-3.75kHz-0.0409-PASS



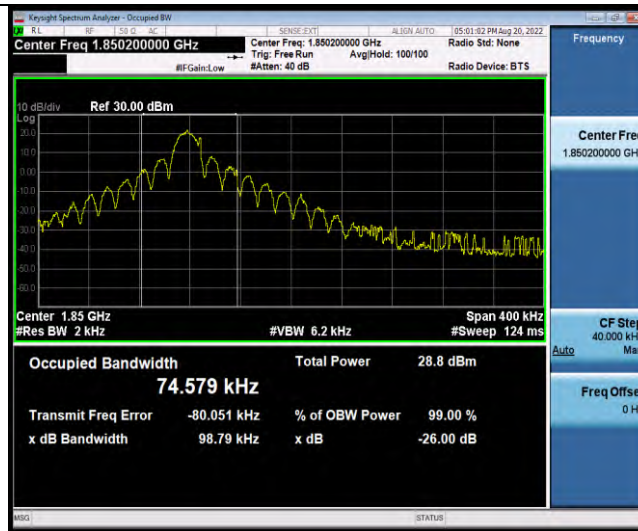

Band2-Stand-Alone-NaN-BPSK-18602-1 @0-15kHz-0.0988-PASS

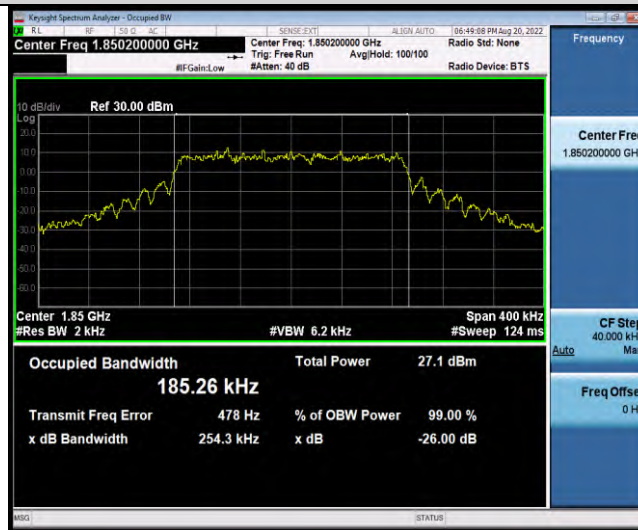

Band2-Stand-Alone-NaN-BPSK-18602-12 @0-15kHz-0.2543-PASS

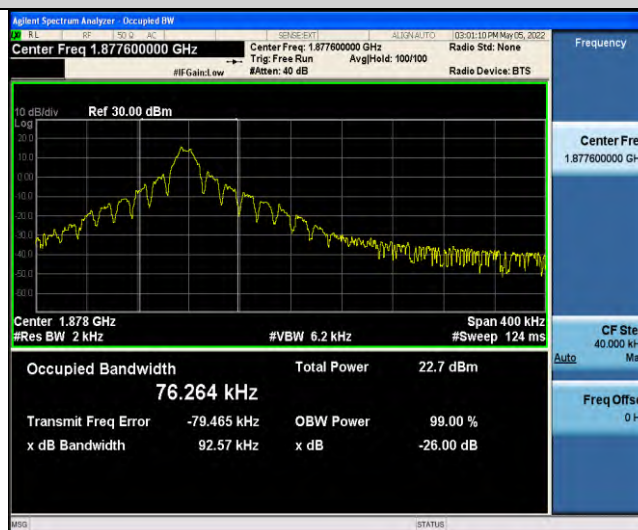

Band2-Stand-Alone-NaN-BPSK-18876-1 @0-15kHz-0.0926-PASS

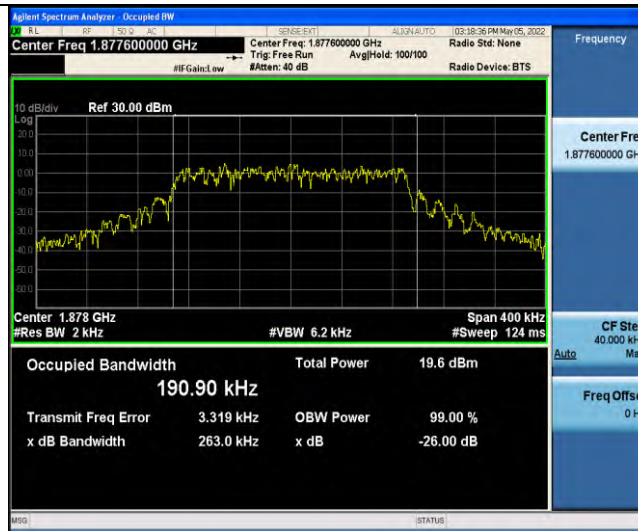

Band2-Stand-Alone-NaN-BPSK-18876-12@0-15kHz-0.2630-PASS

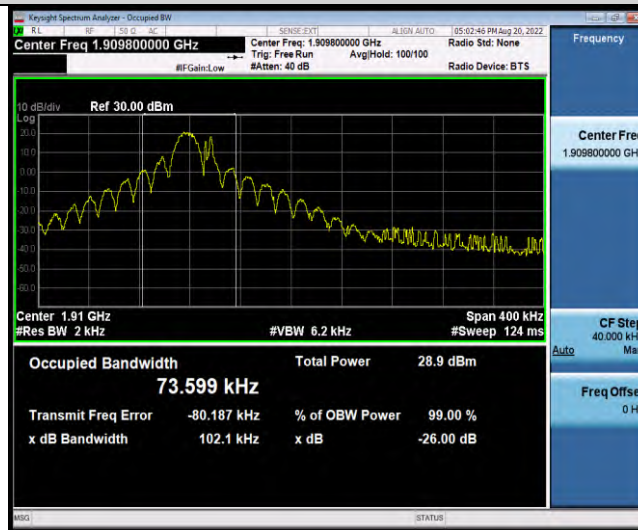

Band2-Stand-Alone-NaN-BPSK-19198-1@0-15kHz-0.1021-PASS

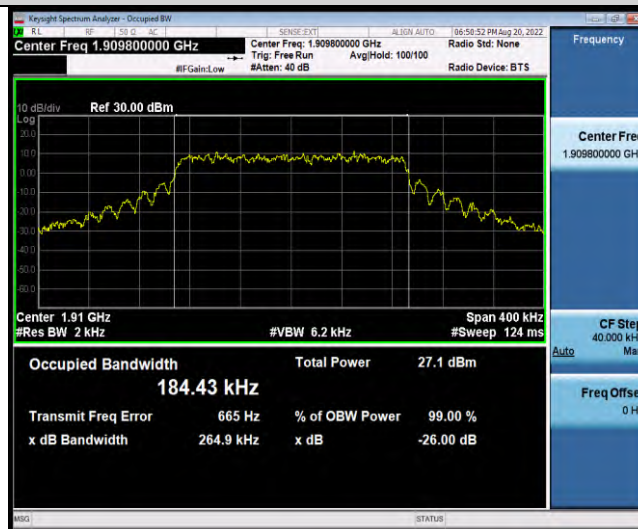

Band2-Stand-Alone-NaN-BPSK-19198-12@0-15kHz-0.2649-PASS

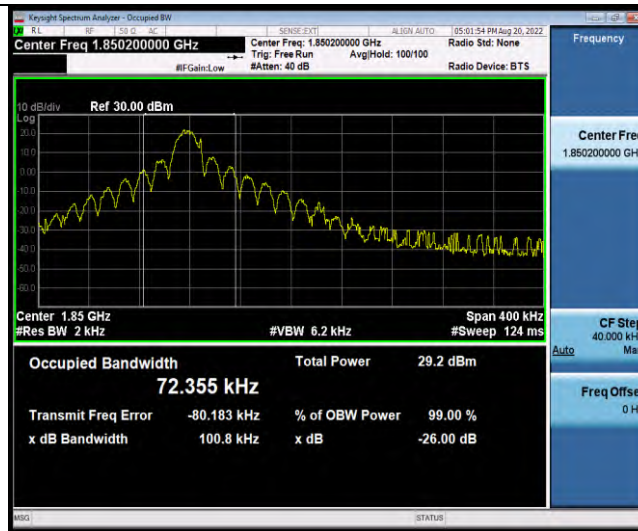

Band2-Stand-Alone-NaN-QPSK-18602-1@0-15kHz-0.1008-PASS

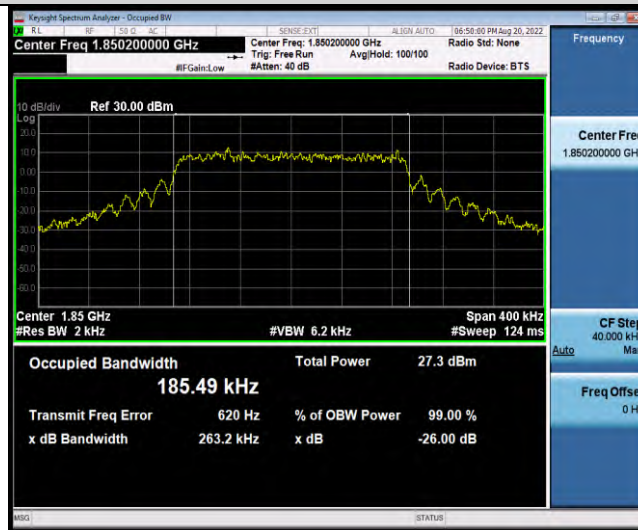

Band2-Stand-Alone-NaN-QPSK-18602-12@0-15kHz-0.2632-PASS

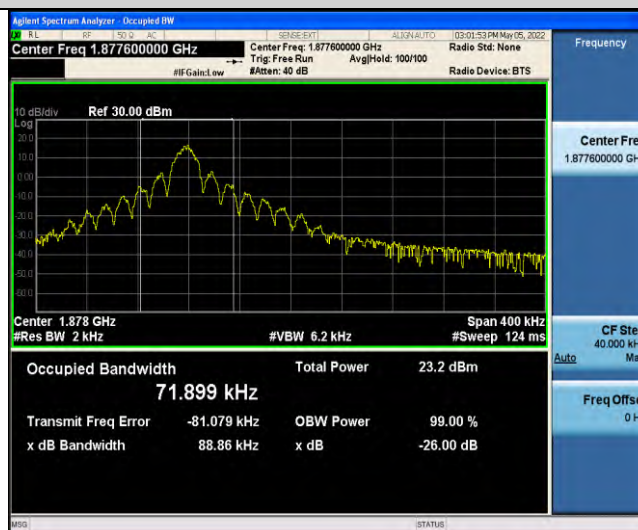

Band2-Stand-Alone-NaN-QPSK-18876-1@0-15kHz-0.0889-PASS