

**InterLab<sup>®</sup>**

Final Report on

Cellular Module

Cinterion<sup>®</sup> PLAS9-X Data Module

FCC ID: QIPPLAS9-X

IC: 7830A-PLAS9X

according to FCC Part 22, Subpart H, Part 24, Subpart E and  
Part 27, Subpart C

**Report Reference:** MDE\_GEMALTO\_1711\_FCCa\_rev1

**Date:** November 21, 2017

**Test Laboratory:**

7layers GmbH  
Borsigstraße 11  
40880 Ratingen  
Germany



Deutsche  
Akkreditierungsstelle  
D-PL-12140-01-00

**Note:**

The following test results relate only to the devices specified in this document. This report shall not be reproduced in parts without the written approval of the test laboratory.

**7layers GmbH**  
Borsigstraße 11  
40880 Ratingen, Germany  
T +49 (0) 2102 749 0  
F +49 (0) 2102 749 350  
[www.7layers.com](http://www.7layers.com)

Geschäftsführer /  
Managing Directors:  
Frank Spiller  
Bernhard Retka  
Alexandre Norré-Oudard

Registergericht registered in:  
Düsseldorf, HRB 75554  
USt-IdNr VAT No.:  
DE203159652  
TAX No. 147/5869/0385  
*A Bureau Veritas Group Company*

## 1 Administrative Data

### 1.1 Project Data

*Project Responsible:* Andreas Tübel  
*Date Of Test Report:* 2017/11/21  
*Date of first test:* 2017/08/01  
*Date of last test:* 2017/08/11

### 1.2 Applicant Data

*Company Name:* Gemalto M2M GmbH  
*Street:* Siemensdamm 50  
*City:* 13629 Berlin  
*Country:* GERMANY  
  
*Contact Person:* Mr. Leandro Wan-Dall  
*Function:* Certification Manager  
*Department:* Approval Department  
*Phone:* +49 3031102 8179  
*Fax:* +49 30311028305  
*E-Mail:* leandro.wan-dall@gemalto.com

### 1.3 Test Laboratory Data

The following list shows all places and laboratories involved for test result generation:

#### 7 layers DE

---

*Company Name :* 7layers GmbH  
*Street :* Borsigstrasse 11  
*City :* 40880 Ratingen  
*Country :* Germany  
*Contact Person :* Mr. Michael Albert  
*Phone :* +49 2102 749 201  
*Fax :* +49 2102 749 444  
*E Mail :* Michael.Albert@7Layers.com

#### Laboratory Details

Lab ID	Identification	Responsible	Accreditation Info
Lab 1	Radiated Emissions	Mr. Marco Kullik Mr. Jens Dörwald	DAKKS-Registration no. D-PL-12140-01-00 ISEDC OATS registration number 3699A-1 FCC accreditation registration number 929146
Lab 2	Radio Lab	Mr. Dobrin Dobrinov Mr. Daniel Gall	DAKKS-Registration no. D-PL-12140-01-00 ISEDC OATS registration number 3699A-1 FCC accreditation registration number 929146

**1.4 Signature of the Testing Responsible**



Daniel Gall  
responsible for tests performed in: Lab 1, Lab 2

**1.5 Signature of the Accreditation Responsible**



Accreditation scope responsible person  
responsible for Lab 1, Lab 2

**2 Test Object Data**

**2.1 General OUT Description**

The following section lists all OUTs (Object's Under Test) involved during testing.

**OUT: Cinterion PLAS9-X**

Type / Model / Family: Cinterion PLAS9-X Data Only Module  
FCC ID: QIPPLAS9-X  
IC: 7830A-PLAS9X

Product Category: Module

**Manufacturer:**  
Company Name: see applicant data

Contact Person: see applicant data

**Parameter List:**

Parameter name	Value
<b>Parameter for Scope FCC_v2:</b>	
DC Power Supply	12 (V)
highest channel	251 (848.8MHz) for GSM850, 810 (1909.8MHz) for GSM1900, 4233 (846.6MHz) for FDD5, 9538 (1907.6MHz) for FDD2, 1513 (1752.6MHz) for FDD4
lowest channel	128 (824.2MHz) for GSM850, 512 (1850.2MHz) for GSM1900, 4132 (826.4MHz) for FDD5, 9262 (1852.4MHz) for FDD2, 1312 (1712.4MHz) for FDD4
mid channel	190 (836.6MHz) for GSM850, 661 (1880.0MHz) for GSM1900, 4183 (836.6MHz) for FDD5, 9400 (1880MHz) for FDD2, 1412 (1732.4MHz)/1450 (1740.0MHz) for FDD4

## 2.2 Detailed Description of OUT Samples

### **Sample : vb01**

<i>OUT Identifier</i>	Cinterion PLAS9-X		
<i>Sample Description</i>	RF Sample for FCC/ISED		
<i>Serial No.</i>	004401082340825		
<i>HW Status</i>	Rev.: 4.4		
<i>SW Status</i>	Rev.: 00.052		
<i>Low Voltage</i>	3.3 V	<i>Low Temp.</i>	-20 °C
<i>High Voltage</i>	4.2 V	<i>High Temp.</i>	55 °C
<i>Nominal Voltage</i>	4.2 V	<i>Normal Temp.</i>	23 °C

### **Sample : vc01**

<i>OUT Identifier</i>	Cinterion PLAS9-X		
<i>Sample Description</i>	Standard Sample FCC/ISED		
<i>Serial No.</i>	004401082341021		
<i>HW Status</i>	Rev.: 4.4		
<i>SW Status</i>	Rev.: 00.052		
<i>Low Voltage</i>	3.3 V	<i>Low Temp.</i>	-20 °C
<i>High Voltage</i>	4.2 V	<i>High Temp.</i>	55 °C
<i>Nominal Voltage</i>	4.2 V	<i>Normal Temp.</i>	23 °C

## 2.3 OUT Features

### Features for OUT: Cinterion PLAS9-X

<i>Designation</i>	<i>Description</i>	<i>Allowed Values</i>	<i>Supported Value(s)</i>
<b>Features for scope: FCC_v2</b>			
Eant	removable antenna supplied and type tested with the radio equipment, designed as an indispensable part of the equipment		
EDGE850	EUT supports EDGE in the band 824 MHz - 849 MHz		
EDGE1900	EUT supports EDGE in the band 1850 MHz - 1910 MHz		
eFDD2			
eFDD4			
eFDD5			
eFDD12			
eFDD13			
FDD2	EUT supports UMTS FDD2 in the band 1850 MHz - 1910 MHz		
FDD4	EUT supports UMTS FDD4 in the band 1710 MHz - 1755 MHz		
FDD5	EUT supports UMTS FDD5 in the band 824 MHz - 849 MHz		
GSM850	EUT supports GSM850 band 824MHz - 849MHz		
HSDPA-FDD2	EUT supports UMTS FDD2 HSDPA in the band 1850 MHz - 1910 MHz		
HSDPA-FDD4	EUT supports UMTS FDD4 HSDPA in the band 1710 MHz - 1755 MHz		
HSDPA-FDD5	EUT supports UMTS FDD5 HSDPA in the band 824 MHz - 849 MHz		
HSUPA-FDD2	EUT supports UMTS FDD2 HSUPA in the band 1850 MHz - 1910 MHz		
HSUPA-FDD4	EUT supports UMTS FDD4 HSUPA in the band 1710 MHz - 1755 MHz		
HSUPA-FDD5	EUT supports UMTS FDD5 HSUPA in the band 824 MHz - 849 MHz		
PCS1900	EUT supports PCS1900 band 1850MHz - 1910MHz		
TantC	temporary antenna connector, which may be only built-in for testing, designed as an example part of the equipment		

## 2.4 Setups used for Testing

For each setup a relation is given to determine if and which samples and auxiliary equipment is used. The left side list all OUT samples and the right side lists all auxiliary equipment for the given setup.

<i>Setup No.</i>	<i>List of OUT samples</i>		<i>List of auxiliary equipment</i>	
	<i>Sample No.</i>	<i>Sample Description</i>	<i>AE No.</i>	<i>AE Description</i>
<b>S01_VB01 (PLAS9-X FCC/ISED)</b>				
	<i>Sample: vb01</i>	RF Sample for FCC/ISED	AE 01	DSB75 Development Board
			AE 03	Housing Box for Test Setup
			AE 02	Module Adapter Plate ALAS6-DSB75
			AE 04	Panorama Antennas LPB-7-27-05SP
<b>S01_VC01 (PLAS9-X FCC/ISED)</b>				
	<i>Sample: vc01</i>	Standard Sample FCC/ISED	AE 01	DSB75 Development Board
			AE 03	Housing Box for Test Setup
			AE 02	Module Adapter Plate ALAS6-DSB75
			AE 04	Panorama Antennas LPB-7-27-05SP

## 3 Results

### 3.1 General

**Documentation of tested devices:**

Available at the test laboratory.

**Interpretation of the test results:**

The results of the inspection are described on the following pages, where 'Conformity' or 'Passed' means that the certification criteria were verified and that the tested device is conform to the applied standard.

In cases where 'Declaration' is printed, the required documents are available in the manufacturers product documentation.

In cases where 'not applicable' is printed, the test case requirements are not relevant to the specific equipment implementation.

**Note:**

1. This is a partial report and contains the abbreviated information content pertaining to services rendered. Supporting documentation not included herein is maintained and available at the laboratory. Scope of testing reported at this report, is full eFDD13 as well as eFDD2, eFDD5 and eFDD12 was spot checked.

2. All tests are performed under environmental conditions within the requirements of the specifications. Environmental conditions are available at the laboratory.

3. This report replace report MDE\_GEMALTO\_1711\_FCCa Changes done: added Annex (Additional Information for Report) page 52 to 88.

### 3.2 List of the Applicable Body

(Body for Scope: FCC\_v2)

<i>Designation</i>	<i>Description</i>
FCC47CFRChIPART27MISCELLANEOUS	Part 27, Subpart C - Technical Standards
WIRELESS COMMUNICATIONS SERVICES	

### 3.3 List of Test Specification

*Test Specification:* **FCC part 2 and 22**  
*Version:* 10-1-15 Edition  
*Title:* PART 2 - GENERAL RULES AND REGULATIONS  
 PART 22 - PUBLIC MOBILE SERVICES

<i>Applicable Errata</i>	<i>Activate Date</i>	<i>Comment</i>
ANSI C63.4-2003	04/1/30	

*Test Specification:* **FCC part 2 and 24**  
*Date / Version:* 2015/10/01 Version: 10-1-15 Edition  
*Title:* PART 2 - GENERAL RULES AND REGULATIONS  
 PART 24 - PERSONAL COMMUNICATIONS SERVICES

<i>Applicable Errata</i>	<i>Activate Date</i>	<i>Comment</i>
ANSI C63.4-2003	04/1/30	

*Test Specification:* **FCC part 2 and 27**  
*Version:* 10-1-13 Edition  
*Title:* PART 2 - GENERAL RULES AND REGULATIONS  
 PART 27 - MISCELLANEOUS WIRELESS COMMUNICATIONS SERVICES

<i>Applicable Errata</i>	<i>Activate Date</i>	<i>Comment</i>
ANSI C63.4-2003	04/1/30	

### 3.4 Summary

<i>Test Case Identifier / Name</i> <i>Test (condition)</i>	<i>Cat</i>	<i>Result</i>	<i>Date of Test</i>	<i>Lab</i> <i>Ref.</i>	<i>Setup</i>
<b>Test Specification: FCC part 2 and 22</b>					
<b>22.1 RF Power Output §2.1046, §22.913</b>					
22.1; _RF Power Output Summary §2.1046, §22.913	-	Passed	2017/08/09	Lab 2	S01_VC01
<b>22.4 Field strength of spurious radiation §2.1053, §22.917</b>					
22.4; Field strength of spurious radiation Summary §2.1053, §22.917	-	Passed	2017/08/01	Lab 1	S01_VB01
<b>Test Specification: FCC part 2 and 24</b>					
<b>24.1 RF Power Output §2.1046, §24.232</b>					
24.1; RF Power Output Summary §2.1046, §24.232	-	Passed	2017/08/09	Lab 2	S01_VC01
<b>24.4 Field strength of spurious radiation §2.1053, §24.238</b>					
24.4; Field strength of spurious radiation Summary §2.1053, §24.238	-	Passed	2017/08/01	Lab 1	S01_VB01
					regarding the limits of RSS 130 Section 4.6.2 the device is compliant against the limits
<b>Test Specification: FCC part 2 and 27</b>					
<b>27.1 RF Power Output §2.1046, §27.250</b>					
27.1; RF Power Output Summary §2.1046, §27.250	-	Passed	2017/08/09	Lab 2	S01_VC01
<b>27.2 Frequency stability §2.1055, §27.54</b>					
27.2; Frequency stability Summary §2.1055, §27.54	-	Passed	2017/08/11	Lab 2	S01_VC01
<b>27.3 Spurious emissions at antenna terminals §2.1051, §27.53</b>					
27.3; Spurious emissions at antenna terminals Summary §2.1051, §27.53	-	Passed	2017/08/09	Lab 2	S01_VC01
					regarding the limits of RSS 130 Section 4.6.2 the device is compliant against the limits
<b>27.4 Field strength of spurious radiation §2.1053, §27.53</b>					
27.4; Field strength of spurious radiation Summary §2.1053, §27.53	-	Passed	2017/08/01	Lab 1	S01_VB01
27.4; Frequency Band = eFDD13, Mode = QPSK 5MHz, Channel = 23205, Frequency = 779.5MHz, Method = radiated	-	Passed	2017/08/01	Lab 1	S01_VB01
27.4; Frequency Band = eFDD13, Mode = QPSK 5MHz, Channel = 23230, Frequency = 782MHz, Method = radiated	-	Passed	2017/08/01	Lab 1	S01_VB01
27.4; Frequency Band = eFDD13, Mode = QPSK 5MHz, Channel = 23255, Frequency = 784.5MHz, Method = radiated	-	Passed	2017/08/01	Lab 1	S01_VB01
<b>27.5 Emission and Occupied Bandwidth §2.1049</b>					
27.5; Emission and Occupied Bandwidth Summary §2.1049	-	Passed	2017/08/09	Lab 2	S01_VC01
<b>27.6 Band edge compliance §2.1053, §27.53</b>					
27.6; Band edge compliance summary §2.1053, §27.53	-	Passed	2017/08/09	Lab 2	S01_VC01
<b>27.7 Peak-to-Average ratio §2.1046, §27.50</b>					
27.7; Peak-to-Average Ratio Summary §2.1046, §27.50	-	Passed	2017/08/09	Lab 2	S01_VC01



### **3.5 Detailed Results**

#### **3.5.1 22.1 RF Power Output §2.1046, §22.913**

##### **Test: 22.1; \_RF Power Output Summary §2.1046, §22.913**

<i>Result:</i>	Passed
<i>Setup No.:</i>	S01_VC01
<i>Date of Test:</i>	2017/08/09 11:39
<i>Body:</i>	NO BODY
<i>Test Specification:</i>	FCC part 2 and 22

**Detailed Results:**

Radio Technology	Channel	Res-source Blocks	Band-width (MHz)	OLD RMS Conducted Power (dBm)	NEW RMS Conducted Power (dBm)	DEVIATION Conducted Power (dBm)
eFDD 5 QPSK	low	1	1.4	22.4	22.33	0.07
eFDD 5 QPSK	low	3	1.4	22.27	21.95	0.32
eFDD 5 QPSK	low	6	1.4	21.24	21.08	0.16
eFDD 5 QPSK	mid	1	1.4	22.2	22.39	0.19
eFDD 5 QPSK	mid	3	1.4	22.02	22.06	0.04
eFDD 5 QPSK	mid	6	1.4	20.99	20.94	0.05
eFDD 5 QPSK	high	1	1.4	22.21	22.53	0.32
eFDD 5 QPSK	high	3	1.4	22.22	22.22	0
eFDD 5 QPSK	high	6	1.4	21.05	21.07	0.02
eFDD 5 16QAM	low	1	1.4	21.39	21.52	0.13
eFDD 5 16QAM	low	6	1.4	20.09	19.98	0.11
eFDD 5 16QAM	mid	1	1.4	21.21	21.5	0.29
eFDD 5 16QAM	mid	6	1.4	19.88	19.96	0.08
eFDD 5 16QAM	high	1	1.4	21.47	21.76	0.29
eFDD 5 16QAM	high	6	1.4	20.21	20.03	0.18
eFDD 5 QPSK	low	1	3	22.79	23.02	0.23
eFDD 5 QPSK	low	15	3	21.47	21.44	0.03
eFDD 5 QPSK	mid	1	3	22.51	22.93	0.42
eFDD 5 QPSK	mid	15	3	21.34	21.41	0.07
eFDD 5 QPSK	high	1	3	22.75	23.11	0.36
eFDD 5 QPSK	high	15	3	21.39	21.47	0.08
eFDD 5 16QAM	low	1	3	21.72	22.18	0.46
eFDD 5 16QAM	low	15	3	20.51	20.46	0.05
eFDD 5 16QAM	mid	1	3	21.64	21.84	0.2
eFDD 5 16QAM	mid	15	3	20.3	20.4	0.1
eFDD 5 16QAM	high	1	3	21.71	22.19	0.48
eFDD 5 16QAM	high	15	3	20.45	20.43	0.02

Radio Technology	Channel	Resource Blocks	Bandwidth (MHz)	OLD RMS Conducted Power (dBm)	NEW RMS Conducted Power (dBm)	DEVIATION Conducted Power (dBm)
eFDD 5 QPSK	low	1	5	22.79	23.05	0.26
eFDD 5 QPSK	low	12	5	21.59	21.49	0.1
eFDD 5 QPSK	low	25	5	21.48	21.37	0.11
eFDD 5 QPSK	mid	1	5	22.74	23.23	0.49
eFDD 5 QPSK	mid	12	5	21.3	21.31	0.01
eFDD 5 QPSK	mid	25	5	21.28	21.43	0.15
eFDD 5 QPSK	high	1	5	22.71	23.08	0.37
eFDD 5 QPSK	high	12	5	21.3	21.48	0.18
eFDD 5 QPSK	high	25	5	21.36	21.52	0.16
eFDD 5 16QAM	low	1	5	21.82	22.05	0.23
eFDD 5 16QAM	low	25	5	20.43	20.35	0.08
eFDD 5 16QAM	mid	1	5	21.6	21.99	0.39
eFDD 5 16QAM	mid	25	5	20.26	20.34	0.08
eFDD 5 16QAM	high	1	5	21.8	22.17	0.37
eFDD 5 16QAM	high	25	5	20.44	20.46	0.02
eFDD 5 QPSK	low	1	10	22.87	23.07	0.2
eFDD 5 QPSK	low	50	10	21.74	21.86	0.12
eFDD 5 QPSK	mid	1	10	22.66	23.05	0.39
eFDD 5 QPSK	mid	50	10	21.52	21.71	0.19
eFDD 5 QPSK	high	1	10	22.92	23.42	0.5
eFDD 5 QPSK	high	50	10	21.77	22.04	0.27
eFDD 5 16QAM	low	1	10	22.05	22.29	0.24
eFDD 5 16QAM	low	50	10	20.62	20.79	0.17
eFDD 5 16QAM	mid	1	10	21.69	22.12	0.43
eFDD 5 16QAM	mid	50	10	20.47	20.7	0.23
eFDD 5 16QAM	high	1	10	21.83	22.38	0.55
eFDD 5 16QAM	high	50	10	20.71	21	0.29

Comparison of the conducted output power. NEW means that LTE band eFDD13 is software-enabled, OLD means LTE band eFDD13 was not enabled.

### **3.5.2 22.4 Field strength of spurious radiation §2.1053, §22.917**

#### **Test: 22.4; Field strength of spurious radiation Summary §2.1053, §22.917**

<i>Result:</i>	Passed
<i>Setup No.:</i>	S01_VB01
<i>Date of Test:</i>	2017/08/01 15:19
<i>Body:</i>	NO BODY
<i>Test Specification:</i>	FCC part 2 and 22

**Detailed Results:**

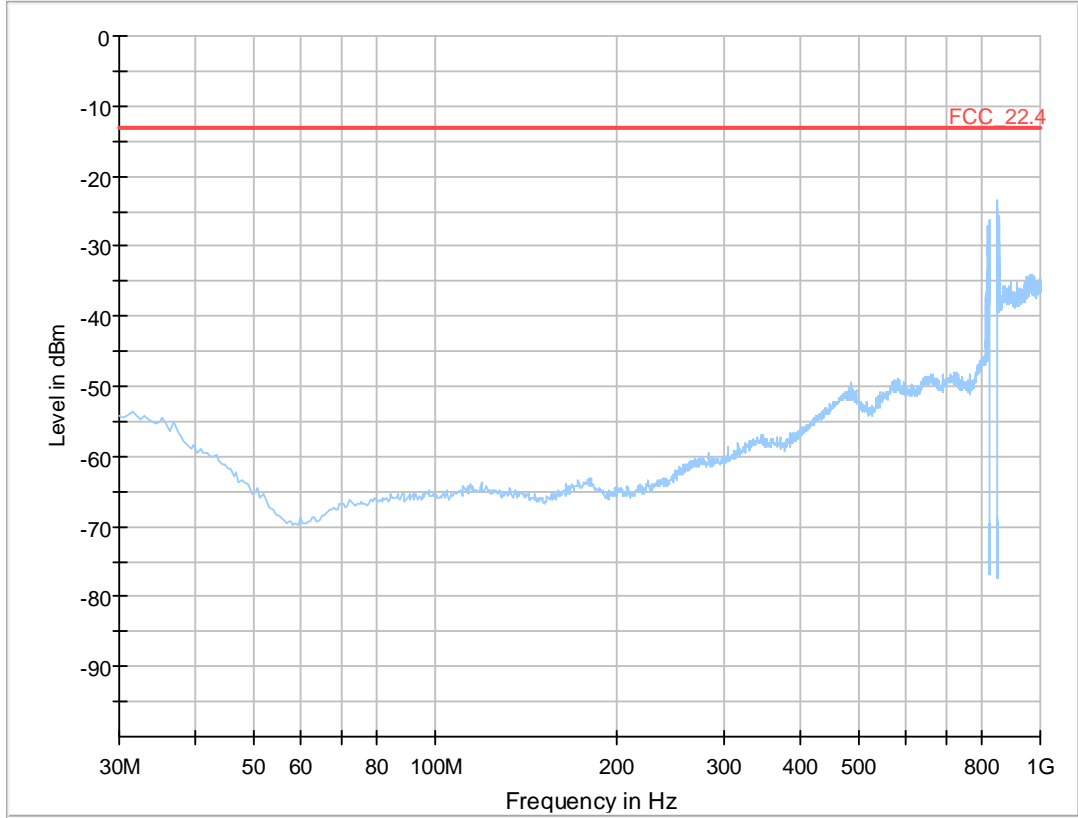

**Critical\_Freqs**

Frequency (MHz)	MaxPeak (dBm)	Limit (dBm)	Margin (dB)	Meas. Time (ms)	Bandwidth (kHz)	Height (cm)	Pol	Azimuth (deg)	Elevation (deg)	Corr. (dB)
---	---	---	---	---	---	---		---	---	---

**Final\_Result**

Frequency (MHz)	MaxPeak (dBm)	Limit (dBm)	Margin (dB)	Meas. Time (ms)	Bandwidth (kHz)	Height (cm)	Pol	Azimuth (deg)	Elevation (deg)	Corr. (dB)
---	---	---	---	---	---	---		---	---	---

eFDD5 QPSK 5MHz RB1 Channel=mid

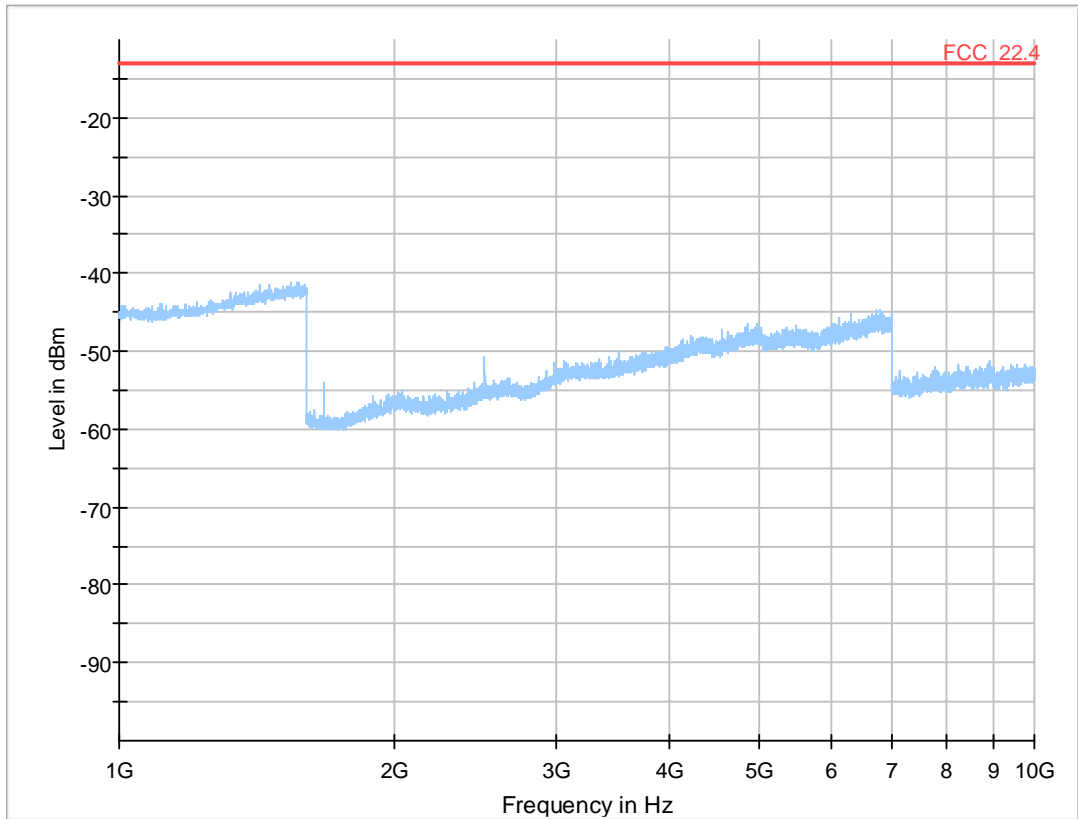

### Critical\_Freqs

Frequency (MHz)	MaxPeak (dBm)	Limit (dBm)	Margin (dB)	Meas. Time (ms)	Bandwidth (kHz)	Height (cm)	Pol	Azimuth (deg)	Elevation (deg)	Corr. (dB)
---	---	---	---	---	---	---		---	---	---

### Final\_Result

Frequency (MHz)	MaxPeak (dBm)	Limit (dBm)	Margin (dB)	Meas. Time (ms)	Bandwidth (kHz)	Height (cm)	Pol	Azimuth (deg)	Elevation (deg)	Corr. (dB)
---	---	---	---	---	---	---		---	---	---

eFDD5 QPSK 5MHz RB1 Channel=mid

### **3.5.3 24.1 RF Power Output §2.1046, §24.232**

#### **Test: 24.1; RF Power Output Summary §2.1046, §24.232**

<i>Result:</i>	Passed
<i>Setup No.:</i>	S01_VC01
<i>Date of Test:</i>	2017/08/09 11:45
<i>Body:</i>	NO BODY
<i>Test Specification:</i>	FCC part 2 and 24

**Detailed Results:**

Radio Technology	Channel	Res- source Blocks	Band- width (MHz)	OLD RMS Conducted Power (dBm)	NEW RMS Conducted Power (dBm)	DEVIATION RMS Conducted Power (dBm)
eFDD 2 QPSK	low	1	1.4	21.91	21.68	0.23
eFDD 2 QPSK	low	3	1.4	21.46	21.11	0.35
eFDD 2 QPSK	low	6	1.4	20.37	20.12	0.25
eFDD 2 QPSK	mid	1	1.4	21.47	21.9	0.43
eFDD 2 QPSK	mid	3	1.4	21.2	21.38	0.18
eFDD 2 QPSK	mid	6	1.4	20.4	20.37	0.03
eFDD 2 QPSK	high	1	1.4	22	21.75	0.25
eFDD 2 QPSK	high	3	1.4	21.55	21.36	0.19
eFDD 2 QPSK	high	6	1.4	20.52	20.28	0.24
eFDD 2 16QAM	low	1	1.4	20.8	20.72	0.08
eFDD 2 16QAM	low	6	1.4	19.44	19.08	0.36
eFDD 2 16QAM	mid	1	1.4	20.7	20.96	0.26
eFDD 2 16QAM	mid	6	1.4	19.72	19.32	0.4
eFDD 2 16QAM	high	1	1.4	21.38	20.74	0.64
eFDD 2 16QAM	high	6	1.4	19.51	19.28	0.23
eFDD 2 QPSK	low	1	3	22.14	22.03	0.11
eFDD 2 QPSK	low	15	3	20.84	20.51	0.33
eFDD 2 QPSK	mid	1	3	22.33	22.28	0.05
eFDD 2 QPSK	mid	15	3	20.99	20.83	0.16
eFDD 2 QPSK	high	1	3	22.48	22.28	0.2
eFDD 2 QPSK	high	15	3	20.99	20.66	0.33
eFDD 2 16QAM	low	1	3	21.4	21.15	0.25
eFDD 2 16QAM	low	15	3	19.9	19.57	0.33
eFDD 2 16QAM	mid	1	3	21.55	21.26	0.29
eFDD 2 16QAM	mid	15	3	19.99	19.78	0.21
eFDD 2 16QAM	high	1	3	21.41	21.24	0.17
eFDD 2 16QAM	high	15	3	20.04	19.67	0.37
eFDD 2 QPSK	low	1	5	22.47	22.32	0.15
eFDD 2 QPSK	low	12	5	20.95	20.5	0.45
eFDD 2 QPSK	low	25	5	20.83	20.51	0.32
eFDD 2 QPSK	mid	1	5	22.64	22.66	0.02
eFDD 2 QPSK	mid	12	5	21.13	20.85	0.28
eFDD 2 QPSK	mid	25	5	21.07	20.77	0.3
eFDD 2 QPSK	high	1	5	22.89	22.4	0.49
eFDD 2 QPSK	high	12	5	21.08	21.16	0.08
eFDD 2 QPSK	high	25	5	21	21.25	0.25
eFDD 2 16QAM	low	1	5	21.58	21.23	0.35
eFDD 2 16QAM	low	25	5	19.89	19.5	0.39
eFDD 2 16QAM	mid	1	5	21.77	21.5	0.27
eFDD 2 16QAM	mid	25	5	20.04	19.81	0.23
eFDD 2 16QAM	high	1	5	21.72	21.21	0.51



Radio Technology	Channel	Res- source Blocks	Band- width (MHz)	OLD RMS Conducted Power (dBm)	NEW RMS Conducted Power (dBm)	DEVIATION RMS Conducted Power (dBm)
eFDD 2 16QAM	high	25	5	19.99	20.22	0.23
eFDD 2 QPSK	low	1	10	22.57	22.22	0.35
eFDD 2 QPSK	low	50	10	21.19	20.91	0.28
eFDD 2 QPSK	mid	1	10	22.56	22.4	0.16
eFDD 2 QPSK	mid	50	10	21.35	21.2	0.15
eFDD 2 QPSK	high	1	10	22.64	22.76	0.12
eFDD 2 QPSK	high	50	10	21.28	21.5	0.22
eFDD 2 16QAM	low	1	10	21.66	21.33	0.33
eFDD 2 16QAM	low	50	10	20.17	19.87	0.3
eFDD 2 16QAM	mid	1	10	21.55	21.45	0.1
eFDD 2 16QAM	mid	50	10	20.38	20.23	0.15
eFDD 2 16QAM	high	1	10	21.82	21.7	0.12
eFDD 2 16QAM	high	50	10	20.29	20.48	0.19
eFDD 2 QPSK	low	1	15	22.74	22.2	0.54
eFDD 2 QPSK	low	36	15	21.94	21.47	0.47
eFDD 2 QPSK	low	75	15	21.86	21.34	0.52
eFDD 2 QPSK	mid	1	15	22.71	22.38	0.33
eFDD 2 QPSK	mid	36	15	21.86	21.54	0.32
eFDD 2 QPSK	mid	75	15	21.68	21.28	0.4
eFDD 2 QPSK	high	1	15	22.59	22.69	0.1
eFDD 2 QPSK	high	36	15	21.83	21.71	0.12
eFDD 2 QPSK	high	75	15	21.76	21.6	0.16
eFDD 2 16QAM	low	1	15	22.07	21.59	0.48
eFDD 2 16QAM	low	75	15	20.82	20.35	0.47
eFDD 2 16QAM	mid	1	15	21.53	21.34	0.19
eFDD 2 16QAM	mid	75	15	20.66	20.35	0.31
eFDD 2 16QAM	high	1	15	21.92	21.68	0.24
eFDD 2 16QAM	high	75	15	20.72	20.61	0.11
eFDD 2 QPSK	low	1	20	22.63	22.37	0.26
eFDD 2 QPSK	low	100	20	21.94	21.52	0.42
eFDD 2 QPSK	mid	1	20	22.65	22.44	0.21
eFDD 2 QPSK	mid	100	20	21.76	21.51	0.25
eFDD 2 QPSK	high	1	20	22.59	22.71	0.12
eFDD 2 QPSK	high	100	20	21.9	21.97	0.07
eFDD 2 16QAM	low	1	20	21.73	21.54	0.19
eFDD 2 16QAM	low	100	20	20.97	20.54	0.43
eFDD 2 16QAM	mid	1	20	21.61	21.53	0.08
eFDD 2 16QAM	mid	100	20	20.76	20.52	0.24
eFDD 2 16QAM	high	1	20	21.59	21.65	0.06
eFDD 2 16QAM	high	100	20	20.94	21	0.06

Comparison of the conducted output power. NEW means that LTE band eFDD13 is software-enabled, OLD means LTE band eFDD13 was not enabled.

### **3.5.4 24.4 Field strength of spurious radiation §2.1053, §24.238**

#### **Test: 24.4; Field strength of spurious radiation Summary §2.1053, §24.238**

<i>Result:</i>	Passed regarding the limits of RSS 130 Section 4.6.2 the device is compliant against the limits
<i>Setup No.:</i>	S01_VB01
<i>Date of Test:</i>	2017/08/01 15:21
<i>Body:</i>	NO BODY
<i>Test Specification:</i>	FCC part 2 and 24

**Detailed Results:**

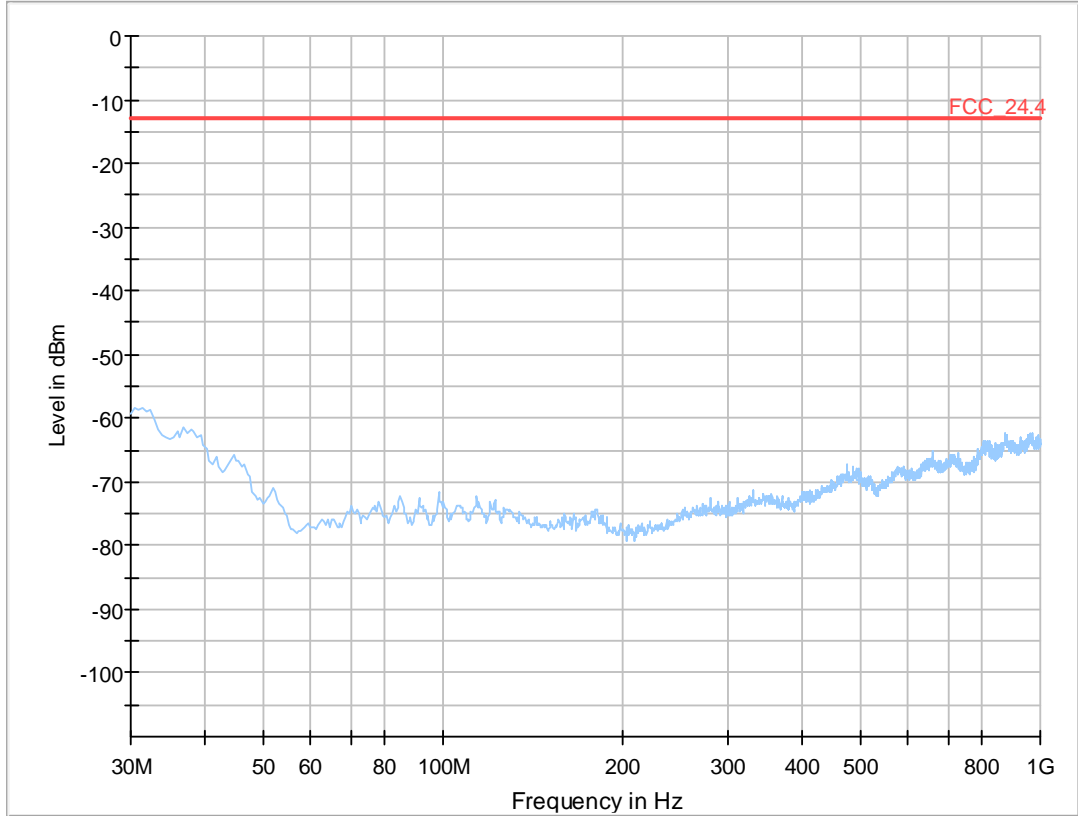

**Critical\_Freqs**

Frequency (MHz)	MaxPeak (dBm)	Limit (dBm)	Margin (dB)	Meas. Time (ms)	Bandwidth (kHz)	Height (cm)	Pol	Azimuth (deg)	Elevation (deg)	Corr. (dB)
---	---	---	---	---	---	---		---	---	---

**Final\_Result**

Frequency (MHz)	MaxPeak (dBm)	Limit (dBm)	Margin (dB)	Meas. Time (ms)	Bandwidth (kHz)	Height (cm)	Pol	Azimuth (deg)	Elevation (deg)	Corr. (dB)
---	---	---	---	---	---	---		---	---	---

eFDD2 QPSK 5MHz RB1 Channel=mid

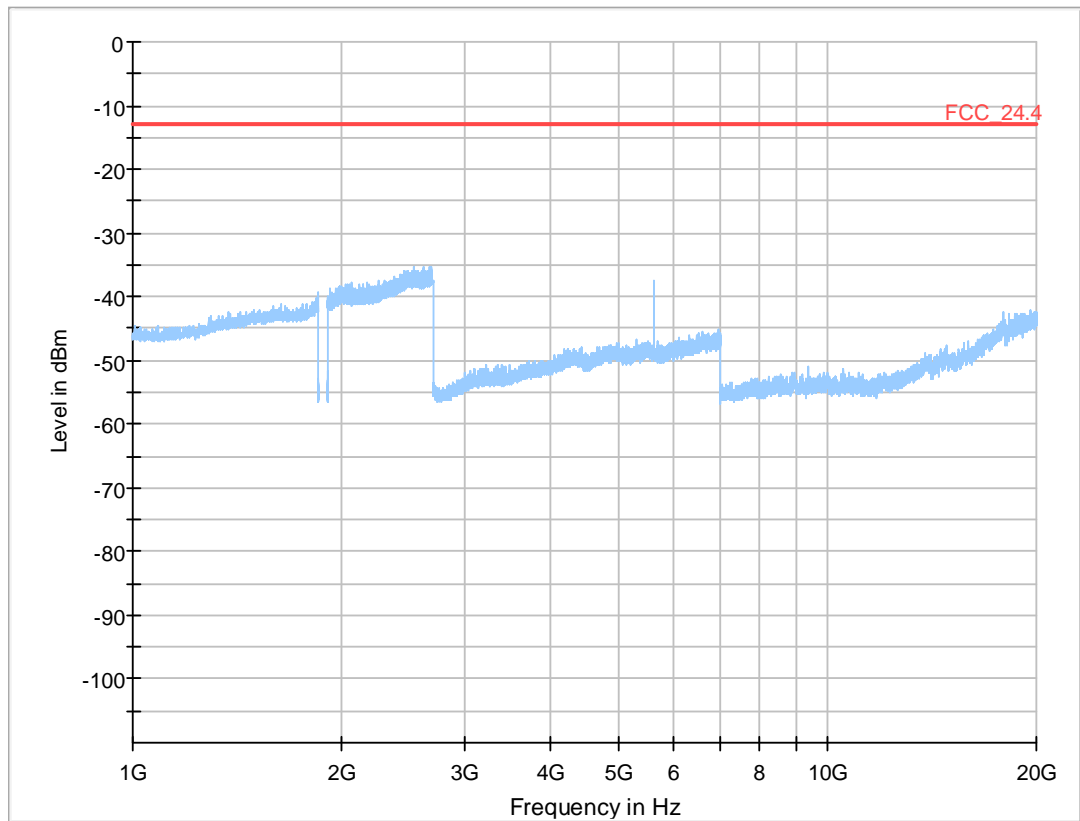

### Critical\_Freqs

Frequency (MHz)	MaxPeak (dBm)	Limit (dBm)	Margin (dB)	Meas. Time (ms)	Bandwidth (kHz)	Height (cm)	Pol	Azimuth (deg)	Elevation (deg)	Corr. (dB)
---	---	---	---	---	---	---		---	---	---

### Final\_Result

Frequency (MHz)	MaxPeak (dBm)	Limit (dBm)	Margin (dB)	Meas. Time (ms)	Bandwidth (kHz)	Height (cm)	Pol	Azimuth (deg)	Elevation (deg)	Corr. (dB)
---	---	---	---	---	---	---		---	---	---

eFDD2 QPSK 5MHz RB1 Channel=mid

### **3.5.5 27.1 RF Power Output §2.1046, §27.250**

#### **Test: 27.1; RF Power Output Summary §2.1046, §27.250**

<i>Result:</i>	Passed
<i>Setup No.:</i>	S01_VC01
<i>Date of Test:</i>	2017/08/09 12:09
<i>Body:</i>	NO BODY
<i>Test Specification:</i>	FCC part 2 and 27

**Detailed Results:**

Radio Technology	Channel	Ressource Blocks	BW [MHz]	RMS Cond. Power [dBm]
eFDD 13 QPSK	low	1	5	21.22
eFDD 13 QPSK	low	12	5	19.58
eFDD 13 QPSK	low	25	5	19.55
eFDD 13 QPSK	mid	1	5	21.24
eFDD 13 QPSK	mid	12	5	19.55
eFDD 13 QPSK	mid	25	5	19.54
eFDD 13 QPSK	high	1	5	21.29
eFDD 13 QPSK	high	12	5	19.43
eFDD 13 QPSK	high	25	5	19.56
eFDD 13 16QAM	low	1	5	20.16
eFDD 13 16QAM	low	25	5	18.54
eFDD 13 16QAM	mid	1	5	20.19
eFDD 13 16QAM	mid	25	5	18.68
eFDD 13 16QAM	high	1	5	20.21
eFDD 13 16QAM	high	25	5	18.81
eFDD 13 QPSK	mid	1	10	21.24
eFDD 13 QPSK	mid	50	10	20.32
eFDD 13 16QAM	mid	1	10	20.47
eFDD 13 16QAM	mid	50	10	19.26

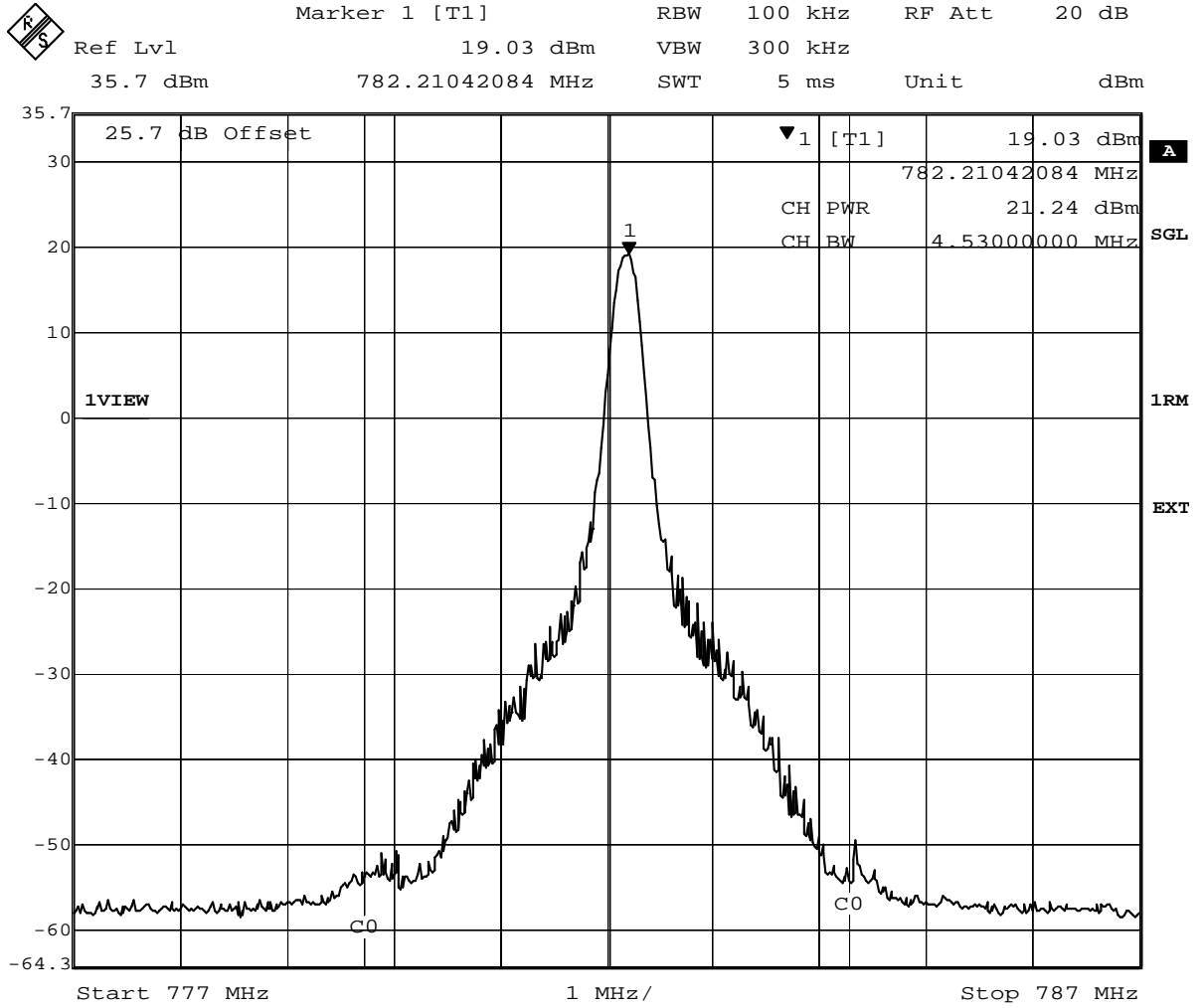

Date: 2.AUG.2017 16:45:30

eFDD13 QPSK 5MHz RB1 Channel=mid

Radio Technology	Channel	Res- source Blocks	Band- width (MHz)	OLD RMS Conducted Power (dBm)	NEW RMS Conducted Power (dBm)	DEVIATION RMS Conducted Power (dBm)
eFDD 12 QPSK	low	1	1.4	22	22.07	0.07
eFDD 12 QPSK	low	3	1.4	21.7	21.69	0.01
eFDD 12 QPSK	low	6	1.4	20.6	20.7	0.1
eFDD 12 QPSK	mid	1	1.4	22.3	22.34	0.04
eFDD 12 QPSK	mid	3	1.4	21.8	21.89	0.09
eFDD 12 QPSK	mid	6	1.4	20.8	20.81	0.01
eFDD 12 QPSK	high	1	1.4	22.2	22.11	0.09
eFDD 12 QPSK	high	3	1.4	21.9	21.83	0.07
eFDD 12 QPSK	high	6	1.4	20.7	20.6	0.1
eFDD 12 16QAM	low	1	1.4	21.3	21.15	0.15
eFDD 12 16QAM	low	6	1.4	20.28	19.81	0.47
eFDD 12 16QAM	mid	1	1.4	21.1	21.17	0.07
eFDD 12 16QAM	mid	6	1.4	20.51	19.88	0.63
eFDD 12 16QAM	high	1	1.4	21.1	21.26	0.16
eFDD 12 16QAM	high	6	1.4	20.44	19.66	0.78
eFDD 12 QPSK	low	1	3	22.5	22.71	0.21
eFDD 12 QPSK	low	15	3	21.1	21.29	0.19
eFDD 12 QPSK	mid	1	3	22.8	22.76	0.04
eFDD 12 QPSK	mid	15	3	21.4	21.33	0.07
eFDD 12 QPSK	high	1	3	22.7	22.66	0.04
eFDD 12 QPSK	high	15	3	21.2	21.16	0.04
eFDD 12 16QAM	low	1	3	22.1	22.41	0.31
eFDD 12 16QAM	low	15	3	20.1	20.39	0.29
eFDD 12 16QAM	mid	1	3	22.4	22.22	0.18
eFDD 12 16QAM	mid	15	3	20.4	20.38	0.02
eFDD 12 16QAM	high	1	3	21.8	21.6	0.2
eFDD 12 16QAM	high	15	3	20.2	20.26	0.06



Radio Technology	Channel	Res- source Blocks	Band- width (MHz)	OLD RMS Conducted Power (dBm)	NEW RMS Conducted Power (dBm)	DEVIATION RMS Conducted Power (dBm)
eFDD 12 QPSK	low	1	5	22.9	23.12	0.22
eFDD 12 QPSK	low	12	5	21.2	21.33	0.13
eFDD 12 QPSK	low	25	5	21.1	21.25	0.15
eFDD 12 QPSK	mid	1	5	22.9	22.92	0.02
eFDD 12 QPSK	mid	12	5	21.4	21.3	0.1
eFDD 12 QPSK	mid	25	5	21.3	21.22	0.08
eFDD 12 QPSK	high	1	5	23	23.01	0.01
eFDD 12 QPSK	high	12	5	21.2	21.27	0.07
eFDD 12 QPSK	high	25	5	21.3	21.24	0.06
eFDD 12 16QAM	low	1	5	22	22.31	0.31
eFDD 12 16QAM	low	25	5	20.85	20.22	0.63
eFDD 12 16QAM	mid	1	5	22.1	22.3	0.2
eFDD 12 16QAM	mid	25	5	20.82	20.26	0.56
eFDD 12 16QAM	high	1	5	22.1	22.07	0.03
eFDD 12 16QAM	high	25	5	20.91	20.36	0.55
eFDD 12 QPSK	low	1	10	22.9	22.98	0.08
eFDD 12 QPSK	low	50	10	21.6	21.55	0.05
eFDD 12 QPSK	mid	1	10	22.9	22.8	0.1
eFDD 12 QPSK	mid	50	10	21.7	21.64	0.06
eFDD 12 QPSK	high	1	10	22.9	22.92	0.02
eFDD 12 QPSK	high	50	10	21.6	21.66	0.06
eFDD 12 16QAM	low	1	10	22.5	22.34	0.16
eFDD 12 16QAM	low	50	10	20.7	20.52	0.18
eFDD 12 16QAM	mid	1	10	20.8	21.56	0.76
eFDD 12 16QAM	mid	50	10	22.1	20.8	1.3
eFDD 12 16QAM	high	1	10	22.1	22.13	0.03
eFDD 12 16QAM	high	50	10	20.6	20.59	0.01

Comparison of the conducted output power. NEW means that LTE band eFDD13 is software-enabled, OLD means LTE band eFDD13 was not enabled.

### **3.5.6 27.2 Frequency stability §2.1055, §27.54**

#### **Test: 27.2; Frequency stability Summary §2.1055, §27.54**

<i>Result:</i>	Passed
<i>Setup No.:</i>	S01_VC01
<i>Date of Test:</i>	2017/08/11 12:13
<i>Body:</i>	NO BODY
<i>Test Specification:</i>	FCC part 2 and 27

**Detailed Results:**

Temp. °C	Duration min	Voltage	Limit Hz	Freq. error Average (Hz)	Freq. error Max. (Hz)	Verdict
-30	0	normal	1955	0	2	passed
-30	5			1	3	passed
-30	10			-2	-4	passed
-20	0	normal	1955	0	5	passed
-20	5			0	3	passed
-20	10			2	4	passed
-10	0	normal	1955	0	1	passed
-10	5			1	-2	passed
-10	10			-2	-2	passed
0	0	normal	1955	-3	3	passed
0	5			-2	4	passed
0	10			0	2	passed
10	0	normal	1955	0	-1	passed
10	5			-1	-3	passed
10	10			0	-4	passed
20	0	low	1955	2	-3	passed
20	5			0	-4	passed
20	10			0	-2	passed
20	0	normal = high <sup>1)</sup>	1955	-1	2	passed
20	5			0	1	passed
20	10			0	2	passed
20	0	high	1955	1	2	passed
20	5			-1	-3	passed
20	10			2	4	passed
30	0	normal	1955	0	-2	passed
30	5			0	-3	passed
30	10			-1	1	passed
40	0	normal	1955	-1	3	passed
40	5			1	3	passed
40	10			1	-2	passed
50	0	normal	1955	-1	-1	passed
50	5			1	-2	passed
50	10			2	-2	passed

LTE eFDD13						
BW (MHz) / Resource	f <sub>L</sub> (MHz)	f <sub>H</sub> (MHz)	Max. Frequency Error (Hz)	Resulting Freq. (MHz)	Limit (MHz)	Result
5 / 25	777.1	-	5	777.11	777	Passed
	-	786.85	5	786.85	787	Passed

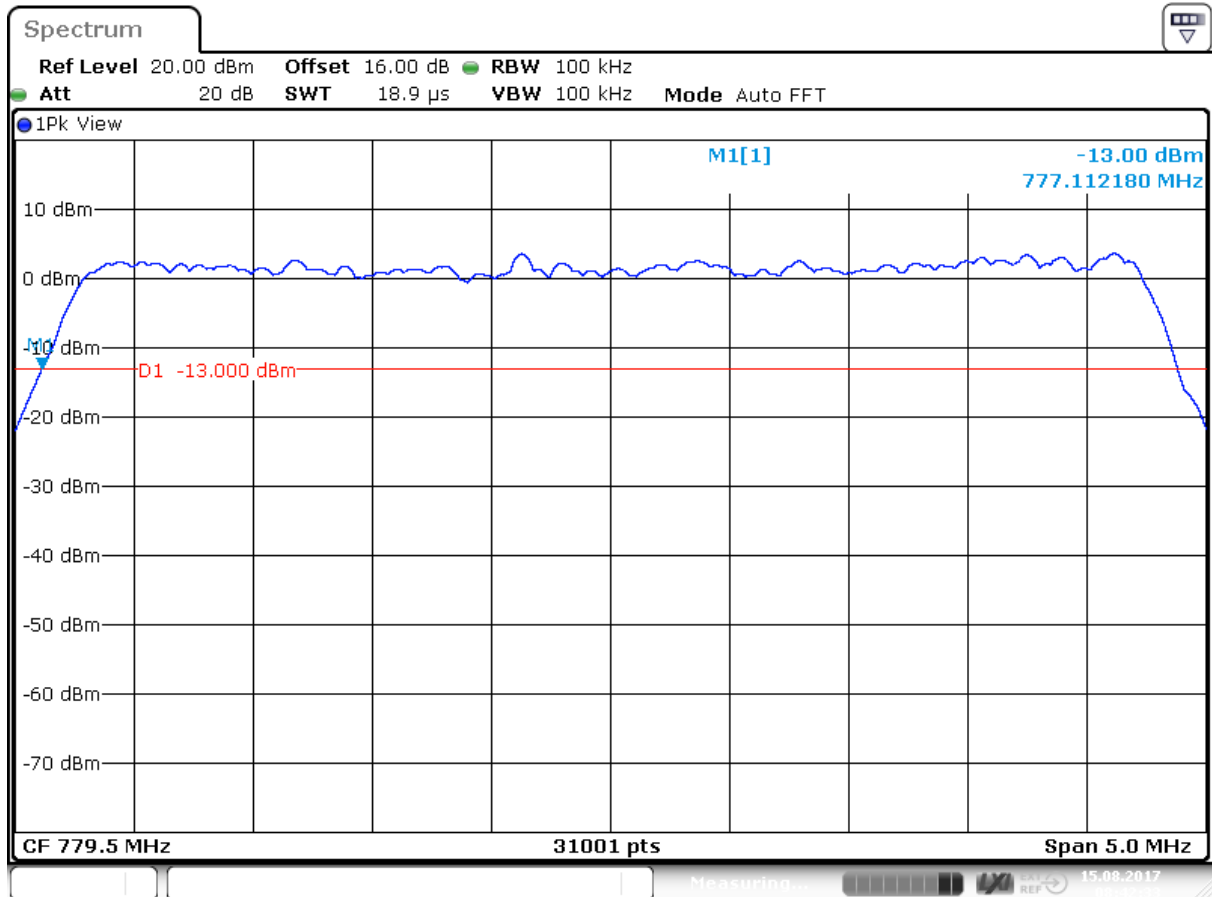

Date: 15 AUG 2017 08:42:33

eFDD13 QPSK 5MHz RB25 Channle=low

### 3.5.7 27.3 Spurious emissions at antenna terminals §2.1051, §27.53

#### Test: 27.3; Spurious emissions at antenna terminals Summary §2.1051, §27.53

Result: Passed  
 regarding the limits of RSS 130 Section 4.6.2 the device is compliant against the limits

Setup No.: S01\_VC01

Date of Test: 2017/08/09 12:19

Body: NO BODY

Test Specification: FCC part 2 and 27

#### Detailed Results:

Radio Technology	Channel	Detector	Trace	Resolution Bandwidth /kHz	Frequency /MHz	Peak Value /dBm	Limit /dBm	Margin to Limit /dB
eFDD 13 QPSK	low	rms	maxhold	-	-	-	-13	>20
eFDD 13 QPSK	mid	rms	maxhold	-	-	-	-13	>20
eFDD 13 QPSK	high	rms	maxhold	-	-	-	-13	>20

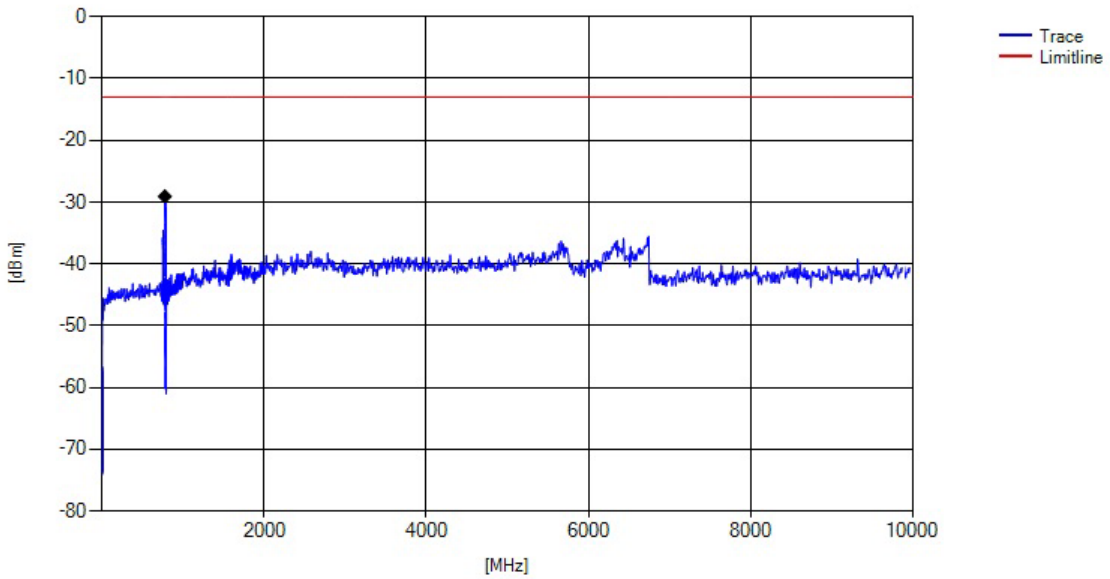

eFDD13 QPSK 5MHz RB1 Channel=high

### **3.5.8 27.4 Field strength of spurious radiation §2.1053, §27.53**

#### **Test: 27.4; Field strength of spurious radiation Summary §2.1053, §27.53**

<i>Result:</i>	Passed
<i>Setup No.:</i>	S01_VB01
<i>Date of Test:</i>	2017/08/01 15:23
<i>Body:</i>	NO BODY
<i>Test Specification:</i>	FCC part 2 and 27

**Detailed Results:**

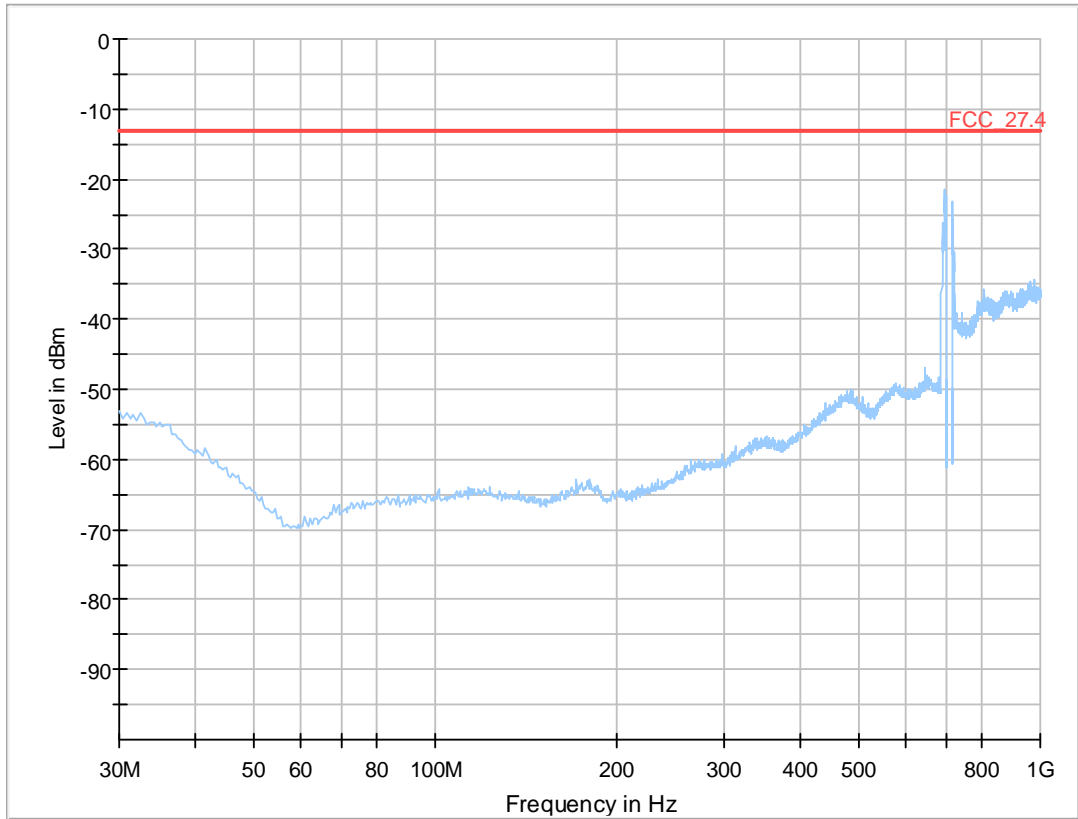

**Critical\_Freqs**

Frequency (MHz)	MaxPeak (dBm)	Limit (dBm)	Margin (dB)	Meas. Time (ms)	Bandwidth (kHz)	Height (cm)	Pol	Azimuth (deg)	Elevation (deg)	Corr. (dB)
---	---	---	---	---	---	---		---	---	---

**Final\_Result**

Frequency (MHz)	MaxPeak (dBm)	Limit (dBm)	Margin (dB)	Meas. Time (ms)	Bandwidth (kHz)	Height (cm)	Pol	Azimuth (deg)	Elevation (deg)	Corr. (dB)
---	---	---	---	---	---	---		---	---	---

eFDD12 QPSK 5MHz RB1 Channel=mid

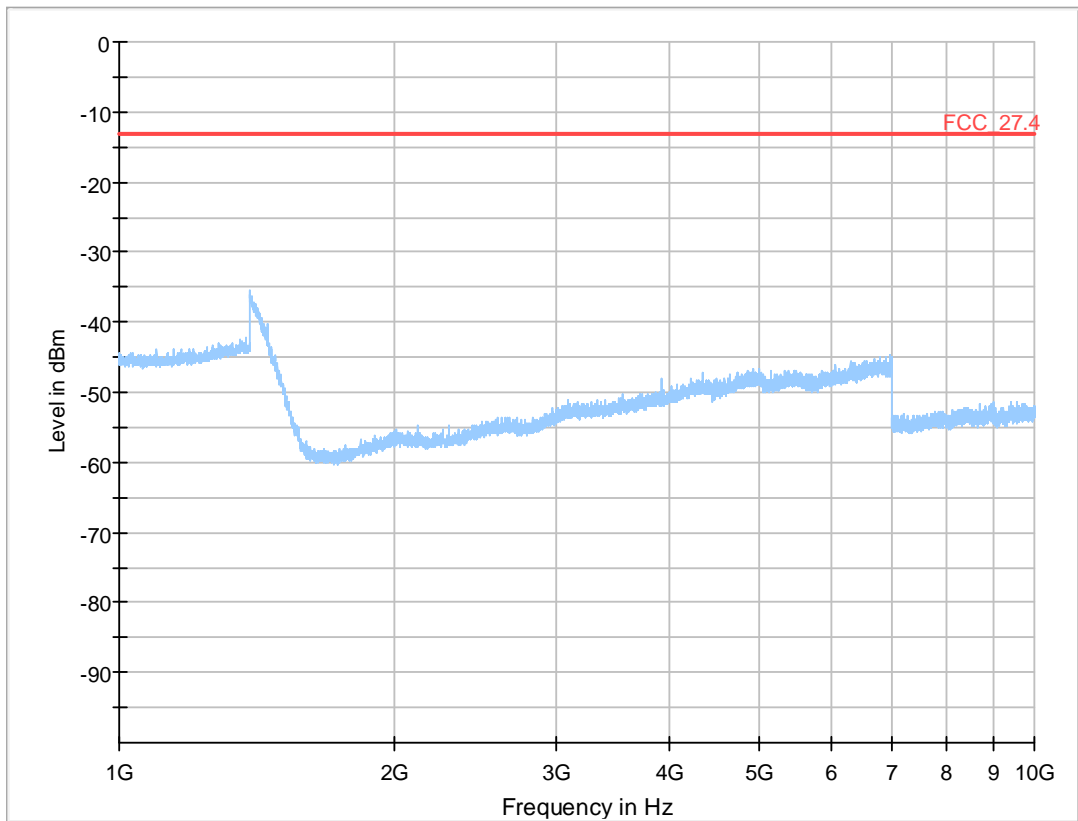

### Critical Freqs

Frequency (MHz)	MaxPeak (dBm)	Limit (dBm)	Margin (dB)	Meas. Time (ms)	Bandwidth (kHz)	Height (cm)	Pol	Azimuth (deg)	Elevation (deg)	Corr. (dB)
---	---	---	---	---	---	---		---	---	---

### Final Result

Frequency (MHz)	MaxPeak (dBm)	Limit (dBm)	Margin (dB)	Meas. Time (ms)	Bandwidth (kHz)	Height (cm)	Pol	Azimuth (deg)	Elevation (deg)	Corr. (dB)
---	---	---	---	---	---	---		---	---	---

eFDD12 QPSK 5MHz RB1 Channel=mid

**Test: 27.4; Frequency Band = eFDD13, Mode = QPSK 5MHz, Channel = 23205, Frequency = 779.5MHz, Method = radiated**

Result: Passed

Setup No.: S01\_VB01

Date of Test: 2017/08/01 15:14

Body: FCC47CFRChIPART27MISCELLANEOUS WIRELESS COMMUNICATIONS SERV

Test Specification: FCC part 2 and 27



**Detailed Results:**

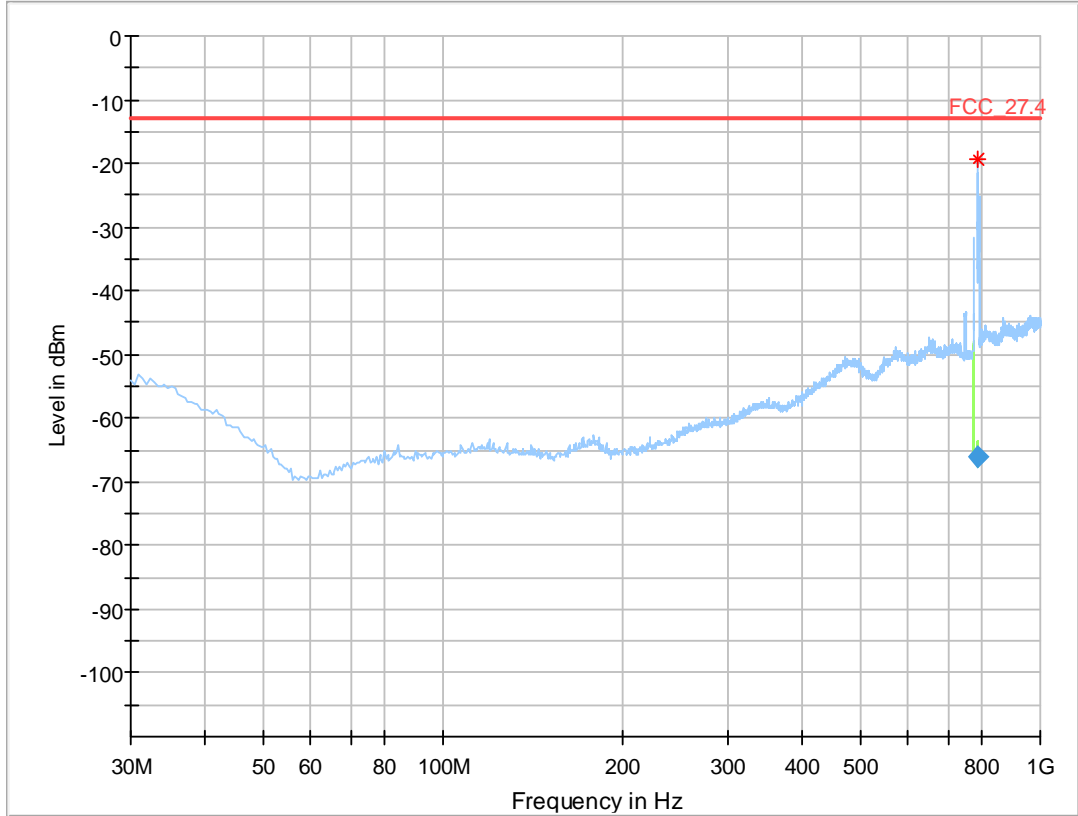

**Critical Freqs**

Frequency (MHz)	MaxPeak (dBm)	Limit (dBm)	Margin (dB)	Meas. Time (ms)	Bandwidth (kHz)	Height (cm)	Pol	Azimuth (deg)	Elevation (deg)	Corr. (dB)
787.100000	-19.39	-13.00	6.39	---	---	150.0	V	112.0	9.9	-73.2

**Final Result**

Frequency (MHz)	RMS (dBm)	Limit (dBm)	Margin (dB)	Meas. Time (ms)	Bandwidth (kHz)	Height (cm)	Pol	Azimuth (deg)	Elevation (deg)	Corr. (dB)
787.100000	-66.14	-13.00	53.14	1000.0	100.000	150.0	V	112.0	10.0	-73.2

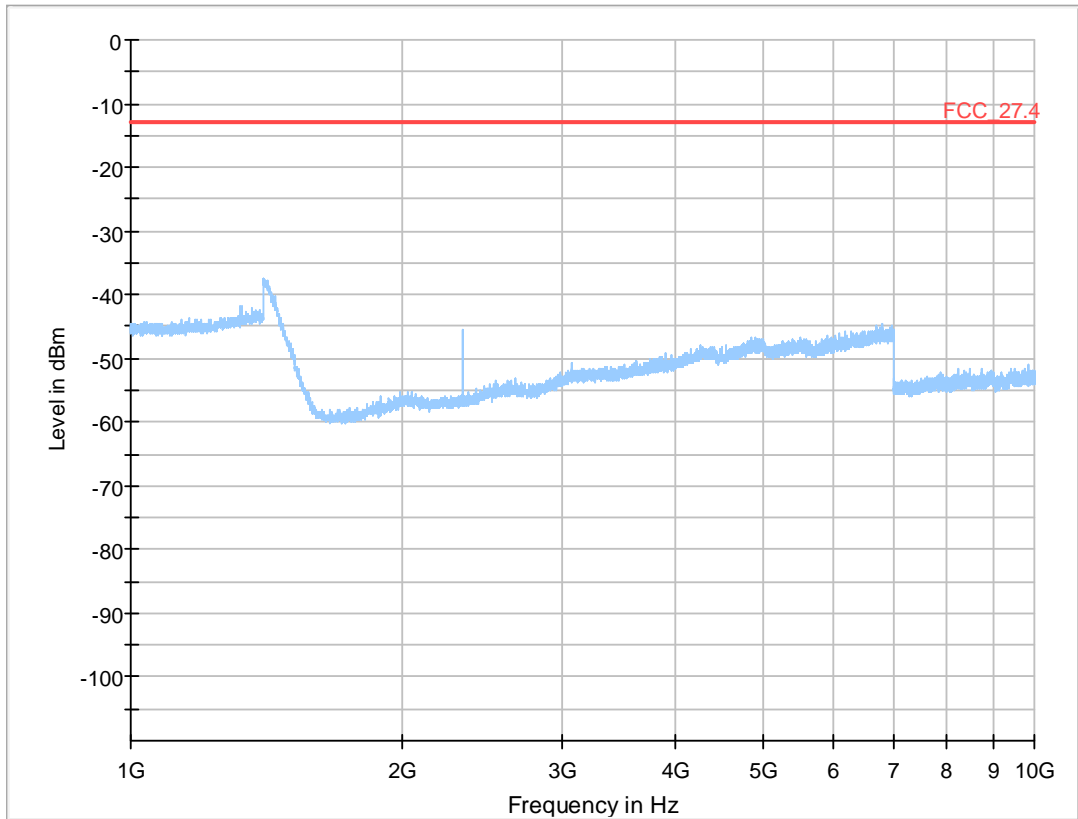

### Critical Freqs

Frequency (MHz)	MaxPeak (dBm)	Limit (dBm)	Margi n (dB)	Meas. Time (ms)	Bandwidt h (kHz)	Heigh t (cm)	Pol	Azimet h (deg)	Elevatio n (deg)	Corr. (dB)
---	---	---	---	---	---	---		---	---	---

### Final Result

Frequency (MHz)	RMS (dBm)	Limit (dBm)	Margi n (dB)	Meas. Time (ms)	Bandwidt h (kHz)	Heigh t (cm)	Pol	Azimet h (deg)	Elevatio n (deg)	Corr. (dB)
---	---	---	---	---	---	---		---	---	---

**Test: 27.4; Frequency Band = eFDD13, Mode = QPSK 5MHz, Channel = 23230, Frequency = 782MHz, Method = radiated**

*Result:* Passed  
*Setup No.:* S01\_VB01  
*Date of Test:* 2017/08/01 15:17  
*Body:* FCC47CFRCHIPART27MISCELLANEOUS WIRELESS COMMUNICATIONS SERV  
*Test Specification:* FCC part 2 and 27

**Detailed Results:**

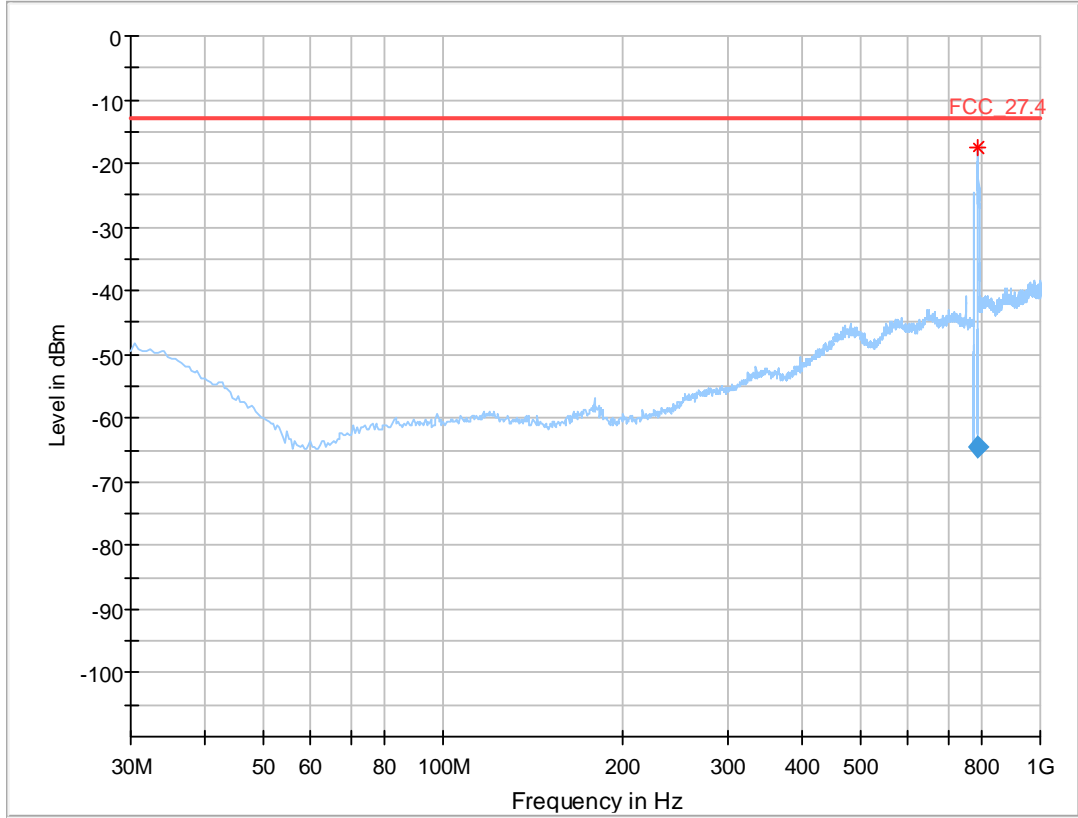

**Critical\_Freqs**

Frequency (MHz)	MaxPeak (dBm)	Limit (dBm)	Margi n (dB)	Meas. Time (ms)	Bandwidt h (kHz)	Heigh t (cm)	Pol	Azimut h (deg)	Elevatio n (deg)	Corr. (dB)
787.100000	-17.56	-13.00	4.56	---	---	150.0	H	-158.0	68.0	-74.3

**Final\_Result**

Frequency (MHz)	RMS (dBm)	Limit (dBm)	Margi n (dB)	Meas. Time (ms)	Bandwidt h (kHz)	Heigh t (cm)	Pol	Azimut h (deg)	Elevatio n (deg)	Corr. (dB)
787.100000	-64.50	-13.00	51.50	1000.0	100.000	150.0	H	-158.0	67.8	-74.3

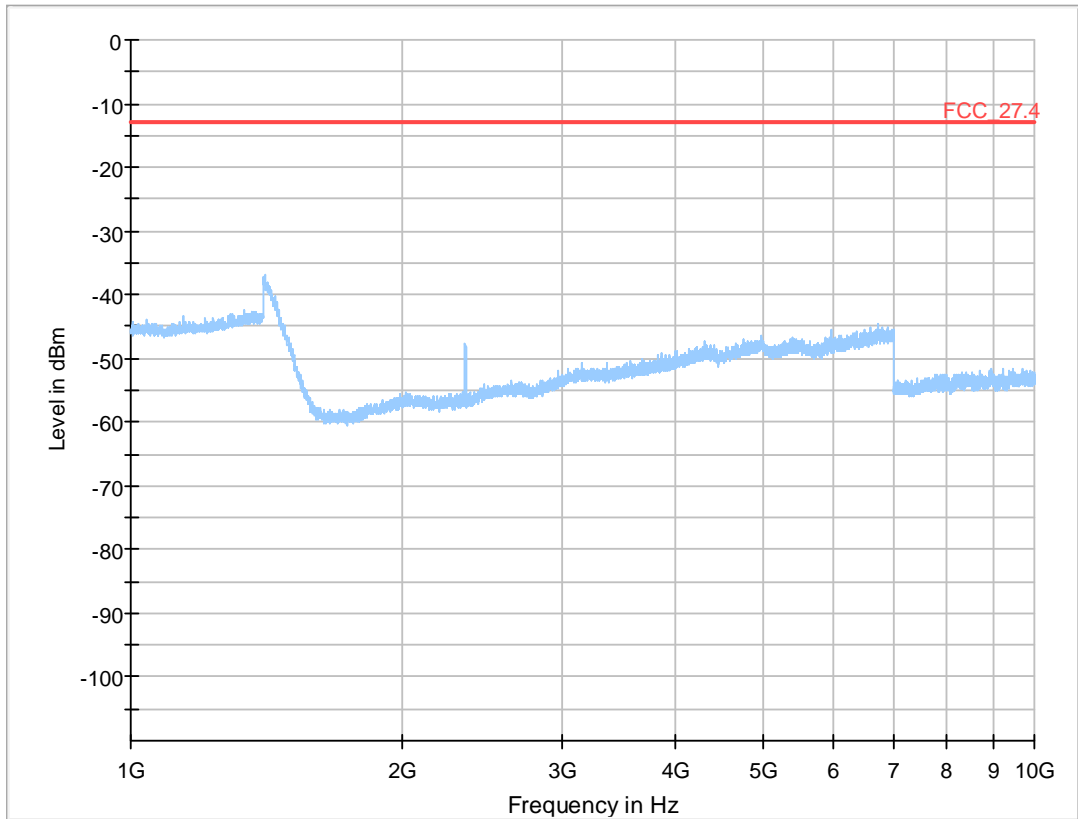

### Critical Freqs

Frequency (MHz)	MaxPeak (dBm)	Limit (dBm)	Margin (dB)	Meas. Time (ms)	Bandwidth (kHz)	Height (cm)	Pol	Azimuth (deg)	Elevation (deg)	Corr. (dB)
---	---	---	---	---	---	---		---	---	---

### Final Result

Frequency (MHz)	RMS (dBm)	Limit (dBm)	Margin (dB)	Meas. Time (ms)	Bandwidth (kHz)	Height (cm)	Pol	Azimuth (deg)	Elevation (deg)	Corr. (dB)
---	---	---	---	---	---	---		---	---	---

**Test: 27.4; Frequency Band = eFDD13, Mode = QPSK 5MHz, Channel = 23255, Frequency = 784.5MHz, Method = radiated**

Result: Passed

Setup No.: S01\_VB01

Date of Test: 2017/08/01 15:18

Body: FCC47CFRCHIPART27MISCELLANEOUS WIRELESS COMMUNICATIONS SERV

Test Specification: FCC part 2 and 27

**Detailed Results:**

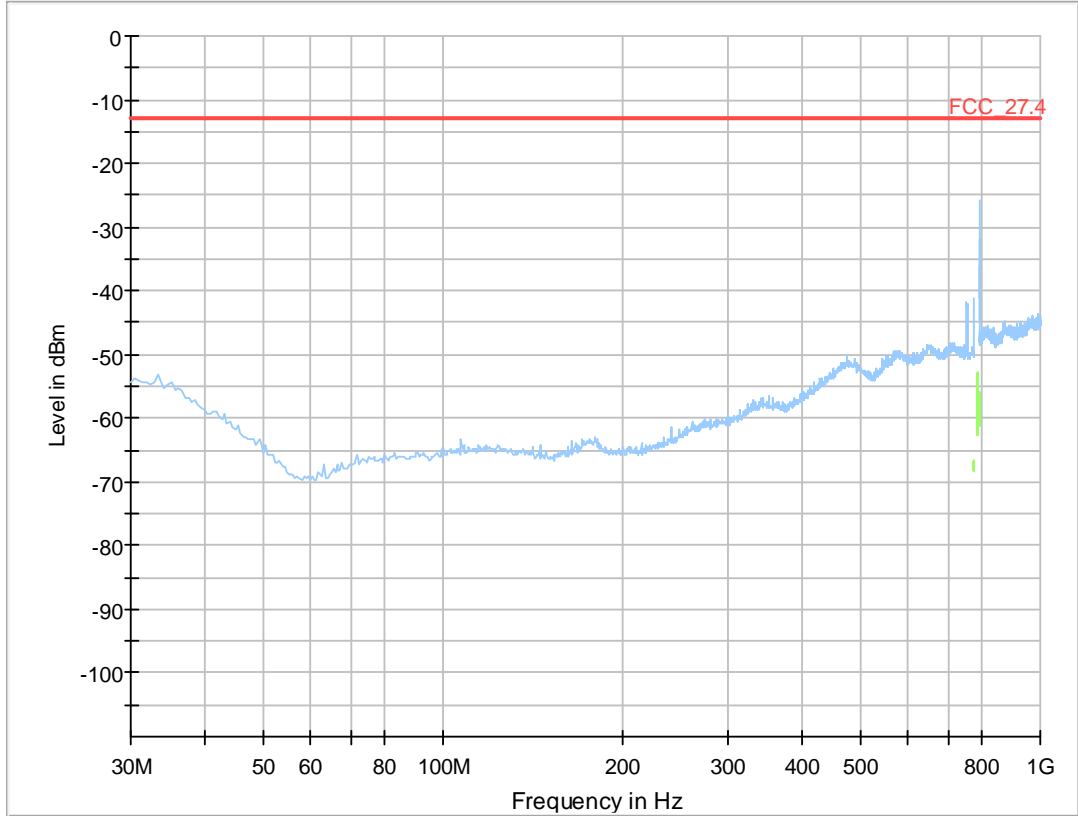

**Critical\_Freqs**

Frequency (MHz)	MaxPeak (dBm)	Limit (dBm)	Margin (dB)	Meas. Time (ms)	Bandwidth (kHz)	Height (cm)	Pol	Azimuth (deg)	Elevation (deg)	Corr. (dB)
---	---	---	---	---	---	---		---	---	---

**Final\_Result**

Frequency (MHz)	RMS (dBm)	Limit (dBm)	Margin (dB)	Meas. Time (ms)	Bandwidth (kHz)	Height (cm)	Pol	Azimuth (deg)	Elevation (deg)	Corr. (dB)
---	---	---	---	---	---	---		---	---	---

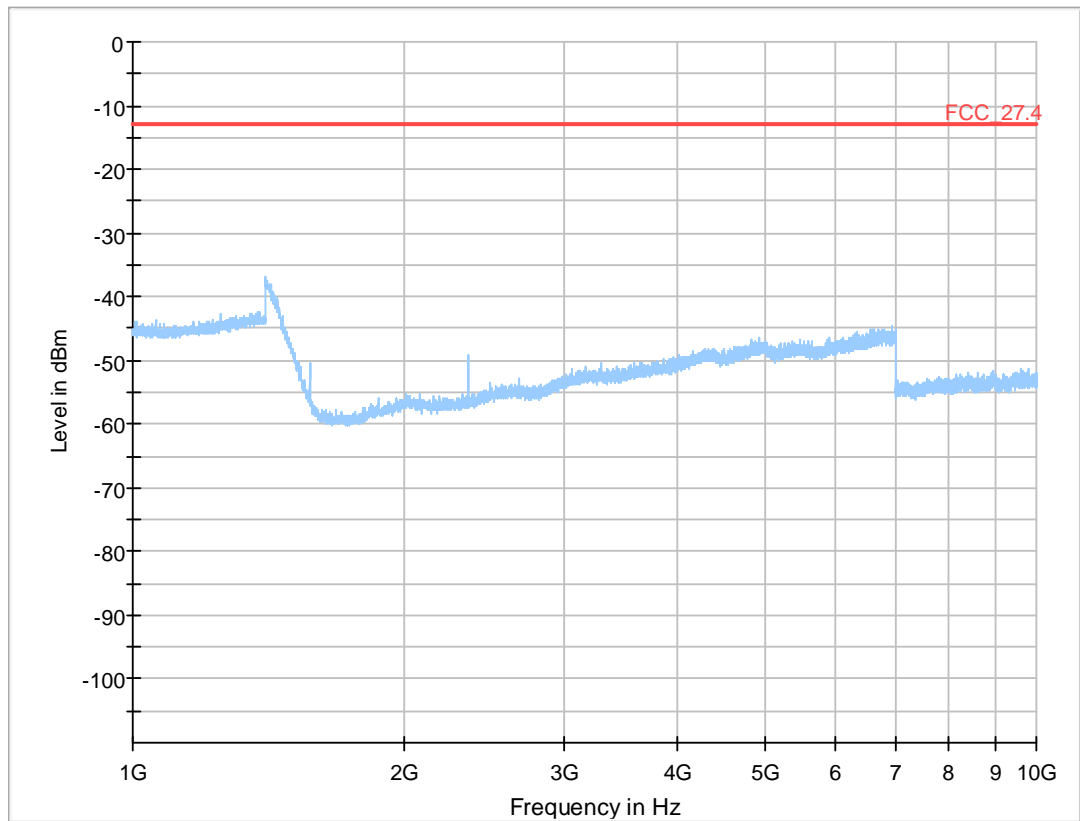

### Critical\_Freqs

Frequency (MHz)	MaxPeak (dBm)	Limit (dBm)	Margi n (dB)	Meas. Time (ms)	Bandwidt h (kHz)	Heigh t (cm)	Pol	Azimet h (deg)	Elevatio n (deg)	Corr. (dB)
---	---	---	---	---	---	---		---	---	---

### Final\_Result

Frequency (MHz)	RMS (dBm)	Limit (dBm)	Margi n (dB)	Meas. Time (ms)	Bandwidt h (kHz)	Heigh t (cm)	Pol	Azimet h (deg)	Elevatio n (deg)	Corr. (dB)
---	---	---	---	---	---	---		---	---	---

### **3.5.9 27.5 Emission and Occupied Bandwidth §2.1049**

#### **Test: 27.5; Emission and Occupied Bandwidth Summary §2.1049**

<i>Result:</i>	Passed
<i>Setup No.:</i>	S01_VC01
<i>Date of Test:</i>	2017/08/09 12:24
<i>Body:</i>	NO BODY
<i>Test Specification:</i>	FCC part 2 and 27

**Detailed Results:**

Radio Technology	Channel	Ressource Blocks	Bandwidth [MHz]	Nominal BW [MHz]	99 % BW [kHz]
eFDD 13 QPSK	low	25	5	5	4529.06
eFDD 13 QPSK	mid	25	5	5	4529.06
eFDD 13 QPSK	high	25	5	5	4488.98
eFDD 13 16QAM	low	25	5	5	4549.1
eFDD 13 16QAM	mid	25	5	5	4509.02
eFDD 13 16QAM	high	25	5	5	4509.02
eFDD 13 QPSK	mid	50	10	10	8977.96
eFDD 13 16QAM	mid	50	10	10	8977.96

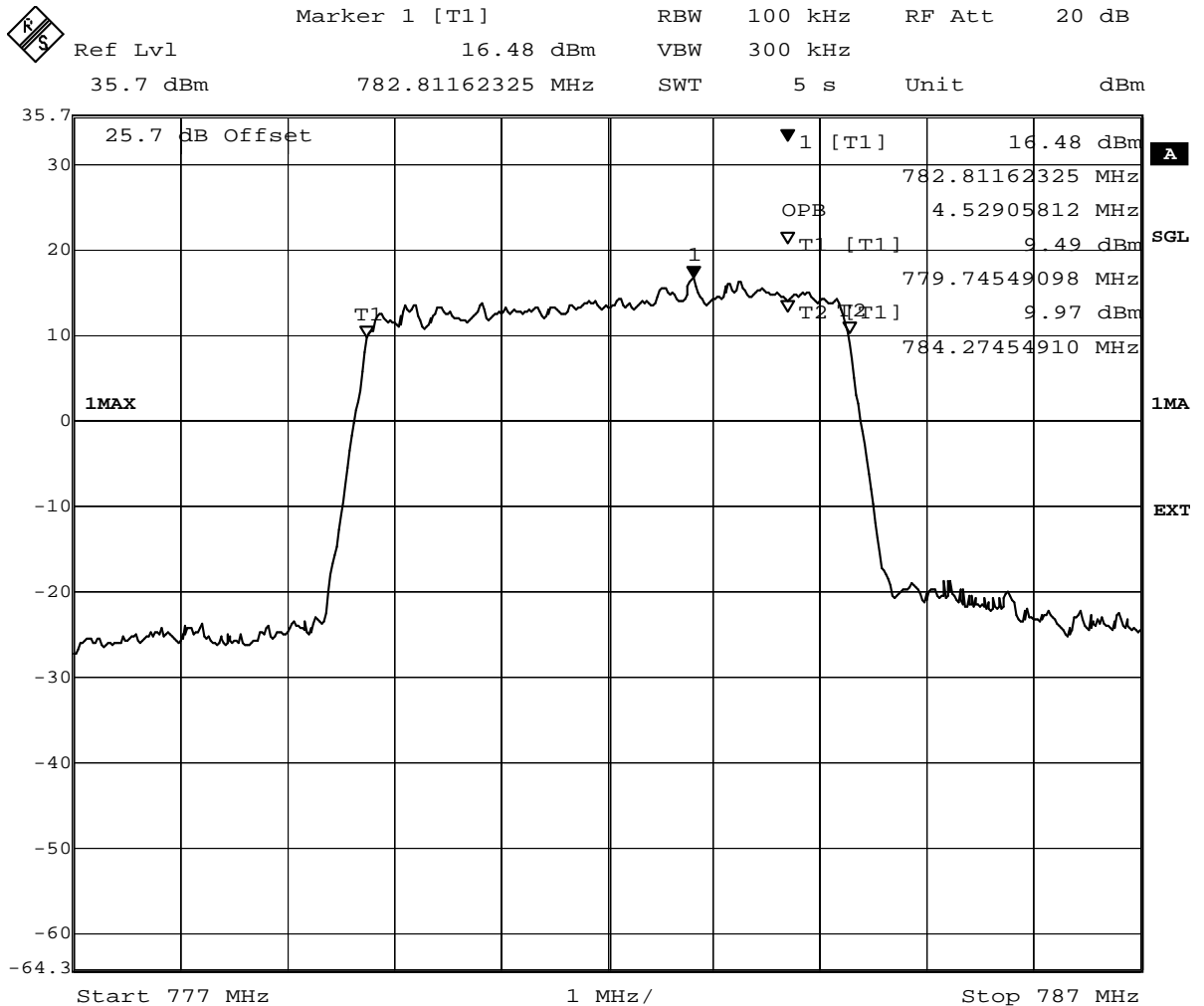

Date: 2.AUG.2017 16:30:41

eFDD13 16QAM 5MHz RB25 Channel=mid



### **3.5.10 27.6 Band edge compliance §2.1053, §27.53**

#### **Test: 27.6; Band edge compliance summary §2.1053, §27.53**

<i>Result:</i>	Passed
<i>Setup No.:</i>	S01_VC01
<i>Date of Test:</i>	2017/08/09 12:27
<i>Body:</i>	NO BODY
<i>Test Specification:</i>	FCC part 2 and 27

**Detailed Results:**

Radio Technology	CH	Band Edge	Nominal BW	Resource Blocks	Peak [dBm]	Average [dBm]	RMS [dBm]	Limit [dBm]	Margin to Limit [dB]
eFDD 13 QPSK	low	lower	5	1	-22.33	-31.91	-30.92	-13	17.92
eFDD 13 QPSK	high	higher	5	1	-25.08	-36.94	-35.78	-13	22.78
eFDD 13 16QAM	low	lower	5	1	-23.32	-34.76	-33.02	-13	20.02
eFDD 13 16QAM	high	higher	5	1	-27.46	-39.04	-36.94	-13	23.94
eFDD 13 QPSK	mid	lower	10	1	-26.53	-36.34	-34.76	-13	21.76
eFDD 13 QPSK	mid	higher	10	1	-27.93	-39.04	-36.94	-13	23.94
eFDD 13 16QAM	mid	lower	10	1	-30.42	-39.87	-39.04	-13	26.04
eFDD 13 16QAM	mid	higher	10	1	-30.85	-42.96	-40.78	-13	27.78

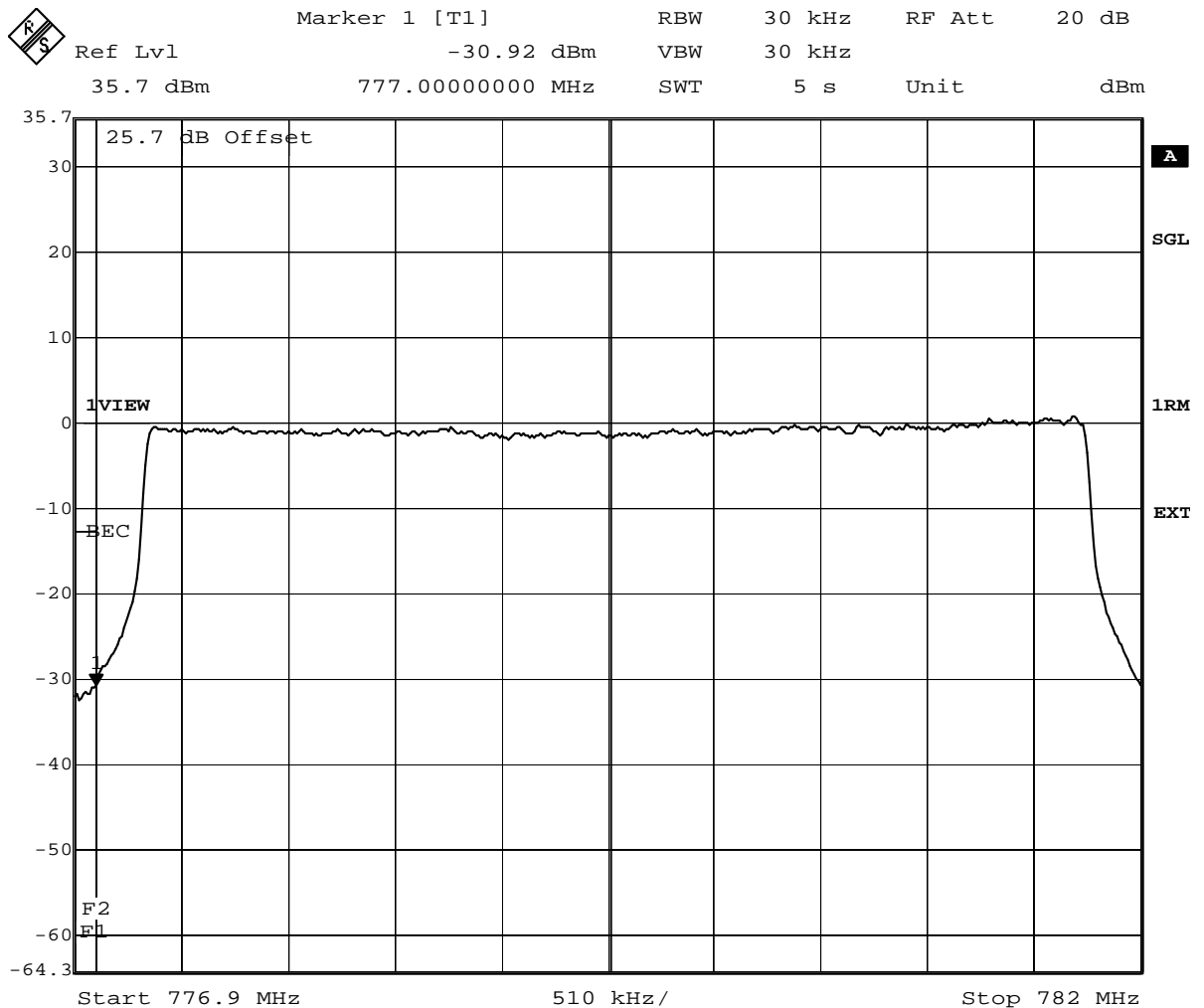

Date: 2.AUG.2017 17:09:33

eFDD13 QPSK 5MHz RB1 Channel=low

### **3.5.11 27.7 Peak-to-Average ratio §2.1046, §27.50**

#### **Test: 27.7; Peak-to-Average Ratio Summary §2.1046, §27.50**

<i>Result:</i>	Passed
<i>Setup No.:</i>	S01_VC01
<i>Date of Test:</i>	2017/08/09 12:29
<i>Body:</i>	NO BODY
<i>Test Specification:</i>	FCC part 2 and 27

**Detailed Results:**

Radio Technology	Channel	Ressource Blocks	Band width [MHz]	Peak to Average Ratio [dB]	Limit (FCC) [dB]	Limit (IC) [dB]
eFDD 13 QPSK	low	25	5	4.84	-	13
eFDD 13 QPSK	mid	25	5	4.55	-	13
eFDD 13 QPSK	high	25	5	4.38	-	13
eFDD 13 16QAM	low	25	5	5.62	-	13
eFDD 13 16QAM	mid	25	5	5.36	-	13
eFDD 13 16QAM	high	25	5	5.28	-	13

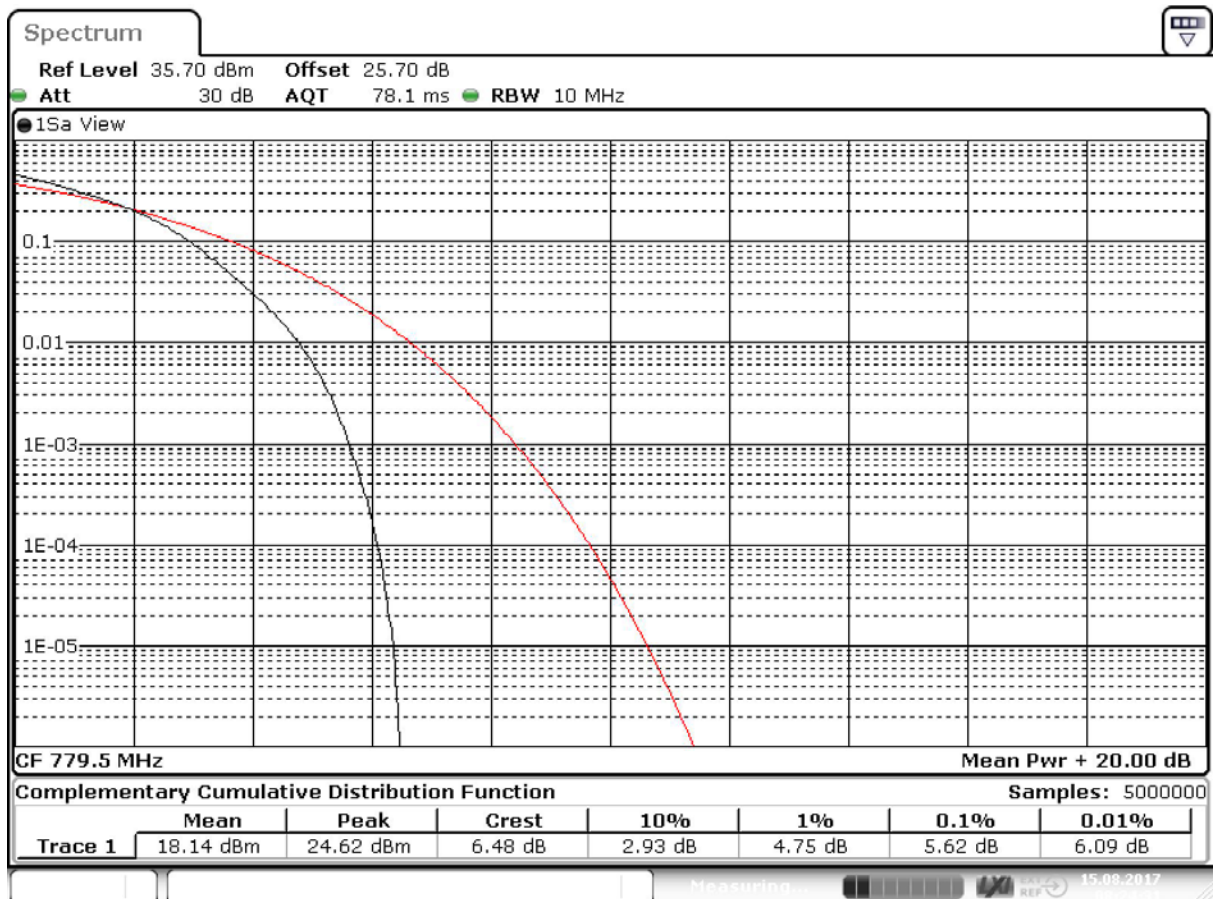

Date: 15.AUG.2017 08:24:31

eFDD13 16QAM 5MHz RB25 Channel=low

## 4 Test Equipment Details

### 4.1 List of Used Test Equipment

The calibration, hardware and software states are shown for the testing period.

#### Test Equipment Anechoic Chamber

**Lab ID:** Lab 1  
**Description:** Anechoic Chamber for radiated testing

##### Single Devices for Anechoic Chamber

Single Device Name	Type	Serial Number	Manufacturer
Air compressor	none	-	
Anechoic Chamber	10.58 x 6.38 x 6.00 m <sup>3</sup>	none	
Anechoic Chamber	8.8m x 4.6m x 4.05 m	B83117-S40-X191	Albatross Projects GmbH
Controller Maturo	MCU	961208	Maturo GmbH
EMC camera	CE-CAM/1	-	
EMC camera Nr.2	CCD-400E	0005033	
Filter ISDN	B84312-C110-E1		
Filter Universal 1A	BB4312-C30-H3	-	

#### Test Equipment Auxiliary Equipment for Radiated emissions

**Lab ID:** Lab 1  
**Description:** Equipment for emission measurements  
**Serial Number:** see single devices

##### Single Devices for Auxiliary Equipment for Radiated emissions

Single Device Name	Type	Serial Number	Manufacturer
Antenna mast	AM 4.0	AM4.0/180/11920 513	Maturo GmbH
Biconical Broadband Antenna	SBA 9119	9119-005	
Biconical dipole	VUBA 9117	9117-108	
Broadband Amplifier 1 GHz - 4 GHz	AFS4-01000400-1Q-10P-4	-	
Broadband Amplifier 18 GHz - 26 GHz	JS4-18002600-32-5P	849785	
Broadband Amplifier 30 MHz - 18 GHz	JS4-00101800-35-5P	896037	
Cable "ESI to EMI Antenna"	EcoFlex10	W18.01- 2+W38.01-2	
Cable "ESI to Horn Antenna"	SucoFlex	W18.02- 2+W38.02-2	
Double-ridged horn	HF 906	357357/002	Rohde & Schwarz GmbH & Co. KG
	<i>Calibration Details</i>		<i>Last Execution Next Execution</i>
	Standard Calibration		2015/06/23 2018/06/22
Double-ridged horn	HF 907	102444	Rohde & Schwarz GmbH & Co. KG
	<i>Calibration Details</i>		<i>Last Execution Next Execution</i>
	Standard Calibration		2015/05/11 2018/05/10

**Single Devices for Auxiliary Equipment for Radiated emissions (continued)**

<i>Single Device Name</i>	<i>Type</i>	<i>Serial Number</i>	<i>Manufacturer</i>
Double-ridged horn-duplicated 2015-07-15 10:47:55	HF 906	357357/001	Rohde & Schwarz GmbH & Co. KG
High Pass Filter	4HC1600/12750-1.5-KK	9942011	
High Pass Filter	5HC2700/12750-1.5-KK	9942012	
High Pass Filter	5HC3500/18000-1.2-KK	200035008	
High Pass Filter	WHKX 7.0/18G-8SS	09	
Horn Antenna Schwarzbeck 15-26.5 GHz BBHA 9170	BBHA 9170	BBHA9170262	
Log.-per. Antenna	HL 562 Ultralog	100609	Rohde & Schwarz GmbH & Co. KG
Log.-per. Antenna (upgraded)	HL 562 Ultralog new biconicals	830547/003	Rohde & Schwarz GmbH & Co. KG
	<i>Calibration Details</i>		<i>Last Execution Next Execution</i>
	Standard Calibration		2015/06/30 2018/06/29
Loop Antenna	HFH2-Z2	829324/006	Rohde & Schwarz GmbH & Co. KG
	<i>Calibration Details</i>		<i>Last Execution Next Execution</i>
	DKD Calibration		2014/11/27 2017/11/27
Standard Gain / Pyramidal Horn Antenna 40 GHz	3160-10	00086675	
Tilt device Maturo (Rohacell)	Antrieb TD1.5-10kg	TD1.5-10kg/024/379070 9	Maturo GmbH

### Test Equipment Auxiliary Test Equipment

**Lab ID:** Lab 1, Lab 2  
**Description:** Single Devices for various Test Equipment  
**Type:** various  
**Serial Number:** none

### Single Devices for Auxiliary Test Equipment

Single Device Name	Type	Serial Number	Manufacturer
Broadband Power Divider N (Aux)	1506A / 93459	LM390	
Broadband Power Divider SMA	WA1515	A855	
Digital Multimeter 03 (Multimeter)	Fluke 177	86670383	
	<i>Calibration Details</i>		<i>Last Execution Next Execution</i>
	DAkKS Calibration		2016/02/04 2018/02/28
Digital Multimeter 13 (Clamp Meter)	Fluke 325	31270091WS	FLUKE
	<i>Calibration Details</i>		<i>Last Execution Next Execution</i>
	DAkKS-Calibration		2016/02/04 2019/02/28
Fibre optic link Satellite (Aux)	FO RS232 Link	181-018	
Fibre optic link Transceiver (Aux)	FO RS232 Link	182-018	
Isolating Transformer	LTS 604	1888	
Notch Filter Ultra Stable (Aux)	WRCA800/960-6EEK	24	
Signal Analyzer	FSV30	103005	Rohde & Schwarz GmbH & Co. KG
	<i>Calibration Details</i>		<i>Last Execution Next Execution</i>
	DKD calibration		2016/02/25 2018/02/24
Spectrum Analyser	FSU26	200418	
	<i>Calibration Details</i>		<i>Last Execution Next Execution</i>
	Standard calibration		2016/11/03 2017/11/02
Spectrum Analyzer	FSP3	836722/011	Rohde & Schwarz GmbH & Co. KG
	<i>Calibration Details</i>		<i>Last Execution Next Execution</i>
	DKD calibration		2015/06/23 2018/06/22
Vector Signal Generator	SMIQ 03B	832492/061	

### Test Equipment Digital Signalling Devices

**Lab ID:** Lab 1, Lab 2  
**Description:** Signalling equipment for various wireless technologies.

#### Single Devices for Digital Signalling Devices

Single Device Name	Type	Serial Number	Manufacturer
CMW500	CMW500	107500	
Digital Radio Communication Tester	CMD 55	831050/020	Rohde & Schwarz GmbH & Co. KG
	<i>Calibration Details</i>		<i>Last Execution Next Execution</i>
	DKD calibration		2014/12/02 2017/12/01
Universal Radio Communication Tester	CMU 200	837983/052	Rohde & Schwarz GmbH & Co. KG
	<i>Calibration Details</i>		<i>Last Execution Next Execution</i>
	DKD calibration		2014/12/03 2017/12/02
Vector Signal Generator	SMU200A	100912	Rohde & Schwarz GmbH & Co. KG

### Test Equipment Emission measurement devices

**Lab ID:** Lab 1  
**Description:** Equipment for emission measurements  
**Serial Number:** see single devices

#### Single Devices for Emission measurement devices

Single Device Name	Type	Serial Number	Manufacturer
EMI Receiver / Spectrum Analyzer	ESR 7	101424	
	<i>Calibration Details</i>		<i>Last Execution Next Execution</i>
	DKD Calibration		2016/11/29 2018/11/28
Personal Computer	Dell	30304832059	
Power Meter	NRVD	828110/016	
	<i>Calibration Details</i>		<i>Last Execution Next Execution</i>
	Standard calibration		2017/05/17 2018/05/16
Sensor Head A	NRV-Z1	827753/005	
	<i>Calibration Details</i>		<i>Last Execution Next Execution</i>
	Standard calibration		2017/05/18 2018/05/17
Signal Generator	SMR 20	846834/008	Rohde & Schwarz GmbH & Co. KG
Spectrum Analyzer	ESIB 26	830482/004	Rohde & Schwarz GmbH & Co. KG
	<i>Calibration Details</i>		<i>Last Execution Next Execution</i>
	DAkKS Calibration (DK)		2015/12/09 2017/12/08
	<i>HW/SW Status</i>		<i>Date of Start Date of End</i>
	Firmware-Update 4.34.4 from 3.45 during calibration		2009/12/03
Spectrum Analyzer	FSW 43	103779	
	<i>Calibration Details</i>		<i>Last Execution Next Execution</i>
	DKD calibration		2016/12/02 2018/12/01



**Test Equipment Multimeter 03**

**Lab ID:** Lab 1, Lab 2  
**Description:** Fluke 177  
**Serial Number:** 86670383

**Single Devices for Multimeter 03**

<i>Single Device Name</i>	<i>Type</i>	<i>Serial Number</i>	<i>Manufacturer</i>
Digital Multimeter 03 (Multimeter)	Fluke 177	86670383	
	<i>Calibration Details</i>		<i>Last Execution Next Execution</i>
	DAkKS Calibration		2016/02/04 2018/02/28

## Test Equipment Radio Lab Test Equipment

**Lab ID:** Lab 2  
**Description:** Radio Lab Test Equipment

### Single Devices for Radio Lab Test Equipment

Single Device Name	Type	Serial Number	Manufacturer
Broadband Power Divider SMA	WA1515	A856	
Coax Attenuator 10dB SMA 2W	4T-10	F9401	
Coax Attenuator 10dB SMA 2W	56-10	W3702	
Coax Attenuator 10dB SMA 2W	56-10	W3711	
Coax Cable Huber&Suhner	Sucotest 2,0m		Huber&Suhner
Coax Cable Rosenberger Micro Coax FA210A0010003030 SMA/SMA 1,0m	FA210A0010003030	54491-2	
Power Meter	NRVD	828110/016	
	<i>Calibration Details</i>		<i>Last Execution Next Execution</i>
	Standard calibration		2017/05/17 2018/05/16
RF Step Attenuator RSP	RSP	833695/001	
Rubidium Frequency Standard	Datum, Model: MFS	5489/001	
	<i>Calibration Details</i>		<i>Last Execution Next Execution</i>
	Standard calibration		2017/07/11 2018/07/10
Sensor Head A	NRV-Z1	827753/005	
	<i>Calibration Details</i>		<i>Last Execution Next Execution</i>
	Standard calibration		2017/05/18 2018/05/17
Signal Generator SME	SME03	827460/016	
	<i>Calibration Details</i>		<i>Last Execution Next Execution</i>
	Standard calibration		2014/12/02 2017/12/01
Signal Generator SMP	SMP02	833286/0014	Rohde & Schwarz GmbH & Co. KG
	<i>Calibration Details</i>		<i>Last Execution Next Execution</i>
	Standard calibration		2016/05/24 2019/05/23
Spectrum Analyzer	FSIQ26	840061/005	Rohde & Schwarz GmbH & Co. KG

### Test Equipment T/A Logger 13

**Lab ID:** Lab 1, Lab 2  
**Description:** Lufft Opus10 TPR  
**Type:** Opus10 TPR  
**Serial Number:** 13936

#### Single Devices for T/A Logger 13

Single Device Name	Type	Serial Number	Manufacturer
ThermoAirpressure Datalogger 13 (Environ)	Opus10 TPR (8253.00)	13936	
<i>Calibration Details</i>			<i>Last Execution Next Execution</i>
Customized calibration			2017/04/10 2019/04/09

### Test Equipment T/H Logger 03

**Lab ID:** Lab 2  
**Description:** Lufft Opus10  
**Serial Number:** 7482

#### Single Devices for T/H Logger 03

Single Device Name	Type	Serial Number	Manufacturer
ThermoHygro Datalogger 03 (Environ)	Opus10 THI (8152.00)	7482	
<i>Calibration Details</i>			<i>Last Execution Next Execution</i>
Customized calibration			2017/03/30 2019/03/29

### Test Equipment T/H Logger 12

**Lab ID:** Lab 1  
**Description:** Lufft Opus10  
**Serial Number:** 12482

#### Single Devices for T/H Logger 12

Single Device Name	Type	Serial Number	Manufacturer
ThermoHygro Datalogger 12 (Environ)	Opus10 THI (8152.00)	12482	
<i>Calibration Details</i>			<i>Last Execution Next Execution</i>
Customized calibration			2017/03/30 2019/03/29

### Test Equipment Temperature Chamber 05

**Lab ID:** Lab 2  
**Description:** Temperature Chamber VT4002  
**Type:** Vötsch  
**Serial Number:** see single devices

#### Single Devices for Temperature Chamber 05

Single Device Name	Type	Serial Number	Manufacturer
Temperature Chamber Vötsch 05	VT 4002	58566080550010	
<i>Calibration Details</i>			<i>Last Execution Next Execution</i>
Customized calibration			2016/03/09 2018/03/08

## **5 Annex**

### **5.1 Additional Information for Report**

Summary of Test Results

---

---

The EUT complied with all performed tests as listed in the summary section of this report.

---

Technical Report Summary

---

---

Type of Authorization :

Certification for a GSM/WCDMA/CDMA2000 cellular radiotelephone device

Applicable FCC Rules

Prepared in accordance with the requirements of FCC Rules and Regulations as listed in 47 CFR Ch.1 Parts 0 to 69. The following subparts are applicable to the results in this test report.

Part 2, Subpart J - Equipment Authorization Procedures, Certification

- § 2.1046 Measurement required: RF power output
- § 2.1049 Measurement required: Occupied bandwidth
- § 2.1051 Measurement required: Spurious emissions at antenna terminals
- § 2.1053 Measurement required: Field strength of spurious radiation
- § 2.1055 Measurement required: Frequency stability
- § 2.1057 Frequency spectrum to be investigated

Part 22, Subpart C – Operational and Technical Requirements

- § 22.355 Frequency tolerance

Part 22, Subpart H – Cellular Radiotelephone Service

- § 22.913 Effective radiated power limits
- § 22.917 Emission limitations for cellular equipment

additional documents

ANSI TIA-603-C-2004

Description of Methods of Measurements

---

---

RF Power Output

---

Standard    FCC Part 22, Subpart H

The test was performed according to: FCC §2.1046

Test Description (conducted measurement procedure)

- 1) The EUT was coupled to a Spectrum Analyser and a Digital Communication Tester through a Power Divider. Refer to chapter "Setup Drawings".
  - 2) The total insertion losses for signal path 1 and signal path 2 were measured. The values were used to correct the readings from the Spectrum Analyser and the Digital Communication Tester.
  - 3) A call was established on a Traffic Channel between the EUT and the Digital Communication Tester.
- Important Settings:
- Channel (Frequency): please refer to the detailed results
- 4) The transmitted power of the EUT was recorded by using a spectrum analyser.

Test Description (radiated measurement procedure)

- 1) The EUT was placed inside an anechoic chamber. Refer to chapter "Setup Drawings". The EUT was coupled to a Digital Communication Tester which was located outside the chamber via a small signalling antenna.
  - 2) A call was established on a Traffic Channel between the EUT and the Digital Communication Tester.
- Important Settings:
- Output Power: Maximum
  - Channel: please refer to the detailed results
- 3) A substitution procedure is used so that the readings from the spectrum analyser are corrected and represent directly the equivalent radiated power (related to a  $\lambda/2$  dipole).
  - 4) The output power was measured in both vertical and horizontal antenna polarisation during the call is established on the lowest channel, mid channel and on the highest channel. To find the worst case power all orientations (X, Y, Z) of the EUT have been measured.
  - 5) The test procedure according to TIA-603-C-2004 has been considered.

Test Requirements / Limits

§2.1046 Measurements Required: RF Power Output

(a) For transmitters other than single sideband, independent sideband and controlled carrier radiotelephone, power output shall be measured at the RF output terminals when the transmitter is adjusted in accordance with the tune-up procedure to give the values of current and voltage on the circuit elements specified in § 2.1033(c)(8). The electrical characteristics of the output terminals when this test is made shall be stated.

§22.913 Effective radiated power limits

(a)(2) Maximum ERP. ... The ERP of mobile transmitters and auxiliary test transmitters must not exceed 7 Watts.

---

Emission and Occupied Bandwidth

---

Standard FCC Part 22, Subpart H

The test was performed according to: FCC §2.1049

Test Description

- 1) The EUT was coupled to a Spectrum Analyser and a Digital Communication Tester through a Power Divider. Refer to chapter "Setup Drawings".
  - 2) The total insertion losses for signal path 1 and signal path 2 were measured. The values were used to correct the readings from the Spectrum Analyser and the Digital Communication Tester.
  - 3) A call was established on a Traffic Channel between the EUT and the Digital Communication Tester.
- Important Settings:
- Output Power: Maximum
  - Channel: please refer to the detailed results
- 4) Important Analyser Settings:
    - Resolution Bandwidth: >1% of the manufacturer's stated occupied bandwidth
  - 5) The maximum spectral level of the modulated signal was recorded as the reference.
  - 6) The emission bandwidth is measured as follows:  
the two furthest frequencies above and below the frequency of the maximum reference level where the spectrum is -26 dB down have to be found.
  - 7) The occupied bandwidth (99% Bandwidth) is measured as follows:  
the occupied bandwidth, that is the frequency bandwidth such that, below its lower and above its upper frequency limits, the mean powers are each equal to 0.5 percent of the total mean power.

#### Test Requirements / Limits

##### § 2.1049 Measurements required: Occupied bandwidth

The occupied bandwidth, that is the frequency bandwidth such that, below its lower and above its upper frequency limits, the mean powers radiated are each equal to 0.5 percent of the total mean power radiated by a given emission shall be measured under the following conditions (as applicable):

(h) Transmitters employing digital modulation techniques - when modulated by an input signal such that its amplitude and symbol rate represent the maximum rated conditions under which the equipment will be operated. The signal shall be applied through any filter networks, pseudo-random generators or other devices required in normal service. Additionally, the occupied bandwidth shall be shown for operation with any devices used for modifying the spectrum when such devices are optional at the discretion of the user.

---

#### Spurious emissions at antenna terminals

---

Standard FCC Part 22, Subpart H

The test was performed according to FCC §2.1051

#### Test Description

- 1) The EUT was coupled to a Spectrum Analyser and a Digital Communication Tester through a Power Divider. Refer to chapter "Setup Drawings".
- 2) The total insertion losses for signal path 1 and signal path 2 were measured. The values were used to correct the readings from the Spectrum Analyser and the Digital Communication Tester.
- 3) A call was established on a Traffic Channel between the EUT and the Digital Communication Tester.  
Important Settings:
  - Output Power: Maximum
  - Channel: please refer to the detailed results
- 4) Important Analyser Settings
  - [Resolution Bandwidth]:
    - a) [ $\geq 1\%$  of wanted signal bandwidth] in the Span of 1 MHz directly below and above the PCS-Band,
    - b) otherwise [100 kHz] (or [1 MHz] for accelerated sweep times)
    - c) [reduced resolution bandwidth] in case the curve of the analyser IF-Filter or the wanted EUT signal leads to an exceeding of the limit, in this case a correction factor was used
  - Sweep Time: depending on the transmitting signal, the span and the resolution bandwidth
- 5) The spurious emissions peaks were measured in the frequency range from 9 kHz to 10 GHz (up to the 10th harmonic) during the call was established

#### Test Requirements / Limits

##### § 2.1051 Spurious emissions at antenna terminals

The radio frequency voltage or power generated within the equipment and appearing on a spurious frequency shall be checked at the equipment output terminals when properly loaded with a suitable artificial antenna. Curves or equivalent data shall show the magnitude of each harmonic and other spurious emission that can be detected when the equipment is operated under the conditions specified in Sec. 2.1049 as appropriate. The magnitude of spurious emissions which are attenuated more than 20 dB below the permissible value need not be specified.

##### § 2.1057 Frequency spectrum to be investigated.

- (a) In all of the measurements set forth in Secs. 2.1051 and 2.1053, the spectrum shall be investigated from the lowest radio frequency signal generated in the equipment, without going below 9 kHz, up to at least the frequency shown below:
- (1) If the equipment operates below 10 GHz: to the tenth harmonic of the highest fundamental frequency or to 40 GHz, whichever is lower.
  - (b) Particular attention should be paid to harmonics and subharmonics of the carrier frequency as well as to those frequencies removed from the carrier by multiples of the oscillator frequency. Radiation at the frequencies of multiplier stages should also be checked.
  - (c) The amplitude of spurious emissions which are attenuated more than 20 dB below the permissible value

need not be reported.

(d) Unless otherwise specified, measurements above 40 GHz shall be performed using a minimum resolution bandwidth of 1 MHz.

#### § 22.917 Emission limitations for cellular equipment

(a) The power of any emission outside of the authorized operating frequency ranges must be attenuated below the transmitting power (P) by a factor of at least  $43 + 10 \log(P)$  dB.

Remark of the test laboratory: This is calculated to be -13 dBm.

(b) Compliance with these rules is based on the use of measurement instrumentation employing a resolution bandwidth of 100 kHz or greater. In the 1 MHz bands immediately outside and adjacent to the frequency block a resolution bandwidth of at least one percent of the emission bandwidth of the fundamental emission of the transmitter may be employed. A narrower resolution bandwidth is permitted in all cases to improve measurement accuracy provided the measured power is integrated over the full required measurement bandwidth (i.e. 100 kHz or 1 percent of emission bandwidth, as specified). The emission bandwidth is defined as the width of the signal between two points, one below the carrier center frequency and one above the carrier center frequency, outside of which all emissions are attenuated at least 26 dB below the transmitter power.

(c) Licensees in this service may establish an alternative out of band emission limit to be used at specified band edge(s) in specified geographical areas [...].

(d) If any emission from a transmitter operating in this service results in interference to users of another radio service, the FCC may require a greater attenuation of that emission than specified in this section.

For reporting only spurious emission levels reaching to the 20dB margin to limit were noted.

---

#### Field strength of spurious radiation

---

Standard FCC Part 22, Subpart H

The test was performed according to: FCC §2.1053

#### Test Description

1) The EUT was placed inside an anechoic chamber. Refer to chapter "Setup Drawings". The EUT was coupled to a Digital Communication Tester which was located outside the chamber via a small signalling antenna.

2) A call was established on a Traffic Channel between the EUT and the Digital Communication Tester.

Important Settings:

- Output Power: Maximum

- Channel: please refer to the detailed results

3) A pre-calibration procedure is used so that the readings from the spectrum analyser are corrected and represent directly the equivalent radiated power (related to a  $\lambda/2$  dipole).

4) All spurious radiation measurements were made with spectrum analyser and the appropriate calibrated antennas for the frequency range of 30 MHz to 10 GHz (up to the 10th harmonic of the transmit frequency). The frequency range from 9 kHz to 30 MHz has been examined during the conducted spurious emission measurements.

5) Important Analyser Settings

- [Resolution Bandwidth / Video Bandwidth]:

a) [3 kHz / 10 kHz] in the Span of 1 MHz directly below and above the Band,

b) [10 kHz / 30 kHz] in case the curve of the analyser IF-Filter leads to an exceeding of the limit, in this case a worst case correction factor of 20 dB (1 MHz -> 10 kHz) was used

c) [1 MHz / 3 MHz] otherwise

- Sweep Time: depending on the transmitting signal, the span and the resolution bandwidth

6) The spurious emissions peaks were measured in both vertical and horizontal antenna polarization during the call is established on the lowest channel, mid channel and on the highest channel. To find the worst case peaks all orientations (X, Y, Z) of the EUT have been measured.

7) After this initial test, a final test according to TIA-603-C 2.2.12 Unwanted Emissions is performed on signals which are identified as being close to the limit. For any emissions found to be within 10 dB of the limit, a specific signal substitution measurement is performed at the frequency of the emission to determine the exact e.i.r.p. value.

#### Test Requirements / Limits

§ 2.1053 Measurements required: Field strength of spurious radiation.



Measurements shall be made to detect spurious emissions that may be radiated directly from the cabinet, control circuits, power leads, or intermediate circuit elements under normal conditions of installation and operation. Curves or equivalent data shall be supplied showing the magnitude of each harmonic and other spurious emission. For this test, single sideband, independent sideband, and controlled carrier transmitters shall be modulated under the conditions specified in paragraph (c) of Sec. 2.1049, as appropriate. For equipment operating on frequencies below 890 MHz, an open field test is normally required, with the measuring instrument antenna located in the far-field at all test frequencies. In the event it is either impractical or impossible to make open field measurements (e.g. a broadcast transmitter installed in a building) measurements will be accepted of the equipment as installed. Such measurements must be accompanied by a description of the site where the measurements were made showing the location of any possible source of reflections which might distort the field strength measurements. Information submitted shall include the relative radiated power of each spurious emission with reference to the rated power output of the transmitter, assuming all emissions are radiated from halfwave dipole antennas.

- (b) The measurements specified in paragraph (a) of this section shall be made for the following equipment:  
(2) All equipment operating on frequencies higher than 25 MHz.

#### § 2.1057 Frequency spectrum to be investigated.

(a) In all of the measurements set forth in Secs. 2.1051 and 2.1053, the spectrum shall be investigated from the lowest radio frequency signal generated in the equipment, without going below 9 kHz, up to at least the frequency shown below:

(1) If the equipment operates below 10 GHz: to the tenth harmonic of the highest fundamental frequency or to 40 GHz, whichever is lower.

(b) Particular attention should be paid to harmonics and subharmonics of the carrier frequency as well as to those frequencies removed from the carrier by multiples of the oscillator frequency. Radiation at the frequencies of multiplier stages should also be checked.

(c) The amplitude of spurious emissions which are attenuated more than 20 dB below the permissible value need not be reported.

(d) Unless otherwise specified, measurements above 40 GHz shall be performed using a minimum resolution bandwidth of 1 MHz.

#### § 22.917 Emission limitations for cellular equipment

(a) The power of any emission outside of the authorized operating frequency ranges must be attenuated below the transmitting power (P) by a factor of at least  $43 + 10 \log(P)$  dB.

This is calculated to be -13 dBm (effective radiated power) which corresponds to 84.6 dB $\mu$ V/m (field strength) in a distance of 3 m.

(b) Compliance with these rules is based on the use of measurement instrumentation employing a resolution bandwidth of 100 kHz or greater. In the 1 MHz bands immediately outside and adjacent to the frequency block a resolution bandwidth of at least one percent of the emission bandwidth of the fundamental emission of the transmitter may be employed. A narrower resolution bandwidth is permitted in all cases to improve measurement accuracy provided the measured power is integrated over the full required measurement bandwidth (i.e. 100 kHz or 1 percent of emission bandwidth, as specified). The emission bandwidth is defined as the width of the signal between two points, one below the carrier center frequency and one above the carrier center frequency, outside of which all emissions are attenuated at least 26 dB below the transmitter power.

(c) Licensees in this service may establish an alternative out of band emission limit to be used at specified band edge(s) in specified geographical areas [...].

(d) If any emission from a transmitter operating in this service results in interference to users of another radio service, the FCC may require a greater attenuation of that emission than specified in this section.

For reporting only spurious emission levels reaching to the 20dB margin to limit were noted.

\_\_\_\_\_  
Frequency stability  
\_\_\_\_\_

Standard    FCC Part 22, Subpart H

The test was performed according to FCC §2.1055

#### Test Description

- 1) The EUT was placed inside a temperature chamber.
- 2) The EUT was coupled to a Digital Communication Tester. Refer to chapter "Setup Drawings".

- 3) The climatic chamber was cycled down/up to a certain temperature, starting with the EUT minimum temperature.
- 4) After the temperature was stabilized the EUT was switched on and a call was established on a Traffic Channel between the EUT and the Digital Communication Tester.  
Important Settings:  
- Output Power: Maximum  
- Mid Channel
- 5) The frequency error of the EUT was recorded by using an internal measurement function of the Digital Communication Tester immediately after the call was established, five minutes after the call was established and ten minutes after the call was established.
- 6) This measurement procedure was performed for temperature variation from -30°C to +50°C in increments of 10°C, if not otherwise stated in the detailed results.  
When the EUT did not operate at certain temperature levels, these measurements were left out.

#### Test Requirements / Limits

##### §2.1055 Measurements required: Frequency stability

- (a) The frequency stability shall be measured with variation of ambient temperature as follows:
- (1) From -30° to +50° centigrade for all equipment except that specified in paragraphs (a) (2) and (3) of this section.
  - (b) Frequency measurements shall be made at the extremes of the specified temperature range and at intervals of not more than 10° centigrade through the range. A period of time sufficient to stabilize all of the components of the oscillator circuit at each temperature level shall be allowed prior to frequency measurement. The short term transient effects on the frequency of the transmitter due to keying (except for broadcast transmitters) and any heating element cycling normally occurring at each ambient temperature level also shall be shown. Only the portion or portions of the transmitter containing the frequency determining and stabilizing circuitry need be subjected to the temperature variation test.
  - (d) The frequency stability shall be measured with variation of primary supply voltage as follows:
    - (1) Vary primary supply voltage from 85 to 115 percent of the nominal value for other than hand carried battery equipment.
    - (2) For hand carried, battery powered equipment, reduce primary supply voltage to the battery operating end point which shall be specified by the manufacturer.
    - (3) The supply voltage shall be measured at the input to the cable normally provided with the equipment, or at the power supply terminals if cables are not normally provided. Effects on frequency of transmitter keying (except for broadcast transmitters) and any heating element cycling at the nominal supply voltage and at each extreme also shall be shown.

##### §22.355 Frequency tolerance

...the carrier frequency of each transmitter in the Public Mobile Service must be maintained within the tolerances given in table C-1 of this section.

Frequency range (MHz)	Base, fixed (ppm)	Mobile up to 3 watts (ppm)	Mobile above 3 watts (ppm)
25 to 50	20.0	20.0	50.0
50 to 450	5.0	5.0	50.0
450 to 512	2.5	5.0	5.0
821 to 896	1.5	2.5	2.5
928 to 929	5.0	n/a	n/a
929 to 960	1.5	n/a	n/a
2110 to 2220	10.0	n/a	n/a

channel (836.6 MHz) the frequency tolerance is 2.5 ppm (2091.5 Hz).

#### Band edge compliance

Standard FCC Part 22, Subpart H

The test was performed according to: FCC §22.913

#### Test Description

- 1) The EUT was coupled to a Spectrum Analyser and a Digital Communication Tester through a Power Divider.

Refer to chapter "Setup Drawings".

2) The total insertion losses for signal path 1 and signal path 2 were measured. The values were used to correct the readings from the Spectrum Analyser and the Digital Communication Tester.

3) A call was established on a Traffic Channel between the EUT and the Digital Communication Tester.

Important Settings:

- Output Power: Maximum
- Channel: please refer to the detailed results

4) Important Analyser Settings:

- Resolution Bandwidth = Video Bandwidth: >1% of the manufacturer's stated occupied bandwidth

Test Requirements / Limits

§ 22.917 Emission limitations for cellular equipment

Refer to chapter "Field strength of spurious radiation".

Summary of Test Results

---

---

The EUT complied with all performed tests as listed in the summary section of this report.

---

Technical Report Summary

---

---

Type of Authorization :

Certification for a GSM/WCDMA/CDMA2000 cellular radiotelephone device

Applicable FCC Rules

Prepared in accordance with the requirements of FCC Rules and Regulations as listed in 47 CFR Ch.1 Parts 0 to 69. The following subparts are applicable to the results in this test report.

Part 2, Subpart J - Equipment Authorization Procedures, Certification

- § 2.1046 Measurement required: RF power output
- § 2.1049 Measurement required: Occupied bandwidth
- § 2.1051 Measurement required: Spurious emissions at antenna terminals
- § 2.1053 Measurement required: Field strength of spurious radiation
- § 2.1055 Measurement required: Frequency stability
- § 2.1057 Frequency spectrum to be investigated

Part 24, Subpart E - Broadband PCS

- § 24.232 Power and antenna height limits
- § 24.235 Frequency stability
- § 24.236 Field strength limits
- § 24.238 Emission limitations for Broadband PCS equipment

additional documents

ANSI TIA-603-C-2004

Description of Methods of Measurements

---

---

RF Power Output

---

Standard: FCC Part 24, Subpart E

The test was performed according to: FCC §2.1046

Test Description (conducted measurement procedure)

- 1) The EUT was coupled to a Spectrum Analyser and a Digital Communication Tester through a Power Divider. Refer to chapter "Setup Drawings".
- 2) The total insertion losses for signal path 1 and signal path 2 were measured. The values were used to correct the readings from the Spectrum Analyser and the Digital Communication Tester.
- 3) A call was established on a Traffic Channel between the EUT and the Digital Communication Tester.  
Important Settings:
  - Channel (Frequency): please refer to the detailed results
- 4) The transmitted power of the EUT was recorded by using a spectrum analyser.

Test Description (radiated measurement procedure)

- 1) The EUT was placed inside an anechoic chamber. Refer to chapter "Setup Drawings". The EUT was coupled to a Digital Communication Tester which was located outside the chamber via a small signalling antenna.
- 2) A call was established on a Traffic Channel between the EUT and the Digital Communication Tester.  
Important Settings:
  - Output Power: Maximum
  - Channel: please refer to the detailed results
- 3) A substitution procedure is used so that the readings from the spectrum analyser are corrected and represent directly the equivalent radiated power (related to a  $\lambda/2$  dipole).
- 4) The output power was measured in both vertical and horizontal antenna polarisation during the call is established on the lowest channel, mid channel and on the highest channel. To find the worst case power all orientations (X, Y, Z) of the EUT have been measured.
- 5) The test procedure according to TIA-603-C-2004 has been considered.

Test Requirements / Limits

§2.1046 Measurements Required: RF Power Output

(a) For transmitters other than single sideband, independent sideband and controlled carrier radiotelephone, power output shall be measured at the RF output terminals when the transmitter is adjusted in accordance with the tune-up procedure to give the values of current and voltage on the circuit elements specified in § 2.1033(c)(8). The electrical characteristics of the output terminals when this test is made shall be stated.

§24.232 Power and antenna height limits

(c) Mobile/portable stations are limited to 2 watts EIRP peak power and the equipment must employ means to limit the power to the minimum necessary for successful communications.

(e) Peak transmit power must be measured over any interval of continuous transmission using instrumentation calibrated in terms of an rms-equivalent voltage. The measurement results shall be properly adjusted for any instrument limitations, such as detector response times, limited resolution bandwidth capability when compared to the emission bandwidth, sensitivity, etc., so as to obtain a true peak measurement for the emission in question over the full bandwidth of the channel.

---

Emission and Occupied Bandwidth

---

Standard: FCC Part 24, Subpart E

The test was performed according to: FCC §2.1049

#### Test Description

- 1) The EUT was coupled to a Spectrum Analyser and a Digital Communication Tester through a Power Divider. Refer to chapter "Setup Drawings".
  - 2) The total insertion losses for signal path 1 and signal path 2 were measured. The values were used to correct the readings from the Spectrum Analyser and the Digital Communication Tester.
  - 3) A call was established on a Traffic Channel between the EUT and the Digital Communication Tester.
- Important Settings:
- Output Power: Maximum
  - Channel: please refer to the detailed results
- 4) Important Analyser Settings:
    - Resolution Bandwidth: >1% of the manufacturer's stated occupied bandwidth
  - 5) The maximum spectral level of the modulated signal was recorded as the reference.
  - 6) The emission bandwidth is measured as follows:  
the two furthest frequencies above and below the frequency of the maximum reference level where the spectrum is -26 dB down have to be found.
  - 7) The occupied bandwidth (99% Bandwidth) is measured as follows:  
the occupied bandwidth, that is the frequency bandwidth such that, below its lower and above its upper frequency limits, the mean powers are each equal to 0.5 percent of the total mean power.

#### Test Requirements / Limits

§ 2.1049 Measurements required: Occupied bandwidth

The occupied bandwidth, that is the frequency bandwidth such that, below its lower and above its upper frequency limits, the mean powers radiated are each equal to 0.5 percent of the total mean power radiated by a given emission shall be measured under the following conditions (as applicable):

(h) Transmitters employing digital modulation techniques - when modulated by an input signal such that its amplitude and symbol rate represent the maximum rated conditions under which the equipment will be operated. The signal shall be applied through any filter networks, pseudo-random generators or other devices required in normal service. Additionally, the occupied bandwidth shall be shown for operation with any devices used for modifying the spectrum when such devices are optional at the discretion of the user.

---

#### Spurious emissions at antenna terminals

---

Standard: FCC Part 24, Subpart E

The test was performed according to FCC §2.1051

#### Test Description

- 1) The EUT was coupled to a Spectrum Analyser and a Digital Communication Tester through a Power Divider. Refer to chapter "Setup Drawings".
  - 2) The total insertion losses for signal path 1 and signal path 2 were measured. The values were used to correct the readings from the Spectrum Analyser and the Digital Communication Tester.
  - 3) A call was established on a Traffic Channel between the EUT and the Digital Communication Tester.
- Important Settings:
- Output Power: Maximum
  - Channel: please refer to the detailed results
- 4) Important Analyser Settings:
    - [Resolution Bandwidth]:
      - a) [ $\geq 1\%$  of wanted signal bandwidth] in the Span of 1 MHz directly below and above the Band,
      - b) otherwise [1 MHz]
      - c) [reduced resolution bandwidth] in case the curve of the analyser IF-Filter or the wanted EUT signal leads to an exceeding of the limit, in this case a correction factor was used
    - Sweep Time: depending on the transmitting signal, the span and the resolution bandwidth
  - 5) The spurious emissions peaks were measured in the frequency range from 9 kHz to 20 GHz (up to the 10th harmonic) during the call was established

## Test Requirements / Limits

### § 2.1051 Spurious emissions at antenna terminals

The radio frequency voltage or power generated within the equipment and appearing on a spurious frequency shall be checked at the equipment output terminals when properly loaded with a suitable artificial antenna. Curves or equivalent data shall show the magnitude of each harmonic and other spurious emission that can be detected when the equipment is operated under the conditions specified in Sec. 2.1049 as appropriate. The magnitude of spurious emissions which are attenuated more than 20 dB below the permissible value need not be specified.

### § 2.1057 Frequency spectrum to be investigated.

(a) In all of the measurements set forth in Secs. 2.1051 and 2.1053, the spectrum shall be investigated from the lowest radio frequency signal generated in the equipment, without going below 9 kHz, up to at least the frequency shown below:

(1) If the equipment operates below 10 GHz: to the tenth harmonic of the highest fundamental frequency or to 40 GHz, whichever is lower.

(b) Particular attention should be paid to harmonics and subharmonics of the carrier frequency as well as to those frequencies removed from the carrier by multiples of the oscillator frequency. Radiation at the frequencies of multiplier stages should also be checked.

(c) The amplitude of spurious emissions which are attenuated more than 20 dB below the permissible value need not be reported.

(d) Unless otherwise specified, measurements above 40 GHz shall be performed using a minimum resolution bandwidth of 1 MHz.

### § 24.238 Emission limitations for Broadband PCS equipment

(a) The power of any emission outside of the authorized operating frequency ranges must be attenuated below the transmitting power (P) by a factor of at least  $43 + 10 \log(P)$  dB.

Remark of the test laboratory: This is calculated to be -13 dBm.

(b) Compliance with these rules is based on the use of measurement instrumentation employing a resolution bandwidth of 1 MHz or greater. However, in the 1 MHz bands immediately outside and adjacent to the frequency block a resolution bandwidth of at least one percent of the emission bandwidth of the fundamental emission of the transmitter may be employed. A narrower resolution bandwidth is permitted in all cases to improve measurement accuracy provided the measured power is integrated over the full required measurement bandwidth (i.e. 1 MHz or 1 percent of emission bandwidth, as specified). The emission bandwidth is defined as the width of the signal between two points, one below the carrier center frequency and one above the carrier center frequency, outside of which all emissions are attenuated at least 26 dB below the transmitter power.

(c) Licensees in this service may establish an alternative out of band emission limit to be used at specified band edge(s) in specified geographical areas [...].

(d) If any emission from a transmitter operating in this service results in interference to users of another radio service, the FCC may require a greater attenuation of that emission than specified in this section.

For reporting only spurious emission levels reaching to the 20dB margin to limit were noted.

---

Field strength of spurious radiation

---

Standard: FCC Part 24, Subpart E

The test was performed according to: FCC §2.1053

## Test Description

1) The EUT was placed inside an anechoic chamber. Refer to chapter "Setup Drawings". The EUT was coupled to a Digital Communication Tester which was located outside the chamber via a small signalling antenna.

2) A call was established on a Traffic Channel between the EUT and the Digital Communication Tester.

Important Settings:

- Output Power: Maximum

- Channel: please refer to the detailed results

3) A pre-calibration procedure is used so that the readings from the spectrum analyser are corrected and represent directly the equivalent radiated power (related to a  $\lambda/2$  dipole).

- 4) All spurious radiation measurements were made with spectrum analyser and the appropriate calibrated antennas for the frequency range of 30 MHz to 20 GHz (up to the 10th harmonic of the transmit frequency). The frequency range from 9 kHz to 30 MHz has been examined during the conducted spurious emission measurements.
- 5) Important Analyser Settings  
- [Resolution Bandwidth / Video Bandwidth]:  
a) [3 kHz / 10 kHz] in the Span of 1 MHz directly below and above the Band,  
b) [10 kHz / 30 kHz] in case the curve of the analyser IF-Filter leads to an exceeding of the limit, in this case a worst case correction factor of 20 dB (1 MHz -> 10 kHz) was used  
c) [1 MHz / 3 MHz] otherwise  
- Sweep Time: depending on the transmitting signal, the span and the resolution bandwidth
- 6) The spurious emissions peaks were measured in both vertical and horizontal antenna polarisation during the call is established on the lowest channel, mid channel and on the highest channel. To find the worst case peaks all orientations (X, Y, Z) of the EUT have been measured.
- 7) After this initial test, a final test according to TIA-603-C 2.2.12 Unwanted Emissions is performed on signals which are identified as being close to the limit. For any emissions found to be within 10 dB of the limit, a specific signal substitution measurement is performed at the frequency of the emission to determine the exact e.i.r.p. value.

#### Test Requirements / Limits

##### § 2.1053 Measurements required: Field strength of spurious radiation.

Measurements shall be made to detect spurious emissions that may be radiated directly from the cabinet, control circuits, power leads, or intermediate circuit elements under normal conditions of installation and operation. Curves or equivalent data shall be supplied showing the magnitude of each harmonic and other spurious emission. For this test, single sideband, independent sideband, and controlled carrier transmitters shall be modulated under the conditions specified in paragraph (c) of Sec. 2.1049, as appropriate. For equipment operating on frequencies below 890 MHz, an open field test is normally required, with the measuring instrument antenna located in the far-field at all test frequencies. In the event it is either impractical or impossible to make open field measurements (e.g. a broadcast transmitter installed in a building) measurements will be accepted of the equipment as installed. Such measurements must be accompanied by a description of the site where the measurements were made showing the location of any possible source of reflections which might distort the field strength measurements. Information submitted shall include the relative radiated power of each spurious emission with reference to the rated power output of the transmitter, assuming all emissions are radiated from halfwave dipole antennas.

- (b) The measurements specified in paragraph (a) of this section shall be made for the following equipment:  
(2) All equipment operating on frequencies higher than 25 MHz.

##### § 2.1057 Frequency spectrum to be investigated.

(a) In all of the measurements set forth in Secs. 2.1051 and 2.1053, the spectrum shall be investigated from the lowest radio frequency signal generated in the equipment, without going below 9 kHz, up to at least the frequency shown below:

- (1) If the equipment operates below 10 GHz: to the tenth harmonic of the highest fundamental frequency or to 40 GHz, whichever is lower.  
(b) Particular attention should be paid to harmonics and subharmonics of the carrier frequency as well as to those frequencies removed from the carrier by multiples of the oscillator frequency. Radiation at the frequencies of multiplier stages should also be checked.  
(c) The amplitude of spurious emissions which are attenuated more than 20 dB below the permissible value need not be reported.  
(d) Unless otherwise specified, measurements above 40 GHz shall be performed using a minimum resolution bandwidth of 1 MHz.

##### § 24.238 Emission limitations for Broadband PCS equipment

(a) The power of any emission outside of the authorized operating frequency ranges must be attenuated below the transmitting power (P) by a factor of at least  $43 + 10 \log(P)$  dB. This is calculated to be -13 dBm (effective radiated power) which corresponds to 84.6 dBµV/m (field strength) in a distance of 3 m.

(b) Compliance with these rules is based on the use of measurement instrumentation employing a resolution bandwidth of 1 MHz or greater. However, in the 1 MHz bands immediately outside and adjacent to the frequency block a resolution bandwidth of at least one percent of the emission bandwidth of the fundamental emission of the transmitter may be employed. A narrower resolution bandwidth is permitted in all cases to improve measurement accuracy provided the measured power is integrated over the full required measurement bandwidth (i.e. 1 MHz or 1 percent of emission bandwidth, as specified). The emission bandwidth is defined as the width of the signal between two points, one below the carrier center frequency and one above the carrier center frequency, outside of which all emissions are attenuated at least 26 dB below

the transmitter power.

(c) Licensees in this service may establish an alternative out of band emission limit to be used at specified band edge(s) in specified geographical areas [...].

(d) If any emission from a transmitter operating in this service results in interference to users of another radio service, the FCC may require a greater attenuation of that emission than specified in this section.

For reporting only spurious emission levels reaching to the 20dB margin to limit were noted.

---

Frequency stability

---

Standard: FCC Part 24, Subpart E

The test was performed according to FCC §2.1055

#### Test Description

- 1) The EUT was placed inside a temperature chamber.
  - 2) The EUT was coupled to a Digital Communication Tester. Refer to chapter "Setup Drawings".
  - 3) The climatic chamber was cycled down/up to a certain temperature, starting with the EUT minimum temperature.
  - 4) After the temperature was stabilized the EUT was switched on and a call was established on a Traffic Channel between the EUT and the Digital Communication Tester.
- Important Settings:
- Output Power: Maximum
  - Mid Channel
- 5) The frequency error of the EUT was recorded by using an internal measurement function of the Digital Communication Tester immediately after the call was established, five minutes after the call was established and ten minutes after the call was established.
  - 6) This measurement procedure was performed for temperature variation from  $-30^{\circ}\text{C}$  to  $+50^{\circ}\text{C}$  in increments of  $10^{\circ}\text{C}$ , if not otherwise stated in the detailed results.
- When the EUT did not operate at certain temperature levels, these measurements were left out.

#### Test Requirements / Limits

§2.1055 Measurements required: Frequency stability

- (a) The frequency stability shall be measured with variation of ambient temperature as follows:
- (1) From  $-30^{\circ}$  to  $+50^{\circ}$  centigrade for all equipment except that specified in paragraphs (a) (2) and (3) of this section.
  - (b) Frequency measurements shall be made at the extremes of the specified temperature range and at intervals of not more than  $10^{\circ}$  centigrade through the range. A period of time sufficient to stabilize all of the components of the oscillator circuit at each temperature level shall be allowed prior to frequency measurement. The short term transient effects on the frequency of the transmitter due to keying (except for broadcast transmitters) and any heating element cycling normally occurring at each ambient temperature level also shall be shown. Only the portion or portions of the transmitter containing the frequency determining and stabilizing circuitry need be subjected to the temperature variation test.
  - (d) The frequency stability shall be measured with variation of primary supply voltage as follows:
    - (1) Vary primary supply voltage from 85 to 115 percent of the nominal value for other than hand carried battery equipment.
    - (2) For hand carried, battery powered equipment, reduce primary supply voltage to the battery operating end point which shall be specified by the manufacturer.
    - (3) The supply voltage shall be measured at the input to the cable normally provided with the equipment, or at the power supply terminals if cables are not normally provided. Effects on frequency of transmitter keying (except for broadcast transmitters) and any heating element cycling at the nominal supply voltage and at each extreme also shall be shown.

#### §24.235 Frequency stability

The frequency stability shall be sufficient to ensure that the fundamental emission stays within the authorized frequency block.

7Layers interpretation of limit:



To ensure that the frequency stability shall be sufficient to ensure that the fundamental emission stays within the authorized frequency block following limit was used:

+/- 2.5 ppm = 4700 Hz for a frequency of 1880.0 MHz

in accordance with FCC Part 22, Subpart H, §22.355, table C-1: Frequency tolerance for the carrier frequency of mobile transmitters in the Public Mobile Service in the frequency range 821 to 896 MHz.

---

Band edge compliance

---

Standard: FCC Part 24, Subpart E

The test was performed according to: FCC §24.238

#### Test Description

- 1) The EUT was coupled to a Spectrum Analyser and a Digital Communication Tester through a Power Divider. Refer to chapter "Setup Drawings".
- 2) The total insertion losses for signal path 1 and signal path 2 were measured. The values were used to correct the readings from the Spectrum Analyser and the Digital Communication Tester.
- 3) A call was established on a Traffic Channel between the EUT and the Digital Communication Tester.

#### Important Settings:

- Output Power: Maximum
  - Channel: please refer to the detailed results
- 4) Important Analyser Settings:
    - Resolution Bandwidth = Video Bandwidth: >1% of the manufacturer's stated occupied bandwidth

#### Test Requirements / Limits

§ 24.238 Effective radiated power limits

Refer to chapter "Field strength of spurious radiation".

Summary of Test Results

---

---

The EUT complied with all performed tests as listed in the summary section of this report.

---

Technical Report Summary

---

---

Type of Authorization :

Certification for a GSM/WCDMA/CDMA2000 cellular radiotelephone device

Applicable FCC Rules

Prepared in accordance with the requirements of FCC Rules and Regulations as listed in 47 CFR Ch.1 Parts 0 to 69. The following subparts are applicable to the results in this test report.

Part 2, Subpart J - Equipment Authorization Procedures, Certification

- § 2.1046 Measurement required: RF power output
- § 2.1049 Measurement required: Occupied bandwidth
- § 2.1051 Measurement required: Spurious emissions at antenna terminals
- § 2.1053 Measurement required: Field strength of spurious radiation
- § 2.1055 Measurement required: Frequency stability
- § 2.1057 Frequency spectrum to be investigated

Part 22, Subpart C – Operational and Technical Requirements

- § 22.355 Frequency tolerance

Part 22, Subpart H – Cellular Radiotelephone Service

- § 22.913 Effective radiated power limits
- § 22.917 Emission limitations for cellular equipment

additional documents

ANSI TIA-603-C-2004

Description of Methods of Measurements

---

---

RF Power Output

---

Standard    FCC Part 22, Subpart H

The test was performed according to: FCC §2.1046

Test Description (conducted measurement procedure)

- 1) The EUT was coupled to a Spectrum Analyser and a Digital Communication Tester through a Power Divider. Refer to chapter "Setup Drawings".
  - 2) The total insertion losses for signal path 1 and signal path 2 were measured. The values were used to correct the readings from the Spectrum Analyser and the Digital Communication Tester.
  - 3) A call was established on a Traffic Channel between the EUT and the Digital Communication Tester.
- Important Settings:
- Channel (Frequency): please refer to the detailed results
- 4) The transmitted power of the EUT was recorded by using a spectrum analyser.

Test Description (radiated measurement procedure)

- 1) The EUT was placed inside an anechoic chamber. Refer to chapter "Setup Drawings". The EUT was coupled to a Digital Communication Tester which was located outside the chamber via a small signalling antenna.
  - 2) A call was established on a Traffic Channel between the EUT and the Digital Communication Tester.
- Important Settings:
- Output Power: Maximum
  - Channel: please refer to the detailed results
- 3) A substitution procedure is used so that the readings from the spectrum analyser are corrected and represent directly the equivalent radiated power (related to a  $\lambda/2$  dipole).
  - 4) The output power was measured in both vertical and horizontal antenna polarisation during the call is established on the lowest channel, mid channel and on the highest channel. To find the worst case power all orientations (X, Y, Z) of the EUT have been measured.
  - 5) The test procedure according to TIA-603-C-2004 has been considered.

Test Requirements / Limits

§2.1046 Measurements Required: RF Power Output

(a) For transmitters other than single sideband, independent sideband and controlled carrier radiotelephone, power output shall be measured at the RF output terminals when the transmitter is adjusted in accordance with the tune-up procedure to give the values of current and voltage on the circuit elements specified in § 2.1033(c)(8). The electrical characteristics of the output terminals when this test is made shall be stated.

§22.913 Effective radiated power limits

(a)(2) Maximum ERP. ... The ERP of mobile transmitters and auxiliary test transmitters must not exceed 7 Watts.

---

Emission and Occupied Bandwidth

---

Standard FCC Part 22, Subpart H

The test was performed according to: FCC §2.1049

Test Description

- 1) The EUT was coupled to a Spectrum Analyser and a Digital Communication Tester through a Power Divider. Refer to chapter "Setup Drawings".
  - 2) The total insertion losses for signal path 1 and signal path 2 were measured. The values were used to correct the readings from the Spectrum Analyser and the Digital Communication Tester.
  - 3) A call was established on a Traffic Channel between the EUT and the Digital Communication Tester.
- Important Settings:
- Output Power: Maximum
  - Channel: please refer to the detailed results
- 4) Important Analyser Settings:
    - Resolution Bandwidth: >1% of the manufacturer's stated occupied bandwidth
  - 5) The maximum spectral level of the modulated signal was recorded as the reference.
  - 6) The emission bandwidth is measured as follows:  
the two furthest frequencies above and below the frequency of the maximum reference level where the spectrum is -26 dB down have to be found.
  - 7) The occupied bandwidth (99% Bandwidth) is measured as follows:  
the occupied bandwidth, that is the frequency bandwidth such that, below its lower and above its upper frequency limits, the mean powers are each equal to 0.5 percent of the total mean power.

#### Test Requirements / Limits

##### § 2.1049 Measurements required: Occupied bandwidth

The occupied bandwidth, that is the frequency bandwidth such that, below its lower and above its upper frequency limits, the mean powers radiated are each equal to 0.5 percent of the total mean power radiated by a given emission shall be measured under the following conditions (as applicable):

(h) Transmitters employing digital modulation techniques - when modulated by an input signal such that its amplitude and symbol rate represent the maximum rated conditions under which the equipment will be operated. The signal shall be applied through any filter networks, pseudo-random generators or other devices required in normal service. Additionally, the occupied bandwidth shall be shown for operation with any devices used for modifying the spectrum when such devices are optional at the discretion of the user.

---

#### Spurious emissions at antenna terminals

---

Standard FCC Part 22, Subpart H

The test was performed according to FCC §2.1051

#### Test Description

- 1) The EUT was coupled to a Spectrum Analyser and a Digital Communication Tester through a Power Divider. Refer to chapter "Setup Drawings".
- 2) The total insertion losses for signal path 1 and signal path 2 were measured. The values were used to correct the readings from the Spectrum Analyser and the Digital Communication Tester.
- 3) A call was established on a Traffic Channel between the EUT and the Digital Communication Tester.  
Important Settings:
  - Output Power: Maximum
  - Channel: please refer to the detailed results
- 4) Important Analyser Settings
  - [Resolution Bandwidth]:
    - a) [ $\geq 1\%$  of wanted signal bandwidth] in the Span of 1 MHz directly below and above the PCS-Band,
    - b) otherwise [100 kHz] (or [1 MHz] for accelerated sweep times)
    - c) [reduced resolution bandwidth] in case the curve of the analyser IF-Filter or the wanted EUT signal leads to an exceeding of the limit, in this case a correction factor was used
  - Sweep Time: depending on the transmitting signal, the span and the resolution bandwidth
- 5) The spurious emissions peaks were measured in the frequency range from 9 kHz to 10 GHz (up to the 10th harmonic) during the call was established

#### Test Requirements / Limits

##### § 2.1051 Spurious emissions at antenna terminals

The radio frequency voltage or power generated within the equipment and appearing on a spurious frequency shall be checked at the equipment output terminals when properly loaded with a suitable artificial antenna. Curves or equivalent data shall show the magnitude of each harmonic and other spurious emission that can be detected when the equipment is operated under the conditions specified in Sec. 2.1049 as appropriate. The magnitude of spurious emissions which are attenuated more than 20 dB below the permissible value need not be specified.

##### § 2.1057 Frequency spectrum to be investigated.

- (a) In all of the measurements set forth in Secs. 2.1051 and 2.1053, the spectrum shall be investigated from the lowest radio frequency signal generated in the equipment, without going below 9 kHz, up to at least the frequency shown below:
- (1) If the equipment operates below 10 GHz: to the tenth harmonic of the highest fundamental frequency or to 40 GHz, whichever is lower.
  - (b) Particular attention should be paid to harmonics and subharmonics of the carrier frequency as well as to those frequencies removed from the carrier by multiples of the oscillator frequency. Radiation at the frequencies of multiplier stages should also be checked.
  - (c) The amplitude of spurious emissions which are attenuated more than 20 dB below the permissible value

need not be reported.

(d) Unless otherwise specified, measurements above 40 GHz shall be performed using a minimum resolution bandwidth of 1 MHz.

#### § 22.917 Emission limitations for cellular equipment

(a) The power of any emission outside of the authorized operating frequency ranges must be attenuated below the transmitting power (P) by a factor of at least  $43 + 10 \log(P)$  dB.

Remark of the test laboratory: This is calculated to be -13 dBm.

(b) Compliance with these rules is based on the use of measurement instrumentation employing a resolution bandwidth of 100 kHz or greater. In the 1 MHz bands immediately outside and adjacent to the frequency block a resolution bandwidth of at least one percent of the emission bandwidth of the fundamental emission of the transmitter may be employed. A narrower resolution bandwidth is permitted in all cases to improve measurement accuracy provided the measured power is integrated over the full required measurement bandwidth (i.e. 100 kHz or 1 percent of emission bandwidth, as specified). The emission bandwidth is defined as the width of the signal between two points, one below the carrier center frequency and one above the carrier center frequency, outside of which all emissions are attenuated at least 26 dB below the transmitter power.

(c) Licensees in this service may establish an alternative out of band emission limit to be used at specified band edge(s) in specified geographical areas [...].

(d) If any emission from a transmitter operating in this service results in interference to users of another radio service, the FCC may require a greater attenuation of that emission than specified in this section.

For reporting only spurious emission levels reaching to the 20dB margin to limit were noted.

---

#### Field strength of spurious radiation

---

Standard FCC Part 22, Subpart H

The test was performed according to: FCC §2.1053

#### Test Description

1) The EUT was placed inside an anechoic chamber. Refer to chapter "Setup Drawings". The EUT was coupled to a Digital Communication Tester which was located outside the chamber via a small signalling antenna.

2) A call was established on a Traffic Channel between the EUT and the Digital Communication Tester.

Important Settings:

- Output Power: Maximum

- Channel: please refer to the detailed results

3) A pre-calibration procedure is used so that the readings from the spectrum analyser are corrected and represent directly the equivalent radiated power (related to a  $\lambda/2$  dipole).

4) All spurious radiation measurements were made with spectrum analyser and the appropriate calibrated antennas for the frequency range of 30 MHz to 10 GHz (up to the 10th harmonic of the transmit frequency). The frequency range from 9 kHz to 30 MHz has been examined during the conducted spurious emission measurements.

5) Important Analyser Settings

- [Resolution Bandwidth / Video Bandwidth]:

a) [3 kHz / 10 kHz] in the Span of 1 MHz directly below and above the Band,

b) [10 kHz / 30 kHz] in case the curve of the analyser IF-Filter leads to an exceeding of the limit, in this case a worst case correction factor of 20 dB (1 MHz -> 10 kHz) was used

c) [1 MHz / 3 MHz] otherwise

- Sweep Time: depending on the transmitting signal, the span and the resolution bandwidth

6) The spurious emissions peaks were measured in both vertical and horizontal antenna polarization during the call is established on the lowest channel, mid channel and on the highest channel. To find the worst case peaks all orientations (X, Y, Z) of the EUT have been measured.

7) After this initial test, a final test according to TIA-603-C 2.2.12 Unwanted Emissions is performed on signals which are identified as being close to the limit. For any emissions found to be within 10 dB of the limit, a specific signal substitution measurement is performed at the frequency of the emission to determine the exact e.i.r.p. value.

#### Test Requirements / Limits

§ 2.1053 Measurements required: Field strength of spurious radiation.

Measurements shall be made to detect spurious emissions that may be radiated directly from the cabinet, control circuits, power leads, or intermediate circuit elements under normal conditions of installation and operation. Curves or equivalent data shall be supplied showing the magnitude of each harmonic and other spurious emission. For this test, single sideband, independent sideband, and controlled carrier transmitters shall be modulated under the conditions specified in paragraph (c) of Sec. 2.1049, as appropriate. For equipment operating on frequencies below 890 MHz, an open field test is normally required, with the measuring instrument antenna located in the far-field at all test frequencies. In the event it is either impractical or impossible to make open field measurements (e.g. a broadcast transmitter installed in a building) measurements will be accepted of the equipment as installed. Such measurements must be accompanied by a description of the site where the measurements were made showing the location of any possible source of reflections which might distort the field strength measurements. Information submitted shall include the relative radiated power of each spurious emission with reference to the rated power output of the transmitter, assuming all emissions are radiated from halfwave dipole antennas.

- (b) The measurements specified in paragraph (a) of this section shall be made for the following equipment:  
(2) All equipment operating on frequencies higher than 25 MHz.

#### § 2.1057 Frequency spectrum to be investigated.

(a) In all of the measurements set forth in Secs. 2.1051 and 2.1053, the spectrum shall be investigated from the lowest radio frequency signal generated in the equipment, without going below 9 kHz, up to at least the frequency shown below:

(1) If the equipment operates below 10 GHz: to the tenth harmonic of the highest fundamental frequency or to 40 GHz, whichever is lower.

(b) Particular attention should be paid to harmonics and subharmonics of the carrier frequency as well as to those frequencies removed from the carrier by multiples of the oscillator frequency. Radiation at the frequencies of multiplier stages should also be checked.

(c) The amplitude of spurious emissions which are attenuated more than 20 dB below the permissible value need not be reported.

(d) Unless otherwise specified, measurements above 40 GHz shall be performed using a minimum resolution bandwidth of 1 MHz.

#### § 22.917 Emission limitations for cellular equipment

(a) The power of any emission outside of the authorized operating frequency ranges must be attenuated below the transmitting power (P) by a factor of at least  $43 + 10 \log(P)$  dB.

This is calculated to be -13 dBm (effective radiated power) which corresponds to 84.6 dB $\mu$ V/m (field strength) in a distance of 3 m.

(b) Compliance with these rules is based on the use of measurement instrumentation employing a resolution bandwidth of 100 kHz or greater. In the 1 MHz bands immediately outside and adjacent to the frequency block a resolution bandwidth of at least one percent of the emission bandwidth of the fundamental emission of the transmitter may be employed. A narrower resolution bandwidth is permitted in all cases to improve measurement accuracy provided the measured power is integrated over the full required measurement bandwidth (i.e. 100 kHz or 1 percent of emission bandwidth, as specified). The emission bandwidth is defined as the width of the signal between two points, one below the carrier center frequency and one above the carrier center frequency, outside of which all emissions are attenuated at least 26 dB below the transmitter power.

(c) Licensees in this service may establish an alternative out of band emission limit to be used at specified band edge(s) in specified geographical areas [...].

(d) If any emission from a transmitter operating in this service results in interference to users of another radio service, the FCC may require a greater attenuation of that emission than specified in this section.

For reporting only spurious emission levels reaching to the 20dB margin to limit were noted.

\_\_\_\_\_

Frequency stability

\_\_\_\_\_

Standard    FCC Part 22, Subpart H

The test was performed according to FCC §2.1055

#### Test Description

- 1) The EUT was placed inside a temperature chamber.
- 2) The EUT was coupled to a Digital Communication Tester. Refer to chapter "Setup Drawings".

- 3) The climatic chamber was cycled down/up to a certain temperature, starting with the EUT minimum temperature.
- 4) After the temperature was stabilized the EUT was switched on and a call was established on a Traffic Channel between the EUT and the Digital Communication Tester.  
Important Settings:  
- Output Power: Maximum  
- Mid Channel
- 5) The frequency error of the EUT was recorded by using an internal measurement function of the Digital Communication Tester immediately after the call was established, five minutes after the call was established and ten minutes after the call was established.
- 6) This measurement procedure was performed for temperature variation from -30°C to +50°C in increments of 10°C, if not otherwise stated in the detailed results.  
When the EUT did not operate at certain temperature levels, these measurements were left out.

#### Test Requirements / Limits

##### §2.1055 Measurements required: Frequency stability

- (a) The frequency stability shall be measured with variation of ambient temperature as follows:
- (1) From -30° to +50° centigrade for all equipment except that specified in paragraphs (a) (2) and (3) of this section.
  - (b) Frequency measurements shall be made at the extremes of the specified temperature range and at intervals of not more than 10° centigrade through the range. A period of time sufficient to stabilize all of the components of the oscillator circuit at each temperature level shall be allowed prior to frequency measurement. The short term transient effects on the frequency of the transmitter due to keying (except for broadcast transmitters) and any heating element cycling normally occurring at each ambient temperature level also shall be shown. Only the portion or portions of the transmitter containing the frequency determining and stabilizing circuitry need be subjected to the temperature variation test.
  - (d) The frequency stability shall be measured with variation of primary supply voltage as follows:
    - (1) Vary primary supply voltage from 85 to 115 percent of the nominal value for other than hand carried battery equipment.
    - (2) For hand carried, battery powered equipment, reduce primary supply voltage to the battery operating end point which shall be specified by the manufacturer.
    - (3) The supply voltage shall be measured at the input to the cable normally provided with the equipment, or at the power supply terminals if cables are not normally provided. Effects on frequency of transmitter keying (except for broadcast transmitters) and any heating element cycling at the nominal supply voltage and at each extreme also shall be shown.

##### §22.355 Frequency tolerance

...the carrier frequency of each transmitter in the Public Mobile Service must be maintained within the tolerances given in table C-1 of this section.

Frequency range (MHz)	Base, fixed (ppm)	Mobile up to 3 watts (ppm)	Mobile above 3 watts (ppm)
25 to 50	20.0	20.0	50.0
50 to 450	5.0	5.0	50.0
450 to 512	2.5	5.0	5.0
821 to 896	1.5	2.5	2.5
928 to 929	5.0	n/a	n/a
929 to 960	1.5	n/a	n/a
2110 to 2220	10.0	n/a	n/a

channel (836.6 MHz) the frequency tolerance is 2.5 ppm (2091.5 Hz).

#### Band edge compliance

Standard FCC Part 22, Subpart H

The test was performed according to: FCC §22.913

#### Test Description

- 1) The EUT was coupled to a Spectrum Analyser and a Digital Communication Tester through a Power Divider.

Refer to chapter "Setup Drawings".

2) The total insertion losses for signal path 1 and signal path 2 were measured. The values were used to correct the readings from the Spectrum Analyser and the Digital Communication Tester.

3) A call was established on a Traffic Channel between the EUT and the Digital Communication Tester.

Important Settings:

- Output Power: Maximum
- Channel: please refer to the detailed results

4) Important Analyser Settings:

- Resolution Bandwidth = Video Bandwidth: >1% of the manufacturer's stated occupied bandwidth

Test Requirements / Limits

§ 22.917 Emission limitations for cellular equipment

Refer to chapter "Field strength of spurious radiation".

Summary of Test Results

---

---

The EUT complied with all performed tests as listed in the summary section of this report.

---

Technical Report Summary

---

---

Type of Authorization :

Certification for a GSM/WCDMA/CDMA2000 cellular radiotelephone device

Applicable FCC Rules

Prepared in accordance with the requirements of FCC Rules and Regulations as listed in 47 CFR Ch.1 Parts 0 to 69. The following subparts are applicable to the results in this test report.

Part 2, Subpart J - Equipment Authorization Procedures, Certification

- § 2.1046 Measurement required: RF power output
- § 2.1049 Measurement required: Occupied bandwidth
- § 2.1051 Measurement required: Spurious emissions at antenna terminals
- § 2.1053 Measurement required: Field strength of spurious radiation
- § 2.1055 Measurement required: Frequency stability
- § 2.1057 Frequency spectrum to be investigated

Part 24, Subpart E - Broadband PCS

- § 24.232 Power and antenna height limits
- § 24.235 Frequency stability
- § 24.236 Field strength limits
- § 24.238 Emission limitations for Broadband PCS equipment

additional documents



ANSI TIA-603-C-2004

Description of Methods of Measurements

---

---

RF Power Output

---

Standard: FCC Part 24, Subpart E

The test was performed according to: FCC §2.1046

Test Description (conducted measurement procedure)

- 1) The EUT was coupled to a Spectrum Analyser and a Digital Communication Tester through a Power Divider. Refer to chapter "Setup Drawings".
- 2) The total insertion losses for signal path 1 and signal path 2 were measured. The values were used to correct the readings from the Spectrum Analyser and the Digital Communication Tester.
- 3) A call was established on a Traffic Channel between the EUT and the Digital Communication Tester.  
Important Settings:
  - Channel (Frequency): please refer to the detailed results
- 4) The transmitted power of the EUT was recorded by using a spectrum analyser.

Test Description (radiated measurement procedure)

- 1) The EUT was placed inside an anechoic chamber. Refer to chapter "Setup Drawings". The EUT was coupled to a Digital Communication Tester which was located outside the chamber via a small signalling antenna.
- 2) A call was established on a Traffic Channel between the EUT and the Digital Communication Tester.  
Important Settings:
  - Output Power: Maximum
  - Channel: please refer to the detailed results
- 3) A substitution procedure is used so that the readings from the spectrum analyser are corrected and represent directly the equivalent radiated power (related to a  $\lambda/2$  dipole).
- 4) The output power was measured in both vertical and horizontal antenna polarisation during the call is established on the lowest channel, mid channel and on the highest channel. To find the worst case power all orientations (X, Y, Z) of the EUT have been measured.
- 5) The test procedure according to TIA-603-C-2004 has been considered.

Test Requirements / Limits

§2.1046 Measurements Required: RF Power Output

(a) For transmitters other than single sideband, independent sideband and controlled carrier radiotelephone, power output shall be measured at the RF output terminals when the transmitter is adjusted in accordance with the tune-up procedure to give the values of current and voltage on the circuit elements specified in § 2.1033(c)(8). The electrical characteristics of the output terminals when this test is made shall be stated.

§24.232 Power and antenna height limits

(c) Mobile/portable stations are limited to 2 watts EIRP peak power and the equipment must employ means to limit the power to the minimum necessary for successful communications.

(e) Peak transmit power must be measured over any interval of continuous transmission using instrumentation calibrated in terms of an rms-equivalent voltage. The measurement results shall be properly adjusted for any instrument limitations, such as detector response times, limited resolution bandwidth capability when compared to the emission bandwidth, sensitivity, etc., so as to obtain a true peak measurement for the emission in question over the full bandwidth of the channel.

---

Emission and Occupied Bandwidth

---

Standard: FCC Part 24, Subpart E

The test was performed according to: FCC §2.1049

#### Test Description

- 1) The EUT was coupled to a Spectrum Analyser and a Digital Communication Tester through a Power Divider. Refer to chapter "Setup Drawings".
  - 2) The total insertion losses for signal path 1 and signal path 2 were measured. The values were used to correct the readings from the Spectrum Analyser and the Digital Communication Tester.
  - 3) A call was established on a Traffic Channel between the EUT and the Digital Communication Tester.
- Important Settings:
- Output Power: Maximum
  - Channel: please refer to the detailed results
- 4) Important Analyser Settings:
    - Resolution Bandwidth: >1% of the manufacturer's stated occupied bandwidth
  - 5) The maximum spectral level of the modulated signal was recorded as the reference.
  - 6) The emission bandwidth is measured as follows:  
the two furthest frequencies above and below the frequency of the maximum reference level where the spectrum is -26 dB down have to be found.
  - 7) The occupied bandwidth (99% Bandwidth) is measured as follows:  
the occupied bandwidth, that is the frequency bandwidth such that, below its lower and above its upper frequency limits, the mean powers are each equal to 0.5 percent of the total mean power.

#### Test Requirements / Limits

§ 2.1049 Measurements required: Occupied bandwidth

The occupied bandwidth, that is the frequency bandwidth such that, below its lower and above its upper frequency limits, the mean powers radiated are each equal to 0.5 percent of the total mean power radiated by a given emission shall be measured under the following conditions (as applicable):

(h) Transmitters employing digital modulation techniques - when modulated by an input signal such that its amplitude and symbol rate represent the maximum rated conditions under which the equipment will be operated. The signal shall be applied through any filter networks, pseudo-random generators or other devices required in normal service. Additionally, the occupied bandwidth shall be shown for operation with any devices used for modifying the spectrum when such devices are optional at the discretion of the user.

---

#### Spurious emissions at antenna terminals

---

Standard: FCC Part 24, Subpart E

The test was performed according to FCC §2.1051

#### Test Description

- 1) The EUT was coupled to a Spectrum Analyser and a Digital Communication Tester through a Power Divider. Refer to chapter "Setup Drawings".
  - 2) The total insertion losses for signal path 1 and signal path 2 were measured. The values were used to correct the readings from the Spectrum Analyser and the Digital Communication Tester.
  - 3) A call was established on a Traffic Channel between the EUT and the Digital Communication Tester.
- Important Settings:
- Output Power: Maximum
  - Channel: please refer to the detailed results
- 4) Important Analyser Settings:
    - [Resolution Bandwidth]:
      - a) [ $\geq 1\%$  of wanted signal bandwidth] in the Span of 1 MHz directly below and above the Band,
      - b) otherwise [1 MHz]
      - c) [reduced resolution bandwidth] in case the curve of the analyser IF-Filter or the wanted EUT signal leads to an exceeding of the limit, in this case a correction factor was used
    - Sweep Time: depending on the transmitting signal, the span and the resolution bandwidth
  - 5) The spurious emissions peaks were measured in the frequency range from 9 kHz to 20 GHz (up to the 10th harmonic) during the call was established

## Test Requirements / Limits

### § 2.1051 Spurious emissions at antenna terminals

The radio frequency voltage or power generated within the equipment and appearing on a spurious frequency shall be checked at the equipment output terminals when properly loaded with a suitable artificial antenna. Curves or equivalent data shall show the magnitude of each harmonic and other spurious emission that can be detected when the equipment is operated under the conditions specified in Sec. 2.1049 as appropriate. The magnitude of spurious emissions which are attenuated more than 20 dB below the permissible value need not be specified.

### § 2.1057 Frequency spectrum to be investigated.

(a) In all of the measurements set forth in Secs. 2.1051 and 2.1053, the spectrum shall be investigated from the lowest radio frequency signal generated in the equipment, without going below 9 kHz, up to at least the frequency shown below:

(1) If the equipment operates below 10 GHz: to the tenth harmonic of the highest fundamental frequency or to 40 GHz, whichever is lower.

(b) Particular attention should be paid to harmonics and subharmonics of the carrier frequency as well as to those frequencies removed from the carrier by multiples of the oscillator frequency. Radiation at the frequencies of multiplier stages should also be checked.

(c) The amplitude of spurious emissions which are attenuated more than 20 dB below the permissible value need not be reported.

(d) Unless otherwise specified, measurements above 40 GHz shall be performed using a minimum resolution bandwidth of 1 MHz.

### § 24.238 Emission limitations for Broadband PCS equipment

(a) The power of any emission outside of the authorized operating frequency ranges must be attenuated below the transmitting power (P) by a factor of at least  $43 + 10 \log(P)$  dB.

Remark of the test laboratory: This is calculated to be -13 dBm.

(b) Compliance with these rules is based on the use of measurement instrumentation employing a resolution bandwidth of 1 MHz or greater. However, in the 1 MHz bands immediately outside and adjacent to the frequency block a resolution bandwidth of at least one percent of the emission bandwidth of the fundamental emission of the transmitter may be employed. A narrower resolution bandwidth is permitted in all cases to improve measurement accuracy provided the measured power is integrated over the full required measurement bandwidth (i.e. 1 MHz or 1 percent of emission bandwidth, as specified). The emission bandwidth is defined as the width of the signal between two points, one below the carrier center frequency and one above the carrier center frequency, outside of which all emissions are attenuated at least 26 dB below the transmitter power.

(c) Licensees in this service may establish an alternative out of band emission limit to be used at specified band edge(s) in specified geographical areas [...].

(d) If any emission from a transmitter operating in this service results in interference to users of another radio service, the FCC may require a greater attenuation of that emission than specified in this section.

For reporting only spurious emission levels reaching to the 20dB margin to limit were noted.

---

Field strength of spurious radiation

---

Standard: FCC Part 24, Subpart E

The test was performed according to: FCC §2.1053

## Test Description

1) The EUT was placed inside an anechoic chamber. Refer to chapter "Setup Drawings". The EUT was coupled to a Digital Communication Tester which was located outside the chamber via a small signalling antenna.

2) A call was established on a Traffic Channel between the EUT and the Digital Communication Tester.

Important Settings:

- Output Power: Maximum

- Channel: please refer to the detailed results

3) A pre-calibration procedure is used so that the readings from the spectrum analyser are corrected and represent directly the equivalent radiated power (related to a  $\lambda/2$  dipole).

- 4) All spurious radiation measurements were made with spectrum analyser and the appropriate calibrated antennas for the frequency range of 30 MHz to 20 GHz (up to the 10th harmonic of the transmit frequency). The frequency range from 9 kHz to 30 MHz has been examined during the conducted spurious emission measurements.
- 5) Important Analyser Settings  
- [Resolution Bandwidth / Video Bandwidth]:  
a) [3 kHz / 10 kHz] in the Span of 1 MHz directly below and above the Band,  
b) [10 kHz / 30 kHz] in case the curve of the analyser IF-Filter leads to an exceeding of the limit, in this case a worst case correction factor of 20 dB (1 MHz -> 10 kHz) was used  
c) [1 MHz / 3 MHz] otherwise  
- Sweep Time: depending on the transmitting signal, the span and the resolution bandwidth
- 6) The spurious emissions peaks were measured in both vertical and horizontal antenna polarisation during the call is established on the lowest channel, mid channel and on the highest channel. To find the worst case peaks all orientations (X, Y, Z) of the EUT have been measured.
- 7) After this initial test, a final test according to TIA-603-C 2.2.12 Unwanted Emissions is performed on signals which are identified as being close to the limit. For any emissions found to be within 10 dB of the limit, a specific signal substitution measurement is performed at the frequency of the emission to determine the exact e.i.r.p. value.

#### Test Requirements / Limits

##### § 2.1053 Measurements required: Field strength of spurious radiation.

Measurements shall be made to detect spurious emissions that may be radiated directly from the cabinet, control circuits, power leads, or intermediate circuit elements under normal conditions of installation and operation. Curves or equivalent data shall be supplied showing the magnitude of each harmonic and other spurious emission. For this test, single sideband, independent sideband, and controlled carrier transmitters shall be modulated under the conditions specified in paragraph (c) of Sec. 2.1049, as appropriate. For equipment operating on frequencies below 890 MHz, an open field test is normally required, with the measuring instrument antenna located in the far-field at all test frequencies. In the event it is either impractical or impossible to make open field measurements (e.g. a broadcast transmitter installed in a building) measurements will be accepted of the equipment as installed. Such measurements must be accompanied by a description of the site where the measurements were made showing the location of any possible source of reflections which might distort the field strength measurements. Information submitted shall include the relative radiated power of each spurious emission with reference to the rated power output of the transmitter, assuming all emissions are radiated from halfwave dipole antennas.

- (b) The measurements specified in paragraph (a) of this section shall be made for the following equipment:  
(2) All equipment operating on frequencies higher than 25 MHz.

##### § 2.1057 Frequency spectrum to be investigated.

(a) In all of the measurements set forth in Secs. 2.1051 and 2.1053, the spectrum shall be investigated from the lowest radio frequency signal generated in the equipment, without going below 9 kHz, up to at least the frequency shown below:

- (1) If the equipment operates below 10 GHz: to the tenth harmonic of the highest fundamental frequency or to 40 GHz, whichever is lower.  
(b) Particular attention should be paid to harmonics and subharmonics of the carrier frequency as well as to those frequencies removed from the carrier by multiples of the oscillator frequency. Radiation at the frequencies of multiplier stages should also be checked.  
(c) The amplitude of spurious emissions which are attenuated more than 20 dB below the permissible value need not be reported.  
(d) Unless otherwise specified, measurements above 40 GHz shall be performed using a minimum resolution bandwidth of 1 MHz.

##### § 24.238 Emission limitations for Broadband PCS equipment

(a) The power of any emission outside of the authorized operating frequency ranges must be attenuated below the transmitting power (P) by a factor of at least  $43 + 10 \log(P)$  dB. This is calculated to be -13 dBm (effective radiated power) which corresponds to 84.6 dBµV/m (field strength) in a distance of 3 m.

(b) Compliance with these rules is based on the use of measurement instrumentation employing a resolution bandwidth of 1 MHz or greater. However, in the 1 MHz bands immediately outside and adjacent to the frequency block a resolution bandwidth of at least one percent of the emission bandwidth of the fundamental emission of the transmitter may be employed. A narrower resolution bandwidth is permitted in all cases to improve measurement accuracy provided the measured power is integrated over the full required measurement bandwidth (i.e. 1 MHz or 1 percent of emission bandwidth, as specified). The emission bandwidth is defined as the width of the signal between two points, one below the carrier center frequency and one above the carrier center frequency, outside of which all emissions are attenuated at least 26 dB below

the transmitter power.

(c) Licensees in this service may establish an alternative out of band emission limit to be used at specified band edge(s) in specified geographical areas [...].

(d) If any emission from a transmitter operating in this service results in interference to users of another radio service, the FCC may require a greater attenuation of that emission than specified in this section.

For reporting only spurious emission levels reaching to the 20dB margin to limit were noted.

---

Frequency stability

---

Standard: FCC Part 24, Subpart E

The test was performed according to FCC §2.1055

#### Test Description

- 1) The EUT was placed inside a temperature chamber.
- 2) The EUT was coupled to a Digital Communication Tester. Refer to chapter "Setup Drawings".
- 3) The climatic chamber was cycled down/up to a certain temperature, starting with the EUT minimum temperature.
- 4) After the temperature was stabilized the EUT was switched on and a call was established on a Traffic Channel between the EUT and the Digital Communication Tester.  
Important Settings:
  - Output Power: Maximum
  - Mid Channel
- 5) The frequency error of the EUT was recorded by using an internal measurement function of the Digital Communication Tester immediately after the call was established, five minutes after the call was established and ten minutes after the call was established.
- 6) This measurement procedure was performed for temperature variation from  $-30^{\circ}\text{C}$  to  $+50^{\circ}\text{C}$  in increments of  $10^{\circ}\text{C}$ , if not otherwise stated in the detailed results.  
When the EUT did not operate at certain temperature levels, these measurements were left out.

#### Test Requirements / Limits

§2.1055 Measurements required: Frequency stability

- (a) The frequency stability shall be measured with variation of ambient temperature as follows:
- (1) From  $-30^{\circ}$  to  $+50^{\circ}$  centigrade for all equipment except that specified in paragraphs (a) (2) and (3) of this section.
  - (b) Frequency measurements shall be made at the extremes of the specified temperature range and at intervals of not more than  $10^{\circ}$  centigrade through the range. A period of time sufficient to stabilize all of the components of the oscillator circuit at each temperature level shall be allowed prior to frequency measurement. The short term transient effects on the frequency of the transmitter due to keying (except for broadcast transmitters) and any heating element cycling normally occurring at each ambient temperature level also shall be shown. Only the portion or portions of the transmitter containing the frequency determining and stabilizing circuitry need be subjected to the temperature variation test.
  - (d) The frequency stability shall be measured with variation of primary supply voltage as follows:
    - (1) Vary primary supply voltage from 85 to 115 percent of the nominal value for other than hand carried battery equipment.
    - (2) For hand carried, battery powered equipment, reduce primary supply voltage to the battery operating end point which shall be specified by the manufacturer.
    - (3) The supply voltage shall be measured at the input to the cable normally provided with the equipment, or at the power supply terminals if cables are not normally provided. Effects on frequency of transmitter keying (except for broadcast transmitters) and any heating element cycling at the nominal supply voltage and at each extreme also shall be shown.

#### §24.235 Frequency stability

The frequency stability shall be sufficient to ensure that the fundamental emission stays within the authorized frequency block.

7Layers interpretation of limit:

To ensure that the frequency stability shall be sufficient to ensure that the fundamental emission stays within the authorized frequency block following limit was used:

+/- 2.5 ppm = 4700 Hz for a frequency of 1880.0 MHz

in accordance with FCC Part 22, Subpart H, §22.355, table C-1: Frequency tolerance for the carrier frequency of mobile transmitters in the Public Mobile Service in the frequency range 821 to 896 MHz.

---

Band edge compliance

---

Standard: FCC Part 24, Subpart E

The test was performed according to: FCC §24.238

#### Test Description

1) The EUT was coupled to a Spectrum Analyser and a Digital Communication Tester through a Power Divider. Refer to chapter "Setup Drawings".

2) The total insertion losses for signal path 1 and signal path 2 were measured. The values were used to correct the readings from the Spectrum Analyser and the Digital Communication Tester.

3) A call was established on a Traffic Channel between the EUT and the Digital Communication Tester.

Important Settings:

- Output Power: Maximum

- Channel: please refer to the detailed results

4) Important Analyser Settings:

- Resolution Bandwidth = Video Bandwidth: >1% of the manufacturer's stated occupied bandwidth

#### Test Requirements / Limits

§ 24.238 Effective radiated power limits

Refer to chapter "Field strength of spurious radiation".

#### Summary of Test Results

---

---

The EUT complied with all performed tests as listed in the summary section of this report.

---

#### Technical Report Summary

---

---

#### Type of Authorization :

Certification for a GSM cellular radiotelephone device

#### Applicable FCC Rules

Prepared in accordance with the requirements of FCC Rules and Regulations as listed in 47 CFR Ch.1 Parts 0 to 69. The following subparts are applicable to the results in this test report.

Part 2, Subpart J - Equipment Authorization Procedures, Certification

- § 2.1046 Measurement required: RF power output
- § 2.1049 Measurement required: Occupied bandwidth
- § 2.1051 Measurement required: Spurious emissions at antenna terminals
- § 2.1053 Measurement required: Field strength of spurious radiation
- § 2.1055 Measurement required: Frequency stability
- § 2.1057 Frequency spectrum to be investigated

Part 27, Subpart C—Technical Standards

- § 27.50 Power and antenna height limits
- § 27.53 Emissions limits
- § 27.54 Frequency stability

additional documents

ANSI TIA-603-C-2004

Description of Methods of Measurements

---

---

RF Power Output

---

Standard FCC Part 27, Subpart C

The test was performed according to: FCC §2.1046

Test Description (conducted measurement procedure)

- 1) The EUT was coupled to a Spectrum Analyser and a Digital Communication Tester through a Power Divider. Refer to chapter "Setup Drawings".
- 2) The total insertion losses for signal path 1 and signal path 2 were measured. The values were used to correct the readings from the Spectrum Analyser and the Digital Communication Tester.
- 3) A call was established on a Traffic Channel between the EUT and the Digital Communication Tester.  
Important Settings:
  - Channel (Frequency): please refer to the detailed results
- 4) The transmitted power of the EUT was recorded by using a spectrum analyser.

Test Description (radiated measurement procedure)

- 1) The EUT was placed inside an anechoic chamber. Refer to chapter "Setup Drawings". The EUT was coupled to a Digital Communication Tester which was located outside the chamber via a small signalling antenna.
- 2) A call was established on a Traffic Channel between the EUT and the Digital Communication Tester.  
Important Settings:
  - Output Power: Maximum
  - Channel: please refer to the detailed results
- 3) A substitution procedure is used so that the readings from the spectrum analyser are corrected and represent directly the equivalent radiated power (related to a  $\lambda/2$  dipole).
- 4) The output power was measured in both vertical and horizontal antenna polarisation during the call is established on the lowest channel, mid channel and on the highest channel. To find the worst case power all orientations (X, Y, Z) of the EUT have been measured.
- 5) The test procedure according to TIA-603-C-2004 has been considered.

Test Requirements / Limits

§2.1046 Measurements Required: RF Power Output

- (a) For transmitters other than single sideband, independent sideband and controlled carrier radiotelephone,

power output shall be measured at the RF output terminals when the transmitter is adjusted in accordance with the tune-up procedure to give the values of current and voltage on the circuit elements specified in § 2.1033(c)(8). The electrical characteristics of the output terminals when this test is made shall be stated. §27.50 Power and antenna height limits.

(d) The following power and antenna height requirements apply to stations transmitting in the 1710–1755 MHz and 2110–2155 MHz bands:

(2) Fixed, mobile, and portable (hand-held) stations operating in the 1710–1755 MHz band are limited to a peak EIRP of 1 watt. Fixed stations operating in this band are limited to a maximum antenna height of 10 meters above ground, and mobile and portable stations must employ a means for limiting power to the minimum necessary for successful communications.

---

#### Emission and Occupied Bandwidth

---

Standard FCC Part 27, Subpart C

The test was performed according to: FCC §2.1049

#### Test Description

1) The EUT was coupled to a Spectrum Analyser and a Digital Communication Tester through a Power Divider. Refer to chapter "Setup Drawings".

2) The total insertion losses for signal path 1 and signal path 2 were measured. The values were used to correct the readings from the Spectrum Analyser and the Digital Communication Tester.

3) A call was established on a Traffic Channel between the EUT and the Digital Communication Tester.

Important Settings:

- Output Power: Maximum  
- Channel: please refer to the detailed results

4) Important Analyser Settings:

- Resolution Bandwidth: >1% of the manufacturer's stated occupied bandwidth

5) The maximum spectral level of the modulated signal was recorded as the reference.

6) The emission bandwidth is measured as follows:

the two furthest frequencies above and below the frequency of the maximum reference level where the spectrum is –26 dB down have to be found.

7) The occupied bandwidth (99% Bandwidth) is measured as follows:

the occupied bandwidth, that is the frequency bandwidth such that, below its lower and above its upper frequency limits, the mean powers are each equal to 0.5 percent of the total mean power.

#### Test Requirements / Limits

§ 2.1049 Measurements required: Occupied bandwidth

The occupied bandwidth, that is the frequency bandwidth such that, below its lower and above its upper frequency limits, the mean powers radiated are each equal to 0.5 percent of the total mean power radiated by a given emission shall be measured under the following conditions (as applicable):

(h) Transmitters employing digital modulation techniques - when modulated by an input signal such that its amplitude and symbol rate represent the maximum rated conditions under which the equipment will be operated. The signal shall be applied through any filter networks, pseudo-random generators or other devices required in normal service. Additionally, the occupied bandwidth shall be shown for operation with any devices used for modifying the spectrum when such devices are optional at the discretion of the user.

---

#### Spurious emissions at antenna terminals

---

Standard FCC Part 27, Subpart C

The test was performed according to FCC §2.1051

#### Test Description



- 1) The EUT was coupled to a Spectrum Analyser and a Digital Communication Tester through a Power Divider. Refer to chapter "Setup Drawings".
- 2) The total insertion losses for signal path 1 and signal path 2 were measured. The values were used to correct the readings from the Spectrum Analyser and the Digital Communication Tester.
- 3) A call was established on a Traffic Channel between the EUT and the Digital Communication Tester.  
Important Settings:
  - Output Power: Maximum
  - Channel: please refer to the detailed results
- 4) Important Analyser Settings
  - [Resolution Bandwidth]:
    - a) [ $\geq 1\%$  of wanted signal bandwidth] in the Span of 1 MHz directly below and above the Band,
    - b) otherwise [1 MHz]
    - c) [reduced resolution bandwidth] in case the curve of the analyser IF-Filter or the wanted EUT signal leads to an exceeding of the limit, in this case a correction factor was used
  - Sweep Time: depending on the transmitting signal, the span and the resolution bandwidth
- 5) The spurious emissions peaks were measured in the frequency range from 9 kHz to 18 GHz (up to the 10th harmonic) during the call is established

#### Test Requirements / Limits

##### § 2.1051 Spurious emissions at antenna terminals

The radio frequency voltage or power generated within the equipment and appearing on a spurious frequency shall be checked at the equipment output terminals when properly loaded with a suitable artificial antenna. Curves or equivalent data shall show the magnitude of each harmonic and other spurious emission that can be detected when the equipment is operated under the conditions specified in Sec. 2.1049 as appropriate. The magnitude of spurious emissions which are attenuated more than 20 dB below the permissible value need not be specified.

##### § 2.1057 Frequency spectrum to be investigated.

(a) In all of the measurements set forth in Secs. 2.1051 and 2.1053, the spectrum shall be investigated from the lowest radio frequency signal generated in the equipment, without going below 9 kHz, up to at least the frequency shown below:

- (1) If the equipment operates below 10 GHz: to the tenth harmonic of the highest fundamental frequency or to 40 GHz, whichever is lower.
- (b) Particular attention should be paid to harmonics and subharmonics of the carrier frequency as well as to those frequencies removed from the carrier by multiples of the oscillator frequency. Radiation at the frequencies of multiplier stages should also be checked.
- (c) The amplitude of spurious emissions which are attenuated more than 20 dB below the permissible value need not be reported.
- (d) Unless otherwise specified, measurements above 40 GHz shall be performed using a minimum resolution bandwidth of 1 MHz.

##### § 27.53 Emission limits

(h) For operations in the 1710–1755 MHz and 2110–2155 MHz bands, the power of any emission outside a licensee's frequency block shall be attenuated below the transmitter power (P) by at least  $43 + 10 \log_{10}(P)$  dB. Remark of the test laboratory: This is calculated to be -13 dBm.

- (1) Compliance with this provision is based on the use of measurement instrumentation employing a resolution bandwidth of 1 megahertz or greater. However, in the 1 megahertz bands immediately outside and adjacent to the licensee's frequency block, a resolution bandwidth of at least one percent of the emission bandwidth of the fundamental emission of the transmitter may be employed. The emission bandwidth is defined as the width of the signal between two points, one below the carrier center frequency and one above the carrier center frequency, outside of which all emissions are attenuated at least 26 dB below the transmitter power.
- (2) When measuring the emission limits, the nominal carrier frequency shall be adjusted as close to the licensee's frequency block edges, both upper and lower, as the design permits.
- (3) The measurements of emission power can be expressed in peak or average values, provided they are expressed in the same parameters as the transmitter power.

For reporting only spurious emission levels reaching to the 20dB margin to limit were noted.

---

Field strength of spurious radiation

---

The test was performed according to: FCC §2.1053

#### Test Description

- 1) The EUT was placed inside an anechoic chamber. Refer to chapter "Setup Drawings". The EUT was coupled to a Digital Communication Tester which was located outside the chamber via a small signalling antenna.
  - 2) A call was established on a Traffic Channel between the EUT and the Digital Communication Tester.
- Important Settings:
- Output Power: Maximum
  - Channel : please refer to the detailed results
- 3) A pre-calibration procedure is used so that the readings from the spectrum analyser are corrected and represent directly the equivalent radiated power (related to a  $\lambda/2$  dipole).
  - 4) All spurious radiation measurements were made with spectrum analyser and the appropriate calibrated antennas for the frequency range of 30 MHz to 18 GHz (up to the 10th harmonic of the transmit frequency). The frequency range from 9 kHz to 30 MHz has been examined during the conducted spurious emission measurements.
  - 5) Important Analyser Settings
    - [Resolution Bandwidth / Video Bandwidth]:
      - a) [3 kHz / 10 kHz] in the Span of 1 MHz directly below and above the Band,
      - b) [10 kHz / 30 kHz] in case the curve of the analyser IF-Filter leads to an exceeding of the limit, in this case a worst case correction factor of 20 dB (1 MHz -> 10 kHz) was used
      - c) [1 MHz / 3 MHz] otherwise
    - Sweep Time: depending on the transmitting signal, the span and the resolution bandwidth
  - 6) The spurious emissions peaks were measured in both vertical and horizontal antenna polarisation during the call is established on the lowest channel, mid channel and on the highest channel. To find the worst case peaks all orientations (X, Y, Z) of the EUT have been measured.
  - 7) After this initial test, a final test according to TIA-603-C 2.2.12 Unwanted Emissions is performed on signals which are identified as being close to the limit. For any emissions found to be within 10 dB of the limit, a specific signal substitution measurement is performed at the frequency of the emission to determine the exact e.i.r.p. value.

#### Test Requirements / Limits

§ 2.1053 Measurements required: Field strength of spurious radiation.

Measurements shall be made to detect spurious emissions that may be radiated directly from the cabinet, control circuits, power leads, or intermediate circuit elements under normal conditions of installation and operation. Curves or equivalent data shall be supplied showing the magnitude of each harmonic and other spurious emission. For this test, single sideband, independent sideband, and controlled carrier transmitters shall be modulated under the conditions specified in paragraph (c) of Sec. 2.1049, as appropriate. For equipment operating on frequencies below 890 MHz, an open field test is normally required, with the measuring instrument antenna located in the far-field at all test frequencies. In the event it is either impractical or impossible to make open field measurements (e.g. a broadcast transmitter installed in a building) measurements will be accepted of the equipment as installed. Such measurements must be accompanied by a description of the site where the measurements were made showing the location of any possible source of reflections which might distort the field strength measurements. Information submitted shall include the relative radiated power of each spurious emission with reference to the rated power output of the transmitter, assuming all emissions are radiated from halfwave dipole antennas.

(b) The measurements specified in paragraph (a) of this section shall be made for the following equipment:

(2) All equipment operating on frequencies higher than 25 MHz.

§ 2.1057 Frequency spectrum to be investigated.

- (a) In all of the measurements set forth in Secs. 2.1051 and 2.1053, the spectrum shall be investigated from the lowest radio frequency signal generated in the equipment, without going below 9 kHz, up to at least the frequency shown below:
- (1) If the equipment operates below 10 GHz: to the tenth harmonic of the highest fundamental frequency or to 40 GHz, whichever is lower.
  - (b) Particular attention should be paid to harmonics and subharmonics of the carrier frequency as well as to those frequencies removed from the carrier by multiples of the oscillator frequency. Radiation at the frequencies of multiplier stages should also be checked.
  - (c) The amplitude of spurious emissions which are attenuated more than 20 dB below the permissible value need not be reported.
  - (d) Unless otherwise specified, measurements above 40 GHz shall be performed using a minimum resolution bandwidth of 1 MHz.

§ 27.53 Emission limits

(h) For operations in the 1710–1755 MHz and 2110–2155 MHz bands, the power of any emission outside a licensee's frequency block shall be attenuated below the transmitter power (P) by at least  $43 + 10 \log_{10}(P)$  dB.

Remark of the test laboratory: This is calculated to be -13 dBm (effective radiated power) which corresponds to 84.6 dB $\mu$ V/m (field strength) in a distance of 3 m.

(1) Compliance with this provision is based on the use of measurement instrumentation employing a resolution bandwidth of 1 megahertz or greater. However, in the 1 megahertz bands immediately outside and adjacent to the licensee's frequency block, a resolution bandwidth of at least one percent of the emission bandwidth of the fundamental emission of the transmitter may be employed. The emission bandwidth is defined as the width of the signal between two points, one below the carrier center frequency and one above the carrier center frequency, outside of which all emissions are attenuated at least 26 dB below the transmitter power.

(2) When measuring the emission limits, the nominal carrier frequency shall be adjusted as close to the licensee's frequency block edges, both upper and lower, as the design permits.

(3) The measurements of emission power can be expressed in peak or average values, provided they are expressed in the same parameters as the transmitter power.

For reporting only spurious emission levels reaching to the 20dB margin to limit were noted.

---

#### Frequency stability

---

Standard FCC Part 27, Subpart C

The test was performed according to FCC §2.1055

#### Test Description

- 1) The EUT was placed inside a temperature chamber.
  - 2) The EUT was coupled to a Digital Communication Tester. Refer to chapter "Setup Drawings".
  - 3) The climatic chamber was cycled down/up to a certain temperature, starting with the EUT minimum temperature.
  - 4) After the temperature was stabilized the EUT was switched on and a call was established on a Traffic Channel between the EUT and the Digital Communication Tester.
- Important Settings:
- Output Power: Maximum
  - Mid Channel
- 5) The frequency error of the EUT was recorded by using an internal measurement function of the Digital Communication Tester immediately after the call was established, five minutes after the call was established and ten minutes after the call was established.
  - 6) This measurement procedure was performed for temperature variation from -30°C to +50°C in increments of 10°C, if not otherwise stated in the detailed results.
- When the EUT did not operate at certain temperature levels, these measurements were left out.

#### Test Requirements / Limits

§2.1055 Measurements required: Frequency stability

- (a) The frequency stability shall be measured with variation of ambient temperature as follows:
- (1) From -30° to +50° centigrade for all equipment except that specified in paragraphs (a) (2) and (3) of this section.
  - (b) Frequency measurements shall be made at the extremes of the specified temperature range and at intervals of not more than 10° centigrade through the range. A period of time sufficient to stabilize all of the components of the oscillator circuit at each temperature level shall be allowed prior to frequency measurement. The short term transient effects on the frequency of the transmitter due to keying (except for broadcast transmitters) and any heating element cycling normally occurring at each ambient temperature level also shall be shown. Only the portion or portions of the transmitter containing the frequency determining and stabilizing circuitry need be subjected to the temperature variation test.
  - (d) The frequency stability shall be measured with variation of primary supply voltage as follows:
    - (1) Vary primary supply voltage from 85 to 115 percent of the nominal value for other than hand carried battery equipment.
    - (2) For hand carried, battery powered equipment, reduce primary supply voltage to the battery operating end point which shall be specified by the manufacturer.
    - (3) The supply voltage shall be measured at the input to the cable normally provided with the equipment, or

at the power supply terminals if cables are not normally provided. Effects on frequency of transmitter keying (except for broadcast transmitters) and any heating element cycling at the nominal supply voltage and at each extreme also shall be shown.

#### §27.54 Frequency stability

The frequency stability shall be sufficient to ensure that the fundamental emissions stay within the authorized bands of operation.

7Layers interpretation of limit:

To ensure that the frequency stability shall be sufficient to ensure that the fundamental emission stays within the authorized frequency block following limit was used:

- +/- 2.5 ppm = 4350 Hz for channel 1450, frequency 1740.0 MHz
- +/- 2.5 ppm = 4331 Hz for channel 1412, frequency 1732.4 MHz

in accordance with FCC Part 22, Subpart H, §22.355, table C-1: Frequency tolerance for the carrier frequency of mobile transmitters in the Public Mobile Service in the frequency range 821 to 896 MHz.

---

#### Band edge compliance

---

Standard            FCC Part 27, Subpart C

The test was performed according to: FCC §27.53

#### Test Description

- 1) The EUT was coupled to a Spectrum Analyser and a Digital Communication Tester through a Power Divider. Refer to chapter "Setup Drawings".
- 2) The total insertion losses for signal path 1 and signal path 2 were measured. The values were used to correct the readings from the Spectrum Analyser and the Digital Communication Tester.
- 3) A call was established on a Traffic Channel between the EUT and the Digital Communication Tester.  
Important Settings:
  - Output Power: Maximum
  - Channel: please refer to the detailed results
- 4) Important Analyser Settings:
  - Resolution Bandwidth = Video Bandwidth: >1% of the manufacturer's stated occupied bandwidth

#### Test Requirements / Limits

##### § 27.53 Effective radiated power limits

Refer to chapter "Field strength of spurious radiation".

Subtests HSDPA

Sub-test	$\beta_c$	$\beta_d$	$\beta_d$ (SF)	$\beta_c/\beta_d$	$\beta_{HS}$ (Note1, Note 2)	CM (dB) (Note 3)	MPR (dB) (Note 3)
1	2/15	15/15	64	2/15	4/15	0.0	0.0
2	12/15 (Note 4)	15/15 (Note 4)	64	12/15 (Note 4)	24/15	1.0	0.0
3	15/15	8/15	64	15/8	30/15	1.5	0.5
4	15/15	4/15	64	15/4	30/15	1.5	0.5

Note 1:  $?_{ACK}$ ,  $?_{NACK}$  and  $?_{CQI} = 30/15$  with  $\beta_{hs} = 30/15 * \beta_c$ .

Note 2: For the HS-DPCCH power mask requirement test in clause 5.2C, 5.7A, and the Error Vector Magnitude (EVM) with HS-DPCCH test in clause 5.13.1A, and HSDPA EVM with phase discontinuity in clause 5.13.1AA,  $?_{ACK}$  and  $?_{NACK} = 30/15$  with  $\beta_{hs} = 30/15 * \beta_c$ , and  $?_{CQI} = 24/15$  with  $\beta_{hs} = 24/15 * \beta_c$ .

Note 3: CM = 1 for  $\beta_c/\beta_d=12/15$ ,  $\beta_{hs}/\beta_c=24/15$ . For all other combinations of DPDCH, DPCCH and HS-DPCCH the MPR is based on the relative CM difference. This is applicable for only UEs that support HSDPA in release 6 and later releases.

Note 4: For subtest 2 the  $\beta_c/\beta_d$  ratio of 12/15 for the TFC during the measurement period (TF1, TF0) is achieved by setting the signalled gain factors for the reference TFC (TF1, TF1) to  $\beta_c = 11/15$  and  $\beta_d = 15/15$ .

Subtests HSUPA

Subtest	Mode	Loopback Mode	Rel99 RMC	HSDPA FRC	HSUPA Test	Number of E-DPDCH Channels
1	Rel6 HSUPA	Test Mode 1	12.2kbps RMC	H-Set1	HSUPA Loopback	1
2	Rel6 HSUPA	Test Mode 1	12.2kbps RMC	H-Set1	HSUPA Loopback	1
3	Rel6 HSUPA	Test Mode 1	12.2kbps RMC	H-Set1	HSUPA Loopback	2
4	Rel6 HSUPA	Test Mode 1	12.2kbps RMC	H-Set1	HSUPA Loopback	1
5	Rel6 HSUPA	Test Mode 1	12.2kbps RMC	H-Set1	HSUPA Loopback	1

Subtest	Max UL Data Rate (kb/s)	$\beta_c/\beta_d$	$\beta_{hs}$	$\beta_{ed}$	CM
1	242.1	11/15	22/15	1309/225	1
2	161.3	6/15	12/15	94/75	3
3	524.7	15/9	30/15	47/15	2
4	197.6	2/15	4/15	56/75	3
5	299.6	15/15	30/15	134/15	1

Setup Drawings

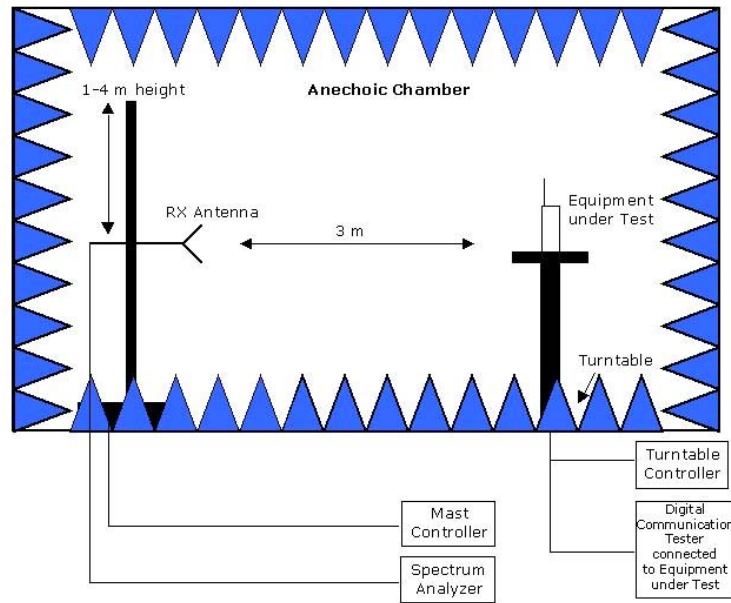

Remark: Depending on the frequency range suitable antenna types, attenuators or preamplifiers are used.

Principle set-up for radiated measurements

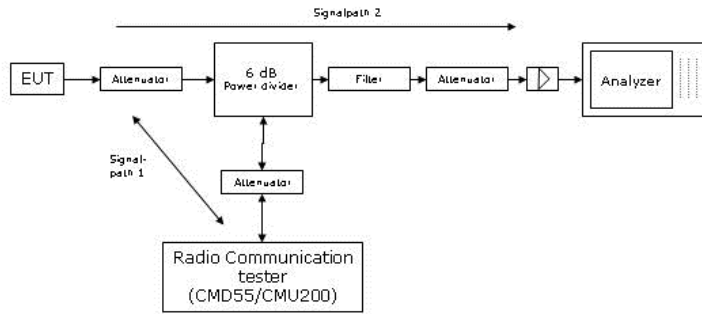

Remark: Depending on the frequency range suitable attenuators and/or filters and/or amplifiers are used.

Principle set-up for conducted measurements under nominal conditions

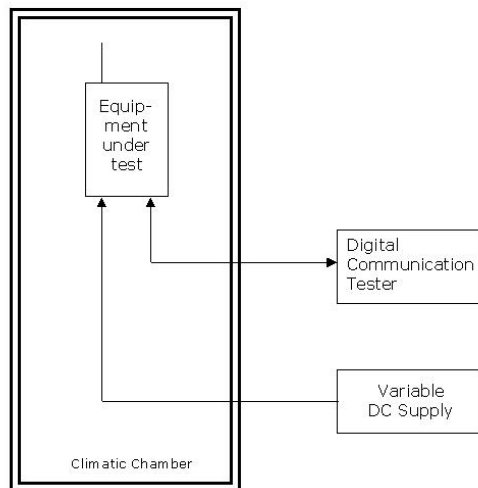

Principle set-up for tests under extreme test conditions

**Correlation of measurement requirements for Cellular Equipment from FCC and IC**

Test name – FCC	FCC reference CFR47				Test name – IC	IC reference					
	Part 2	Part 22	Part 24	Part 27		RSS-Gen	RSS-130 SRSP-518	RSS-132 SRSP-503	RSS-133 SRSP-510	RSS-139 SRSP-513	RSS-199 SRSP-517
					<b>Issue:</b>	4, 2014	1, 2013	3, 2013	6, 2013	3, 2016	3, 2016
RF power output	§ 2.1046	§ 22.913	§ 24.232	§ 27.50	Transmitter output power	6.12	4.4	5.4	6.4	6.5	4.4
Frequency stability	§ 2.1055	§ 22.355	§ 24.235	§ 27.54	Frequency stability	6.11	4.3	5.3	6.3	6.4	4.3
Spurious emissions at antenna terminals	§ 2.1051	§ 22.917	§ 24.238	§ 27.53	Transmitter unwanted emissions conducted	6.13	4.6	5.5	6.5	6.6	4.5
-	-	-	-	-	Receiver unwanted emissions conducted	5/7 *), 7.1.3	-	5.6	6.6	-	-
Field strength of spurious radiation	§ 2.1053	§ 22.917	§ 24.238	§ 27.53	Transmitter unwanted emissions radiated	6.13	4.6	5.5	6.5	6.6	4.5
-	-	-	-	-	Receiver unwanted emissions radiated	5/7 *), 7.1.2	-	5.6	6.6	-	-
Emission and Occupied Bandwidth	§ 2.1049	-	-	-	Emission and Occupied Bandwidth	6.6	-	5.5	2.3; 6.5	-	-
Band edge compliance	§ 2.1053	§ 22.917	§ 24.238	§ 27.53	Band edge compliance	6.13	4.6	5.5	6.5	6.6	4.5

\*) Receivers are exempted from certification besides if operating in stand-alone mode in the frequency range 30–960 MHz or if these are scanner receivers.



## 6 Index

1	Administrative Data	2
1.1	Project Data	2
1.2	Applicant Data	2
1.3	Test Laboratory Data	2
1.4	Signature of the Testing Responsible	3
1.5	Signature of the Accreditation Responsible	3
2	Test Object Data	3
2.1	General OUT Description	3
2.2	Detailed Description of OUT Samples	4
2.3	OUT Features	5
2.4	Setups used for Testing	6
3	Results	6
3.1	General	6
3.2	List of the Applicable Body	7
3.3	List of Test Specification	7
3.4	Summary	8
3.5	Detailed Results	9
3.5.1	22.1 RF Power Output §2.1046, §22.913	9
3.5.2	22.4 Field strength of spurious radiation §2.1053, §22.917	12
3.5.3	24.1 RF Power Output §2.1046, §24.232	15
3.5.4	24.4 Field strength of spurious radiation §2.1053, §24.238	18
3.5.5	27.1 RF Power Output §2.1046, §27.250	21
3.5.6	27.2 Frequency stability §2.1055, §27.54	26
3.5.7	27.3 Spurious emissions at antenna terminals §2.1051, §27.53	29
3.5.8	27.4 Field strength of spurious radiation §2.1053, §27.53	30
3.5.9	27.5 Emission and Occupied Bandwidth §2.1049	39
3.5.10	27.6 Band edge compliance §2.1053, §27.53	41
3.5.11	27.7 Peak-to-Average ratio §2.1046, §27.50	43
4	Test Equipment Details	45
4.1	List of Used Test Equipment	45
5	Annex	52
5.1	Additional Information for Report	52
6	Index	89