

## FCC Test Report (ENDC: n25 + LTE Band 12)

**Report No.:** RFBHQC-WTW-P21030610F

**FCC ID:** QIPMV31-W

**Test Model:** MV31-W

**Received Date:** Sep. 06, 2021

**Test Date:** Sep. 29 ~ Oct. 10, 2021

**Issued Date:** Jun. 24, 2022

**Applicant:** THALES DIS AIS Deutschland GmbH

**Address:** Siemensdamm 50, Berlin, 13629, German

**Issued By:** Bureau Veritas Consumer Products Services (H.K.) Ltd., Taoyuan Branch  
Lin Kou Laboratories

**Lab Address:** No. 47-2, 14th Ling, Chia Pau Vil., Lin Kou Dist., New Taipei City, Taiwan

**Test Location(1):** No. 19, Hwa Ya 2nd Rd., Wen Hwa Vil., Kwei Shan Dist., Taoyuan City  
33383, Taiwan

**FCC Registration /  
Designation Number(1):** 788550 / TW0003

**Test Location(2):** No. 70, Wenming Rd., Guishan Dist., Taoyuan City 333, Taiwan (R.O.C.)

**FCC Registration /  
Designation Number(2):** 281270 / TW0032



This report is governed by, and incorporates by reference, the Conditions of Testing as posted at the date of issuance of this report at <http://www.bureauveritas.com/home/about-us/our-business/cps/about-us/terms-conditions/>, and is intended for your exclusive use. Any copying or replication of this report to or for any other person or entity, or use of our name or trademark, is permitted only with our prior written permission. This report sets forth our findings solely with respect to the test samples identified herein. The results set forth in this report are not indicative or representative of the quality or characteristics of the lot from which a test sample was taken or any similar or identical product unless specifically and expressly noted. Our report includes all of the tests requested by you and the results thereof based upon the information that you provided to us. Measurement uncertainty is only provided upon request for accredited tests. Statements of conformity are based on simple acceptance criteria without taking measurement uncertainty into account, unless otherwise requested in writing. You have 60 days from date of issuance of this report to notify us of any material error or omission caused by our negligence or if you require measurement uncertainty; provided, however, that such notice shall be in writing and shall specifically address the issue you wish to raise. A failure to raise such issue within the prescribed time shall constitute your unqualified acceptance of the completeness of this report, the tests conducted and the correctness of the report contents.

**Table of Contents**

<b>Release Control Record</b> .....	<b>4</b>
<b>1 Certificate of Conformity</b> .....	<b>5</b>
<b>2 Summary of Test Results</b> .....	<b>6</b>
2.1 Measurement Uncertainty.....	7
2.2 Test Site and Instruments.....	8
<b>3 General Information</b> .....	<b>9</b>
3.1 General Description of EUT.....	9
3.2 Configuration of System under Test.....	13
3.2.1 Description of Support Units.....	13
3.3 Test Mode Applicability and Tested Channel Detail.....	14
3.4 EUT Operating Conditions.....	19
3.5 General Description of Applied Standards and References.....	19
<b>4 Test Types and Results</b> .....	<b>20</b>
4.1 Output Power Measurement.....	20
4.1.1 Limits of Output Power Measurement.....	20
4.1.2 Test Procedures.....	20
4.1.3 Test Setup.....	20
4.1.4 Test Results.....	21
4.2 Modulation Characteristics Measurement.....	37
4.2.1 Limits of Modulation Characteristics.....	37
4.2.2 Test Procedure.....	37
4.2.3 Test Setup.....	37
4.2.4 Test Results.....	38
4.3 Frequency Stability Measurement.....	40
4.3.1 Limits of Frequency Stability Measurement.....	40
4.3.2 Test Procedure.....	40
4.3.3 Test Instruments.....	40
4.3.4 Conducted Setup.....	40
4.3.5 Test Results.....	41
4.4 Occupied Bandwidth Measurement.....	49
4.4.1 Test Procedure.....	49
4.4.2 Test Setup.....	49
4.4.3 Test Result.....	50
4.5 Band Edge Measurement.....	58
4.5.1 Limits of Band Edge Measurement.....	58
4.5.2 Test Setup.....	58
4.5.3 Test Procedures.....	58
4.5.4 Test Results.....	59
4.6 Peak to Average Ratio.....	67
4.6.1 Limits of Peak to Average Ratio Measurement.....	67
4.6.2 Test Setup.....	67
4.6.3 Test Procedures.....	67
4.6.4 Test Results.....	68
4.7 Conducted Spurious Emissions.....	72
4.7.1 Limits of Conducted Spurious Emissions Measurement.....	72
4.7.2 Test Setup.....	72
4.7.3 Test Procedure.....	72
4.7.4 Test Results.....	73
4.8 Radiated Emission Measurement.....	81
4.8.1 Limits of Radiated Emission Measurement.....	81
4.8.2 Test Procedure.....	81
4.8.3 Deviation from Test Standard.....	81
4.8.4 Test Setup.....	82

4.8.5 Test Results .....	83
<b>5 Pictures of Test Arrangements.....</b>	<b>97</b>
<b>Appendix – Information of the Testing Laboratories .....</b>	<b>98</b>

### Release Control Record

Issue No.	Description	Date Issued
RFBHQC-WTW-P21030610F	Original release	Jun. 24, 2022

## 1 Certificate of Conformity

**Product:** Cinterion MV31-W

**Brand:** CINTERION

**Test Model:** MV31-W

**Sample Status:** Engineering Sample

**Applicant:** THALES DIS AIS Deutschland GmbH

**Test Date:** Sep. 29 ~ Oct. 10, 2021

**Standards:** FCC Part 24, Subpart E  
FCC Part 27, Subpart C, H

The above equipment has been tested by **Bureau Veritas Consumer Products Services (H.K.) Ltd., Taoyuan Branch**, and found compliance with the requirement of the above standards. The test record, data evaluation & Equipment Under Test (EUT) configurations represented herein are true and accurate accounts of the measurements of the sample's RF characteristics under the conditions specified in this report.

**Prepared by :** Pettie Chen, **Date:** Jun. 24, 2022  
Pettie Chen / Senior Specialist

**Approved by :** Jeremy Lin, **Date:** Jun. 24, 2022  
Jeremy Lin / Project Engineer

## 2 Summary of Test Results

For n25

Applied Standard: FCC Part 24 & Part 2			
FCC Clause	Test Item	Result	Remarks
2.1046 24.232	Effective Isotropically Radiated Power	Pass	Meet the requirement of limit.
2.1046 24.232 (d)	Peak To Average Ratio	Pass	Meet the requirement of limit.
2.1047	Modulation Characteristics	Pass	Meet the requirement
2.1055 24.235	Frequency Stability	Pass	Meet the requirement of limit.
2.1049	Occupied Bandwidth	Pass	Meet the requirement of limit.
24.238	Band Edge Measurements	Pass	Meet the requirement of limit.
2.1051 24.238	Conducted Spurious Emissions	Pass	Meet the requirement of limit.
2.1053 24.238	Radiated Spurious Emissions	Pass	Meet the requirement of limit. Minimum passing margin is -35.25dB at 3765.00MHz.

Note: Determining compliance based on the results of the compliance measurement, not taking into account measurement instrumentation uncertainty.

For LTE Band 12

FCC Clause	Applied Standard: FCC Part 27 & Part 2		
LTE B12	Test Item	Result	Remarks
2.1046 27.50(c)	Equivalent radiated power	Pass	Meet the requirement of limit.
2.1047	Modulation characteristics	Pass	Meet the requirement
2.1055 27.54	Frequency Stability	Pass	Meet the requirement of limit.
2.1049	Emission Bandwidth	Pass	Meet the requirement of limit.
2.1051 27.53(g)	Out of Band Emission Measurements	Pass	Meet the requirement of limit.
--	Peak To Average Ratio	Pass	Meet the requirement of limit.
2.1051 27.53(g)	Conducted Spurious Emissions	Pass	Meet the requirement of limit.
2.1053 27.53(g)	Radiated Spurious Emissions	Pass	Meet the requirement of limit. Minimum passing margin is -38.40dB at 1415.00MHz.

Note: Determining compliance based on the results of the compliance measurement, not taking into account measurement instrumentation uncertainty.

## 2.1 Measurement Uncertainty

Where relevant, the following measurement uncertainty levels have been estimated for tests performed on the EUT as specified in CISPR 16-4-2:

Measurement	Frequency	Expanded Uncertainty (k=2) ( $\pm$ )
Radiated Emissions up to 1 GHz	9kHz ~ 30MHz	3.00 dB
	30MHz ~ 200MHz	2.91 dB
	200MHz ~ 1000MHz	2.93 dB
Radiated Emissions above 1 GHz	1GHz ~ 18GHz	1.76 dB
	18GHz ~ 40GHz	1.77 dB

## 2.2 Test Site and Instruments

Description & Manufacturer	Model No.	Serial No.	Cal. Date	Cal. Due
Test Receiver Rohde & Schwarz	N9038A	MY55420137	Apr. 09, 2021	Apr. 08, 2022
Spectrum Analyzer KEYSIGHT	N9020B	MY60110440	Dec. 18, 2020	Dec. 17, 2021
BILOG Antenna SCHWARZBECK	VULB9168	1213	Nov. 04, 2020	Nov. 03, 2021
HORN Antenna SCHWARZBECK	BBHA 9120 D	9120D-563	Nov. 22, 2020	Nov. 21, 2021
HORN Antenna SCHWARZBECK	BBHA 9170	995	Nov. 22, 2020	Nov. 21, 2021
Preamplifier EMCI	EMC330N	980782	Jan. 12, 2021	Jan. 11, 2022
Preamplifier EMCI	EMC118A45SE	980808	Jan. 12, 2021	Jan. 11, 2022
Preamplifier EMCI	EMC184045SE	980788	Jan. 12, 2021	Jan. 11, 2022
RF signal cable EMCI	EMC104-SM-SM-(9000+2000+1000)	201243+ 201231+ 210102	Jan. 12, 2021	Jan. 11, 2022
RF signal cable EMCI	EMCCFD400-NM-NM-(9000+300+500)	201236+ 201235+ 201233	Jan. 12, 2021	Jan. 11, 2022
RF signal cable EMCI	EMC101G-KM-KM-(5000+3000+2000)	201260+201257+201254	Jan. 12, 2021	Jan. 11, 2022
Software BV ADT	ADT_Radiated_V7.6.15.9.5	NA	NA	NA
Antenna Tower Max-Full	MFT-151SS-0.5T	NA	NA	NA
Turn Table Max-Full	MF-7802BS	NA	NA	NA
Turn Table Controller Max-Full	MF-7802BS	MF780208674	NA	NA
USB Wideband Power Sensor KEYSIGHT	U2021XA	MY55050005/MY55190004/ MY55190007/MY55210005	Jul. 12, 2021	Jul. 11, 2022
Turn Table BV ADT	TT100	TT93021705	NA	NA
Turn Table Controller BV ADT	SC100	SC93021705	NA	NA
Boresight Antenna Fixture	FBA-01	FBA-SIP01	NA	NA
Standard Temperature And Humidity Chamber GIANT FORCE	GTH-120-40-CP-AR	MAA1306-019	Sep. 10, 2021	Sep. 09, 2022
JFW 20dB attenuation	50HF-020-SMA	NA	NA	NA
True RMS Clamp Meter Fluke	325	31130711WS	Jun. 02, 2021	Jun. 01, 2022
DC power supply Keysight	U8002A	MY56330015	NA	NA

Note: 1. The calibration interval of the above test instruments is 12 months and the calibrations are traceable to NML/ROC and NIST/USA.  
2. The test was performed in WM Chamber 8.



### 3 General Information

#### 3.1 General Description of EUT

Product	Cinterion MV31-W
Brand	CINTERION
Test Model	MV31-W
Sample Status	Engineering Sample
Power Supply Rating	5 Vdc (Host equipment) 3.135Vdc~3.63Vdc (Module)

#### n25

Modulation Type	$\pi/2$ BPSK, QPSK, 16QAM, 64QAM, 256QAM					
Waveform Type	CP-OFDM, DFT-s-OFDM					
Operating Frequency	n25 (Channel Bandwidth 5MHz)	1852.5MHz ~ 1912.5MHz				
	n25 (Channel Bandwidth 10MHz)	1855.0MHz ~ 1910.0MHz				
	n25 (Channel Bandwidth 15MHz)	1857.5MHz ~ 1907.5MHz				
	n25 (Channel Bandwidth 20MHz)	1860.0MHz ~ 1905.0MHz				
Max. EIRP Power		$\pi/2$ BPSK	QPSK	16QAM	64QAM	256QAM
	n25 (Channel Bandwidth 5MHz)	868.960mW (29.39dBm)	845.279mW (29.27dBm)	625.173mW (27.96dBm)	508.159mW (27.06dBm)	325.837mW (25.13dBm)
	n25 (Channel Bandwidth 10MHz)	879.023mW (29.44dBm)	839.460mW (29.24dBm)	626.614mW (27.97dBm)	506.991mW (27.05dBm)	323.594mW (25.10dBm)
	n25 (Channel Bandwidth 15MHz)	885.116mW (29.47dBm)	835.603mW (29.22dBm)	606.736mW (27.83dBm)	508.159mW (27.06dBm)	322.107mW (25.08dBm)
	n25 (Channel Bandwidth 20MHz)	887.156mW (29.48dBm)	824.138mW (29.16dBm)	623.735mW (27.95dBm)	509.331mW (27.07dBm)	328.852mW (25.17dBm)
Emission Designator		$\pi/2$ BPSK	QPSK	16QAM	64QAM	256QAM
	n25 (Channel Bandwidth 5MHz)	4M48G7D	4M47G7D	4M47D7W	4M47D7W	4M47D7W
	n25 (Channel Bandwidth 10MHz)	9M21G7D	9M29G7D	9M29D7W	9M29D7W	9M29D7W
	n25 (Channel Bandwidth 15MHz)	14M0G7D	14M1G7D	14M1D7W	14M1D7W	14M1D7W
	n25 (Channel Bandwidth 20MHz)	18M8G7D	18M9G7D	18M9D7W	18M9D7W	18M9D7W

#### LTE Band

Modulation Type	QPSK, 16QAM, 64QAM, 256QAM				
Operating Frequency	LTE Band 12 (Channel Bandwidth 1.4MHz)	699.7MHz ~ 715.3MHz			
	LTE Band 12 (Channel Bandwidth 3MHz)	700.5MHz ~ 714.5MHz			
	LTE Band 12 (Channel Bandwidth 5MHz)	701.5MHz ~ 713.5MHz			
	LTE Band 12 (Channel Bandwidth 10MHz)	704.0MHz ~ 711.0MHz			
Max. ERP Power		QPSK	16QAM	64QAM	256QAM
	LTE Band 12 (Channel Bandwidth 1.4MHz)	524.807mW (27.20dBm)	461.318mW (26.64dBm)	367.282mW (25.65dBm)	237.137mW (23.75dBm)
	LTE Band 12 (Channel Bandwidth 3MHz)	532.108mW (27.26dBm)	464.515mW (26.67dBm)	365.595mW (25.63dBm)	242.661mW (23.85dBm)
	LTE Band 12 (Channel Bandwidth 5MHz)	537.032mW (27.30dBm)	463.447mW (26.66dBm)	371.535mW (25.70dBm)	231.206mW (23.64dBm)
	LTE Band 12 (Channel Bandwidth 10MHz)	524.807mW (27.20dBm)	480.839mW (26.82dBm)	373.250mW (25.72dBm)	230.675mW (23.63dBm)
Emission Designator		QPSK	16QAM	64QAM	256QAM
	LTE Band 12 (Channel Bandwidth 1.4MHz)	1M09G7D	1M09D7W	1M09D7W	1M09D7W
	LTE Band 12 (Channel Bandwidth 3MHz)	2M70G7D	2M70D7W	2M70D7W	2M70D7W
	LTE Band 12 (Channel Bandwidth 5MHz)	4M49G7D	4M49D7W	4M49D7W	4M49D7W
	LTE Band 12 (Channel Bandwidth 10MHz)	8M97G7D	8M96D7W	8M96D7W	8M96D7W
Antenna Type	Refer to Note as below				

Antenna Connector	Refer to Note as below
Accessory Device	NA
Cable Supplied	NA

Output Power / Emission Designator	n25+LTE Band 12	Maximum EIRP		Sum Bandwidth
		n25	887.156mW (29.48dBm)	23M3D7W
	LTE Band 12 (ERP)	537.032mW (27.3dBm)	MAX Sum Bandwidth	
		EIRP		
	n25	887.156mW (29.48dBm)	27M8D7W	
	LTE Band 12 (ERP)	524.807mW (27.20dBm)		

Note:

1. This report is prepared for FCC class II permissive change. This report is issued as a duplicate report of BV CPS report no.: RFBHQC-WTW-P21030610B (FCC ID: 2AQ68T99W175). Difference compared with the original report is changing applicant, FCC ID, product name, brand and model. Due to no effect any test item, we didn't to re-test.
2. There are four Difference HW of MV31-W.

Brand	Model	HW
CINTERION	MV31-W	1. 3G+LTE+Sub6+eSIM
		2. 3G+LTE+Sub6 only w/o eSIM
		3. 3G+LTE+Sub6+eSIM+GNSS connector
		4. 3G+LTE+Sub6 only+w/o eSIM+GNSS connector

\*After pre-testing, "HW: 1. 3G+LTE+Sub6+eSIM" is the worst for the final tests.

3. The following antennas were provided to the EUT.

Antenna No.	RF Chain No.	Brand	Model	Antenna Net Gain(dBi)	Frequency range (MHz)	Antenna Type	Connector Type
1		WHA YU	C107-511720-A	4.41	660~803	PCB	I-PEX
2		WHA YU	C107-511721-A	3.81 4.03	791~960 1447.9~1606	PCB	I-PEX
3		WHA YU	C107-511722-A	4.27 5.31	1710~2170 2500~2690	PCB	I-PEX
4		WHA YU	C107-511723-A	2.99 0.92	2300~2400 3500~3700	PCB	I-PEX
5		WHA YU	C107-511724-A	6.45	5150~5925	PCB	I-PEX
6		WHA YU	C107-511725-A	4.89	3400~3700	PCB	I-PEX
7		AVX	5000106-R1-X01	2.91	699~803	Monopole	I-PEX
8		AVX	5000107-R1-X01	2.59	791~960	Monopole	I-PEX
9		AVX	5000108-R1-X01	2.85	1427~1610	Monopole	I-PEX
10		AVX	5000109-R1-X01	2.23 2.94	1710~2200 5150~5925	Monopole	I-PEX
11		AVX	5000110-R1-X01	0.9	2300~2690	Monopole	I-PEX
12		AVX	5000111-R1-X01	0.87	3300~5000	Monopole	I-PEX
13	Tx1/ Rx1	Ethertronics	5003806	0.4 -1.61 0.39 2.95 1.98 0.38 0.83 2.31	698-821 824-960 1425-1515 1710-2200 2300-2690 3300-4200 4400-5000 5150-5925	PIFA	I-PEX
	Rx2	Ethertronics	5003807	-2.24 -4.52 2.87 2.99 2.93 2.91 2.23 -0.85 -3.04	716-821 824-960 1425-1515 1557-1610 1805-2200 2300-2690 3300-4200 4400-5000 5150-5925	PIFA	I-PEX
	Tx2/ Rx3	Ethertronics	5003806	2.21 2.25 -0.45 2.6	1710-2200 2300-2690 3300-4200 4400-5000	PIFA	I-PEX
	Rx4	Ethertronics	5003700	1.38 2.87 0.6 -2.09	1805-2200 2300-2690 3300-4200 4400-5000	PIFA	I-PEX

Antenna No.	RF Chain No.	Brand	Model	Antenna Net Gain(dBi)	Frequency range (MHz)	Antenna Type	Connector Type
14	Ant. 0 (TX/RX)	Master Wave	NA	2.4 2.2 2.9 2.9 2.9 NA	880~960 1020~2170 2545~2595 3565~3600 3900~4000 GPS	PCB	I-PEX
	Ant. 2 (TX/RX)	Master Wave	NA	NA 2.2 2.8 2.9 2.8 NA	880~960 1020~2170 2545~2595 3565~3600 3900~4000 GPS	PCB	I-PEX
	Ant. 1 (RX)	Master Wave	NA	NA 5.3 5.1 4.3 4.5 NA	880~960 1020~2170 2545~2595 3565~3600 3900~4000 GPS	PCB	I-PEX
	Ant. 3 (RX)	Master Wave	NA	1.3 6.8 3.7 6.4 6.2 3.7	880~960 1020~2170 2545~2595 3565~3600 3900~4000 GPS	PCB	I-PEX

\*The antenna for the final tests as following table.

	Band	Antenna
5GNR	25 (15kHz) /5/10/15/20	Antenna 3

	Band	Antenna
LTE	12	Antenna 1

4. The EUT supports the following ENDC configuration.

5GNR	FCC 5G FR1			ENDC
	Band	SCS	Bandwidth (MHz)	
	n25	15kHz	5/10/15/20	Band 12
n77	30kHz	20/40/50/60/80/90/100	Band 2/5/7/12/13/14/30/41/66	

### 3.2 Configuration of System under Test

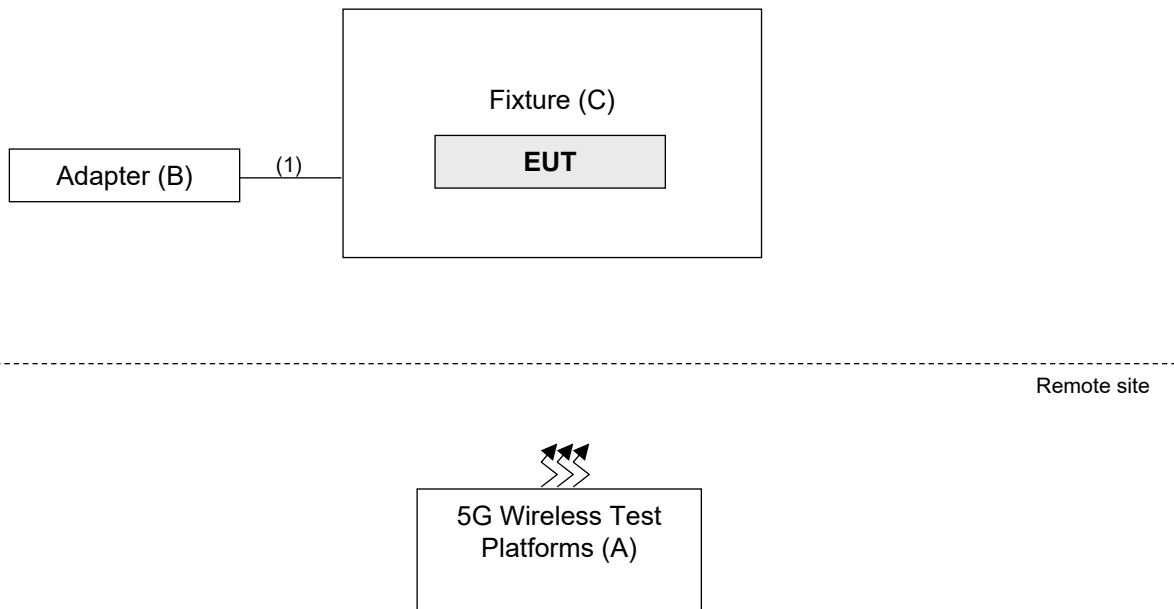

#### 3.2.1 Description of Support Units

The EUT has been tested as an independent unit together with other necessary accessories or support units. The following support units or accessories were used to form a representative test configuration during the tests.

ID	Product	Brand	Model No.	Serial No.	FCC ID	Remarks
A.	5G Wireless Test Platforms	Keysight	E7515B	MY60102114	NA	-
B.	Adapter	LITEON	PA-1050-39	NA	NA	-
C.	Fixture	NA	NA	NA	NA	Provided by client.

Note:

1. All power cords of the above support units are non-shielded (1.8m).
2. Item A acted as a communication partner to transfer data.

ID	Descriptions	Qty.	Length (m)	Shielding (Yes/No)	Cores (Qty.)	Remarks
1.	USB cable	1	1.5	Y	0	-

### 3.3 Test Mode Applicability and Tested Channel Detail

Pre-Scan has been conducted to determine the worst-case mode from all possible combinations between available modulations, data rates, XYZ axis and antenna ports. The worst case was found when positioned as the table below. Following channel(s) was (were) selected for the final test as listed below:

Band	Radiated Emission
n25	Z-plane
LTE Band 12	Z-plane

n25

EUT Configure Mode	Test item	Available channel	Tested channel	Channel Bandwidth	Modulation	Mode
-	EIRP	370500 to 382500	370500 (1852.5MHz), 376500 (1882.5MHz), 382500 (1912.5MHz)	5MHz	$\pi/2$ BPSK / QPSK / 16QAM / 64QAM / 256QAM	1 RB / 0 RB Offset 1 RB / 13 RB Offset 1 RB / 23 RB Offset 12 RB / 0 RB Offset 12 RB / 7 RB Offset 12 RB / 13 RB Offset 25 RB / 0 RB Offset
		371000 to 382000	371000 (1855.0MHz), 376500 (1882.5MHz), 382000 (1910.0MHz)	10MHz	$\pi/2$ BPSK / QPSK / 16QAM / 64QAM / 256QAM	1 RB / 0 RB Offset 1 RB / 26 RB Offset 1 RB / 50 RB Offset 25 RB / 0 RB Offset 25 RB / 14 RB Offset 25 RB / 27 RB Offset 50 RB / 0 RB Offset
		371500 to 381500	371500 (1857.5MHz), 376500 (1882.5MHz), 381500 (1907.5MHz)	15MHz	$\pi/2$ BPSK / QPSK / 16QAM / 64QAM / 256QAM	1 RB / 0 RB Offset 1 RB / 40 RB Offset 1 RB / 77 RB Offset 36 RB / 0 RB Offset 36 RB / 22 RB Offset 36 RB / 43 RB Offset 75 RB / 0 RB Offset
		372000 to 381000	372000 (1860.0MHz), 376500 (1882.5MHz), 381000 (1905.0MHz)	20MHz	$\pi/2$ BPSK / QPSK / 16QAM / 64QAM / 256QAM	1 RB / 0 RB Offset 1 RB / 53 RB Offset 1 RB / 104 RB Offset 50RB / 0 RB Offset 50 RB / 28 RB Offset 50 RB / 56 RB Offset 100 RB / 0 RB Offset
-	Modulation characteristics	372000 to 381000	376500 (1882.5MHz)	20MHz	$\pi/2$ BPSK / QPSK / 16QAM / 64QAM / 256QAM	106 RB / 0 RB Offset
-	Frequency Stability	370500 to 382500	370500 (1852.5MHz), 382500 (1912.5MHz)	5MHz	$\pi/2$ BPSK	25 RB / 0 RB Offset
		371000 to 382000	371000 (1855.0MHz), 382000 (1910.0MHz)	10MHz	$\pi/2$ BPSK	52 RB / 0 RB Offset
		371500 to 381500	371500 (1857.5MHz), 381500 (1907.5MHz)	15MHz	$\pi/2$ BPSK	79 RB / 0 RB Offset
		372000 to 381000	372000 (1860.0MHz), 381000 (1905.0MHz)	20MHz	$\pi/2$ BPSK	106 RB / 0 RB Offset

EUT Configure Mode	Test item	Available channel	Tested channel	Channel Bandwidth	Modulation	Mode
-	Occupied Bandwidth	370500 to 382500	370500 (1852.5MHz), 376500 (1882.5MHz), 382500 (1912.5MHz)	5MHz	$\pi/2$ BPSK / QPSK / 16QAM / 64QAM / 256QAM	25 RB / 0 RB Offset
		371000 to 382000	371000 (1855.0MHz), 376500 (1882.5MHz), 382000 (1910.0MHz)	10MHz	$\pi/2$ BPSK / QPSK / 16QAM / 64QAM / 256QAM	52 RB / 0 RB Offset
		371500 to 381500	371500 (1857.5MHz), 376500 (1882.5MHz), 381500 (1907.5MHz)	15MHz	$\pi/2$ BPSK / QPSK / 16QAM / 64QAM / 256QAM	79 RB / 0 RB Offset
		372000 to 381000	372000 (1860.0MHz), 376500 (1882.5MHz), 381000 (1905.0MHz)	20MHz	$\pi/2$ BPSK / QPSK / 16QAM / 64QAM / 256QAM	106 RB / 0 RB Offset
-	Band Edge	370500 to 382500	370500 (1852.5MHz), 382500 (1912.5MHz)	5MHz	$\pi/2$ BPSK	1 RB / 0 RB Offset 1 RB / 24 RB Offset 25 RB / 0 RB Offset
		371000 to 382000	371000 (1855.0MHz), 382000 (1910.0MHz)	10MHz	$\pi/2$ BPSK	1 RB / 0 RB Offset 1 RB / 51 RB Offset 52 RB / 0 RB Offset
		371500 to 381500	371500 (1857.5MHz), 381500 (1907.5MHz)	15MHz	$\pi/2$ BPSK	1 RB / 0 RB Offset 1 RB / 78 RB Offset 79 RB / 0 RB Offset
		372000 to 381000	372000 (1860.0MHz), 381000 (1905.0MHz)	20MHz	$\pi/2$ BPSK	1 RB / 0 RB Offset 1 RB / 105 RB Offset 106 RB / 0 RB Offset
-	Peak to Average Ratio	370500 to 382500	370500 (1852.5MHz), 376500 (1882.5MHz), 382500 (1912.5MHz)	5MHz	$\pi/2$ BPSK / QPSK / 16QAM / 64QAM / 256QAM	1 RB / 0 RB Offset
		371000 to 382000	371000 (1855.0MHz), 376500 (1882.5MHz), 382000 (1910.0MHz)	10MHz	$\pi/2$ BPSK / QPSK / 16QAM / 64QAM / 256QAM	1 RB / 0 RB Offset
		371500 to 381500	371500 (1857.5MHz), 376500 (1882.5MHz), 381500 (1907.5MHz)	15MHz	$\pi/2$ BPSK / QPSK / 16QAM / 64QAM / 256QAM	1 RB / 0 RB Offset
		372000 to 381000	372000 (1860.0MHz), 376500 (1882.5MHz), 381000 (1905.0MHz)	20MHz	$\pi/2$ BPSK / QPSK / 16QAM / 64QAM / 256QAM	1 RB / 0 RB Offset

EUT Configure Mode	Test item	Available channel	Tested channel	Channel Bandwidth	Modulation	Mode
-	Conducted Emission	370500 to 382500	370500 (1852.5MHz), 376500 (1882.5MHz), 382500 (1912.5MHz)	5MHz	$\pi/2$ BPSK	1 RB / 0 RB Offset
		371000 to 382000	371000 (1855.0MHz), 376500 (1882.5MHz), 382000 (1910.0MHz)	10MHz	$\pi/2$ BPSK	1 RB / 0 RB Offset
		371500 to 381500	371500 (1857.5MHz), 376500 (1882.5MHz), 381500 (1907.5MHz)	15MHz	$\pi/2$ BPSK	1 RB / 0 RB Offset
		372000 to 381000	372000 (1860.0MHz), 376500 (1882.5MHz), 381000 (1905.0MHz)	20MHz	$\pi/2$ BPSK	1 RB / 0 RB Offset
-	Radiated Emission Below 1GHz	372000 to 381000	376500 (1882.5MHz)	20MHz	$\pi/2$ BPSK	1 RB / 0 RB Offset
-	Radiated Emission Above 1GHz	370500 to 382500	370500 (1852.5MHz), 376500 (1882.5MHz), 382500 (1912.5MHz)	5MHz	$\pi/2$ BPSK	1 RB / 0 RB Offset
		372000 to 381000	372000 (1860.0MHz), 376500 (1882.5MHz), 381000 (1905.0MHz)	20MHz	$\pi/2$ BPSK	1 RB / 0 RB Offset

Note:

1. For radiated emission below 1GHz, select the worst radiated emission channel (above 1GHz) for final testing.
2. Only output power, modulation characteristics, occupied bandwidth and Peak to average ratio items had been tested under  $\pi/2$  BPSK, QPSK, 16QAM, 64QAM and 256QAM modes, the other test items were performed under worse mode according to the maximum output power.



LTE Band 12

EUT Configure Mode	Test item	Available channel	Tested channel	Channel Bandwidth	Modulation	Mode
-	ERP	23017 to 23173	23017 (699.7MHz), 23095 (707.5MHz), 23173 (715.3MHz)	1.4MHz	QPSK / 16QAM / 64QAM / 256QAM	1 RB / 0 RB Offset 1 RB / 2 RB Offset 1 RB / 5 RB Offset 3 RB / 0 RB Offset 3 RB / 1 RB Offset 3 RB / 3 RB Offset 6 RB / 0 RB Offset
		23025 to 23165	23025 (700.5MHz), 23095 (707.5MHz), 23165 (714.5MHz)	3MHz	QPSK / 16QAM / 64QAM / 256QAM	1 RB / 0 RB Offset 1 RB / 7 RB Offset 1 RB / 14 RB Offset 8 RB / 0 RB Offset 8 RB / 3 RB Offset 8 RB / 7 RB Offset 15 RB / 0 RB Offset
		23035 to 23155	23035 (701.5MHz), 23095 (707.5MHz), 23155 (713.5MHz)	5MHz	QPSK / 16QAM / 64QAM / 256QAM	1 RB / 0 RB Offset 1 RB / 12 RB Offset 1 RB / 24 RB Offset 12 RB / 0 RB Offset 12 RB / 6 RB Offset 12 RB / 13 RB Offset 25 RB / 0 RB Offset
		23060 to 23130	23060 (704.0MHz), 23095 (707.5MHz), 23130 (711.0 MHz)	10MHz	QPSK / 16QAM / 64QAM / 256QAM	1 RB / 0 RB Offset 1 RB / 24 RB Offset 1 RB / 49 RB Offset 25 RB / 0 RB Offset 25 RB / 12 RB Offset 25 RB / 25 RB Offset 50 RB / 0 RB Offset
-	Modulation characteristics	23060 to 23130	23095(707.5MHz)	10MHz	QPSK	50 RB / 0 RB Offset
-	Frequency Stability	23017 to 23173	23017(699.7MHz), 23173(715.3MHz)	1.4MHz	QPSK	6 RB / 0 RB Offset
		23025 to 23165	23025(700.5MHz), 23165(714.5MHz)	3MHz	QPSK	15 RB / 0 RB Offset
		23035 to 23155	23035(701.5MHz), 23155(713.5MHz)	5MHz	QPSK	25 RB / 0 RB Offset
		23060 to 23130	23060(704.0MHz), 23130(711.0MHz)	10MHz	QPSK	50 RB / 0 RB Offset
-	Emission Bandwidth	23017 to 23173	23017(699.7MHz), 23095(707.5MHz), 23173(715.3MHz)	1.4MHz	QPSK / 16QAM / 64QAM / 256QAM	6 RB / 0 RB Offset
		23025 to 23165	23025(700.5MHz), 23095(707.5MHz), 23165(714.5MHz)	3MHz	QPSK / 16QAM / 64QAM / 256QAM	15 RB / 0 RB Offset
		23035 to 23155	23035(701.5MHz), 23095(707.5MHz), 23155(713.5MHz)	5MHz	QPSK / 16QAM / 64QAM / 256QAM	25 RB / 0 RB Offset
		23060 to 23130	23060(704.0MHz), 23095(707.5MHz), 23130(711.0MHz)	10MHz	QPSK / 16QAM / 64QAM / 256QAM	50 RB / 0 RB Offset

EUT Configure Mode	Test item	Available channel	Tested channel	Channel Bandwidth	Modulation	Mode
-	Band Edge	23017 to 23173	23017(699.7MHz), 23173(715.3MHz)	1.4MHz	QPSK	1 RB / 0 RB Offset 1 RB / 5 RB Offset 6 RB / 0 RB Offset
		23025 to 23165	23025(700.5MHz), 23165(714.5MHz)	3MHz	QPSK	1 RB / 0 RB Offset 1 RB / 14 RB Offset 15 RB / 0 RB Offset
		23035 to 23155	23035(701.5MHz), 23155(713.5MHz)	5MHz	QPSK	1 RB / 0 RB Offset 1 RB / 24 RB Offset 25 RB / 0 RB Offset
		23060 to 23130	23060(704.0MHz), 23130(711.0MHz)	10MHz	QPSK	1 RB / 0 RB Offset 1 RB / 49 RB Offset 50 RB / 0 RB Offset
-	Peak to Average Ratio	23017 to 23173	23017(699.7MHz), 23095(707.5MHz), 23173(715.3MHz)	1.4MHz	QPSK / 16QAM / 64QAM / 256QAM	1 RB / 2 RB Offset
		23025 to 23165	23025(700.5MHz), 23095(707.5MHz), 23165(714.5MHz)	3MHz	QPSK / 16QAM / 64QAM / 256QAM	1 RB / 0 RB Offset
		23035 to 23155	23035(701.5MHz), 23095(707.5MHz), 23155(713.5MHz)	5MHz	QPSK / 16QAM / 64QAM / 256QAM	1 RB / 12 RB Offset
		23060 to 23130	23060(704.0MHz), 23095(707.5MHz), 23130(711.0MHz)	10MHz	QPSK / 16QAM / 64QAM / 256QAM	1 RB / 49 RB Offset
-	Conducted Emission	23017 to 23173	23017(699.7MHz), 23095(707.5MHz), 23173(715.3MHz)	1.4MHz	QPSK	1 RB / 2 RB Offset
		23025 to 23165	23025(700.5MHz), 23095(707.5MHz), 23165(714.5MHz)	3MHz	QPSK	1 RB / 0 RB Offset
		23035 to 23155	23035(701.5MHz), 23095(707.5MHz), 23155(713.5MHz)	5MHz	QPSK	1 RB / 12 RB Offset
		23060 to 23130	23060(704.0MHz), 23095(707.5MHz), 23130(711.0MHz)	10MHz	QPSK	1 RB / 49 RB Offset
-	Radiated Emission Below 1GHz	23060 to 23130	23095 (707.5MHz)	10MHz	QPSK	1 RB / 0 RB Offset
-	Radiated Emission Above 1GHz	23017 to 23173	23017 (699.7MHz), 23095 (707.5MHz), 23173 (715.3MHz)	1.4MHz	QPSK	1 RB / 0 RB Offset
		23035 to 23155	23035 (701.5MHz), 23095 (707.5MHz), 23155 (713.5MHz)	5MHz	QPSK	1 RB / 0 RB Offset
		23060 to 23130	23060 (704.0MHz), 23095 (707.5MHz), 23130 (711.0MHz)	10MHz	QPSK	1 RB / 0 RB Offset

Note:

1. For radiated emission below 1GHz, select the worst radiated emission channel (above 1GHz) for final testing.
2. The output power for QPSK, 16QAM, 64QAM and 256QAM, measured value of QPSK is higher than 16QAM, 64QAM and 256QAM mode. Therefore the radiated emission test items was performed under QPSK mode only.

Test Condition:

Test Item	Environmental Conditions	Input Power	Tested By
EIRP / ERP	25deg. C, 70%RH	5Vdc	James Yang
Modulation Characteristics	24deg. C, 64%RH	5Vdc	James Yang
Frequency Stability	24deg. C, 64%RH	5Vdc	James Yang
Occupied Bandwidth	24deg. C, 64%RH	5Vdc	James Yang
Band Edge	24deg. C, 64%RH	5Vdc	James Yang
Peak To Average Ratio	24deg. C, 64%RH	5Vdc	James Yang
Conducted Emission	24deg. C, 64%RH	5Vdc	James Yang
Radiated Emission	23deg. C, 67%RH	120Vac, 60Hz	Adair Peng

### 3.4 EUT Operating Conditions

The EUT makes a call to the communication simulator. The communication simulator station system controlled a EUT to export maximum output power under transmission mode and specific channel frequency

### 3.5 General Description of Applied Standards and References

The EUT is a RF Product. According to the specifications of the manufacturer, it must comply with the requirements of the following standards:

**Test Standard:**

**FCC 47 CFR Part 2**

**FCC 47 CFR Part 24**

**FCC 47 CFR Part 27**

**ANSI/TIA/EIA-603-D-2010**

**ANSI/TIA/EIA-603-E 2016**

ANSI 63.26-2015

**References Test Guidance:**

**KDB 971168 D01 Power Meas License Digital Systems v03r01**

**KDB 971168 D02 Misc Rev Approv License Devices v02r01**

All test items have been performed and recorded as per the above standards.

## 4 Test Types and Results

### 4.1 Output Power Measurement

#### 4.1.1 Limits of Output Power Measurement

For n25:

Mobile / Portable station are limited to 2 watts e.i.r.p.

For LTE Band 12:

Control and mobile stations in the 698-746 MHz band are limited to 30 watts ERP.

Portable stations (hand-held devices) in the 600 MHz uplink band and the 698-746 MHz band, and fixed and mobile stations in the 600 MHz uplink band are limited to 3 watts ERP.

#### 4.1.2 Test Procedures

##### Conducted Power Measurement:

The EUT was set up for the maximum power with 5GNR and LTE link data modulation and link up with simulator. Set the EUT to transmit under low, middle and high channel and record the power level shown on simulator.

##### Maximum EIRP / ERP

The relevant equation for determining the maximum ERP or EIRP from the measured RF output power is given in Equation as follows:

$$\text{EIRP} = P_{\text{Meas}} + G_T$$

$$\text{ERP} = P_{\text{Meas}} + G_T - 2.15$$

where

ERP or EIRP effective radiated power or equivalent isotropically radiated power, respectively  
(expressed in the same units as  $P_{\text{Meas}}$ , e.g., dBm or dBW)

$P_{\text{Meas}}$  measured transmitter output power or PSD, in dBm or dBW

$G_T$  gain of the transmitting antenna, in dBd (ERP) or dBi (EIRP)

#### 4.1.3 Test Setup

Conducted Power Measurement:



#### 4.1.4 Test Results

##### Conducted Output Power (dBm)

5GNR n25						
BW	MCS Index	Channel		372000	376500	381000
		Frequency (MHz)		1860	1882.5	1905
20M	$\pi/2$ BPSK	1	0	25.21	25.08	25.05
		1	53	25.16	25.09	24.94
		1	105	25.04	24.90	25.05
		54	0	24.62	24.65	24.90
		54	26	24.85	24.78	24.75
		54	52	24.87	24.69	24.80
		100	0	24.77	24.80	24.81
	QPSK	1	0	24.76	24.76	24.85
		1	53	24.84	24.76	24.81
		1	105	24.89	24.79	24.75
		53	0	24.45	24.44	24.60
		53	53	24.50	24.40	24.67
		53	50	24.52	24.55	24.41
		106	0	24.47	24.47	24.60
	16QAM	1	0	23.47	23.48	23.58
		1	53	23.55	23.58	23.62
		1	105	23.48	23.68	23.57
		53	0	23.48	23.27	23.35
		53	53	23.49	23.46	23.46
		53	50	23.43	23.35	23.36
		106	0	23.45	23.38	23.44
	64QAM	1	0	22.72	22.52	22.70
		1	53	22.68	22.50	22.80
		1	105	22.59	22.50	22.75
		53	0	22.27	22.26	22.43
		53	53	22.30	22.23	22.37
		53	50	22.46	22.24	22.34
		106	0	22.24	22.38	22.49
	256QAM	1	0	20.63	20.90	20.84
		1	53	20.61	20.84	20.85
		1	105	20.72	20.65	20.88
		53	0	20.33	20.60	20.41
		53	53	20.55	20.45	20.60
		53	50	20.34	20.47	20.51
		106	0	20.48	20.52	20.55

5GNR n25						
BW	MCS Index	Channel		371500	376500	381500
		Frequency (MHz)		1857.5	1882.5	1907.5
15M	$\pi/2$ BPSK	1	0	25.19	25.13	25.06
		1	39	25.09	24.92	24.91
		1	78	25.20	25.05	24.90
		39	0	24.66	24.67	24.83
		39	19	24.81	24.80	24.65
		39	40	24.83	24.88	24.79
		75	0	24.90	24.77	24.79
	QPSK	1	0	24.72	24.90	24.89
		1	39	24.82	24.90	24.95
		1	78	24.92	24.75	24.70
		39	0	24.70	24.52	24.70
		39	19	24.66	24.47	24.61
		39	40	24.49	24.49	24.40
		79	0	24.46	24.59	24.53
	16QAM	1	0	23.46	23.44	23.41
		1	39	23.56	23.55	23.48
		1	78	23.56	23.54	23.40
		39	0	23.38	23.32	23.48
		39	19	23.44	23.27	23.43
		39	40	23.22	23.41	23.31
		79	0	23.24	23.28	23.30
	64QAM	1	0	22.50	22.56	22.56
		1	39	22.72	22.57	22.79
		1	78	22.64	22.60	22.78
		39	0	22.31	22.23	22.48
		39	19	22.28	22.43	22.20
		39	40	22.22	22.27	22.21
		79	0	22.32	22.39	22.45
	256QAM	1	0	20.60	20.78	20.81
		1	39	20.77	20.68	20.62
		1	78	20.73	20.66	20.78
		39	0	20.45	20.39	20.42
		39	19	20.58	20.40	20.39
		39	40	20.40	20.38	20.57
		79	0	20.33	20.38	20.34

5GNR n25						
BW	MCS Index	Channel		371000	376500	382000
		Frequency (MHz)		1855	1882.5	1910
10M	$\pi/2$ BPSK	1	0	25.04	24.96	24.92
		1	26	25.13	24.93	25.01
		1	51	25.03	25.17	25.00
		26	0	24.67	24.85	24.80
		26	13	24.66	24.85	24.71
		26	26	24.61	24.63	24.83
		51	0	24.67	24.78	24.79
	QPSK	1	0	24.89	24.73	24.97
		1	26	24.72	24.97	24.81
		1	51	24.89	24.71	24.94
		26	0	24.56	24.47	24.45
		26	13	24.60	24.63	24.51
		26	26	24.52	24.60	24.40
		52	0	24.49	24.54	24.67
	16QAM	1	0	23.45	23.52	23.70
		1	26	23.47	23.66	23.64
		1	51	23.42	23.47	23.66
		26	0	23.39	23.48	23.27
		26	13	23.35	23.38	23.50
		26	26	23.45	23.46	23.20
		52	0	23.40	23.33	23.34
	64QAM	1	0	22.63	22.69	22.52
		1	26	22.58	22.57	22.53
		1	51	22.73	22.58	22.78
		26	0	22.30	22.48	22.44
		26	13	22.35	22.20	22.41
		26	26	22.20	22.31	22.36
		52	0	22.25	22.38	22.20
	256QAM	1	0	20.83	20.79	20.75
		1	26	20.70	20.62	20.71
		1	51	20.80	20.71	20.72
		26	0	20.45	20.51	20.51
		26	13	20.55	20.44	20.57
		26	26	20.30	20.59	20.54
		52	0	20.43	20.52	20.53

5GNR n25						
BW	MCS Index	Channel		370500	376500	382500
		Frequency (MHz)		1852.5	1882.5	1912.5
5M	$\pi/2$ BPSK	1	0	25.01	24.98	24.99
		1	12	25.01	25.07	25.12
		1	24	24.93	25.05	24.93
		12	0	24.63	24.90	24.75
		12	6	24.69	24.62	24.65
		12	13	24.81	24.76	24.80
		24	0	24.76	24.73	24.80
	QPSK	1	0	24.84	24.96	24.99
		1	12	25.00	24.87	24.99
		1	24	24.77	24.75	24.92
		12	0	24.42	24.64	24.68
		12	6	24.41	24.49	24.42
		12	13	24.47	24.54	24.53
		25	0	24.46	24.46	24.61
	16QAM	1	0	23.69	23.41	23.43
		1	12	23.48	23.58	23.57
		1	24	23.62	23.59	23.65
		12	0	23.34	23.40	23.38
		12	6	23.26	23.20	23.47
		12	13	23.50	23.42	23.49
		25	0	23.29	23.34	23.47
	64QAM	1	0	22.79	22.79	22.52
		1	12	22.75	22.71	22.74
		1	24	22.69	22.79	22.55
		12	0	22.49	22.21	22.22
		12	6	22.32	22.23	22.46
		12	13	22.22	22.23	22.44
		25	0	22.20	22.41	22.33
	256QAM	1	0	20.77	20.86	20.78
		1	12	20.80	20.65	20.62
		1	24	20.83	20.76	20.81
		12	0	20.53	20.33	20.43
		12	6	20.35	20.31	20.46
		12	13	20.35	20.46	20.51
		25	0	20.52	20.38	20.52



LTE Band 12						
BW	MCS Index	RB Size	RB Offset	Low	Mid	High
		Channel		23060	23095	23130
		Frequency (MHz)		704	707.5	711
10M	QPSK	1	0	24.89	24.94	24.82
		1	24	24.72	24.84	24.93
		1	49	24.82	24.79	24.65
		25	0	23.93	23.89	23.93
		25	12	23.96	23.88	24.01
		25	25	23.97	24.01	24.04
		50	0	24.07	23.90	23.99
10M	16QAM	1	0	24.32	24.35	23.94
		1	24	24.56	24.45	24.17
		1	49	24.25	24.00	24.23
		25	0	22.99	22.96	22.97
		25	12	23.02	22.95	23.03
		25	25	22.96	22.94	23.01
		50	0	23.02	22.95	23.03
10M	64QAM	1	0	23.22	23.33	22.99
		1	24	23.46	23.17	23.15
		1	49	22.96	23.04	23.01
		25	0	22.18	21.92	21.80
		25	12	22.12	21.86	21.74
		25	25	22.01	21.78	21.91
		50	0	21.78	21.67	22.05
10M	256QAM	1	0	21.02	21.26	20.79
		1	24	21.34	20.89	21.37
		1	49	20.73	21.32	20.87
		25	0	20.19	19.71	19.82
		25	12	20.23	19.86	19.55
		25	25	20.21	19.58	19.62
		50	0	19.94	19.95	19.79

LTE Band 12						
BW	MCS Index	RB Size	RB Offset	Low	Mid	High
		Channel		23035	23095	23155
		Frequency (MHz)		701.5	707.5	713.5
5M	QPSK	1	0	24.86	24.84	24.81
		1	12	25.04	24.88	24.70
		1	24	24.91	24.91	24.89
		12	0	24.04	23.94	23.89
		12	6	24.03	23.90	23.96
		12	13	23.98	23.97	23.93
		25	0	23.94	23.86	23.86
5M	16QAM	1	0	24.21	24.09	23.75
		1	12	24.40	24.04	24.22
		1	24	23.84	24.02	24.38
		12	0	23.10	22.90	22.85
		12	6	22.95	22.93	22.96
		12	13	22.96	23.01	22.89
		25	0	22.91	22.94	22.91
5M	64QAM	1	0	22.99	23.25	22.92
		1	12	23.44	23.04	23.39
		1	24	22.90	23.12	23.18
		12	0	22.06	21.96	21.64
		12	6	21.77	22.05	21.84
		12	13	21.80	21.76	21.95
		25	0	22.05	22.06	22.09
5M	256QAM	1	0	20.77	21.32	21.21
		1	12	21.38	21.10	21.12
		1	24	21.14	21.14	20.98
		12	0	20.00	20.17	19.52
		12	6	20.07	19.89	20.08
		12	13	19.60	19.64	19.76
		25	0	20.35	20.14	20.22

LTE Band 12						
BW	MCS Index	RB Size	RB Offset	Low	Mid	High
		Channel		23025	23095	23165
		Frequency (MHz)		700.5	707.5	714.5
3M	QPSK	1	0	25.00	24.90	24.82
		1	7	24.83	24.95	24.79
		1	14	24.80	24.79	24.81
		8	0	23.96	23.89	23.85
		8	3	24.01	23.94	23.85
		8	7	23.89	23.88	23.87
		15	0	24.02	23.90	23.83
3M	16QAM	1	0	24.16	24.32	24.06
		1	7	24.06	24.00	24.21
		1	14	24.09	24.41	23.76
		8	0	22.86	23.00	22.86
		8	3	23.15	22.97	22.88
		8	7	23.04	22.91	22.83
		15	0	23.05	22.88	22.78
3M	64QAM	1	0	23.31	23.08	22.81
		1	7	22.93	23.02	23.37
		1	14	22.91	23.35	22.84
		8	0	21.96	22.11	21.62
		8	3	21.93	22.15	21.66
		8	7	21.97	21.87	21.79
		15	0	22.01	22.08	21.86
3M	256QAM	1	0	21.30	21.31	21.08
		1	7	21.11	21.20	21.59
		1	14	20.96	21.38	20.94
		8	0	20.17	20.11	19.78
		8	3	20.11	19.89	19.95
		8	7	20.04	20.15	19.73
		15	0	20.31	20.11	19.96

LTE Band 12						
BW	MCS Index	RB Size	RB Offset	Low	Mid	High
		Channel		23017	23095	23173
		Frequency (MHz)		699.7	707.5	715.3
1.4M	QPSK	1	0	24.81	24.83	24.74
		1	2	24.92	24.82	24.77
		1	5	24.77	24.69	24.66
		3	0	24.82	24.75	24.68
		3	1	24.94	24.72	24.74
		3	3	24.82	24.83	24.68
		6	0	23.96	23.87	23.76
1.4M	16QAM	1	0	24.38	24.20	23.90
		1	2	24.12	24.07	24.05
		1	5	24.08	24.21	23.71
		3	0	23.91	23.83	23.77
		3	1	24.03	23.95	23.68
		3	3	23.92	23.86	23.84
		6	0	23.11	23.01	22.88
1.4M	64QAM	1	0	23.21	23.18	22.66
		1	2	23.14	23.06	23.01
		1	5	23.04	23.39	22.48
		3	0	23.01	22.65	22.70
		3	1	23.14	22.79	22.43
		3	3	22.70	22.70	22.54
		6	0	22.19	22.13	21.76
1.4M	256QAM	1	0	21.07	21.17	20.54
		1	2	21.28	21.31	20.77
		1	5	21.18	21.49	20.36
		3	0	20.77	20.57	20.64
		3	1	21.18	20.90	20.68
		3	3	20.83	20.44	20.26
		6	0	20.32	20.18	19.89

**EIRP / ERP Power (dBm)**

5G NR n25						
BW	MCS Index	Channel		372000	376500	381000
		Frequency (MHz)		1860	1882.5	1905
20M	$\pi/2$ BPSK	1	0	29.48	29.35	29.32
		1	53	29.43	29.36	29.21
		1	105	29.31	29.17	29.32
		54	0	28.89	28.92	29.17
		54	26	29.12	29.05	29.02
		54	52	29.14	28.96	29.07
		100	0	29.04	29.07	29.08
	QPSK	1	0	29.03	29.03	29.12
		1	53	29.11	29.03	29.08
		1	105	29.16	29.06	29.02
		53	0	28.72	28.71	28.87
		53	53	28.77	28.67	28.94
		53	50	28.79	28.82	28.68
		106	0	28.74	28.74	28.87
	16QAM	1	0	27.74	27.75	27.85
		1	53	27.82	27.85	27.89
		1	105	27.75	27.95	27.84
		53	0	27.75	27.54	27.62
		53	53	27.76	27.73	27.73
		53	50	27.70	27.62	27.63
		106	0	27.72	27.65	27.71
	64QAM	1	0	26.99	26.79	26.97
		1	53	26.95	26.77	27.07
		1	105	26.86	26.77	27.02
		53	0	26.54	26.53	26.70
		53	53	26.57	26.50	26.64
		53	50	26.73	26.51	26.61
		106	0	26.51	26.65	26.76
	256QAM	1	0	24.90	25.17	25.11
		1	53	24.88	25.11	25.12
		1	105	24.99	24.92	25.15
		53	0	24.60	24.87	24.68
		53	53	24.82	24.72	24.87
		53	50	24.61	24.74	24.78
		106	0	24.75	24.79	24.82

\*EIRP = Conducted + antenna gain (4.27dBi)

5GNR n25						
BW	MCS Index	Channel		371500	376500	381500
		Frequency (MHz)		1857.5	1882.5	1907.5
15M	$\pi/2$ BPSK	1	0	29.46	29.40	29.33
		1	39	29.36	29.19	29.18
		1	78	29.47	29.32	29.17
		39	0	28.93	28.94	29.10
		39	19	29.08	29.07	28.92
		39	40	29.10	29.15	29.06
		75	0	29.17	29.04	29.06
	QPSK	1	0	28.99	29.17	29.16
		1	39	29.09	29.17	29.22
		1	78	29.19	29.02	28.97
		39	0	28.97	28.79	28.97
		39	19	28.93	28.74	28.88
		39	40	28.76	28.76	28.67
		79	0	28.73	28.86	28.80
	16QAM	1	0	27.73	27.71	27.68
		1	39	27.83	27.82	27.75
		1	78	27.83	27.81	27.67
		39	0	27.65	27.59	27.75
		39	19	27.71	27.54	27.70
		39	40	27.49	27.68	27.58
		79	0	27.51	27.55	27.57
	64QAM	1	0	26.77	26.83	26.83
		1	39	26.99	26.84	27.06
		1	78	26.91	26.87	27.05
		39	0	26.58	26.50	26.75
		39	19	26.55	26.70	26.47
		39	40	26.49	26.54	26.48
		79	0	26.59	26.66	26.72
	256QAM	1	0	24.87	25.05	25.08
		1	39	25.04	24.95	24.89
1		78	25.00	24.93	25.05	
39		0	24.72	24.66	24.69	
39		19	24.85	24.67	24.66	
39		40	24.67	24.65	24.84	
79		0	24.60	24.65	24.61	

\*EIRP = Conducted + antenna gain (4.27dBi)

5GNR n25						
BW	MCS Index	Channel		371000	376500	382000
		Frequency (MHz)		1855	1882.5	1910
10M	$\pi/2$ BPSK	1	0	29.31	29.23	29.19
		1	26	29.40	29.20	29.28
		1	51	29.30	29.44	29.27
		26	0	28.94	29.12	29.07
		26	13	28.93	29.12	28.98
		26	26	28.88	28.90	29.10
		51	0	28.94	29.05	29.06
	QPSK	1	0	29.16	29.00	29.24
		1	26	28.99	29.24	29.08
		1	51	29.16	28.98	29.21
		26	0	28.83	28.74	28.72
		26	13	28.87	28.90	28.78
		26	26	28.79	28.87	28.67
		52	0	28.76	28.81	28.94
	16QAM	1	0	27.72	27.79	27.97
		1	26	27.74	27.93	27.91
		1	51	27.69	27.74	27.93
		26	0	27.66	27.75	27.54
		26	13	27.62	27.65	27.77
		26	26	27.72	27.73	27.47
		52	0	27.67	27.60	27.61
	64QAM	1	0	26.90	26.96	26.79
		1	26	26.85	26.84	26.80
		1	51	27.00	26.85	27.05
		26	0	26.57	26.75	26.71
		26	13	26.62	26.47	26.68
		26	26	26.47	26.58	26.63
		52	0	26.52	26.65	26.47
	256QAM	1	0	25.10	25.06	25.02
		1	26	24.97	24.89	24.98
		1	51	25.07	24.98	24.99
		26	0	24.72	24.78	24.78
		26	13	24.82	24.71	24.84
		26	26	24.57	24.86	24.81
		52	0	24.70	24.79	24.80

\*EIRP = Conducted + antenna gain (4.27dBi)

5GNR n25						
BW	MCS Index	Channel		370500	376500	382500
		Frequency (MHz)		1852.5	1882.5	1912.5
5M	$\pi/2$ BPSK	1	0	29.28	29.25	29.26
		1	12	29.28	29.34	29.39
		1	24	29.20	29.32	29.20
		12	0	28.90	29.17	29.02
		12	6	28.96	28.89	28.92
		12	13	29.08	29.03	29.07
		24	0	29.03	29.00	29.07
	QPSK	1	0	29.11	29.23	29.26
		1	12	29.27	29.14	29.26
		1	24	29.04	29.02	29.19
		12	0	28.69	28.91	28.95
		12	6	28.68	28.76	28.69
		12	13	28.74	28.81	28.80
		25	0	28.73	28.73	28.88
	16QAM	1	0	27.96	27.68	27.70
		1	12	27.75	27.85	27.84
		1	24	27.89	27.86	27.92
		12	0	27.61	27.67	27.65
		12	6	27.53	27.47	27.74
		12	13	27.77	27.69	27.76
		25	0	27.56	27.61	27.74
	64QAM	1	0	27.06	27.06	26.79
		1	12	27.02	26.98	27.01
		1	24	26.96	27.06	26.82
		12	0	26.76	26.48	26.49
		12	6	26.59	26.50	26.73
		12	13	26.49	26.50	26.71
		25	0	26.47	26.68	26.60
	256QAM	1	0	25.04	25.13	25.05
		1	12	25.07	24.92	24.89
		1	24	25.10	25.03	25.08
		12	0	24.80	24.60	24.70
		12	6	24.62	24.58	24.73
		12	13	24.62	24.73	24.78
		25	0	24.79	24.65	24.79

\*EIRP = Conducted + antenna gain (4.27dBi)



LTE Band 12						
BW	MCS Index	RB Size	RB Offset	Low	Mid	High
		Channel		23060	23095	23130
		Frequency (MHz)		704	707.5	711
10M	QPSK	1	0	27.15	27.20	27.08
		1	24	26.98	27.10	27.19
		1	49	27.08	27.05	26.91
		25	0	26.19	26.15	26.19
		25	12	26.22	26.14	26.27
		25	25	26.23	26.27	26.30
		50	0	26.33	26.16	26.25
10M	16QAM	1	0	26.58	26.61	26.20
		1	24	26.82	26.71	26.43
		1	49	26.51	26.26	26.49
		25	0	25.25	25.22	25.23
		25	12	25.28	25.21	25.29
		25	25	25.22	25.20	25.27
		50	0	25.28	25.21	25.29
10M	64QAM	1	0	25.48	25.59	25.25
		1	24	25.72	25.43	25.41
		1	49	25.22	25.30	25.27
		25	0	24.44	24.18	24.06
		25	12	24.38	24.12	24.00
		25	25	24.27	24.04	24.17
		50	0	24.04	23.93	24.31
10M	256QAM	1	0	23.28	23.52	23.05
		1	24	23.60	23.15	23.63
		1	49	22.99	23.58	23.13
		25	0	22.45	21.97	22.08
		25	12	22.49	22.12	21.81
		25	25	22.47	21.84	21.88
		50	0	22.20	22.21	22.05

\*ERP = Conducted + antenna gain (4.41dBi)-2.15

LTE Band 12						
BW	MCS Index	RB Size	RB Offset	Low	Mid	High
		Channel		23035	23095	23155
		Frequency (MHz)		701.5	707.5	713.5
5M	QPSK	1	0	27.12	27.10	27.07
		1	12	27.30	27.14	26.96
		1	24	27.17	27.17	27.15
		12	0	26.30	26.20	26.15
		12	6	26.29	26.16	26.22
		12	13	26.24	26.23	26.19
		25	0	26.20	26.12	26.12
5M	16QAM	1	0	26.47	26.35	26.01
		1	12	26.66	26.30	26.48
		1	24	26.10	26.28	26.64
		12	0	25.36	25.16	25.11
		12	6	25.21	25.19	25.22
		12	13	25.22	25.27	25.15
		25	0	25.17	25.20	25.17
5M	64QAM	1	0	25.25	25.51	25.18
		1	12	25.70	25.30	25.65
		1	24	25.16	25.38	25.44
		12	0	24.32	24.22	23.90
		12	6	24.03	24.31	24.10
		12	13	24.06	24.02	24.21
		25	0	24.31	24.32	24.35
5M	256QAM	1	0	23.03	23.58	23.47
		1	12	23.64	23.36	23.38
		1	24	23.40	23.40	23.24
		12	0	22.26	22.43	21.78
		12	6	22.33	22.15	22.34
		12	13	21.86	21.90	22.02
		25	0	22.61	22.40	22.48

\*ERP = Conducted + antenna gain (4.41dBi)-2.15

LTE Band 12						
BW	MCS Index	RB Size	RB Offset	Low	Mid	High
		Channel		23025	23095	23165
		Frequency (MHz)		700.5	707.5	714.5
3M	QPSK	1	0	27.26	27.16	27.08
		1	7	27.09	27.21	27.05
		1	14	27.06	27.05	27.07
		8	0	26.22	26.15	26.11
		8	3	26.27	26.20	26.11
		8	7	26.15	26.14	26.13
		15	0	26.28	26.16	26.09
3M	16QAM	1	0	26.42	26.58	26.32
		1	7	26.32	26.26	26.47
		1	14	26.35	26.67	26.02
		8	0	25.12	25.26	25.12
		8	3	25.41	25.23	25.14
		8	7	25.30	25.17	25.09
		15	0	25.31	25.14	25.04
3M	64QAM	1	0	25.57	25.34	25.07
		1	7	25.19	25.28	25.63
		1	14	25.17	25.61	25.10
		8	0	24.22	24.37	23.88
		8	3	24.19	24.41	23.92
		8	7	24.23	24.13	24.05
		15	0	24.27	24.34	24.12
3M	256QAM	1	0	23.56	23.57	23.34
		1	7	23.37	23.46	23.85
		1	14	23.22	23.64	23.20
		8	0	22.43	22.37	22.04
		8	3	22.37	22.15	22.21
		8	7	22.30	22.41	21.99
		15	0	22.57	22.37	22.22

\*ERP = Conducted + antenna gain (4.41dBi)-2.15

LTE Band 12						
BW	MCS Index	RB Size	RB Offset	Low	Mid	High
		Channel		23017	23095	23173
		Frequency (MHz)		699.7	707.5	715.3
1.4M	QPSK	1	0	27.07	27.09	27.00
		1	2	27.18	27.08	27.03
		1	5	27.03	26.95	26.92
		3	0	27.08	27.01	26.94
		3	1	27.20	26.98	27.00
		3	3	27.08	27.09	26.94
		6	0	26.22	26.13	26.02
1.4M	16QAM	1	0	26.64	26.46	26.16
		1	2	26.38	26.33	26.31
		1	5	26.34	26.47	25.97
		3	0	26.17	26.09	26.03
		3	1	26.29	26.21	25.94
		3	3	26.18	26.12	26.10
		6	0	25.37	25.27	25.14
1.4M	64QAM	1	0	25.47	25.44	24.92
		1	2	25.40	25.32	25.27
		1	5	25.30	25.65	24.74
		3	0	25.27	24.91	24.96
		3	1	25.40	25.05	24.69
		3	3	24.96	24.96	24.80
		6	0	24.45	24.39	24.02
1.4M	256QAM	1	0	23.33	23.43	22.80
		1	2	23.54	23.57	23.03
		1	5	23.44	23.75	22.62
		3	0	23.03	22.83	22.90
		3	1	23.44	23.16	22.94
		3	3	23.09	22.70	22.52
		6	0	22.58	22.44	22.15

\*ERP = Conducted + antenna gain (4.41dBi)-2.15

## 4.2 Modulation Characteristics Measurement

### 4.2.1 Limits of Modulation Characteristics

N/A

### 4.2.2 Test Procedure

Connect the EUT to Communication Simulator via the antenna connector, The frequency band is set as EUT supported Modulation and Channels, the EUT output is matched with 50 ohm load, the waveform quality and constellation of the EUT was tested.

### 4.2.3 Test Setup



### 4.2.4 Test Results

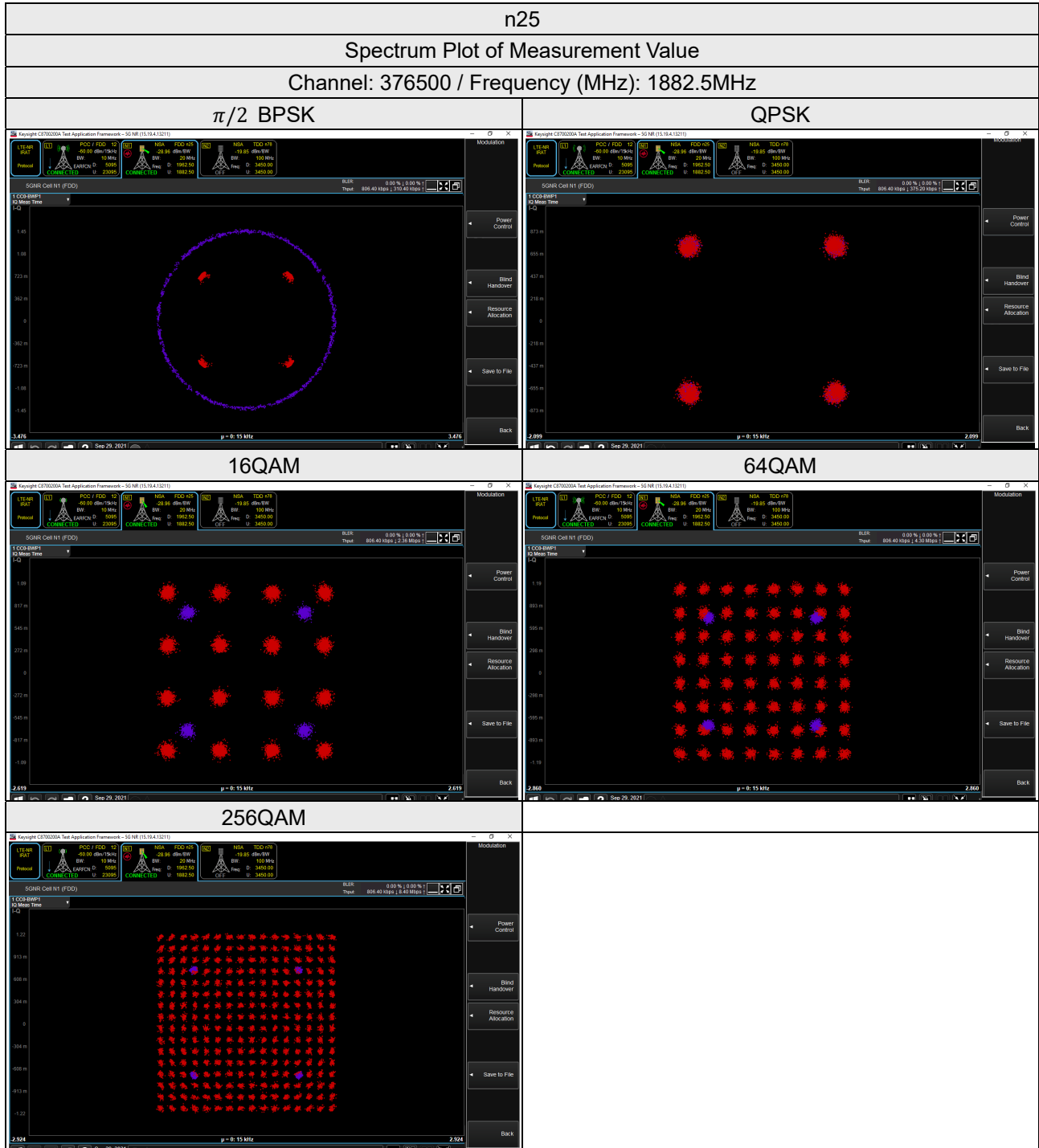

## LTE Band 12

### Spectrum Plot of Measurement Value

Channel: 23095 / Frequency (MHz): 707.5 MHz

#### QPSK

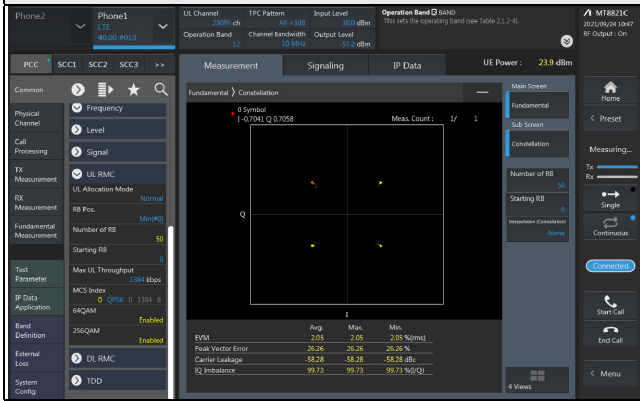

#### 16QAM

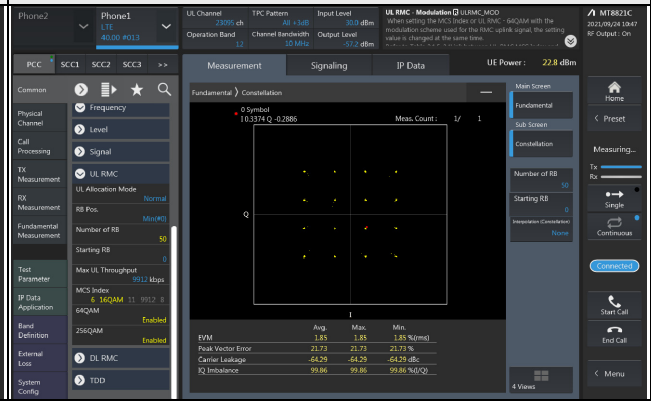

#### 64QAM

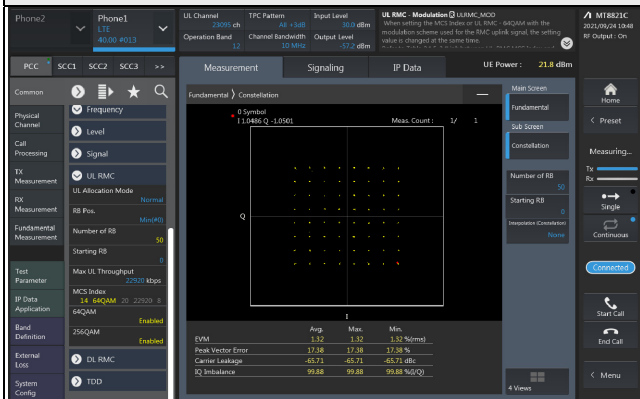

#### 256QAM

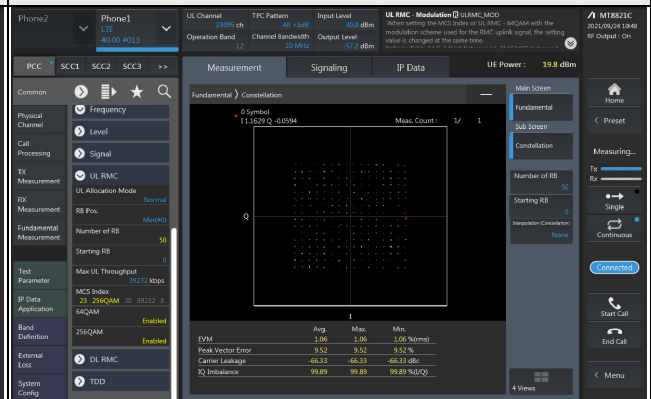

### 4.3 Frequency Stability Measurement

#### 4.3.1 Limits of Frequency Stability Measurement

The frequency stability shall be sufficient to ensure that the fundamental emissions stay within the authorized bands of operation.

According to the FCC part 2.1055 shall be tested the frequency stability. The rule is defined that "The frequency stability shall be sufficient to ensure that the fundamental emission stays within the authorized frequency block." The test extreme voltage is according to the 2.1055(d)(1) Vary primary supply voltage from 85 to 115 percent of the nominal value for other than hand carried battery equipment and the extreme temperature rule is comply with specification of EUT  $-30^{\circ}\text{C} \sim 50^{\circ}\text{C}$ .

#### 4.3.2 Test Procedure

- Device is placed at the oven room. The oven room could control the temperatures and humidity. Power warm up is at least 15 min and power applied should perform before recording frequency error.
- EUT is connected the external power supply to control the DC input power. The test voltage range is from minimum to maximum working voltage. Each step shall be record the frequency error rate.
- The temperature range step is 10 degrees in this test items. All temperature levels shall be hold the  $\pm 0.5^{\circ}\text{C}$  during the measurement testing. The each temperature step shall be at least 0.5 hours, consider the EUT could be test under the stability condition.

Note: The frequency error was recorded frequency error from the communication simulator.

#### 4.3.3 Test Instruments

Description & Manufacturer	Model No.	Serial No.	Cal. Date	Cal. Due
5G Wireless Test Platforms Keysight	E7515B	MY60102114	May 21, 2021	May 20, 2022
Temperature & Humidity Chamber TERCHY	HRM-120RF	931022	Dec. 24, 2020	Dec. 23, 2021
Digital Multimeter Fluke	87-III	70360742	Jun. 24, 2021	Jun. 23, 2022
DC Power Supply Topward	6306A	727263	NA	NA

Note: 1. The calibration interval of the above test instruments is 12 months and the calibrations are traceable to NML/ROC and NIST/USA.

#### 4.3.4 Conducted Setup

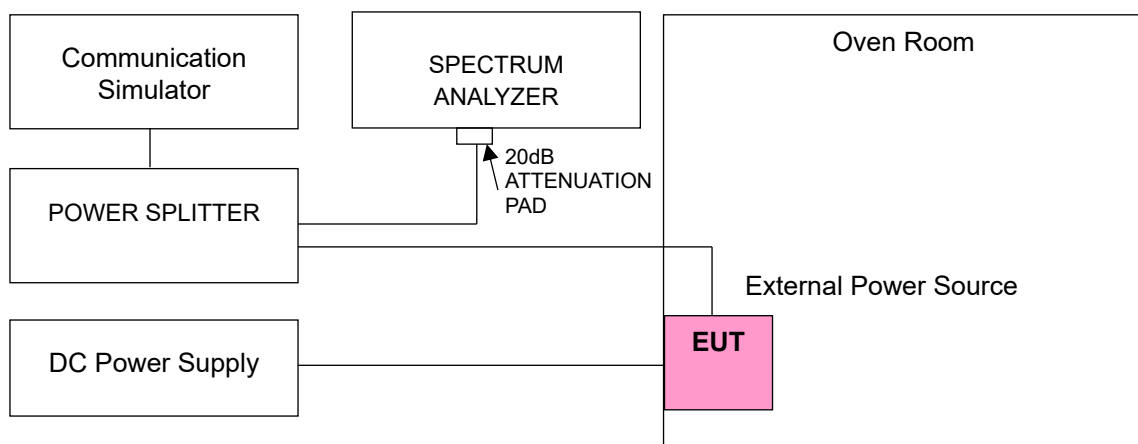



### 4.3.5 Test Results

#### Frequency Error vs. Voltage

Voltage (Vdc)	n25			
	Channel Bandwidth 5 MHz			
	Low Channel		High Channel	
	Frequency (MHz)	Frequency Error (ppm)	Frequency (MHz)	Frequency Error (ppm)
4.25	1852.500014	0.008	1912.500000	0.012
5	1852.500026	0.014	1912.500000	0.019
5.75	1852.500027	0.015	1912.500000	0.014

Note: The applicant defined the normal working voltage is from 4.25Vdc to 5.75Vdc.

#### Frequency Error vs. Temperature

Temp. (°C)	n25			
	Channel Bandwidth 5 MHz			
	Low Channel		High Channel	
	Frequency (MHz)	Frequency Error (ppm)	Frequency (MHz)	Frequency Error (ppm)
-30	1852.500027	0.015	1912.500000	0.021
-20	1852.500037	0.020	1912.500000	0.018
-10	1852.500036	0.019	1912.500000	0.013
0	1852.500011	0.006	1912.500000	0.021
10	1852.499982	-0.010	1912.500000	-0.011
20	1852.499977	-0.012	1912.500000	-0.013
30	1852.499980	-0.011	1912.500000	-0.014
40	1852.499982	-0.010	1912.500000	-0.018
50	1852.499990	-0.005	1912.500000	-0.007

### Frequency Error vs. Voltage

Voltage (Vdc)	n25			
	Channel Bandwidth 10 MHz			
	Low Channel		High Channel	
	Frequency (MHz)	Frequency Error (ppm)	Frequency (MHz)	Frequency Error (ppm)
4.25	1855.000017	0.009	1910.000031	0.016
5	1855.000031	0.017	1910.000036	0.019
5.75	1855.000014	0.008	1910.000026	0.014

Note: The applicant defined the normal working voltage is from 4.25Vdc to 5.75Vdc.

### Frequency Error vs. Temperature

Temp. (°C)	n25			
	Channel Bandwidth 10 MHz			
	Low Channel		High Channel	
	Frequency (MHz)	Frequency Error (ppm)	Frequency (MHz)	Frequency Error (ppm)
-30	1855.000022	0.012	1910.000026	0.014
-20	1855.000037	0.020	1910.000015	0.008
-10	1855.000036	0.019	1910.000026	0.014
0	1855.000021	0.011	1910.000012	0.006
10	1854.999982	-0.010	1909.999968	-0.017
20	1854.999974	-0.014	1909.999976	-0.013
30	1854.999975	-0.013	1909.999990	-0.005
40	1854.999960	-0.022	1909.999970	-0.016
50	1854.999979	-0.011	1909.999980	-0.010

Frequency Error vs. Voltage

Voltage (Vdc)	n25			
	Channel Bandwidth 15 MHz			
	Low Channel		High Channel	
	Frequency (MHz)	Frequency Error (ppm)	Frequency (MHz)	Frequency Error (ppm)
4.25	1857.500015	0.008	1907.500032	0.017
5	1857.500012	0.006	1907.500016	0.008
5.75	1857.500035	0.019	1907.500025	0.013

Note: The applicant defined the normal working voltage is from 4.25Vdc to 5.75Vdc.

Frequency Error vs. Temperature

Temp. (°C)	n25			
	Channel Bandwidth 15 MHz			
	Low Channel		High Channel	
	Frequency (MHz)	Frequency Error (ppm)	Frequency (MHz)	Frequency Error (ppm)
-30	1857.500013	0.007	1907.500018	0.009
-20	1857.500030	0.016	1907.500034	0.018
-10	1857.500040	0.022	1907.500017	0.009
0	1857.500024	0.013	1907.500010	0.005
10	1857.499983	-0.009	1907.499962	-0.020
20	1857.499989	-0.006	1907.499964	-0.019
30	1857.499964	-0.019	1907.499985	-0.008
40	1857.499971	-0.016	1907.499985	-0.008
50	1857.499979	-0.011	1907.499964	-0.019

Frequency Error vs. Voltage

Voltage (Vdc)	n25			
	Channel Bandwidth 20 MHz			
	Low Channel		High Channel	
	Frequency (MHz)	Frequency Error (ppm)	Frequency (MHz)	Frequency Error (ppm)
4.25	1860.000033	0.018	1905.000023	0.012
5	1860.000012	0.006	1905.000016	0.008
5.75	1860.000017	0.009	1905.000015	0.008

Note: The applicant defined the normal working voltage is from 4.25Vdc to 5.75Vdc.

Frequency Error vs. Temperature

Temp. (°C)	n25			
	Channel Bandwidth 20 MHz			
	Low Channel		High Channel	
	Frequency (MHz)	Frequency Error (ppm)	Frequency (MHz)	Frequency Error (ppm)
-30	1860.000019	0.010	1905.000020	0.010
-20	1860.000040	0.022	1905.000036	0.019
-10	1860.000034	0.018	1905.000023	0.012
0	1860.000015	0.008	1905.000017	0.009
10	1859.999967	-0.018	1904.999970	-0.016
20	1859.999973	-0.015	1904.999971	-0.015
30	1859.999975	-0.013	1904.999967	-0.017
40	1859.999974	-0.014	1904.999966	-0.018
50	1859.999985	-0.008	1904.999990	-0.005

**Frequency Error vs. Voltage**

Voltage (Volts)	LTE Band 12			
	Channel Bandwidth: 1.4 MHz			
	Low Channel		High Channel	
	Frequency (MHz)	Frequency Error (ppm)	Frequency (MHz)	Frequency Error (ppm)
4.25	699.700002	0.003	715.300002	0.002
5	699.700004	0.005	715.300001	0.002
5.75	699.700004	0.006	715.300003	0.003

Note: The applicant defined the normal working voltage is from 4.25Vdc to 5.75Vdc.

**Frequency Error vs. Temperature**

Temp. (°C)	LTE Band 12			
	Channel Bandwidth: 1.4 MHz			
	Low Channel		High Channel	
	Frequency (MHz)	Frequency Error (ppm)	Frequency (MHz)	Frequency Error (ppm)
-30	699.700003	0.004	715.300003	0.004
-20	699.700003	0.004	715.300002	0.002
-10	699.700002	0.003	715.300003	0.004
0	699.700002	0.003	715.300004	0.006
10	699.700002	0.003	715.300004	0.005
20	699.699998	-0.003	715.299998	-0.003
30	699.699998	-0.004	715.299998	-0.003
40	699.699997	-0.005	715.299999	-0.002
50	699.699996	-0.005	715.299999	-0.001

Frequency Error vs. Voltage

Voltage (Volts)	LTE Band 12			
	Channel Bandwidth: 3 MHz			
	Low Channel		High Channel	
	Frequency (MHz)	Frequency Error (ppm)	Frequency (MHz)	Frequency Error (ppm)
4.25	700.500003	0.004	714.500004	0.006
5	700.500004	0.005	714.500003	0.004
5.75	700.500004	0.005	714.500004	0.006

Note: The applicant defined the normal working voltage is from 4.25Vdc to 5.75Vdc.

Frequency Error vs. Temperature

Temp. (°C)	LTE Band 12			
	Channel Bandwidth: 3 MHz			
	Low Channel		High Channel	
	Frequency (MHz)	Frequency Error (ppm)	Frequency (MHz)	Frequency Error (ppm)
-30	700.500003	0.005	714.500003	0.005
-20	700.500002	0.003	714.500002	0.003
-10	700.500002	0.002	714.500004	0.005
0	700.500001	0.002	714.500003	0.004
10	700.500001	0.002	714.500003	0.004
20	700.499997	-0.004	714.499997	-0.005
30	700.499999	-0.001	714.499998	-0.003
40	700.499997	-0.004	714.499999	-0.002
50	700.499999	-0.002	714.499998	-0.003

Frequency Error vs. Voltage

Voltage (Volts)	LTE Band 12			
	Channel Bandwidth: 5 MHz			
	Low Channel		High Channel	
	Frequency (MHz)	Frequency Error (ppm)	Frequency (MHz)	Frequency Error (ppm)
4.25	701.500002	0.003	713.500003	0.004
5	701.500004	0.006	713.500003	0.004
5.75	701.500002	0.003	713.500003	0.004

Note: The applicant defined the normal working voltage is from 4.25Vdc to 5.75Vdc.

Frequency Error vs. Temperature

Temp. (°C)	LTE Band 12			
	Channel Bandwidth: 5 MHz			
	Low Channel		High Channel	
	Frequency (MHz)	Frequency Error (ppm)	Frequency (MHz)	Frequency Error (ppm)
-30	701.500004	0.005	713.500003	0.004
-20	701.500002	0.003	713.500003	0.004
-10	701.500003	0.004	713.500001	0.002
0	701.500001	0.002	713.500002	0.002
10	701.500003	0.004	713.500001	0.001
20	701.499997	-0.005	713.499997	-0.004
30	701.499998	-0.003	713.499998	-0.003
40	701.499999	-0.002	713.499999	-0.002
50	701.499996	-0.005	713.499997	-0.004

Frequency Error vs. Voltage

Voltage (Volts)	LTE Band 12			
	Channel Bandwidth: 10 MHz			
	Low Channel		High Channel	
	Frequency (MHz)	Frequency Error (ppm)	Frequency (MHz)	Frequency Error (ppm)
4.25	704.000004	0.005	711.000003	0.004
5	704.000004	0.006	711.000001	0.002
5.75	704.000004	0.005	711.000002	0.003

Note: The applicant defined the normal working voltage is from 4.25Vdc to 5.75Vdc.

Frequency Error vs. Temperature

Temp. (°C)	LTE Band 12			
	Channel Bandwidth: 10 MHz			
	Low Channel		High Channel	
	Frequency (MHz)	Frequency Error (ppm)	Frequency (MHz)	Frequency Error (ppm)
-30	704.000004	0.005	711.000004	0.005
-20	704.000002	0.003	711.000004	0.005
-10	704.000003	0.005	711.000004	0.005
0	704.000004	0.005	711.000001	0.002
10	704.000004	0.006	711.000003	0.004
20	703.999997	-0.004	710.999999	-0.002
30	703.999998	-0.004	710.999999	-0.002
40	703.999998	-0.003	710.999998	-0.003
50	703.999997	-0.004	710.999999	-0.002



## 4.4 Emission Bandwidth Measurement

### 4.4.1 Test Procedure

According to FCC 2.1049, the occupied bandwidth, that is the frequency bandwidth such that, below its lower and above its upper frequency limits, the mean powers radiated are each equal to 0.5 % of the total mean power radiated by a given emission.

For the 26dBc bandwidth measurement method, please refer to section 5.4.3 of ANSI C63.26.

### 4.4.2 Test Procedure

For the 26dBc bandwidth measurement method, please refer to section 5.4.3 of ANSI C63.26.

- a) The spectrum analyzer center frequency is set to the nominal EUT channel center frequency. The span range for the spectrum analyzer shall be wide enough to see sufficient roll off of the signal to make the measurement.
- b) The nominal RBW shall be in the range of 1% to 5% of the anticipated OBW, and the VBW shall be set  $\geq 3 \times \text{RBW}$ .
- c) Set the reference level of the instrument as required to prevent the signal amplitude from exceeding the maximum spectrum analyzer input mixer level for linear operation. See guidance provided in 4.2.3.
- d) The dynamic range of the spectrum analyzer at the selected RBW shall be more than 10 dB below the target “-X dB” requirement, i.e., if the requirement calls for measuring the -26 dB OBW, the spectrum analyzer noise floor at the selected RBW shall be at least 36 dB below the reference level.
- e) Set spectrum analyzer detection mode to peak, and the trace mode to max hold.
- f) Determine the following reference values: Set the EUT to transmit a modulated signal. Allow the trace to stabilize. Set the spectrum analyzer marker to the highest level of the displayed trace (this is the reference value).
- g) Determine the “-X dB amplitude” as equal to (Reference Value - X). Alternatively, this calculation can be performed on the spectrum analyzer using the delta-marker measurement function.
- h) Place two markers, one at the lowest and the other at the highest frequency of the envelope of the spectral display such that each marker is at or slightly below the “-X dB amplitude” determined in step f). If a marker is below this “-X dB amplitude” value it should be as close as possible to this value. The OBW is the positive frequency difference between the two markers.
- i) The OBW shall be reported by providing plot(s) of the measuring instrument display, to include markers depicting the relevant frequency and amplitude information (e.g., marker table). The frequency and amplitude axis and scale shall be clearly labeled. Tabular data may be reported in addition to the plot(s).

For the occupied bandwidth measurement method, please refer to section 5.4.4 of ANSI C63.26.

### 4.4.3 Test Setup

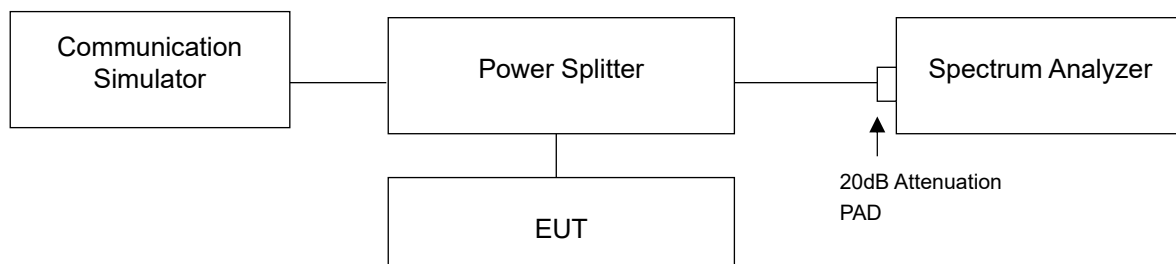

#### 4.4.4 Test Result

##### Occupied Bandwidth

n25, Channel Bandwidth: 5MHz						
Channel	Frequency (MHz)	99% Occupied Bandwidth (MHz)				
		$\pi/2$ BPSK	QPSK	16QAM	64QAM	256QAM
370500	1852.5	4.46	4.47	4.46	4.47	4.47
376500	1882.5	4.48	4.47	4.47	4.47	4.47
382500	1912.5	4.47	4.47	4.47	4.47	4.46
n25, Channel Bandwidth: 10MHz						
Channel	Frequency (MHz)	99% Occupied Bandwidth (MHz)				
		$\pi/2$ BPSK	QPSK	16QAM	64QAM	256QAM
371000	1855.0	9.18	9.28	9.28	9.29	9.28
376500	1882.5	9.18	9.29	9.28	9.28	9.26
382000	1910.0	9.21	9.29	9.29	9.28	9.29
n25, Channel Bandwidth: 15MHz						
Channel	Frequency (MHz)	99% Occupied Bandwidth (MHz)				
		$\pi/2$ BPSK	QPSK	16QAM	64QAM	256QAM
371500	1857.5	13.98	14.11	14.11	14.11	14.11
376500	1882.5	14.00	14.10	14.11	14.10	14.10
381500	1907.5	14.00	14.11	14.10	14.10	14.10
n25, Channel Bandwidth: 20MHz						
Channel	Frequency (MHz)	99% Occupied Bandwidth (MHz)				
		$\pi/2$ BPSK	QPSK	16QAM	64QAM	256QAM
372000	1860.0	18.75	18.91	18.90	18.91	18.91
376500	1882.5	18.60	18.89	18.90	18.90	18.89
381000	1905.0	18.74	18.90	18.90	18.89	18.90

## Spectrum Plot of Worst Value

### 5MHz / $\pi/2$ BPSK

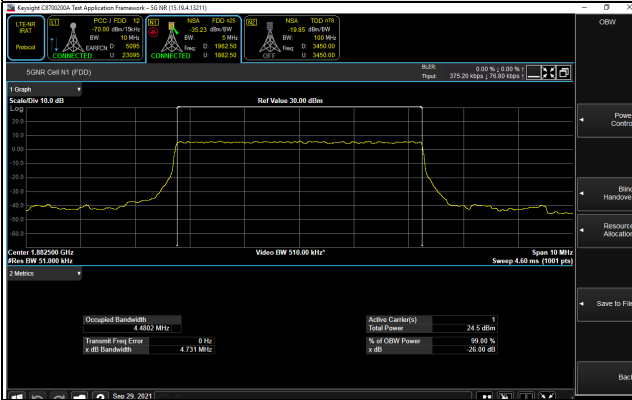

### 10MHz / 16QAM



### 15MHz / 256QAM

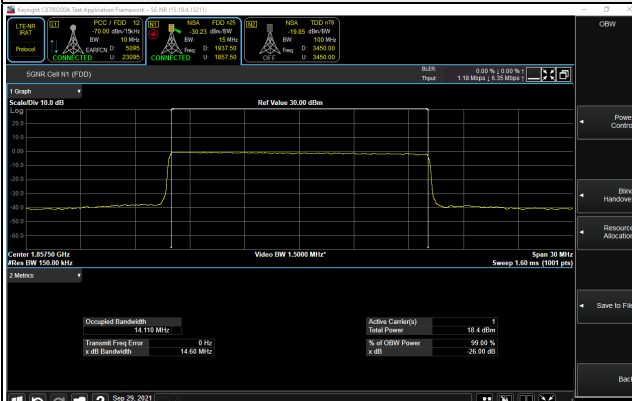

### 20MHz / QPSK

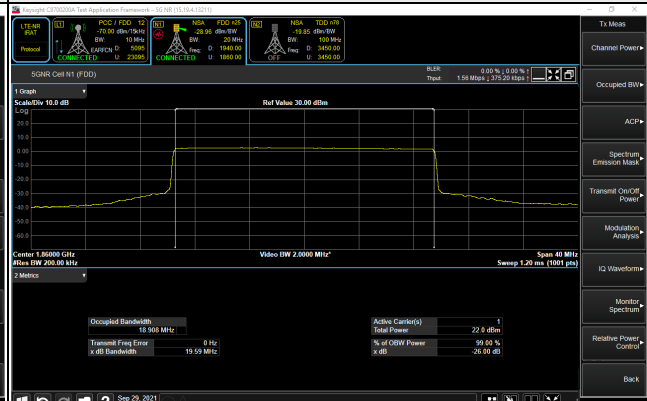

LTE Band 12

LTE Band 12, Channel Bandwidth 1.4MHz					
Channel	Frequency (MHz)	99% Occupied Bandwidth (MHz)			
		QPSK	16QAM	64QAM	256QAM
23017	699.7	1.09	1.09	1.09	1.08
23095	707.5	1.09	1.09	1.09	1.08
23173	715.3	1.09	1.09	1.09	1.09
LTE Band 12, Channel Bandwidth 3MHz					
Channel	Frequency (MHz)	99% Occupied Bandwidth (MHz)			
		QPSK	16QAM	64QAM	256QAM
23025	700.5	2.70	2.70	2.69	2.70
23095	707.5	2.70	2.70	2.70	2.70
23165	714.5	2.70	2.70	2.70	2.70
LTE Band 12, Channel Bandwidth 5MHz					
Channel	Frequency (MHz)	99% Occupied Bandwidth (MHz)			
		QPSK	16QAM	64QAM	256QAM
23035	701.5	4.49	4.49	4.49	4.49
23095	707.5	4.48	4.49	4.48	4.48
23155	713.5	4.48	4.49	4.49	4.49
LTE Band 12, Channel Bandwidth 10MHz					
Channel	Frequency (MHz)	99% Occupied Bandwidth (MHz)			
		QPSK	16QAM	64QAM	256QAM
23060	704.0	8.97	8.96	8.96	8.96
23095	707.5	8.97	8.95	8.96	8.95
23130	711.0	8.96	8.94	8.94	8.95

### Spectrum Plot of Worst Value

#### 1.4MHz / 64QAM



#### 3MHz / 16QAM

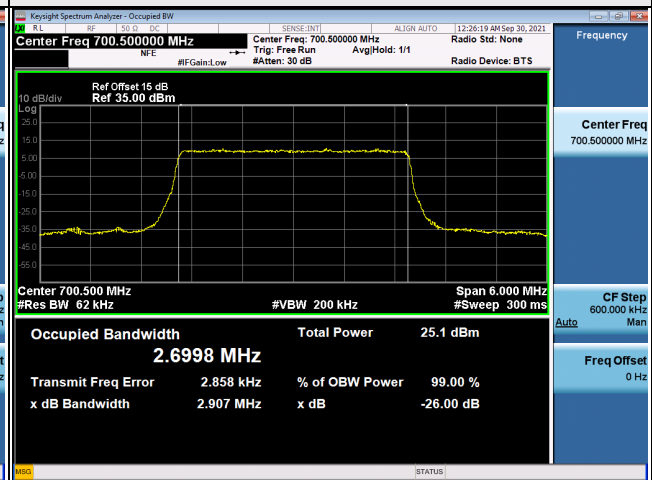

#### 5MHz / 64QAM

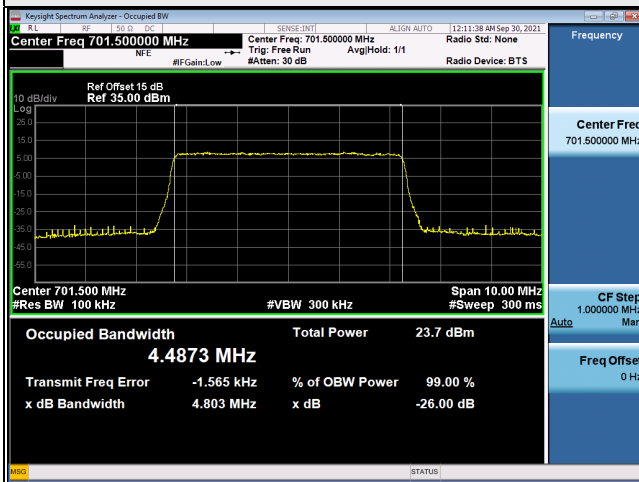

#### 10MHz / QPSK

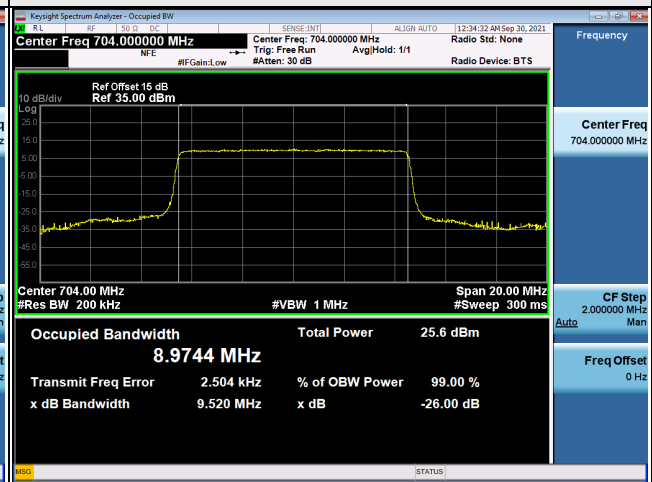

26dB Bandwidth

n25, Channel Bandwidth: 5MHz						
Channel	Frequency (MHz)	26dBc Bandwidth (MHz)				
		$\pi/2$ BPSK	QPSK	16QAM	64QAM	256QAM
370500	1852.5	4.72	4.47	4.74	4.71	4.74
376500	1882.5	4.73	4.48	4.72	4.76	4.75
382500	1912.5	4.74	4.72	4.75	4.71	4.73
n25, Channel Bandwidth: 10MHz						
Channel	Frequency (MHz)	26dBc Bandwidth (MHz)				
		$\pi/2$ BPSK	QPSK	16QAM	64QAM	256QAM
371000	1855.0	9.26	9.65	9.70	9.65	9.69
376500	1882.5	9.28	9.68	9.70	9.65	9.64
382000	1910.0	9.26	9.64	9.65	9.66	9.65
n25, Channel Bandwidth: 15MHz						
Channel	Frequency (MHz)	26dBc Bandwidth (MHz)				
		$\pi/2$ BPSK	QPSK	16QAM	64QAM	256QAM
371500	1857.5	13.89	14.63	14.61	14.60	14.60
376500	1882.5	13.90	14.63	14.61	14.61	14.59
381500	1907.5	13.88	14.61	14.59	14.61	14.59
n25, Channel Bandwidth: 20MHz						
Channel	Frequency (MHz)	26dBc Bandwidth (MHz)				
		$\pi/2$ BPSK	QPSK	16QAM	64QAM	256QAM
372000	1860.0	18.49	19.59	19.55	19.57	19.56
376500	1882.5	18.47	19.58	19.57	19.56	19.54
381000	1905.0	18.48	19.56	19.58	19.55	19.55

## Spectrum Plot of Worst Value

### 5MHz / 64QAM



### 10MHz / 16QAM



### 15MHz / QPSK

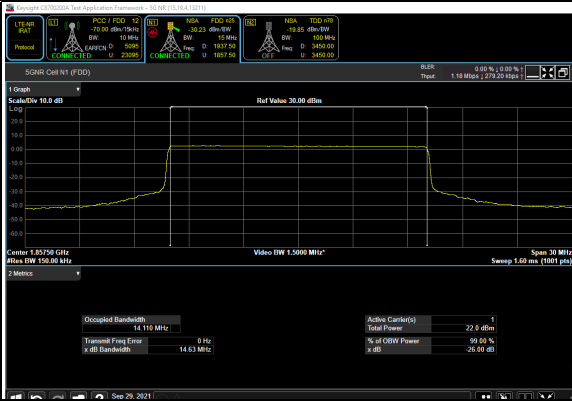

### 20MHz / QPSK

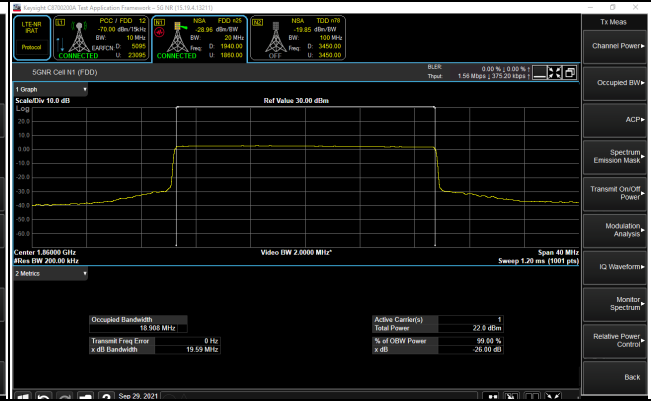

LTE Band 12

LTE Band 12, Channel Bandwidth 1.4MHz					
Channel	Frequency (MHz)	26dBc Bandwidth (MHz)			
		QPSK	16QAM	64QAM	256QAM
23017	699.7	1.21	1.21	1.22	1.21
23095	707.5	1.21	1.22	1.22	1.21
23173	715.3	1.22	1.21	1.21	1.21
LTE Band 12, Channel Bandwidth 3MHz					
Channel	Frequency (MHz)	26dBc Bandwidth (MHz)			
		QPSK	16QAM	64QAM	256QAM
23025	700.5	2.93	2.91	2.88	2.91
23095	707.5	2.92	2.89	2.90	2.92
23165	714.5	2.92	2.90	2.91	2.91
LTE Band 12, Channel Bandwidth 5MHz					
Channel	Frequency (MHz)	26dBc Bandwidth (MHz)			
		QPSK	16QAM	64QAM	256QAM
23035	701.5	4.82	4.81	4.80	4.81
23095	707.5	4.82	4.80	4.80	4.80
23155	713.5	4.82	4.82	4.79	4.80
LTE Band 12, Channel Bandwidth 10MHz					
Channel	Frequency (MHz)	26dBc Bandwidth (MHz)			
		QPSK	16QAM	64QAM	256QAM
23060	704.0	9.52	9.52	9.52	9.51
23095	707.5	9.51	9.52	9.51	9.51
23130	711.0	9.51	9.51	9.49	9.50



### Spectrum Plot of Worst Value

#### 1.4MHz / 64QAM

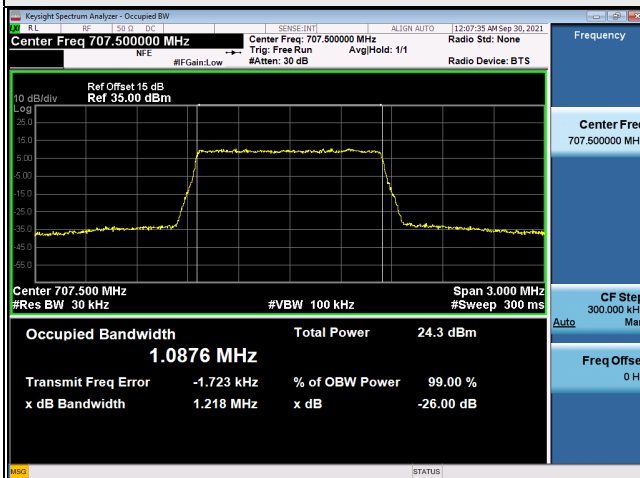

#### 3MHz / QPSK

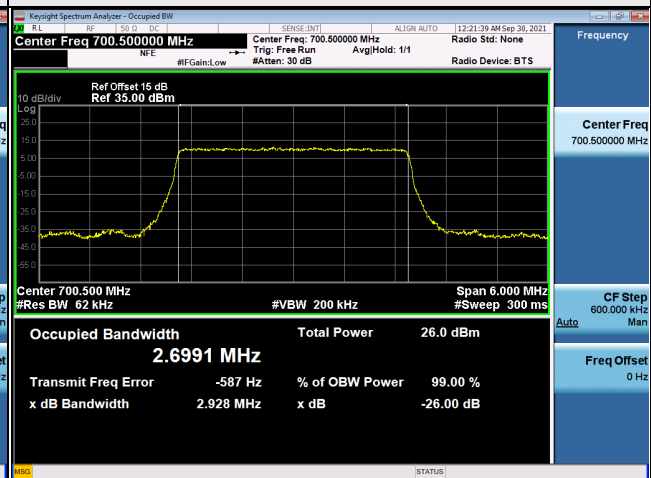

#### 5MHz / 64QAM

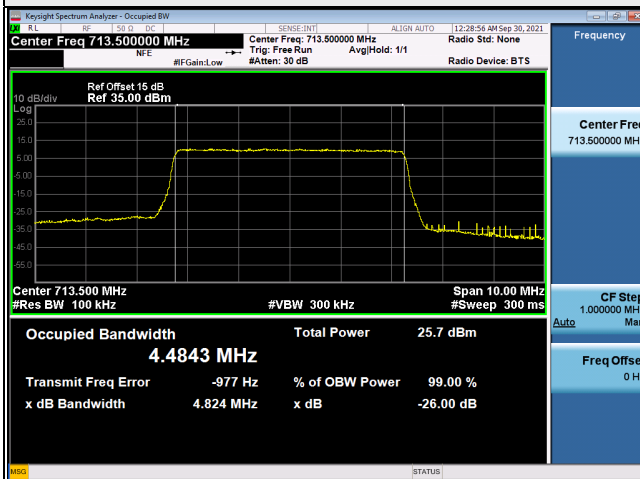

#### 10MHz / QPSK

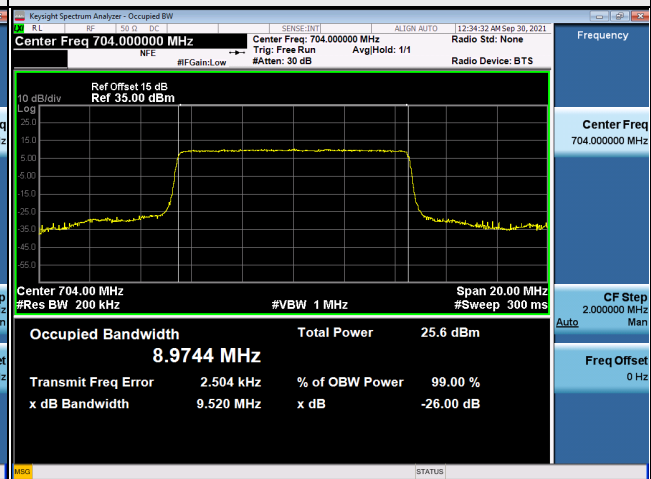

## 4.5 Band Edge Measurement

### 4.5.1 Limits of Band Edge Measurement

For n25:

Power of any emission outside of the authorized operating frequency ranges must be attenuated below the transmitting power (P) by a factor of at least  $43 + 10 \log(P)$  dB. In the 1 MHz bands immediately outside and adjacent to the frequency block a resolution bandwidth of at least one percent of the emission bandwidth of the fundamental emission of the transmitter may be employed.

For LTE Band 12:

According to FCC 27.53(g), for operations in the 600 MHz band and the 698-746 MHz band, the power of any emission outside a licensee's frequency band(s) of operation shall be attenuated below the transmitter power (P) within the licensed band(s) of operation, measured in watts, by at least  $43 + 10 \log(P)$  dB. Compliance with this provision is based on the use of measurement instrumentation employing a resolution bandwidth of 100 kilohertz or greater. However, in the 100 kilohertz bands immediately outside and adjacent to a licensee's frequency block, a resolution bandwidth of at least 30 kHz may be employed.

### 4.5.2 Test Setup

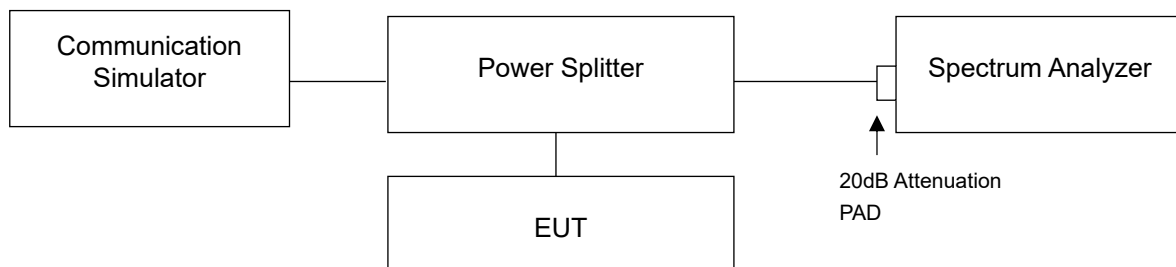

### 4.5.3 Test Procedures

For 5GNR n25:

- All measurements were done at low and high operational frequency range.
- The center frequency of spectrum is the band edge frequency and span is 1MHz or 2MHz. RB of the spectrum is 51kHz and VB of the spectrum is 160kHz (Channel Bandwidth 5MHz).
- The center frequency of spectrum is the band edge frequency and span is 1MHz or 2MHz. RB of the spectrum is 100kHz and VB of the spectrum is 300kHz (Channel Bandwidth 10MHz).
- The center frequency of spectrum is the band edge frequency and span is 1MHz or 2MHz. RB of the spectrum is 150kHz and VB of the spectrum is 470kHz (Channel Bandwidth 15MHz).
- The center frequency of spectrum is the band edge frequency and span is 1MHz or 2MHz. RB of the spectrum is 200kHz and VB of the spectrum is 620kHz (Channel Bandwidth 20MHz).
- Record the max trace plot into the test report.

For LTE Band 12:

- The EUT was set up for the rated peak power. The power was measured with Spectrum Analyzer. All measurements were done at 2 channels: low and high operational frequency range.
- Measurement refer to ANSI C63.26 section 5.7.2 and FCC Part 27 section 27.53.
- Record the max trace plot into the test report.

### 4.5.4 Test Results



n25, Channel Bandwidth 10MHz

Channel 371000 (1855.0MHz)	$\pi/2$ BPSK	1 RB / 0 RB Offset	Channel 382000 (1910.0MHz)	$\pi/2$ BPSK	1 RB / 51 RB Offset
-------------------------------	--------------	--------------------	-------------------------------	--------------	---------------------

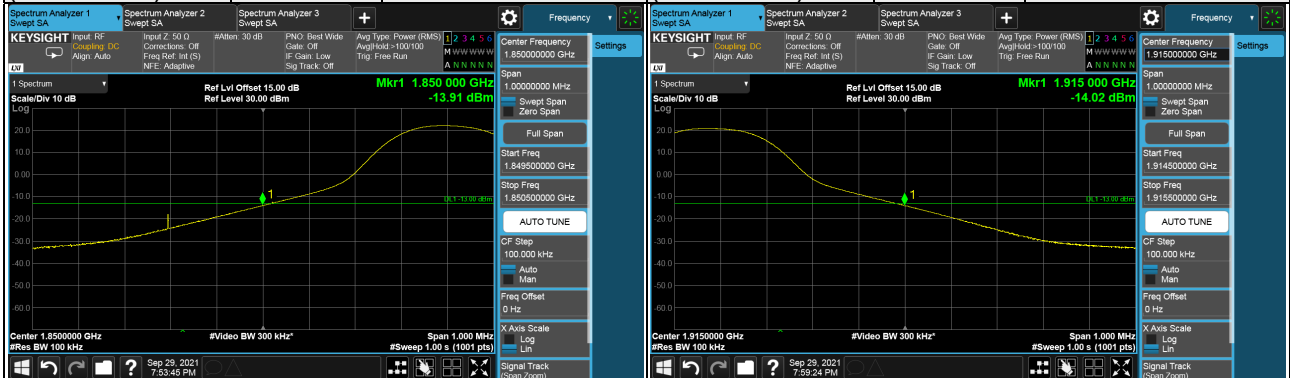

Channel 371000 (1855.0MHz)	$\pi/2$ BPSK	52 RB / 0 RB Offset	Channel 382000 (1910.0MHz)	$\pi/2$ BPSK	52 RB / 0 RB Offset
-------------------------------	--------------	---------------------	-------------------------------	--------------	---------------------

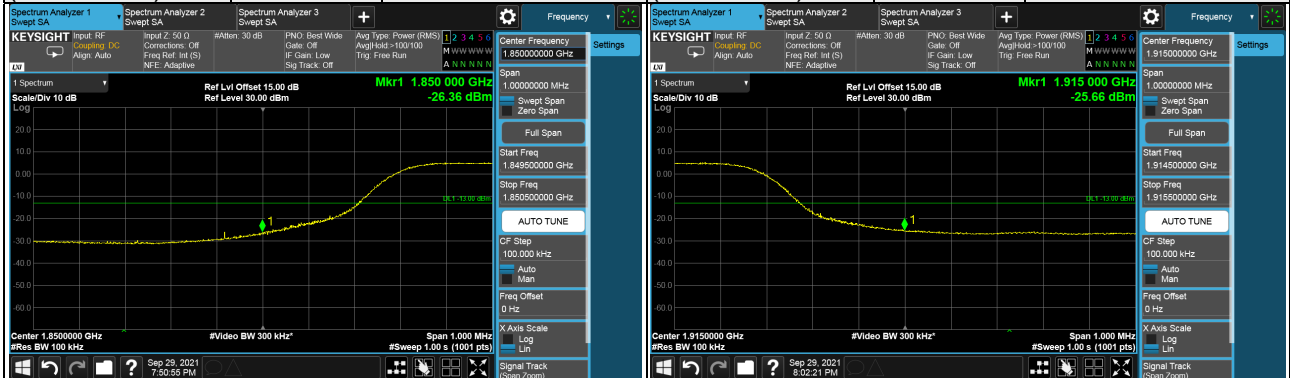

n25, Channel Bandwidth 15MHz

Channel 371500 (1857.5MHz)	$\pi/2$ BPSK	1 RB / 0 RB Offset	Channel 381500 (1907.5MHz)	$\pi/2$ BPSK	1 RB / 78 RB Offset
-------------------------------	--------------	--------------------	-------------------------------	--------------	---------------------

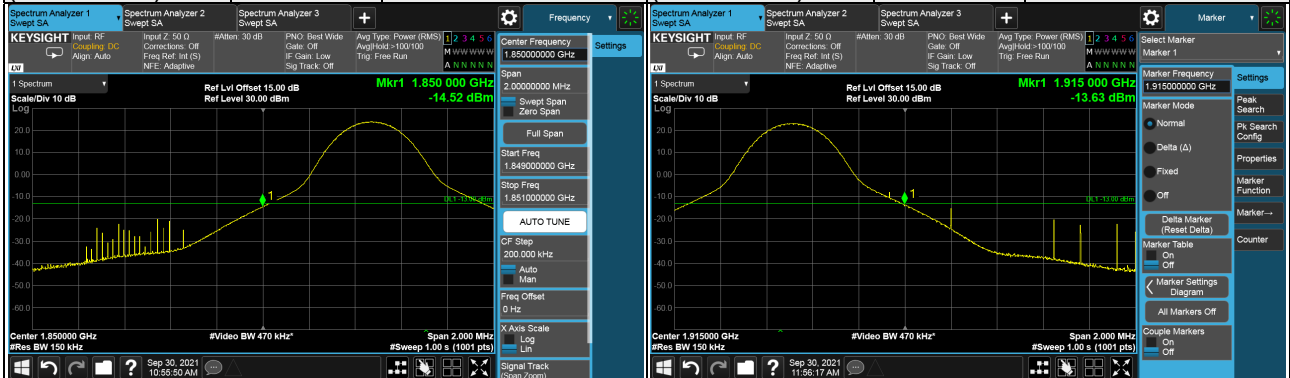

Channel 371500 (1857.5MHz)	$\pi/2$ BPSK	79 RB / 0 RB Offset	Channel 381500 (1907.5MHz)	$\pi/2$ BPSK	79 RB / 0 RB Offset
-------------------------------	--------------	---------------------	-------------------------------	--------------	---------------------

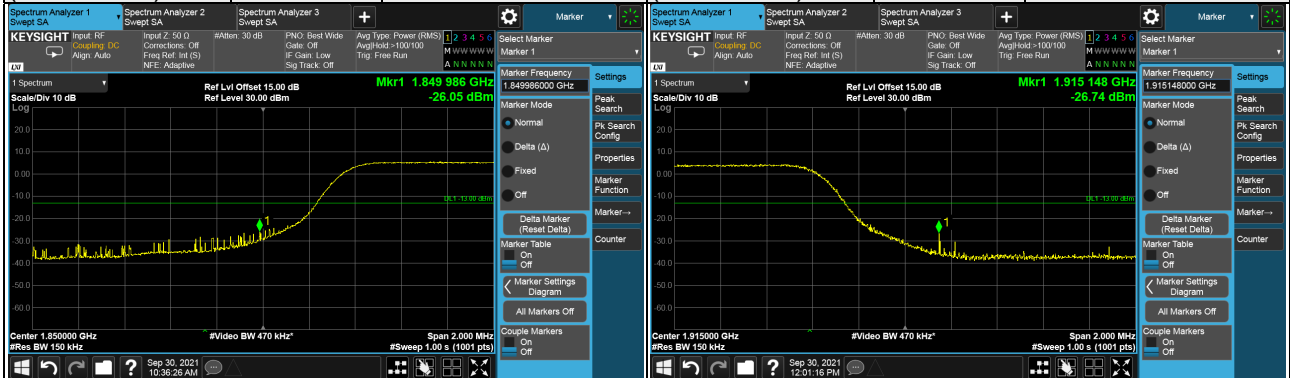

n25, Channel Bandwidth 20MHz

Channel 372000 (1860.0MHz)	$\pi/2$ BPSK	1 RB / 0 RB Offset	Channel 381000 (1905.0MHz)	$\pi/2$ BPSK	1 RB / 105 RB Offset
-------------------------------	--------------	--------------------	-------------------------------	--------------	----------------------

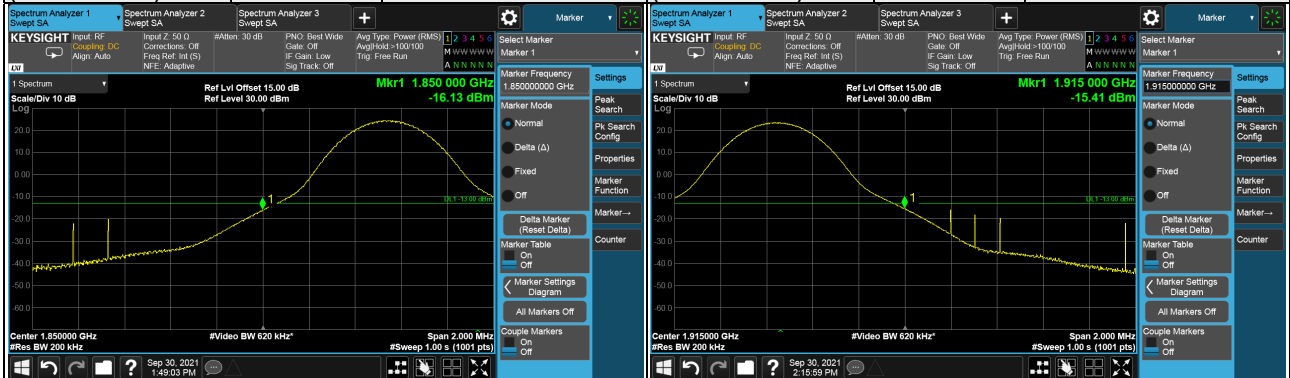

Channel 372000 (1860.0MHz)	$\pi/2$ BPSK	106 RB / 0 RB Offset	Channel 381000 (1905.0MHz)	$\pi/2$ BPSK	106 RB / 0 RB Offset
-------------------------------	--------------	----------------------	-------------------------------	--------------	----------------------

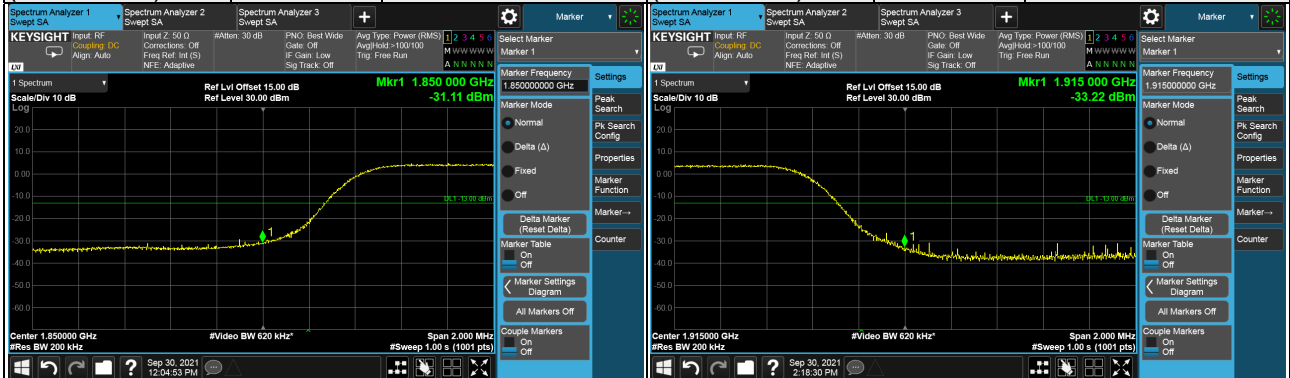

LTE Band 12

Channel Bandwidth: 1.4MHz

Channel 23017 (699.7MHz)	QPSK	1 RB / 0 RB Offset	Channel 23173 (715.3MHz)	QPSK	1 RB / 5 RB Offset
-----------------------------	------	--------------------	-----------------------------	------	--------------------

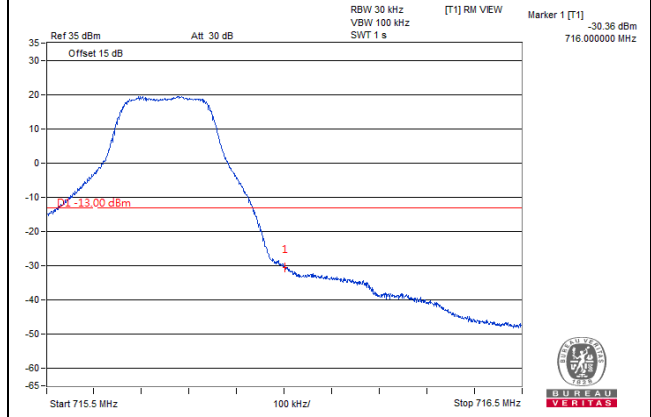
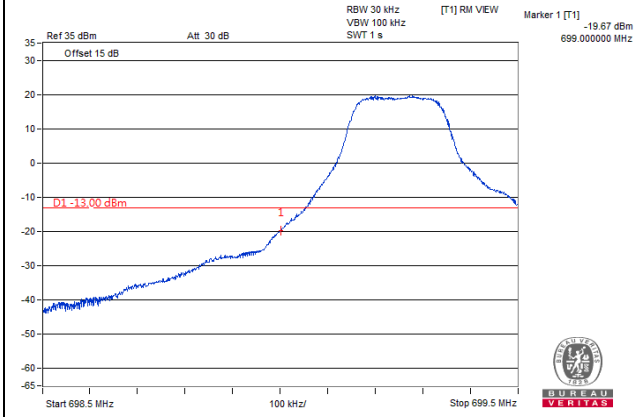

Channel 23017 (699.7MHz)	QPSK	6 RB / 0 RB Offset	Channel 23173 (715.3MHz)	QPSK	6 RB / 0 RB Offset
-----------------------------	------	--------------------	-----------------------------	------	--------------------

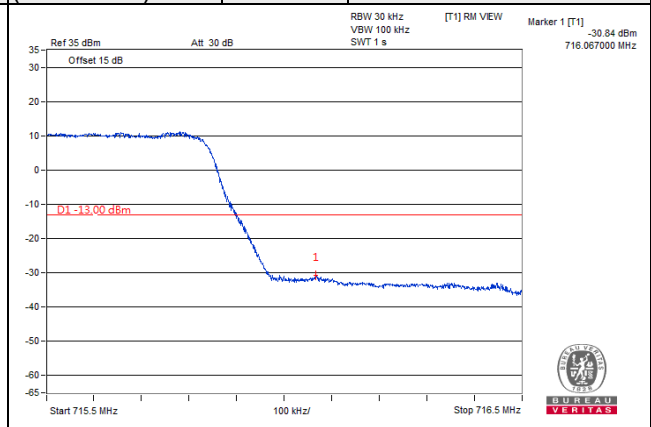
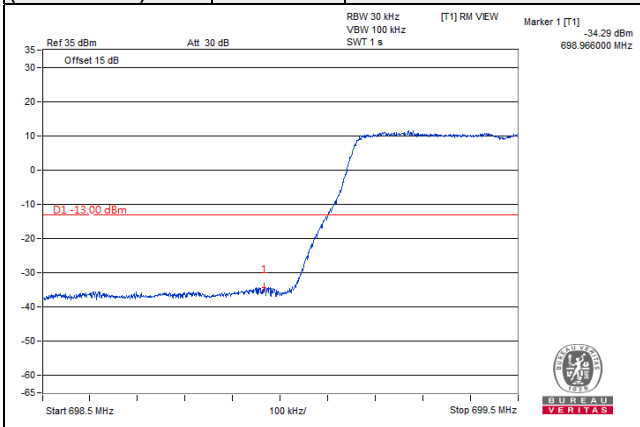

**Channel Bandwidth: 3MHz**

<b>Channel 23025 (700.5MHz)</b>	<b>QPSK</b>	<b>1 RB / 0 RB Offset</b>	<b>Channel 23165 (714.5MHz)</b>	<b>QPSK</b>	<b>1 RB / 14RB Offset</b>
-------------------------------------	-------------	---------------------------	-------------------------------------	-------------	---------------------------

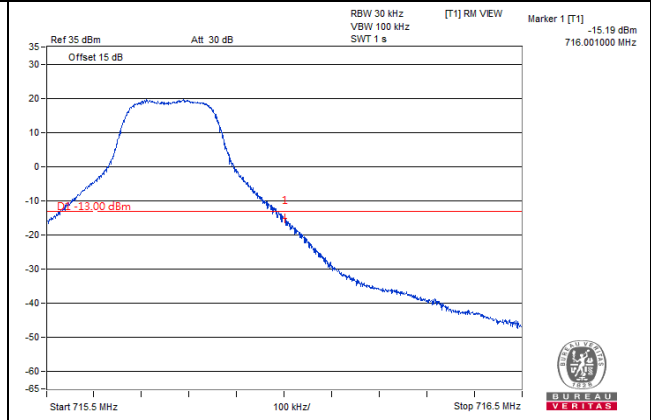
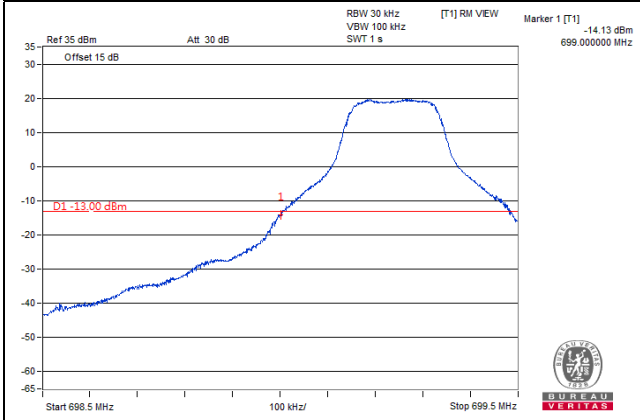

<b>Channel 23025 (700.5MHz)</b>	<b>QPSK</b>	<b>15 RB / 0 RB Offset</b>	<b>Channel 23165 (714.5MHz)</b>	<b>QPSK</b>	<b>15 RB / 0 RB Offset</b>
-------------------------------------	-------------	----------------------------	-------------------------------------	-------------	----------------------------

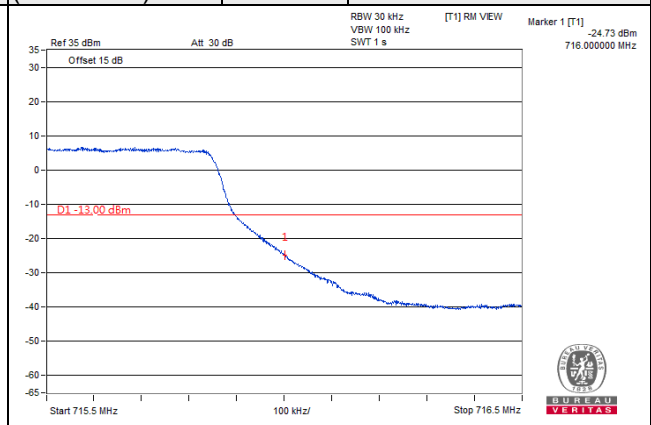
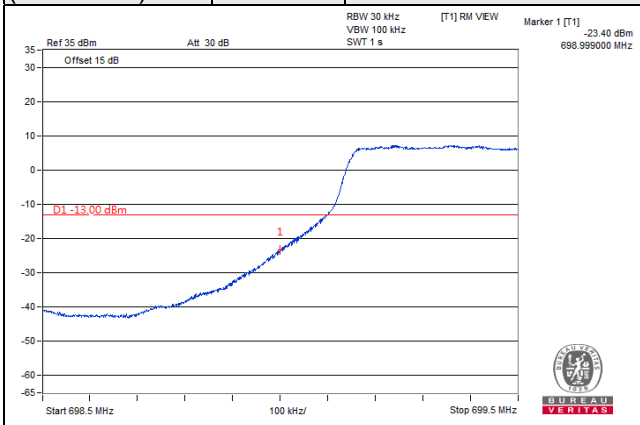



**Channel Bandwidth: 5MHz**

<b>Channel 23035 (701.5MHz)</b>	<b>QPSK</b>	<b>1 RB / 0 RB Offset</b>	<b>Channel 23155 (713.5MHz)</b>	<b>QPSK</b>	<b>1 RB / 24RB Offset</b>
-------------------------------------	-------------	---------------------------	-------------------------------------	-------------	---------------------------

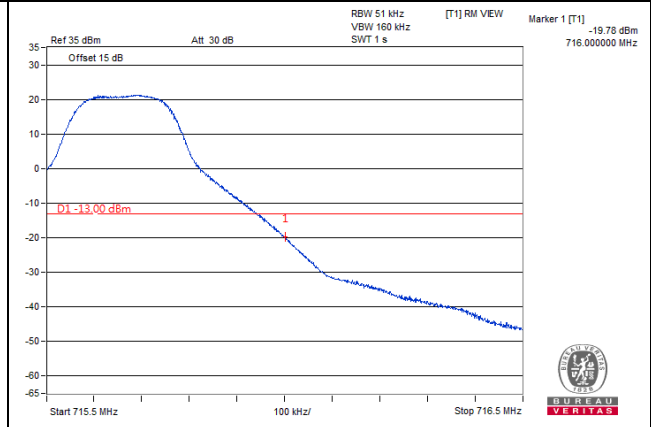
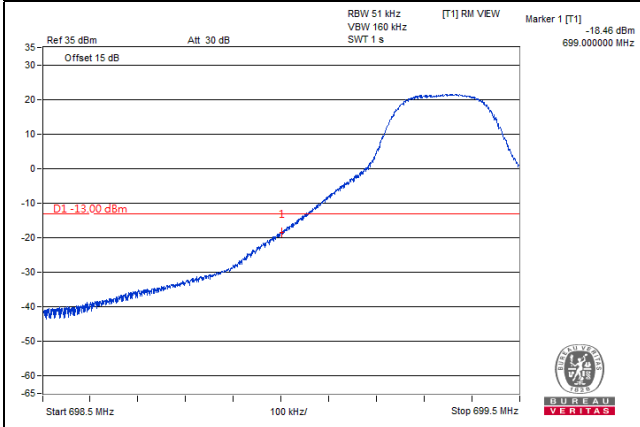

<b>Channel 23035 (701.5MHz)</b>	<b>QPSK</b>	<b>25 RB / 0 RB Offset</b>	<b>Channel 23155 (713.5MHz)</b>	<b>QPSK</b>	<b>25 RB / 0 RB Offset</b>
-------------------------------------	-------------	----------------------------	-------------------------------------	-------------	----------------------------

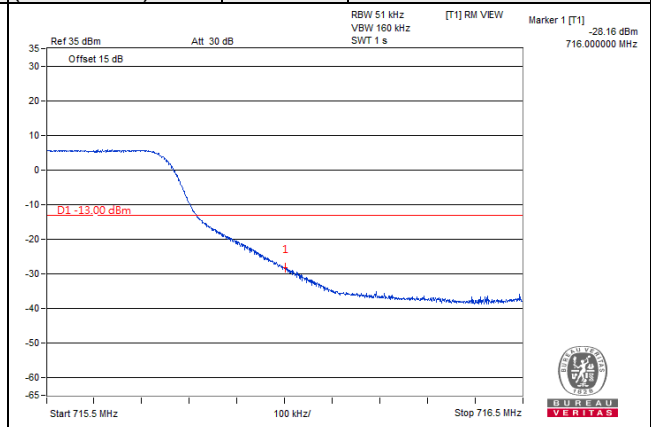
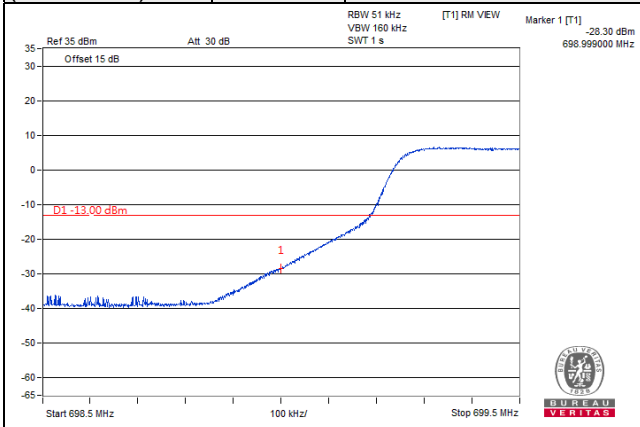

Channel Bandwidth: 10MHz

Channel 23060 (704MHz)	QPSK	1 RB / 0 RB Offset	Channel 23130 (711MHz)	QPSK	1 RB / 24RB Offset
---------------------------	------	--------------------	---------------------------	------	--------------------

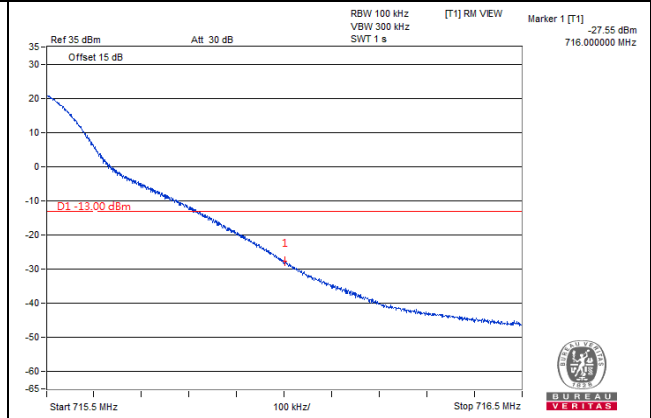
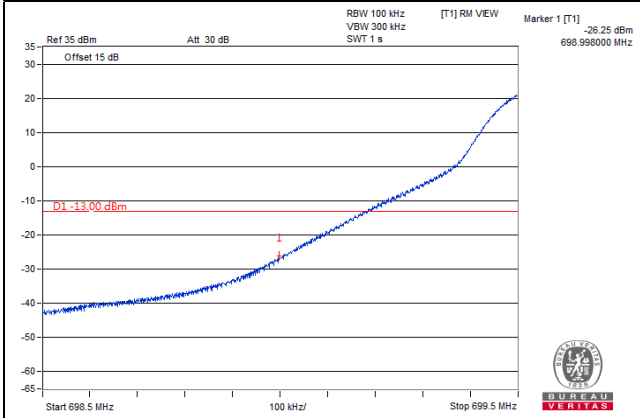

Channel 23060 (704MHz)	QPSK	50 RB / 0 RB Offset	Channel 23130 (711MHz)	QPSK	25 RB / 0 RB Offset
---------------------------	------	---------------------	---------------------------	------	---------------------

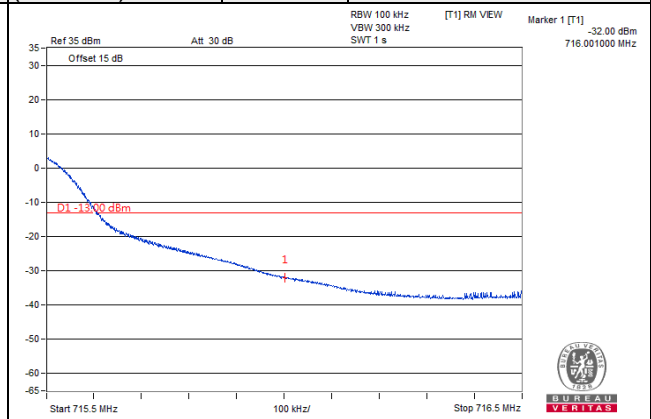
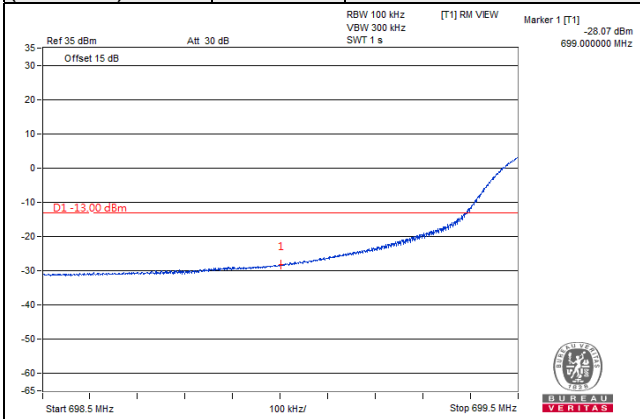

## 4.6 Peak to Average Ratio

### 4.6.1 Limits of Peak to Average Ratio Measurement

In measuring transmissions in this band using an average power technique, the peak to-average ratio (PAR) of the transmission may not exceed 13 dB

### 4.6.2 Test Setup

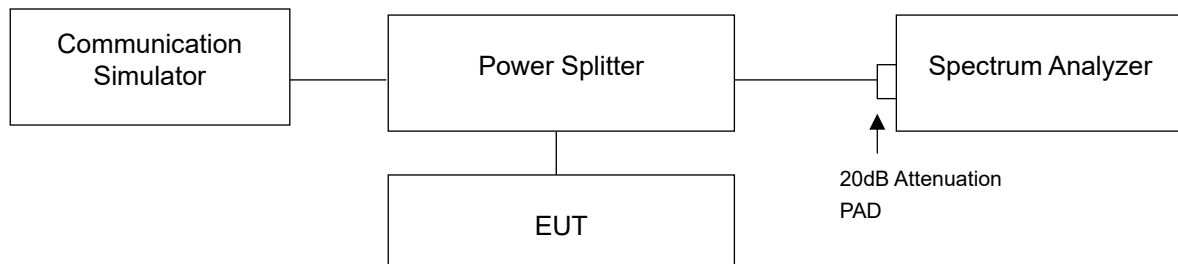

### 4.6.3 Test Procedures

- Set resolution/measurement bandwidth  $\geq$  signal's occupied bandwidth;
- Set the number of counts to a value that stabilizes the measured CCDF curve;
- Record the maximum PAPR level associated with a probability of 0.1%.

#### 4.6.4 Test Results

n25, Channel Bandwidth: 5MHz						
Channel	Frequency (MHz)	Peak To Average Ratio (dB)				
		$\pi/2$ BPSK	QPSK	16QAM	64QAM	256QAM
370500	1852.5	3.83	6.48	6.63	7.14	8.66
376500	1882.5	3.82	6.51	6.66	7.09	8.72
382500	1912.5	3.84	6.40	6.35	6.91	8.56
n25, Channel Bandwidth: 10MHz						
Channel	Frequency (MHz)	Peak To Average Ratio (dB)				
		$\pi/2$ BPSK	QPSK	16QAM	64QAM	256QAM
371000	1855.0	3.84	6.51	6.35	6.95	8.63
376500	1882.5	3.84	6.55	6.38	6.98	8.66
382000	1910.0	3.87	6.53	6.47	6.94	8.46
n25, Channel Bandwidth: 15MHz						
Channel	Frequency (MHz)	Peak To Average Ratio (dB)				
		$\pi/2$ BPSK	QPSK	16QAM	64QAM	256QAM
371500	1857.5	3.94	6.59	6.64	7.01	8.59
376500	1882.5	3.88	6.57	6.59	7.00	8.67
381500	1907.5	4.00	6.69	6.90	7.04	8.59
n25, Channel Bandwidth: 20MHz						
Channel	Frequency (MHz)	Peak To Average Ratio (dB)				
		$\pi/2$ BPSK	QPSK	16QAM	64QAM	256QAM
372000	1860.0	3.73	6.59	6.57	7.02	8.63
376500	1882.5	3.65	6.55	6.58	6.99	8.64
381000	1905.0	3.82	6.76	6.73	7.07	8.56

## Spectrum Plot of Worst Value

### 5MHz / 256QAM

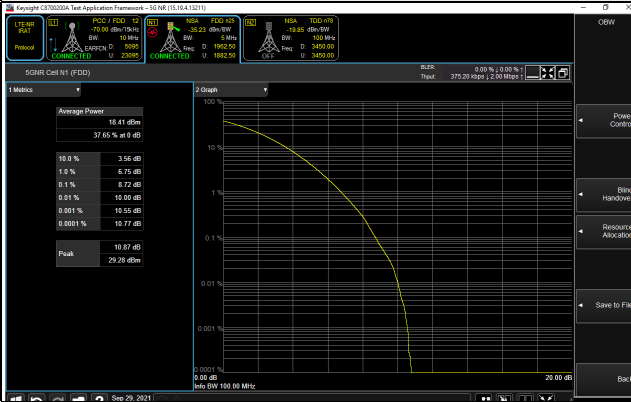

### 10MHz / 256QAM

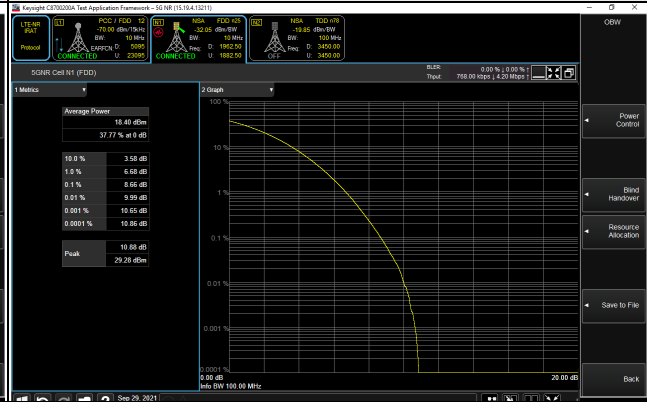

### 15MHz / 256QAM

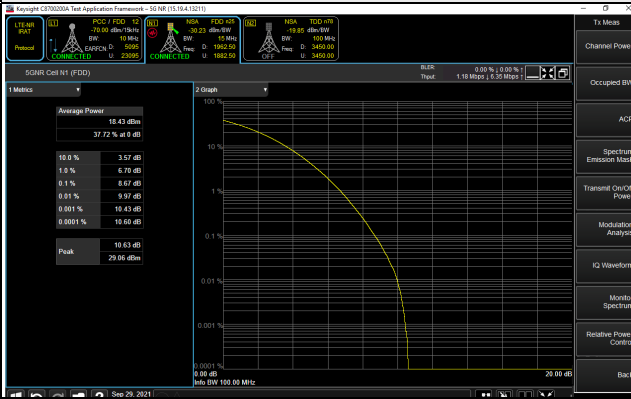

### 20MHz / 256QAM



LTE Band 12

LTE Band 12, Channel Bandwidth 1.4MHz					
Channel	Frequency (MHz)	Peak To Average Ratio (dB)			
		QPSK	16QAM	64QAM	256QAM
23017	699.7	3.33	4.91	5.89	7.06
23095	707.5	3.75	5.32	6.32	6.89
23173	715.3	3.67	5.00	6.11	6.87
LTE Band 12, Channel Bandwidth 3MHz					
Channel	Frequency (MHz)	Peak To Average Ratio (dB)			
		QPSK	16QAM	64QAM	256QAM
23025	700.5	3.14	4.75	5.77	6.15
23095	707.5	3.48	5.12	6.29	6.79
23165	714.5	3.48	5.13	6.28	6.94
LTE Band 12, Channel Bandwidth 5MHz					
Channel	Frequency (MHz)	Peak To Average Ratio (dB)			
		QPSK	16QAM	64QAM	256QAM
23035	701.5	3.19	4.79	5.78	7.07
23095	707.5	3.44	5.03	6.12	6.96
23155	713.5	3.55	5.26	6.48	7.07
LTE Band 12, Channel Bandwidth 10MHz					
Channel	Frequency (MHz)	Peak To Average Ratio (dB)			
		QPSK	16QAM	64QAM	256QAM
23060	704.0	3.18	4.74	5.86	7.13
23095	707.5	3.24	4.76	5.93	6.56
23130	711.0	3.53	5.06	6.32	7.23

### Spectrum Plot of Worst Value

**1.4MHz / 256QAM**

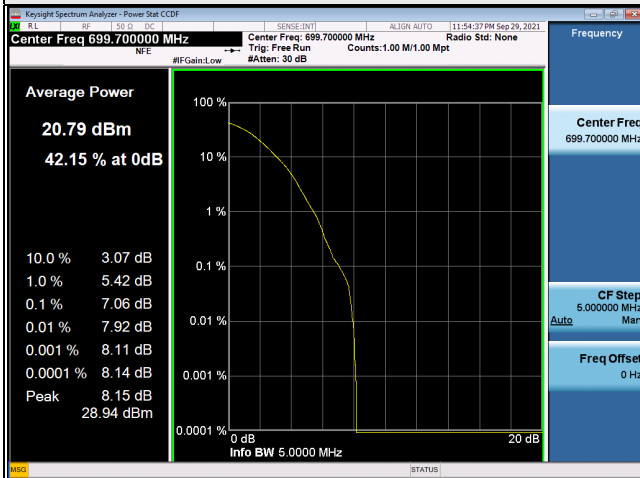

**3MHz / 256QAM**

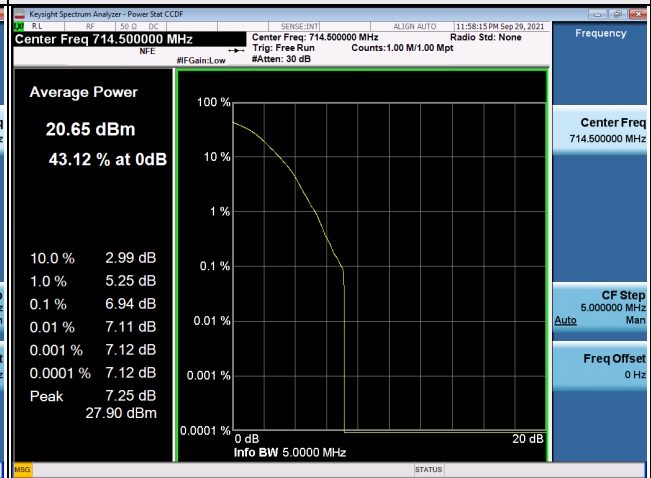

**5MHz / 256QAM**

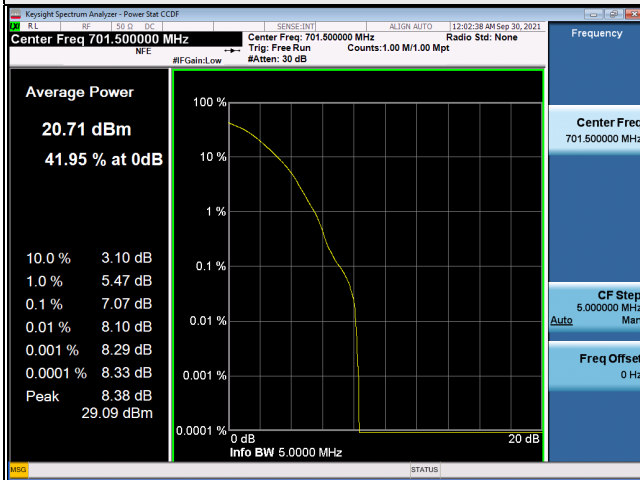

**10MHz / 256QAM**

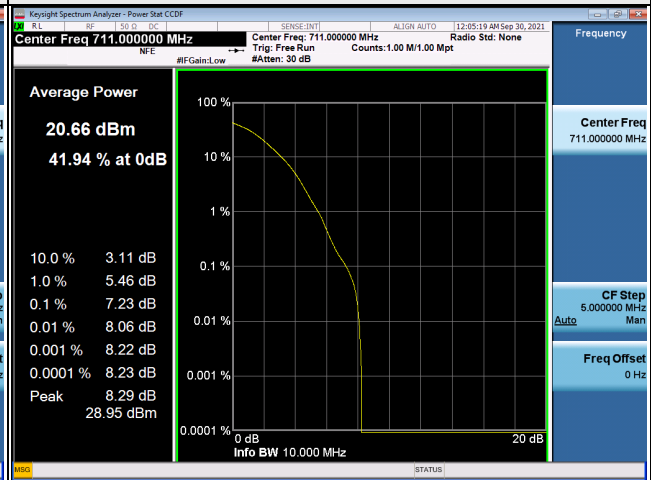

## 4.7 Conducted Spurious Emissions

### 4.7.1 Limits of Conducted Spurious Emissions Measurement

For 5GNR n25:

The power of any emission outside of the authorized operating frequency ranges must be attenuated below the transmitting power (P) by a factor of at least  $43 + 10 \log(P)$  dB. The emission limit equal to  $-13\text{dBm}$ .

For LTE Band 12:

According to FCC 27.53(g), for operations in the 600 MHz band and the 698-746 MHz band, the power of any emission outside a licensee's frequency band(s) of operation shall be attenuated below the transmitter power (P) within the licensed band(s) of operation, measured in watts, by at least  $43 + 10 \log(P)$  dB. The limit of emissions is equal to  $-13$  dBm.

### 4.7.2 Test Setup

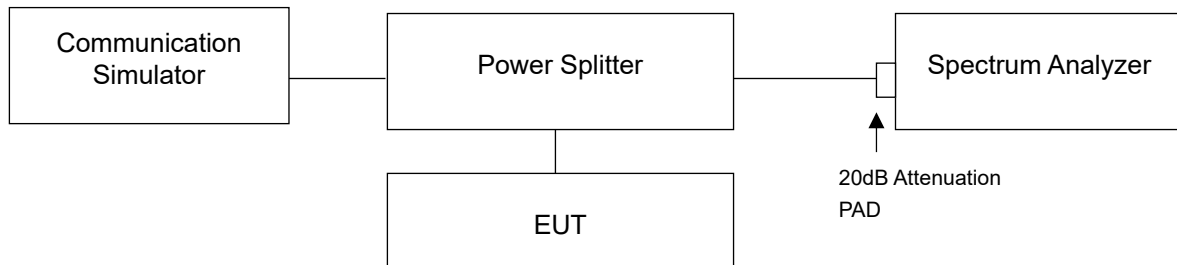

### 4.7.3 Test Procedure

- The EUT makes a phone call to the communication simulator. All measurements were done at low, middle and high operational frequency range.
- Measuring frequency range is from 9kHz to 8GHz or 26GHz. 20dB attenuation pad is connected with spectrum. RBW=1MHz or 100kHz and VBW=3MHz or 300kHz are used for conducted emission measurement.



### 4.7.4 Test Results

n25, Channel Bandwidth 5MHz

Channel 370500 (1852.5MHz)

Frequency Range : 9kHz ~ 1GHz

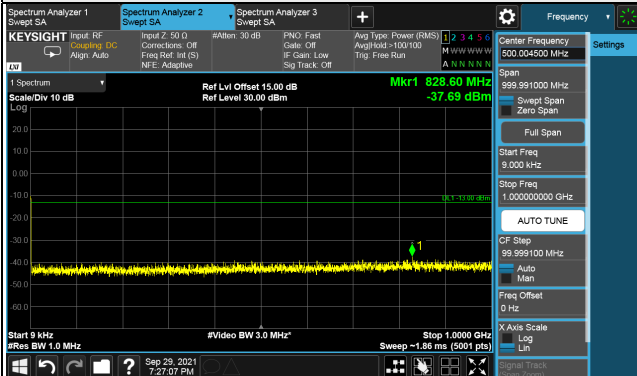

Frequency Range : 1GHz ~ 26GHz

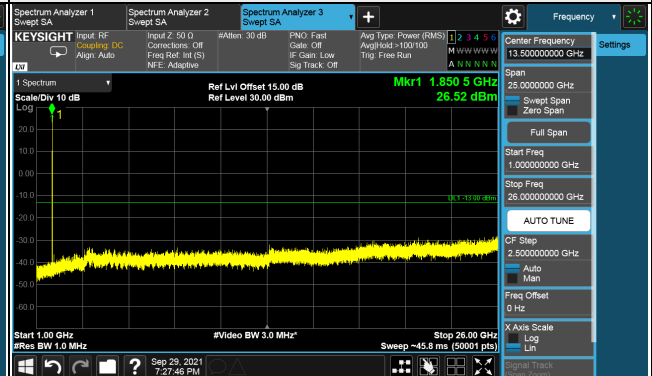

Channel 376500 (1882.5MHz)

Frequency Range : 9kHz ~ 1GHz

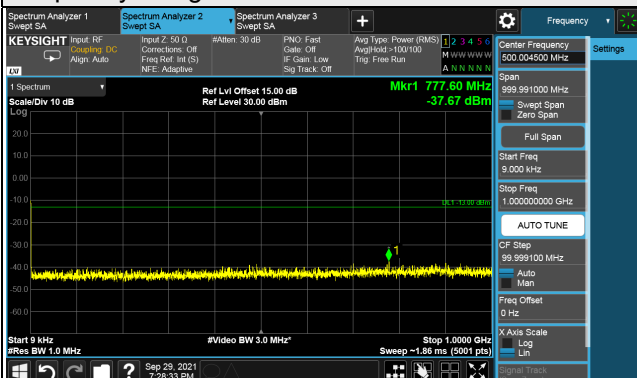

Frequency Range : 1GHz ~ 26GHz

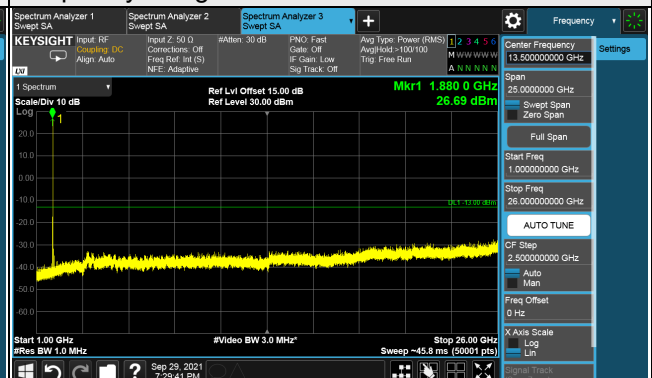

Channel 382500 (1912.5MHz)

Frequency Range : 9kHz ~ 1GHz

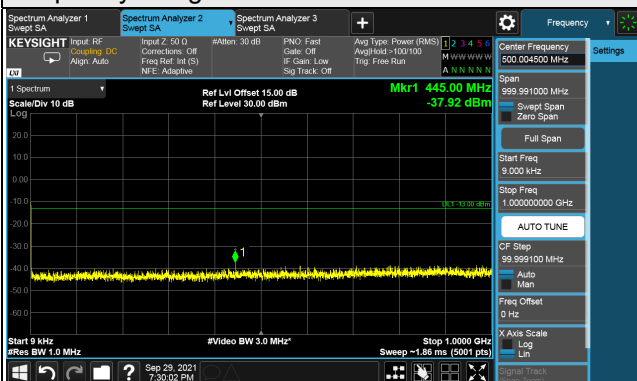

Frequency Range : 1GHz ~ 26GHz

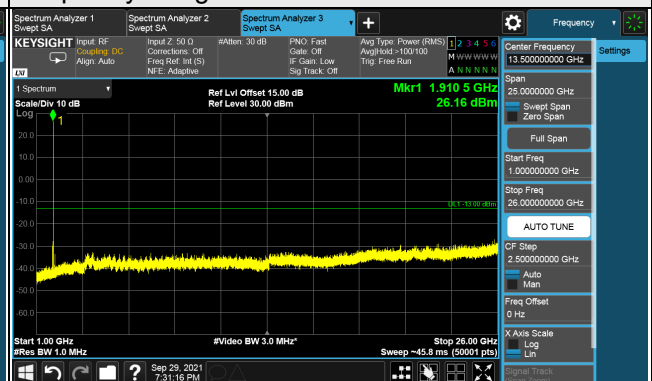

\*The 9kHz signal over the limit is from Spectrum.

n25, Channel Bandwidth 10MHz

Channel 371000 (1855.0MHz)

Frequency Range : 9kHz ~ 1GHz

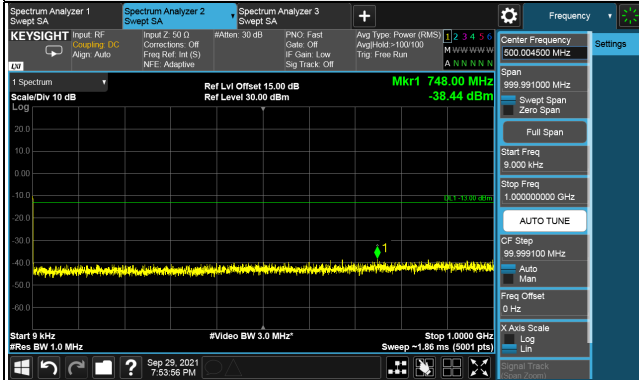

Frequency Range : 1GHz ~ 26GHz

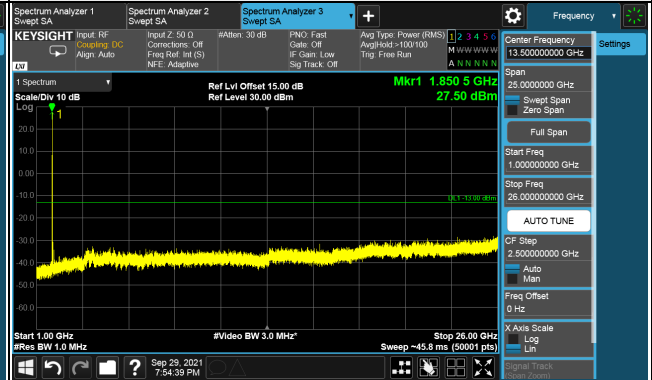

Channel 376500 (1882.5MHz)

Frequency Range : 9kHz ~ 1GHz

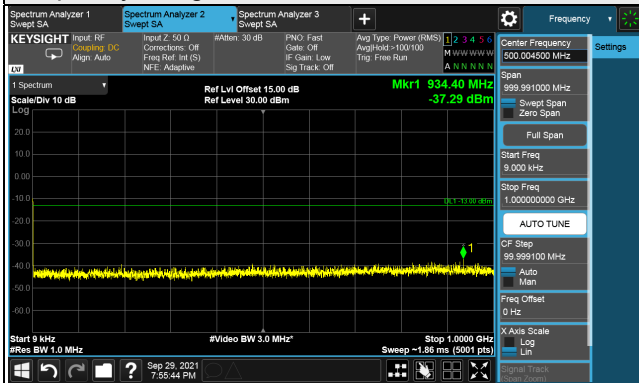

Frequency Range : 1GHz ~ 26GHz

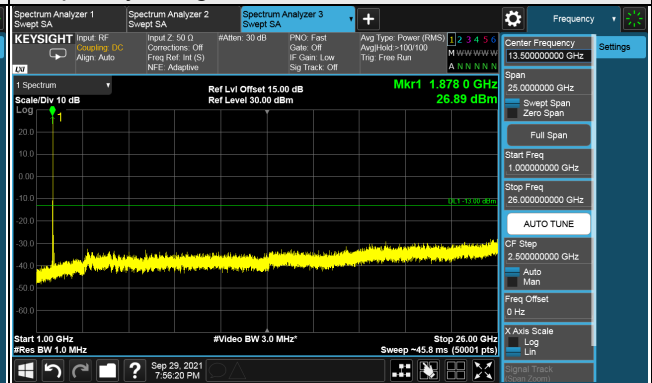

Channel 382000 (1910.0MHz)

Frequency Range : 9kHz ~ 1GHz

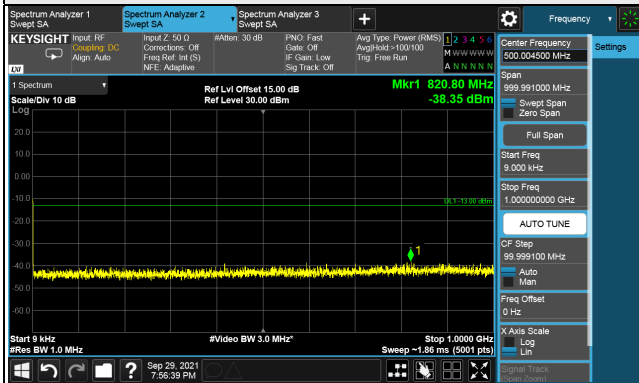

Frequency Range : 1GHz ~ 26GHz

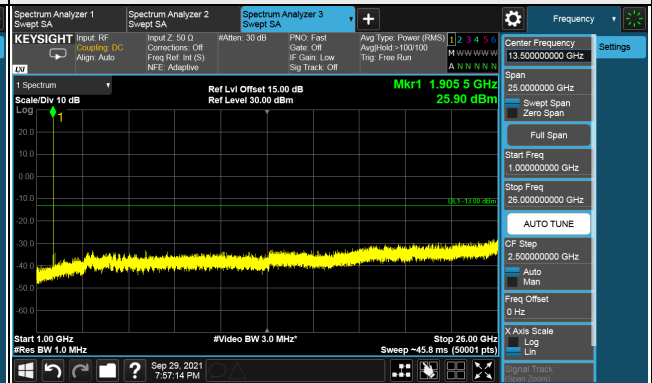

\*The 9kHz signal over the limit is from Spectrum.

n25, Channel Bandwidth 15MHz

Channel 371500 (1857.5MHz)

Frequency Range : 9kHz ~ 1GHz

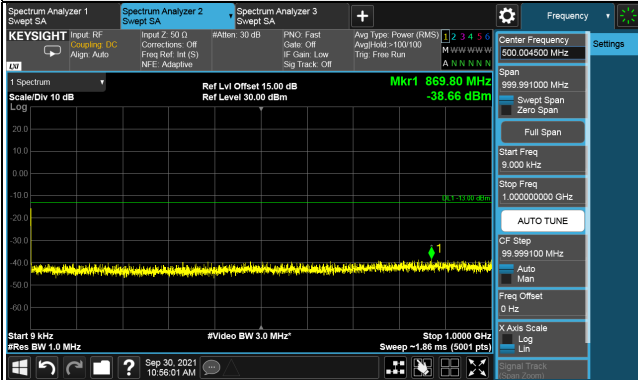

Frequency Range : 1GHz ~ 26GHz

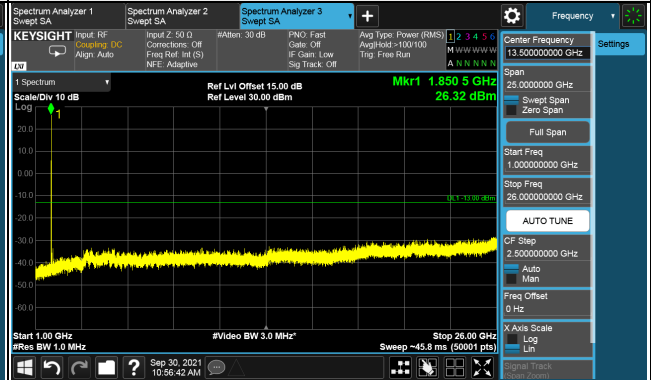

Channel 376500 (1882.5MHz)

Frequency Range : 9kHz ~ 1GHz

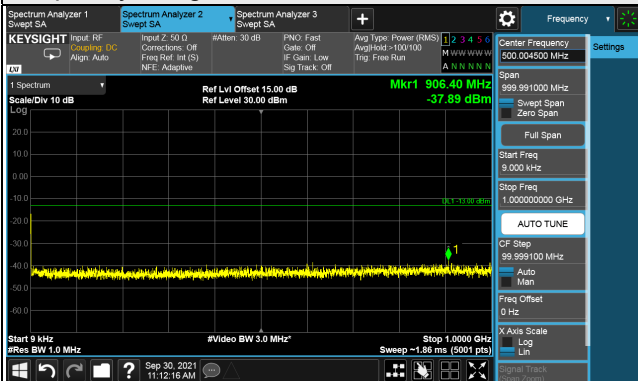

Frequency Range : 1GHz ~ 26GHz

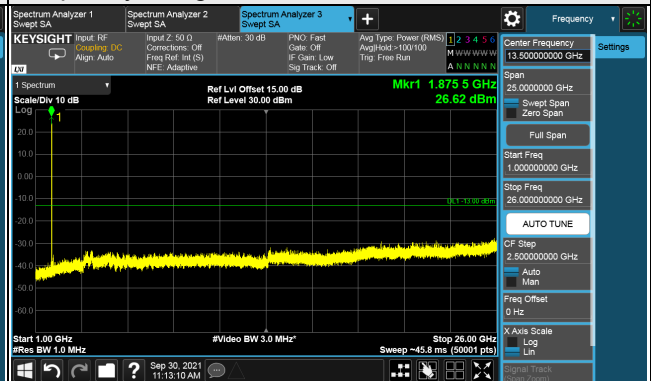

Channel 381500 (1907.5MHz)

Frequency Range : 9kHz ~ 1GHz

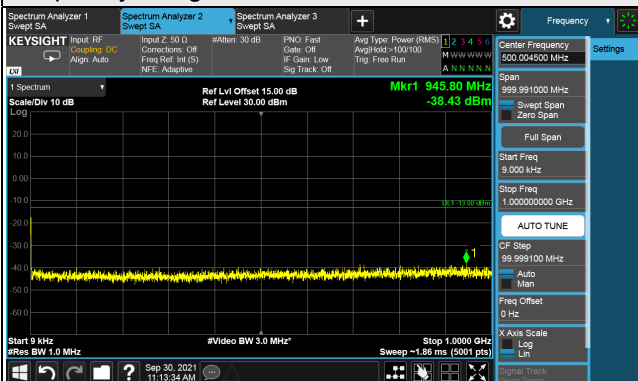

Frequency Range : 1GHz ~ 26GHz

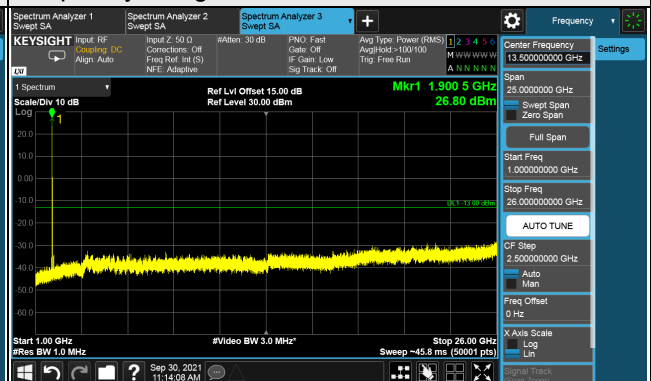

\*The 9kHz signal over the limit is from Spectrum.

n25, Channel Bandwidth 20MHz

Channel 372000 (1860.0MHz)

Frequency Range : 9kHz ~ 1GHz

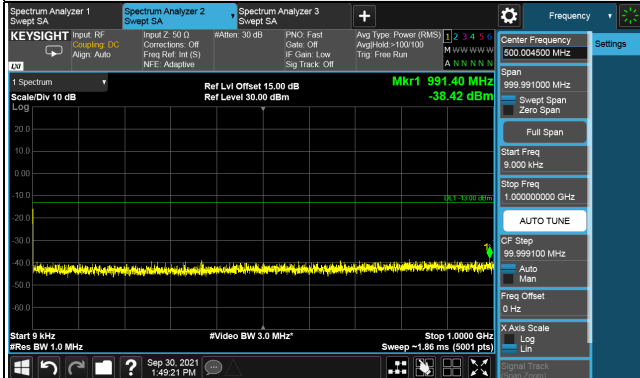

Frequency Range : 1GHz ~ 26GHz

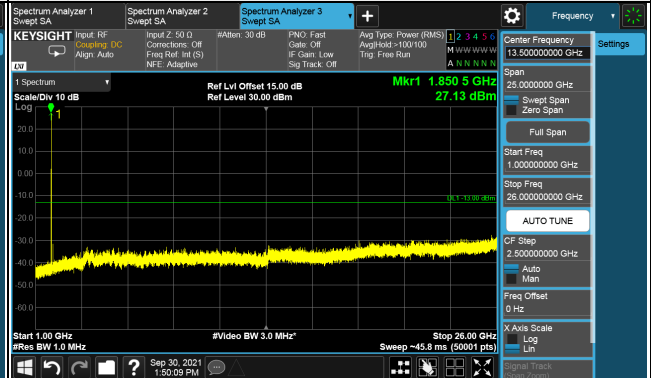

Channel 376500 (1882.5MHz)

Frequency Range : 9kHz ~ 1GHz

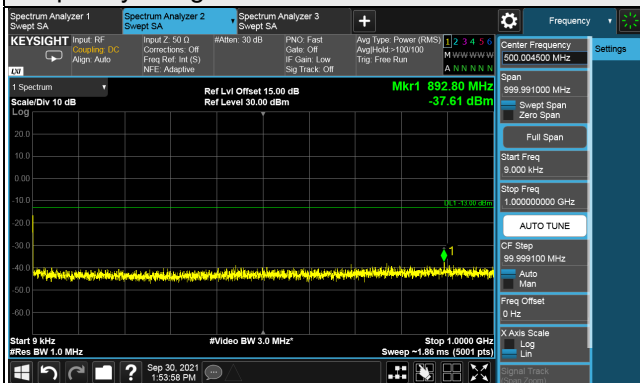

Frequency Range : 1GHz ~ 26GHz

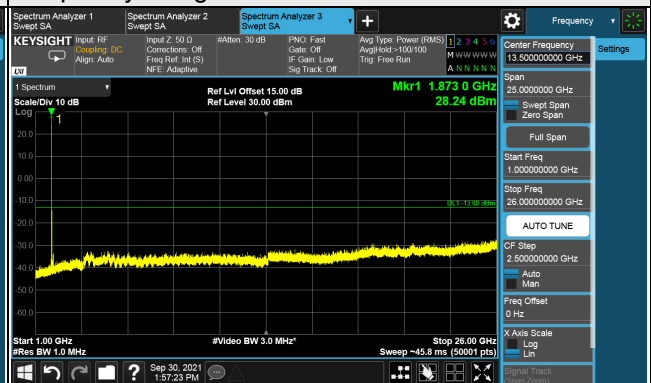

Channel 381000 (1905.0MHz)

Frequency Range : 9kHz ~ 1GHz

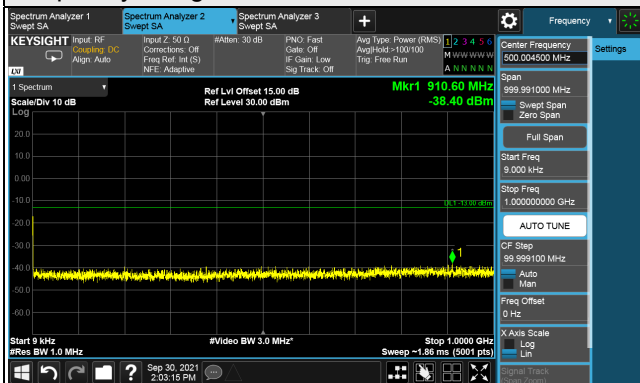

Frequency Range : 1GHz ~ 26GHz

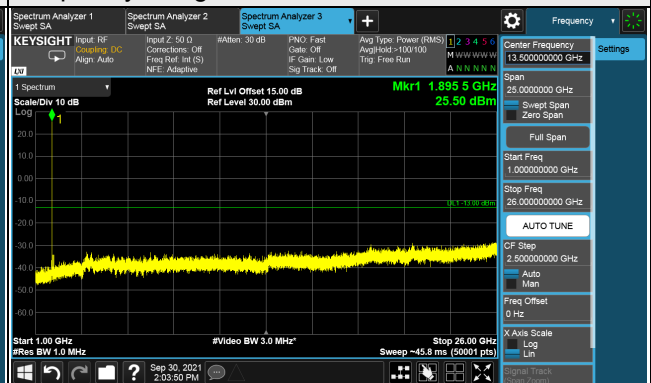

\*The 9kHz signal over the limit is from Spectrum.

**LTE Band 12**

Channel Band width: 1.4MHz

Channel 23017 (699.7MHz)

Frequency Range : 9kHz~1GHz

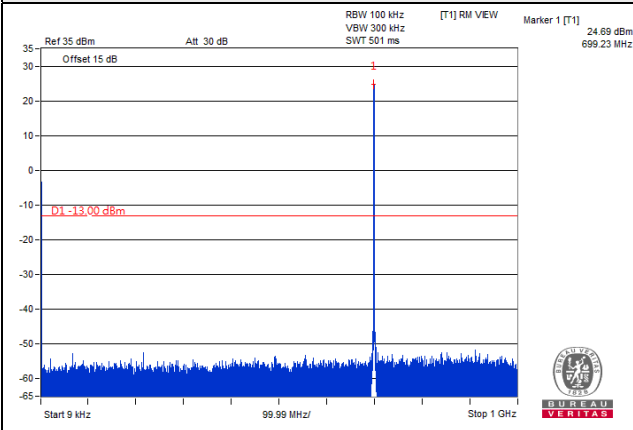

Frequency Range : 1GHz~8GHz

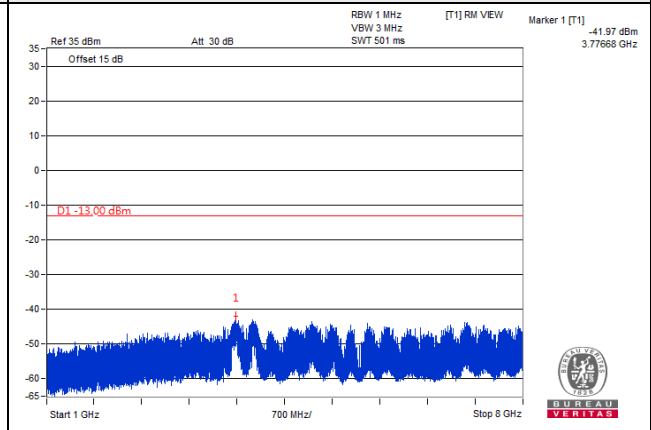

Channel 23095 (707.5MHz)

Frequency Range : 9kHz~1GHz

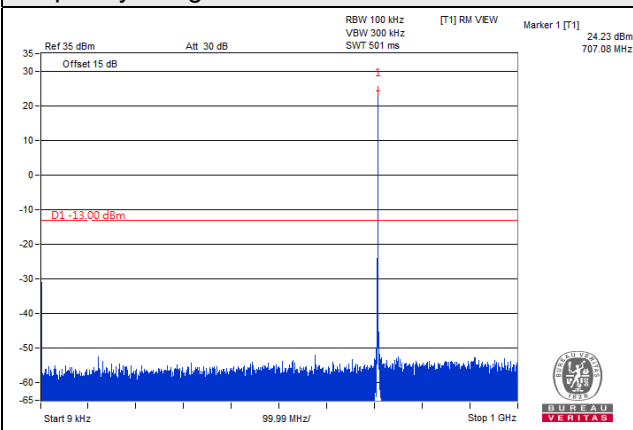

Frequency Range : 1GHz~8GHz

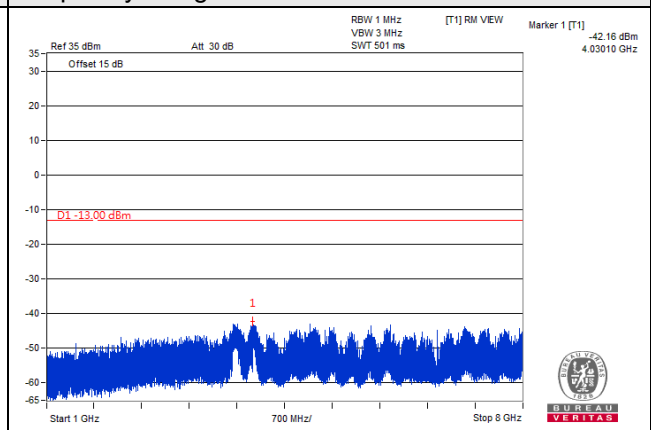

Channel 23173 (715.3MHz)

Frequency Range : 9kHz~1GHz

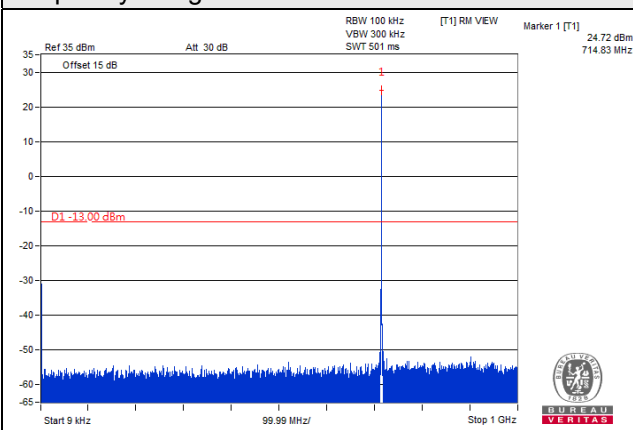

Frequency Range : 1GHz~8GHz

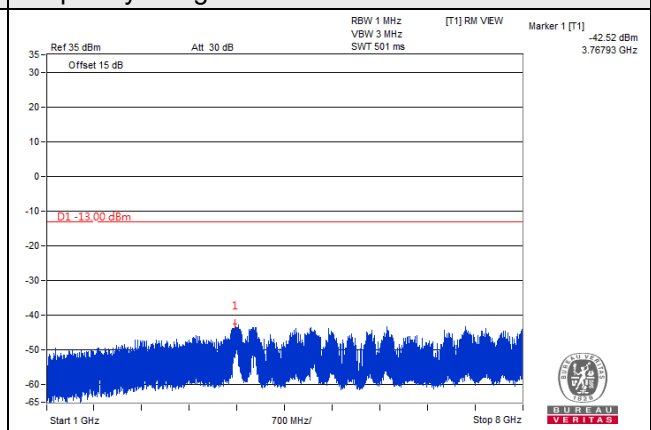

Channel Band width: 3MHz

Channel 23025 (700.5MHz)

Frequency Range : 9kHz~1GHz

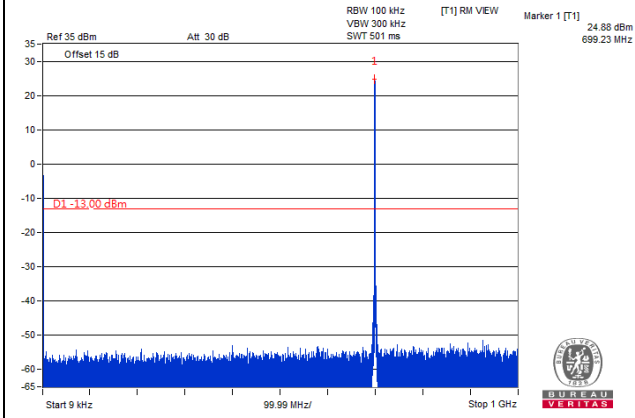

Frequency Range : 1GHz~8GHz

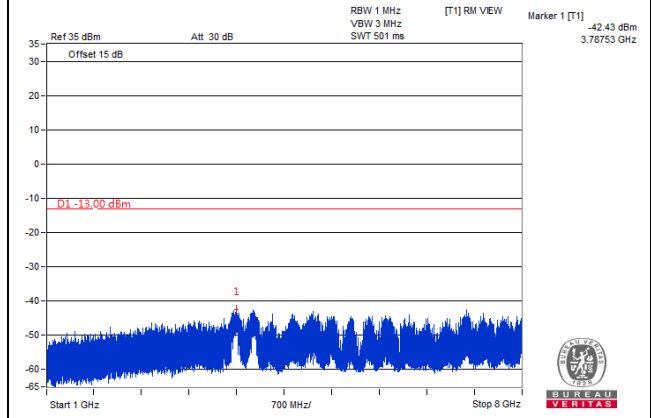

Channel 23095 (707.5MHz)

Frequency Range : 9kHz~1GHz

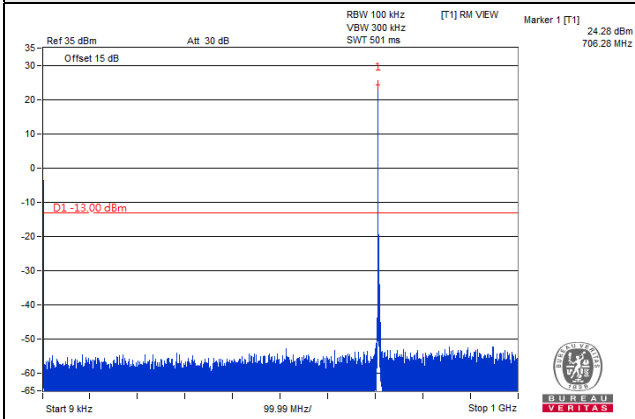

Frequency Range : 1GHz~8GHz

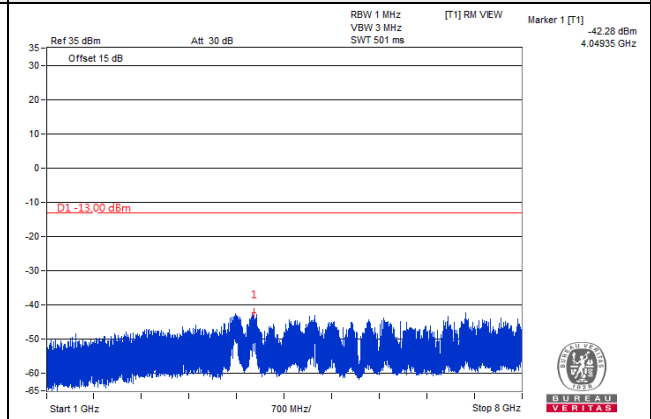

Channel 23165 (714.5MHz)

Frequency Range : 9kHz~1GHz

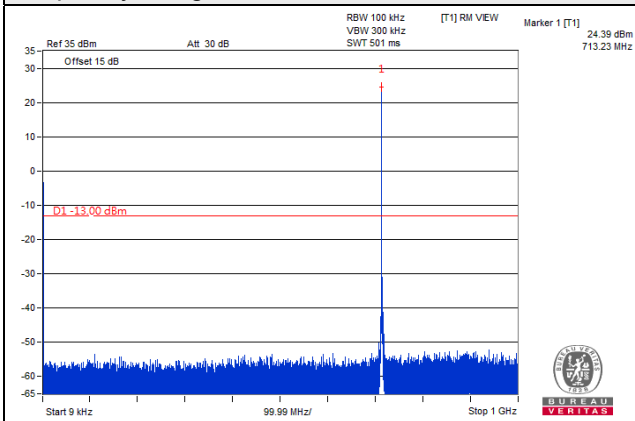

Frequency Range : 1GHz~8GHz

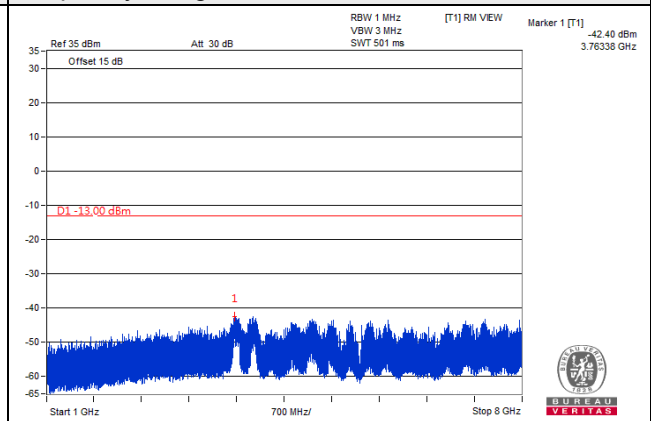

Channel Band width: 5MHz

Channel 23035 (701.5MHz)

Frequency Range : 9kHz~1GHz

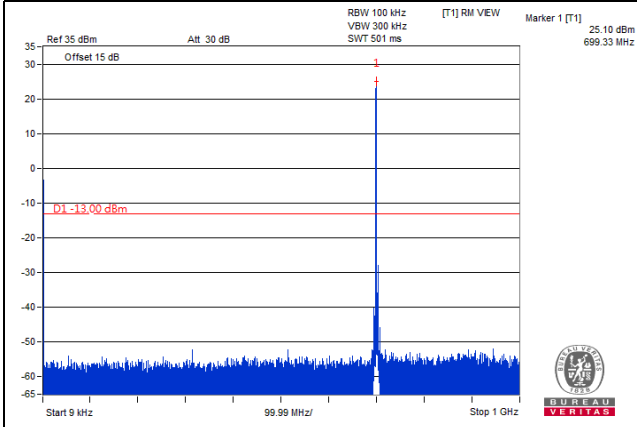

Frequency Range : 1GHz~8GHz

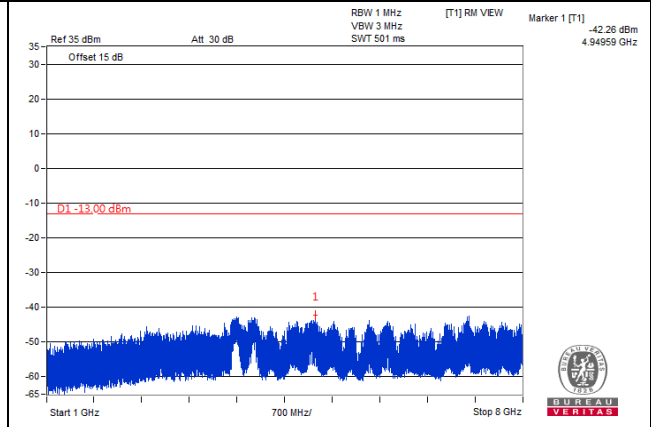

Channel 23095 (707.5MHz)

Frequency Range : 9kHz~1GHz

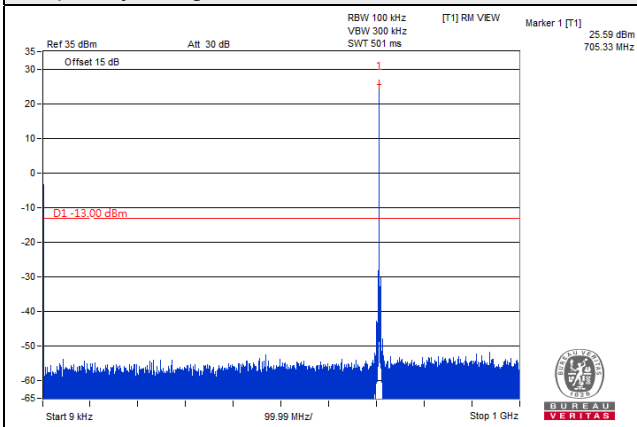

Frequency Range : 1GHz~8GHz

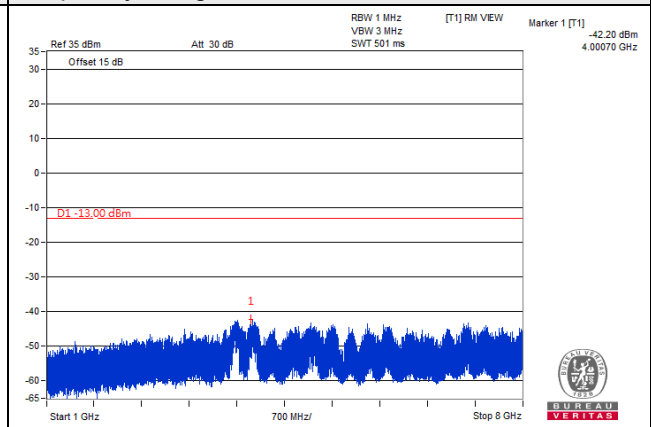

Channel 23155 (713.5MHz)

Frequency Range : 9kHz~1GHz

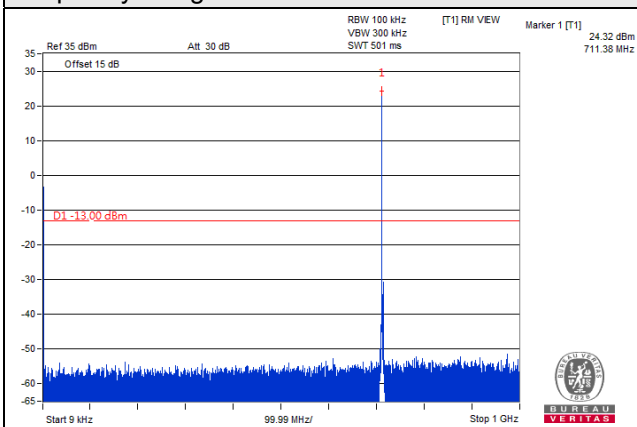

Frequency Range : 1GHz~8GHz

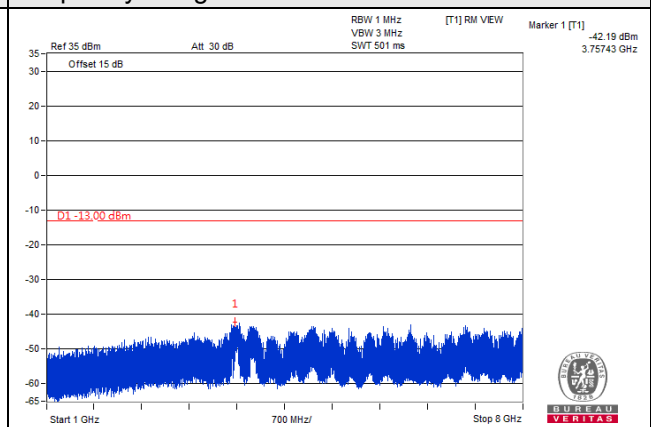

Channel Band width: 10MHz

Channel 23060 (704MHz)

Frequency Range : 9kHz~1GHz

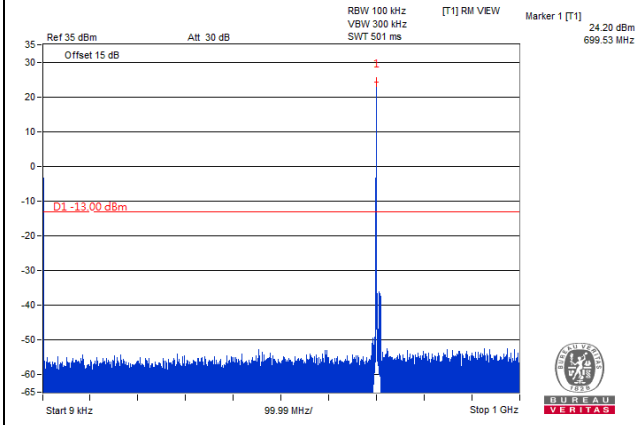

Frequency Range : 1GHz~8GHz

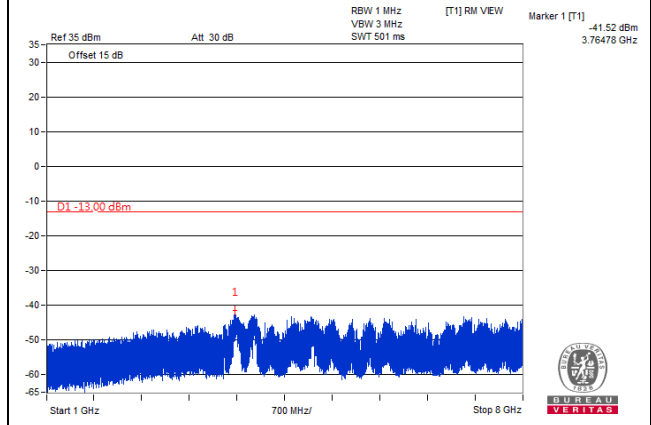

Channel 23095 (707.5MHz)

Frequency Range : 9kHz~1GHz

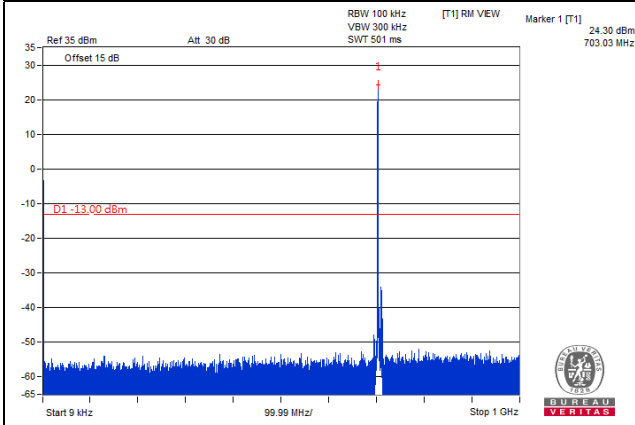

Frequency Range : 1GHz~8GHz

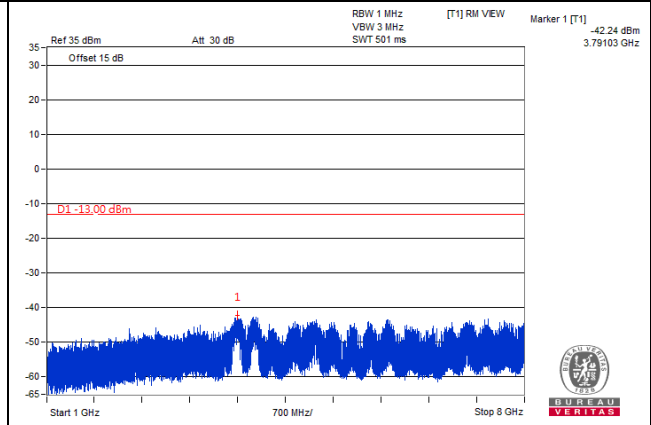

Channel 23130 (711MHz)

Frequency Range : 9kHz~1GHz

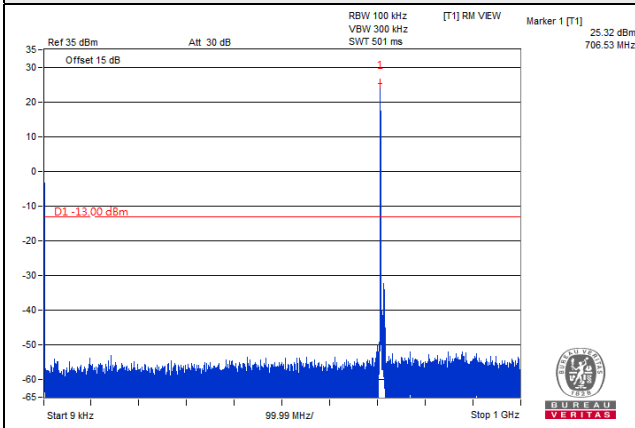

Frequency Range : 1GHz~8GHz

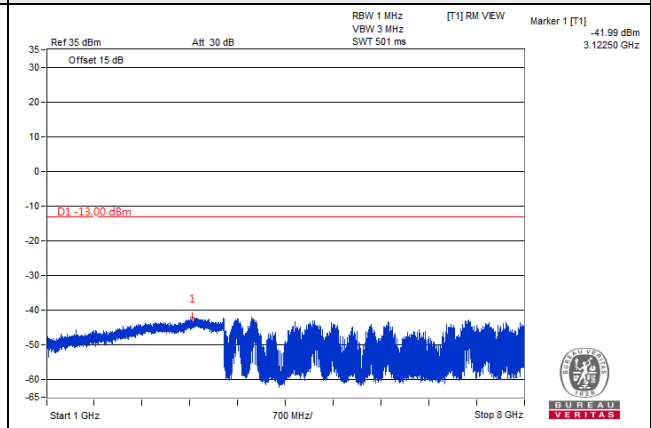



## 4.8 Radiated Emission Measurement

### 4.8.1 Limits of Radiated Emission Measurement

For n25:

The power of any emission outside of the authorized operating frequency ranges must be attenuated below the transmitting power (P) by a factor of at least  $43 + 10 \log(P)$  dB. The emission limit equal to  $-13\text{dBm}$ .

For LTE Band 12:

According to FCC 27.53(g) for operations in the 600 MHz band and the 698-746 MHz band, the power of any emission outside a licensee's frequency band(s) of operation shall be attenuated below the transmitter power (P) within the licensed band(s) of operation, measured in watts, by at least  $43 + 10 \log(P)$  dB. Compliance with this provision is based on the use of measurement instrumentation employing a resolution bandwidth of 100 kilohertz or greater.

### 4.8.2 Test Procedure

- a. In the semi-anechoic chamber, EUT placed on the 0.8m(below or equal 1GHz) and/or 1.5m(above 1GHz) height of Turn Table, rotated the table around 360 degrees to search the maximum radiation power and receiver antenna shall be rotated vertical and horizontal polarization and moved height from 1m to 4m to find the maximum polar radiated power. The "Read Value" is the spectrum reading the maximum power value.
- b. The height of antenna is varied from one meter to four meters above the ground to determine the maximum value of the field strength. Both horizontal and vertical polarizations of the antenna are set to make the measurement.
- c. Perform a field strength measurement and record the worse read value, is the field strength value via a spectrum reading obtained corrected for antenna factor, cable loss and pre-amplifier factor and then mathematically convert the measured field strength level to EIRP/ERP level.
- d. Following C63.26 section 5.5 and 5.2.7
  - $\text{EIRP (dBm)} = E (\text{dB}\mu\text{V/m}) + 20\log(D) - 104.8$ ; where D is the measurement distance (in the far field region) in m.
  - $\text{ERP (dBm)} = E (\text{dB}\mu\text{V/m}) + 20\log(D) - 104.8 - 2.15$ ; where D is the measurement distance (in the far field region) in m.

Note:

1. The resolution bandwidth and video bandwidth of test receiver/spectrum analyzer is 1MHz/3MHz.
2. The emission levels were against the limit of frequency range 9 kHz ~ 30 MHz:  
The amplitude of spurious emissions attenuated more than 20 dB below the permissible value is not required to be report.

### 4.8.3 Deviation from Test Standard

No deviation.

#### 4.8.4 Test Setup

For radiated emission 30MHz to 1GHz

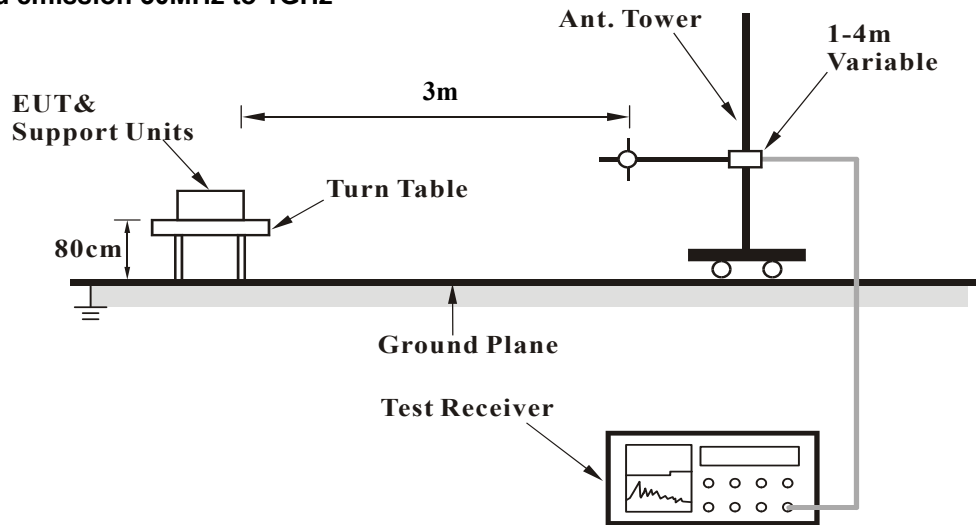

For radiated emission above 1GHz

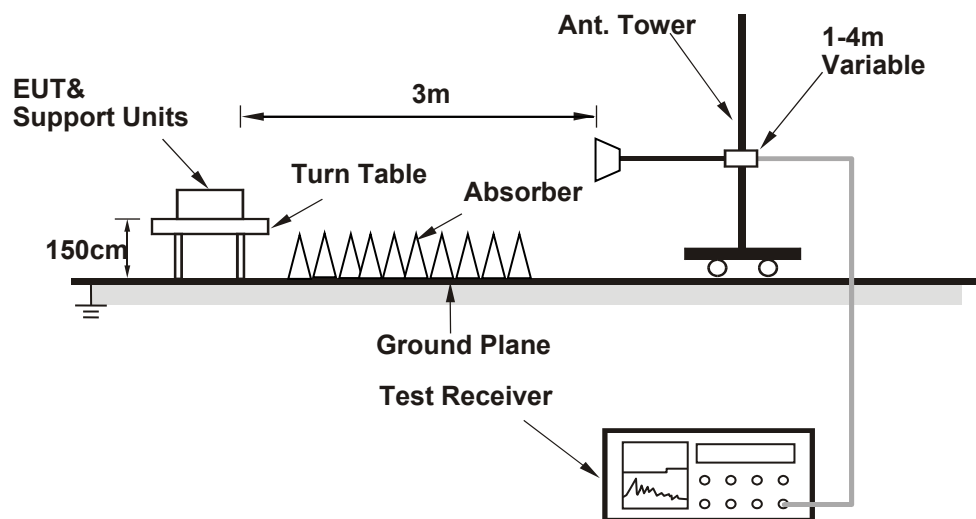

For the actual test configuration, please refer to the attached file (Test Setup Photo).

### 4.8.5 Test Results

Below 1GHz

n25, Channel Bandwidth 20MHz

Mode	TX channel 376500 (1882.5MHz)	Frequency Range	Below 1000 MHz
Environmental Conditions	23deg. C, 67%RH	Input Power	120Vac, 60Hz
Tested By	Adair Peng		

Antenna Polarity & Test Distance : Horizontal at 3 m								
No	Frequency (MHz)	EIRP (dBm)	Limit (dBm)	Margin (dB)	Antenna Height (m)	Table Angle (Degree)	Raw Value (dBuV)	Correction Factor (dB/m)
1	163.55	-58.00	-13.00	-45.00	1.50 H	112	55.47	-113.47
2	197.29	-59.12	-13.00	-46.12	1.50 H	118	57.87	-116.99
3	288.67	-62.49	-13.00	-49.49	1.00 H	77	50.68	-113.17
4	339.28	-57.47	-13.00	-44.47	1.00 H	149	54.34	-111.81
5	357.55	-56.65	-13.00	-43.65	2.00 H	150	54.94	-111.59
6	380.04	-61.50	-13.00	-48.50	1.00 H	66	49.39	-110.89

Remarks:

1.  $EIRP(dBm) = Raw\ Value(dBuV) + Correction\ Factor(dB/m)$
2.  $Correction\ Factor(dB/m) = Antenna\ Factor(dB/m) + Cable\ Factor(dB) - Pre-Amplifier\ Factor(dB) + 20\log(D) - 104.8$
3.  $Margin\ value = EIRP - Limit\ value$
4. The other EIRP levels were very low against the limit.

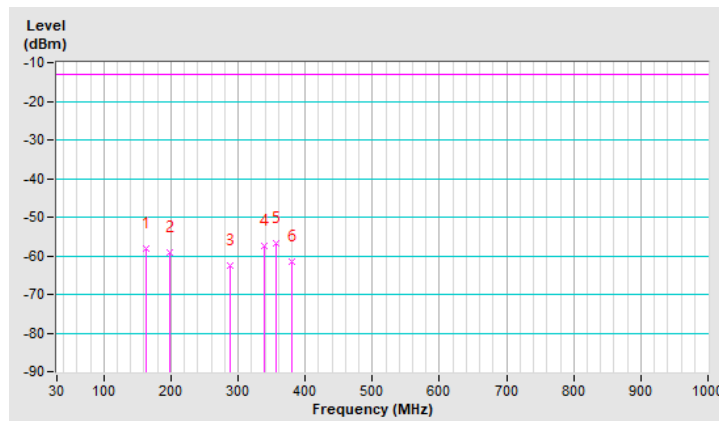

Mode	TX channel 376500 (1882.5MHz)	Frequency Range	Below 1000 MHz
Environmental Conditions	23deg. C, 67%RH	Input Power	120Vac, 60Hz
Tested By	Adair Peng		

Antenna Polarity & Test Distance : Vertical at 3m								
No	Frequency (MHz)	EIRP (dBm)	Limit (dBm)	Margin (dB)	Antenna Height (m)	Table Angle (Degree)	Raw Value (dBuV)	Correction Factor (dB/m)
1	35.62	-48.53	-13.00	-35.53	1.50 V	279	66.21	-114.74
2	72.17	-56.33	-13.00	-43.33	1.00 V	110	60.54	-116.87
3	139.65	-60.48	-13.00	-47.48	1.00 V	81	53.43	-113.91
4	171.99	-58.16	-13.00	-45.16	2.00 V	9	55.81	-113.97
5	353.33	-60.00	-13.00	-47.00	1.50 V	172	51.70	-111.70
6	772.26	-56.31	-13.00	-43.31	1.00 V	84	46.75	-103.06

Remarks:

1.  $EIRP(dBm) = Raw\ Value(dBuV) + Correction\ Factor(dB/m)$
2.  $Correction\ Factor(dB/m) = Antenna\ Factor(dB/m) + Cable\ Factor(dB) - Pre-Amplifier\ Factor(dB) + 20\log(D) - 104.8$
3. Margin value = EIRP – Limit value
4. The other EIRP levels were very low against the limit.

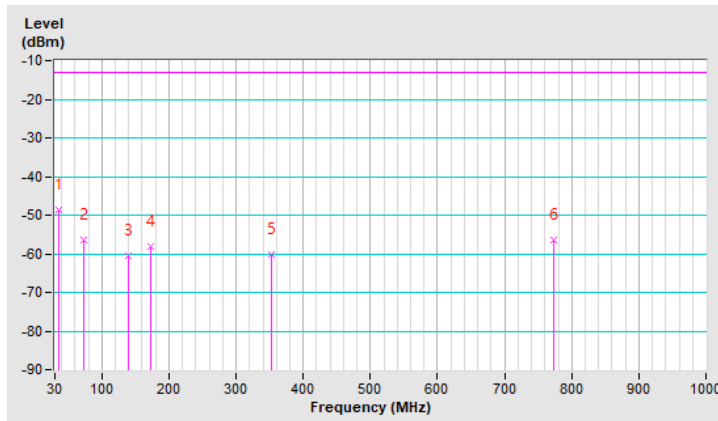

LTE Band 12, Channel Bandwidth 10MHz

Mode	TX channel 23095 (707.5MHz)	Frequency Range	Below 1000 MHz
Environmental Conditions	23deg. C, 67%RH	Input Power	120Vac, 60Hz
Tested By	Adair Peng		

Antenna Polarity & Test Distance : Horizontal at 3 m								
No	Frequency (MHz)	ERP (dBm)	Limit (dBm)	Margin (dB)	Antenna Height (m)	Table Angle (Degree)	Raw Value (dBuV)	Correction Factor (dB/m)
1	34.22	-63.52	-13.00	-50.52	1.49 H	22	53.35	-116.87
2	51.09	-66.85	-13.00	-53.85	1.49 H	38	49.13	-115.98
3	84.83	-69.05	-13.00	-56.05	1.49 H	106	52.72	-121.77
4	179.01	-73.29	-13.00	-60.29	1.49 H	2	43.66	-116.95
5	256.33	-73.41	-13.00	-60.41	1.49 H	0	43.31	-116.72
6	350.52	-60.93	-13.00	-47.93	1.49 H	149	53.01	-113.94

Remarks:

1.  $ERP(dBm) = Raw\ Value(dBuV) + Correction\ Factor(dB/m)$
2.  $Correction\ Factor(dB/m) = Antenna\ Factor(dB/m) + Cable\ Factor(dB) - Pre-Amplifier\ Factor(dB) + 20\log(D) - 104.8 - 2.15$
3.  $Margin\ value = ERP - Limit\ value$
4. The other ERP levels were very low against the limit.

