

RF Test Report

Test in accordance with
Federal Communications Commission(FCC)
CFR TITLE 47, Parts 2,22

Product Name: ELS61-AUS
Model No. : ELS61-AUS
FCC ID: QIPELS61-AUS

Applicant : Gemalto M2M GmbH
Address : Siemensdamm 50, 13629 Berlin, Germany

Date of Receipt : 04-30-2016
Test Date : 04-30-2016~05-16-2016
Issued Date : 06-06-2016
Report No. : UL05420160430FCC004-1
Report Version : V1.0

Notes:

The test result only relate to these samples which have been tested.
Partly using this report will not be admitted unless been allowed by Unilab.
Unilab is only responsible for the complete report with the reported stamp of Unilab.

Test Report Certification

Issued Date : 06-06-2016
ReportNo. :UL05420160430FCC004-1

Product Name : ELS61-AUS
Applicant : Gemalto M2M GmbH
Address : Siemensdamm 50, 13629 Berlin, Germany
Manufacturer : Gemalto M2M GmbH
Address : Siemensdamm 50, 13629 Berlin, Germany
Model No. : ELS61-AUS
EUT Voltage : MIN: 3.0V, NOR: 3.8V, MAX: 4.5V
Brand Name : GEMALTO
FCC ID: QIPELS61-AUS

Applicable Standard : ANSI/TIA-603-D-2010;FCC KDB 971168D01 Power Meas License Digital
Systems v02r02;FCC CFR Title 47 Part 2;FCCCFR Title 47 Part 22

Test Result : Complied

Performed Location : Unilab (Shanghai) Co., Ltd.
FCC 2.948 register number is 714465
No. 1350, Lianxi Rd. Pudong New District, Shanghai, China
TEL: +86-21-50275125FAX: +86-21-50277862

Prepared by : David Ye
(Technical Engineer: David Ye)

Reviewed by : Forest Cao
(Senior Engineer: Forest Cao)

Approved by : Eva Wang
(SupervisorEngineer: Eva Wang)

TABLE OF CONTENTS

SUMMARY OF TEST RESULT.....	4
1. General Information.....	5
1.1. EUT Description	5
1.2. Mode of Operation	6
1.3. Tested System Details	9
1.5. EUT Exercise Software	10
2. Technical Test.....	11
2.1. Test Environment	11
3. Peak Output Power	12
3.1. Test Equipment.....	12
3.2. Test Setup.....	12
3.3. Limit.....	13
3.5. Uncertainty	14
3.6. Test Result	15
4. Occupied Bandwidth	20
4.1. Test Equipment.....	20
4.2. Test Setup	20
4.3. Limit.....	20
4.4. Test Procedure	21
4.5. Uncertainty	21
5.Spurious Emission At Antenna Terminals (+/- 1MHz)	38
5.1. Test Equipment.....	38
5.2. Test Setup	38
5.3. Limit.....	38
5.4. Test Procedure	39
5.5. Uncertainty	39
5.6. Test Result	40
6.Spurious Emission.....	56
6.1. Test Equipment.....	56
6.2. Test Setup	57
6.3. Limit.....	58
6.4. Test Procedure	58
6.5. Uncertainty	59
6.6. Test Result	60
7. FrequencyStability Under Temperature & VoltageVariations	80
7.1. Test Equipment.....	80
7.2. Test Setup	80
7.3. Limit.....	80
7.4. Test Procedure	81
7.5. Uncertainty	81
7.6. Test Result	82
8.Attachment.....	87

SUMMARY OF TEST RESULT

Report Section	SPECIFICATION	Description	Limit	Result
	FCC CFR 47			
3	part2.1046	Conducted Output Power	N/A	PASS
3	part 22.913(a)(2)	Effective Radiated Power Equivalent Isotropic Radiated Power	<7 Watts <2 Watts <1 Watt <3 Watts	PASS
4	part 2.1046	Modulation Characteristic	N/A	PASS
4	part 2.1049 part 22.917(a)	Occupied Bandwidth	N/A	PASS
5	part 2.1051 part 22.917(a)	Band Edge Measurement	<43+10lg(P[Watts])	PASS
6	part 2.1051 part 22.917(a)	Conducted Spurious Emission	<43+10lg(P[Watts])	PASS
6	part 2.1053 part 22.917(a)	Field Strength of Spurious Radiation	<43+10lg(P[Watts])	PASS
7	part 2.1055 part 22.355	Frequency Stability for Temperature & Voltage	<2.5 ppm	PASS

1.General Information

1.1. EUT Description

Product Name:	ELS61-AUS
Model Name:	ELS61-AUS
Hardware Version:	B2.1
Software Version:	00.380
RF Exposure Environment:	Uncontrolled
LTE	
Support Band:	LTE Band V
Tx FrequencyRange:	LTE Band V: 824MHz ~849MHz
Rx FrequencyRange:	LTE Band V: 869MHz ~894MHz
Type of modulation:	LTE: QPSK,16-QAM
Antenna Type:	Connector
AntennaPeak Gain:	LTE Band V: 2.15dBi

1.2. Mode of Operation

Unilab has verified the construction and function in typical operation. EUT is inlink mode with base station emulator at maximum power level. All the test modes were carried out with the EUT in normal operation, which was shown in this test report is the worst test mode and defined as:

Mode	Band Width (MHz)	QPSK		16-QAM	
		RB Size	RB Offset	RB Size	RB Offset
LTE Band 5	1.4	1	0	1	0
	3	1	0	1	0
	5	1	0	1	0
	10	1	0	1	0

Note:

1. Regards to the frequency band operation: the lowest, middle and highest frequency of channel were selected to perform the test, then shown on this report.
2. For the ERP/EIRP and radiated emission test, every axis (X, Y, Z) was verified, and show the worst (Z axis) result on this report.
3. For conducted test, both two Modulations(QPSK and 16-QAM) are tested. For RSE, only the maximum RF output power level are chosen.

The conducted power table is as follows:

Mode	Band Width	Channel	Frequency (MHz)	Modulation	RB Configuration		Average Power (dBm)	Average Power (Watts)
					RB Size	RB Offset		
LTE Band 5	1.4 MHz	20407	824.7	QPSK	1	0	21.99	0.16
					1	5	21.90	0.15
					5	1	21.82	0.15
				6	0	20.81	0.15	
				16-QAM	1	0	21.18	0.13
					1	5	21.10	0.13
		5	1		21.01	0.13		
		20525	836.5	QPSK	1	0	21.74	0.15
					1	5	21.73	0.15
					5	1	21.76	0.15
				6	0	20.81	0.12	
				16-QAM	1	0	21.85	0.15
	1				5	21.80	0.15	
	5	1	21.75		0.15			
	20643	848.3	QPSK	6	0	20.81	0.12	
				1	0	21.73	0.15	
				1	5	21.66	0.15	
			16-QAM	5	1	21.71	0.15	
				6	0	20.74	0.12	
				1	0	20.82	0.12	
	3MHz	20415	QPSK	1	5	20.74	0.12	
				15	0	20.78	0.12	
				6	9	20.74	0.12	
			16-QAM	1	0	21.36	0.14	
1				14	21.15	0.13		
6				9	19.87	0.10		
20525		836.5	QPSK	15	0	19.93	0.10	
				1	0	21.70	0.15	
				1	14	21.62	0.15	
			16-QAM	6	9	20.66	0.12	
				15	0	20.59	0.12	
				1	0	20.74	0.12	
20635	847.5	QPSK	1	14	20.62	0.12		
			6	9	19.82	0.10		
			15	0	19.86	0.10		
		QPSK	1	0	21.67	0.15		
			1	14	21.59	0.15		
			6	9	20.73	0.12		

LTE Band 5	5MHz	20425	826.5	16-QAM	15	0	20.72	0.12	
					1	0	20.92	0.12	
					1	14	20.79	0.12	
					6	9	19.78	0.10	
					15	0	19.77	0.10	
		QPSK	1	0	21.78	0.15			
			1	24	21.57	0.14			
			8	17	21.75	0.15			
			25	0	20.70	0.12			
			16-QAM	1	0	21.16	0.13		
				1	24	21.02	0.13		
				8	17	20.78	0.12		
				25	0	19.82	0.10		
			QPSK	20525	836.5	QPSK	1	0	21.67
		1					24	21.46	0.14
	8	17					21.60	0.14	
	16-QAM	25		0	20.60	0.11			
		1		0	20.96	0.12			
		1		24	20.75	0.12			
		8		17	20.63	0.12			
		25		0	19.72	0.09			
		QPSK		20625	846.5	QPSK	1	0	21.66
	1		24				21.51	0.14	
	8		17				21.61	0.14	
	16-QAM		25	0	20.63	0.12			
			1	0	20.79	0.12			
			1	24	20.68	0.12			
			8	17	20.81	0.12			
			25	0	19.79	0.10			
			QPSK	20450	829	QPSK	1	0	21.71
	1	49					21.43	0.14	
	16	34					20.51	0.11	
	16-QAM	50				0	20.68	0.12	
		1				0	21.24	0.13	
		1				49	20.94	0.12	
		16				34	19.74	0.09	
		50				0	19.80	0.10	
		QPSK				20525	836.5	QPSK	1
	1			49	21.46				0.14
	16			34	20.54				0.11
	16-QAM			50	0	20.63	0.12		
				1	0	20.68	0.12		
1				49	20.53	0.11			
16		34		19.69	0.09				
50		0	19.71	0.09					
QPSK		20600	844	QPSK	1	0	21.54	0.14	
	1				49	21.43	0.14		
	16				34	20.58	0.11		
	50	0	20.61	0.11					

				16-QAM	1	0	20.74	0.12
					1	49	20.66	0.12
					16	34	19.68	0.09
					50	0	19.62	0.09

1.3. Tested System Details

The types for all equipments, plus descriptions of all cables used in the tested system (including inserted cards) are:

Product	Manufacturer	Model	Serial No.	Power Cord
Radio Communication Tester	R&S	CMW500	147483	N/A

1.4. Configuration of Tested System Connection Diagram

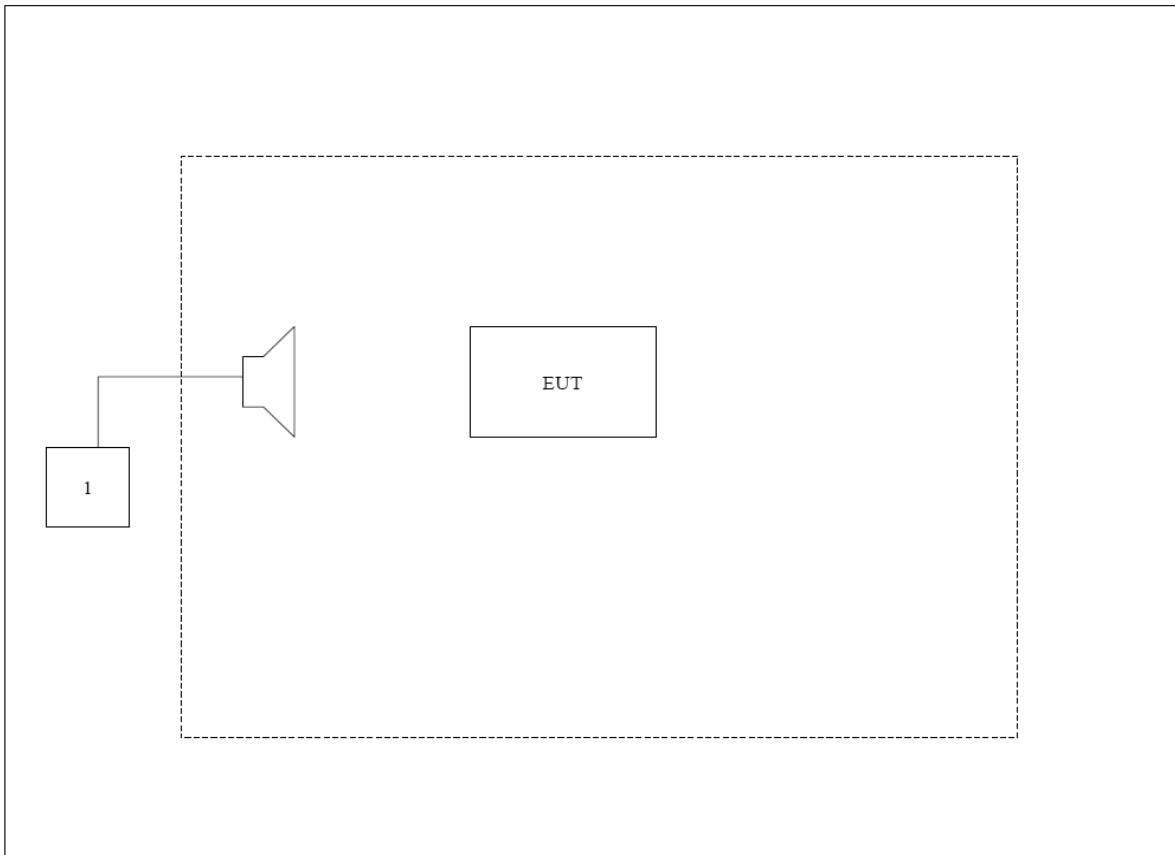

1.5. EUT Exercise Software

1	Setup the EUT and simulators as shown on above.
2	Turn on the power of all equipment.
3	EUT Communicate with CMW500, then select channel to test.

2. Technical Test

2.1. Test Environment

Items	Required (IEC 68-1)	Actual
Temperature (°C)	15-35	22
Humidity (%RH)	25-75	53
Barometric pressure (mbar)	860-1060	950-1000

3. Peak Output Power

3.1. Test Equipment

Instrument	Manufacturer	Model	Serial No.	Cali. Due Date
SpectrumAnalyzer	Agilent	N9038A	MY51210142	11/05/2016
RadioCommunicationTester	R&S	CMW500	147483	11/08/2016
SignalGenerator	Agilent	N5183A	MY50140938	01/03/2017
Preamplifier	CEM	EM30180	3008A0245	02/26/2017
DC Power Supply	Agilent	6612C	MY43002989	03/01/2017
Bilog Antenna	Schwarzbeck	VULB9160	9160-3316	09/19/2016
VHF-UHF-Biconical Antenna	Schwarzbeck	VUBA9117	9117-263	09/19/2016
Broad-Band Horn Antenna	Schwarzbeck	BBHA9120D	9120D-942	09/19/2016
Broad-Band Horn Antenna	Schwarzbeck	BBHA9120D	9120D-943	09/19/2016

The measureequipment had been calibrated once a year.

3.2. Test Setup

Conducted Power Measurement:

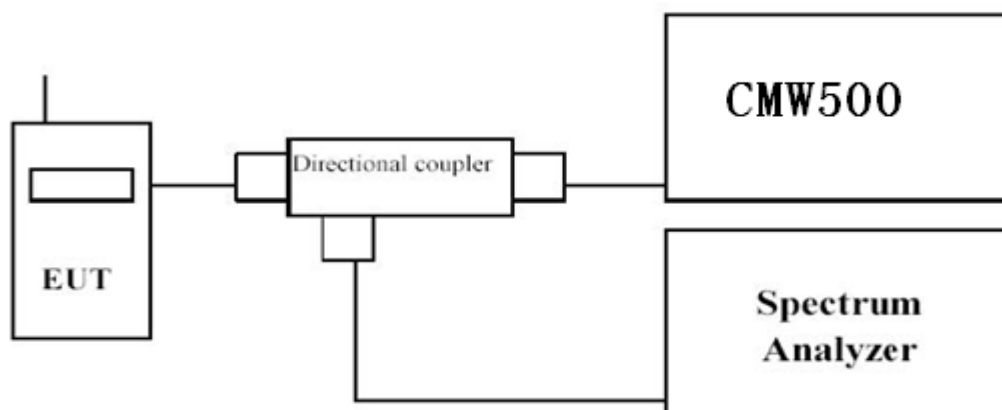

Radiated Spurious Measurement: below 1GHz

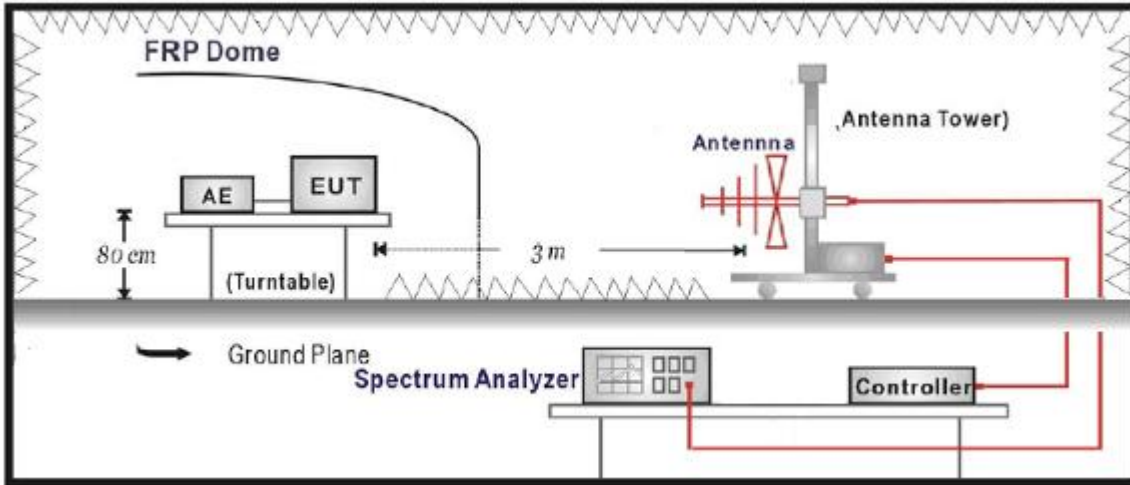

Radiated Spurious Measurement: above 1GHz

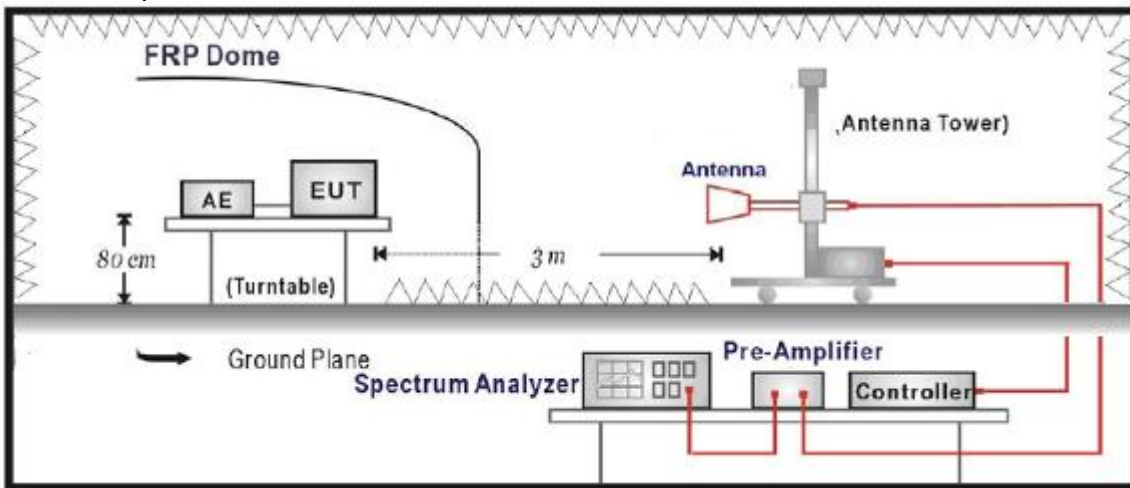

3.3. Limit

For FCC Part 22.913(a)(2):

The ERP of mobile transmitters and auxiliary test transmitters must not exceed 7 Watts.

For FCC Part 24.232(c):

The EIRP of mobile transmitters and auxiliary test transmitters must not exceed 2 Watts.

For FCC Part 27.50(d):

The EIRP of mobile transmitters and auxiliary test transmitters must not exceed 1 Watt.

For FCC Part 27.50(c):

The ERP of mobile transmitters and auxiliary test transmitters must not exceed 3 Watts.

3.4. Test Procedure

Conducted Power Measurement:

- a. Place the EUT on a bench and set it in transmitting mode.
- b. Connect a low loss RF cable from the antenna port to a spectrum analyzer and CMW500 by a Directional Couple.
- c. EUT Communicate with CMW500, then selects a channel for testing.
- d. Add a correction factor to the display of spectrum, and then test.

Radiated Power Measurement:

- a. The EUT shall be placed at the specified height on a support, and in the position closest to normal use as declared by provider.
- b. The test antenna shall be oriented initially for vertical polarization and shall be chosen to correspond to the frequency of the transmitter
- c. The output of the test antenna shall be connected to the measuring receiver.
- d. The transmitter shall be switched on and the measuring receiver shall be tuned to the frequency of the transmitter under test.
- e. The test antenna shall be raised and lowered through the specified range of height until a maximum signal level is detected by the measuring receiver.
- f. The transmitter shall then be rotated through 360° in the horizontal plane, until the maximum signal level is detected by the measuring receiver.
- g. The test antenna shall be raised and lowered again through the specified range of height until a maximum signal level is detected by the measuring receiver.
- h. The maximum signal level detected by the measuring receiver shall be noted.
- i. The transmitter shall be replaced by a substitution antenna.
- j. The substitution antenna shall be orientated for vertical polarization and the length of the substitution antenna shall be adjusted to correspond to the frequency of the transmitter.
- k. The substitution antenna shall be connected to a calibrated signal generator.
- l. If necessary, the input attenuator setting of the measuring receiver shall be adjusted in order to increase the sensitivity of the measuring receiver.
- m. The test antenna shall be raised and lowered through the specified range of height to ensure that the maximum signal is received.
- n. The input signal to the substitution antenna shall be adjusted to the level that produces a level detected by the measuring receiver, that is equal to the level noted while the transmitter radiated power was measured, corrected for the change of input attenuator setting of the measuring receiver.
- o. The measurement shall be repeated with the test antenna and the substitution antenna orientated for horizontal polarization.
- p. The measure of the effective radiated power is the larger of the two levels recorded at the input to the substitution antenna, corrected for gain of the substitution antenna if necessary.
- q. Test site anechoic chamber refer to ANSI C63.4: 2014.

3.5. Uncertainty

The measurement uncertainty is defined as for Conducted Power Measurement ± 1.1 dB,
for Radiated Power Measurement ± 3.1 dB

3.6. Test Result

The following table shows the conducted power measured:

Mode	Band Width	Channel	Frequency (MHz)	Modulation	RB Configuration		Average Power (dBm)	Average Power (Watts)
					RB Size	RB Offset		
LTE Band 5	1.4 MHz	20407	824.7	QPSK	1	0	21.99	0.16
				16-QAM	1	0	21.18	0.13
		20525	836.5	QPSK	5	1	21.76	0.15
				16-QAM	1	0	21.85	0.15
		20643	848.3	QPSK	1	0	21.73	0.15
				16-QAM	1	0	21.85	0.15
	3MHz	20415	825.5	QPSK	1	0	21.81	0.15
				16-QAM	1	0	21.36	0.14
		20525	836.5	QPSK	1	0	21.70	0.15
				16-QAM	1	0	20.74	0.12
		20635	847.5	QPSK	1	0	21.67	0.15
				16-QAM	1	0	20.92	0.12
	5MHz	20425	826.5	QPSK	1	0	21.78	0.15
				16-QAM	1	0	21.16	0.13
		20525	836.5	QPSK	1	0	21.67	0.15
				16-QAM	1	0	20.96	0.12
		20625	846.5	QPSK	1	0	21.66	0.15
				16-QAM	8	17	20.81	0.12
	10MHz	20450	829	QPSK	1	0	21.58	0.14
				16-QAM	1	0	20.68	0.12
		20525	836.5	QPSK	1	0	21.66	0.15
				16-QAM	1	0	20.68	0.12
		20600	844	QPSK	1	0	21.54	0.14
				16-QAM	1	0	20.74	0.12

The following table shows the Radiated power measured :

LTE Band 5 (QPSK, Band Width 1.4MHz,RB Size 1,RB Offset 0)

Frequency(MHz)	Ant. Pol. (H/V)	SG Reading(dBm)	Cable Loss(dB)	Gain (dBd)	ERP (dBm)	ERP (W)
Low Channel 20407(824.7MHz)						
824.7	H	29.56	3.83	-2.99	22.74	0.19
824.7	V	29.78	3.83	-2.99	22.96	0.20
Middle Channel 20525 (836.5MHz)						
836.5	H	29.53	3.96	-3.04	22.53	0.18
836.5	V	28.86	3.96	-3.04	21.86	0.15
High Channel 20643 (848.3MHz)						
848.3	H	29.54	3.97	-3.1	22.47	0.18
848.3	V	29.54	3.97	-3.1	22.47	0.18

LTE Band 5 (16-QAM, Band Width 1.4MHz,RB Size 1,RB Offset 0)

Frequency(MHz)	Ant. Pol. (H/V)	SG Reading(dBm)	Cable Loss(dB)	Gain (dBd)	ERP (dBm)	ERP (W)
Low Channel 20407(824.7MHz)						
824.7	H	29.35	3.83	-2.99	22.53	0.18
824.7	V	28.64	3.83	-2.99	21.82	0.15
Middle Channel 20525 (836.5MHz)						
836.5	H	29.41	3.96	-3.04	22.41	0.17
836.5	V	28.54	3.96	-3.04	21.54	0.14
High Channel 20643 (848.3MHz)						
848.3	H	29.56	3.97	-3.1	22.49	0.18
848.3	V	28.54	3.97	-3.1	21.47	0.14

LTE Band 5 (QPSK, Band Width 3MHz, RB Size 1, RB Offset 0)

Frequency(MHz)	Ant. Pol. (H/V)	SG Reading(dBm)	Cable Loss(dB)	Gain (dBd)	ERP (dBm)	ERP (W)
Low Channel 20415(825.5MHz)						
825.5	H	29.56	3.83	-2.99	22.74	0.19
825.5	V	28.56	3.83	-2.99	21.74	0.15
Middle Channel 20525 (836.5MHz)						
836.5	H	29.53	3.96	-3.04	22.53	0.18
836.5	V	29.06	3.96	-3.04	22.06	0.16
High Channel 20635 (847.5MHz)						
847.5	H	29.55	3.97	-3.1	22.48	0.18
847.5	V	29.52	3.97	-3.1	22.45	0.18

LTE Band 5 (16-QAM, Band Width 3MHz, RB Size 1, RB Offset 0)

Frequency(MHz)	Ant. Pol. (H/V)	SG Reading(dBm)	Cable Loss(dB)	Gain (dBd)	ERP (dBm)	ERP (W)
Low Channel 20415(825.5MHz)						
825.5	H	29.58	3.83	-2.99	22.76	0.19
825.5	V	28.51	3.83	-2.99	21.69	0.15
Middle Channel 20525 (836.5MHz)						
836.5	H	29.51	3.96	-3.04	22.51	0.18
836.5	V	28.64	3.96	-3.04	21.64	0.15
High Channel 20635 (847.5MHz)						
847.5	H	29.52	3.97	-3.1	22.45	0.18
847.5	V	28.75	3.97	-3.1	21.68	0.15

LTE Band 5 (QPSK, Band Width 5MHz, RB Size 1, RB Offset 0)

Frequency(MHz)	Ant. Pol. (H/V)	SG Reading(dBm)	Cable Loss(dB)	Gain (dBd)	ERP (dBm)	ERP (W)
Low Channel 20425(826.5MHz)						
826.5	H	29.64	3.83	-2.99	22.82	0.19
826.5	V	29.14	3.83	-2.99	22.32	0.17
Middle Channel 20525 (836.5MHz)						
836.5	H	29.72	3.96	-3.04	22.72	0.19
836.5	V	29.74	3.96	-3.04	22.74	0.19
High Channel 20625 (846.5MHz)						
846.5	H	29.65	3.97	-3.1	22.58	0.18
846.5	V	29.50	3.97	-3.1	22.43	0.18

LTE Band 5 (16-QAM, Band Width 5MHz, RB Size 1, RB Offset 0)

Frequency(MHz)	Ant. Pol. (H/V)	SG Reading(dBm)	Cable Loss(dB)	Gain (dBd)	ERP (dBm)	ERP (W)
Low Channel 20425(826.5MHz)						
826.5	H	29.41	3.83	-2.99	22.59	0.18
826.5	V	28.63	3.83	-2.99	21.81	0.15
Middle Channel 20525 (836.5MHz)						
836.5	H	29.63	3.96	-3.04	22.63	0.18
836.5	V	28.56	3.96	-3.04	21.56	0.14
High Channel 20625 (846.5MHz)						
846.5	H	29.54	3.97	-3.1	22.47	0.18
846.5	V	28.25	3.97	-3.1	21.18	0.13

LTE Band 5 (QPSK, Band Width 10MHz, RB Size 1, RB Offset 0)

Frequency(MHz)	Ant. Pol. (H/V)	SG Reading(dBm)	Cable Loss(dB)	Gain (dBd)	ERP (dBm)	ERP (W)
Low Channel 20450(829.0MHz)						
829.0	H	29.50	3.83	-2.99	22.68	0.19
829.0	V	29.51	3.83	-2.99	22.69	0.19
Middle Channel 20525 (836.5MHz)						
836.5	H	29.24	3.96	-3.04	22.24	0.17
836.5	V	29.14	3.96	-3.04	22.14	0.16
High Channel 20600 (844.0MHz)						
844.0	H	29.68	3.97	-3.1	22.61	0.18
844.0	V	29.59	3.97	-3.1	22.52	0.18

LTE Band 5 (16-QAM, Band Width 10MHz, RB Size 1, RB Offset 0)

Frequency(MHz)	Ant. Pol. (H/V)	SG Reading(dBm)	Cable Loss(dB)	Gain (dBd)	ERP (dBm)	ERP (W)
Low Channel 20450(829.0MHz)						
829.0	H	29.61	3.83	-2.99	22.79	0.19
829.0	V	28.51	3.83	-2.99	21.69	0.15
Middle Channel 20525 (836.5MHz)						
836.5	H	29.35	3.96	-3.04	22.35	0.17
836.5	V	28.56	3.96	-3.04	21.56	0.14
High Channel 20600 (844.0MHz)						
844.0	H	29.23	3.97	-3.1	22.16	0.16
844.0	V	28.35	3.97	-3.1	21.28	0.13

4. Occupied Bandwidth

4.1. Test Equipment

Occupied Bandwidth

Instrument	Manufacturer	Model	Serial No	Cal. Date
Radio Communication Tester	R&S	CMW500	147483	11/08/2016
Spectrum Analyzer	Agilent	N9038A	MY51210142	11/05/2016
DC Power Supply	Agilent	6612C	MY43002989	03/01/2017

The measure equipment had been calibrated once a year.

4.2. Test Setup

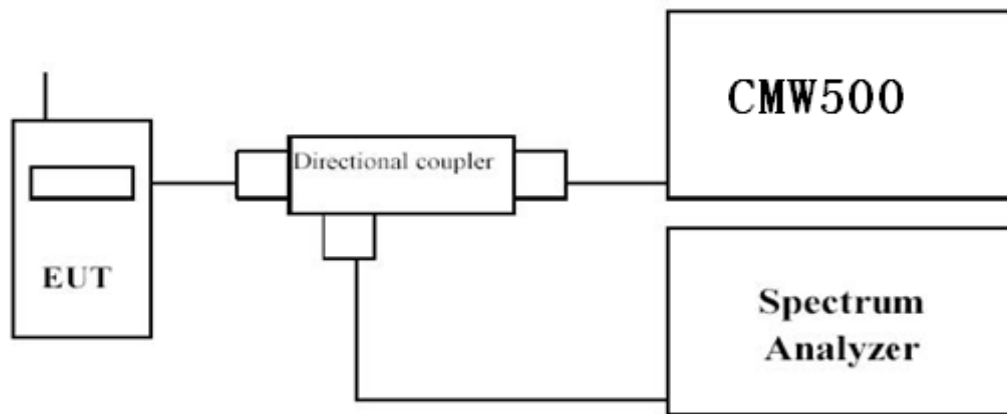

4.3. Limit

N/A

4.4. Test Procedure

1. The testing follows FCC KDB 971168 v02v02 Section 4.2;
2. Using Occupied Bandwidth measurement function of spectrum analyzer. In the Occupied Bandwidth measurement a resolution bandwidth of at least one percent of the emission bandwidth of the fundamental emission of the transmitter may be employed.

4.5. Uncertainty

The measurement uncertainty is defined as ± 10 Hz

4.6. Test Result

LTE Band 5 (QPSK, Band Width 1.4MHz,RB Size 6,RB Offset 0)

Channel No.	Frequency (MHz)	-26dB Occupied Bandwidth (MHz)	99% Occupied Bandwidth (MHz)
20407	824.7	1.401	1.1078
20525	836.5	1.362	1.1125
20643	848.3	1.362	1.1057

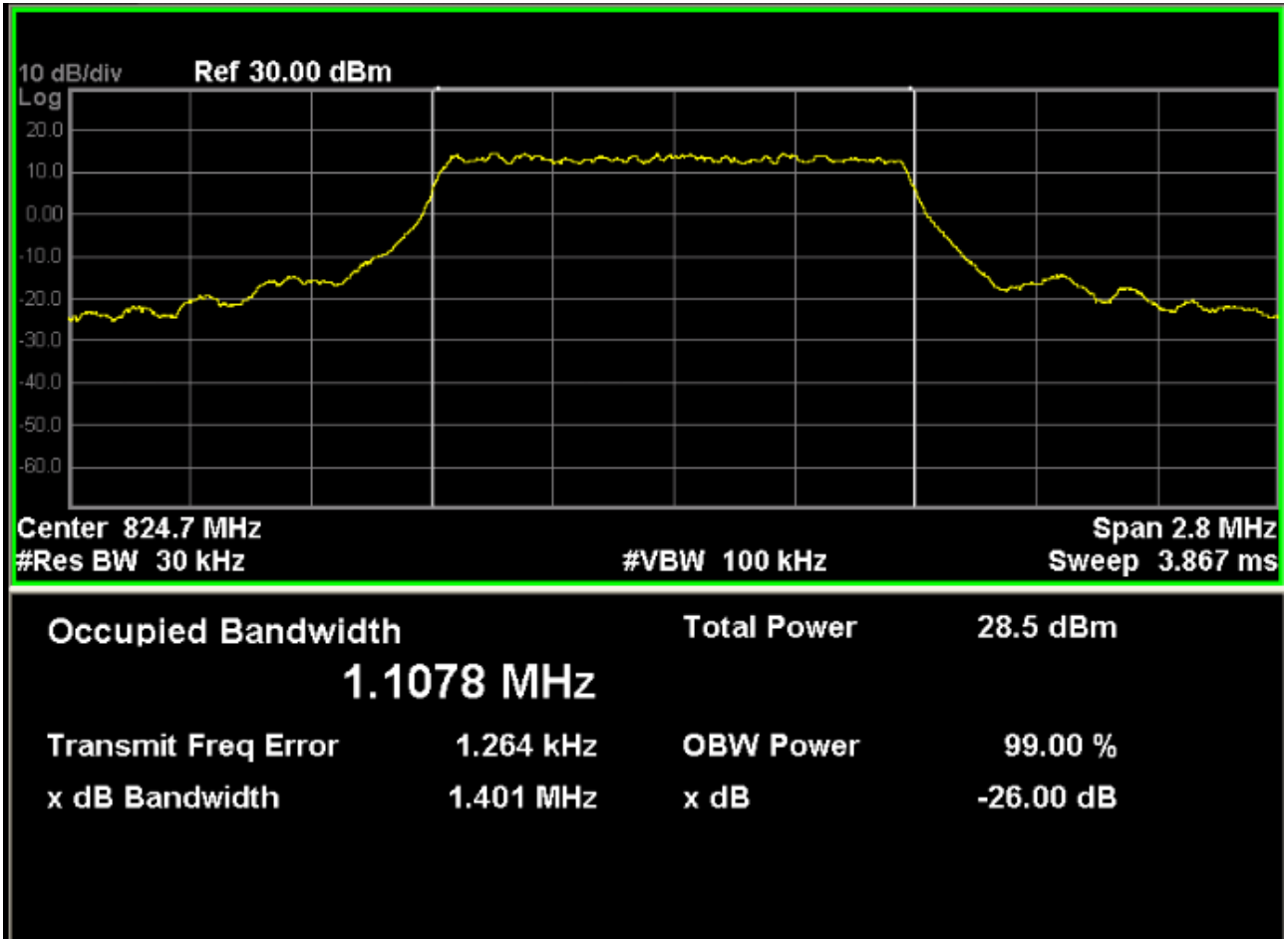

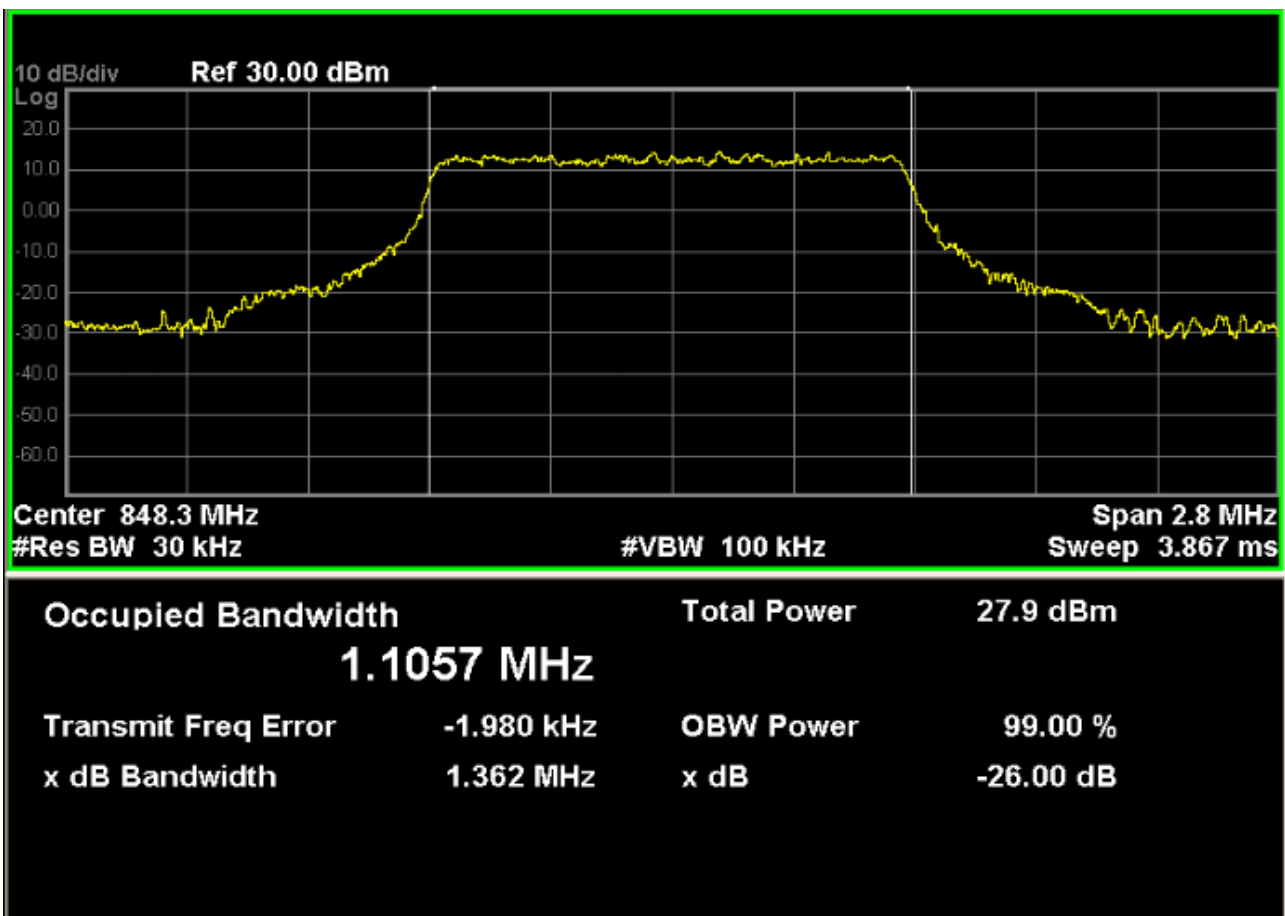
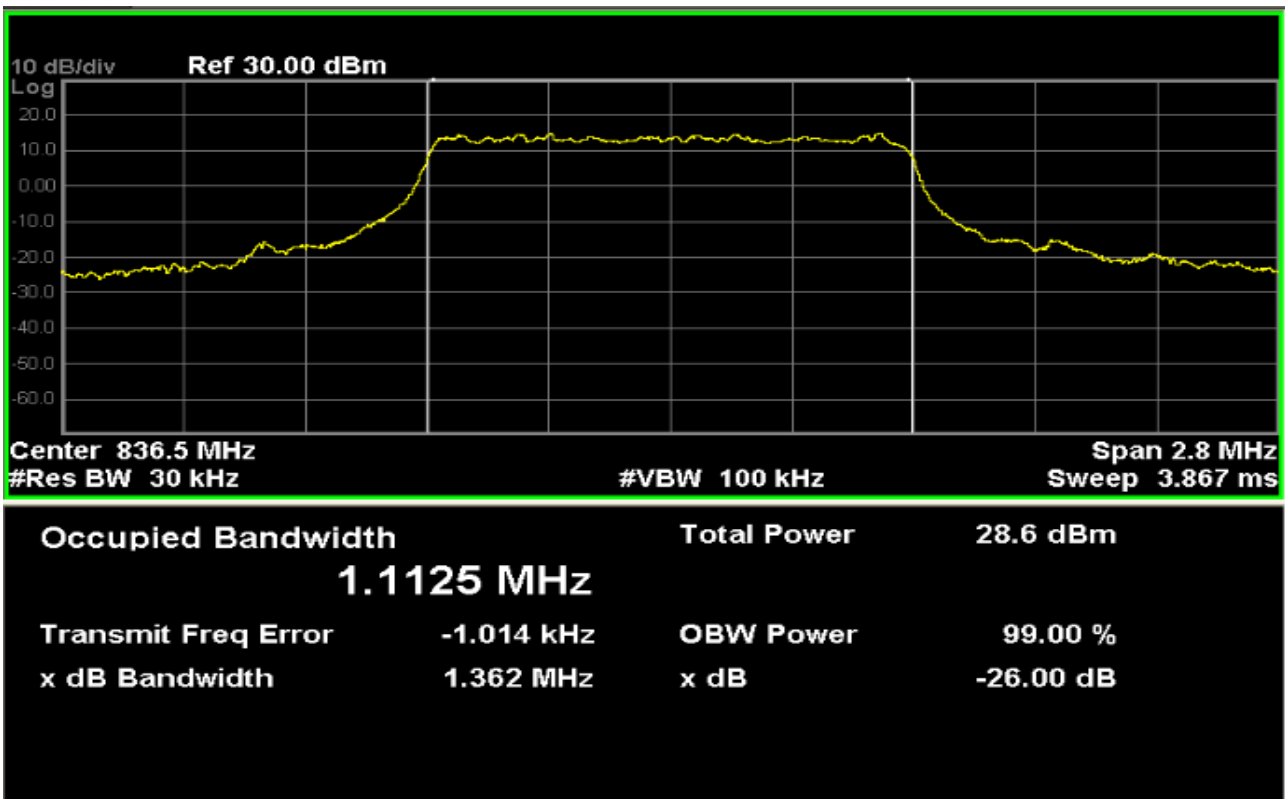

LTE Band 5 (16-QAM, Band Width 1.4MHz, RB Size 6, RB Offset 0)

Channel No.	Frequency (MHz)	-26dB Occupied Bandwidth (MHz)	99% Occupied Bandwidth (MHz)
20407	824.7	1.366	1.1027
20525	836.5	1.353	1.1049
20643	848.3	1.390	1.1161

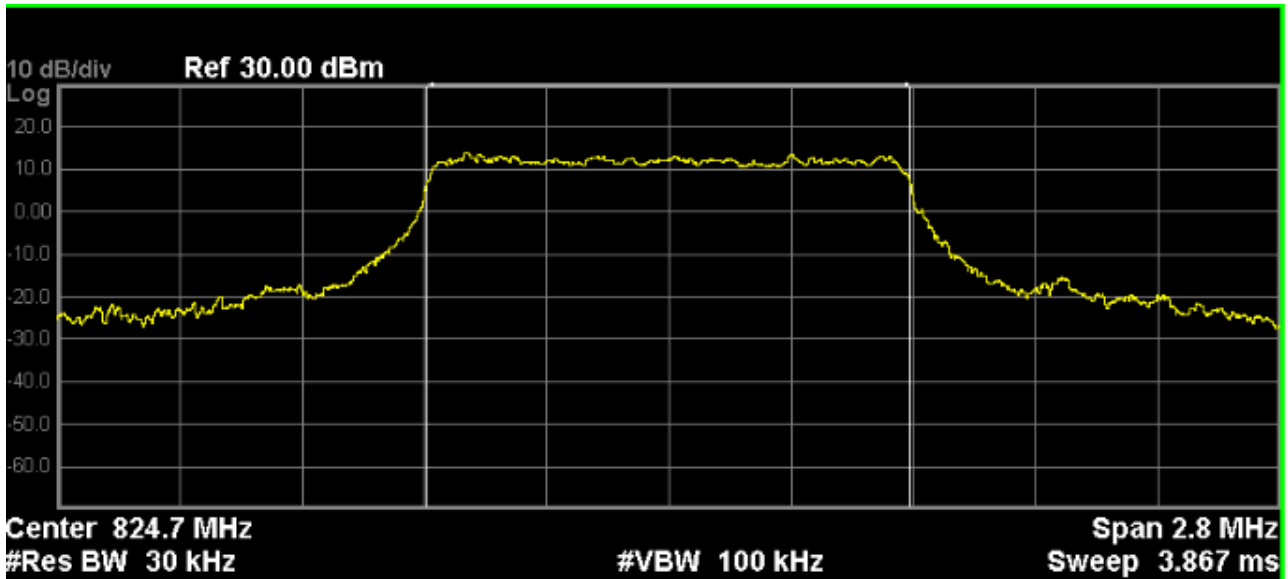

Occupied Bandwidth	1.1027 MHz	Total Power	27.3 dBm
Transmit Freq Error	700 Hz	OBW Power	99.00 %
x dB Bandwidth	1.366 MHz	x dB	-26.00 dB

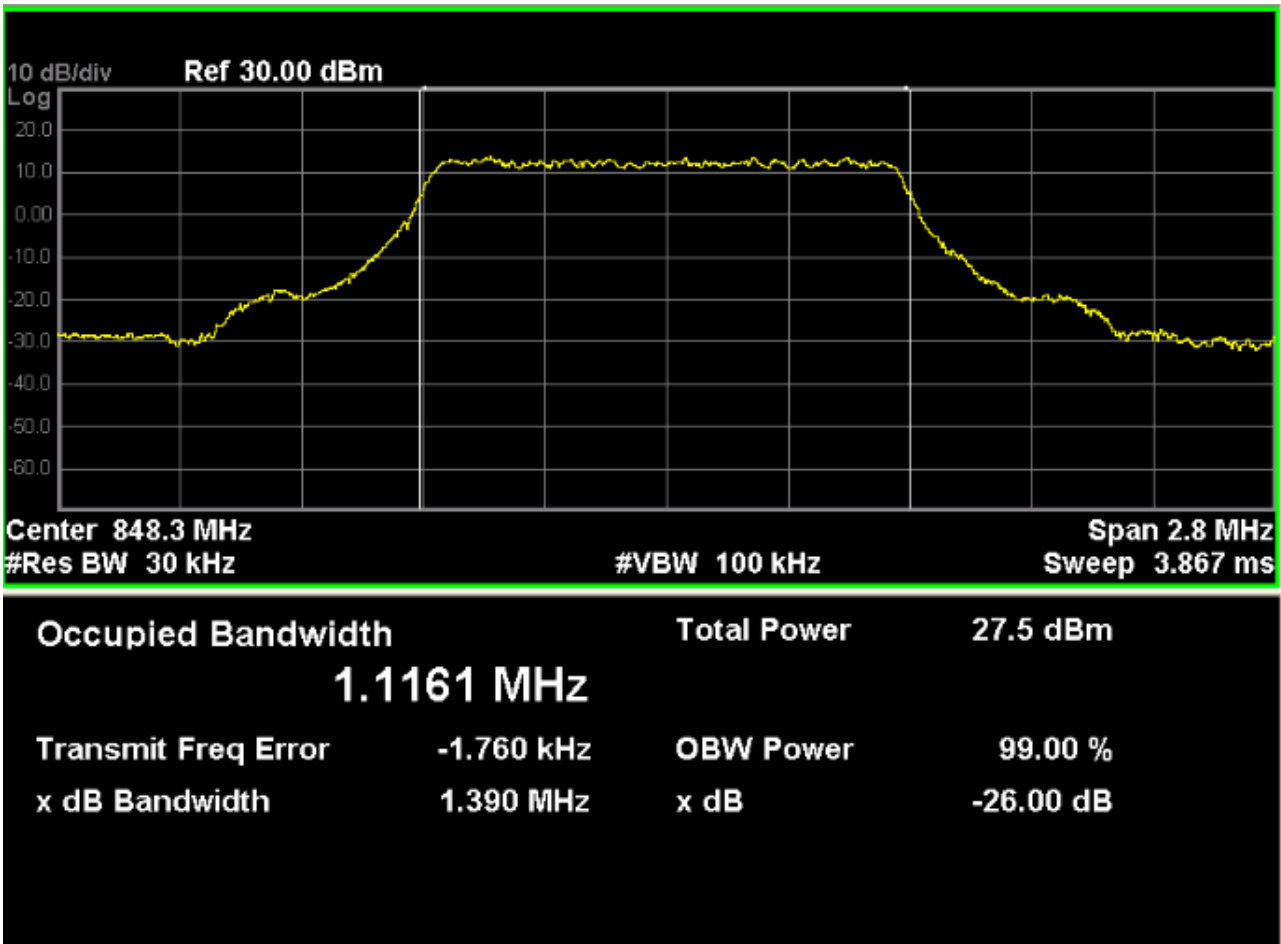
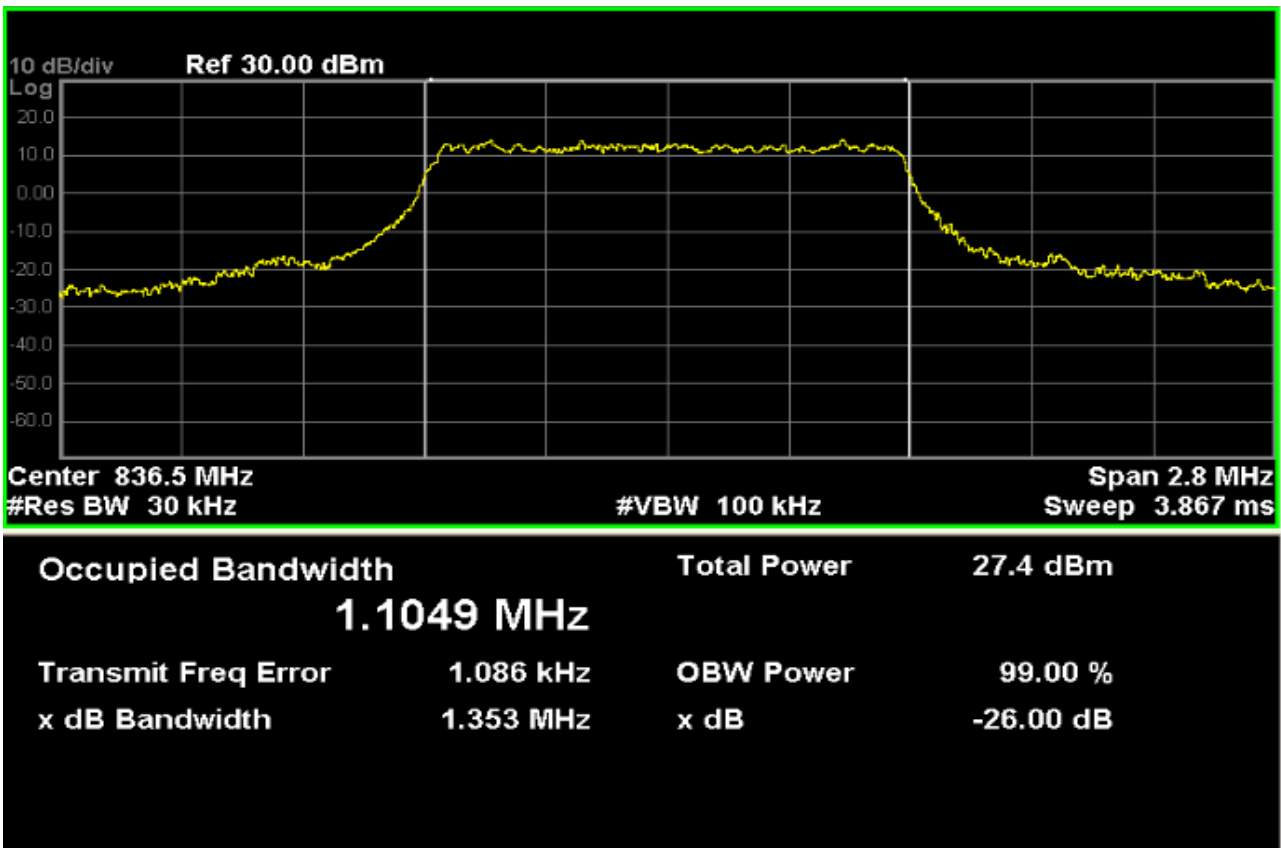

LTE Band 5 (QPSK, Band Width 3MHz,RB Size 15,RB Offset 0)

Channel No.	Frequency (MHz)	-26dB Occupied Bandwidth (MHz)	99% Occupied Bandwidth (MHz)
20415	825.5	3.111	2.7568
20525	836.5	3.118	2.7502
20635	847.5	3.126	2.7508

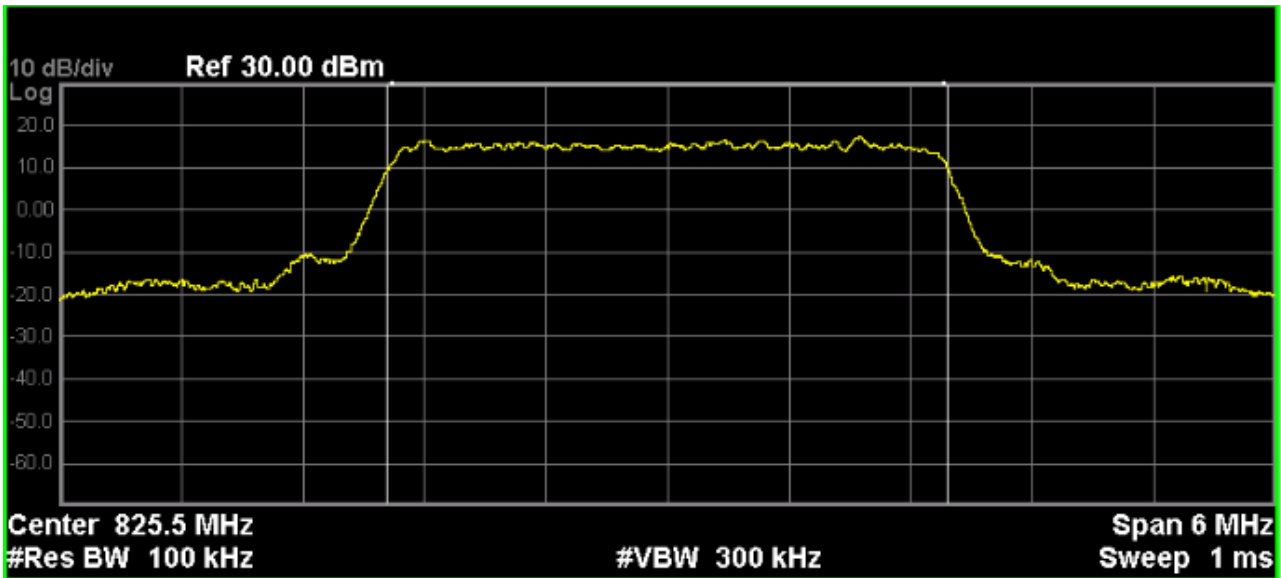

Occupied Bandwidth		Total Power	29.2 dBm
	2.7568 MHz		
Transmit Freq Error	145 Hz	OBW Power	99.00 %
x dB Bandwidth	3.111 MHz	x dB	-26.00 dB

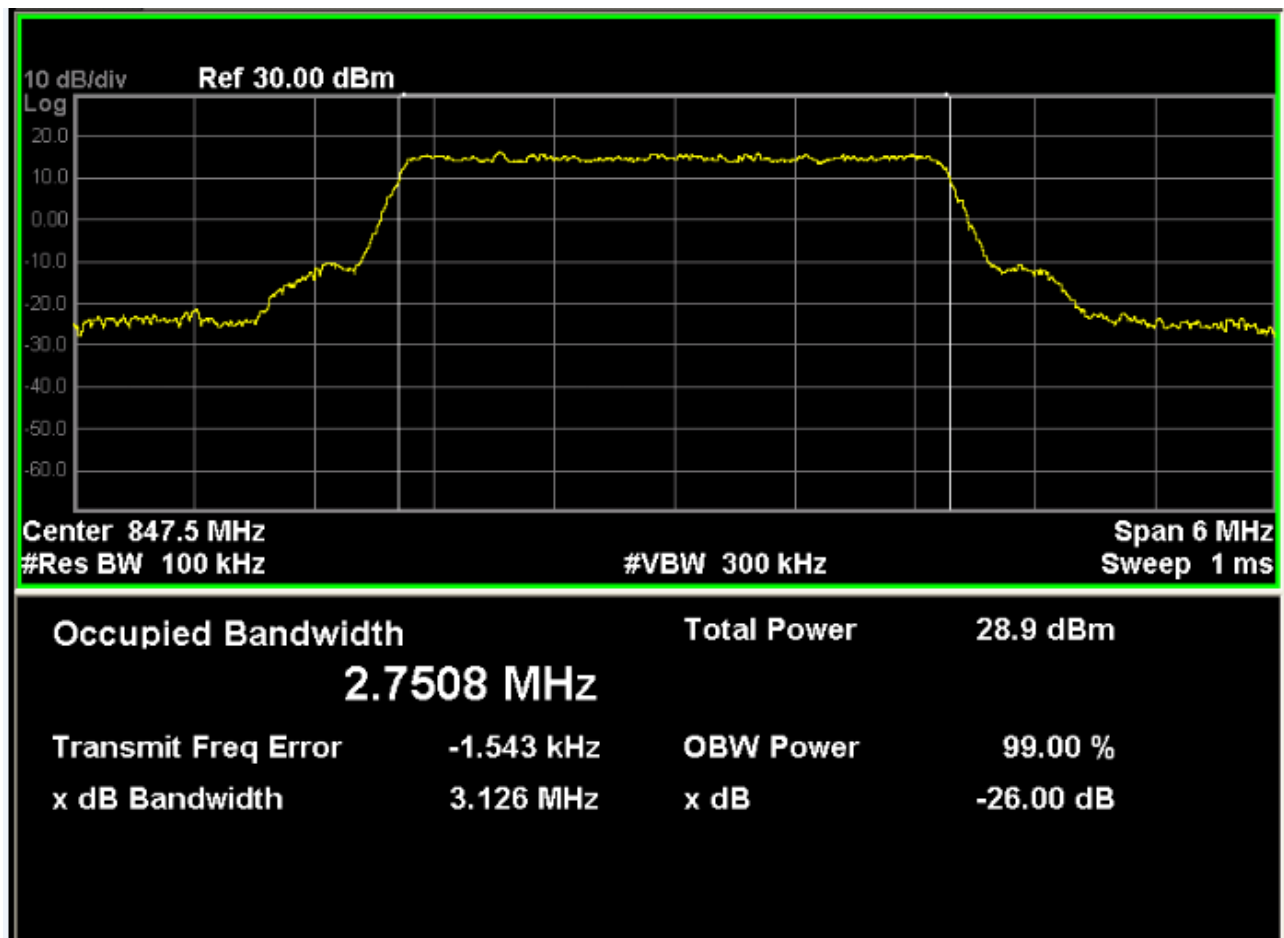
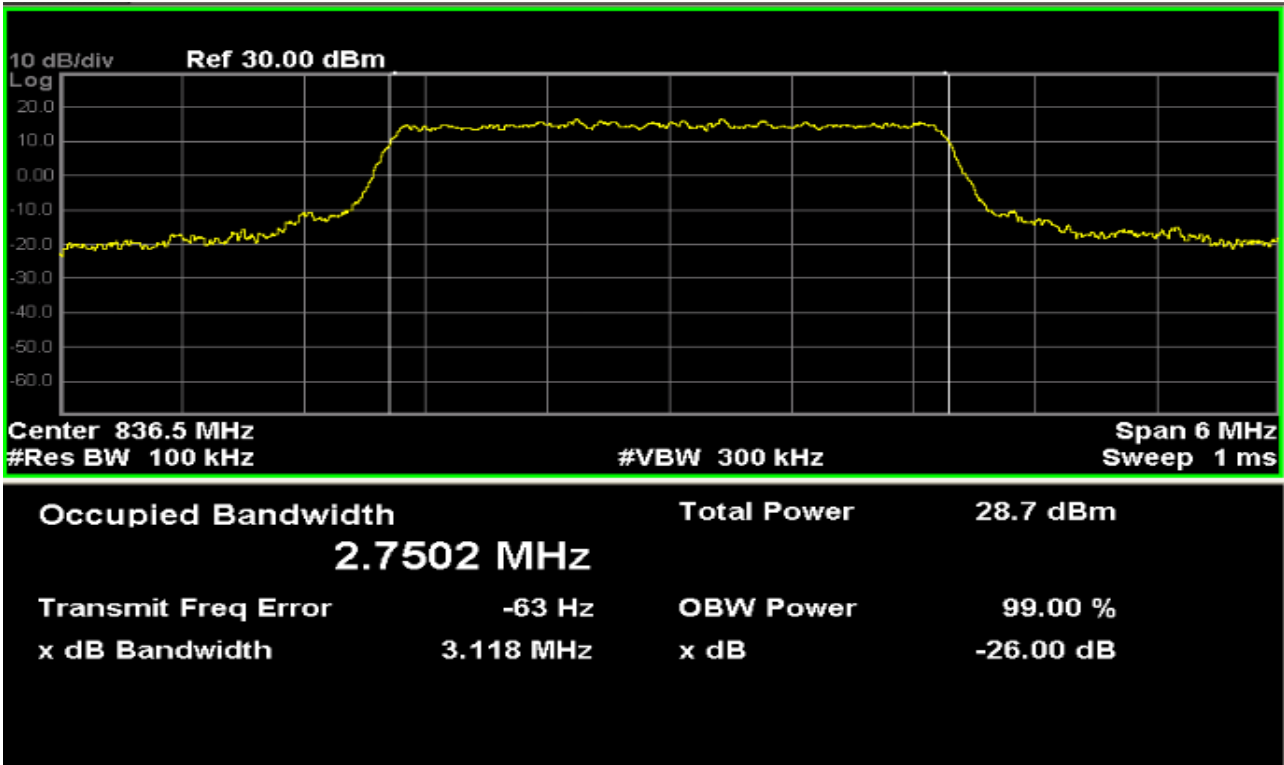

LTE Band 5 (16-QAM, Band Width 3MHz,RB Size 15,RB Offset 0)

Channel No.	Frequency (MHz)	-26dB Occupied Bandwidth (MHz)	99% Occupied Bandwidth (MHz)
20415	825.5	3.163	2.7435
20525	836.5	3.157	2.7576
20635	847.5	3.141	2.7689

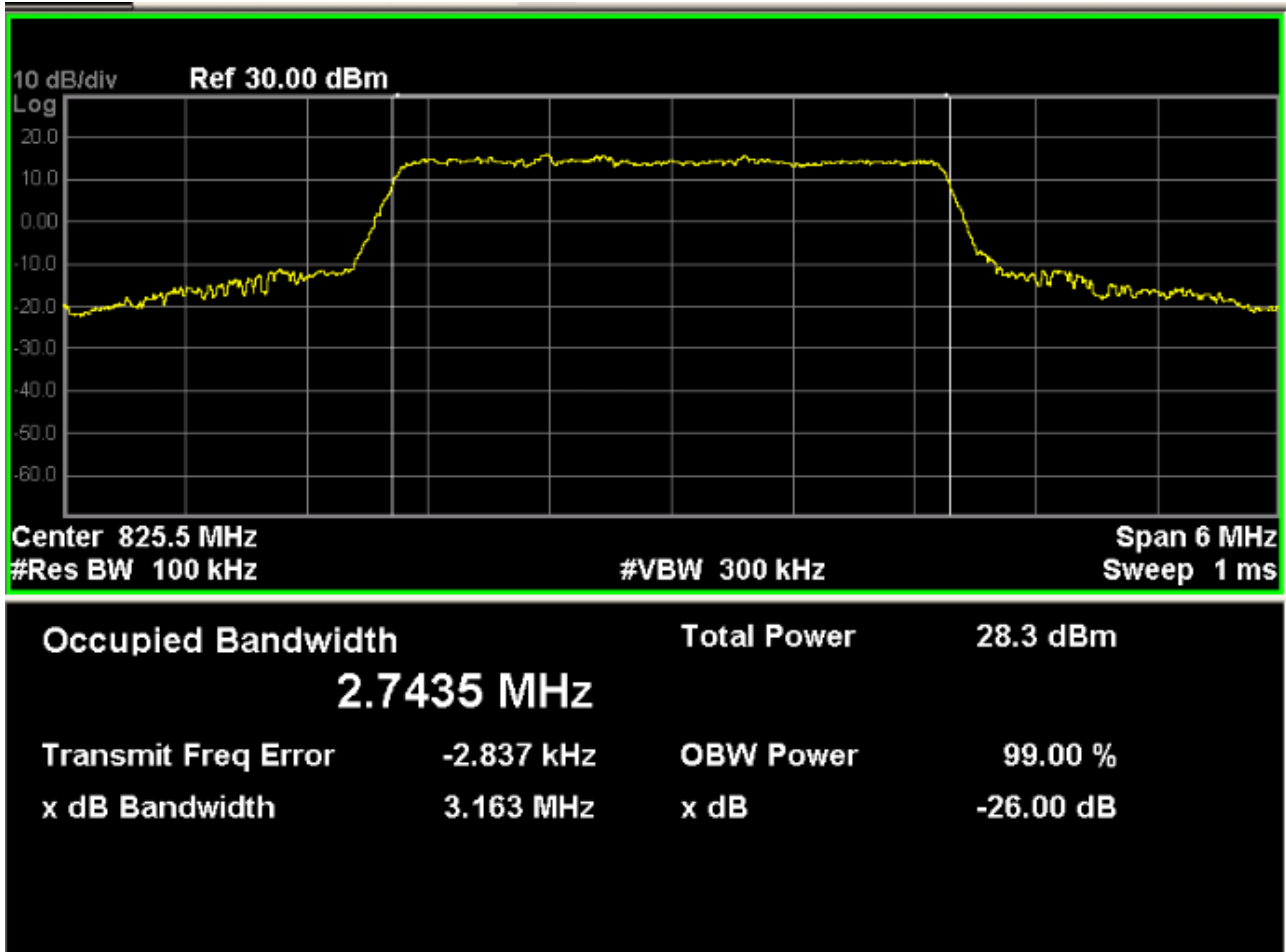

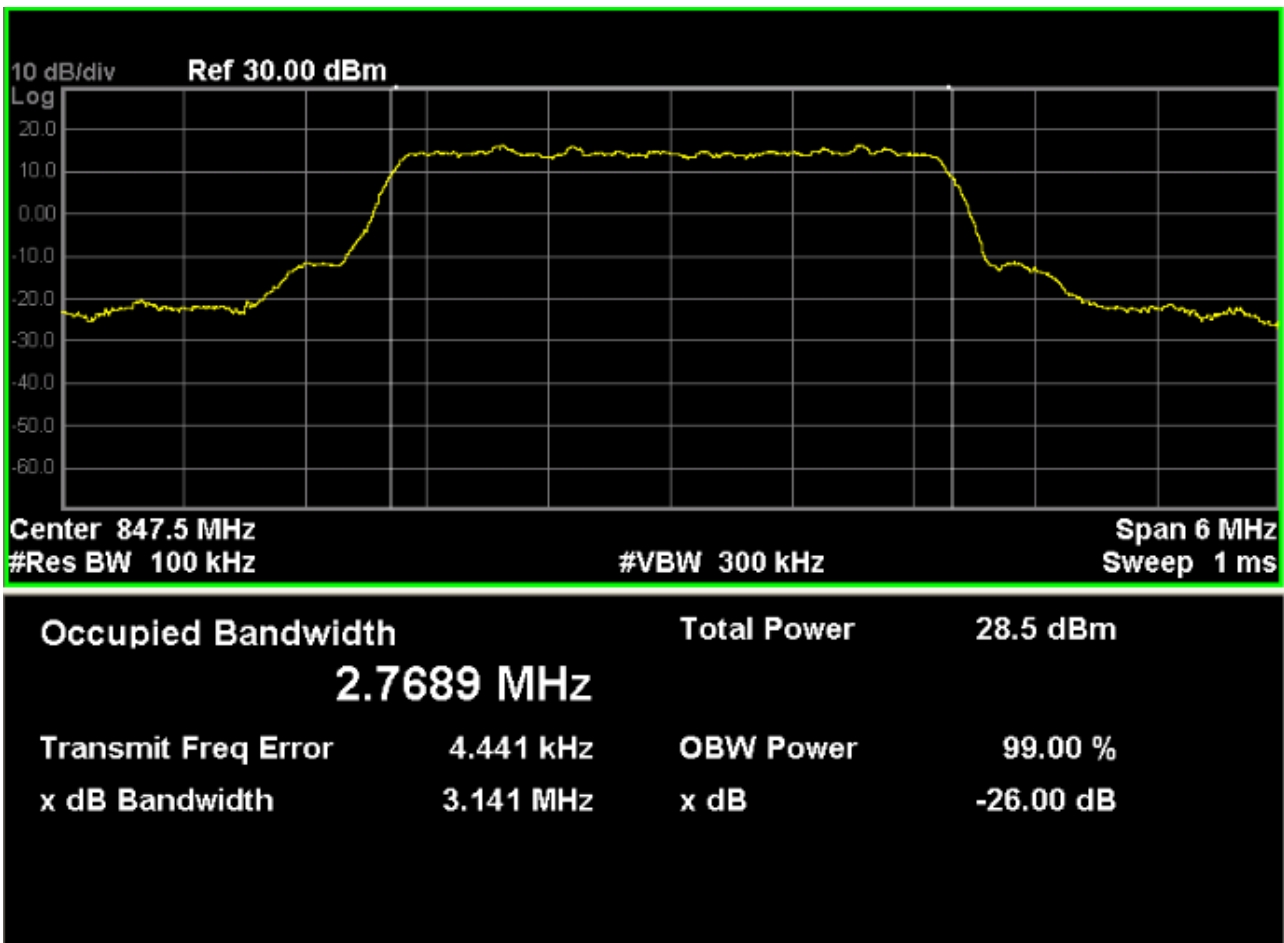
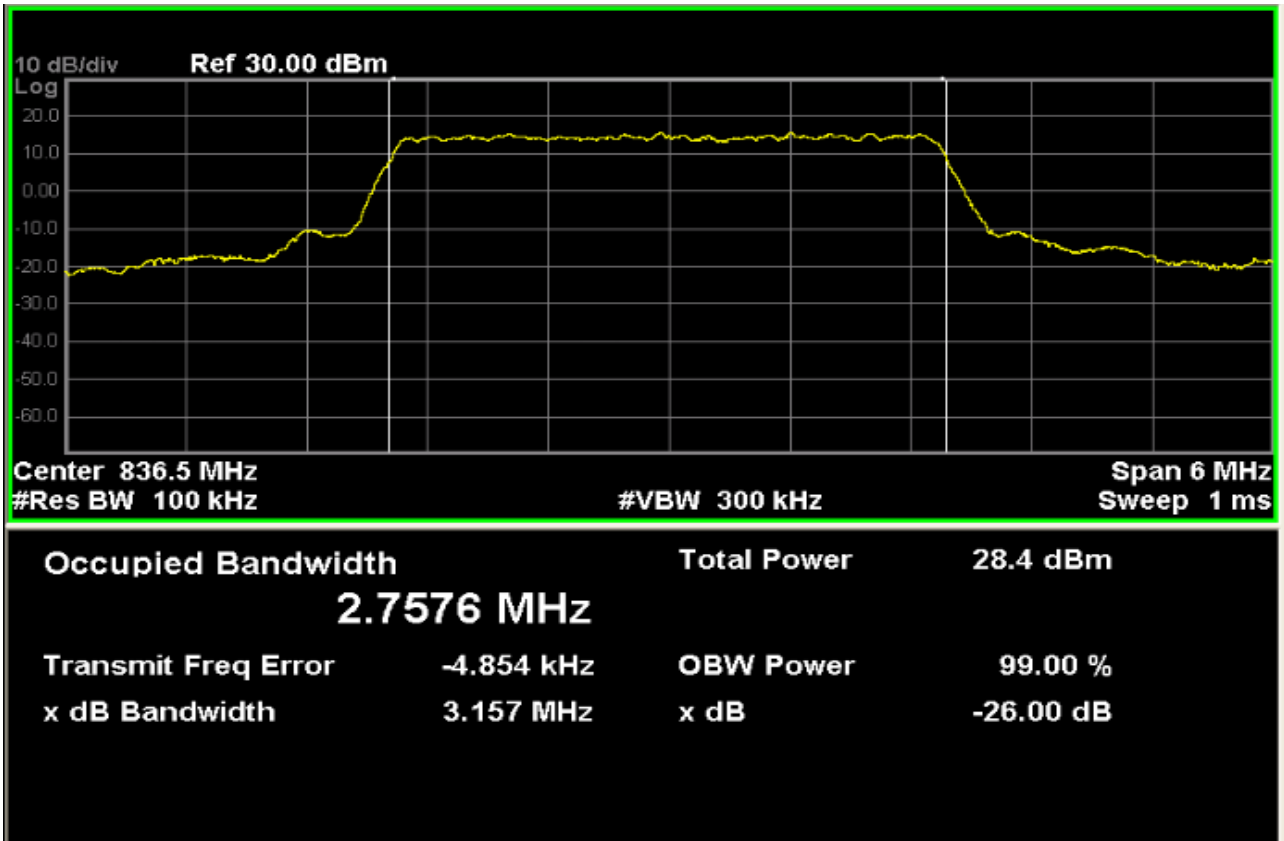

LTE Band 5 (QPSK, Band Width 5MHz,RB Size 25,RB Offset 0)

Channel No.	Frequency (MHz)	-26dB Occupied Bandwidth (MHz)	99% Occupied Bandwidth (MHz)
20425	826.5	5.123	4.5196
20525	836.5	5.121	4.5113
20625	846.5	5.073	4.5156

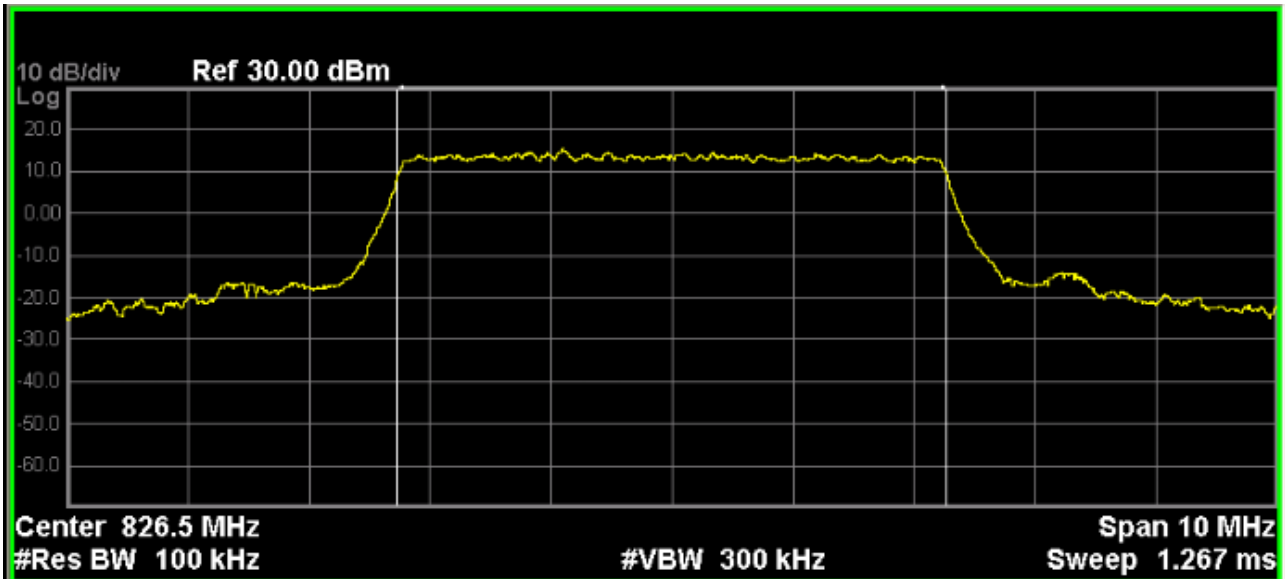

Occupied Bandwidth	Total Power	29.6 dBm
4.5196 MHz		
Transmit Freq Error	OBW Power	99.00 %
6.075 kHz	x dB	-26.00 dB
x dB Bandwidth		
5.123 MHz		

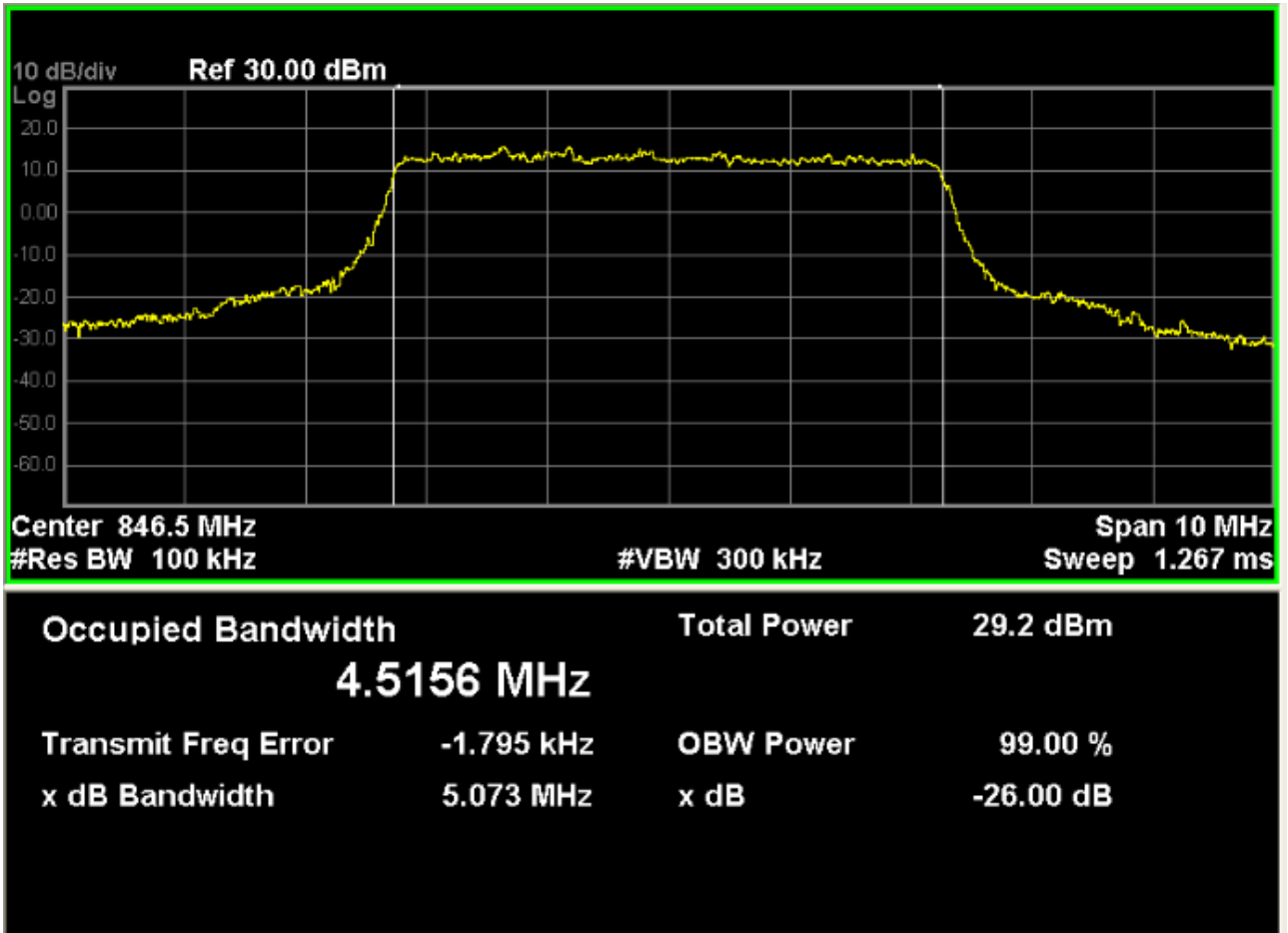
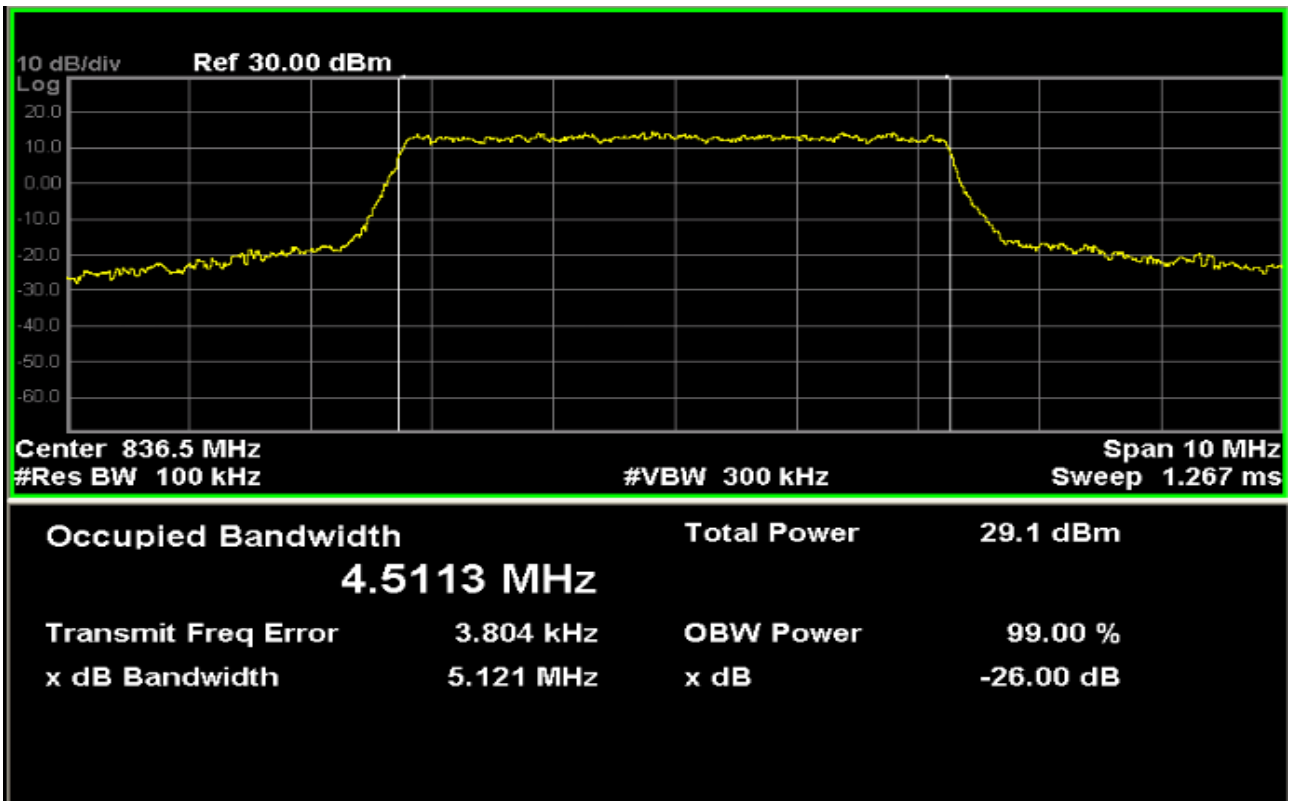

LTE Band 5 (16-QAM, Band Width 5MHz, RB Size 25, RB Offset 0)

Channel No.	Frequency (MHz)	-26dB Occupied Bandwidth (MHz)	99% Occupied Bandwidth (MHz)
20425	826.5	5.131	4.5105
20525	836.5	5.123	4.5214
20625	846.5	5.119	4.5053

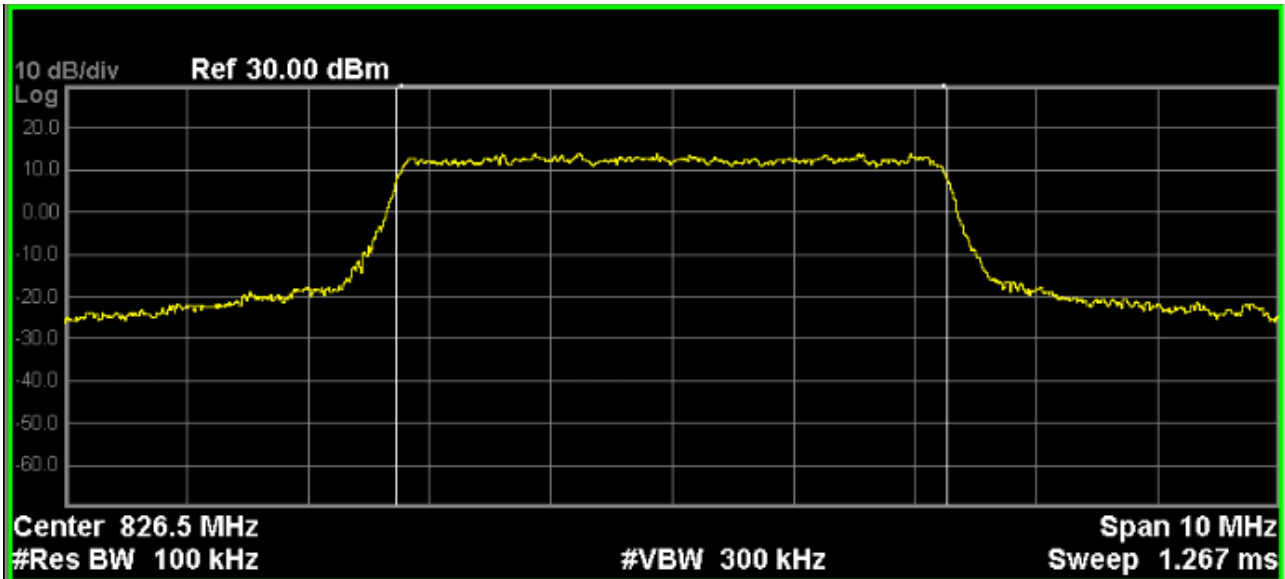

Occupied Bandwidth	Total Power	28.6 dBm
4.5105 MHz		
Transmit Freq Error	OBW Power	99.00 %
3.948 kHz	x dB	-26.00 dB
x dB Bandwidth		
5.131 MHz		

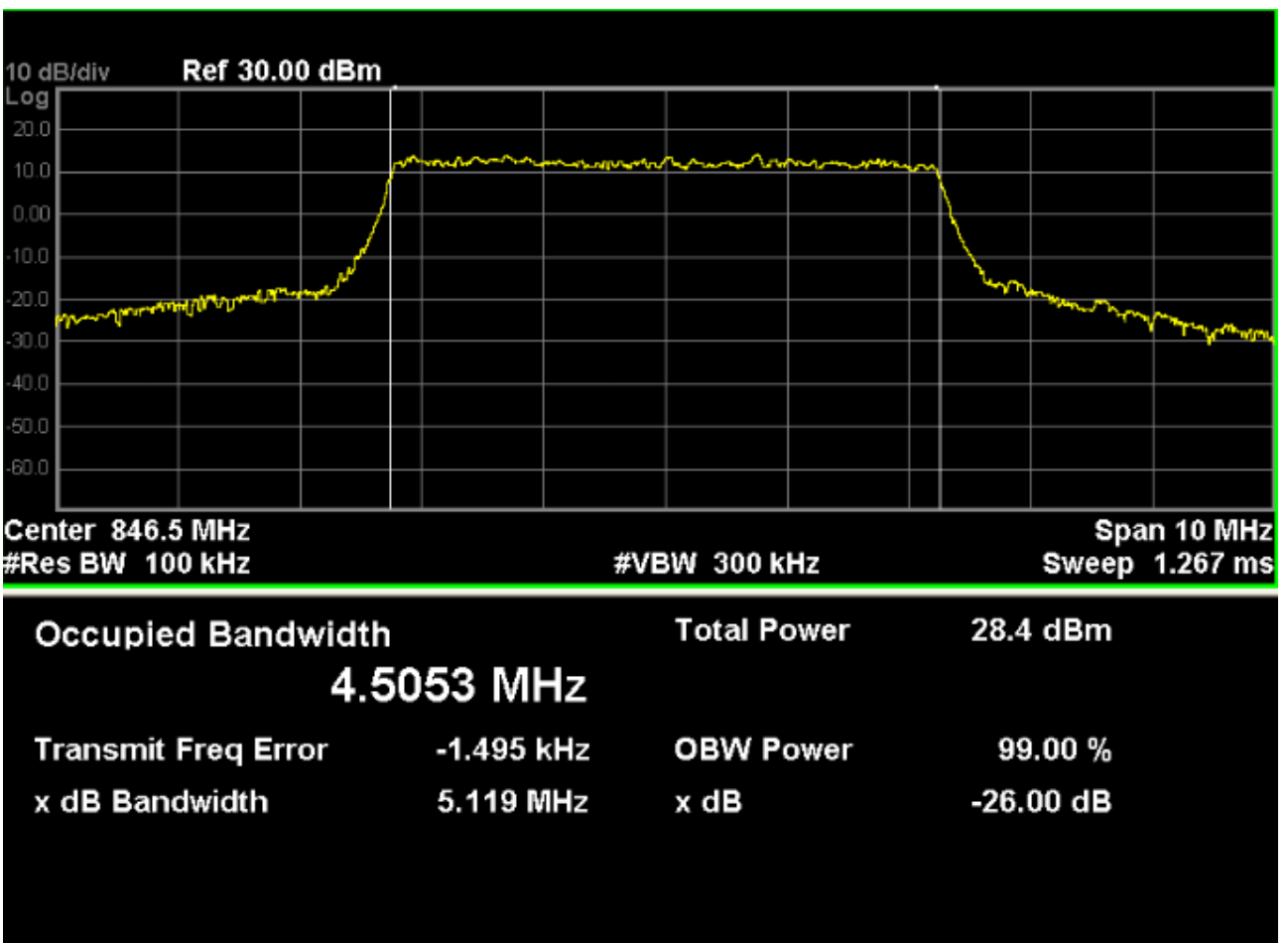
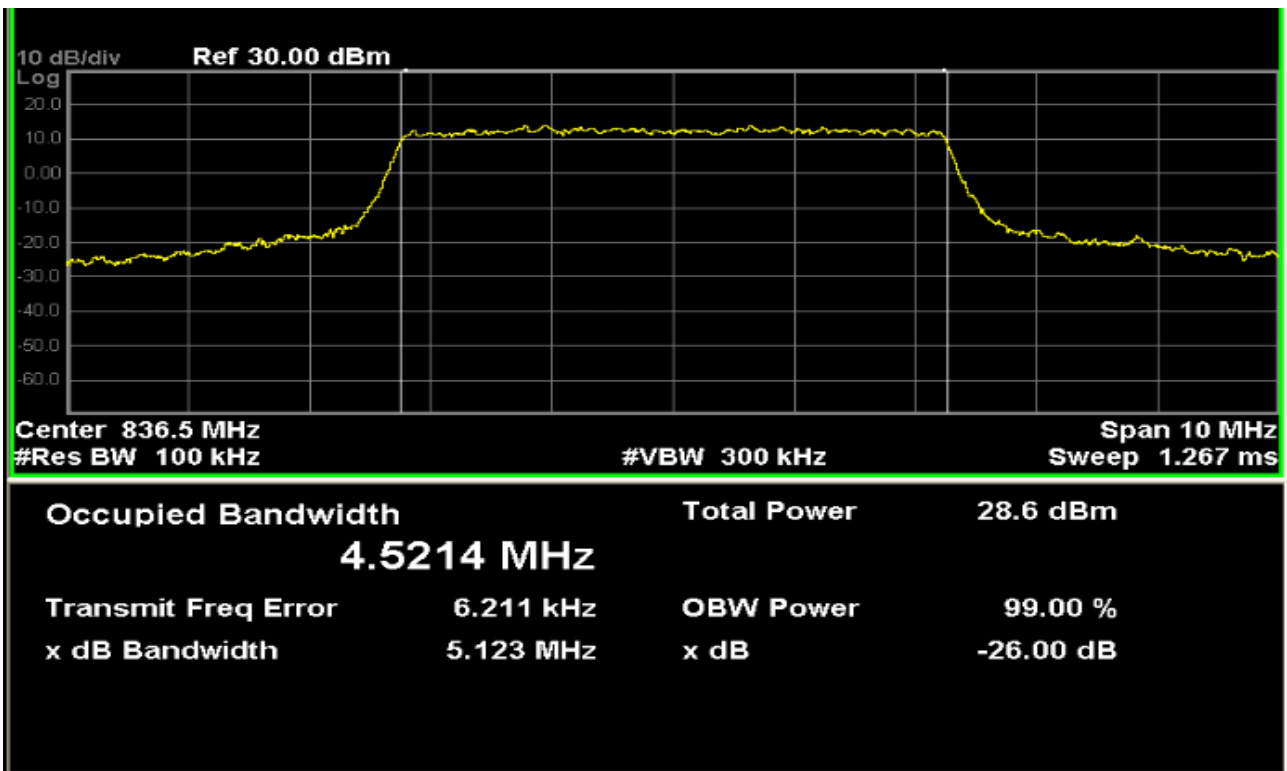

LTE Band 5 (QPSK, Band Width 10MHz,RB Size 50,RB Offset 0)

Channel No.	Frequency (MHz)	-26dB Occupied Bandwidth (MHz)	99% Occupied Bandwidth (MHz)
20450	829.0	10.56	9.0849
20525	836.5	10.54	9.1050
20600	844.0	10.52	9.0940

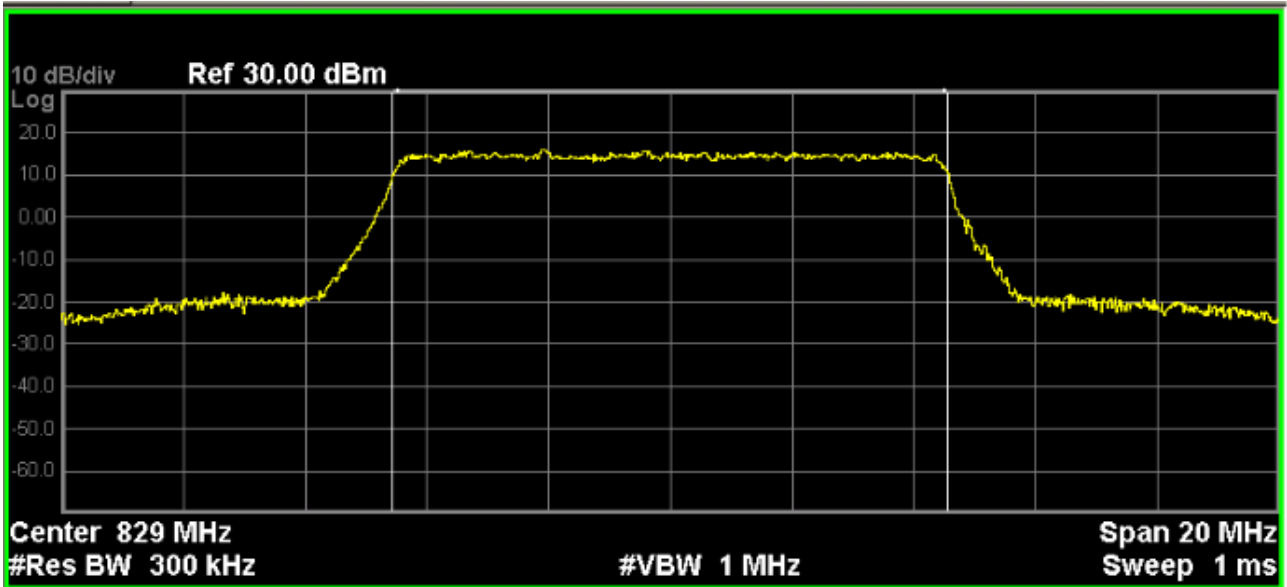

Occupied Bandwidth		Total Power	29.0 dBm
	9.0849 MHz		
Transmit Freq Error	-2.476 kHz	OBW Power	99.00 %
x dB Bandwidth	10.56 MHz	x dB	-26.00 dB

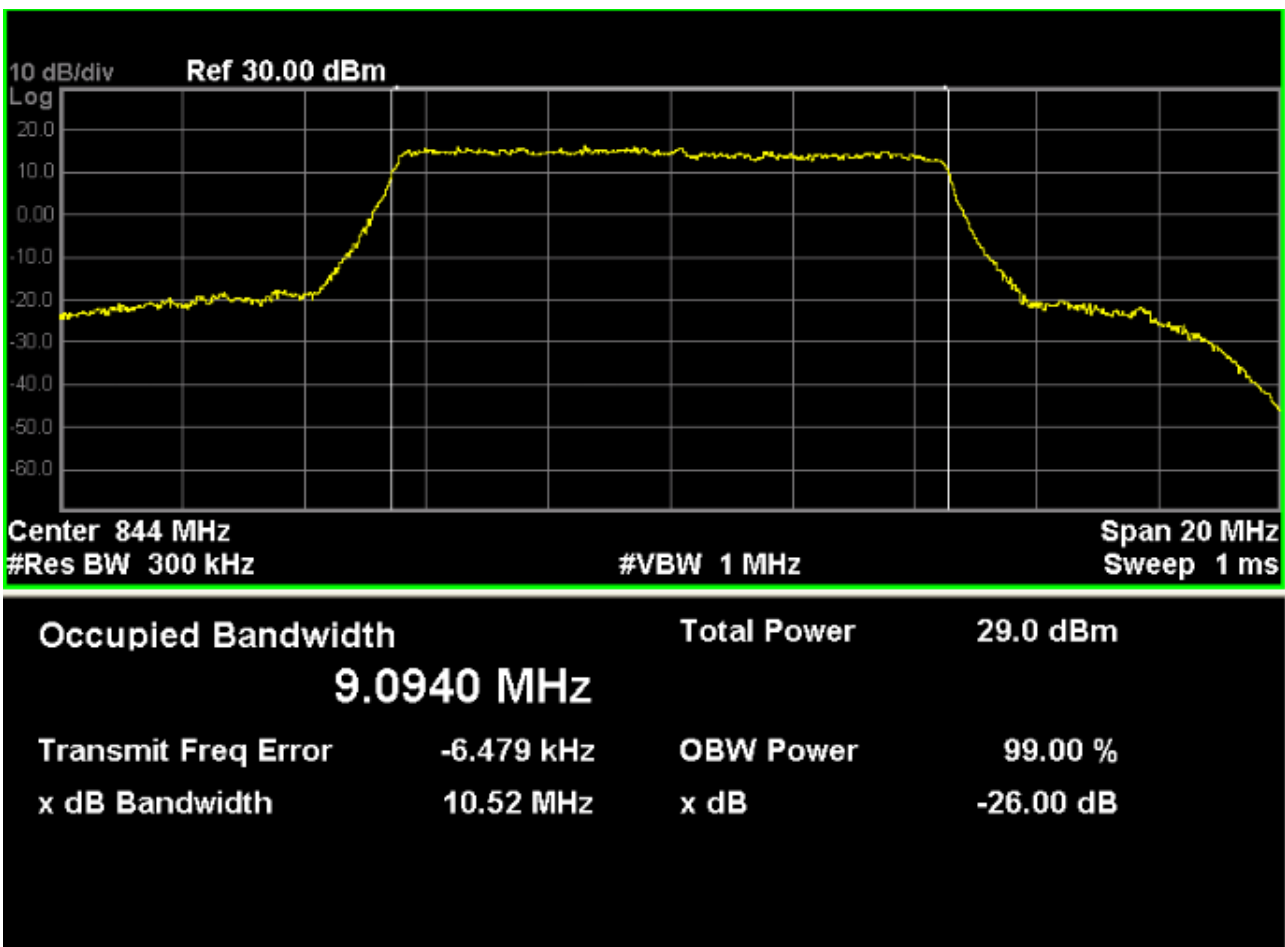
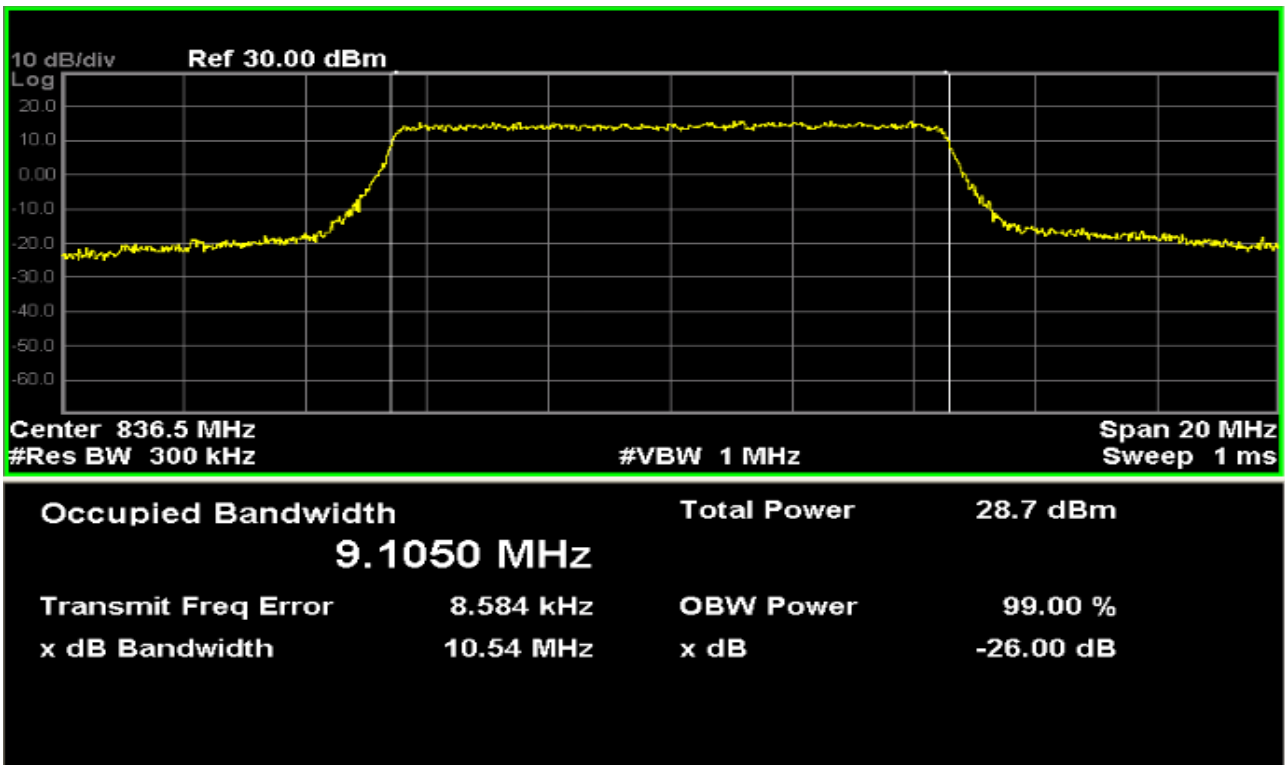

LTE Band 5 (16-QAM, Band Width 10MHz, RB Size 50, RB Offset 0)

Channel No.	Frequency (MHz)	-26dB Occupied Bandwidth (MHz)	99% Occupied Bandwidth (MHz)
20450	829.0	10.47	9.0919
20525	836.5	10.61	9.0997
20600	844.0	10.26	9.0642

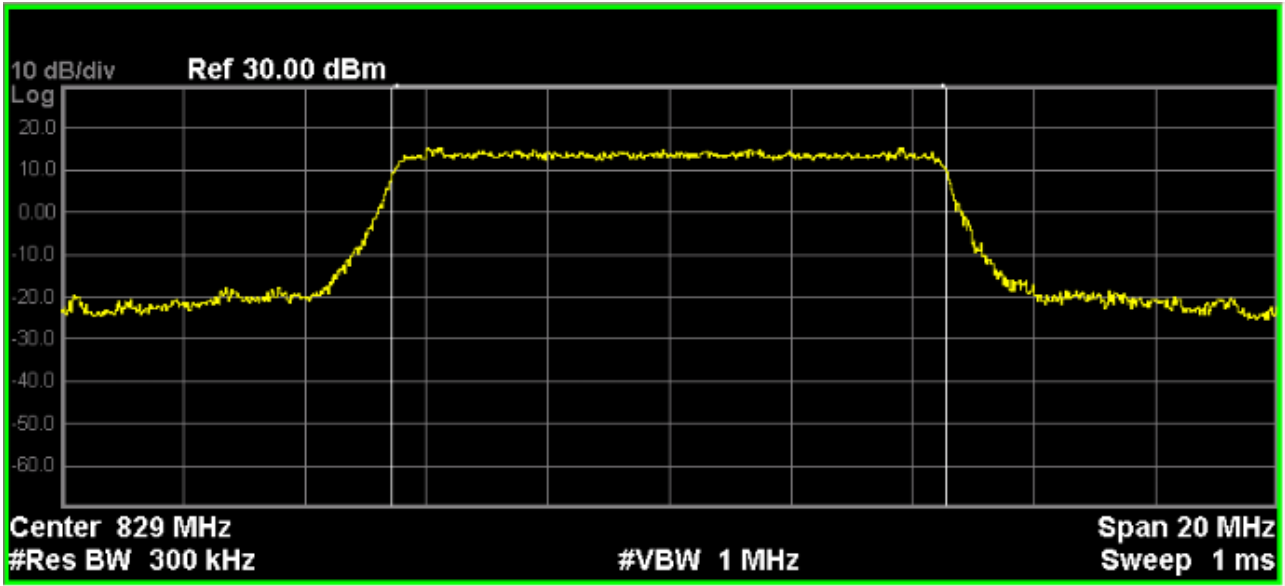

Occupied Bandwidth	Total Power		28.1 dBm
9.0919 MHz			
Transmit Freq Error	6.972 kHz	OBW Power	99.00 %
x dB Bandwidth	10.47 MHz	x dB	-26.00 dB

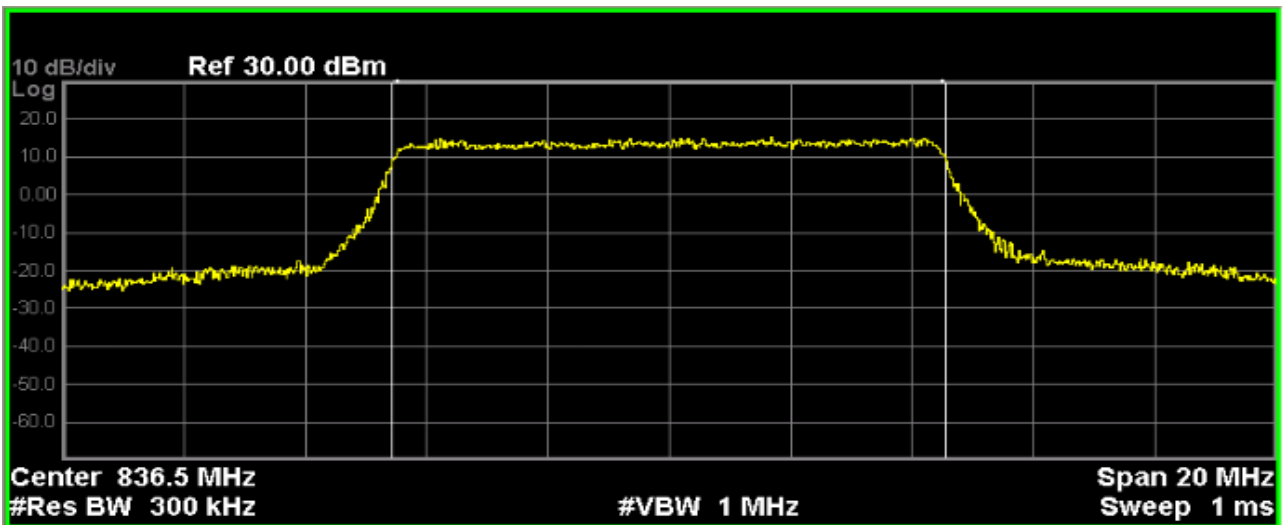

Occupied Bandwidth	Total Power	27.9 dBm	
9.0997 MHz			
Transmit Freq Error	6.949 kHz	OBW Power	99.00 %
x dB Bandwidth	10.61 MHz	x dB	-26.00 dB

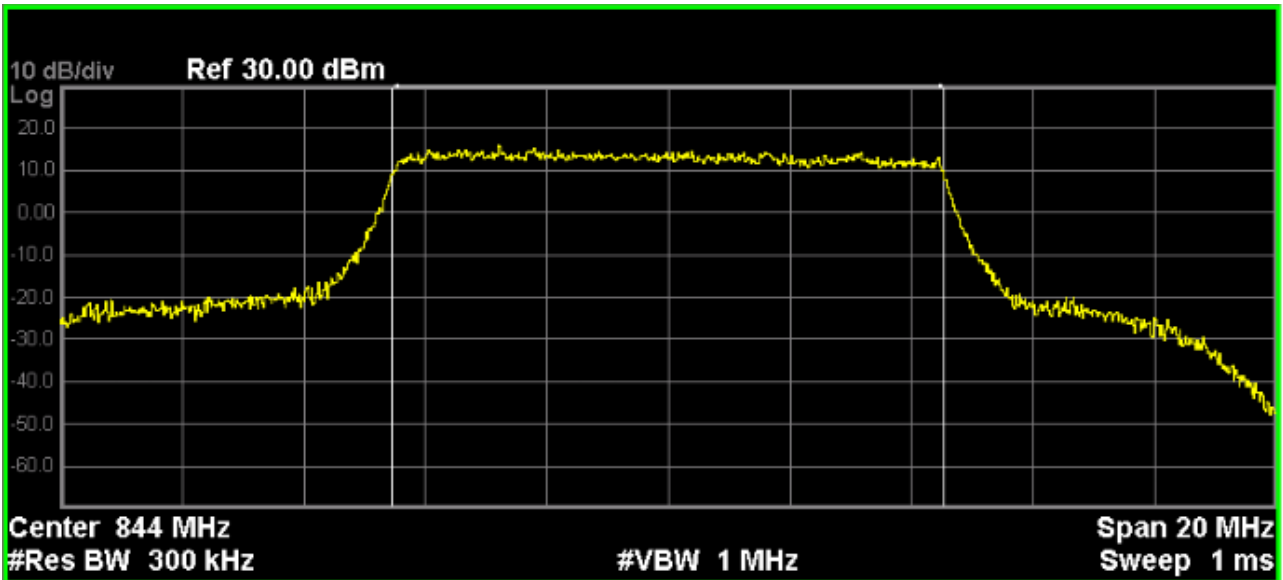

Occupied Bandwidth	Total Power	27.6 dBm	
9.0642 MHz			
Transmit Freq Error	-9.406 kHz	OBW Power	99.00 %
x dB Bandwidth	10.26 MHz	x dB	-26.00 dB

5. Spurious Emission At Antenna Terminals (+/- 1MHz)

5.1. Test Equipment

Instrument	Manufacturer	Model	Serial No	Cal. Date
Radio Communication Tester	R&S	CMW500	147483	11/08/2016
Spectrum Analyzer	Agilent	N9038A	MY51210142	11/05/2016
DC Power Supply	Agilent	6612C	MY43002989	03/01/2017

The measure equipment had been calibrated once a year.

5.2. Test Setup

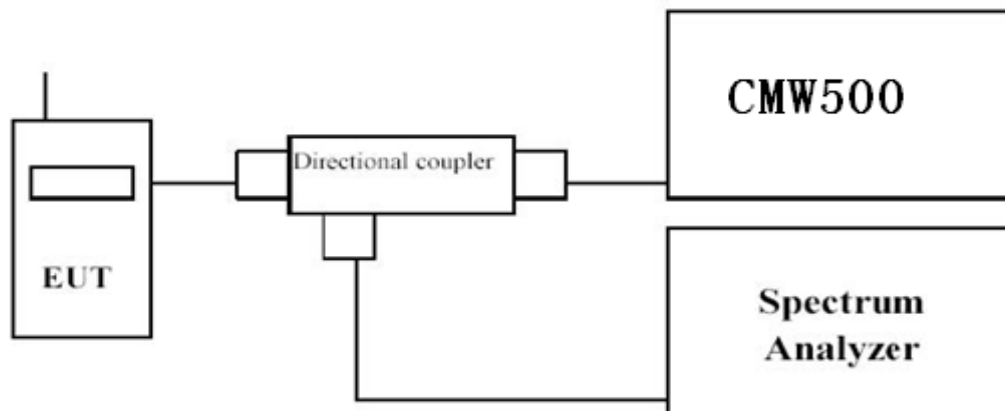

5.3. Limit

The power of any emission outside of the authorized operating frequency ranges must be attenuated below the transmitting power (P) by a factor of at least $43 + 10\log(P)$ dB.

5.4. Test Procedure

In the 1MHz bands immediately outside and adjacent to the frequency block a resolution bandwidth of at least one percent of the emission bandwidth of the fundamental emission of the transmitter may be employed to measure the out of band Emissions.

Procedure:

1. The testing follows FCC KDB 971168 v02v02 Section 6.0;
2. The EUT was connected to spectrum analyzer and the CMW500;
3. The band edges of low and high channels for the highest RF powers were measured. Set $RBW \geq 1\%OBW$ in the 1MHz band immediately outside and adjacent to the band edge.
4. Set spectrum analyzer with RMS detector.

5.5. Uncertainty

The measurement uncertainty is defined as ± 1.2 dB.

5.6. Test Result

LTE Band 5 (QPSK, Band Width 1.4MHz, RB Size 1, RB Offset 0, Channel 20407, Frequency 824.7MHz)

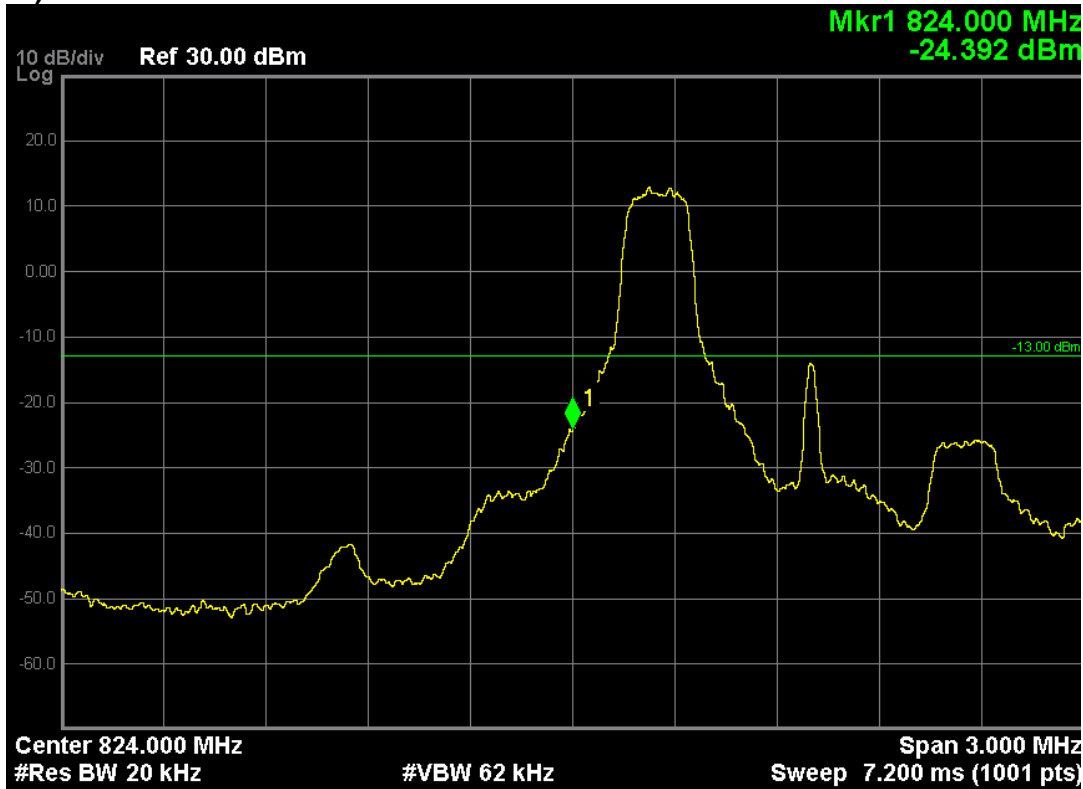

LTE Band 5 (QPSK, Band Width 1.4MHz, RB Size 6, RB Offset 0, Channel 20407, Frequency 824.7MHz)

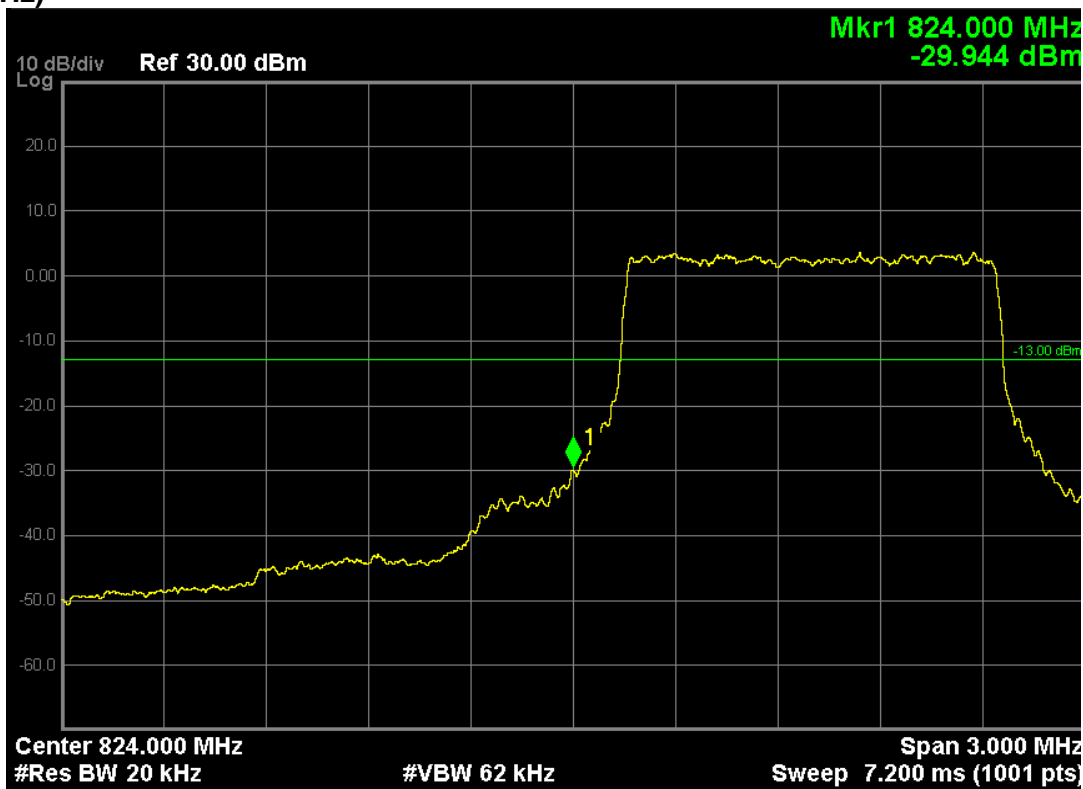

LTE Band 5 (QPSK, Band Width 1.4MHz, RB Size 1, RB Offset 5, Channel 20643, Frequency 848.3MHz)

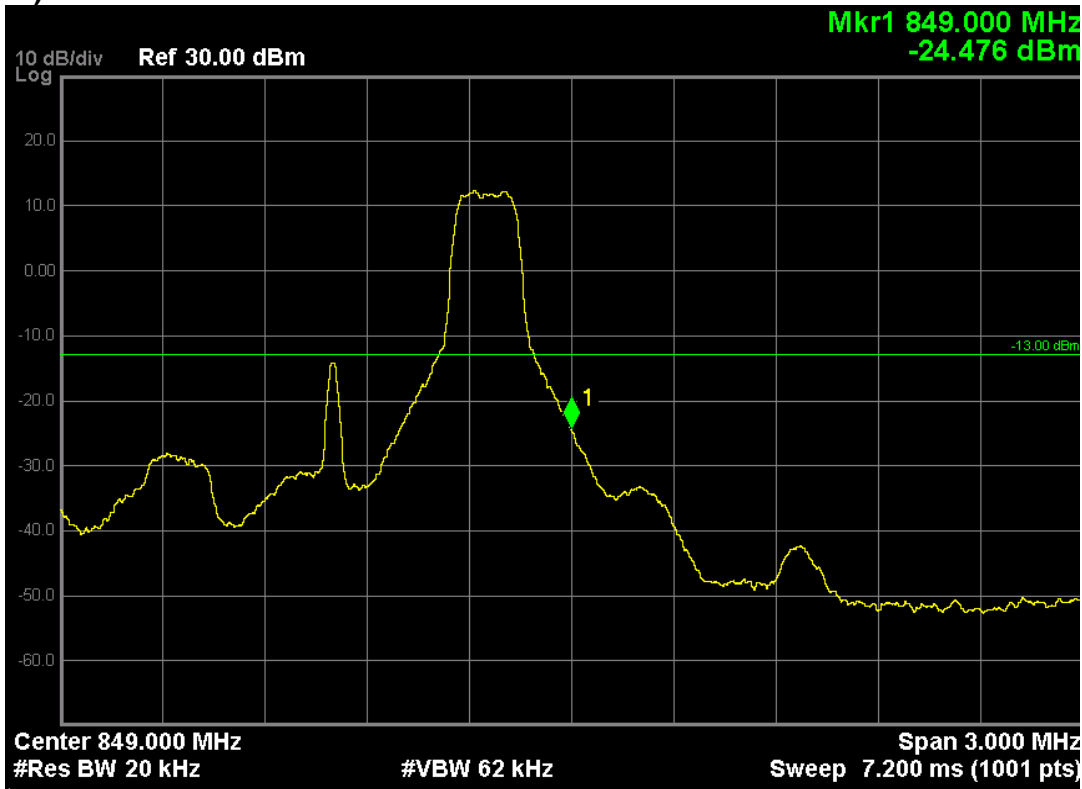

LTE Band 5 (QPSK, Band Width 1.4MHz, RB Size 6, RB Offset 0, Channel 20643, Frequency 848.3MHz)

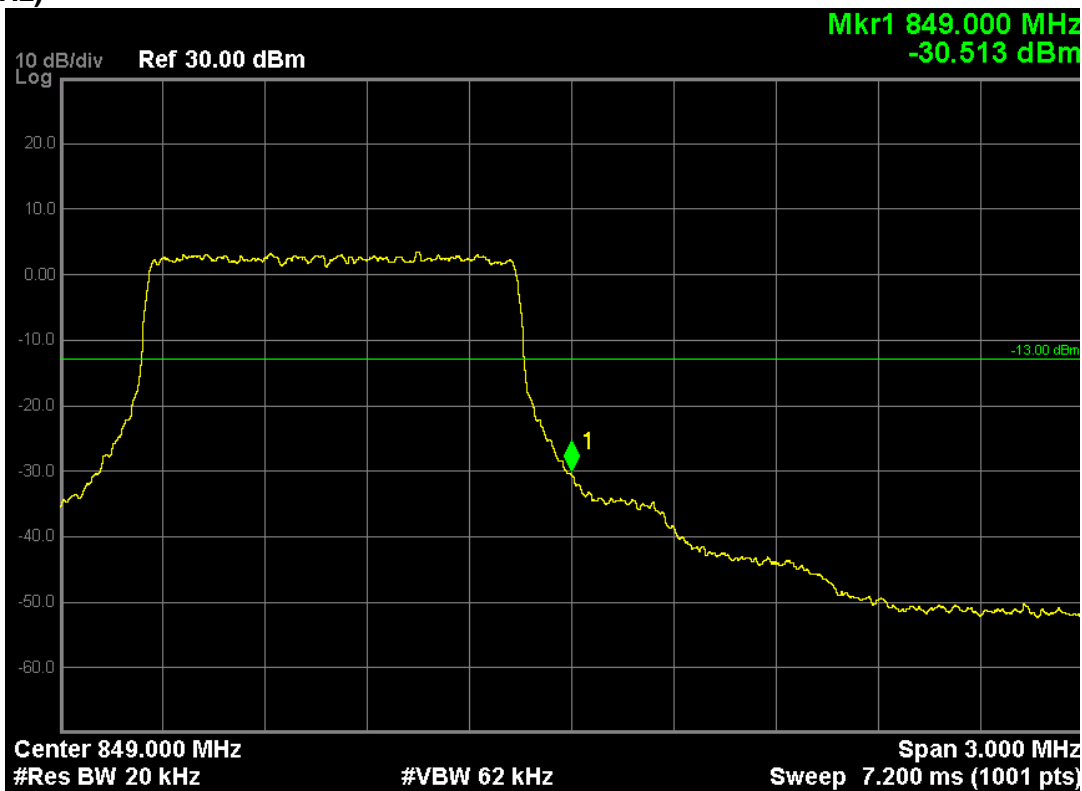

LTE Band 5 (16-QAM, Band Width 1.4MHz, RB Size 1, RB Offset 0, Channel 20407, Frequency 824.7MHz)

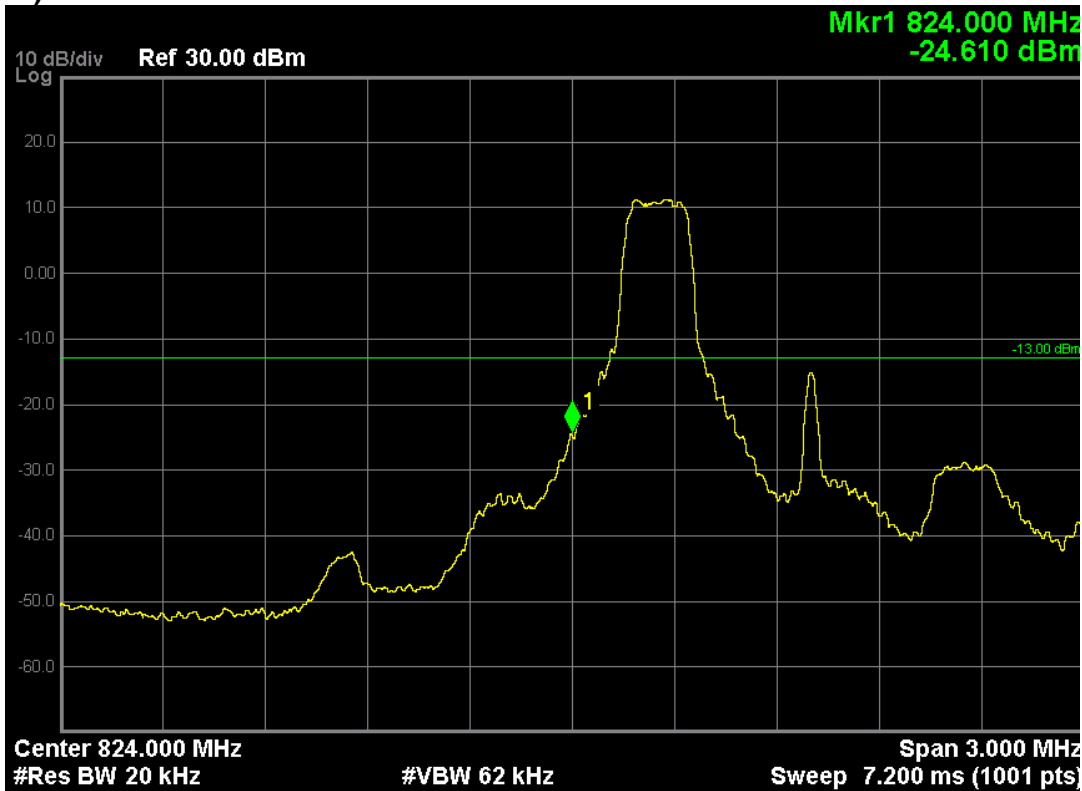

LTE Band 5 (16-QAM, Band Width 1.4MHz, RB Size 6, RB Offset 0, Channel 20407, Frequency 824.7MHz)

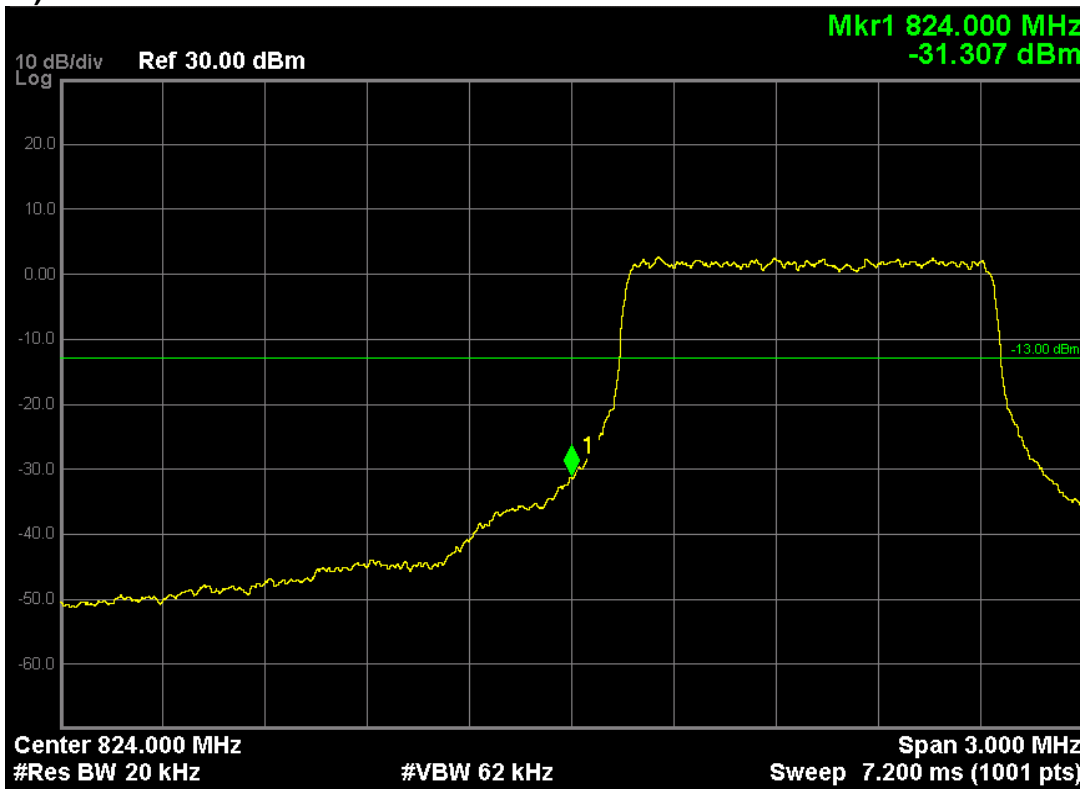

LTE Band 5 (16-QAM, Band Width 1.4MHz, RB Size 1, RB Offset 5, Channel 20643, Frequency 848.3MHz)

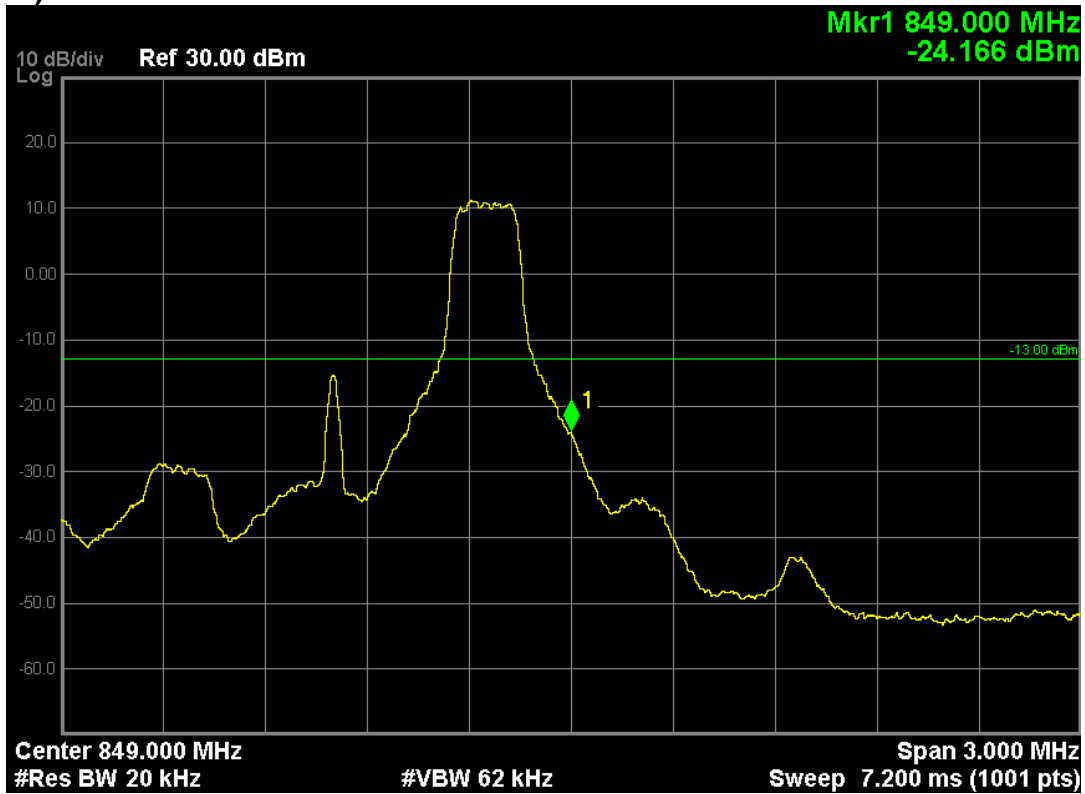

LTE Band 5 (16-QAM, Band Width 1.4MHz, RB Size 6, RB Offset 0, Channel 20643, Frequency 848.3MHz)

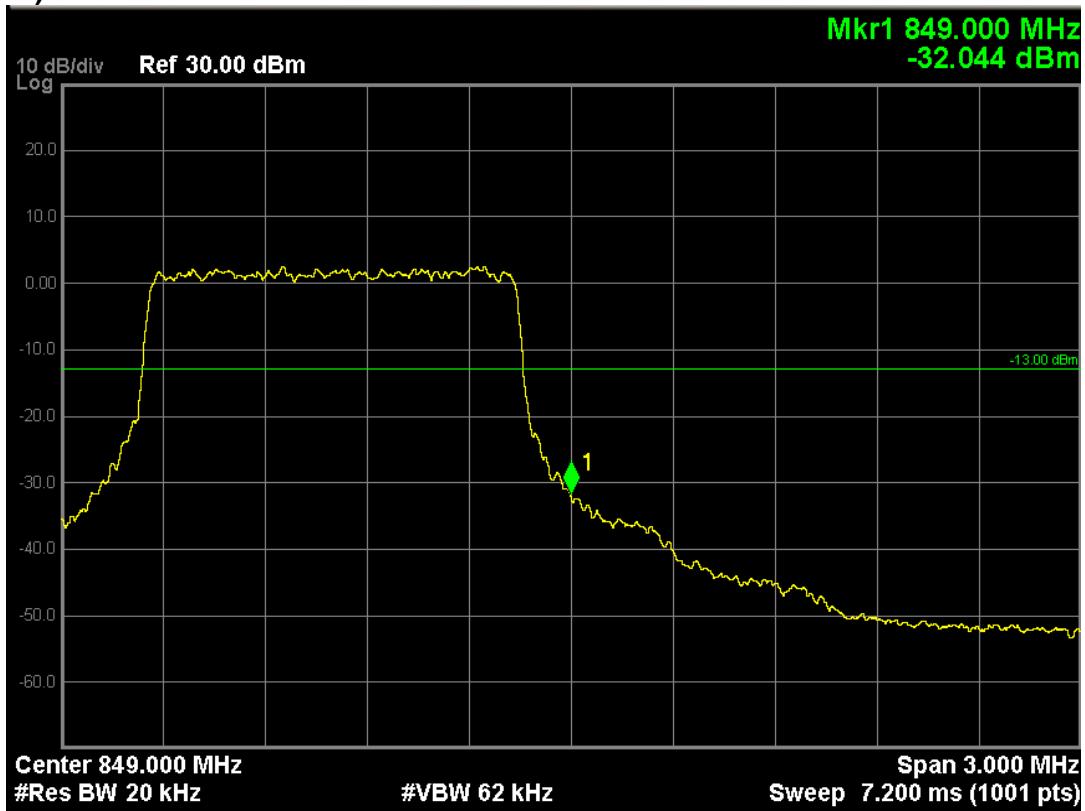

LTE Band 5 (QPSK, Band Width 3MHz, RB Size 1, RB Offset 0, Channel 20415, Frequency 825.5MHz)

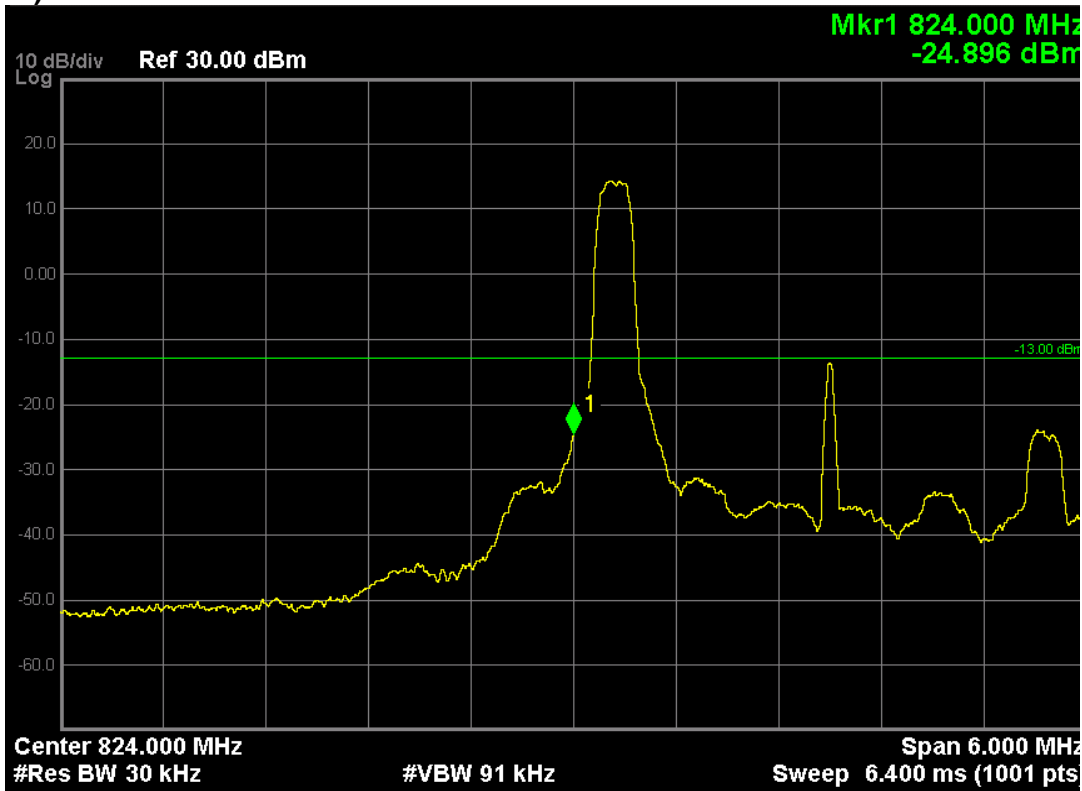

LTE Band 5 (QPSK, Band Width 3MHz, RB Size 15, RB Offset 0, Channel 20415, Frequency 825.5MHz)

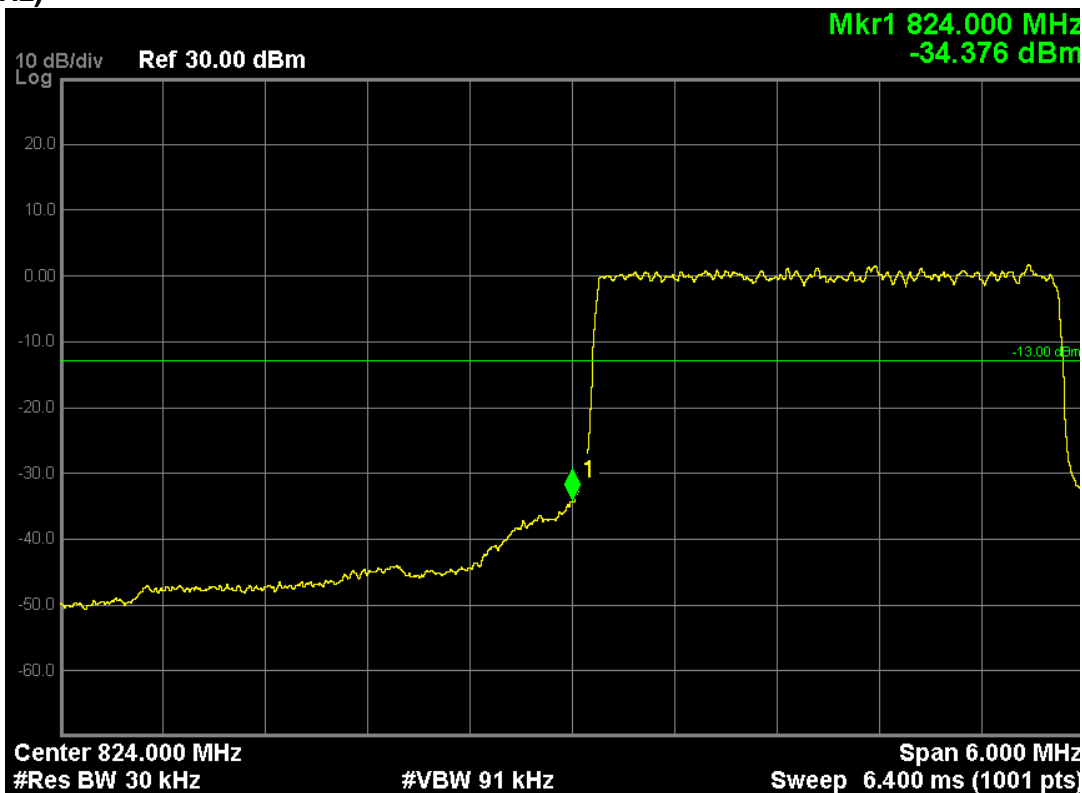

LTE Band 5 (QPSK, Band Width 3MHz, RB Size 1, RB Offset 14, Channel 20635, Frequency 847.5MHz)

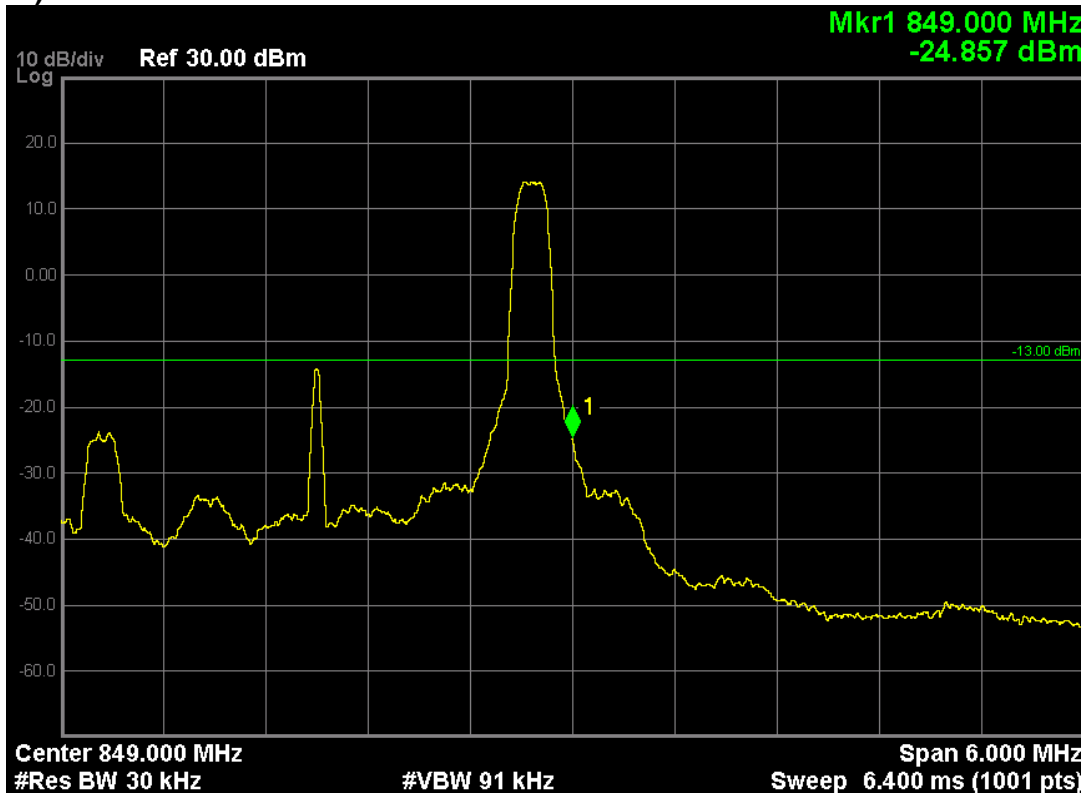

LTE Band 5 (QPSK, Band Width 3MHz, RB Size 15, RB Offset 0, Channel 20635, Frequency 847.5MHz)

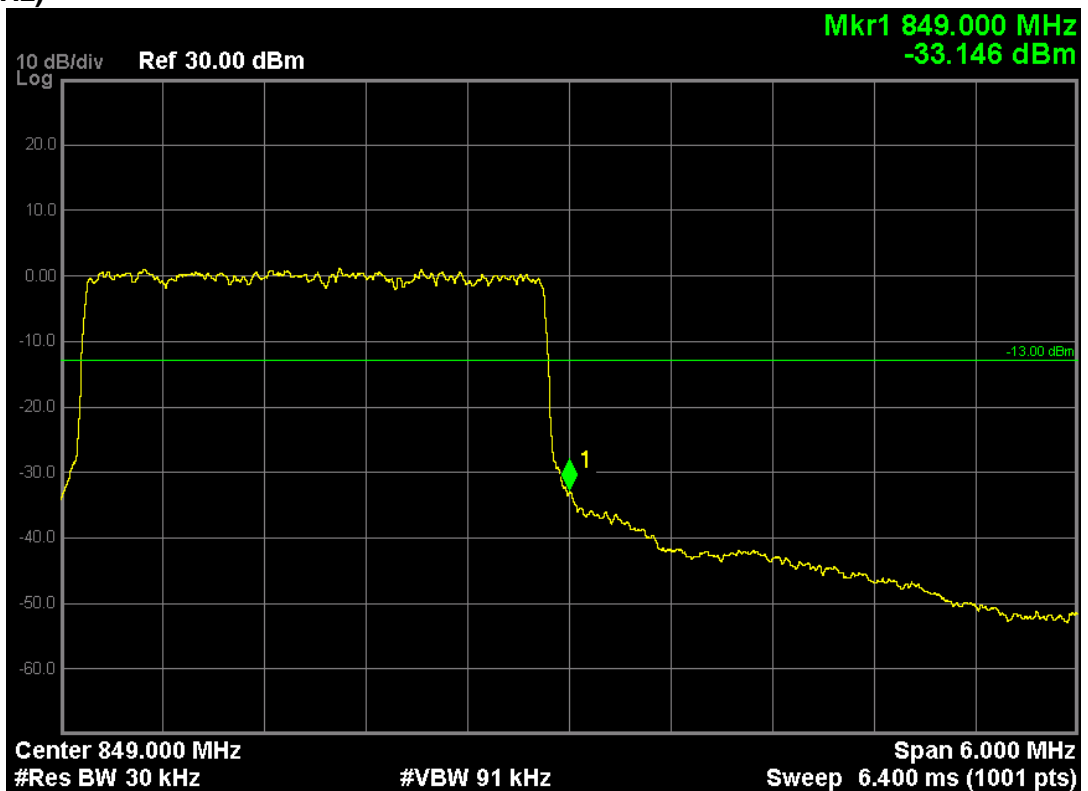

LTE Band 5 (16-QAM, Band Width 3MHz, RB Size 1, RB Offset 0, Channel 20415, Frequency 825.5MHz)

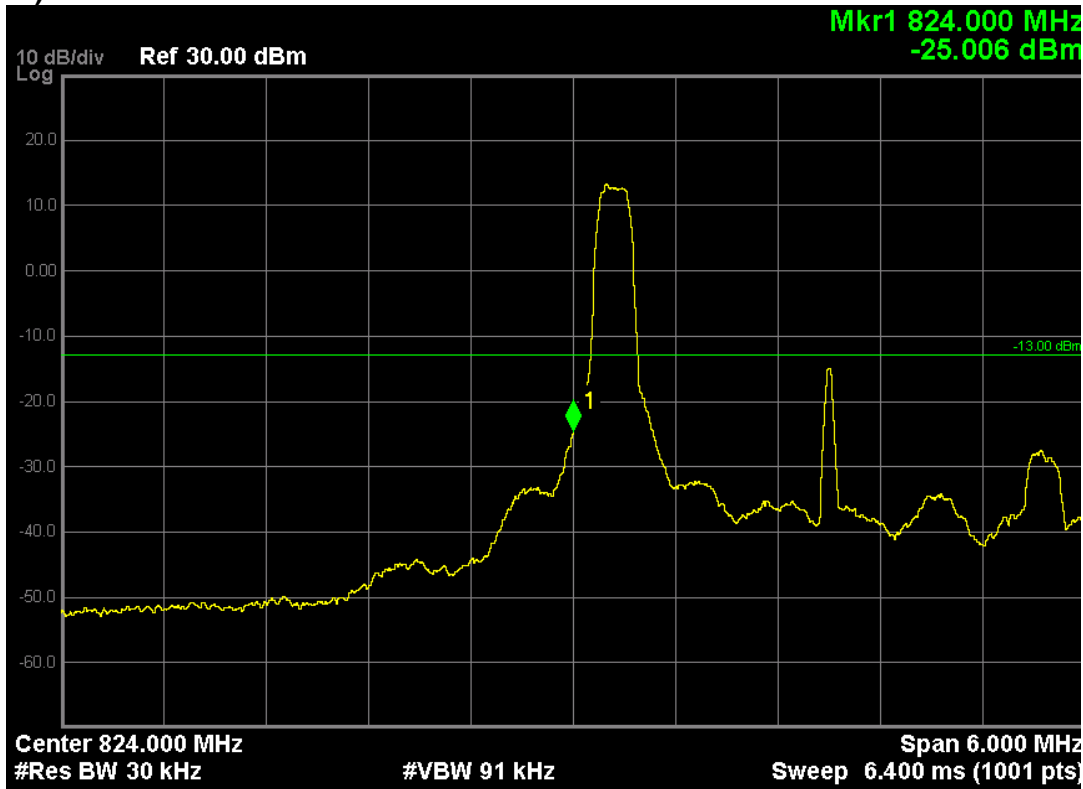

LTE Band 5 (16-QAM, Band Width 3MHz, RB Size 15, RB Offset 0, Channel 20415, Frequency 825.5MHz)

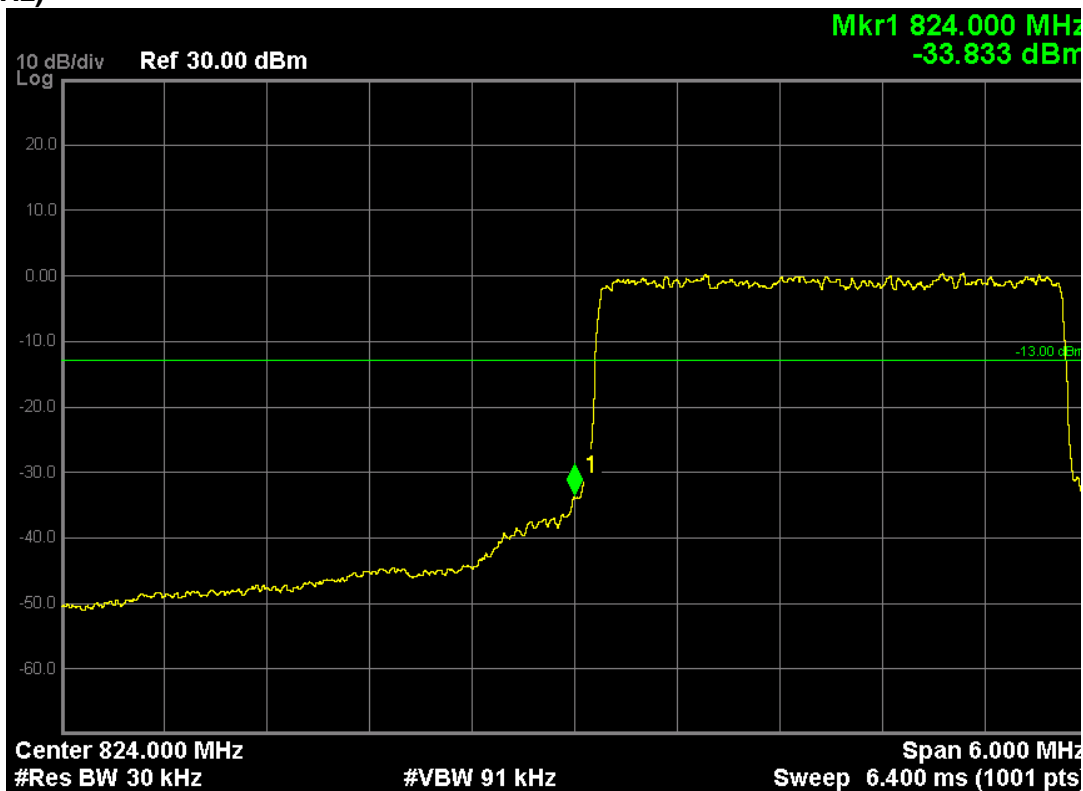

LTE Band 5 (16-QAM, Band Width 3MHz, RB Size 1, RB Offset 14, Channel 20635, Frequency 847.5MHz)

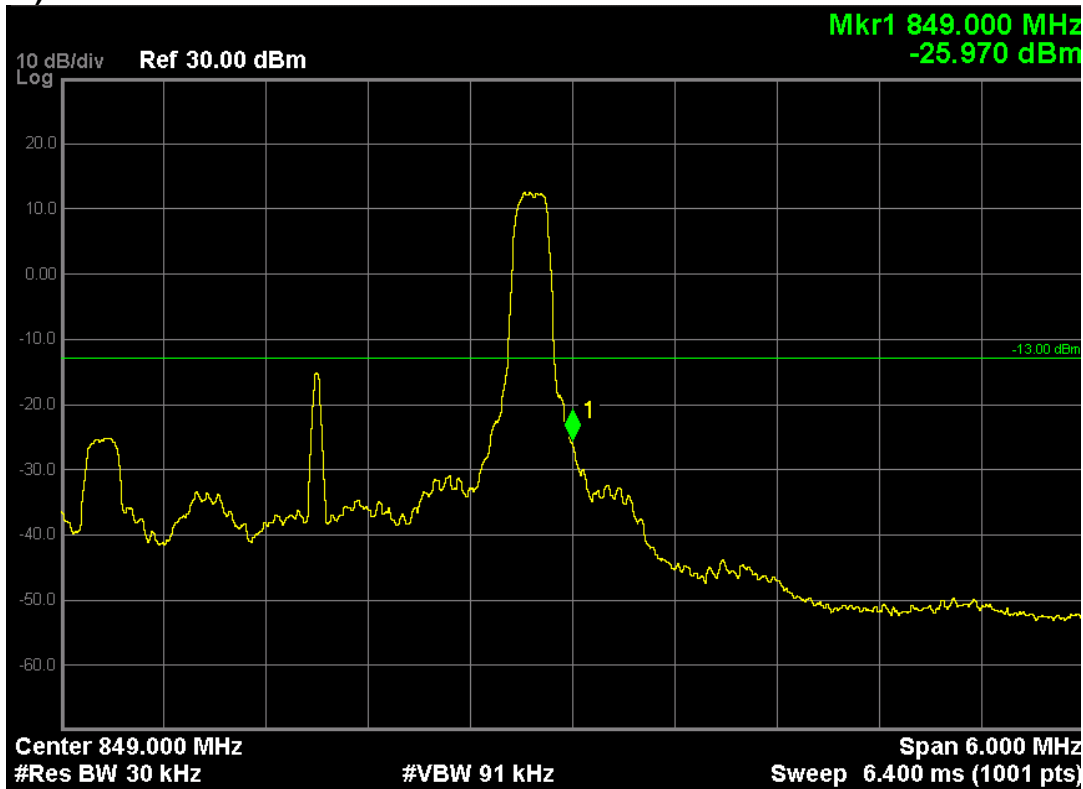

LTE Band 5 (16-QAM, Band Width 3MHz, RB Size 15, RB Offset 0, Channel 20635, Frequency 847.5MHz)

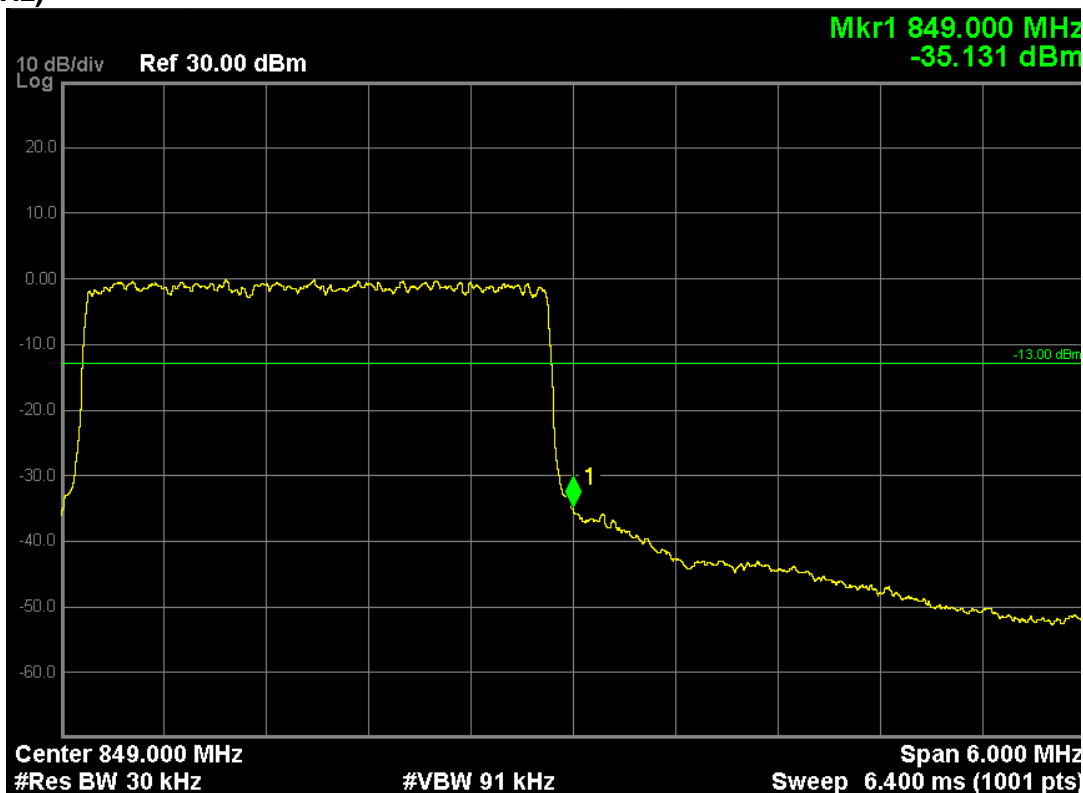

LTE Band 5 (QPSK, Band Width 5MHz, RB Size 1, RB Offset 0, Channel 20425, Frequency 826.5MHz)

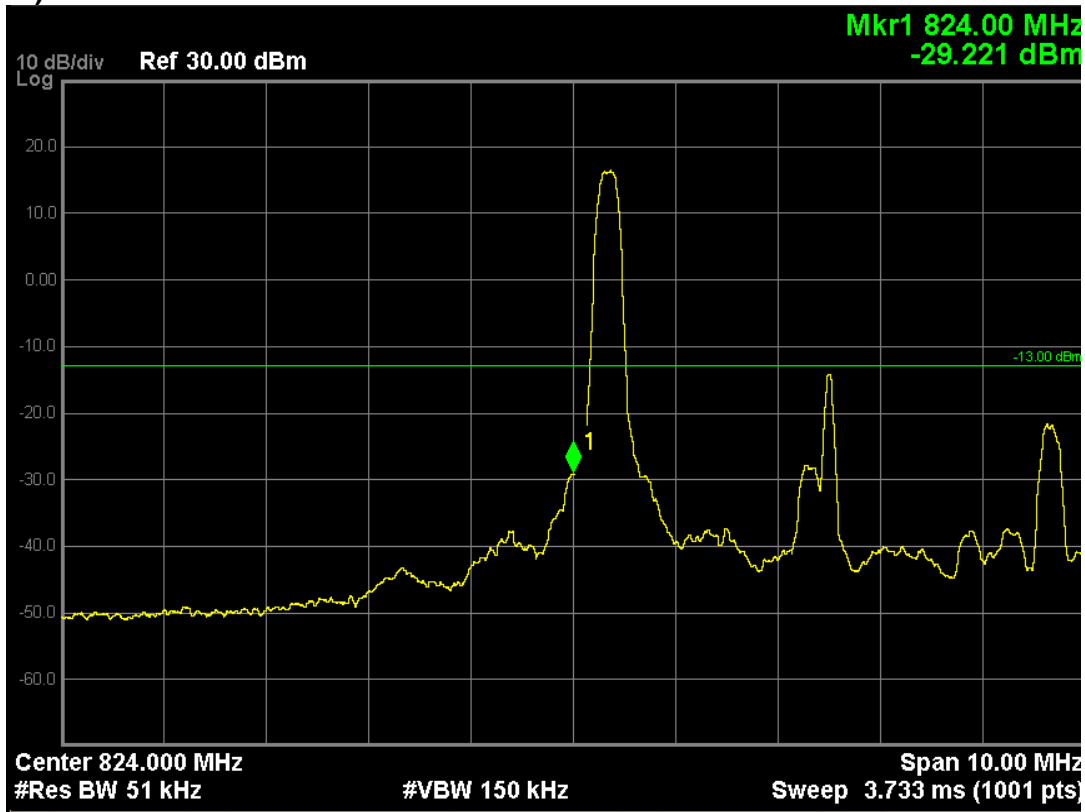

LTE Band 5 (QPSK, Band Width 5MHz, RB Size 25, RB Offset 0, Channel 20425, Frequency 826.5MHz)

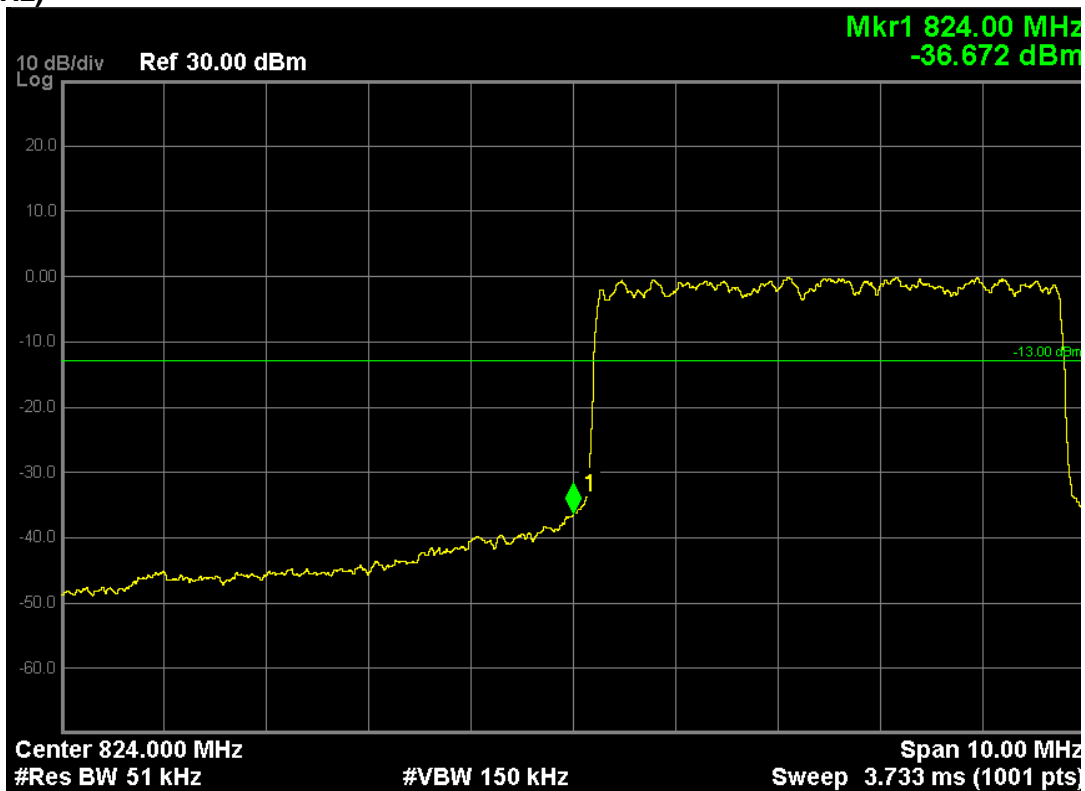

LTE Band 5 (QPSK, Band Width 5MHz, RB Size 1, RB Offset 24, Channel 20625, Frequency 846.5MHz)

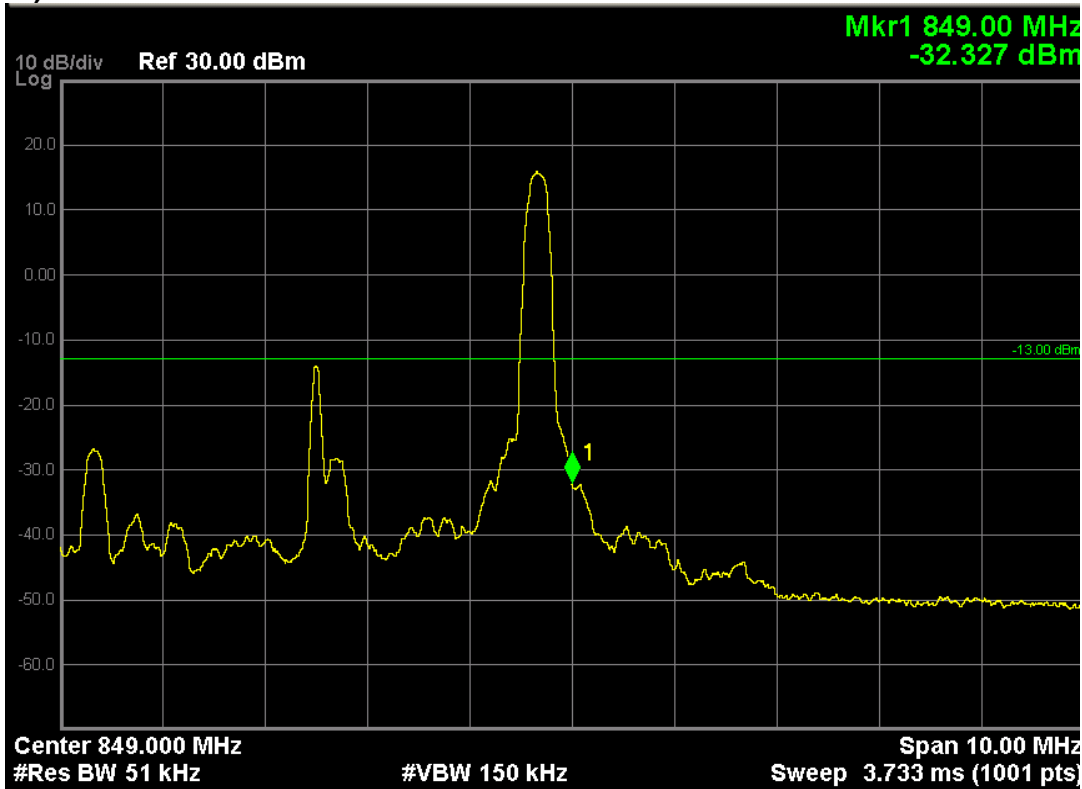

LTE Band 5 (QPSK, Band Width 5MHz, RB Size 25, RB Offset 0, Channel 20625, Frequency 846.5MHz)

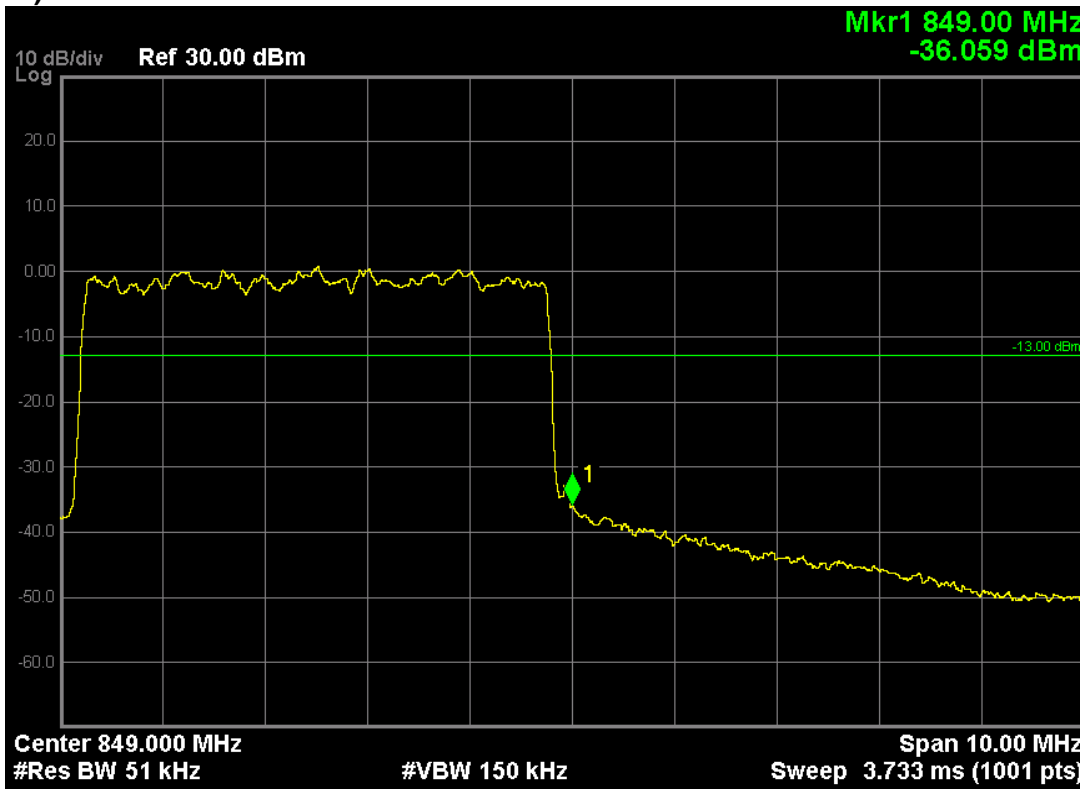

LTE Band 5 (16-QAM, Band Width 5MHz, RB Size 1, RB Offset 0, Channel 20425, Frequency 826.5MHz)

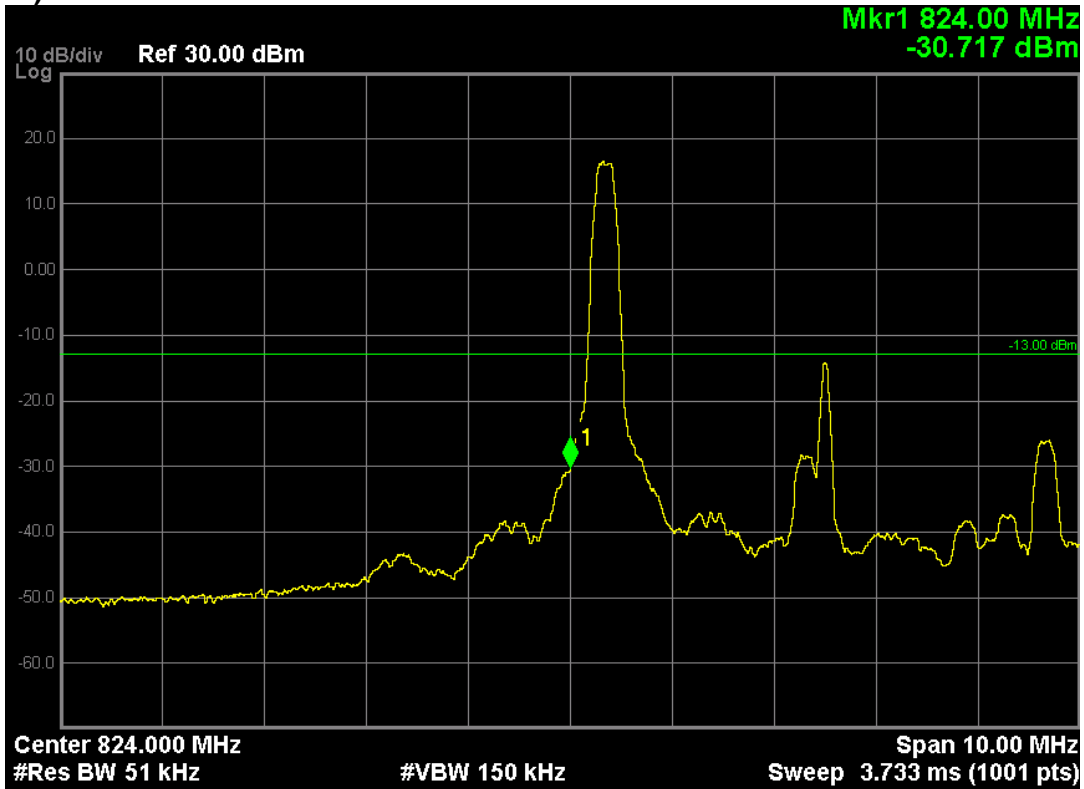

LTE Band 5 (16-QAM, Band Width 5MHz, RB Size 25, RB Offset 0, Channel 20425, Frequency 826.5MHz)

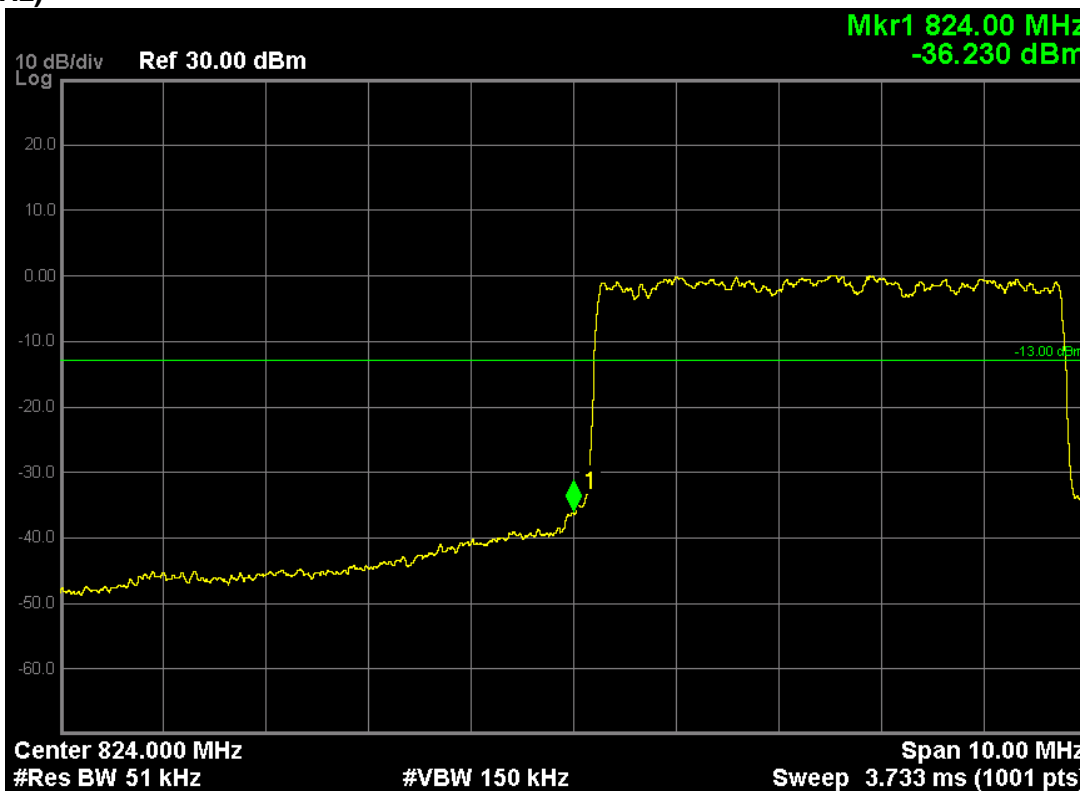

LTE Band 5 (16-QAM, Band Width 5MHz, RB Size 1, RB Offset 24, Channel 20625, Frequency 846.5MHz)

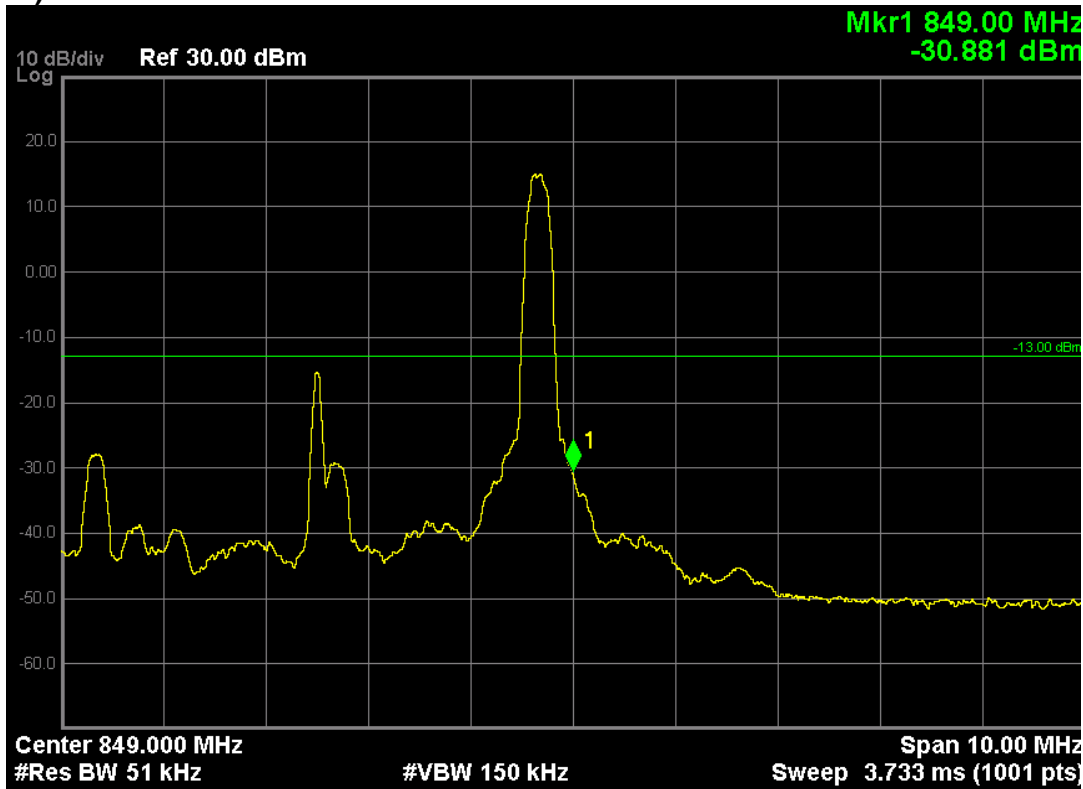

LTE Band 5 (16-QAM, Band Width 5MHz, RB Size 25, RB Offset 0, Channel 20625, Frequency 846.5MHz)

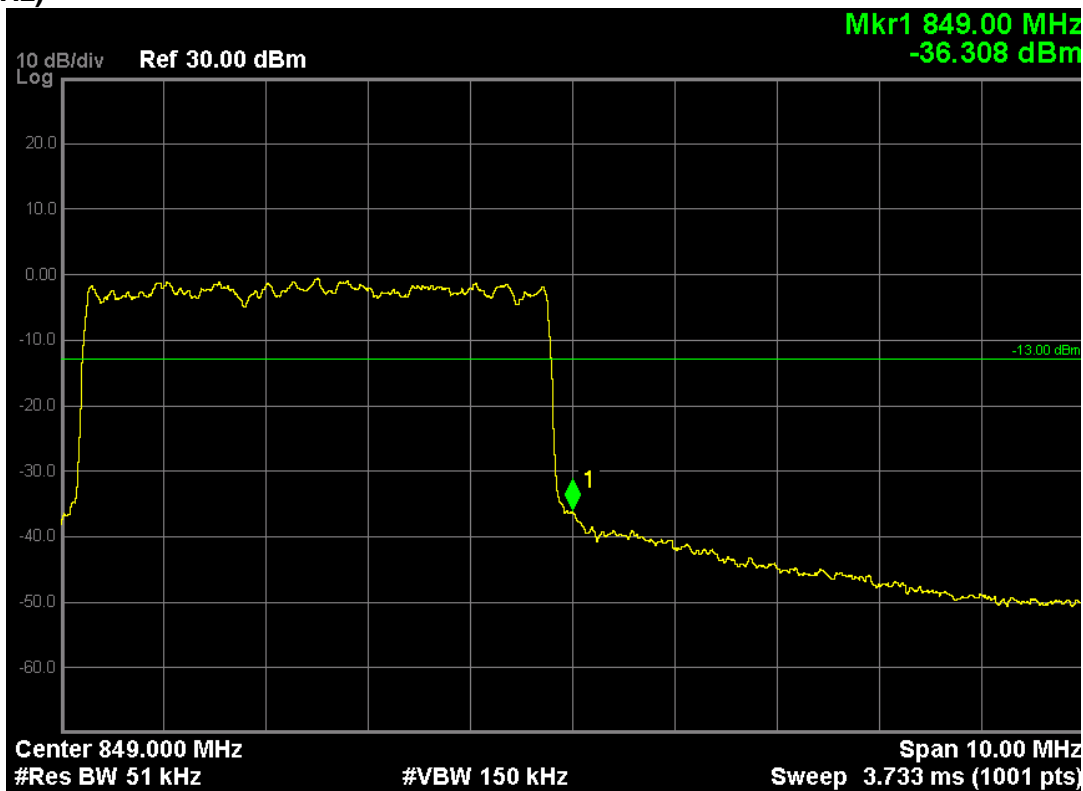

LTE Band 5 (QPSK, Band Width 10MHz, RB Size 1, RB Offset 0, Channel 20450, Frequency 829.0MHz)

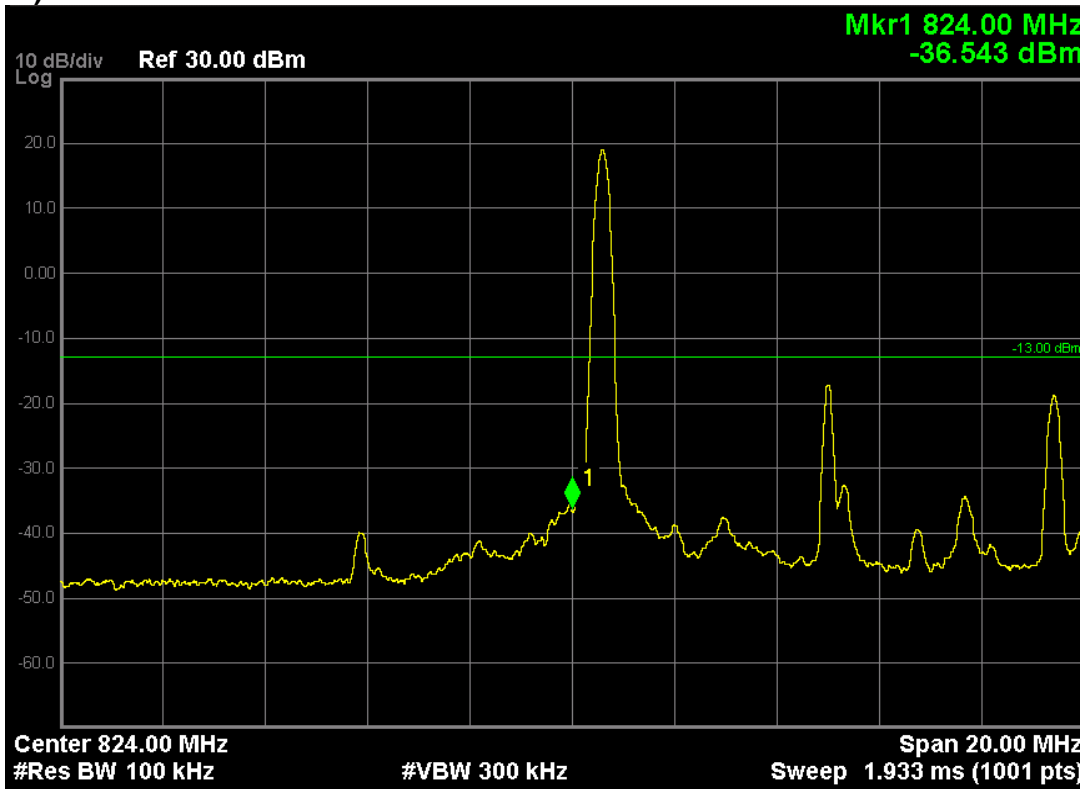

LTE Band 5 (QPSK, Band Width 10MHz, RB Size 50, RB Offset 0, Channel 20450, Frequency 829.0MHz)

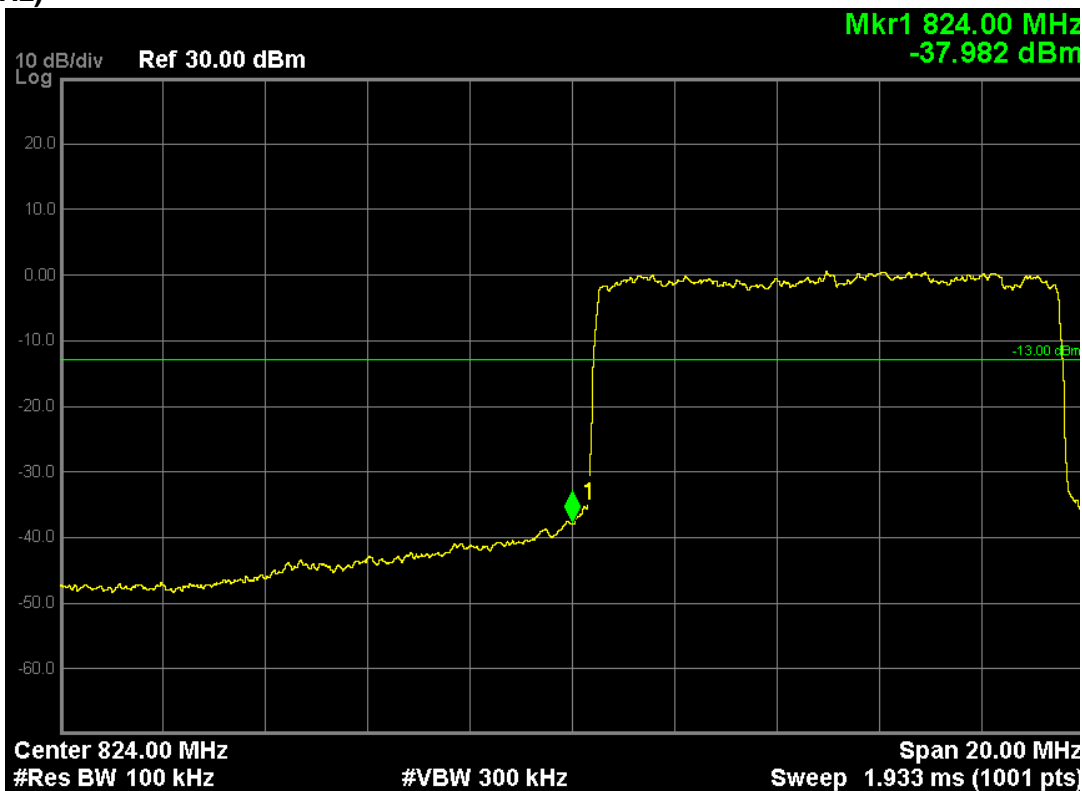

LTE Band 5 (QPSK, Band Width 10MHz, RB Size 1, RB Offset 49, Channel 20600, Frequency 844.0MHz)

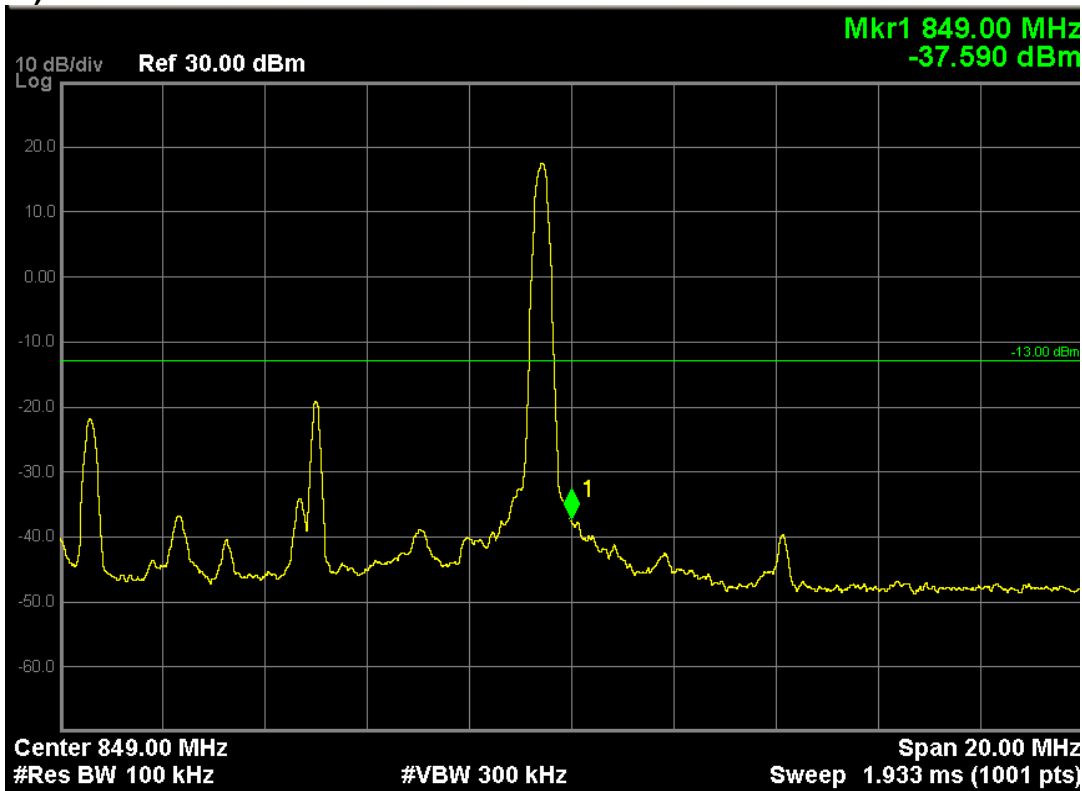

LTE Band 5 (QPSK, Band Width 10MHz, RB Size 50, RB Offset 0, Channel 20600, Frequency 844.0MHz)

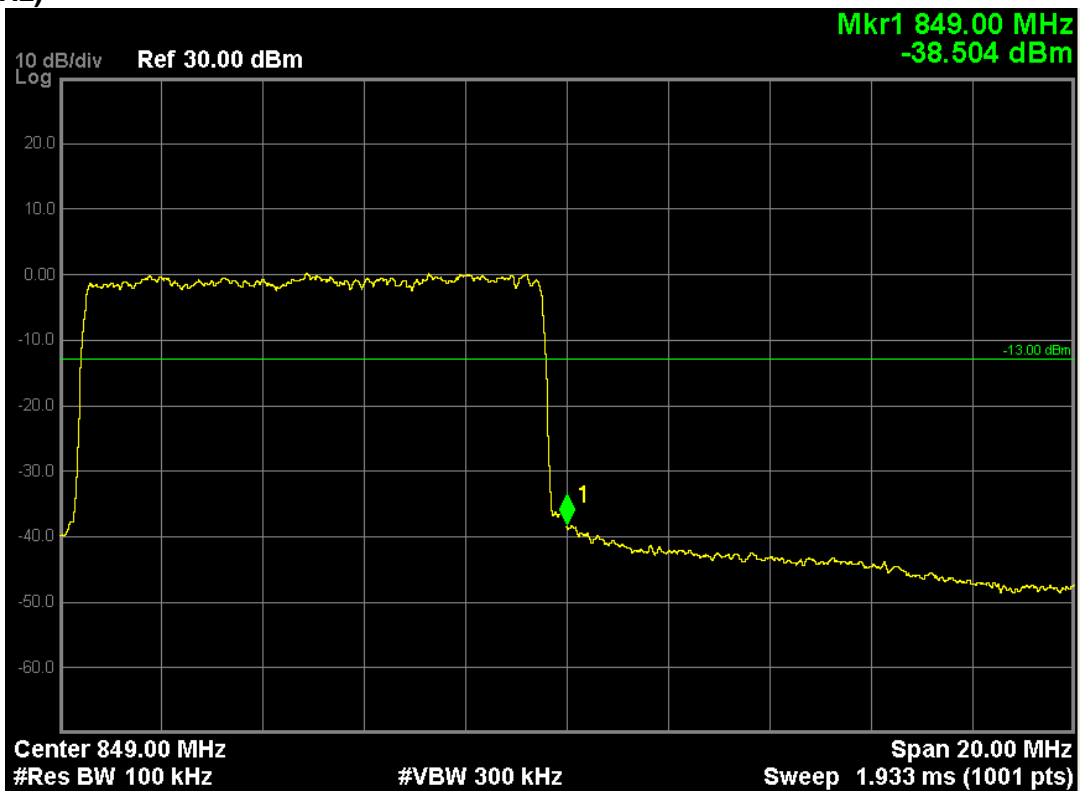

LTE Band 5 (16-QAM, Band Width 10MHz, RB Size 1, RB Offset 0, Channel 20450, Frequency 829.0MHz)

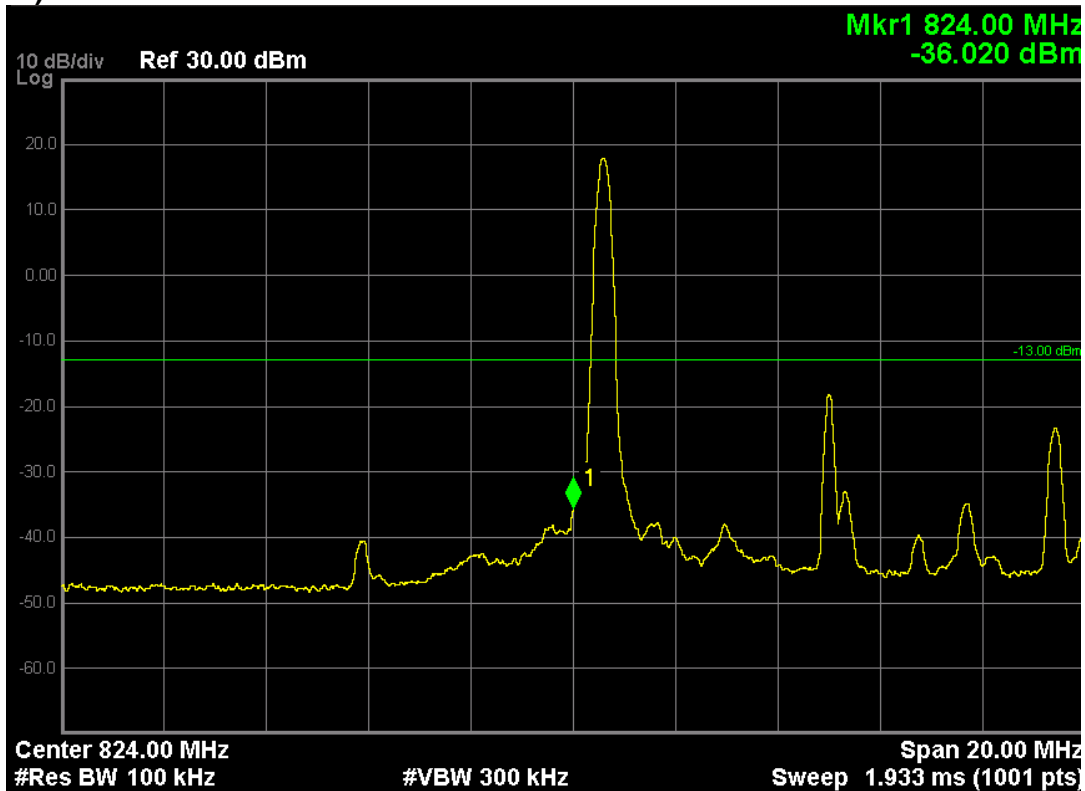

LTE Band 5 (16-QAM, Band Width 10MHz, RB Size 50, RB Offset 0, Channel 20450, Frequency 829.0MHz)

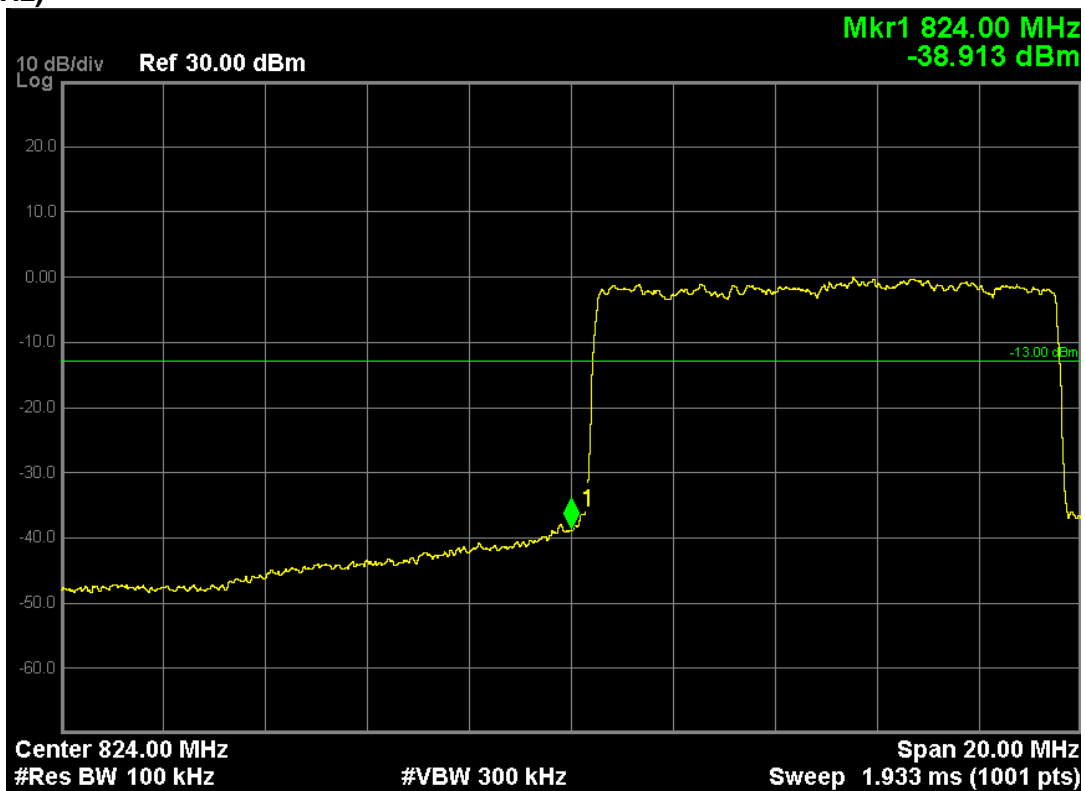

LTE Band 5 (16-QAM, Band Width 10MHz, RB Size 1, RB Offset 49, Channel 20600, Frequency 844.0MHz)

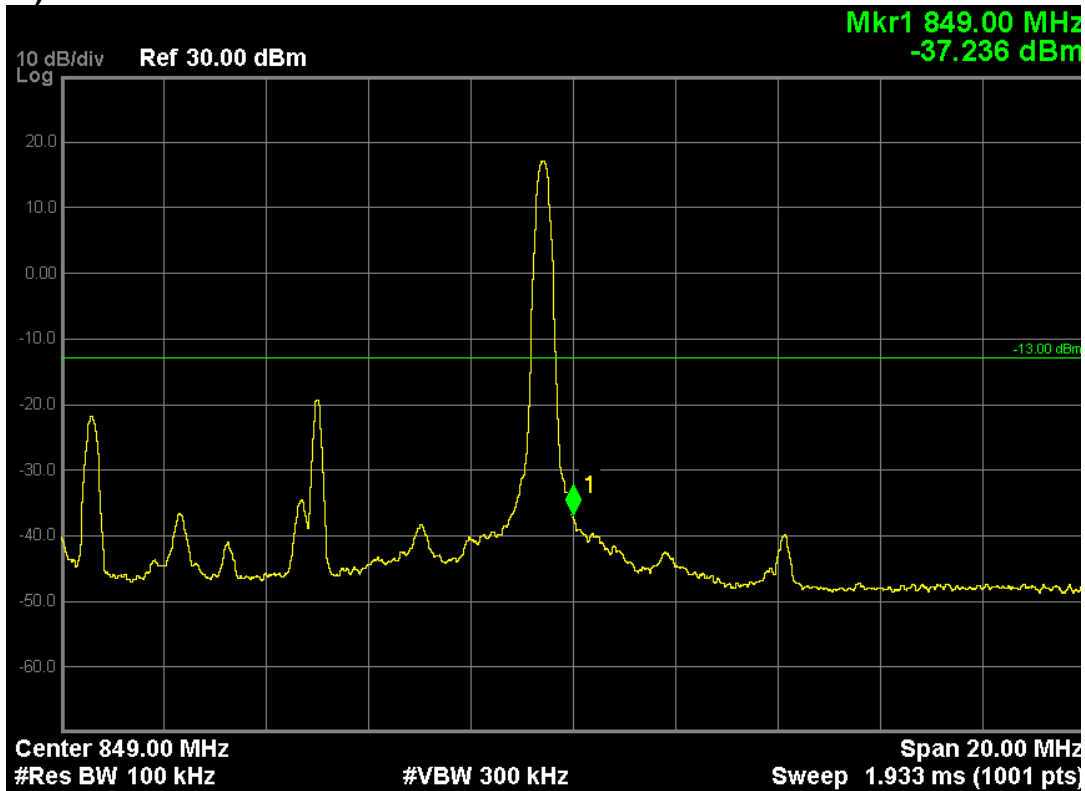

LTE Band 5 (16-QAM, Band Width 10MHz, RB Size 50, RB Offset 0, Channel 20600, Frequency 844.0MHz)

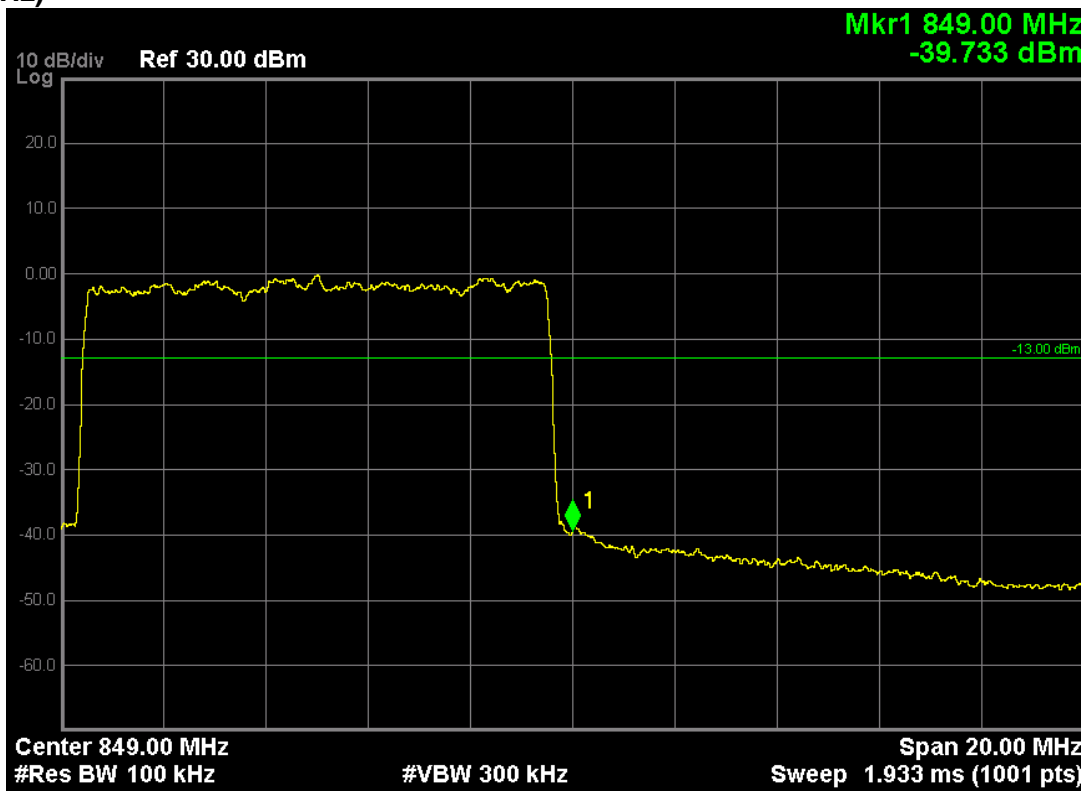

6.Spurious Emission

6.1. Test Equipment

Instrument	Manufacturer	Model	Serial No.	Cali. Due Date
SpectrumAnalyzer	Agilent	N9038A	MY51210142	11/05/2016
Radio Communication Tester	R&S	CMW500	147483	11/08/2016
SignalGenerator	Agilent	N5183A	MY50140938	01/03/2017
Preamplifier	CEM	EM30180	3008A0245	02/26/2017
Loop Antenna	Schwarzbeck	FMZB1519	1519-020	03/24/2017
Bilog Antenna	Schwarzbeck	VULB9160	9160-3316	09/19/2016
VHF-UHF-Biconical Antenna	Schwarzbeck	VUBA9117	9117-263	09/19/2016
Broad-Band Horn Antenna	Schwarzbeck	BBHA9120D	9120D-942	09/19/2016
Broad-Band Horn Antenna	Schwarzbeck	BBHA9120D	9120D-943	09/19/2016

The measure equipment had been calibrated once a year.

6.2. Test Setup

Conducted Spurious Emission Measurement:

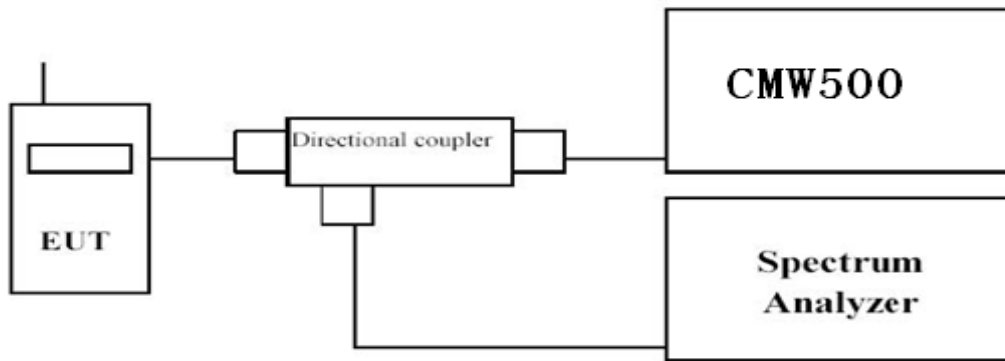

Radiated Spurious Measurement: below 30MHz

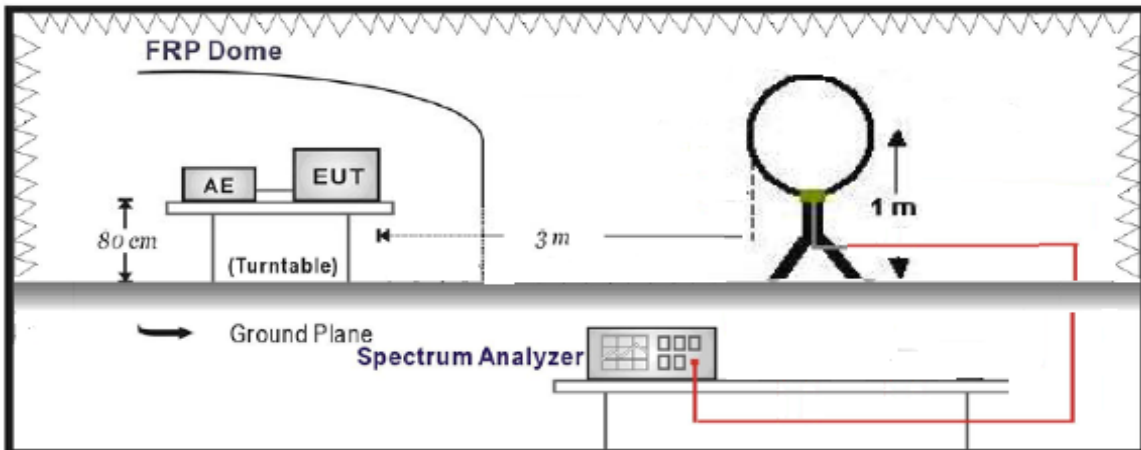

Radiated Spurious Measurement: 30MHz to 1GHz

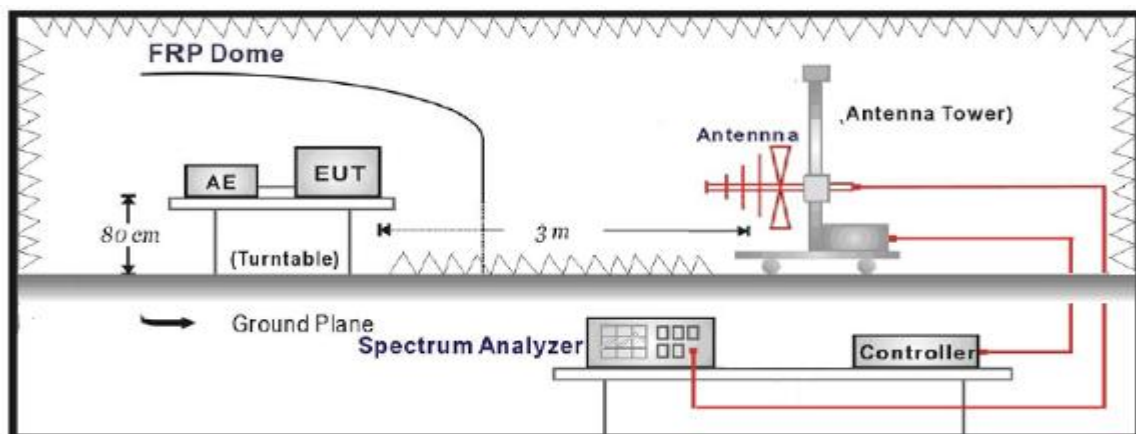

Radiated Spurious Measurement: above 1GHz

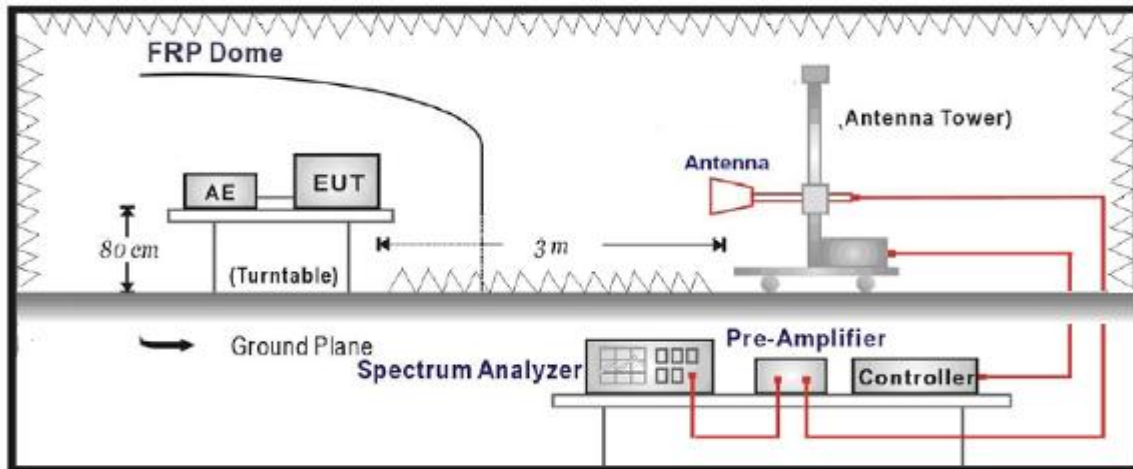

6.3. Limit

The power of any emission outside of the authorized operating frequency ranges must be attenuated below the transmitting power (P) by a factor of at least $43 + 10\log(P)$ dB.

6.4. Test Procedure

Conducted Spurious Measurement:

- The testing follows FCC KDB 971168 v02v02 Section 6.0;
- Place the EUT on a bench and set it in transmitting mode.
- Connect a low loss RF cable from the antenna port to a spectrum analyzer and CMW500 by a Directional Coupler.
- EUT Communicate with CMW500, then select a channel for testing.
- Add a correction factor to the display of spectrum, and then test.
- The resolution bandwidth of the spectrum analyzer was set at 1 MHz, sufficient scans were taken to show the out of band Emission if any up to 10th harmonic.

Radiated Spurious Measurement:

- The testing follows FCC KDB 971168 v02v02 Section 5.8 and ANSI/TIA-603-D-2010 Section 2.2.12;
- The EUT shall be placed at the specified height on a support, and in the position closest to normal use as declared by provider.
- The test antenna shall be oriented initially for vertical polarization and shall be chosen to correspond to the frequency of the transmitter
- The output of the test antenna shall be connected to the measuring receiver. The transmitter shall be switched on and the measuring receiver shall be tuned to the frequency of the transmitter under test.
- The test antenna shall be raised and lowered through the specified range of height until a

- maximum signal level is detected by the measuring receiver.
- f. The transmitter shall then be rotated through 360° in the horizontal plane, until the maximum signal level is detected by the measuring receiver.
 - g. The test antenna shall be raised and lowered again through the specified range of height until a maximum signal level is detected by the measuring receiver.
 - h. The maximum signal level detected by the measuring receiver shall be noted.
 - i. The transmitter shall be replaced by a substitution antenna.
 - j. The substitution antenna shall be orientated for vertical polarization and the length of the substitution antenna shall be adjusted to correspond to the frequency of the transmitter.
 - k. The substitution antenna shall be connected to a calibrated signal generator.
 - l. If necessary, the input attenuator setting of the measuring receiver shall be adjusted in order to increase the sensitivity of the measuring receiver.
 - m. The test antenna shall be raised and lowered through the specified range of height to ensure that the maximum signal is received.
 - n. The input signal to the substitution antenna shall be adjusted to the level that produces a level detected by the measuring receiver, that is equal to the level noted while the transmitter radiated power was measured, corrected for the change of input attenuator setting of the measuring receiver.
 - o. The measurement shall be repeated with the test antenna and the substitution antenna orientated for horizontal polarization.
 - p. The measure of the effective radiated power is the larger of the two levels recorded at the input to the substitution antenna, corrected for gain of the substitution antenna if necessary.
 - q. The frequency range was checked up to 10^{th} harmonic.

6.5. Uncertainty

The measurement uncertainty is defined as 3.2 dB for Radiated Power Measurement.

6.6. Test Result

Conducted Spurious Measurement:

LTE Band 5 (QPSK, Band Width 1.4MHz, RB Size 1, RB Offset 0, Channel 20407, Frequency 824.7MHz)

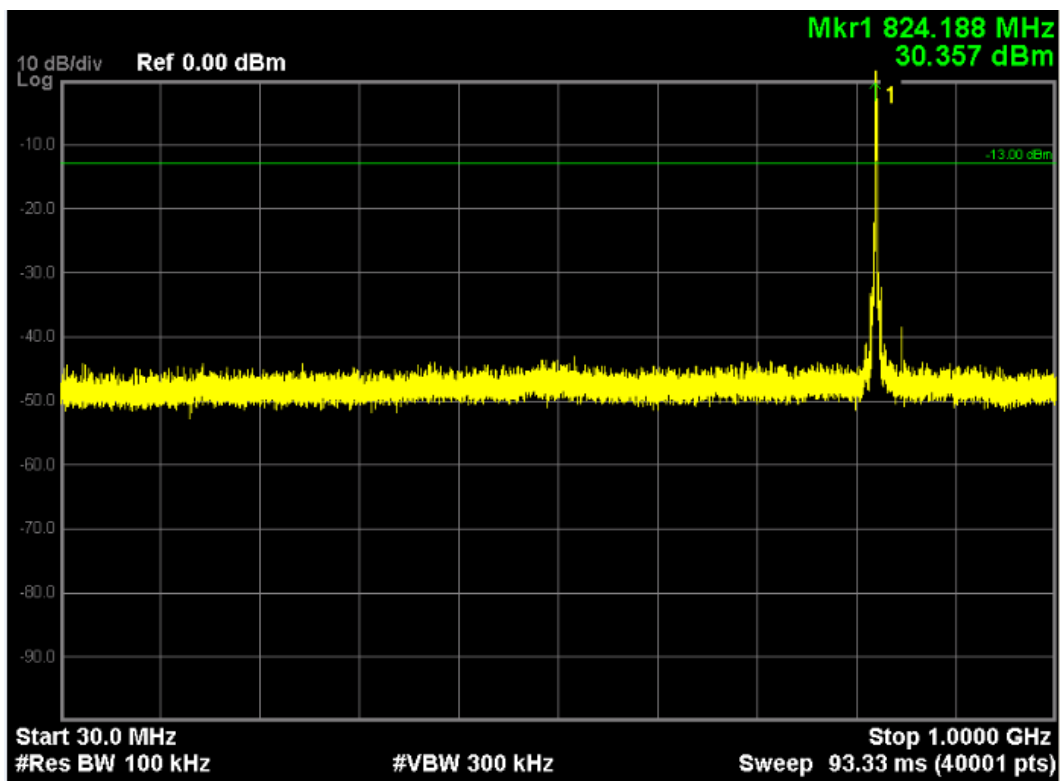
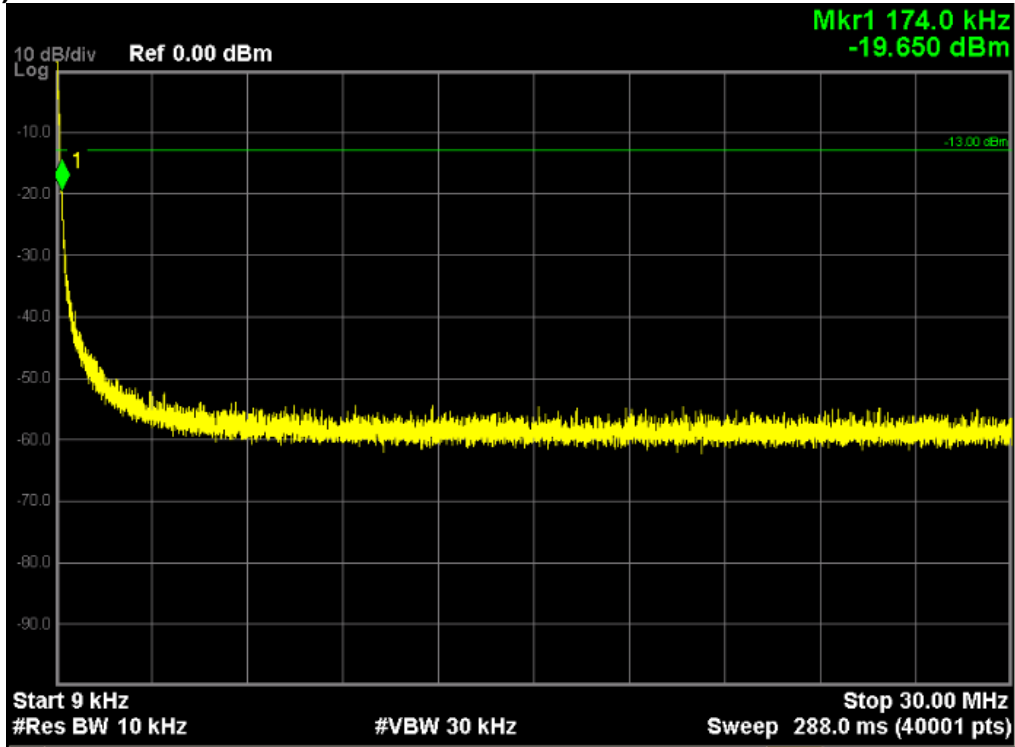

Note: The signal at point 1 is carrier

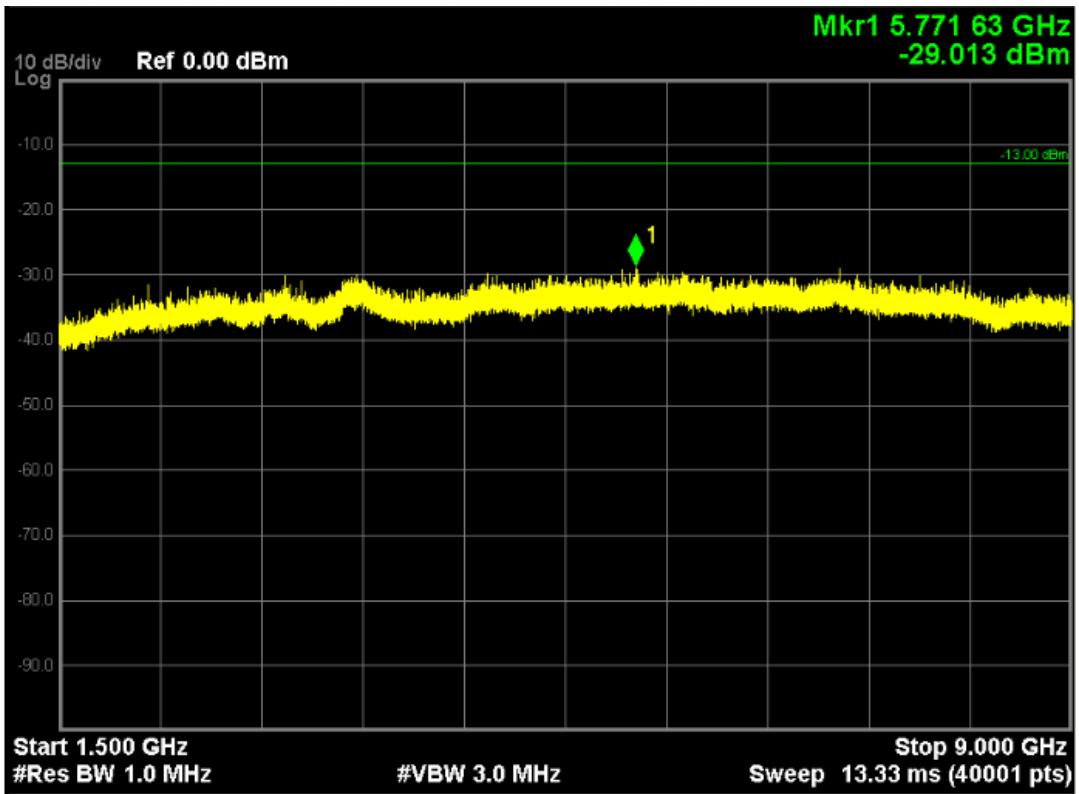
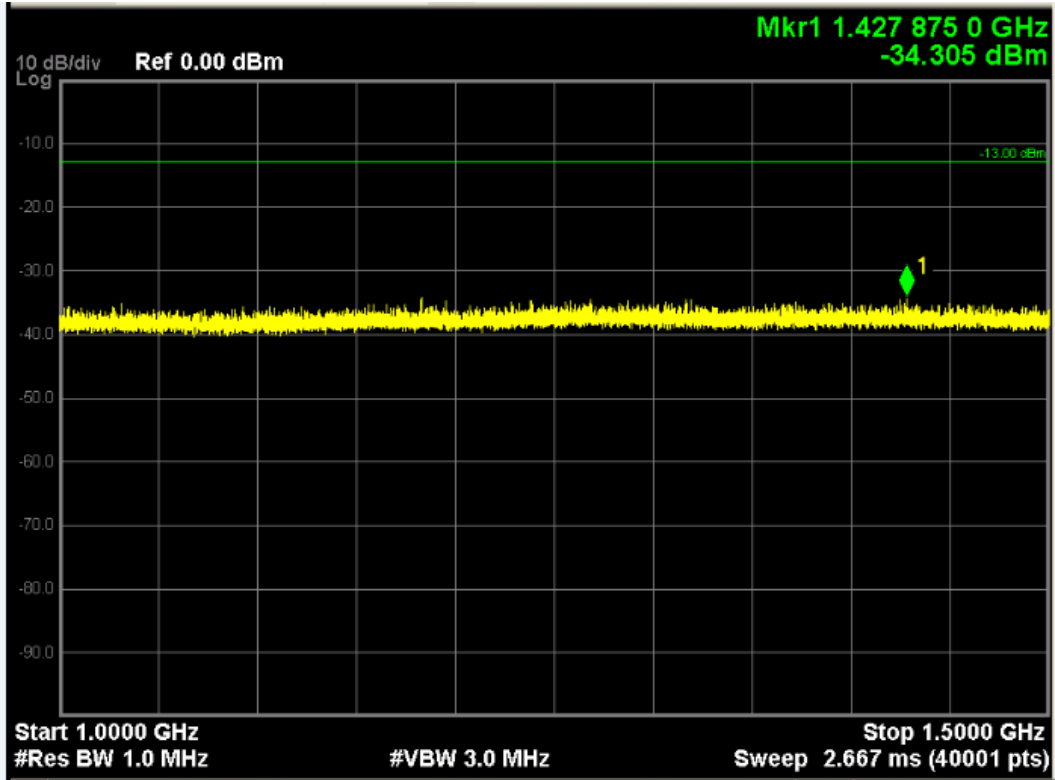

LTE Band 5 (16-QAM, Band Width 1.4MHz, RB Size 1, RB Offset 0, Channel 20643, Frequency 848.3MHz)

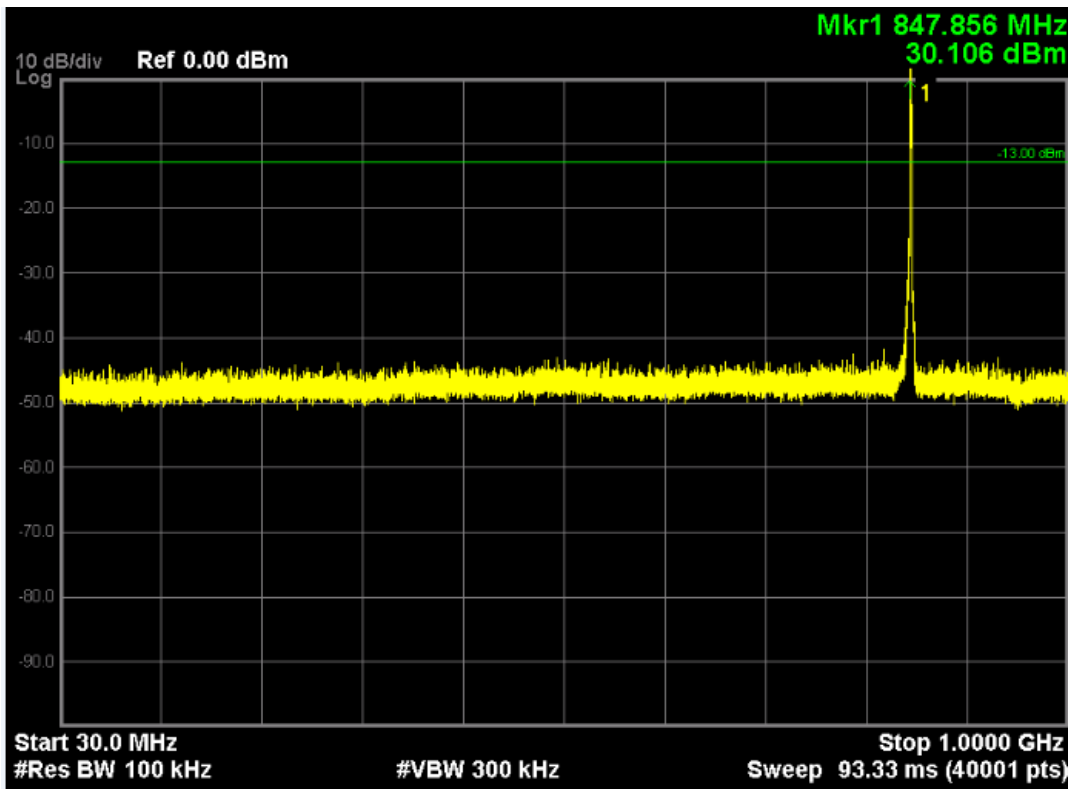
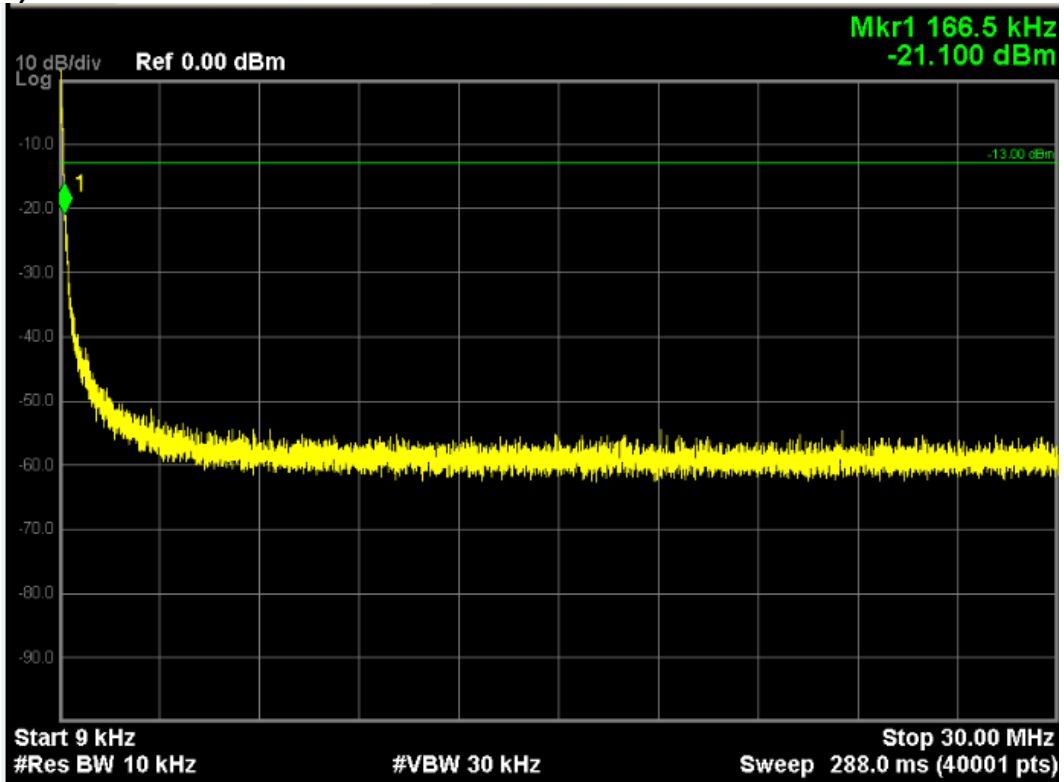

Note: The signal at point 1 is carrier

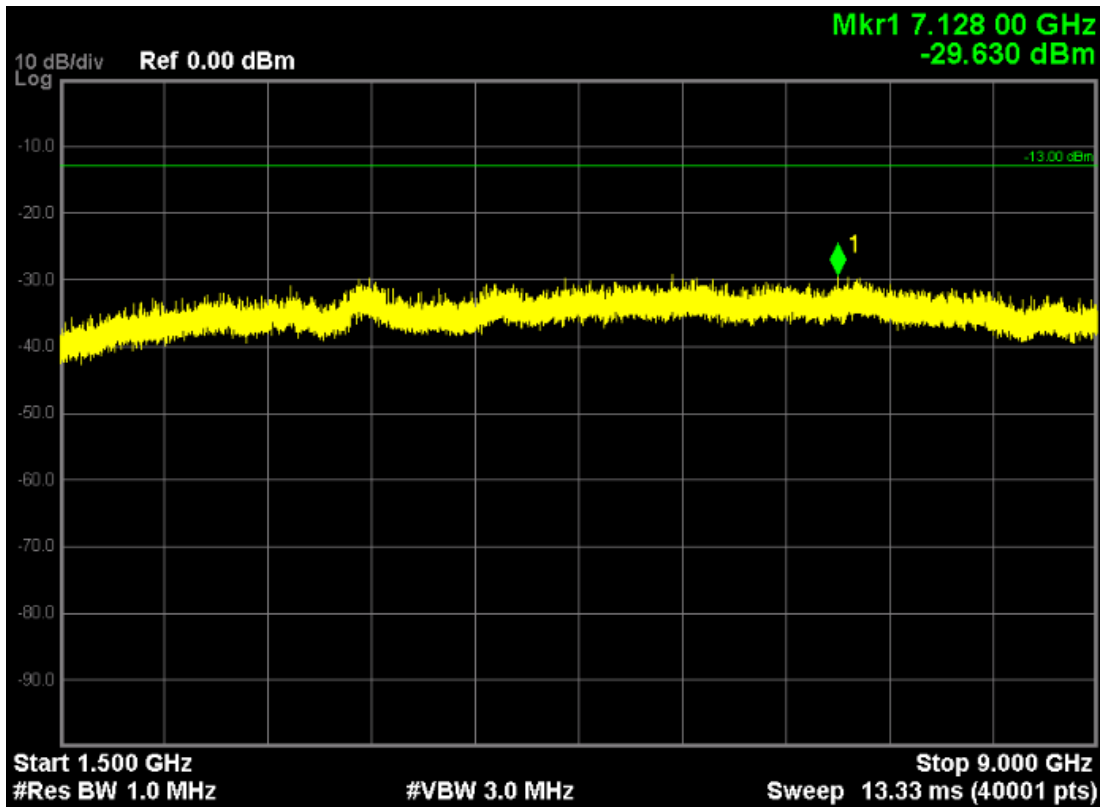
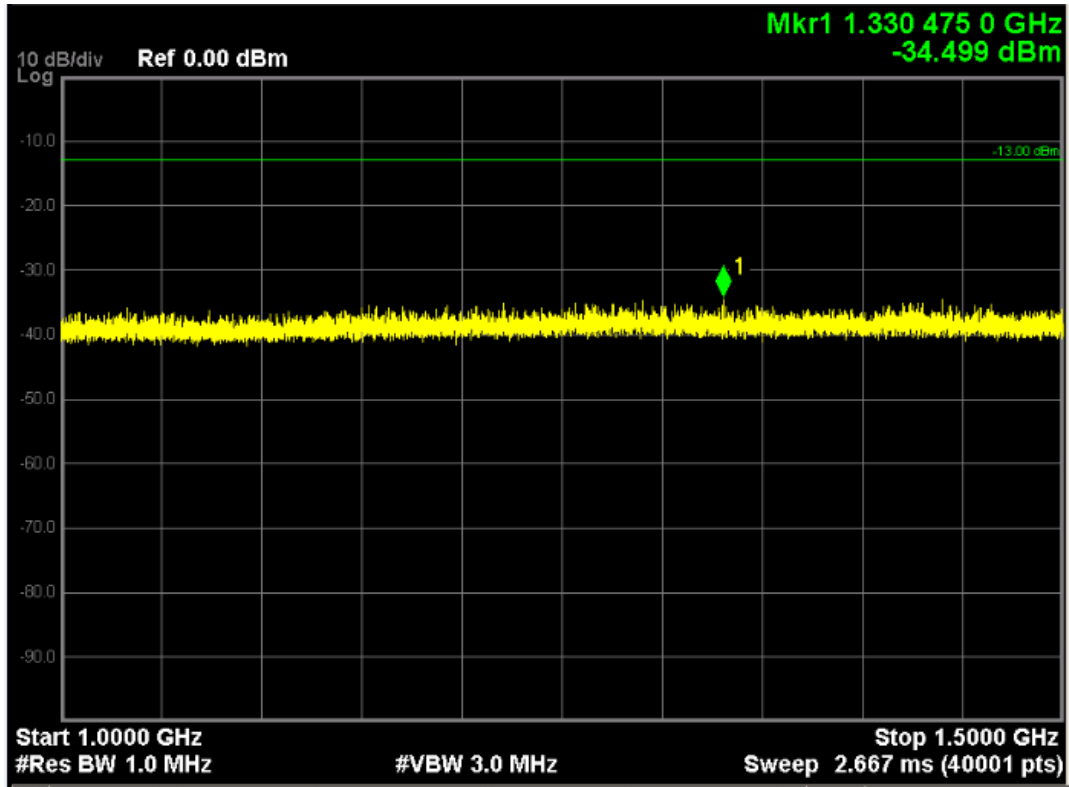

LTE Band 5 (QPSK, Band Width 3MHz, RB Size 1, RB Offset 0, Channel 20415, Frequency 825.5MHz)

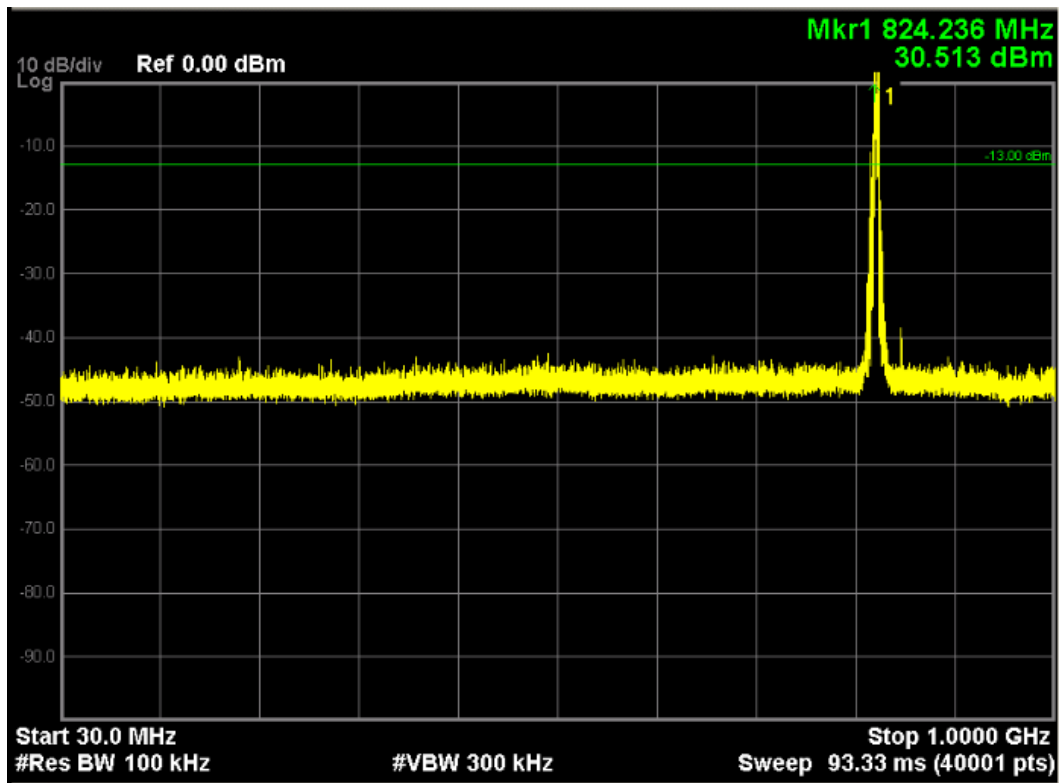
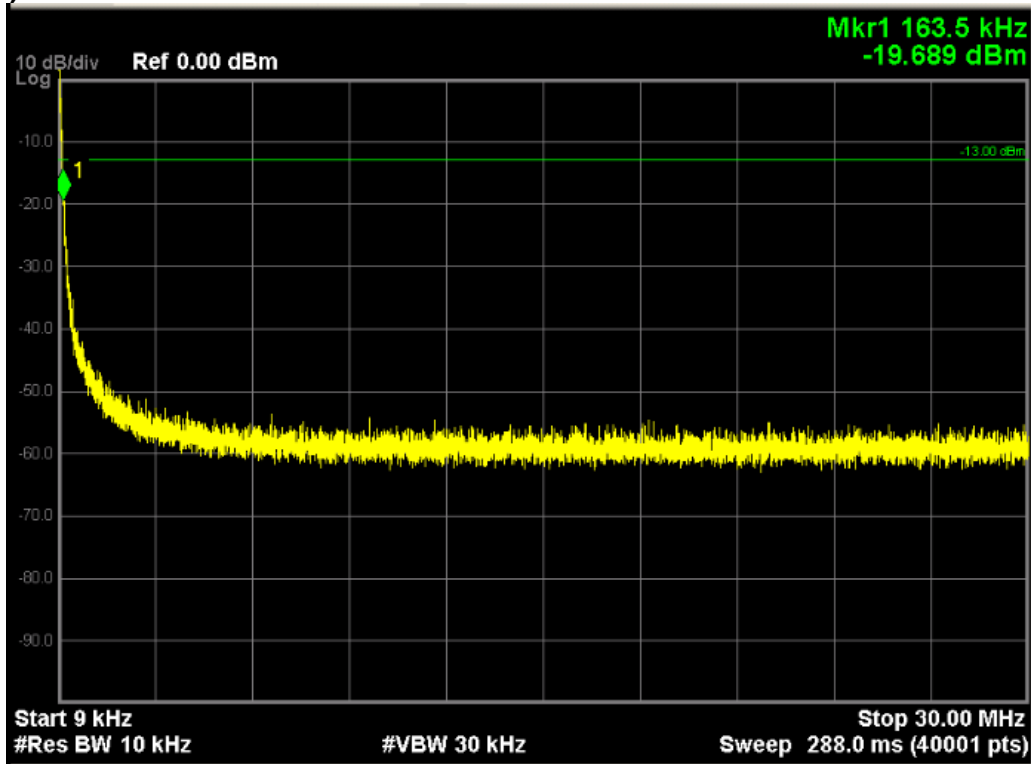

Note: The signal at point 1 is carrier

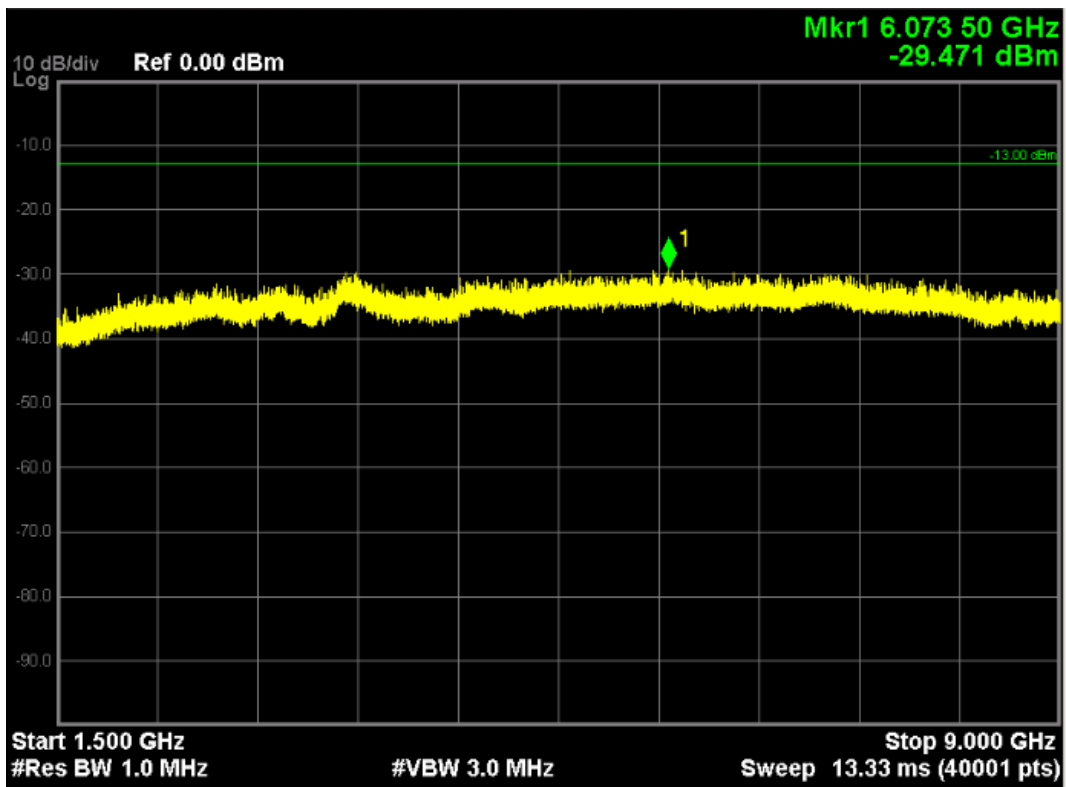
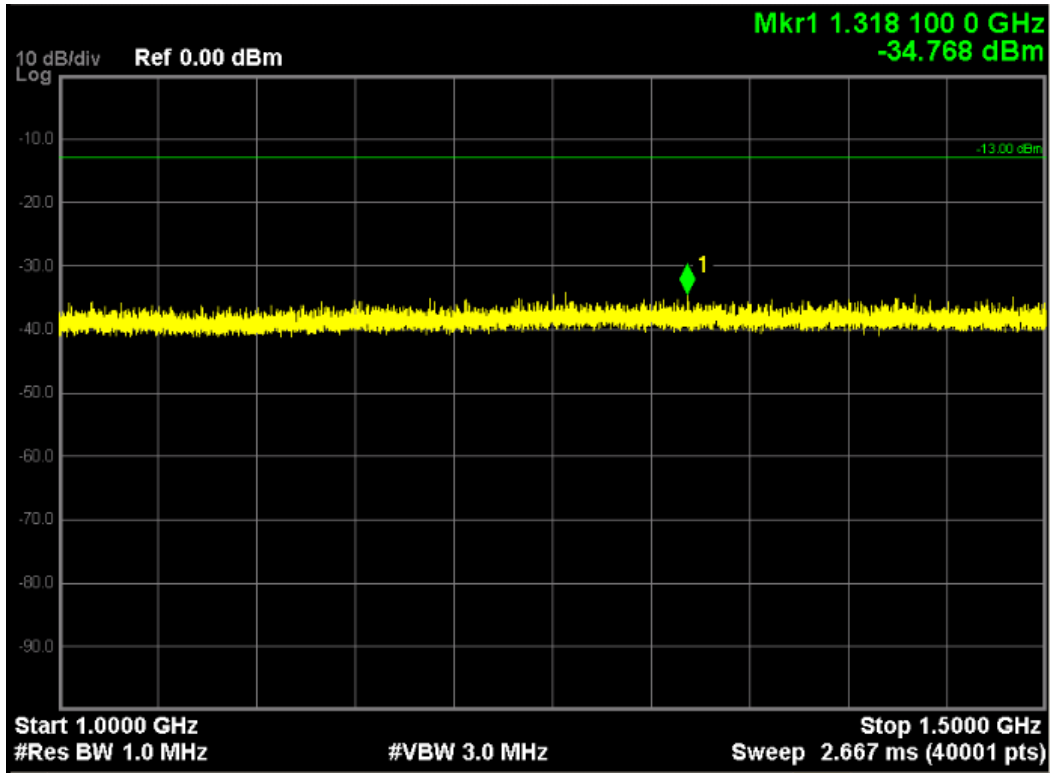

LTE Band 5 (16-QAM, Band Width 3MHz,RB Size 1,RB Offset 0,Channel 20415,Frequency 825.5MHz)

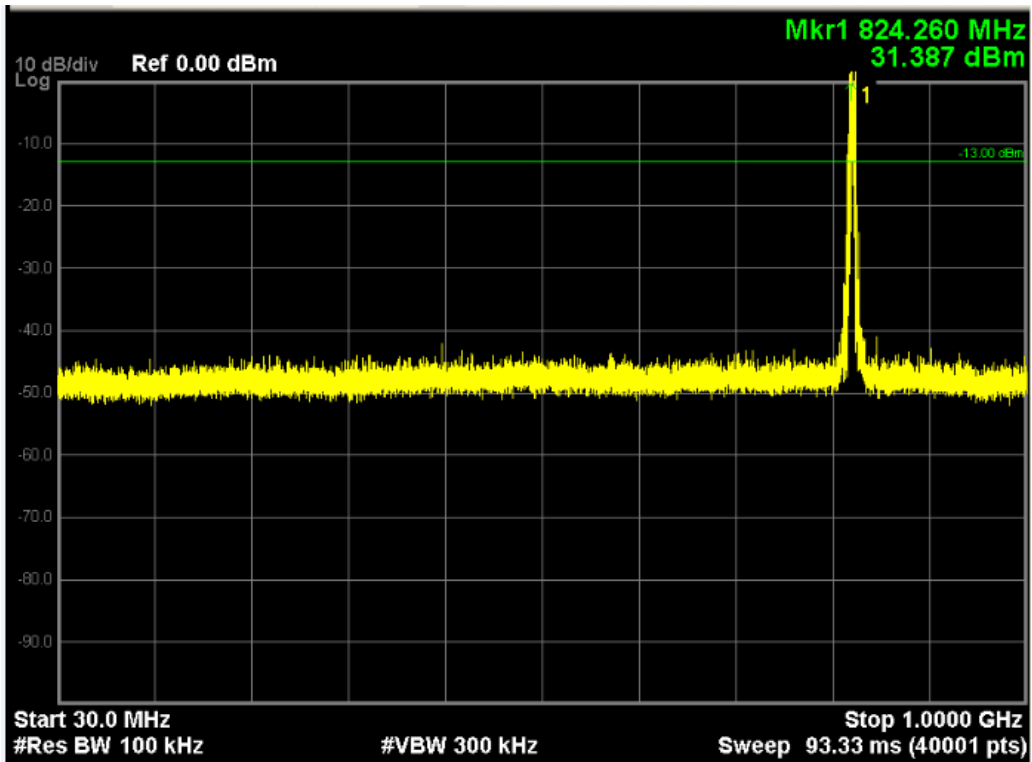
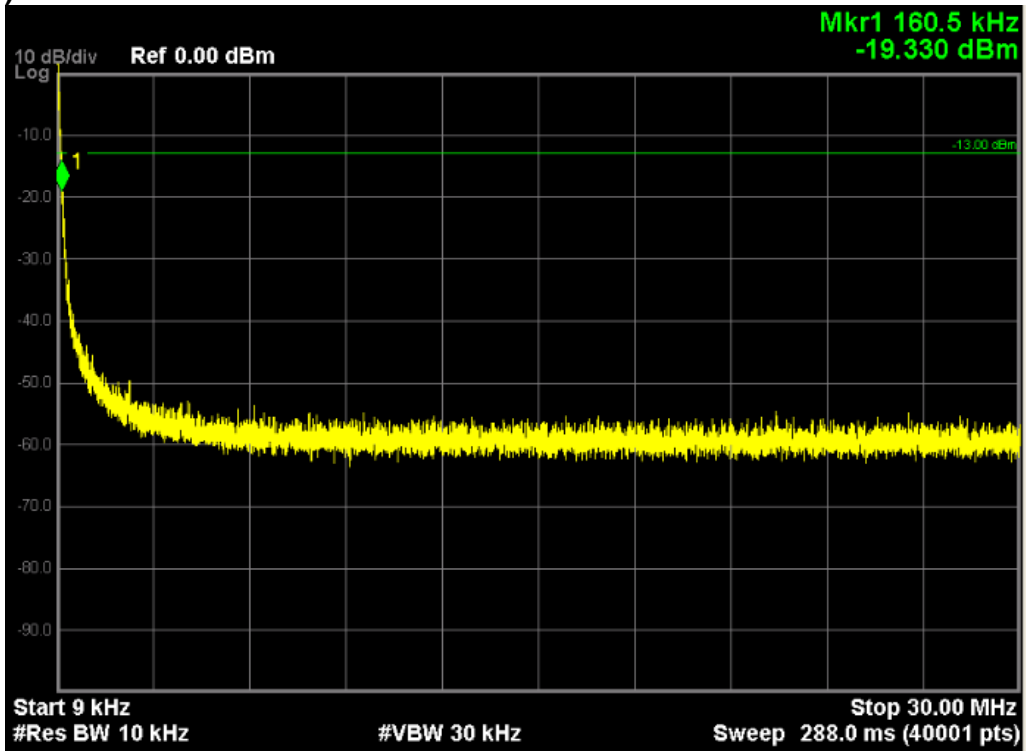

Note: The signal at point 1 is carrier

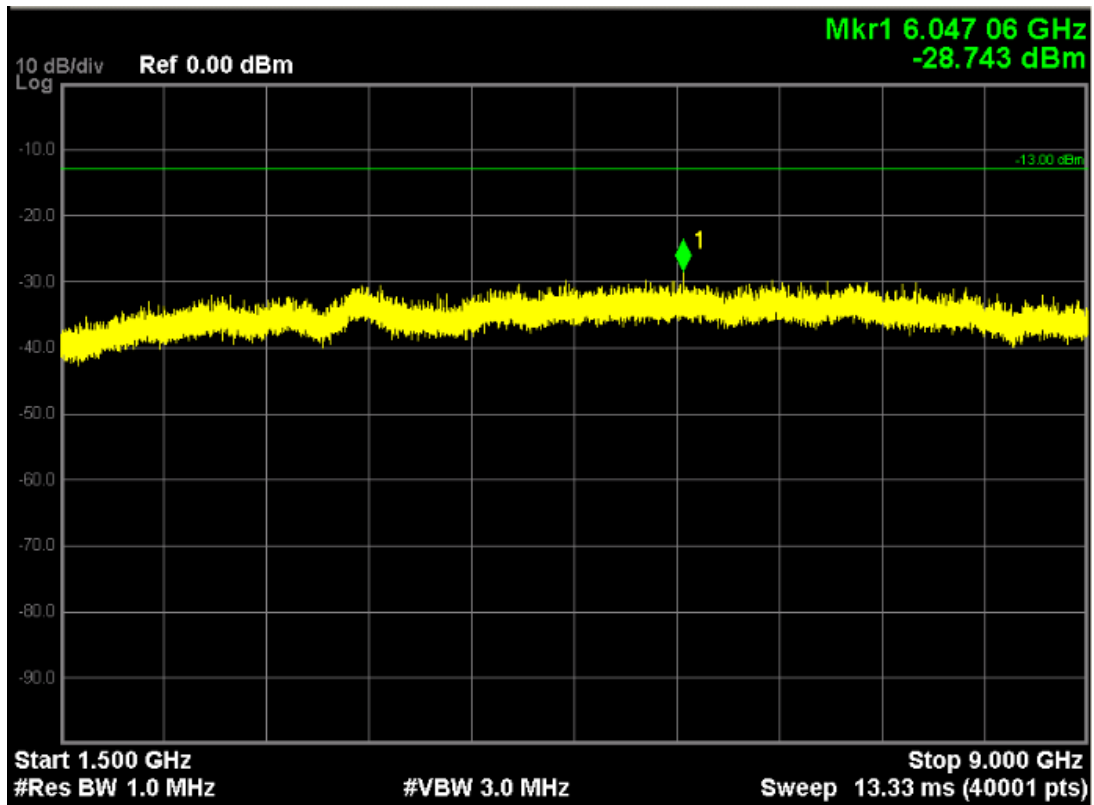
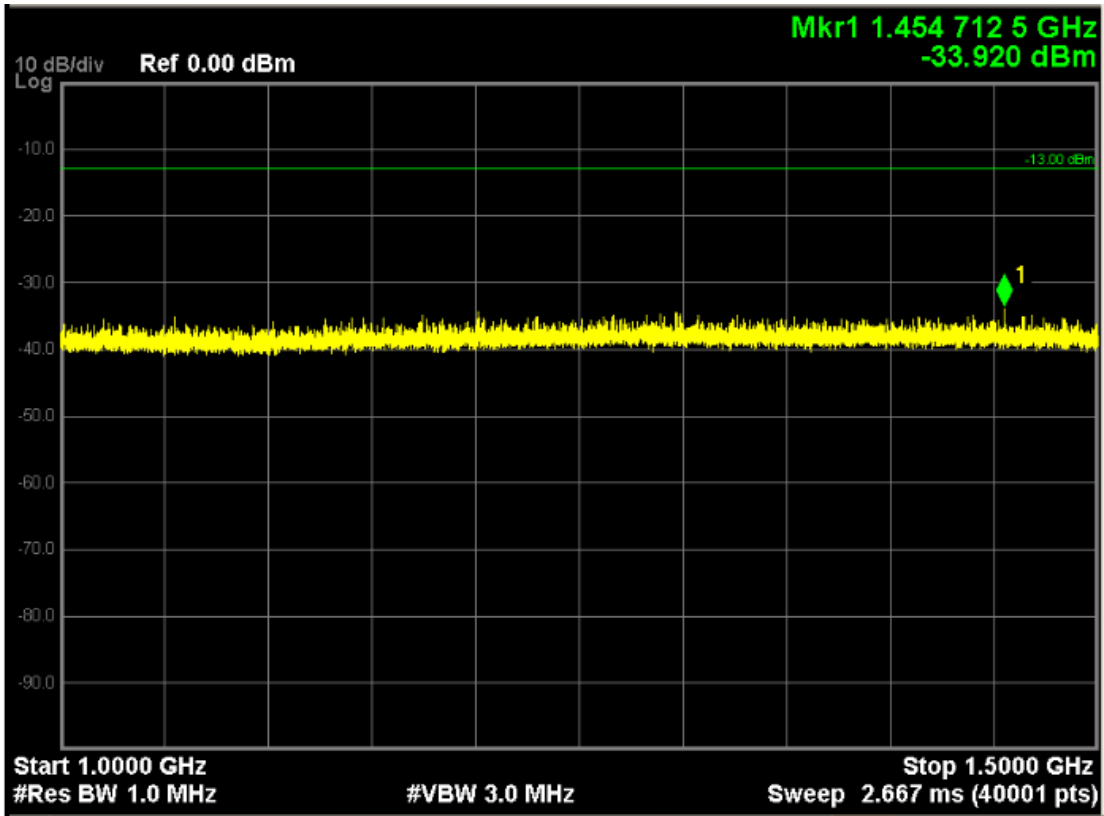

LTE Band 5 (QPSK, Band Width 5MHz,RB Size 1,RB Offset 0,Channel 20425,Frequeny 826.5MHz)

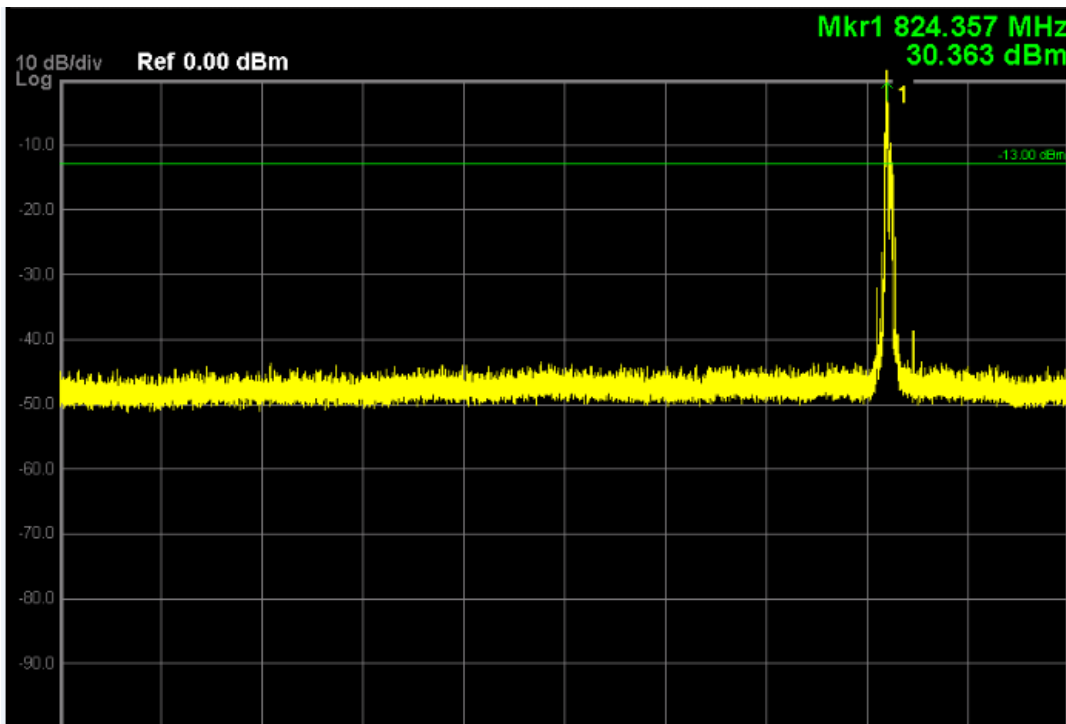
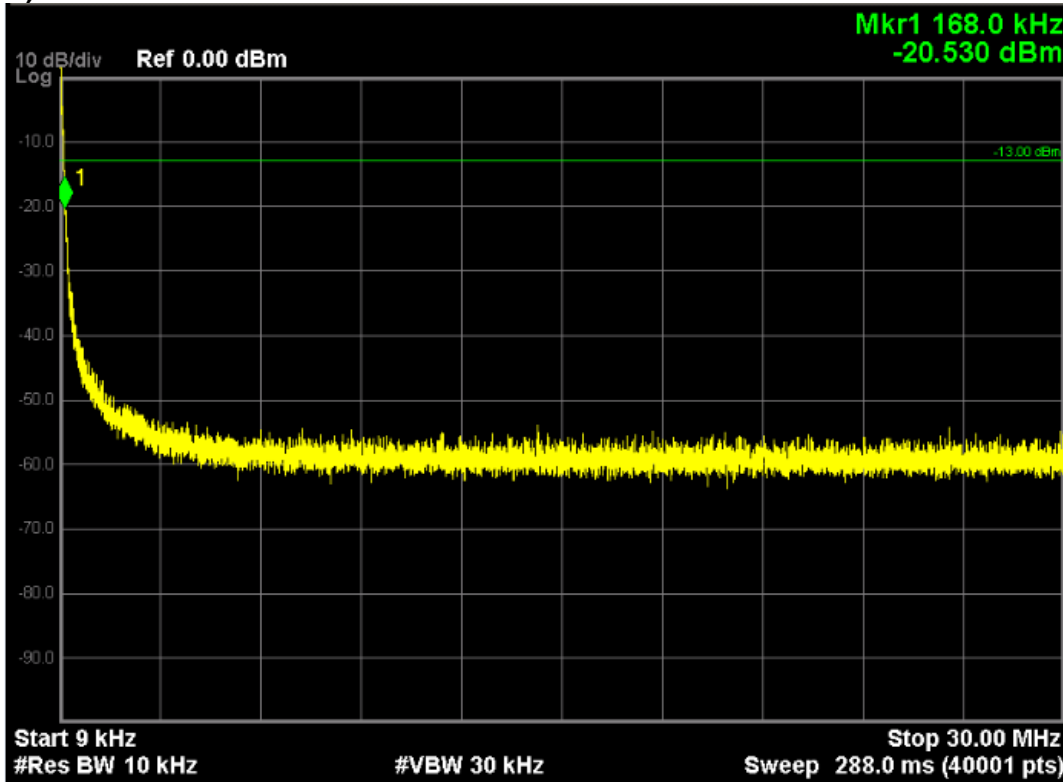

Note: The signal at point 1 is carrier

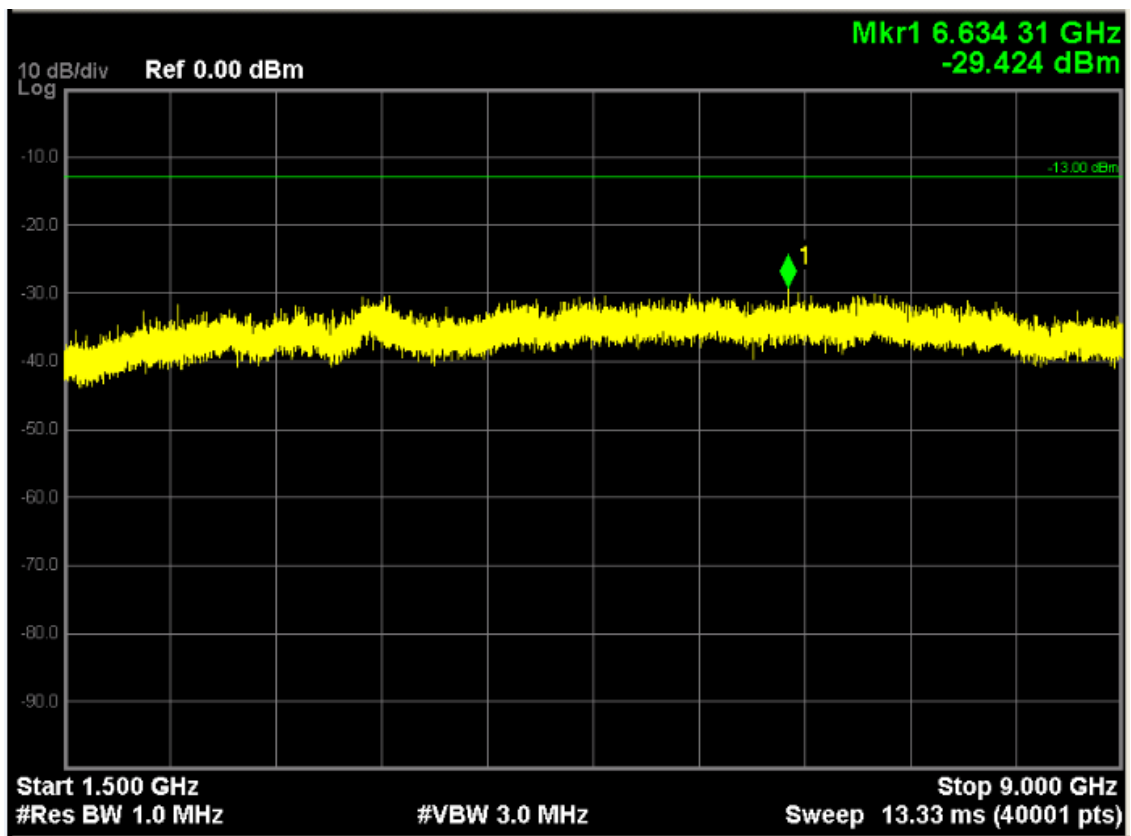
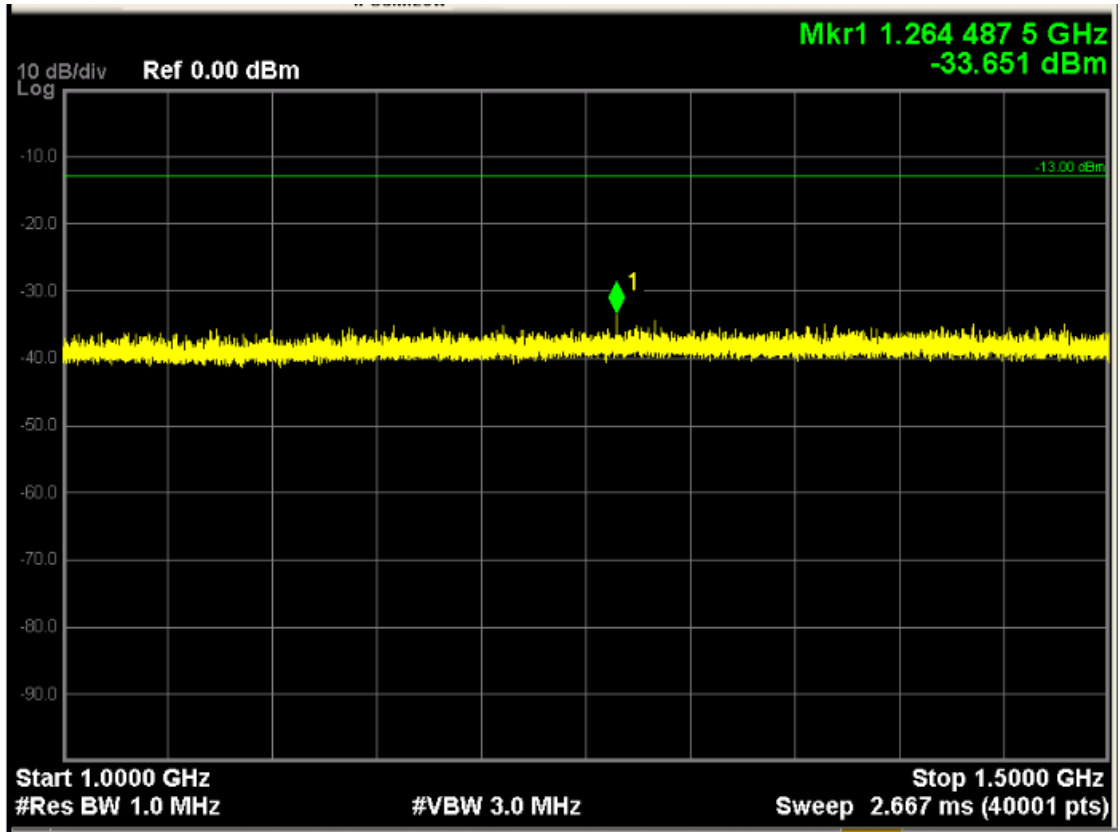

LTE Band 5 (16-QAM, Band Width 5MHz,RB Size 1,RB Offset 0,Channel 20425,Frequency 826.5MHz)

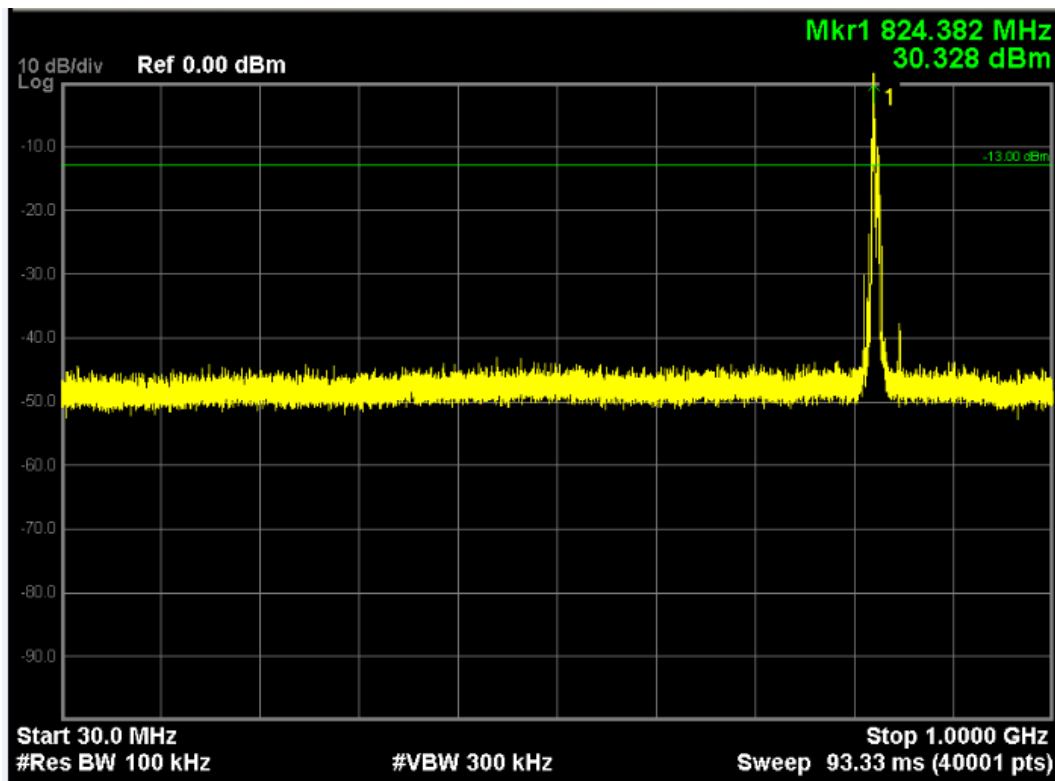
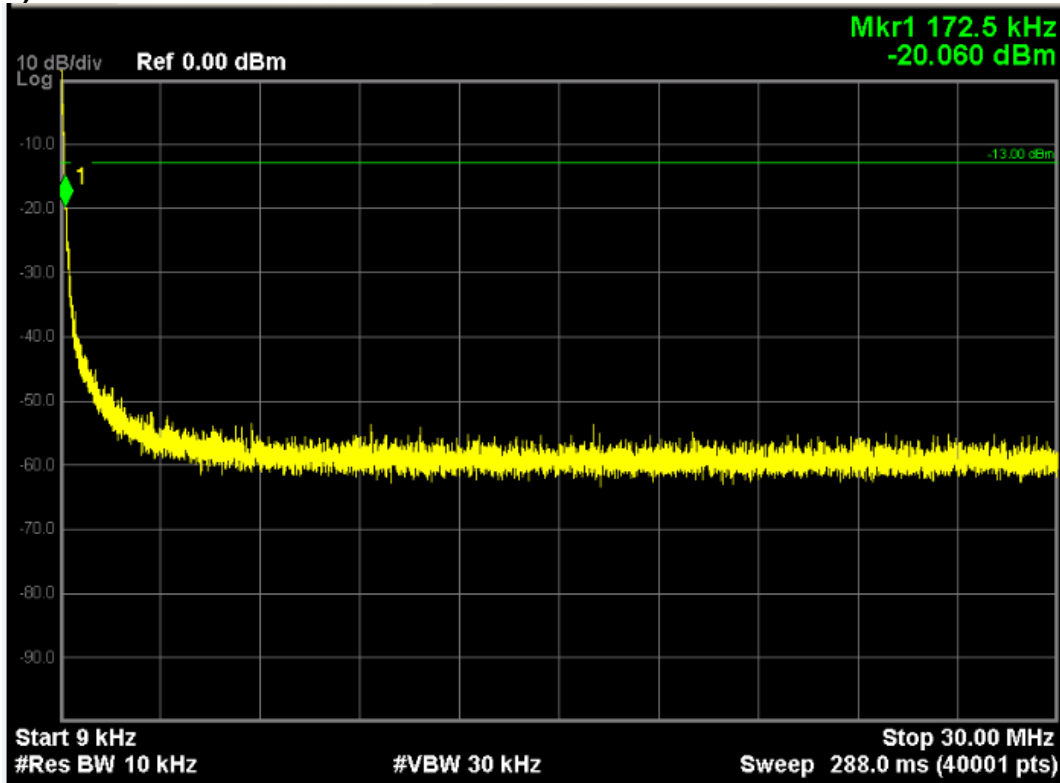

Note: The signal at point 1 is carrier

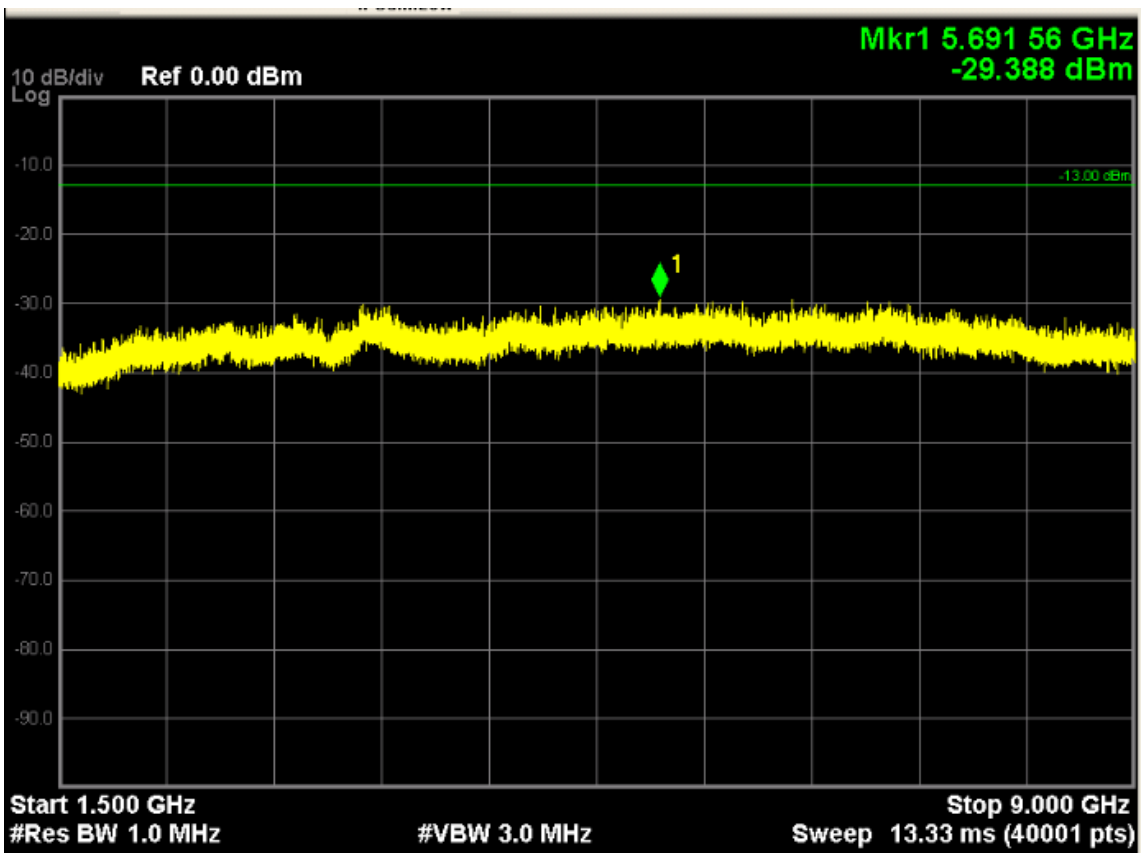
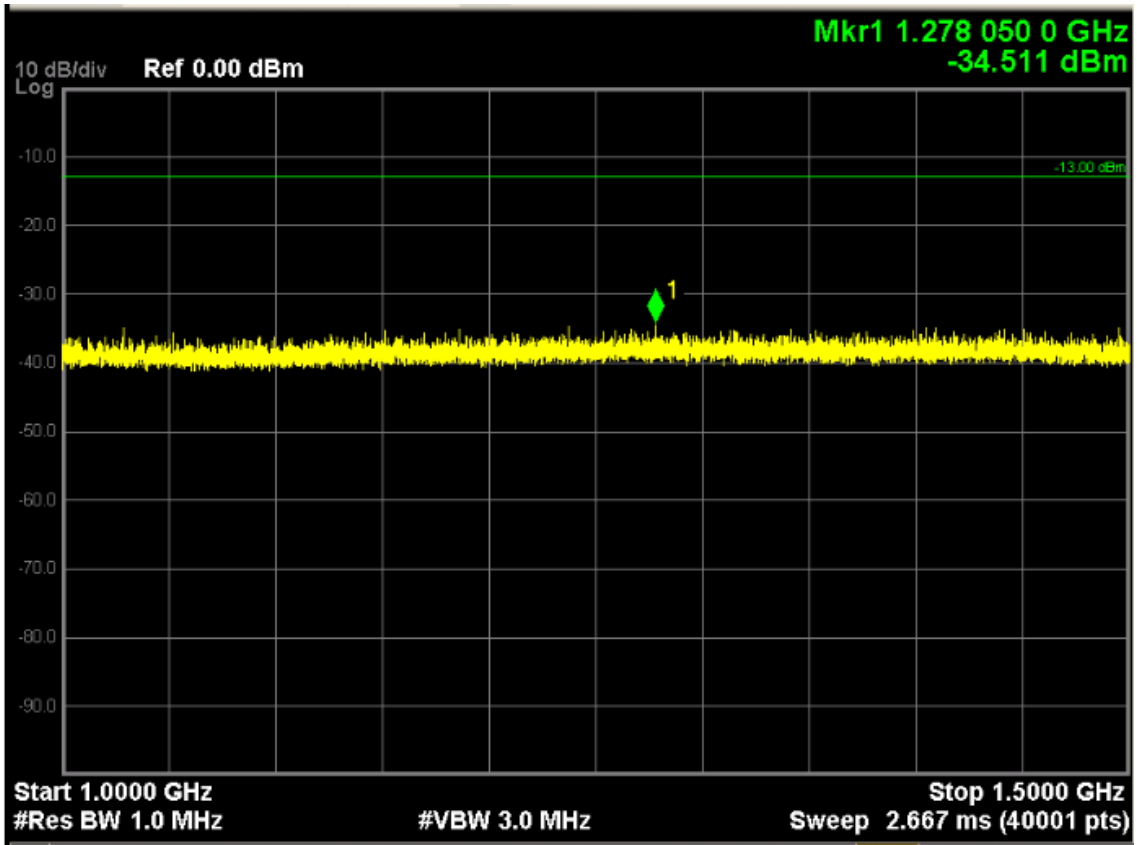

LTE Band 5 (QPSK, Band Width 10MHz, RB Size 1, RB Offset 0, Channel 20525, Frequency 836.5MHz)

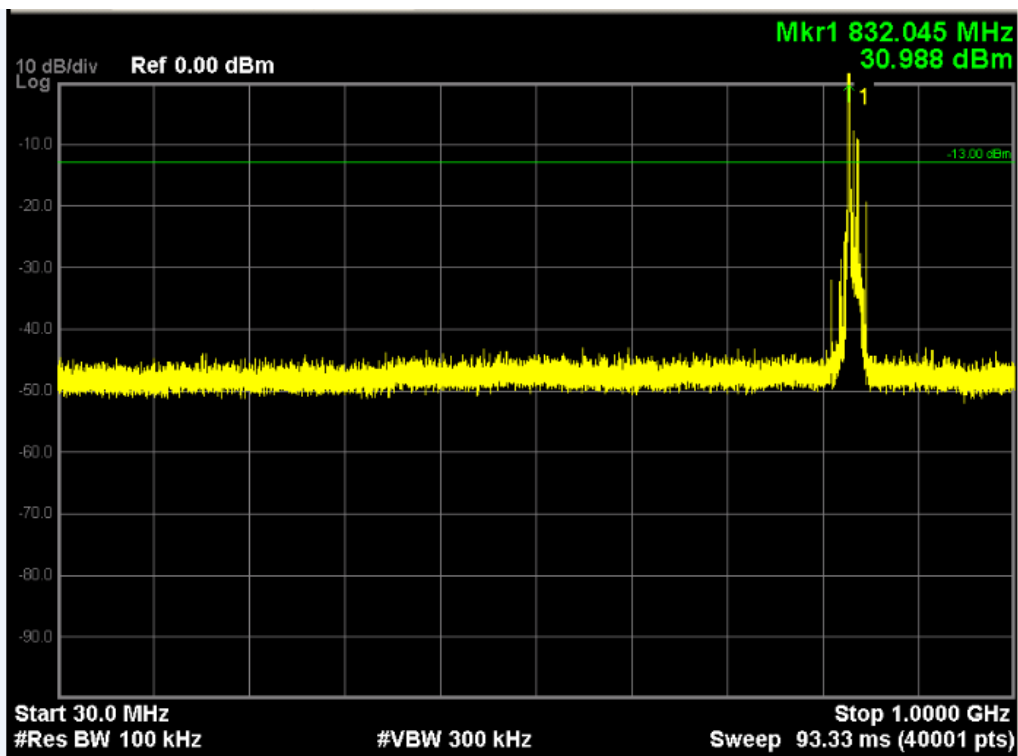
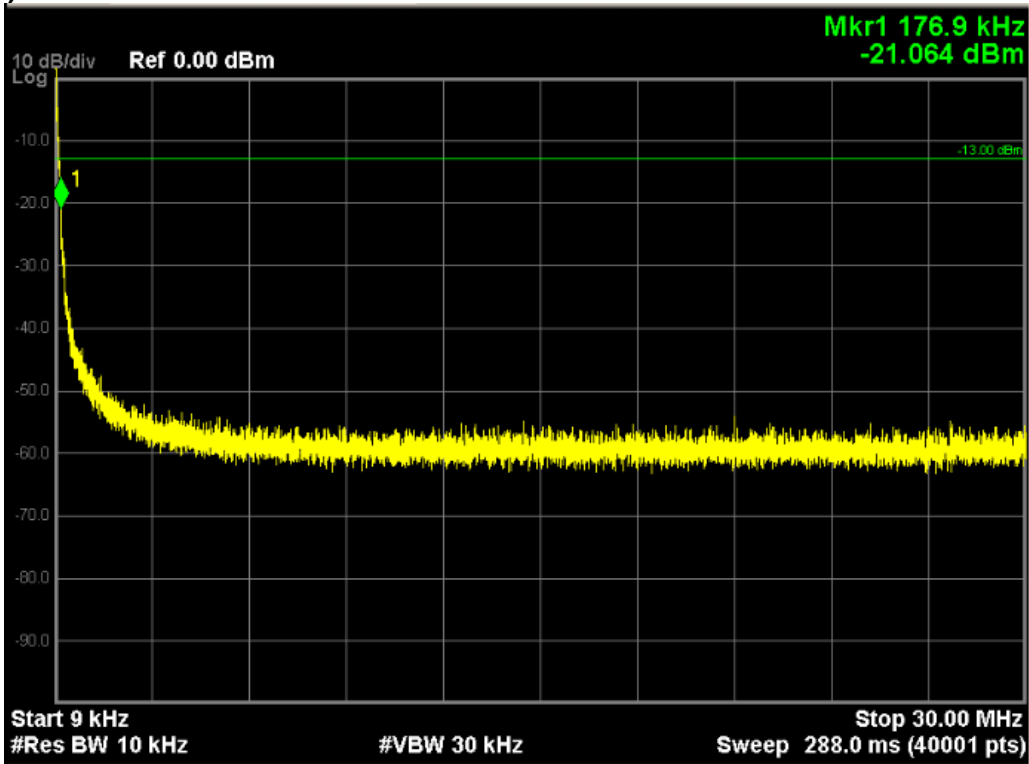

Note: The signal at point 1 is carrier

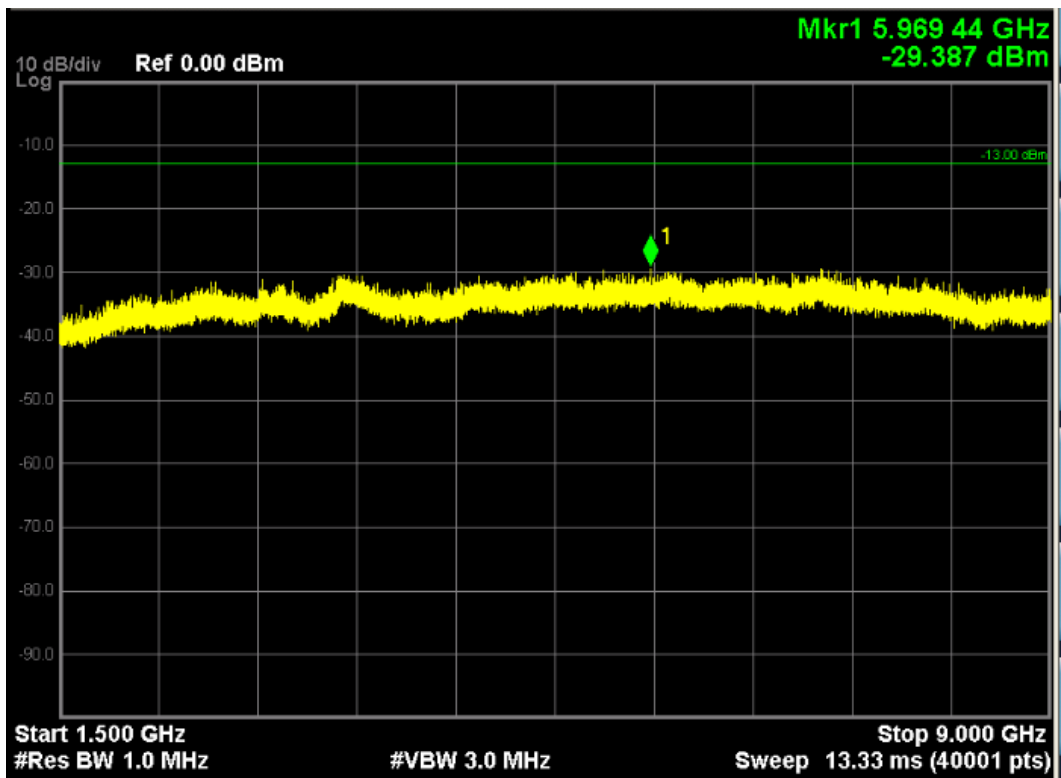
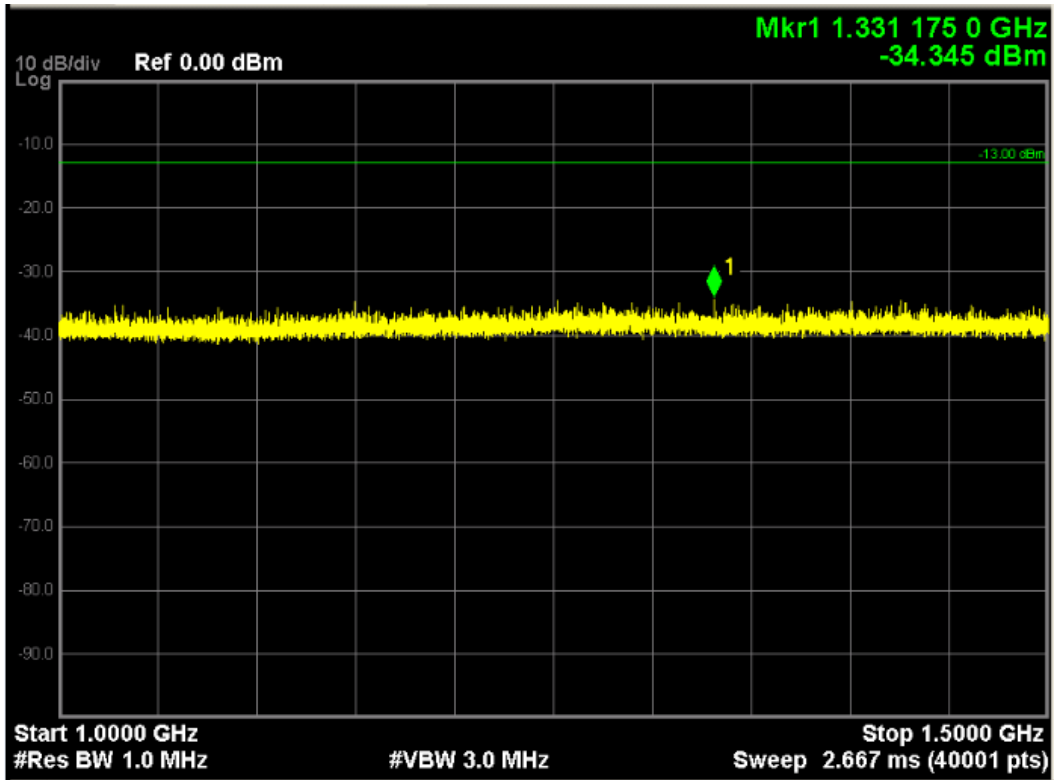

LTE Band 5 (16-QAM, Band Width 10MHz, RB Size 1, RB Offset 0, Channel 20450, Frequency 829.0MHz)

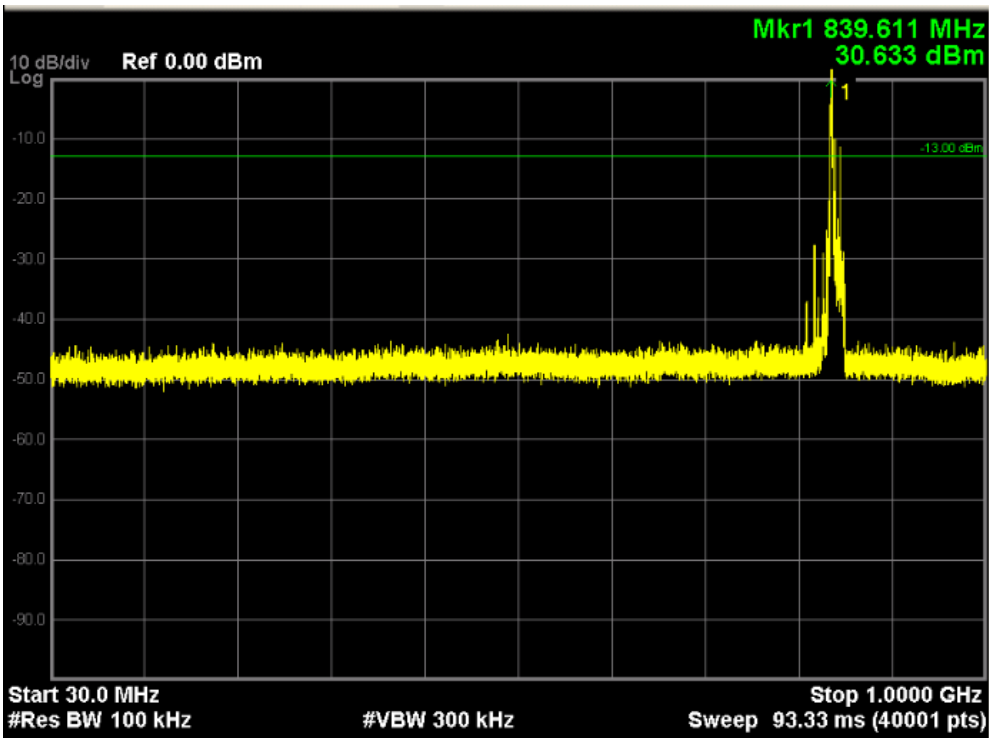
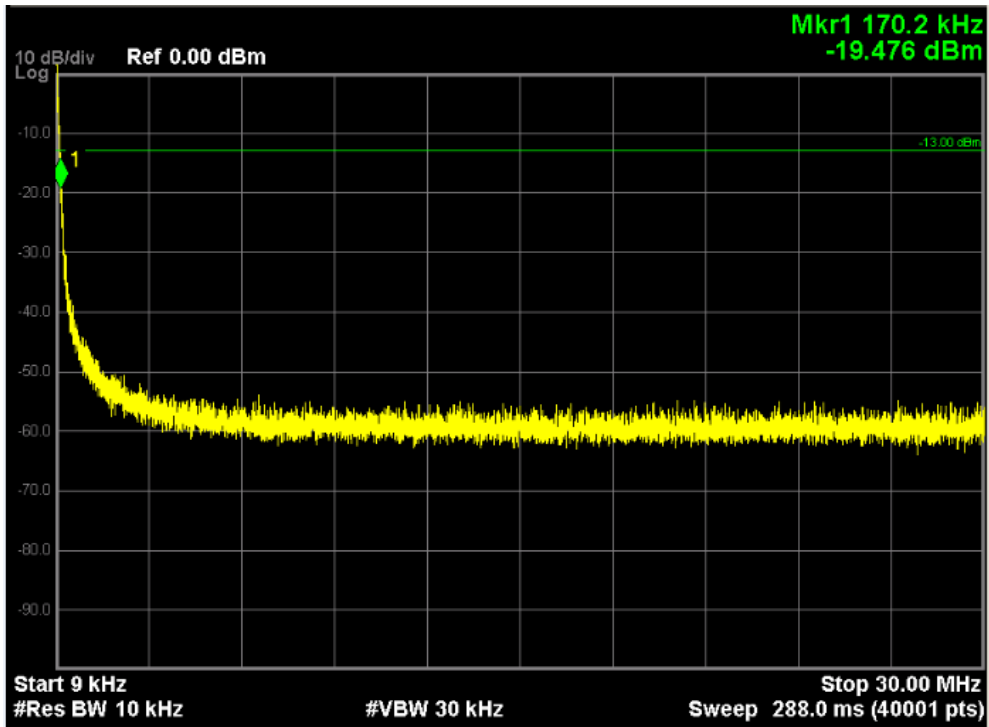

Note: The signal at point 1 is carrier

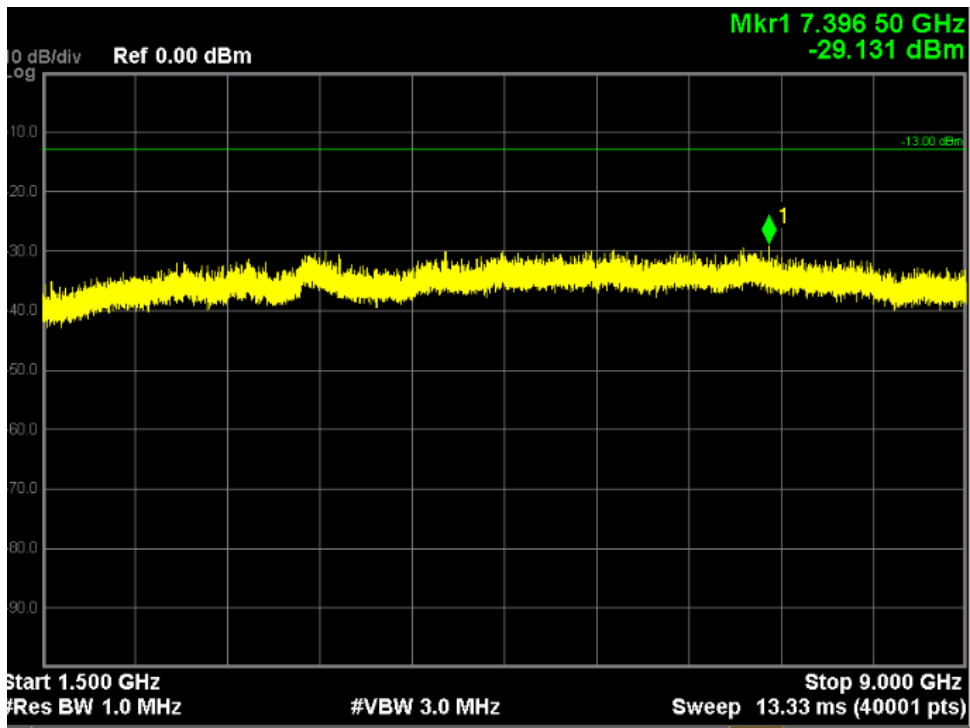
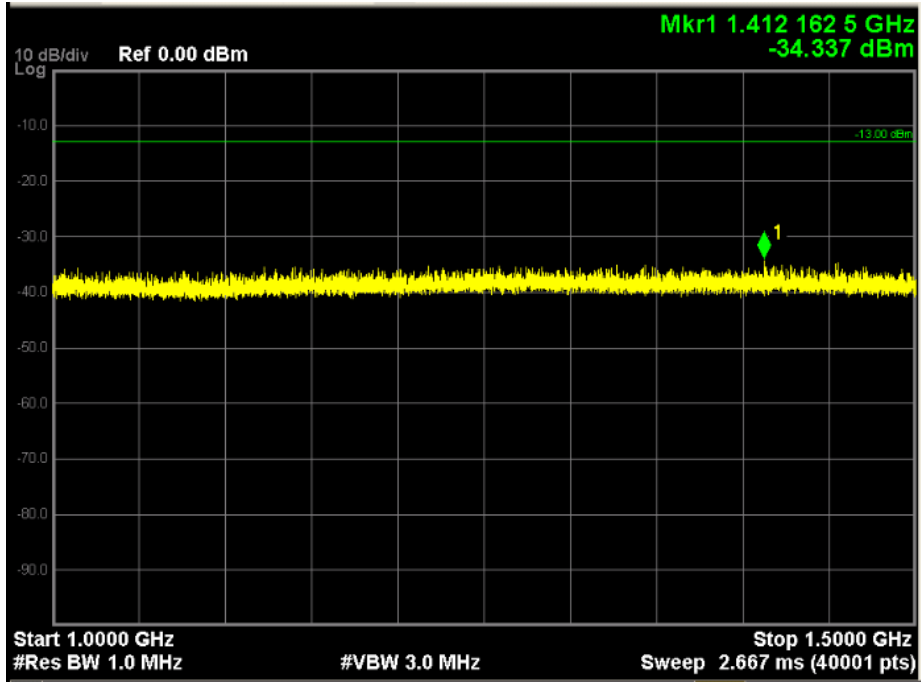

Radiated Spurious Measurement:

**LTE Band 5 (QPSK, Band Width 1.4MHz,RB Size 1,RB Offset 0,Channel 20407,Frequency 824.7MHz)
 9KHz to 30MHz**

The low frequency, which started from 9KHz to 30MHz, was pre-scanned and the result which was 20dB lower than the limit line, and that was not reported per 2.1057 (c).

30MHz to 1GHz

Frequency (MHz)	Ant. Pol. (H/V)	SG Reading (dBm)	Cable Loss (dB)	Gain (dBi)	EIRP (dBm)	Limit (dBm)	Margin (dB)
Channel 20407 (824.7MHz)							
598.6	H	-45.11	2.86	-2.44	-50.41	-13	-37.41
598.6	V	-44.55	2.86	-2.44	-49.85	-13	-36.85

Above 1GHz

Frequency (MHz)	Ant. Pol. (H/V)	SG Reading (dBm)	Cable Loss (dB)	Gain (dBi)	EIRP (dBm)	Limit (dBm)	Margin (dB)
Channel 20407 (824.7MHz)							
1650.3	H	-41.76	7.13	9.4	-38.49	-13	-25.49
1650.3	V	-42.25	7.13	9.4	-38.98	-13	-25.98
2475.1	H	-47.65	8.32	10.5	-44.47	-13	-31.47
2475.1	V	-46.55	8.32	10.5	-43.37	-13	-30.37
3297.8	H	-49.78	9.43	11.5	-46.71	-13	-33.71
3297.8	V	-48.48	9.43	11.5	-45.41	-13	-32.41

**LTE Band 5 (QPSK, Band Width 3MHz, RB Size 1, RB Offset 0, Channel 20415, Frequency 825.5MHz)
 9KHz to 30MHz**

The low frequency, which started from 9KHz to 30MHz, was pre-scanned and the result which was 20dB lower than the limit line, and that was not reported per 2.1057 (c).

30MHz to 1GHz

Frequency (MHz)	Ant. Pol. (H/V)	SG Reading (dBm)	Cable Loss (dB)	Gain (dBi)	EIRP (dBm)	Limit (dBm)	Margin (dB)
Channel 20415 (825.5MHz)							
593.1	H	-44.67	2.86	-2.44	-49.97	-13	-36.97
593.1	V	-45.54	2.86	-2.44	-50.84	-13	-37.84

Above 1GHz

Frequency (MHz)	Ant. Pol. (H/V)	SG Reading (dBm)	Cable Loss (dB)	Gain (dBi)	EIRP (dBm)	Limit (dBm)	Margin (dB)
Channel 20415 (825.5MHz)							
1651	H	-43.48	6.13	9.4	-40.21	-13	-27.21
1651	V	-45.21	6.13	9.4	-41.94	-13	-28.94
2476.5	H	-45.56	7.32	10.5	-42.38	-13	-29.38
2476.5	V	-45.32	7.32	10.5	-42.14	-13	-29.14
3302	H	-46.35	8.43	11.5	-43.28	-13	-30.28
3302	V	-48.64	8.43	11.5	-45.57	-13	-32.57

**LTE Band 5 (QPSK, Band Width 5MHz, RB Size 1, RB Offset 0, Channel 20425, Frequency 826.5MHz)
 9KHz to 30MHz**

The low frequency, which started from 9KHz to 30MHz, was pre-scanned and the result which was 20dB lower than the limit line, and that was not reported per 2.1057 (c).

30MHz to 1GHz

Frequency (MHz)	Ant. Pol. (H/V)	SG Reading (dBm)	Cable Loss (dB)	Gain (dBi)	EIRP (dBm)	Limit (dBm)	Margin (dB)
Channel 20425 (826.5MHz)							
594.2	H	-46.35	2.86	-2.44	-51.65	-13	-38.65
594.2	V	-47.34	2.86	-2.44	-52.64	-13	-39.64

Above 1GHz

Frequency (MHz)	Ant. Pol. (H/V)	SG Reading (dBm)	Cable Loss (dB)	Gain (dBi)	EIRP (dBm)	Limit (dBm)	Margin (dB)
Channel 20425 (826.5MHz)							
1654	H	-48.32	6.13	9.4	-45.05	-13	-32.05
1654	V	-47.54	6.13	9.4	-44.27	-13	-31.27
2480.5	H	-46.56	7.32	10.5	-43.38	-13	-30.38
2480.5	V	-44.23	7.32	10.5	-41.05	-13	-28.05
3307	H	-49.52	8.43	11.5	-46.45	-13	-33.45
3307	V	-48.56	8.43	11.5	-45.49	-13	-32.49

LTE Band 5 (QPSK, Band Width 10MHz,RB Size 1,RB Offset 0,Channel 20450,Frequency 829.0MHz) 9KHz to 30MHz

The low frequency, which started from 9KHz to 30MHz, was pre-scanned and the result which was 20dB lower than the limit line, and that was not reported per 2.1057 (c).

30MHz to 1GHz

Frequency (MHz)	Ant. Pol. (H/V)	SG Reading (dBm)	Cable Loss (dB)	Gain (dBi)	EIRP (dBm)	Limit (dBm)	Margin (dB)
Channel 20450 (829MHz)							
595.8	H	-47.52	2.86	-2.44	-52.82	-13	-39.82
595.8	V	-45.54	2.86	-2.44	-50.84	-13	-37.84

Above 1GHz

Frequency (MHz)	Ant. Pol. (H/V)	SG Reading (dBm)	Cable Loss (dB)	Gain (dBi)	EIRP (dBm)	Limit (dBm)	Margin (dB)
Channel 20450 (829MHz)							
1659	H	-47.65	6.13	9.4	-44.38	-13	-31.38
1659	V	-46.38	6.13	9.4	-43.11	-13	-30.11
2488	H	-49.52	7.32	10.5	-46.34	-13	-33.34
2488	V	-47.35	7.32	10.5	-44.17	-13	-31.17
3317	H	-48.34	8.43	11.5	-45.27	-13	-32.27
3317	V	-46.62	8.43	11.5	-43.55	-13	-30.55

7. Frequency Stability Under Temperature & Voltage Variations

7.1. Test Equipment

Instrument	Manufacturer	Model	Serial No.	Cali. Due Date
Spectrum Analyzer	Agilent	N9038A	MY51210142	11/05/2016
Radio Communication Tester	R&S	CMW500	147483	11/08/2016
DC Power Supply	Agilent	6612C	MY43002989	03/01/2017
Temperature Chamber	WEISS	DU/20/40	58226017340050	01/03/2017

The measure equipment had been calibrated once a year.

7.2. Test Setup

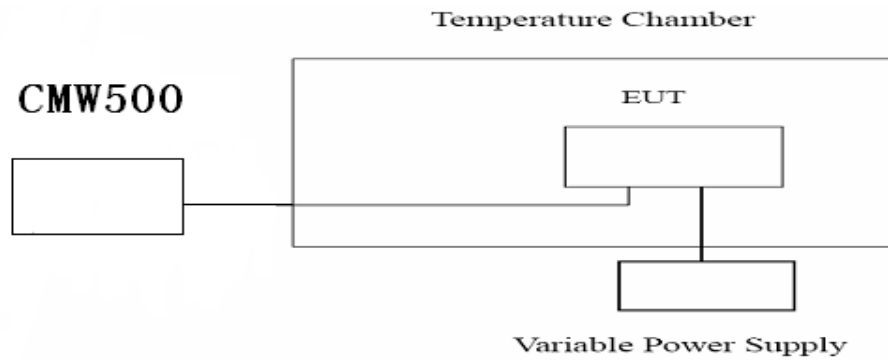

7.3. Limit

The frequency stability shall be sufficient to ensure that the fundamental emission stays within the authorized frequency block.

Limit	$< \pm 2.5$ ppm
-------	-----------------

7.4. Test Procedure

1. The testing follows FCC KDB 971168 v02v02 Section 9.0;

2. Frequency Stability Under Temperature Variations:

The equipment under test was connected to an external AC or DC power supply and input rated voltage. RF output was connected to a frequency counter or CMW500. The EUT was placed inside the temperature chamber.

EUT 20°C operating frequency as reference frequency. Turn EUT off and set the chamber temperature to -20°C. After the temperature stabilized for approximately 30 minutes recorded the frequency. Repeat step measure with 10°C increased per stage until the highest temperature of +50°C reached.

3. Frequency Stability Under Voltage Variations:

Set chamber temperature to 20°C. Use a variable AC power supply / DC power source to power the EUT and set the voltage to rated voltage.

Reduce the input voltage to specify extreme voltage variation ($\pm 15\%$) and endpoint, record the maximum frequency change.

7.5. Uncertainty

The measurement uncertainty is defined as ± 10 Hz.

7.6. Test Result

LTE Band 5 (QPSK, Band Width 1.4MHz, RB Size 1, RB Offset 0, Channel 20407)

Frequency Stability under Temperature

Temperature Interval (°C)	Test Frequency (MHz)	Deviation (Hz)	Limit(Hz)
-20	824.7	2.92	±2061.75
-10	824.7	3.26	±2061.75
0	824.7	1.30	±2061.75
10	824.7	1.95	±2061.75
20	824.7	0.89	±2061.75
30	824.7	1.87	±2061.75
40	824.7	2.27	±2061.75
50	824.7	2.42	±2061.75

Frequency Stability under Voltage

DC Voltage (V)	Test Frequency (MHz)	Deviation (Hz)	Limit(Hz)
3.0	824.7	2.31	±2061.75
3.8	824.7	2.82	±2061.75
4.5	824.7	2.29	±2061.75

LTE Band 5 (16-QAM, Band Width 1.4MHz, RB Size 1, RB Offset 0, Channel 20643)

Frequency Stability under Temperature

Temperature Interval (°C)	Test Frequency (MHz)	Deviation (Hz)	Limit(Hz)
-20	848.3	0.64	±2061.75
-10	848.3	2.16	±2061.75
0	848.3	1.23	±2061.75
10	848.3	1.92	±2061.75
20	848.3	3.02	±2061.75
30	848.3	0.84	±2061.75
40	848.3	0.67	±2061.75
50	848.3	1.34	±2061.75

Frequency Stability under Voltage

DC Voltage (V)	Test Frequency (MHz)	Deviation (Hz)	Limit(Hz)
3.0	848.3	1.26	±2061.75
3.8	848.3	1.54	±2061.75
4.5	848.3	1.53	±2061.75

LTE Band 5 (QPSK, Band Width 3MHz, RB Size 1, RB Offset 0, Channel 20415)

Frequency Stability under Temperature

Temperature Interval (°C)	Test Frequency (MHz)	Deviation (Hz)	Limit(Hz)
-20	825.5	-0.30	±2063.75
-10	825.5	-0.47	±2063.75
0	825.5	-0.72	±2063.75
10	825.5	-0.46	±2063.75
20	825.5	-1.24	±2063.75
30	825.5	-0.89	±2063.75
40	825.5	-0.62	±2063.75
50	825.5	-0.40	±2063.75

Frequency Stability under Voltage

DC Voltage (V)	Test Frequency (MHz)	Deviation (Hz)	Limit(Hz)
3.0	825.5	-0.46	±2063.75
3.8	825.5	-0.23	±2063.75
4.5	825.5	-0.33	±2063.75

LTE Band 5 (16-QAM, Band Width 3MHz, RB Size 1, RB Offset 0, Channel 20415)

Frequency Stability under Temperature

Temperature Interval (°C)	Test Frequency (MHz)	Deviation (Hz)	Limit(Hz)
-20	825.5	0.46	±2118.75
-10	825.5	1.23	±2118.75
0	825.5	1.46	±2118.75
10	825.5	0.84	±2118.75
20	825.5	0.77	±2118.75
30	825.5	0.72	±2118.75
40	825.5	0.37	±2118.75
50	825.5	0.21	±2118.75

Frequency Stability under Voltage

DC Voltage (V)	Test Frequency (MHz)	Deviation (Hz)	Limit(Hz)
3.0	825.5	0.32	±2118.75
3.8	825.5	0.52	±2118.75
4.5	825.5	0.82	±2118.75

LTE Band 5 (QPSK, Band Width 5MHz, RB Size 1, RB Offset 0, Channel 20425)

Frequency Stability under Temperature

Temperature Interval (°C)	Test Frequency (MHz)	Deviation (Hz)	Limit(Hz)
-20	826.5	1.96	±2066.25
-10	826.5	2.36	±2066.25
0	826.5	1.55	±2066.25
10	826.5	3.13	±2066.25
20	826.5	1.97	±2066.25
30	826.5	2.89	±2066.25
40	826.5	2.29	±2066.25
50	826.5	2.61	±2066.25

Frequency Stability under Voltage

DC Voltage (V)	Test Frequency (MHz)	Deviation (Hz)	Limit(Hz)
3.0	826.5	2.06	±2066.25
3.8	826.5	1.75	±2066.25
4.5	826.5	2.47	±2066.25

LTE Band 5 (16-QAM, Band Width 5MHz, RB Size 1, RB Offset 0, Channel 20425)

Frequency Stability under Temperature

Temperature Interval (°C)	Test Frequency (MHz)	Deviation (Hz)	Limit(Hz)
-20	826.5	3.75	±2066.25
-10	826.5	3.45	±2066.25
0	826.5	2.90	±2066.25
10	826.5	2.32	±2066.25
20	826.5	3.45	±2066.25
3.0	826.5	3.32	±2066.25
3.8	826.5	4.16	±2066.25
4.5	826.5	4.61	±2066.25

Frequency Stability under Voltage

DC Voltage (V)	Test Frequency (MHz)	Deviation (Hz)	Limit(Hz)
3.2	826.5	3.72	±2066.25
3.8	826.5	3.56	±2066.25
4.4	826.5	4.05	±2066.25

LTE Band 5 (QPSK, Band Width 10MHz, RB Size 1, RB Offset 0, Channel 20525)

Frequency Stability under Temperature

Temperature Interval (°C)	Test Frequency (MHz)	Deviation (Hz)	Limit(Hz)
-20	836.5	0.03	±2072.5
-10	836.5	-0.23	±2072.5
0	836.5	0.24	±2072.5
10	836.5	0.49	±2072.5
20	836.5	-0.41	±2072.5
30	836.5	-0.16	±2072.5
40	836.5	-0.79	±2072.5
50	836.5	-0.86	±2072.5

Frequency Stability under Voltage

DC Voltage (V)	Test Frequency (MHz)	Deviation (Hz)	Limit(Hz)
3.0	836.5	-0.46	±2072.5
3.8	836.5	0.92	±2072.5
4.5	836.5	0.96	±2072.5

LTE Band 5 (16-QAM, Band Width 10MHz, RB Size 1, RB Offset 0, Channel 20600)

Frequency Stability under Temperature

Temperature Interval (°C)	Test Frequency (MHz)	Deviation (Hz)	Limit(Hz)
-20	844.0	-1.07	±2072.5
-10	844.0	-0.44	±2072.5
0	844.0	-0.39	±2072.5
10	844.0	-0.30	±2072.5
20	844.0	-0.51	±2072.5
30	844.0	-0.47	±2072.5
40	844.0	-0.67	±2072.5
50	844.0	-0.16	±2072.5

Frequency Stability under Voltage

DC Voltage (V)	Test Frequency (MHz)	Deviation (Hz)	Limit(Hz)
3.0	844.0	1.47	±2072.5
3.8	844.0	1.32	±2072.5
4.5	844.0	1.96	±2072.5

8.Attachment

PHOTOGRAPHS OF TEST SETUP

Please refer to the file named "RF Setup Photos".

PHOTOGRAPHS OF EUT

Please refer to the two files named "External Photos" and " Internal Photos" .

----End of the report----