

TEST REPORT
No.: 20834387a/14-C1

According to:
FCC Regulations
Part 27

for

Gemalto M2M GmbH

Wireless Module ALS6A-E
FCC-ID: QIPALS6A-E







Laboratory Accreditation and Listings			
 DAKKS Deutsche Akkreditierungsstelle D-PL-12047-01-01	 Reg. No.: 736496 MRA US-EU 0003	 Industry Canada Reg. No.: 3462D-1 Reg. No.: 3462D-2 Reg. No.: 3462D-3	 Voluntary Controls for Electromagnetic Emissions Reg. No.: R-2666 C-2914, T-1967, G-301
 WiFi ALLIANCE AUTHORIZED RF LABORATORY	 CTIA Authorized Test Lab LAB CODE 20011130-00		
accredited according to DIN EN ISO/IEC 17025			
<p>CETECOM GmbH Laboratory Radio Communications & Electromagnetic Compatibility Im Teelbruch 116 • 45219 Essen • Germany Registered in Essen, Germany, Reg. No.: HRB Essen 8984 Tel.: + 49 (0) 20 54 / 95 19-954 • Fax: + 49 (0) 20 54 / 95 19-964 E-mail: info@cetecom.com • Internet: www.cetecom.com</p>			

Table of contents

1. SUMMARY OF TEST RESULTS.....	3
1.1. TEST OVERVIEW ACCORDING FCC PART 27	3
2. ADMINISTRATIVE DATA	5
2.1. Identification of the testing laboratory	5
2.2. Test location	5
2.3. Organizational items	5
2.4. Applicant’s details	5
2.5. Manufacturer’s details	5
3. EQUIPMENT UNDER TEST (EUT)	6
3.1. Technical data of main EUT declared by applicant	6
3.2. EUT: Type, S/N etc. and short descriptions used in this test report	7
3.3. Auxiliary Equipment (AE): Type, S/N etc. and short descriptions	7
3.4. EUT set-ups	8
3.5. EUT operating modes	8
3.6. Additional declaration and description of EUT	9
3.7. Configuration of cables used for testing	10
4. DESCRIPTION OF TEST SYSTEM SET-UP’S	11
4.1. Test system set-up for conducted measurements on antenna port	11
4.2. Test system set-up for radiated magnetic field measurements below 30 MHz	12
4.3. Test system set-up for radiated spurious emission measurements	13
5. MEASUREMENTS	14
5.1. General Limit - Radiated field strength emissions below 30 MHz	14
5.2. RF-Parameter - RF Peak power output conducted	16
5.3. RF-Parameter - Occupied bandwidth and emission bandwidth	18
5.4. RF-Parameter - RF Peak power output radiated	21
5.5. RF-Parameter - Conducted Out-of-Band RF emissions and Band Edge Emissions	23
5.6. RF-Parameter - Radiated out of Band RF emissions and Band Edge emissions	27
5.7. RF-Parameter - Frequency stability on temperature and voltage variations	31
5.8. Measurement uncertainties	38
6. ABBREVIATIONS USED IN THIS REPORT	38
7. ACCREDITATION DETAILS OF CETECOM’S LABORATORIES AND TEST SITES	39
8. INSTRUMENTS AND ANCILLARY	40
8.1. Used equipment “CTC”	40
9. VERSIONS OF TEST REPORTS (CHANGE HISTORY)	43

Table of annex

	Total pages
SEPARATE DOCUMENT: ANNEX 1 - DIAGRAMS OF TESTING	81
SEPARATE DOCUMENT: ANNEX 2 - EXTERNAL PHOTOGRAPHS OF EUT	8
SEPARATE DOCUMENT: ANNEX 3 - PHOTOGRAPHS OF MEASUREMENT SET-UP	5
SEPARATE DOCUMENT: ANNEX 4 - INTERNAL PHOTOGRAPHS OF EUT	FROM APPLICANT

The listed attachments are an integral part of this report.

1. Summary of test results

The test results apply exclusively to the test samples as presented in this Report. The CETECOM GmbH does not assume responsibility for any conclusions and generalizations taken in conjunction with other specimens or samples of the type of the item presented to tests.

The Equipment Under Test (in this report, hereinafter referred as EUT) is a digital device with no support of radiofrequency technologies. Typical operating mode was tested according unintended use of the equipment.

Following tests have been performed to show compliance with applicable FCC Part 27 of the CFR Rules Edition 1th October 2014.

1.1. TEST OVERVIEW ACCORDING FCC PART 27

No. of Diagram group	Test case	Port	References & Limits			EUT set-up	EUT op-mode	Result
			FCC Standard		Test limit			
1	AC-Power Lines Emissions Conducted (0,15 - 30 MHz)	AC-Power lines (conducted)	§15.207		§15.207 limits	--	--	Not applicable
2	General field strength emissions (9 kHz - 30 MHz)	Cabinet + inter-connecting cables (radiated)	§15.209(a)		2400/F(kHz) μ V/m 24000/F(kHz) μ V/m 30 μ V/m	2	1	Passed
7	RF-Power (ERP/EIRP)		§27.50(h)(2)		< 2 Watt (EIRP)	2	1	Passed
8	Spurious emissions		§2.1053(a) §27.53(m) (4)(6)		40+10log(P) dBc 43+10log(P) dBc 55+10log(P) dBc	2	1	Passed
9	Band-Edge compliance		§27.53(m) (4)(6)			2	1	Passed

30	RF Power	Antenna terminal (conducted)	§2.1046		N/A	1	1	passed	
34	26dB Emission bandwidth		§2.202 §2.1049 §27.53(m)(6)			26dBc Emissions BW 99% Power	1	1	For information only
35	99% Occupied bandwidth								
36	Spurious emissions		§2.1051 §27.53(m) (4)(6)			43+10log(P) dBc	1	1	passed
37	Band-Edge compliance		§27.53(m) (4)(6)			40+10log(P) dBc 43+10log(P) dBc 55+10log(P) dBc			Passed
38	Frequency stability		§2.1055(a)(1) §27.54			< ±0.1 ppm			Passed

Remarks: --

Report 20834387a/14-C1 dated 2015-03-20 substitutes report 20834387a/14 dated 2015-03-12. The substituted report gets invalid herewith.



Dipl.-Ing. Rachid Acharkaoui
Responsible for test section

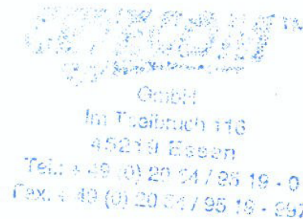

GmbH
 Im Thelbruch 113
 45219 Essen
 Tel.: +49 (0) 20 24 785 19 - 0
 Fax: +49 (0) 20 24 785 18 - 257

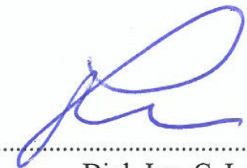

Dipl.-Ing. C. Lorenz
Responsible for test report

2. Administrative Data

2.1. Identification of the testing laboratory

Company name:	CETECOM GmbH
Address:	Im Teelbruch 116 45219 Essen - Kettwig Germany
Responsible for testing laboratory:	Dipl.-Ing. Niels Jeß
Deputy:	Dipl.-Ing. Rachid Acharkaoui

2.2. Test location

2.2.1. Test laboratory "CTC"

Company name:	see chapter 2.1. Identification of the testing laboratory
---------------	---

2.3. Organizational items

Responsible for test report and project leader:	Dipl.-Ing. C. Lorenz
Receipt of EUT:	2015-02-02
Date(s) of test:	2015-02-02 to 2015-03-12
Date of report:	2015-03-20

Version of template:	13.02

2.4. Applicant's details

Applicant's name:	Gemalto M2M GmbH
Address:	Siemensdamm 50 13629 Berlin Germany
Contact person:	Mr. Thorsten Liebig

2.5. Manufacturer's details

Manufacturer's name:	please see Applicant's details
Address:	please see Applicant's details

3. Equipment under test (EUT)

3.1. Technical data of main EUT declared by applicant

Main function	Wireless Module		
Type	ALS6A-E		
TX-frequency range (E-UTRA operating bands)	LTE Band 7: 2500 - 2570 MHz (Uplink)		
Type of modulation	QPSK, 16-QAM		
Data rates	Cat3, Downlink: max. 100Mbps, Uplink: max. 50Mbps		
Number of channels – Table 5.4.4-1 accord. 3GPP TS36.521-1	LTE Band 7 UARFCN range: 5MHz BW: 20775 - 21425 10MHz BW: 20800 - 21400 15MHz BW: 20825 - 21375 20MHz BW: 20850 - 21350		
Emission designator(s)	Channel bandwidth	QPSK Modulation:	16-QAM Modulation
	1.4 MHz	(not supported)	(not supported)
	3 MHz	(not supported)	(not supported)
	5 MHz	4M46G7D	4M46W7D
	10 MHz	8M94G7D	8M92W7D
	15 MHz	13M3G7D	13M3W7D
	20 MHz	17M8G7D	17M8W7D
Antenna Type	<input type="checkbox"/> Integrated <input type="checkbox"/> External, no RF- connector <input checked="" type="checkbox"/> External, separate RF-connector: main TX + secondary RX connector+GPS		
Antenna Gain	max. 0dBd gain		
MAX PEAK Output Power: Conducted LTE-Mode 7	28.31 dBm (PK)		
MAX PEAK Output Power: Radiated LTE-Mode 7	27.96 dBm (PK)		
FCC-ID	QIPALS6A-E		
Installed option	<input checked="" type="checkbox"/> GPS (not tested within this test report)		
Power supply	<input checked="" type="checkbox"/> DC power only: 9-12 Volt on DSB75-Adapter Converted to voltage range of 3.5 V to 4.3 V by DSB75-Adapter board		
Special EMI components	--		
EUT sample type	<input type="checkbox"/> Production	<input checked="" type="checkbox"/> Pre-Production	<input type="checkbox"/> Engineering
FCC label attached	<input type="checkbox"/> yes	<input checked="" type="checkbox"/> no	

3.2. EUT: Type, S/N etc. and short descriptions used in this test report

Short description*)	EUT	Type	S/N serial number	HW hardware status	SW software status
EUT A	Wireless Module	ALS6A-E	IMEI: 004401 08 1034643	B2 (Rev. 4.2)	01.270

*) EUT short description is used to simplify the identification of the EUT in this test report.

3.3. Auxiliary Equipment (AE): Type, S/N etc. and short descriptions

AE short description *)	Auxiliary Equipment	Type	S/N serial number	HW hardware status	SW software status
AE 1	SMARTEQ MiniMag. mount antenna 1	2.6m RG174, SMA-m 0dBd, 824-960 / 1710-2170MHz	59801B	1140.26 SMA	--
AE 2	SMARTEQ MiniMag. mount antenna 2	2.6m RG174, SMA-m 0dBd, 824-960 / 1710-2170MHz	59801B	1140.26 SMA	--
AE 3	SMARTEQ MiniMag. mount antenna 1	2.6m RG174, SMA-m 0dBd, 824-960 / 1710-2170MHz	59801B	1140.26 SMA	--
AE 4	DSB75-Adapter	DSB75	W30880-Q9812-X-2	AH6-DSB75-1	--
AE 5	Handset Votronic	Telephone receiver with RJ11 connector	4017953211 311	HH-SI-30.3/V3.0/0	--
AE 6	USB cable	1m	--	--	--
AE 7	CETECOM Notebook	Dell Latitude E6420	CTC01034	--	Windows 7 + Terminal Program + Driver USB

*) AE short description is used to simplify the identification of the auxiliary equipment in this test report.

3.4. EUT set-ups

EUT set-up no. *)	Combination of EUT and AE	Remarks
set. 1	EUT A + AE 4 + AE 5 + AE 6 + (AE 7)	Conducted tests performed: AT commands set the device into operating mode conditions with help of AE7. AE7 is not connected to the EUT during tests
set. 2	EUT A + AE 1 + A 2 + AE 3 + AE 4 + AE 5 + AE 6 + (AE 7)	Radiated tests performed: AT commands set the device into operating mode conditions with help of AE7. AE7 is not connected to the EUT during tests

*) EUT set-up no. is used to simplify the identification of the EUT set-up in this test report.

3.5. EUT operating modes

EUT operating mode no. *)	Description of operating modes	Additional information
op. 1	LTE-Band 7 RMC Mode	A communication link is established between the mobile station (UE) and the test simulator. The transmitter is operated on its maximum rated output power class: 23dBm nominal. The input signal to the receiver is modulated with normal test modulation: QPSK or 16-QAM Modulation. The wanted RF input signal level to the receiver of the mobile station is set to a level to provide a stable communication link.

*) EUT operating mode no. is used to simplify the test report.

3.6. Additional declaration and description of EUT

(Applicant's declaration, = not selected, = selected)

EUT A		<input type="checkbox"/> table-top <input type="checkbox"/> floor-standing <input type="checkbox"/> wall-mounted <input checked="" type="checkbox"/> not defined	typical use <input type="checkbox"/> portable use <input type="checkbox"/> fixed use <input type="checkbox"/> vehicular use <input checked="" type="checkbox"/> general	typical operating cycle of EUT. <input checked="" type="checkbox"/> < 0,5 sec. <input type="checkbox"/> :
Place of use		<input type="checkbox"/> Residential, commercial and light industry <input type="checkbox"/> Industrial environment <input type="checkbox"/> vehicular use <input checked="" type="checkbox"/> general		
Highest frequency generated or used in the device or on which the device operates or tunes		<input type="checkbox"/> below 1.705 MHz -> up to 30 MHz <input type="checkbox"/> 1.705 MHz – 108 MHz -> up to 1 GHz <input type="checkbox"/> 108 MHz -500 MHz -> up to 2 GHz <input type="checkbox"/> 500MHz 1000 MHz -> up to 5 GHz <input checked="" type="checkbox"/> Above 1000 MHz -> 5 th harmonic or 40 GHz		
Power line: <input type="checkbox"/> AC <input type="checkbox"/> L1, <input type="checkbox"/> L2, <input type="checkbox"/> L3, <input type="checkbox"/> N _____Hz <input type="checkbox"/> 12V, <input type="checkbox"/> 24V, <input type="checkbox"/> 230V, <input type="checkbox"/> 400V <input checked="" type="checkbox"/> DC <input checked="" type="checkbox"/> Range 3.5 to 4.3 V over AE4 Tested at 4.1V DC Internally regulated		EUT-grounding: <input checked="" type="checkbox"/> none <input type="checkbox"/> with power supply <input type="checkbox"/> additional: <p style="text-align: right;">(in case of deviation during tests the single details are described on chapter 4)</p>		
Other Ports		possible total cable length	shielding	connected during test
(description of interconnecting cables)				
Connector				
1. Antenna Main	SMA	<input checked="" type="checkbox"/> < 3m <input type="checkbox"/> > 3m <input type="checkbox"/> : other	<input checked="" type="checkbox"/> screened <input type="checkbox"/> unscreened	<input checked="" type="checkbox"/> yes <input type="checkbox"/> no
2. Antenna Second	SMA	<input checked="" type="checkbox"/> < 3m <input type="checkbox"/> > 3m <input type="checkbox"/> : other	<input checked="" type="checkbox"/> screened <input type="checkbox"/> unscreened	<input checked="" type="checkbox"/> yes <input type="checkbox"/> no
3. GPS -line	SMA	<input checked="" type="checkbox"/> < 3m <input type="checkbox"/> > 3m <input type="checkbox"/> : other	<input checked="" type="checkbox"/> screened <input type="checkbox"/> unscreened	<input checked="" type="checkbox"/> yes <input type="checkbox"/> no
4. USB-line	Mini-USB	<input checked="" type="checkbox"/> < 3m <input type="checkbox"/> > 3m <input type="checkbox"/> : other	<input type="checkbox"/> screened <input type="checkbox"/> unscreened	<input checked="" type="checkbox"/> yes <input type="checkbox"/> no
5. RJ11 Handset Line		<input checked="" type="checkbox"/> < 3m <input type="checkbox"/> > 3m <input type="checkbox"/> : other	<input type="checkbox"/> screened <input checked="" type="checkbox"/> unscreened	<input checked="" type="checkbox"/> yes <input type="checkbox"/> no
Does EUT contain devices susceptible to magnetic fields, e.g. Hall elements, electrodynamics microphones, etc.?				<input type="checkbox"/> yes <input checked="" type="checkbox"/> no
Is mounting position / usual operating position defined?				<input type="checkbox"/> yes <input checked="" type="checkbox"/> no

3.7. Configuration of cables used for testing

Cable number	Item	Type	S/N serial number	HW hardware status	Cable length
Cable 1	USB Port	--	--	--	1 m
Cable 2	RJ11 handset line	--	--	--	1.5 m
Cable 3	RF-antenna port 1 (main)	--	--	--	1.5 m
Cable 4	RF-antenna port 2 (secondary)	--	--	--	1.5 m
Cable 5	RF-antenna port 3 (GPS)	--	--	--	1.5 m

4. Description of test system set-up's

4.1. Test system set-up for conducted measurements on antenna port

Specification: ANSI 63-10:2009

General Description: The EUT's RF-signal is coupled out by a suitable antenna coupling connector (1). The signal is first attenuated (2) before it is 0° divided by a power divider (3). One of the signal path is connected to the radio communication tester (4), other branch is connected to the spectrum – analyzer (5). The specific attenuation losses for both signal paths/branches are determined prior to the measurement within a set-up calibration. These are then taken into account by correcting the measurement readings on the spectrum-analyzer.

Schematic:

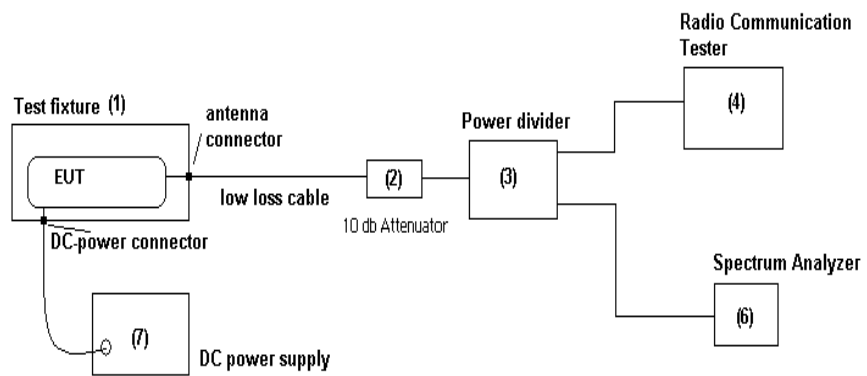

4.2. Test system set-up for radiated magnetic field measurements below 30 MHz

Specification: ANSI C63.4-2009 chapter 8.2.1, ANSI C63.10-2009 chapter 6.4

General Description: Evaluating the radiated field emissions are done first by an exploratory emission measurement and a final measurement for most critical frequencies determined.

The loop antenna was placed at 1 m height above ground plane and 3 m measurement distance from set-up for investigations. Because of reduced measurement distance, correction data were applied, as stated in chapter “General Limit - Radiated field strength emissions below 30 MHz“. The tests are performed in the semi anechoic room recognized by the regulatory commission.

Schematic:

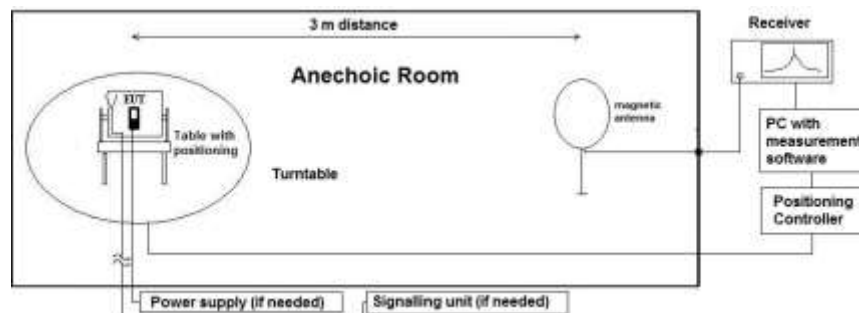

Testing method:

Exploratory, preliminary measurement

The EUT and its associated accessories are placed on a non-conductive position manipulator (tipping device) of 0.8 m height which is placed on the turntable. By rotating the turntable (step 90°, range 0° to 360°) and the EUT itself either on 3-orthogonal axis (portable equipment) or 2-orthogonal axis (defined operational position of EUT), the emission spectrum was recorded. The loop antenna was moved at least to 2-perpendicular axes (antenna vector in direction of EUT and parallel to EUT) in order to maximize the emissions. The results are documented in a diagram. Critical frequencies (low margin to limit) are saved within a data reduction table for further investigations. If various operating modes are supported, further investigations are made to find the worst-case. Also the interconnection cables and equipment position were varied in order to maximize the emissions.

Final measurement on critical frequencies

Based on the exploratory measurements, the most critical frequencies are re-measured by maintaining the EUT's worst-case operation mode, cable position, etc.

First a frequency zoom around the critical frequency is done to locate the frequency more precisely. After this step, for all identified critical frequencies, the maximum peak was determined.

Following parameters were varied: the turntable angle continuously in the range 0 to 360 degree, the EUT itself either over 3-orthogonal axis (not defined usage position) or 2-orthogonal axis (defined usage position).

On the determined worst-case position, a final measurement with necessary bandwidth and detector according standard has been carried out.

Formula:

$$E_C = E_R + AF + C_L + D_F - G_A$$

$$M = L_T - E_C$$

AF = Antenna factor

C_L = Cable loss

D_F = Distance correction factor

E_C = Electrical field – corrected value

E_R = Receiver reading

G_A = Gain of pre-amplifier (if used)

L_T = Limit

M = Margin

All units are dB-units, positive margin means value is below limit.

Distance correction:

Reference for applied correction (extrapolating) factors:

IEEC Transaction EMC, Vol. 47, No. 3, Aug. 2005, Journal Paper

“*Extrapolating Near-field emissions of low frequency loop transmitters*”.

4.3. Test system set-up for radiated spurious emission measurements

Specification:

ANSI C63.4-2009 chapter 8, ANSI C63.10-2009 chapter 6.5&6.6

General Description:

Evaluating the field emissions have to be done first by an exploratory emissions measurement and a final measurement for most critical frequencies. The tests are performed in a CISPR 16-4 compliant fully anechoic room (FAR) recognized by the regulatory commission. The measurement distance was set to 3 meter for frequencies up to 20 GHz and 1 meter above 20 GHz. A logarithmic periodic antenna is used for the frequency range 30 MHz to 1 GHz. The horn antenna is used for frequency range 1 GHz to 40 GHz. Due to use of a fully anechoic room the measurement antennas are set to fixed antenna height of 1.55 m (no height scan necessary) and the site validation criteria accord. ANSI63.10:2009 is fulfilled. The EUT is aligned within 3 dB beam width of the measurement antenna, on big EUTs several surface measurements are performed.

Schematic:

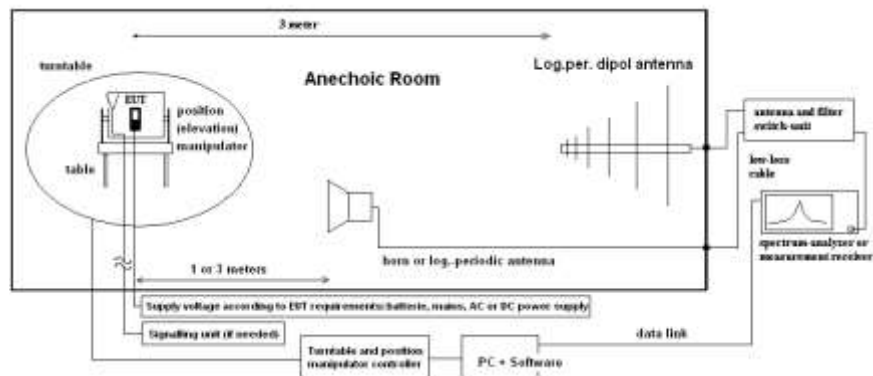

Testing method:

Exploratory, preliminary measurements

The EUT and its associated accessories are placed on a non-conductive position manipulator (tipping device) of 1.55 m height which is placed on the turntable. By rotating the turntable (range 0° to 360°, step 45°) and the EUT itself either on 3-orthogonal axis (portable equipment) or 2-orthogonal axis (defined operational position of EUT) the emission spectrum and its characteristics was recorded with an EMI-receiver, broadband antenna and software. The measurements are performed in horizontal and vertical polarization of the measurement antennas. The results are documented in a diagram. Critical frequencies (low margin to limit) are saved within a table for further investigations. If various operating modes are supported, further investigations are made to find the worst-case of them. Also the interconnection cables and equipment position were varied in order to maximize the emissions.

Final measurement on critical frequencies

Based on the exploratory measurements, the most critical frequencies are re-measured by maintaining the EUT's worst-case operation mode, cable position, etc. First a frequency zoom around the critical frequency is done to locate the frequency more precisely. After this step, for all identified critical frequencies, the maximum peak was determined. Following parameters were varied: the turntable angle continuously in the range 0 to 360 degree, the EUT itself either over 3-orthogonal axis (not defined usage position) or 2-orthogonal axis (defined usage position). The measurement antenna height is fixed to 1.55 m. On the determined worst-case position, a final measurement with necessary bandwidth and detector according standard has been carried out. The readings on the spectrum analyzer are corrected with conversion value between field strength and E(I)RP, so the readings shown are equivalent to ERP/EIRP values. Critical measurements near the limit are re-measured with a substitution method accord. ANSI/TIA/EIA 603 C/D

Formula:

$$E_C = E_R + AF + C_L + D_F - G_A \quad (1)$$

$$E_{C_{E(I)RP}} = E_C - 95.2 \text{ dB}$$

$$M = L_T - E_{C_{E(I)RP}}$$

E_C = Electrical field – corrected value

E_R = Receiver reading

M = Margin

L_T = Limit

AF = Antenna factor

C_L = Cable loss

D_F = Distance correction factor (if used)

G_A = Gain of pre-amplifier (if used)

$E_{C_{E(I)RP}}$ = Electrical field corrected for E(I)RP

All units are dB-units, positive margin means value is below limit.

5. Measurements

5.1. General Limit - Radiated field strength emissions below 30 MHz

5.1.1. Test location and equipment

test location	<input checked="" type="checkbox"/> CETECOM Essen (Chapter. 2.2.1)	<input type="checkbox"/> Please see Chapter. 2.2.2	<input type="checkbox"/> Please see Chapter. 2.2.3
test site	<input checked="" type="checkbox"/> 441 EMI SAR	<input type="checkbox"/> 487 SAR NSA	<input type="checkbox"/> 347 Radio.lab.
receiver	<input type="checkbox"/> 377 ESCS30	<input checked="" type="checkbox"/> 001 ESS	<input type="checkbox"/>
spectr. analys.	<input type="checkbox"/> 584 FSU	<input type="checkbox"/> 120 FSEM	<input type="checkbox"/> 264 FSEK
antenna	<input type="checkbox"/> 574 BTA-L	<input type="checkbox"/> 133 EMCO3115	<input type="checkbox"/> 302 BBHA9170
signaling	<input type="checkbox"/> 392 MT8820A	<input type="checkbox"/> 371 CBT32	<input type="checkbox"/> 547 CMU
otherwise	<input type="checkbox"/> 400 FTC40x15E	<input type="checkbox"/> 401 FTC40x15E	<input type="checkbox"/> 110 USB LWL
DC power	<input type="checkbox"/> 456 EA 3013A	<input type="checkbox"/> 457 EA 3013A	<input type="checkbox"/> 459 EA 2032-50
line voltage	<input type="checkbox"/> 230 V 50 Hz via public mains	<input checked="" type="checkbox"/> 060 120 V 60 Hz via PAS 5000	<input type="checkbox"/> 289 CBL 6141
			<input checked="" type="checkbox"/> 030 HFH-Z2
			<input type="checkbox"/> 477 GPS
			<input type="checkbox"/> 482 Filter Matrix
			<input type="checkbox"/> 378 RadiSense
			<input type="checkbox"/> 494 AG6632A
			<input type="checkbox"/> 498 NGPE 40

5.1.2. Requirements

FCC	Part 15, Subpart C, §15.205 & §15.209		
ANSI	C63.10-2009		
Frequency [MHz]	Field strength limit [μ V/m]	Distance [m]	Remarks
0.009 – 0.490	2400/f (kHz)	67.6 – 20Log(f) (kHz)	300
0.490 – 1.705	24000/f (kHz)	87.6 – 20Log(f) (kHz)	30
1.705 – 30	30	29.5	30

5.1.3. Test condition and test set-up

Signal link to test system (if used):	<input checked="" type="checkbox"/> air link	<input type="checkbox"/> cable connection	<input type="checkbox"/> none
EUT-grounding	<input checked="" type="checkbox"/> none	<input type="checkbox"/> with power supply	<input type="checkbox"/> additional connection
Equipment set up	<input checked="" type="checkbox"/> table top	<input type="checkbox"/> floor standing	
Climatic conditions	Temperature: (22 \pm 3°C)		Rel. humidity: (40 \pm 20)%
EMI-Receiver or Analyzer Settings	Scan data	<input checked="" type="checkbox"/> 9 – 150 kHz RBW/VBW = 200 Hz Scan step = 80 Hz <input checked="" type="checkbox"/> 150 kHz – 30 MHz RBW/VBW = 9 kHz Scan step = 4 kHz <input type="checkbox"/> other:	
	Scan-Mode Detector Mode: Sweep-Time	<input checked="" type="checkbox"/> 6 dB EMI-Receiver Mode <input type="checkbox"/> 3dB Spectrum analyser Mode Peak (pre-measurement) and Quasi-PK/Average (final if applicable) Repetitive-Scan, max-hold Coupled – calibrated display if continuous signal otherwise adapted to EUT’s individual transmission duty-cycle	
General measurement procedures	Please see chapter “Test system set-up radiated magnetic field measurements below 30 MHz”		

5.1.4. Measurement Results

The results are presented below in summary form only. For more information please see the diagrams.

Table of measurement results:

Diagram No.	Carrier Channel		Frequency range	Set-up no.	OP-mode no.	Remark	Used detector			Result
	Range	No.					PK	AV	QP	
2.01_ Ch20825	Low	20825	9 kHz-30 MHz	2	1	15MHz Signal bandwidth used	<input checked="" type="checkbox"/>	<input type="checkbox"/>	<input type="checkbox"/>	passed
2.02_ Ch21000	Middle	21100	9 kHz-30 MHz	2	1	10MHz signal bandwidth used	<input checked="" type="checkbox"/>	<input type="checkbox"/>	<input type="checkbox"/>	passed
2.03_ Ch21350	High	21350	9 kHz-30 MHz	2	1	20MHz signal bandwidth used	<input checked="" type="checkbox"/>	<input type="checkbox"/>	<input type="checkbox"/>	passed

5.2. RF-Parameter - RF Peak power output conducted

5.2.1. Test location and equipments (for reference numbers please see chapter 'List of test equipment')

test location	<input checked="" type="checkbox"/> CETECOM Essen (Chapter. 2.2.1)	<input type="checkbox"/> Please see Chapter. 2.2.2				
test site	<input type="checkbox"/> 347 Radio.lab. 1	<input checked="" type="checkbox"/> Radio.lab. 2				
spectr. analys.	<input type="checkbox"/> 584 FSU	<input type="checkbox"/> 489 ESU 40	<input type="checkbox"/> 264 FSEK	<input type="checkbox"/> 620 ESU 26		
signaling	<input type="checkbox"/> 392 MT8820A	<input type="checkbox"/> 436 CMU	<input type="checkbox"/> 547 CMU	<input checked="" type="checkbox"/> 594 CMW500		
otherwise	<input type="checkbox"/> 400 FTC40x15E	<input type="checkbox"/> 401 FTC40x15E	<input type="checkbox"/> 110 USB LWL	<input type="checkbox"/> 482 Filter Matrix	<input type="checkbox"/> 378 RadiSense	
DC power	<input type="checkbox"/> 456 EA 3013A	<input type="checkbox"/> 463 HP3245A	<input type="checkbox"/> 459 EA 2032-50	<input type="checkbox"/> 268 EA- 3050	<input type="checkbox"/> 494 AG6632A	<input checked="" type="checkbox"/> 611 E3632A
otherwise	<input type="checkbox"/> 331 HC 4055	<input type="checkbox"/> 248 6 dB Att.	<input checked="" type="checkbox"/> 529 Power div.	<input type="checkbox"/> - cable OTA20		<input checked="" type="checkbox"/> 530 10 dB Att.
line voltage	<input type="checkbox"/> 230 V 50 Hz via public mains		<input type="checkbox"/> 060 110 V/ 60 Hz via PAS 5000			

5.2.2. Requirements and limits

FCC	§2.1046, §27.50(h)(2) for LTE Band 7
Limit	Maximum Power Output of the mobile phone should be determined while measured conducted.
	Limit LTE Band 7: 2 Watt EIRP (33.0 dBm)

5.2.3. Test condition and test set-up

Climatic conditions	Temperature: (22±3°C)	Rel. humidity: (40±20)%
Test system set-up	Please see chapter "Test system set-up for conducted measurements on antenna port"	
Measurement method	<p>The measurements were performed with the integrated power measurement function of the „radio communication tester CMU200 from Rohde&Schwarz company. In this way spectrum-analyzers instrument limitations can be avoided or minimized. Instead, CMU manufacturers declared measurement error can be considered for this measurement.</p> <p>The attenuation (insertion loss) at the RF Inputs/Outputs of CMU were set according the path loss of the test set-up, determined in a step before starting the measurements. A suitable artificial antenna or RF-connector is provided by the applicant in order to perform the conducted measurements. Any data provided with the artificial antenna or connector, have been taken in account in order to correct the measurement data. (typical 0.3dB for attenuation of antenna connector)</p> <p>Peak and Average Values have been recorded for each channel and band.</p>	
Mobile phone settings	<p>A call was established with a suitable communication test unit (CMW500). UE is set TX mode, highest transmit power conditions (RMC-mode), power saving techniques have been disabled (MPR-techniques)</p> <p>Tests have been performed in different EUT bandwidth settings and various settings for allocated RBs.</p> <p>The measurements were made at the low, middle and high carrier frequencies of each of the supported operating band within the designated range within the allowed channel bandwidths. Choosing three TX-carrier frequencies of the mobile phone, should be sufficient to demonstrate compliance.</p>	

5.2.4. Measurement Results

LTE-Band 7				QPSK-Modulation			16-QAM-Modulation			Max- modulation	Max. channel	Absolute max. value
Channel bandwidth	ARFCN ch. no.	ARFCN-Frequency [MHz]	Resource block allocation	Peak detektor [dBm]	RMS detektor [dBm]	PAR Faktor [dB]	Peak detektor [dBm]	RMS detektor [dBm]	PAR Faktor [dB]			
5 MHz	20775	2502,5	1RB low	27,33	23,43	3,9	27,61	22,82	4,79	28,07	28,07	
			1RB high	27,12	23,3	3,82	27,34	22,64	4,7			
			50%RB mid	27,55	22,04	5,51	27,26	21,22	6,04			
			100%RB	28,07	21,97	6,1	28	20,95	7,05			
	21100	2535,0	1RB low	27,24	22,83	4,41	27,07	22,51	4,56	28,02		
			1RB high	27,31	22,7	4,61	27,15	22,4	4,75			
			50%RB mid	27,58	21,76	5,82	27,35	20,84	6,51			
			100%RB	27,9	21,68	6,22	28,02	20,65	7,37			
	21425	2567,5	1RB low	26,53	22,75	3,78	26,52	21,5	5,02	27,91		
			1RB high	26,80	22,78	4,02	26,86	21,7	5,16			
			50%RB mid	27,08	21,85	5,23	26,83	20,81	6,02			
			100%RB	27,91	21,79	6,12	27,79	20,83	6,96			
10 MHz	20800	2505	1RB low	27,51	23,44	4,07	26,83	22,07	4,76	27,81	28,11	
			1RB high	27,10	23,17	3,93	26,54	21,98	4,56			
			50%RB mid	27,45	21,95	5,5	27,33	21,04	6,29			
			100%RB	27,81	21,79	6,02	27,81	20,84	6,97			
	21100	2535,0	1RB low	27,05	22,69	4,36	27,31	22,43	4,88	28,11		
			1RB high	27,19	22,74	4,45	27,52	22,42	5,1			
			50%RB mid	27,52	21,75	5,77	27,58	20,69	6,89			
			100%RB	27,70	21,45	6,25	28,11	20,52	7,59			
	21400	2565	1RB low	26,62	22,94	3,68	26,29	21,86	4,43	27,63		
			1RB high	26,97	22,77	4,2	26,66	21,95	4,71			
			50%RB mid	26,95	21,78	5,17	26,92	20,88	6,04			
			100%RB	27,63	21,54	6,09	27,5	20,61	6,89			
15 MHz	20825	2507,5	1RB low	28,02	23,25	4,77	27,74	22,68	5,06	28,02	28,31	
			1RB high	26,88	23,07	3,81	27,13	22,5	4,63			
			50%RB mid	27,26	21,81	5,45	27,34	20,77	6,57			
			100%RB	27,90	21,79	6,11	27,73	20,77	6,96			
	21100	2535,0	1RB low	26,99	22,91	4,08	27,24	21,52	5,72	28,31		
			1RB high	27,14	22,67	4,47	27,46	21,43	6,03			
			50%RB mid	27,41	21,47	5,94	27,46	20,56	6,9			
			100%RB	28,31	21,47	6,84	27,87	20,39	7,48			
	21375	2562,5	1RB low	26,94	22,96	3,98	26,83	22,19	4,64	27,59		
			1RB high	27,05	23,14	3,91	26,89	22,01	4,88			
			50%RB mid	26,75	21,58	5,17	26,83	20,63	6,2			
			100%RB	27,59	21,54	6,05	27,16	20,47	6,69			
20 MHz	20850	2510,0	1RB low	27,68	23,23	4,45	27,08	22,37	4,71	28,02	28,02	
			1RB high	27,02	22,98	4,04	26,59	22,05	4,54			
			50%RB mid	27,33	21,83	5,5	27,22	20,73	6,49			
			100%RB	27,73	21,95	5,78	28,02	20,89	7,13			
	21100	2535,0	1RB low	27,19	22,95	4,24	27,22	22,1	5,12	27,88		
			1RB high	27,39	22,7	4,69	27,5	21,92	5,58			
			50%RB mid	27,37	21,37	6	27,5	20,44	7,06			
			100%RB	27,88	21,65	6,23	27,7	20,56	7,14			
	21350	2560,0	1RB low	27,14	23,07	4,07	26,7	22,1	4,6	27,78		
			1RB high	27,08	23,11	3,97	26,58	21,88	4,7			
			50%RB mid	26,94	21,61	5,33	26,94	20,55	6,39			
			100%RB	27,48	21,66	5,82	27,78	20,7	7,08			

5.3. RF-Parameter - Occupied bandwidth and emission bandwidth

5.3.1. Test location and equipments (for reference numbers please see chapter 'List of test equipment')

test site	<input type="checkbox"/> 347 Radio.lab. 1	<input checked="" type="checkbox"/> Radio.lab. 2			
spectr. analys.	<input type="checkbox"/> 584 FSU8	<input type="checkbox"/> 489 ESU	<input checked="" type="checkbox"/> 620 ESU26	<input type="checkbox"/> 264 FSEK	
attenuator	<input checked="" type="checkbox"/> 530 10 dB	<input type="checkbox"/>	<input type="checkbox"/>		
signaling	<input type="checkbox"/> 392 MT8820A	<input type="checkbox"/> 436 CMU	<input type="checkbox"/> 547 CMU	<input checked="" type="checkbox"/> 594 CMW500	
DC Power	<input checked="" type="checkbox"/> 611 E3632A	<input type="checkbox"/> 087 EA3013	<input type="checkbox"/> 354 NGPE 40	<input type="checkbox"/> 086 LNG50-10	<input type="checkbox"/> 611 E3632A
otherwise	<input checked="" type="checkbox"/> 529 6dB divider				
line voltage	<input type="checkbox"/> 230 V 50 Hz via public mains		<input type="checkbox"/> 060 110 V/ 60 Hz via PAS 5000		

5.3.2. Requirements and Limits

FCC	CFR47, §2.202(a), §2.1049	„the occupied bandwidth is the frequency bandwidth, such that, below it lower and above it upper frequency limits, the mean powers radiated are each equal to 0.5 percent of the total mean power radiated”
ANSI	C63.10-2009	

5.3.3. Test condition and test set-up

Climatic conditions		Temperature: (22±3°C)	Rel. humidity: (40±20)%
Test system set-up		Please see chapter “Test system set-up for conducted measurements at antenna port”	
Spectrum Analyzer Settings	Parameter	Occupied bandwidth:	Emission bandwidth
	Scan Mode	Spectrum analyser mode	Spectrum analyser mode
	Span	1.8MHz/4MHz/6MHz /12MHz/17MHz/22MHz	2MHz/4MHz/7MHz /12MHz/17MHz/22MHz
	RBW	30kHz/50kHz/100kHz/	30kHz/50kHz/100kHz/
	VBW	500kHz/1MHz/	300 kHz/500kHz/1MHz/
	Sweep time	60 Sec	Coupled
	Sweep mode	Single max-hold	Repetitive, max-hold
Detector	RMS	PK	
Measurement method	The used spectrum analyzer FSE or ESU from Rohde & Schwarz contains an integrated function to calculate the occupied bandwidth automatically. From left and right display margin, the upper and lower frequency points where the accumulated power becomes 0.5% of the total power, are calculated. Subtracting the previous determined two frequency points, yields the occupied bandwidth.		Bandwidth defined between 2 markers with are 26dBc compared to highest In-Band Peak Emission.
Mobile phone settings	<p>A call was established with a suitable communication test unit (CMW500). UE is set TX mode, highest transmit power conditions (RMC-mode), power saving techniques have been disabled. All RBs as possible per EUT signal bandwidth have been allocated.</p> <p>The measurements were made at the low, middle and high carrier frequencies of each of the supported operating band. Choosing three TX-carrier frequencies of the mobile phone, should be sufficient to demonstrate compliance.</p>		

5.3.4. Results

5.3.4.1. LTE Band 7: Op. Mode 1, Set-up 1

Test are performed at 100% resource blocks allocation as per bandwidth

Operational Band	Modulation	Signal bandwidth [MHz]	Channel no.		99%-Occupied bandwidth		26 dB Emission Bandwidth	
			Range	Channel no. (Frequenz [MHz])	Diagram no.	Value [MHz]	Diagram no.	Value [MHz]
Band 7	QPSK	5	Low	Ch20775 (2502.5)	35.701	--	34.701	4.9711
			Mid	Ch21100 (2535)	35.702	4.4615	34.702	5.0288
			High	Ch21425 (2567.5)	35.703	--	34.703	4.9519
		10	Low	Ch20800 (2505)	35.704	--	34.704	9.7884
			Mid	Ch21100 (2535)	35.705	--	34.705	9.7884
			High	Ch21400 (2565)	35.706	8.9423	34.706	9.8461
		15	Low	Ch20825 2507.5	35.707	13.3493	34.707	14.7115
			Mid	Ch21100 (2535)	35.708	--	34.708	14.5480
			High	Ch21375 2562.5	35.709	--	34.709	14.4935
		20	low	Ch20850 2510	35.710	--	34.710	19.0384
			Mid	Ch21100 (2535)	35.711	17.8397	34.711	19.1442
			High	Ch21350 2560	35.712	--	34.712	18.9326

Remark: see extract of diagrams with max. values in annex 1

Test are performed at 100% resource blocks allocation as per bandwidth

Operational Band	Modulation	Signal bandwidth [MHz]	Channel no.		99%-Occupied bandwidth		26 dB Emission Bandwidth	
			Range	Channel no. (Frequenz [MHz])	Diagram no.	Value [MHz]	Diagram no.	Value [MHz]
Band 7	16-QAM	5	Low	Ch20775 (2502.5)	35.713	--	34.713	5.0192
			Mid	Ch21100 (2535)	35.714	4.4615	34.714	5.0192
			High	Ch21425 (2567.5)	35.715	--	34.715	5.0096
		10	Low	Ch20800 (2505)	35.716	--	34.716	9.8269
			Mid	Ch21100 (2535)	35.717	--	34.717	9.7884
			High	Ch21400 (2565)	35.718	8.9230	34.718	9.8653
		15	Low	Ch20825 2507.5	35.719	13.3493	34.719	14.5480
			Mid	Ch21100 (2535)	35.720	--	34.720	14.4391
			High	Ch21375 2562.5	35.721	--	34.721	14.4663
		20	low	Ch20850 2510	35.722	--	34.722	19.1089
			Mid	Ch21100 (2535)	35.723	17.8397	34.723	19.1794
			High	Ch21350 2560	35.724	--	34.724	18.9679

Remark: see extract of diagrams with max. values in annex 1

5.4. RF-Parameter - RF Peak power output radiated

5.4.1. Test location and equipment (for reference numbers please see chapter 'List of test equipment')

test location	<input checked="" type="checkbox"/> CETECOM Essen (Chapter. 2.2.1)	<input type="checkbox"/> Please see Chapter. 2.2.2	<input type="checkbox"/> Please see Chapter. 2.2.3
test site	<input type="checkbox"/> 441 EMI SAR	<input type="checkbox"/> 487 SAR NSA	<input checked="" type="checkbox"/> 443 FAR
receiver	<input type="checkbox"/> 377 ESCS30	<input type="checkbox"/> 001 ESS	<input type="checkbox"/> 489 ESU 40
spectr. analys.	<input type="checkbox"/> 584 FSU	<input type="checkbox"/> 120 FSEM	<input checked="" type="checkbox"/> 264 FSEK
antenna	<input type="checkbox"/> 574 BTA-L	<input type="checkbox"/> 133 EMCO3115	<input type="checkbox"/> 302 BBHA9170
signalling	<input checked="" type="checkbox"/> 594 CMW500	<input type="checkbox"/> 436 CMU	<input type="checkbox"/> 546 CMU
otherwise	<input type="checkbox"/> 400 FTC40x15E	<input type="checkbox"/> 401 FTC40x15E	<input type="checkbox"/> 110 USB LWL
DC power	<input type="checkbox"/> 456 EA 3013A	<input type="checkbox"/> 463 HP3245A	<input type="checkbox"/> 459 EA 2032-50
line voltage	<input type="checkbox"/> 230 V 50 Hz via public mains	<input type="checkbox"/> 060 110 V/ 60 Hz via PAS 5000	<input type="checkbox"/> 268 EA- 3050

5.4.2. Requirements and limits

FCC	§2.1046(a), §27.50(h)(2)
Limit	Maximum Power Output of the mobile phone should be determined while measured radiated E(D)RP. Limit LTE Band 7: 2 Watt EIRP for mobile Mobile stations (33.0 dBm)

5.4.3. Test condition and test set-up

link to test system (if used):		<input checked="" type="checkbox"/> air link	<input type="checkbox"/> cable connection	<input type="checkbox"/>
EUT-grounding		<input checked="" type="checkbox"/> none	<input type="checkbox"/> with power supply	<input type="checkbox"/> additional connection
Equipment set up		<input checked="" type="checkbox"/> table top	<input type="checkbox"/> floor standing	
Climatic conditions		Temperature: (22±3°C)		Rel. humidity: (40±20)%
Test system set-up		Please see chapter "Test system set-up for radiated spurious emission measurements up to 20 GHz"		
Spectrum Analyzer Settings	Parameter:	Spectrum analyser mode		
	Scan Mode Span RBW VBW Sweep time Sweep mode Detector	100 MHz 10 MHz 10 MHz Coupled repetitive Peak		
Measurement method		<p>The measurements were performed by using the substitution method (ANSI/TIA/EIA 603C/D) with a spectrum-analyzer. This method can be described like follows:</p> <ol style="list-style-type: none"> choosing of suitable spectrum-analyzer settings for performing the measurements. This settings of the spectrum analyzer must be maintained for both stages of the measurements: EUT emission measurements and also for measurements of the substituted level. The maximum level of the peak power was recorded, while the emissions were maximized by rotating the EUT in three orthogonal axes, which was situated on a non-conductive turntable of 1.55 m height ($P_{MEAS,1}$). This was performed for both measuring antenna polarisations (vertical/horizontal), the maximum of both values is used for further measurements and final substitution ($P_{MEAS,1,MAX}$). As the maximum emission is recorded, the EUT is replaced by a frequency dependant suitable antenna, which is connected to a RF-signal generator, which is transmitting on the determined worst-case frequency as determined in step 2. The RF-signal level of the signal generator is adjusted as long the same worst-case level determined first step is measured at the spectrum analyzer ($P_{SMHU}=P_{MEAS,1,MAX}$) Then the RF-signal cable is disconnected from the antenna and connected to a power-level meter. The level is determined ($P_{MEAS,2}$). The final result is calculated by adding the ERP/EIRP gain of the antenna which substitutes the EUT. $P_{EUT,SUBST} = P_{MEAS,2} + G_{ANTENNA}$ 		
Mobile phone settings		<p>A call was established on highest power transmit conditions in RMC mode. MPR was deactivated.</p> <p>The measurements were made at the low, middle and high carrier frequencies of each of the supported operating band within the designated range within the allowed channel bandwidths. Choosing three TX-carrier frequencies of the mobile phone, should be sufficient to demonstrate compliance.</p>		

5.4.4. Results

Worst-Case channel, Signal bandwidth and resource block configuration from conducted tests cases, re-tested in order to have ERP. and EIRP values.

EUT					Set-up 2, Op. Mode 1				
Channel BW [MHz]	Channel				Peak Output Power (EIRP) [dBm]			Limit [dBm]	Result
	ARFCN ch. no.	ARFCN- Frequency [MHz]	Resource block allocation	Modulation	AV (measured)	PAPR Factor ^{1.)}	PK (calculated)	PK	
5	20775	2502.5	25	QPSK	20.83	6.10	26.93	33.0 (2 Watt)	passed
	21100	2535.0	25	16-QAM	19.99	7.37	27.36		
10	20800	2505.0	50	QPSK	21.94	6.02	27.96		passed
	21100	2535.0	50	16-QAM	19.51	7.59	27.10		
15	20825	2507.5	1RB Low	QPSK	22.28	4.77	27.05		passed
	21100	2535.0	75	16-QAM	18.77	7.48	26.25		
20	20850	2510.0	100	16-QAM	20.51	7.13	27.64		passed
	21100	2535.0	100	QPSK	19.92	6.23	26.15		

Remark: 1.) see conducted measurements for PAR factor

5.5. RF-Parameter - Conducted Out-of-Band RF emissions and Band Edge Emissions

5.5.1. Test location and equipments (for reference numbers please see chapter 'List of test equipment')

test location	<input checked="" type="checkbox"/> CETECOM Essen (Chapter. 2.2.1)	<input type="checkbox"/> Please see Chapter. 2.2.2	<input type="checkbox"/> Please see Chapter. 2.2.3
test site	<input type="checkbox"/> 441 EMI SAR	<input type="checkbox"/> 487 SAR NSA	<input type="checkbox"/> 443 FAR
receiver	<input type="checkbox"/> 377 ESCS30	<input type="checkbox"/> 001 ESS	<input type="checkbox"/> 489 ESU 40
spectr. analys.	<input type="checkbox"/> 584 FSU	<input type="checkbox"/> 120 FSEM	<input checked="" type="checkbox"/> 620 ESU 26
antenna	<input checked="" type="checkbox"/> 608 HL 562	<input checked="" type="checkbox"/> 549 HL 025	<input type="checkbox"/> 302 BBHA9170
signaling	<input type="checkbox"/> 017 CMD 65	<input type="checkbox"/> 323 CMD 55	<input type="checkbox"/> 340 CMD 55
signaling	<input type="checkbox"/> 392 MT8820A	<input type="checkbox"/> 546 CMU	<input type="checkbox"/> 547 CMU
power supply	<input checked="" type="checkbox"/> 611 E3632A	<input type="checkbox"/> 457 EA 3013A	<input type="checkbox"/> 459 EA 2032-50
otherwise	<input checked="" type="checkbox"/> 529 6dB divider	<input type="checkbox"/> 530 6dB Att.	<input type="checkbox"/> 110 USB LWL
line voltage	<input type="checkbox"/> 230 V 50 Hz via public mains	<input type="checkbox"/> 060 110 V/ 60 Hz via PAS 5000	<input type="checkbox"/> 268 EA- 3050
			<input type="checkbox"/> 494 AG6632A
			<input type="checkbox"/> 482 Filter Matrix
			<input type="checkbox"/> 431 Near field
			<input type="checkbox"/> 498 NGPE 40
			<input type="checkbox"/> 477 GPS

5.5.2. Requirements and limits

FCC	§2.1051, §2.1057, §27.53(m)(4)(6)	
Limit	<p>old: 43+10log(P) dBc ^{1.)}</p> <p>55+10log(P) dBc</p>	<p>new: for $CHE \pm 5MHz \leq f \leq CHE \pm 5MHz$ 40+10log(P) dBc ^{2.)}</p> <p>for $2490,5MHz < f < 2496MHz$ 43+10log(P) dBc</p> <p>for $f \leq 2490,5MHz$ 55+10log(P) dBc</p>

Remark:

- 1.) used for measurements: “(4) For mobile digital stations, the attenuation factor shall be not less than 43 + 10 log (P) dB at the channel edge and 55 + 10 log (P) dB at 5.5 megahertz from the channel edges. Mobile Satellite Service licensees operating on frequencies below 2495 MHz may also submit a documented interference complaint against BRS licensees operating on channel BRS Channel 1 on the same terms and conditions as adjacent channel BRS or EBS licensees.”
- 2.) “(4) For mobile digital stations, the attenuation factor shall be not less than 40 + 10 log (P) dB on all frequencies between the channel edge and 5 megahertz from the channel edge, 43 + 10 log (P) dB on all frequencies between 5 megahertz and X megahertz from the channel edge, and 55 + 10 log (P) dB on all frequencies more than X megahertz from the channel edge, where X is the greater of 6 megahertz or the actual emission bandwidth as defined in paragraph (m)(6) of this section. In addition, the attenuation factor shall not be less than 43 + 10 log (P) dB on all frequencies between 2490.5 MHz and 2496 MHz and 55 + 10 log (P) dB at or below 2490.5 MHz. Mobile Satellite Service licensees operating on frequencies below 2495 MHz may also submit a documented interference complaint against BRS licensees operating on channel BRS Channel 1 on the same terms and conditions as adjacent channel BRS or EBS licensees.” dated 2014-07-16

5.5.3. Test condition and test set-up

Climatic conditions	Temperature: (22±3°C)	Rel. humidity: (40±20)%
Test system set-up	Please see chapter “Test system set-up for conducted measurements on antenna port”	
Measurement method	<p>OOB-Emissions: The spectrum was scanned from 9 kHz to the 10th harmonic of the highest frequency generated within the equipment. A PEAK detector was used except measurements near the block-edge where a AVERAGE detector applied.</p> <p>A suitable artificial antenna or RF-connector is provided by the applicant in order to perform the conducted measurements. Any data provided with the artificial antenna or connector, have been taken in account in order to correct the measurement data. (typical 0.3dB for attenuation of antenna connector)</p> <p>Band-Edge Emissions: An integrated BW method was used for band-edge compliance measurements. Details for measurement parameters can be found on the diagrams in annex 1. The integrated function of the measurement receiver was used with corresponding settings.</p>	
Spectrum-Analyzer settings	See below tables	
EUT settings	<p>A call was established with a suitable communication test unit (CMW500). The EUT is set TX mode, highest transmit power conditions (RMC-mode), power saving techniques have been disabled</p> <p>Tests have been performed in various settings for the device regarding allocated ressource blocks and channels in order to find worst-case configuration. Due to very big amount of possible combinations only certain combinations have been tested.</p> <p>The measurements were made at the low, middle and high carrier frequencies of each of the supported operating band. Choosing three TX-carrier frequencies of the EUT, should be sufficient to demonstrate compliance.</p>	

5.5.4. Spectrum-Analyzer settings for LTE Band 7

	Start freq. MHz	Stop freq. MHz	R-BW kHz	V-BW MHz	Sweep time sec.	Att. [dB]	Detector
Sweep 1	0.009	0.150	0.0001	-- ^{1.)}	10	25	MaxH-PK
Sweep 1	0.150	1	0.009	-- ^{1.)}	10	25	MaxH-PK
Sweep 1	1	30	0.1	-- ^{1.)}	5	25	MaxH-PK
Sweep 2	30	19500	1	-- ^{1.)}	>60	35	MaxH-PK
Sweep 3a (Band-Edge)	2477.905	2501.095	50kHz ^{1.)}	500kHz	10	35	MaxH-RMS
Sweep 3b (Band-Edge)	2568.5	2592.5	50MHz ^{1.)}	500kHz	10	35	MaxH-RMS

Remark: 1.) Integrated BW Method used, results integrated to 1MHz reference bandwidth

5.5.5. Results

The results are presented below in summary form only. For more information please see the diagrams enclosed in annex 4.

5.5.5.1. RSE Conducted LTE Band 7: Set-up 1 (QPSK-Modulation)

Dia-gram no.	Carrier Channel		Frequency range	OP-mode no.	Remark	Used detector			Result
	Range	No.				PK	AV	QP	
36.720	Low	20825	9kHz to 30MHz	1	--	<input checked="" type="checkbox"/>	<input type="checkbox"/>	<input type="checkbox"/>	passed
36.721			30 MHz to 19.5 GHz		Carrier (2500.8MHz)and Downlink channel (2628.8MHz) visible on diagram. Not relevant for results	<input checked="" type="checkbox"/>	<input type="checkbox"/>	<input type="checkbox"/>	passed
--			19.5 GHz to 27 GHz		No final measurement performed, pre-measurement uncritical radiated performed (only noise)	<input checked="" type="checkbox"/>	<input type="checkbox"/>	<input type="checkbox"/>	Not performed, not critical peaks found during pre-tests
36.722	Middle	21100	9kHz to 30MHz	1	QPSK modulation	<input checked="" type="checkbox"/>	<input type="checkbox"/>	<input type="checkbox"/>	passed
36.723			30 MHz to 19.5 GHz		Carrier (2532.0MHz)and Downlink channel (2656.0MHz) visible on diagram. Not relevant for results	<input checked="" type="checkbox"/>	<input type="checkbox"/>	<input type="checkbox"/>	passed
--			19.5 GHz to 27 GHz		No final measurement performed, pre-measurement uncritical radiated performed (only noise)	<input checked="" type="checkbox"/>	<input type="checkbox"/>	<input type="checkbox"/>	Not performed, not critical peaks found during pre-tests

36.724	High	21425	9kHz to 30MHz	1	QPSK modulation	<input checked="" type="checkbox"/>	<input type="checkbox"/>	<input type="checkbox"/>	passed
36.725			30 MHz to 18 GHz		Carrier (2567.6)and Downlink channel (2688.0MHz) visible on diagram. Not relevant for results	<input checked="" type="checkbox"/>	<input type="checkbox"/>	<input type="checkbox"/>	passed
--			19.5 GHz to 27 GHz		No final measurement performed, pre-measurement uncritical radiated performed (only noise)	<input checked="" type="checkbox"/>	<input type="checkbox"/>	<input type="checkbox"/>	Not performed, not critical peaks found during pre-tests

Remark: --

5.5.5.2. RSE Conducted LTE Band 7: Set-up 1

Diagram no.	Carrier Channel		Frequency range	OP-mode no.	Remark	Used detector			Result
	Range	No.				PK	AV	QP	
36.726	Low	20825	9kHz to 30MHz	1	16-QAM modulation	<input checked="" type="checkbox"/>	<input type="checkbox"/>	<input type="checkbox"/>	passed
36.727			30 MHz to 19.5 GHz		Carrier (2500.8MHz)and Downlink channel (2628.8MHz) visible on diagram. Not relevant for results	<input checked="" type="checkbox"/>	<input type="checkbox"/>	<input type="checkbox"/>	passed
--			19.5 GHz to 27 GHz		No final measurement performed, pre-measurement uncritical radiated performed (only noise)	<input checked="" type="checkbox"/>	<input type="checkbox"/>	<input type="checkbox"/>	Not performed, not critical peaks found during pre-tests
36.728	Middle	21100	9kHz to 30MHz	1	QPSK modulation	<input checked="" type="checkbox"/>	<input type="checkbox"/>	<input type="checkbox"/>	passed
36.729			30 MHz to 19.5 GHz		Carrier (2534.4MHz)and Downlink channel (2656.0MHz) visible on diagram. Not relevant for results	<input checked="" type="checkbox"/>	<input type="checkbox"/>	<input type="checkbox"/>	passed
--			19.5 GHz to 27 GHz		No final measurement performed, pre-measurement uncritical radiated performed (only noise)	<input checked="" type="checkbox"/>	<input type="checkbox"/>	<input type="checkbox"/>	Not performed, not critical peaks found during pre-tests
36.730	High	21425	9kHz to 30MHz	1	QPSK modulation	<input checked="" type="checkbox"/>	<input type="checkbox"/>	<input type="checkbox"/>	passed
36.731			30 MHz to 18 GHz		Carrier (2567.2)and Downlink channel (2689.2MHz) visible on diagram. Not relevant for results	<input checked="" type="checkbox"/>	<input type="checkbox"/>	<input type="checkbox"/>	passed
--			19.5 GHz to 27 GHz		No final measurement performed, pre-measurement uncritical radiated performed (only noise)	<input checked="" type="checkbox"/>	<input type="checkbox"/>	<input type="checkbox"/>	Not performed, not critical peaks found during pre-tests

Remark: --

5.5.5.3. Band-Edge Low - Conducted LTE Band 7: Op. Mode 1 Set-up 1

Diagram no.	Carrier Channel		Measured frequency range	OP-mode no. ^{*1.)}	Remark	Used detector			Result
	Range	No.				PK	AV	QP	
--	Low	20775 (2502.5MHz) 20800 (2505.0MHz)	2500 - 2506 MHz		Band-Edge compliance QPSK modulation, an integrated bandwidth method was used for measurement. Consult TX-channel value for first 1MHz near band-edge (8 th UPPER) as well as Adjacent/alternate channels On LOWER/UPPER-column for the results for frequencies above 1MHz from channel-edge.	<input type="checkbox"/>	<input checked="" type="checkbox"/>	<input type="checkbox"/>	passed
--	Low	20825 (2507.5MHz) 20850 (2510.0MHz)	2500 - 2506 MHz		Band-Edge compliance 16-QAM modulation, an integrated bandwidth method was used for measurement. Consult TX-channel value for first 1MHz near band-edge (8 th Upper) as well as Adjacent/alternate channels On LOWER/UPPER-column for the results for frequencies above 1MHz from channel-edge.	<input type="checkbox"/>	<input checked="" type="checkbox"/>	<input type="checkbox"/>	passed

Remark: *1.) Please see test measurement in annex 1 - diagrams and values for detailed overview of the tested operating mode.

5.5.5.4. Band-Edge High - Conducted LTE Band 7: Op. Mode 1 Set-up 1

Diagram no.	Carrier Channel		Measured frequency range	OP-mode no. ^{*1.)}	Remark	Used detector			Result
	Range	No.				PK	AV	QP	
--	High	21425 (2567.5MHz) 21400 (2565.0MHz)	2570 -2576 MHz		Band-Edge compliance QPSK modulation, an integrated bandwidth method was used for measurement. Consult TX-channel value for first 1MHz near band-edge (ADJACENT) as well as alternate channels On LOWER/UPPER-column for the results for frequencies above 1MHz from channel-edge.	<input type="checkbox"/>	<input checked="" type="checkbox"/>	<input type="checkbox"/>	passed
--	High	21375 (2562.5MHz) 21350 (2560.0MHz)	2570 -2576 MHz		Band-Edge compliance QAM modulation, an integrated bandwidth method was used for measurement. Consult TX-channel value for first 1MHz near band-edge (ADJACENT) as well as Adjacent/alternate channels On LOWER/UPPER-column for the results for frequencies above 1MHz from channel-edge.	<input type="checkbox"/>	<input checked="" type="checkbox"/>	<input type="checkbox"/>	passed

Remark: *1.) Please see test measurement in annex 1 - diagrams and values for detailed overview of the tested operating mode.

5.6. RF-Parameter - Radiated out of Band RF emissions and Band Edge emissions

5.6.1. Test location and equipments (for reference numbers please see chapter 'List of test equipment')

test location	<input checked="" type="checkbox"/> CETECOM Essen (Chapter. 2.2.1)	<input type="checkbox"/> Please see Chapter. 2.2.2	<input type="checkbox"/> Please see Chapter. 2.2.3
test site	<input type="checkbox"/> 441 EMI SAR	<input type="checkbox"/> 487 SAR NSA	<input checked="" type="checkbox"/> 443 FAR
receiver	<input type="checkbox"/> 377 ESCS30	<input type="checkbox"/> 001 ESS	<input type="checkbox"/> 489 ESU 40
spectr. analys.	<input type="checkbox"/> 584 FSU	<input type="checkbox"/> 120 FSEM	<input checked="" type="checkbox"/> 264 FSEK
antenna	<input checked="" type="checkbox"/> 439 HL 562	<input checked="" type="checkbox"/> 549 HL 025	<input type="checkbox"/> 302 BBHA9170
signaling	<input type="checkbox"/> 017 CMD 65	<input type="checkbox"/> 323 CMD 55	<input type="checkbox"/> 340 CMD 55
signaling	<input type="checkbox"/> 392 MT8820A	<input type="checkbox"/> 546 CMU	<input type="checkbox"/> 547 CMU
power supply	<input checked="" type="checkbox"/> 611 E3632A	<input type="checkbox"/> 457 EA 3013A	<input type="checkbox"/> 459 EA 2032-50
otherwise	<input type="checkbox"/> 529 6dB divider	<input type="checkbox"/> 530 6dB Att.	<input type="checkbox"/> 110 USB LWL
line voltage	<input type="checkbox"/> 230 V 50 Hz via public mains	<input type="checkbox"/> 060 110 V/ 60 Hz via PAS 5000	<input type="checkbox"/> 268 EA- 3050
			<input type="checkbox"/> 494 AG6632A
			<input type="checkbox"/> 498 NGPE 40
			<input type="checkbox"/> 482 Filter Matrix
			<input type="checkbox"/> 431 Near field

5.6.2. Requirements and limits

FCC	§2.1057, §27.53(m)(4)(6)
Limit	<p>for $CHE \pm 5\text{MHz} \leq f \leq CHE \pm 5\text{MHz}$ $40 + 10\log(P)$ dBc ^{1.)}</p> <p>for $2490,5\text{MHz} < f < 2496\text{MHz}$ $43 + 10\log(P)$ dBc</p> <p>for $f \leq 2490,5\text{MHz}$ $55 + 10\log(P)$ dBc</p>

Remark:

1.) “(4) For mobile digital stations, the attenuation factor shall be not less than $40 + 10 \log (P)$ dB on all frequencies between the channel edge and 5 megahertz from the channel edge, $43 + 10 \log (P)$ dB on all frequencies between 5 megahertz and X megahertz from the channel edge, and $55 + 10 \log (P)$ dB on all frequencies more than X megahertz from the channel edge, where X is the greater of 6 megahertz or the actual emission bandwidth as defined in paragraph (m)(6) of this section. In addition, the attenuation factor shall not be less than $43 + 10 \log (P)$ dB on all frequencies between 2490.5 MHz and 2496 MHz and $55 + 10 \log (P)$ dB at or below 2490.5 MHz. Mobile Satellite Service licensees operating on frequencies below 2495 MHz may also submit a documented interference complaint against BRS licensees operating on channel BRS Channel 1 on the same terms and conditions as adjacent channel BRS or EBS licensees.” dated 2014-07-16

5.6.3. Test condition and test set-up

link to test system (if used):	<input checked="" type="checkbox"/> air link	<input type="checkbox"/> cable connection	<input type="checkbox"/>
EUT-grounding	<input checked="" type="checkbox"/> none	<input type="checkbox"/> with power supply	<input type="checkbox"/> additional connection
Equipment set up	<input checked="" type="checkbox"/> table top	<input type="checkbox"/> floor standing	
Climatic conditions	Temperature: (22±3°C)	Rel. humidity: (40±20)%	
Test system set-up	Please see chapter “Test system set-up for radiated spurious emission measurements up to 20 GHz”		
Measurement method	<p>OOB-Emissions: The spectrum was scanned from 9 kHz to the 10th harmonic of the highest frequency generated within the equipment. A PEAK detector was used except measurements near the Band-Edge where a AVERAGE detector applied when results are critical (low margin or limit exceed). Tests have been performed in various settings for the device regarding allocated resource blocks and channels in order to find worst-case configuration. Due to very big amount of possible combinations only certain combinations have been tested.</p> <p>Band-Edge Emissions: Either an integrated BW method or a conventional frequency sweep method was used for band-edge compliance. Details on the diagrams in annex 1.</p>		
EUT settings	<p>A call was established on highest power transmit conditions in RMC mode. MPR was deactivated.</p> <p>The measurements were made at the low, middle and high carrier frequencies of each of the supported operating band within the designated range within the allowed channel bandwidths. Choosing three TX-carrier frequencies of the EUT, should be sufficient to demonstrate compliance.</p>		

5.6.4. Spectrum-analyser settings for LTE Band 7

	Start freq. MHz	Stop freq. MHz	R-BW MHz	V-BW MHz	Sweep time sec.	Att.	Detector
Sweep 1 (subrange 1)	30	1000	1	1	10	10	MaxH-PK / MaxH-AV
Sweep 1 (subrange 2)	1000	2800	1	1	15	0	MaxH-PK / MaxH-AV
Sweep 1 (subrange 3)	2800	18000	1	1	160	10	MaxH-PK / MaxH-AV
Sweep 2a (Band-Edge low)	2485	2496	1MHz	3MHz	10	35	MaxH-PK / MaxH-AV
Sweep 2b (Band-Edge high)	2572	2595	1 MHz	3MHz	10	35	MaxH-PK / MaxH-AV

Remark: none

5.6.5. Results

The results are presented below in summary form only. For more information please see the diagrams enclosed in annex 1.

5.6.5.1. LTE Band 7: Op. Mode 1 Set-up 1 and 2

Diagram no.	Carrier Channel		Measured frequency range	OP-mode no. ^{*1)}	Remark	Used detector			Result
	Range	No.				PK	AV	QP	
8.01a	Low	20825 (2507,5MHz)	30 MHz to 2.8 GHz	1	Carrier visible on diagram. Not relevant for results	<input type="checkbox"/>	<input checked="" type="checkbox"/>	<input type="checkbox"/>	passed
8.01 b/c			2.8 GHz to 18GHz	1	--	<input type="checkbox"/>	<input checked="" type="checkbox"/>	<input type="checkbox"/>	passed
8.01d			18 GHz to 26.5 GHz	1	--	<input type="checkbox"/>	<input checked="" type="checkbox"/>	<input type="checkbox"/>	passed
--	Low	20775 (2502,5MHz) 20800 (2505,0MHz)	2471 - 2496 MHz	1	Band Edge Compliance QPSK modulation *2)	<input type="checkbox"/>	<input checked="" type="checkbox"/>	<input type="checkbox"/>	passed
--	Low	20825 (2507,5MHz) 20850 (2510,0MHz)	2471 - 2496 MHz	1	Band Edge Compliance 16-QAM modulation *2)	<input type="checkbox"/>	<input checked="" type="checkbox"/>	<input type="checkbox"/>	passed
8.02a	Mid	21100 (2535,0MHz)	30 MHz to 2.8 GHz	1	Carrier visible on diagram. Not relevant for results	<input type="checkbox"/>	<input checked="" type="checkbox"/>	<input type="checkbox"/>	passed
8.02b			2.8 GHz to 18GHz	1	--	<input type="checkbox"/>	<input checked="" type="checkbox"/>	<input type="checkbox"/>	passed
8.02c			18 GHz to 26.5 GHz	1	--	<input type="checkbox"/>	<input checked="" type="checkbox"/>	<input type="checkbox"/>	passed
8.03a	High	21425 (2567,5MHz)	30 MHz to 2.8 GHz	1	Carrier visible on diagram. Not relevant for results	<input type="checkbox"/>	<input checked="" type="checkbox"/>	<input type="checkbox"/>	passed
8.03b			2.8 GHz to 18GHz	1	--	<input type="checkbox"/>	<input checked="" type="checkbox"/>	<input type="checkbox"/>	passed
8.03c			18 GHz to 26.5 GHz	1	--	<input type="checkbox"/>	<input checked="" type="checkbox"/>	<input type="checkbox"/>	passed

Table continues on the next page

Remark: *1.)Please see test measurement in annex 1 - diagrams and values for detailed overview of the tested operating mode.

*2.) see band-edge measurements in annex 1 - diagrams and values. Different bandwidths and modulations have been tested in order to find worst-case

Diagram no.	Carrier Channel		Measured Frequency range	OP-mode no. *1)	Remark	Used detector			Result
	Range	No.				PK	AV	QP	
--	High	21425 (2567,5MHz) 21400 (2565,0MHz)	2572 -2597 MHz	1	Band Edge Compliance QPSK modulation *2)	<input checked="" type="checkbox"/>	<input checked="" type="checkbox"/>	<input type="checkbox"/>	passed
--	High	21375 (2562,5MHz) 21350 (2560,0MHz)	2572 -2597 MHz	1	Band Edge Compliance 16-QAM modulation *2)	<input checked="" type="checkbox"/>	<input checked="" type="checkbox"/>	<input type="checkbox"/>	passed

Remark: *1.)Please see test measurement in annex 4 - diagrams and values for detailed overview of the tested operating mode.

*2.) see band-edge measurements in annex 4 - diagrams and values. Different bandwidths and modulations have been tested in order to find worst-case

5.7. RF-Parameter - Frequency stability on temperature and voltage variations

5.7.1. Test location and equipments (for reference numbers please see chapter 'List of test equipment')

test location	<input checked="" type="checkbox"/> CETECOM Essen (Chapter. 2.2.1)	<input type="checkbox"/> Please see Chapter. 2.2.2		<input type="checkbox"/> Please see Chapter. 2.2.3		
test site	<input type="checkbox"/> 347 Radio.lab.1	<input checked="" type="checkbox"/> Radio.lab.2				
spectr. analys.	<input type="checkbox"/> 584 FSU	<input type="checkbox"/> 489 ESU 40	<input type="checkbox"/> 264 FSEK	<input type="checkbox"/> 620 ESU 26		
signaling	<input type="checkbox"/> 392 MT8820A	<input type="checkbox"/> 436 CMU	<input type="checkbox"/> 547 CMU	<input checked="" type="checkbox"/> 594 CMW500	<input type="checkbox"/> 594 CMW500	
DC power	<input type="checkbox"/> 611 E3632A	<input type="checkbox"/> 457 EA 3013A	<input type="checkbox"/> 459 EA 2032-50	<input type="checkbox"/> 268 EA- 3050	<input type="checkbox"/> 494 AG6632A	<input type="checkbox"/> 498 NGPE 40
otherwise	<input checked="" type="checkbox"/> 529 6dB divider	<input checked="" type="checkbox"/> 530 10dB Att.	<input type="checkbox"/> 431 Near field			
Climatic test chamber	<input checked="" type="checkbox"/> 331 HC 4055					
line voltage	<input type="checkbox"/> 230 V 50 Hz via public mains		<input type="checkbox"/> 060 110 V/ 60 Hz via PAS 5000			

5.7.2. Requirements and limits

FCC	§2.1055(a)(1) §27.54
Limit	<i>"The frequency stability shall be sufficient to ensure that the fundamental emission stays within the authorized frequency block"</i>

5.7.3. Test condition and test set-up

Test system set-up	<p>Please see chapter "Test system set-up for conducted measurements on antenna port"</p> <p>In order to maintain the voltage constant over the time period of the tests, a dummy battery was connected to a laboratory power supply. The power supply voltage was controlled on the input of the power supply terminals of the EUT.</p>
Measurement method	<p>The RF Channel spacing is 100 kHz according LTE-Spec, with a guard band depending of the TX signal bandwidth. Details can be found in standard 3GPP36.521. The aim of the EUT is to function under all extreme conditions within authorized sub-bands in regard to temperature and voltage variations. The frequency deviation was recorded with base station's build in capability. (CMW500) for both modulations possible: QPSK and 16-QAM</p> <p>As the standard requires that the fundamental emissions stays within the authorized band, a limit of ±0.1ppm is considered low enough to ensure this. However the standard required a more relaxed limit of ±2.5ppm</p>
Mobile phone settings	<p>UE is set TX mode, highest transmit power conditions (RMC-mode), power saving techniques have been disabled</p> <p>Tests have been done in RMC operating mode ,maximum power at lowest per bandwidth allowed TX signal bandwidth: 1.4MHz or 5MHz. Both modulations have been tested: QPSK and 16-QAM.</p>

5.7.3.1. Frequency shift of carrier against a voltage range at constant nominal temperature of 20° Celsius

- 1.) determine the carrier frequency for the lowest and highest channel at room temperature and nominal voltage [20°C]
- 2.) The voltage was reduced in 0.1 Volt steps to the lower end point, where the mobile phone stops working. (this shall be specified by the manufacturer) Record the carrier frequency shift within 2 minutes after powering on the mobile phone, to prevent for self heating effects.
- 3.) The voltage was increased in 0.1 Volt steps to the upper declared voltage of the battery. Record the carrier frequency shift within 2 minutes after powering on the mobile phone, to prevent for self heating effects.

5.7.4. Measurement Results:

5.7.4.1. Low Channel

LTE Band 7 / Channel 20775 BW=5 MHz/Full RBs						
Voltage [V]	Frequency [MHz]	Frequency error [Hz]		Maximum Frequency error		Verdict Limit=0.1ppm
		QPSK [Hz]	16-QAM [Hz]	QPSK [ppm]	16-QAM [ppm]	
3,50	2,5025E+09	-32,37	-34,02	-0,0129	-0,0136	passed
3,60		-33,45	-28,37	-0,0134	-0,0113	
3,70		-35,89	-26,64	-0,0143	-0,0106	
3,80		-33,83	-33,35	-0,0135	-0,0133	
3,90		-32,84	-31,09	-0,0131	-0,0124	
4,00		-32,92	-34,25	-0,0132	-0,0137	
4,10		-33,77	-35,42	-0,0135	-0,0142	
4,20		-59,74	-63,44	-0,0239	-0,0254	
4,30		-32,73	-29,58	-0,0131	-0,0118	

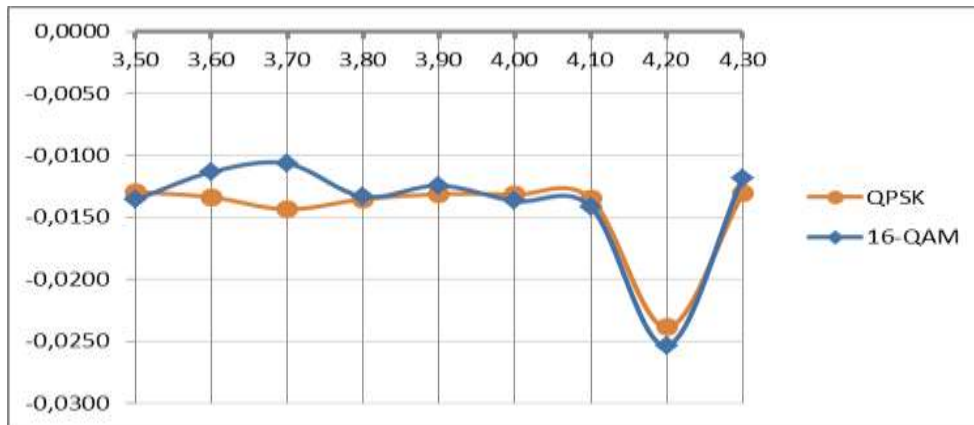

5.7.4.2. Middle Channel

LTE Band 7 / Channel 21100/BW=10 MHz/Full RBs						
Voltage [V]	Nominal Frequency [MHz]	Frequency error [Hz]		Maximum Frequency error		Verdict Limit=0.1ppm
		QPSK [Hz]	16-QAM [Hz]	QPSK [ppm]	16-QAM [ppm]	
3,50	2,5350E+09	-28,04	-28,05	-0,0111	-0,0111	passed
3,60		-26,68	-29,74	-0,0105	-0,0117	
3,70		-29,34	-24,43	-0,0116	-0,0096	
3,80		-27,62	-26,88	-0,0109	-0,0106	
3,90		-25,91	-29,73	-0,0102	-0,0117	
4,00		-28,50	-34,27	-0,0112	-0,0135	
4,10		-30,07	-26,59	-0,0119	-0,0105	
4,20		-25,08	-27,98	-0,0099	-0,0110	
4,30		-26,94	-28,28	-0,0106	-0,0112	

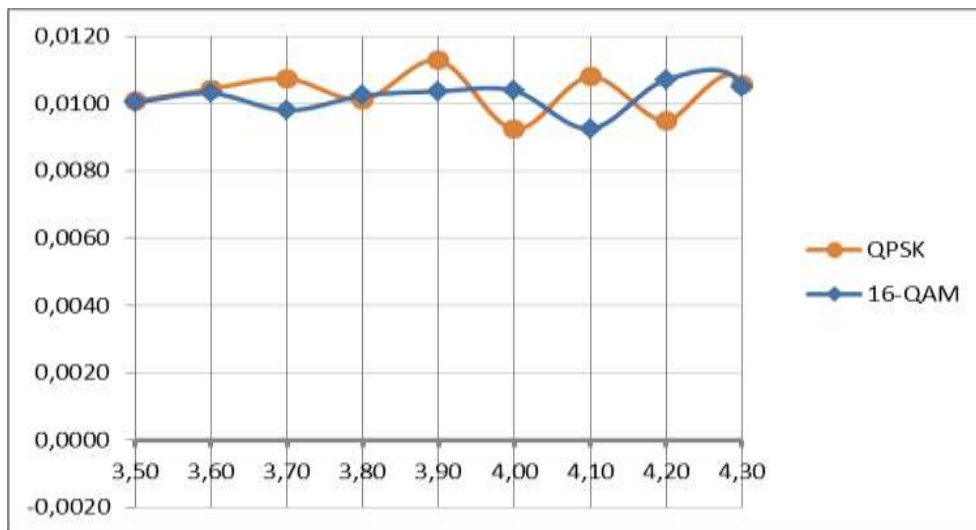

5.7.4.3. High Channel

LTE Band 7 / Channel 21425/BW=5 MHz/Full RBs						
Voltage [V]	Frequency [MHz]	Frequency error [Hz]		Maximum Frequency error		Verdict Limit=0.1ppm
		QPSK [Hz]	16-QAM [Hz]	QPSK [ppm]	16-QAM [ppm]	
3,50	2,5675E+09	25,85	25,76	0,0101	0,0100	passed
3,60		26,79	26,46	0,0104	0,0103	
3,70		27,59	25,15	0,0107	0,0098	
3,80		25,98	26,28	0,0101	0,0102	
3,90		28,97	26,61	0,0113	0,0104	
4,00		23,73	26,65	0,0092	0,0104	
4,10		27,72	23,76	0,0108	0,0093	
4,20		24,33	27,48	0,0095	0,0107	
4,30		27,14	26,92	0,0106	0,0105	

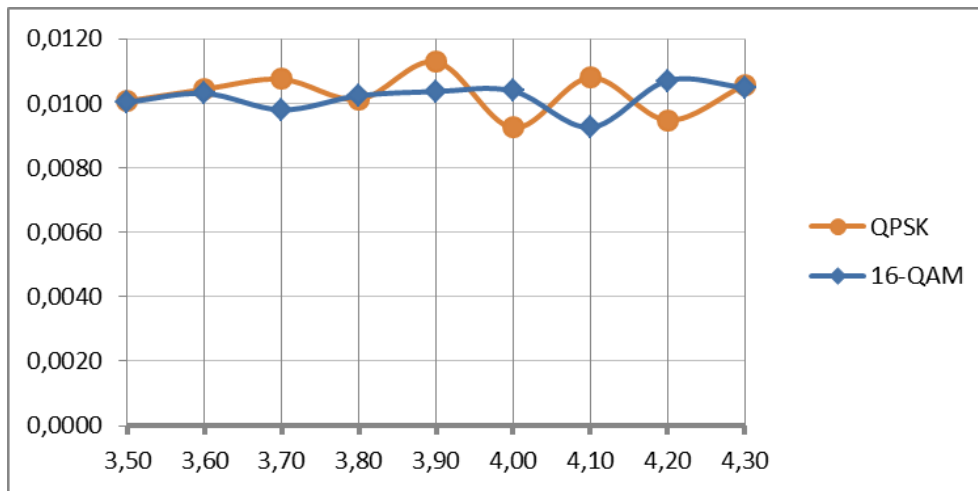

5.7.4.4. Frequency shift of carrier against temperature at constant power supply voltage

- 1.) determine the carrier frequency for the lowest, middle and highest channel at room temperature and nominal voltage [20°C]
- 2.) expose the mobile station to -30°C, wait sufficient time to have constant temperature.
- 3.) Perform the carrier frequencies measurements in 10°C increments from -30°C to +50°C. For about half hour at the specified temperature the mobile was powered-off. After powering-on, the measurements were made within 2 minute for the channel lower channel, in order to prevent self-warming of the mobile.

5.7.4.5. Low channel

Temperature	Maximum frequency error				Verdict Limit=±0.1ppm
	Channel low = 20775/ BW= 5MHz				
	QPSK Modulation [Hz]	16-QAM Modulation [Hz]	QPSK Modulation [ppm]	16-QAM Modulation [ppm]	
-30	-31,06	-29,63	-0,0124	-0,0118	Pass
-20	-31,27	-31,46	-0,0125	-0,0126	
-10	-32,09	-32,33	-0,0128	-0,0129	
0	-30,41	-31,00	-0,0122	-0,0124	
10	-29,43	-31,81	-0,0118	-0,0127	
20	-46,82	-34,70	-0,0187	-0,0139	
30	-32,99	-31,41	-0,0132	-0,0126	
40	-33,65	-33,12	-0,0134	-0,0132	
50	-32,43	-35,29	-0,0130	-0,0141	

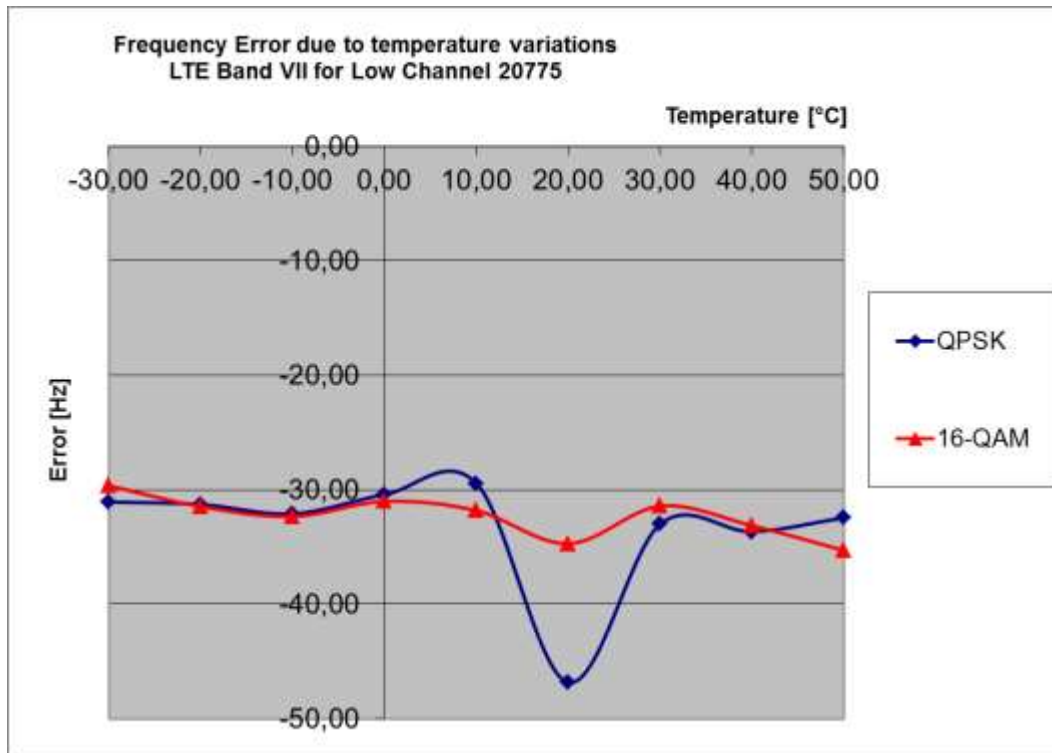

5.7.4.6. Middle channel

Temperature	Maximum frequency error				Verdict Limit=±0.1ppm
	Channel 21100/ BW= 5MHz				
	QPSK Modulation [Hz]	16-QAM Modulation [Hz]	QPSK Modulation [ppm]	16-QAM Modulation [ppm]	
-30	-24,99	-25,79	-0,010	-0,0102	Pass
-20	-24,12	-28,45	-0,010	-0,0112	
-10	-26,35	-27,72	-0,010	-0,0109	
0	-26,89	-28,18	-0,011	-0,0111	
10	-23,76	-26,35	-0,009	-0,0104	
20	-26,87	-29,58	-0,011	-0,0106	
30	-28,35	-21,03	-0,011	-0,0112	
40	-26,87	-28,77	-0,011	-0,0113	
50	-27,08	-28,50	-0,011	-0,0107	

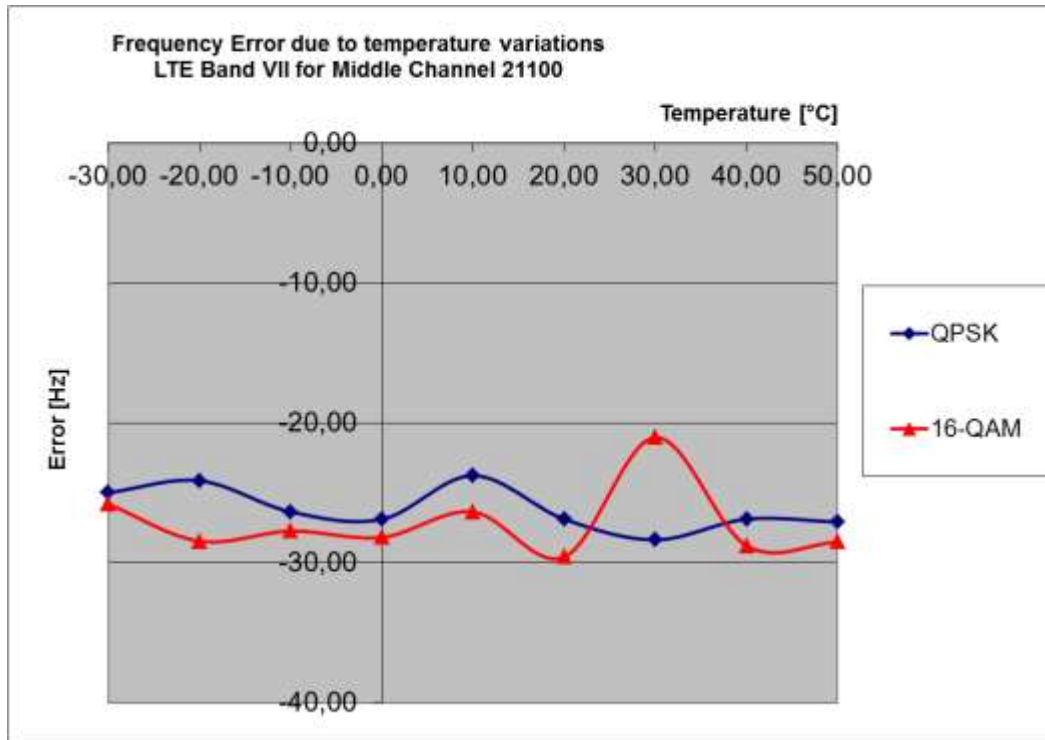

5.7.4.7. High channel

Temperature	Maximum frequency error				Verdict Limit=±0.1ppm
	Channel 21425/ BW= 5MHz				
	QPSK Modulation [Hz]	16-QAM Modulation [Hz]	QPSK Modulation [ppm]	16-QAM Modulation [ppm]	
-30	27,67	26,28	0,0108	0,0102	Pass
-20	27,95	29,33	0,0109	0,0114	
-10	-32,20	-31,15	-0,0125	-0,0121	
0	28,38	27,98	0,0111	0,0109	
10	24,42	27,64	0,0095	0,0108	
20	28,88	29,95	0,0112	0,0117	
30	26,38	25,56	0,0103	0,0100	
40	25,26	29,14	0,0098	0,0113	
50	27,65	27,71	0,0108	0,0108	

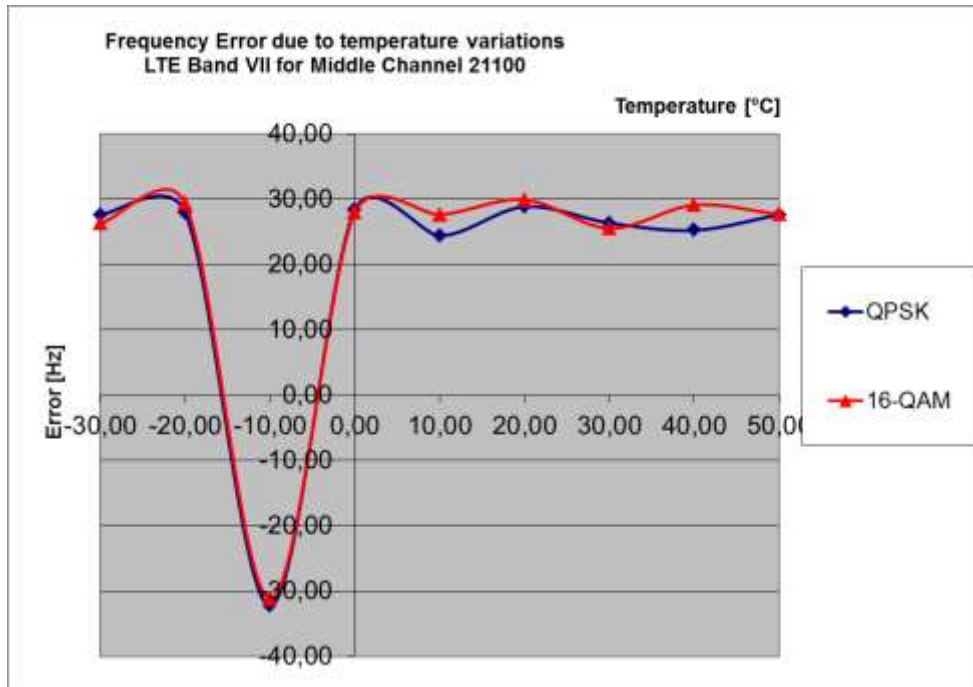

5.8. Measurement uncertainties

The reported uncertainties are calculated based on the standard uncertainty multiplied with the appropriate coverage factor **k**, such that a confidence level of approximately 95% is achieved.

For uncertainty determination, each component used in the concrete measurement set-up was taken in account and it's contribution to the overall uncertainty according it's statistical distribution calculated.

Following table shows expectable uncertainties for each measurement type performed.

RF-Measurement	Frequency range	Calculated uncertainty based on a confidence level of 95%	Remarks:
Power Output conducted	9 kHz .. 20 GHz	1.0 dB	--
Power Output radiated	30 MHz .. 4 GHz	3.17 dB	Substitution method
Conducted emissions on antenna ports	9 kHz .. 20 GHz	1.0 dB	--
Radiated emissions enclosure	150 kHz .. 30 MHz	5.0 dB	Magnetic field
	30 MHz .. 1 GHz	4.2 dB	E-Field
	1 GHz .. 20 GHz	3.17 dB	Substitution method
Occupied bandwidth	9 kHz .. 4 GHz	0.1272 ppm (Delta Marker)	Frequency error
		1.0 dB	Power
Emission bandwidth	9 kHz .. 4 GHz	0.1272 ppm (Delta Marker)	Frequency error
		1.0 dB	Power
Frequency stability	9 kHz .. 20 GHz	0.0636 ppm	--
Conducted emissions on AC-mains port (U _{CISPR})	9 kHz .. 150 kHz	4.0 dB	--
	150 kHz .. 30 MHz	3.6 dB	--

Table: measurement uncertainties, valid for conducted/radiated measurements

6. Abbreviations used in this report

The abbreviations	
ANSI	American National Standards Institute
AV , AVG, CAV	Average detector
EIRP	Equivalent isotropically radiated power, determined within a separate measurement
EGPRS	Enhanced General Packet Radio Service
EUT	Equipment Under Test
FCC	Federal Communications Commission, USA
IC	Industry Canada
n.a.	not applicable
Op-Mode	Operating mode of the equipment
PK	Peak
RBW	resolution bandwidth
RF	Radio frequency
RSS	Radio Standards Specification, Dokuments from Industry Canada
Rx	Receiver
TCH	Traffic channel
Tx	Transmitter
QP	Quasi peak detector
VBW	Video bandwidth
ERP	Effective radiated power

7. Accreditation details of CETECOM's laboratories and test sites

Ref.-No.	Accreditation Certificate	Valid for laboratory area or test site	Accreditation Body
-	D-PL-12047-01-01	All laboratories and test sites of CETECOM GmbH, Essen	DAkkS, Deutsche Akkreditierungsstelle GmbH
337 487 558 348 348	736496	Radiated Measurements 30 MHz to 1 GHz, 3 m / 10 m (OATS) Radiated Measurements 30 MHz to 1 GHz, 3 m (SAR) Radiated Measurements above 1 GHz, 3 m (FAR) Mains Ports Conducted Interference Measurements Telecommunication Ports Conducted Interference Measur.	FCC, Federal Communications Commission Laboratory Division, USA (MRA US-EU 0003)
337 487 550 558	3462D-1 3462D-2 3462D-2 3462D-3	Radiated Measurements 30 MHz to 1 GHz, 3 m / 10 m (OATS) Radiated Measurements 30 MHz to 1 GHz, 3 m (SAR) Radiated Measurements 1 GHz to 6 GHz, 3 m (SAR) Radiated Measurements above 1 GHz, 3 m (FAR)	IC, Industry Canada Certification and Engineering Bureau
487 550 348 348	R-2666 G-301 C-2914 T-1967	Radiated Measurements 30 MHz to 1 GHz, 3 m (SAR) Radiated Measurements 1 GHz to 6 GHz, 3 m (SAR) Mains Ports Conducted Interference Measurements Telecommunication Ports Conducted Interference Measur.	VCCI, Voluntary Control Council for Interference by Information Technology Equipment, Japan
OATS = Open Area Test Site, SAR = Semi Anechoic Room, FAR = Fully Anechoic Room			

8. Instruments and Ancillary

25. Feb. 15

8.1. Used equipment “CTC”

The “Ref.-No” in the left column of the following tables allows the clear identification of the laboratory equipment.

8.1.1. Test software and firmware of equipment

Ref.-No.	Equipment	Type	Serial-No.	Version of Firmware or Software during the test
001	EMI Test Receiver	ESS	825132/017	Firm.= 1.21 , OTP=2.0, GRA=2.0
012	Signal Generator (EMS-cond.)	SMY 01	839069/027	Firm.= V 2.02
013	Power Meter (EMS cond.)	NRVD	839111/003	Firm.= V 1.51
017	Digital Radiocommunication Tester	CMD 60 M	844365/014	Firmware = V 3.52 .22.01.99, DECT = D2.87 13.01.99
053	Audio Analyzer	UPA3	860612/022	Firm. V 4.3
119	RT Harmonics Analyzer dig. Flickermeter	B10	G60547	Firm.= V 3.1DHG
140	Signal Generator	SMHU	831314/006	Firm.= 3.21
261	Thermal Power Sensor	NRV-Z55	825083/0008	EPROM-Datum 02.12.04, SE EE 1 B
262	Power Meter	NRV-S	825770/0010	Firm.= 2.6
263	Signal Generator	SMP 04	826190/0007	Firm.=3.21
264	Spectrum Analyzer	FSEK 30	826939/005	Bios=2.1, Analyzer= 3.20
295	Racal Digital Radio Test Set	6103	1572	UNIT Firmware= 4.04, SW-Main=4.04, SW-BBP=1.04, SW-DSP=1.02, Hardboot=1.02, Softboot=2.02
298	Univ. Radio Communication Tester	CMU 200	832221/091	R&S Test Firmware =3.53 /3.54 (current Testsoftw. f. all band used
323	Digital Radiocommunication Tester	CMD 55	825878/0034	Firm.= 3.52 .22.01.99
331	Climatic Test Chamber -40/+80 Grad	HC 4055	43146	TSI 1.53
335	CTC-EMS-Conducted	System EMS Conducted	-	EMC 32 V 8.52
340	Digital Radiocommunication Tester	CMD 55	849709/037	Firm.= 3.52 .22.01.99
355	Power Meter	URV 5	891310/027	Firm.= 1.31
365	10V Insertion Unit 50 Ohm	URV5-Z2	100880	Eprom Data = 31.03.08
366	Ultra Compact Simulator	UCS 500 M4	V0531100594	Firm. UCS 500-001925/3.06a02, rc=ISMIEC 4.10
371	Bluetooth Tester	CBT32	100153	CBT V5.30+ SW-Option K55, K57
377	EMI Test Receiver	ESCS 30	100160	Firm.= 2.30, OTP= 02.01, GRA= 02.36
378	Broadband RF Field Monitor	RadiSense III	03D00013SNO-08	Firm.= V.03D13
389	Digital Multimeter	Keithley 2000	0583926	Firm. = A13 (Mainboard) A02 (Display)
392	Radio Communication Tester	MT8820A	6K00000788	Firm.= 4.50 #005, IPL=4.01#001,OS=4.02#001, GSM=4.41#013, W-CDMA= 4.54#004, scenario= 4.52#002
436	Univ. Radio Communication Tester	CMU 200	103083	R&S Test Firmware Base=5.14, Mess-Software= GSM:5.14 WCDMA:5.14 (current Testsoftw. F. all band
441	CTC-SAR-EMI Cable Loss	System EMI field (SAR)	-	EMC 32 Version 8.52
442	CTC-SAR-EMS	System EMS field (SAR)	-	EMC 32 Version 8.40
443	CTC-FAR-EMI-RSE	System CTC-FAR-EMI-RSE	-	Spuri 7.2.5 or EMC 32 Ver. 9.15.00
444	CTC-FAR-EMS field	System-EMS-Field (FAR)	-	EMC 32 Version 9.15.00
460	Univ. Radio Communication Tester	CMU 200	108901	R&S Test Firmware Base=5.14, GSM=5.14 WCDMA=5.14 (current Testsoftw.,f. all band to be used,
489	EMI Test Receiver	ESU40	1000-30	Firmware=4.43 SP3, Bios=V5.1-16-3, Spec. =01.00
491	ESD Simulator dito	ESD dito	dito307022	V 2.30
524	Voltage Drop Simulator	VDS 200	0196-16	Software Nr: 000037 Version V4.20a01
526	Burst Generator	EFT 200 A	0496-06	Software Nr. 000034 Version V2.32
527	Micro Pulse Generator	MPG 200 B	0496-05	Software-Nr. 000030 Version V2.43
528	Load Dump Simulator	LD 200B	0496-06	Software-Nr. 000031 Version V2.35a01
546	Univ. Radio Communication Tester	CMU 200	106436	R&S Test Firmware Base=5.14, GSM=5.14 WCDMA=5.14 (current Testsoftw.,f. all band to be used
547	Univ. Radio Communication Tester	CMU 200	835390/014	R&S Test Firmware Base=V5.1403 (current Testsoftw., f. all band used, GSM = 5.14 WCDMA: = 5.14
584	Spectrum Analyzer	FSU 8	100248	2.82_SP3
597	Univ. Radio Communication Tester	CMU 200	100347	R&S Test Firmware Base=5.01, GSM=5.02 WCDMA= not installed, Mainboard= µP1=V.850
598	Spectrum Analyzer	FSEM 30 (Reserve)	831259/013	Firmware Bios 3.40 , Analyzer 3.40 Sp 2
620	EMI Test Receiver	ESU 26	100362	4.43_SP3
642	Wideband Radio Communication Tester	CMW 500	126089	Setup V03.26, Test programm component V03.02.20
692	Bluetooth Tester	CBT 32	100236	CBT V 5.40, FW: V.2.41 (FPGA Digital, V. 3.09 FPGA RF)

8.1.2. Single instruments and test systems

Ref.-No.	Equipment	Type	Serial-No.	Manufacturer	Interval of calibration	Remark	Cal due
001	EMI Test Receiver	ESS	825132/017	Rohde & Schwarz	12 M	-	31.03.2015
005	AC - LISN (50 Ohm/50µH, test site 1)	ESH2-Z5	861741/005	Rohde & Schwarz	12 M	-	31.03.2015
007	Single-Line V-Network (50 Ohm/5µH)	ESH3-Z6	892563/002	Rohde & Schwarz	12 M	-	31.03.2015
009	Power Meter (EMS-radiated)	NRV	863056/017	Rohde & Schwarz	24 M	-	31.03.2015
016	Line Impedance Simulating Network	Op. 24-D	B6366	Spitzenberger+Spies	36 M	-	31.03.2016
020	Horn Antenna 18 GHz (Subst 1)	3115	9107-3699	EMCO	36/12 M	-	31.03.2017
021	Loop Antenna (H-Field)	6502	9206-2770	EMCO	36 M	-	31.03.2015
030	Loop Antenna (H-field)	HFH-Z2	879604/026	Rohde & Schwarz	36 M	-	31.03.2015
033	RF-current probe (100kHz-30MHz)	ESH2-Z1	879581/18	Rohde & Schwarz	24 M	-	31.03.2015
057	relay-switch-unit (EMS system)	RSU	494440/002	Rohde & Schwarz	pre-m	1a	
060	power amplifier (DC-2kHz)	PAS 5000	B6363	Spitzenberger+Spies	-	3	
066	notch filter (WCDMA; FDD1)	WRCT 1900/2200-5/40-10EEK	5	Wainwright GmbH	12 M	1g	31.07.2015
086	DC - power supply, 0 -10 A	LNG 50-10	-	Heinzinger Electronic	pre-m	2	
087	DC - power supply, 0 -5 A	EA-3013 S	-	Elektro Automatik	pre-m	2	
090	Helmholtz coil: 2x10 coils in series	Helmholtz coil: 2x10 coils in	-	RWTÜV	12 M	4	31.03.2015
091	USB-LWL-Converter	OLS-1	007/2006	Ing. Büro Scheiba	-	4	
099	passive voltage probe	ESH2-Z3	299.7810.52	Rohde & Schwarz	36 M	-	31.03.2015
100	passive voltage probe	Probe TK 9416	without	Schwarzbeck	36 M	-	31.03.2015
110	USB-LWL-Converter	OLS-1	-	Ing. Büro Scheiba	-	4	
119	RT Harmonics Analyzer dig. Flickermeter	B10	G60547	BOCONSULT	36 M	-	31.03.2016
136	adjustable dipole antenna (Dipole 1)	3121C-DB4	9105-0697	EMCO	36 M	-	31.03.2015
140	Signal Generator	SMHU	831314/006	Rohde & Schwarz	24 M	-	31.03.2016
248	attenuator	SMA 6dB 2W	-	Radiall	pre-m	2	
249	attenuator	SMA 10dB 10W	-	Radiall	pre-m	2	
252	attenuator	N 6dB 12W	-	Radiall	pre-m	2	
256	attenuator	SMA 3dB 2W	-	Radiall	pre-m	2	
257	hybrid	4031C	04491	Narda	pre-m	2	
260	hybrid coupler	4032C	11342	Narda	pre-m	2	
261	Thermal Power Sensor	NRV-Z55	825083/0008	Rohde & Schwarz	24 M	-	31.03.2016
262	Power Meter	NRV-S	825770/0010	Rohde & Schwarz	24 M	-	31.03.2016
263	Signal Generator	SMP 04	826190/0007	Rohde & Schwarz	36 M	-	31.03.2016
264	Spectrum Analyzer	FSEK 30	826939/005	Rohde & Schwarz	12 M	-	31.03.2015
265	peak power sensor	NRV-Z33, Model 04	840414/009	Rohde & Schwarz	24 M	-	31.03.2016
266	Peak Power Sensor	NRV-Z31, Model 04	843383/016	Rohde & Schwarz	24 M	-	31.03.2016
267	notch filter GSM 850	WRCA 800/960-6EEK	9	Wainwright GmbH	pre-m	2	
270	termination	1418 N	BB6935	Weinschel	pre-m	2	
271	termination	1418 N	BE6384	Weinschel	pre-m	2	
272	attenuator (20 dB) 50 W	Model 47	BF6239	Weinschel	pre-m	2	
273	attenuator (10 dB) 100 W	Model 48	BF9229	Weinschel	pre-m	2	
274	attenuator (10 dB) 50 W	Model 47 (10 dB) 50 W	BG0321	Weinschel	pre-m	2	
275	DC-Block	Model 7003 (N)	C5129	Weinschel	pre-m	2	
276	DC-Block	Model 7006 (SMA)	C7061	Weinschel	pre-m	2	
279	power divider	1515 (SMA)	LH855	Weinschel	pre-m	2	
287	pre-amplifier 25MHz - 4GHz	AMF-2D-100M4G-35-10P	379418	Miteq	12 M	1c	31.07.2015
291	high pass filter GSM 850/900	WHJ 2200-4EE	14	Wainwright GmbH	12 M	1c	31.07.2015
298	Univ. Radio Communication Tester	CMU 200	832221/091	Rohde & Schwarz	pre-m	3	
300	AC LISN (50 Ohm/50µH, 1-phase)	ESH3-Z5	892 239/020	Rohde & Schwarz	12 M	-	31.03.2015
301	attenuator (20 dB) 50W, 18GHz	47-20-33	AW0272	Lucas Weinschel	pre-m	2	
302	horn antenna 40 GHz (Meas 1)	BBHA9170	155	Schwarzbeck	36 M	-	31.03.2017
303	horn antenna 40 GHz (Subst 1)	BBHA9170	156	Schwarzbeck	36 M	-	31.03.2017
331	Climatic Test Chamber -40/+80 Grad	HC 4055	43146	Heraeus Vötsch	24 M	-	30.11.2014
341	Digital Multimeter	Fluke 112	81650455	Fluke	24 M	-	31.03.2016
342	Digital Multimeter	Voltcraft M-4660A	IB 255466	Voltcraft	24 M	-	31.03.2015
347	laboratory site	radio lab.	-	-	-	5	
348	laboratory site	EMI conducted	-	-	-	5	
354	DC - Power Supply 40A	NGPE 40/40	448	Rohde & Schwarz	pre-m	2	
355	Power Meter	URV 5	891310/027	Rohde & Schwarz	24 M	-	31.03.2016
356	power sensor	NRV-Z1	882322/014	Rohde & Schwarz	24 M	-	31.03.2015
357	power sensor	NRV-Z1	861761/002	Rohde & Schwarz	24 M	-	31.03.2015
371	Bluetooth Tester	CBT32	100153	R&S	24 M	-	31.03.2016
373	Single-Line V-Network (50 Ohm/5µH)	ESH3-Z6	100535	Rohde & Schwarz	24 M	-	31.03.2016
377	EMI Test Receiver	ESCS 30	100160	Rohde & Schwarz	12 M	-	31.03.2015
389	Digital Multimeter	Keithley 2000	0583926	Keithley	24 M	-	31.03.2015
392	Radio Communication Tester	MT8820A	6K00000788	Anritsu	12 M	-	31.03.2015
431	Model 7405	Near-Field Probe Set	9305-2457	EMCO	-	4	
436	Univ. Radio Communication Tester	CMU 200	103083	Rohde & Schwarz	12 M	-	31.03.2015
439	UltraLog-Antenna	HL 562	100248	Rohde & Schwarz	36 M	-	31.03.2017
441	CTC-SAR-EMI Cable Loss	System EMI field (SAR) Cable	-	CETECOM	12 M	5	30.01.2016
443	CTC-FAR-EMI-RSE	System CTC-FAR-EMI-	-	ETS-Lindgren /	12 M	5	31.07.2015

Ref.-No.	Equipment	Type	Serial-No.	Manufacturer	Interval of calibration	Remark	Cal due
		RSE		CETECOM			
448	notch filter WCDMA_FDD II	WRCT 1850.0/2170.0-5/40-	5	Wainwright Instruments GmbH	12 M	1c	31.07.2015
449	notch filter WCDMA FDD V	WRCT 824.0/894.0-5/40-8SSK	1	Wainwright	12 M	1c	31.07.2015
454	Oscilloscope	HM 205-3	9210 P 29661	Hameg	-	4	
456	DC-Power supply 0-5 A	EA 3013 S	207810	Elektro Automatik	pre-m	2	
459	DC -Power supply 0-5 A , 0-32 V	EA-PS 2032-50	910722	Elektro Automatik	pre-m	2	
460	Univ. Radio Communication Tester	CMU 200	108901	Rohde & Schwarz	12 M	-	31.03.2015
463	Universal source	HP3245A	2831A03472	Agilent	-	4	
466	Digital Multimeter	Fluke 112	89210157	Fluke USA	24 M	-	31.03.2016
467	Digital Multimeter	Fluke 112	89680306	Fluke USA	36 M	-	31.03.2015
468	Digital Multimeter	Fluke 112	90090455	Fluke USA	36 M	-	31.03.2015
477	ReRadiating GPS-System	AS-47	-	Automotive Cons. Fink	-	3	
480	power meter (Fula)	NRVS	838392/031	Rohde & Schwarz	24 M	-	31.03.2015
482	filter matrix	Filter matrix SAR 1	-	CETECOM (Brl)	-	1d	
484	pre-amplifier 2,5 - 18 GHz	AMF-5D-02501800-25-10P	1244554	Miteq	12 M	-	31.07.2015
487	System CTC NSA-Verification SAR-EMI	System EMI field (SAR) NSA	-	ETS Lindgren / CETECOM	24 M	-	30.06.2015
489	EMI Test Receiver	ESU40	1000-30	Rohde & Schwarz	12 M	-	31.03.2015
502	band reject filter	WRCG 1709/1786-1699/1796-	SN 9	Wainwright	pre-m	2	
503	band reject filter	WRCG 824/849-814/859-	SN 5	Wainwright	pre-m	2	
512	notch filter GSM 850	WRCA 800/960-02/40-6EEK	SN 24	Wainwright	12 M	1c	31.07.2015
517	relais switch matrix	HF Relais Box Keithley	SE 04	Keithley	pre-m	2	
523	Digital Multimeter	L4411A	MY46000154	Agilent	24 M	-	31.03.2015
529	6 dB Broadband resistive power divider	Model 1515	LH 855	Weinschel	pre-m	2	
530	10 dB Broadband resistive power divider	R 416110000	LOT 9828	-	pre-m	2	
546	Univ. Radio Communication Tester	CMU 200	106436	R&S	12 M	-	12.02.2015
547	Univ. Radio Communication Tester	CMU 200	835390/014	Rohde & Schwarz	12 M	-	31.03.2015
548	Digital-Barometer	GBP 2300	without	Greisinger GmbH	36 M	-	30.06.2015
549	Log-Per-Antenna	HL025	1000060	Rohde & Schwarz	36/12 M	-	31.03.2015
552	high pass filter 2,8-18GHz	WHKX 2.8/18G-10SS	4	Wainwright	12 M	1c	31.07.2015
557	System CTC-OTA-2	R&S TS8991	-	Rohde & Schwarz	12 M	5	30.09.2015
558	System CTC FAR S-VSWR	System CTC FAR S-VSWR	-	CTC	24 M	-	31.07.2015
574	Biconilog Hybrid Antenna	BTA-L	980026L	Frankonia	36/12 M	-	31.03.2016
584	Spectrum Analyzer	FSU 8	100248	Rohde & Schwarz	pre-m	-	
594	Wideband Radio Communication Tester	CMW 500	101757	Rohde & Schwarz	12 M	-	31.03.2015
597	Univ. Radio Communication Tester	CMU 200	100347	Rohde & Schwarz	36 M	-	31.03.2016
598	Spectrum Analyzer	FSEM 30 (Reserve)	831259/013	Rohde & Schwarz	24 M	-	13.01.2015
600	power meter	NRVD (Reserve)	834501/018	Rohde & Schwarz	24 M	-	31.03.2015
601	medium-sensitivity diode sensor	NRV-Z5 (Reserve)	8435323/003	Rohde & Schwarz	24 M	-	31.03.2015
602	peak power sensor	NRV-Z32 (Reserve)	835080	Rohde & Schwarz	24 M	-	31.03.2015
611	DC power supply	E3632A	KR 75305854	Agilent	pre-m	2	
612	DC power supply	E3632A	MY 40001321	Agilent	pre-m	2	
613	Attenuator	R416120000 20dB 10W	Lot. 9828	Radiall	pre-m	2	
616	Digitalmultimeter	Fluke 177	88900339	Fluke	24 M	-	31.03.2016
617	Power Splitter/Combiner	ZFSC-2-2-S+	S F987001108	Mini Circuits	-	2	
618	Power Splitter/Combiner	50PD-634	600994	JFW Industries USA	-	2	
619	Power Splitter/Combiner	50PD-634	600995	JFW Industries, USA	-	3	
620	EMI Test Receiver	ESU 26	100362	Rohde-Schwarz	12 M	-	01.12.2015
621	Step Attenuator 0-139 dB	RSP	100017	Rohde & Schwarz	pre-m	2	
625	Generic Test Load USB	Generic Test Load USB	-	CETECOM	-	2	
627	data logger	OPUS 1	201.0999.9302.6.4.1.4 3	G. Luft GmbH	36 M	-	30.05.2015
634	Spectrum Analyzer	FSM (HF-Unit)	826188/010	Rohde & Schwarz	pre-m	2	
636	Thermal Imaging camera	Ti32	Ti32-12060213	Fluke Corporation	36 M	-	31.07.2015
637	High Speed HDMI with Ethernet 1m	HDMI cable with Ethernet 1m	-	Kogilink	-	2	
638	HDMI Kabel with Ethernet 1,5 m flach	HDMI cable with Ethernet	-	Reichelt	-	2	
640	HDMI cable 2m rund	HDMI cable 2m rund	-	Reichelt	-	2	
641	HDMI cable with Ethernet	Certified HDMI cable with	-	PureLink	-	2	
642	Wideband Radio Communication Tester	CMW 500	126089	Rohde&Schwarz	12 M	-	31.03.2015
644	Amplifierer	ZX60-2534M+	SN865701299	Mini-Circuits	-	-	
670	Univ. Radio Communication Tester	CMU 200	106833	Rohde & Schwarz	12 M	-	31.03.2015
671	DC-power supply 0-5 A	EA-3013S	-	Elektro Automatik	pre-m	2	
678	Power Meter	NRP	101638	Rohde&Schwarz	pre-m	-	
683	Spectrum Analyzer	FSU 26	200571	Rohde & Schwarz	12 M	-	01.04.2015
686	Field Analyzer	EHP-200A	160WX30702	Narda Safety Test Solutions	24 M	-	18.07.2015
687	Signal Generator	SMF 100A	102073	Rohde&Schwarz	12 M	-	01.04.2015
688	Pre Amp	JS-18004000-40-8P	1750117	Miteq	pre-m	-	
692	Bluetooth Tester	CBT 32	100236	Rohde & Schwarz	12 M	-	31.03.2015

Ref.-No.	Equipment	Type	Serial-No.	Manufacturer	Interval of calibration	Remark	Cal due
693	TS8997	CTC-Radio Lab 1_TS8997	-	Rohde&Schwarz	12 M	5	01.05.2015
697	Power Splitter	ZN4PD-642W-S+	165001445	Mini-Circuits	-	2	

Note / remarks		Calibrated during system calibration:
	1a	System CTC-SAR-EMS (Ref.-No. 442)
	1b	System-CTC-EMS-Conducted (Ref.-No. 335)
	1c	System CTC-FAR-EMI-RSE (Ref.-No . 443)
	1d	System CTC-SAR-EMI (Ref.-No . 441)
	1e	System CTC-OATS (EMI radiated) (Ref.-No. 337)
	1 f	System CTC-CTIA-OTA (Ref.-No . 420)
	1 g	System CTC-FAR-EMS (Ref.-No . 444)
	2	Calibration or equipment check immediately before measurement
	3	Regulatory maintained equipment for functional check or support purpose
	4	Ancillary equipment without calibration e.g. mechanical equipment or monitoring equipment
	5	Test System

Interval of calibration	12 M	12 month
	24 M	24 month
	36 M	36 month
	24/12 M	Calibration every 24 months, between this every 12 months internal validation
	36/12 M	Calibration every 36 months, between this every 12 months internal validation
	Pre-m	Check before starting the measurement
	-	Without calibration

9. Versions of test reports (change history)

Version	Applied changes	Date of release
--	Initial release	2015-03-12
C1	Remark about modular approval on page 4 removed	2015-03-20