

TEST REPORT
No.: 6-0147-12-14-5b

According to:
FCC Regulations
 Part 22, Part 24, Part 27

IC-Regulations
 RSS-132 Issue 3, RSS-133 Issue 6,
 RSS-139 Issue 2, RSS-Gen Issue 3

for

Gemalto M2M GmbH
Wireless Module ALS1-US

(W-CDMA Mode)

FCC-ID: QIPALS1-US
 IC: 7830A-ALS1US







Laboratory Accreditation and Listings			
 Deutsche Akkreditierungsstelle D-PL-12047-01-01	 FEDERAL COMMUNICATIONS COMMISSION USA Reg. No.: 736496 MRA US-EU 0003	 Industry Canada Reg. No.: 3462D-1 Reg. No.: 3462D-2 Reg. No.: 3462D-3	 Voluntary Controls for Electromagnetic Emissions Reg. No.: R-2665, R-2666 C-2914, T-1967, G-301
 WiFi ALLIANCE AUTHORIZED RF LABORATORY	 CTIA Authorized Test Lab LAB CODE 20011130-00		
accredited according to DIN EN ISO/IEC 17025			
<p align="center"> CETECOM GmbH Laboratory Radio Communications & Electromagnetic Compatibility Im Teelbruch 116 • 45219 Essen • Germany Registered in Essen, Germany, Reg. No.: HRB Essen 8984 Tel.: + 49 (0) 20 54 / 95 19-954 • Fax: + 49 (0) 20 54 / 95 19-964 E-mail: info@cetecom.com • Internet: www.cetecom.com </p>			

Table of contents

1. SUMMARY OF TEST RESULTS.....	3
1.1. TX mode, tests overview according FCC and Canadian RSS Standards.....	3
2. ADMINISTRATIVE DATA	5
2.1. Identification of the testing laboratory.....	5
2.2. Test location	5
2.3. Organizational items	5
2.4. Applicant’s details	5
2.5. Manufacturer’s details	5
3. EQUIPMENT UNDER TEST (EUT).....	6
3.1. Technical data of main EUT declared by applicant	6
3.2. EUT: Type, S/N etc. and short descriptions used in this test report	7
3.3. Auxiliary Equipment (AE): Type, S/N etc. and short descriptions.....	7
3.4. EUT set-ups	8
3.5. EUT operating modes	9
3.6. Configuration of cables used for testing	9
4. DESCRIPTION OF TEST SYSTEM SET-UP’S	10
4.1. Test system set-up for conducted measurements on antenna port	10
4.2. Test system set-up for radiated spurious emission measurements	11
5. MEASUREMENTS	12
5.1. RF-Parameter - RF Peak power output radiated	12
5.2. RF-Parameter - Radiated out of Band RF emissions and Band Edge.....	14
5.3. RF-Parameter - RF Peak power output conducted.....	18
5.4. RF-Parameter - Occupied bandwidth and emission bandwidth	20
5.5. RF-Parameter - Conducted out of Band RF emissions and Band Edge.....	22
5.6. RF-Parameter - Frequency stability on temperature and voltage variations	25
5.7. Measurement uncertainties	32
6. ABBREVIATIONS USED IN THIS REPORT	32
7. ACCREDITATION DETAILS OF CETECOM’S LABORATORIES AND TEST SITES	33
8. INSTRUMENTS AND ANCILLARY.....	34
8.1. Used equipment “CTC”	34

Table of annex

Total pages

ANNEX 1: EXTERNAL PHOTOGRAPHS SEPARATE DOCUMENT 6-0147-12-14-5-A1.PDF	8
ANNEX 2: INTERNAL PHOTOGRAPHS – TO BE SUPPLIED BY APPLICANT	NONE
ANNEX 3: TEST SET-UP PHOTOGRAPHS SEPARATE DOCUMENT 6-0147-12-14-5-A3.PDF	4
ANNEX 4: MEASUREMENT DIAGRAMS SEPARATE DOCUMENT 6-0147-12-14-5B-A4.PDF	59

The listed attachments are an integral part of this report.

1. Summary of test results

The test results apply exclusively to the test samples as presented in this Report. The CETECOM GmbH does not assume responsibility for any conclusions and generalizations taken in conjunction with other specimens or samples of the type of the item presented to tests.

The Equipment Under Test (in this report, hereinafter referred as EUT) supports radiofrequency technologies in the field of wireless communication.

The presented RF data-module includes different wireless technologies for example W-CDMA Band II, IV and V. This test report shows results for W-CDMA technologies only. Other implemented wireless technologies were not considered within this test report.

Following tests have been performed to show compliance with applicable FCC Part 2, Part 22, Subpart H, Part 24, Subpart E (Broadband PCS) and Part27, Subpart C (AWS) of the FCC CFR 47 Rules, Edition 1st October 2012 and Canada RSS-132, Issue 3, RSS-133, Issue 6, RSS-139, Issue 2 and RSS-Gen. Issue 3 standards.

1.1. TX mode, tests overview according FCC and Canadian RSS Standards

No. of Diagram group	Test case	Port	References & Limits			EUT set-up	EUT op-mode	Result
			FCC Standard	RSS Section	Test limit			
1	AC-Power Lines Emissions Conducted (0,15 - 30 MHz)	AC-Power lines (conducted)	§15.207	RSS-Gen: Chapt.7.2.4	§15.207 limits IC: Table 4, Chapter 7.2.4	--	--	Remark 1.)
2	General field strength emissions (9 kHz - 30 MHz)	Cabinet + inter-connecting cables (radiated)	§15.209(a)	RSS-Gen, Chapter 4.11 Chapter 7.2.5, Table 5+6	2400/F(kHz) µV/m 24000/F(kHz) µV/m 30 µV/m	--	--	Remark 1.)
7	RF-Power (ERP/EIRP)		§2.1046 §22.913(a)(2)	RSS-132: 5.4 SRSP-503: 5.1.3	< 7 Watt (ERP)	1	1	passed
			§24.232(c)	RSS-133:4.1/6.4 SRSP-510: 5.1.2	< 2 Watt (EIRP)			
			§27.50(d)(4)	RSS-139: 6.4				
8	Spurious emissions		§2.1053(a) §2.1057	RSS-132: 4.5.1 & 4.5.2	43+10log(P) dBc	1+5	1	passed
9	Band-Edge compliance	§22.917(a)(b) §24.238(a)(b) §27.53(h)(3)	RSS-133: 6.5.1(a)(b) RSS-139: 6.5(i)(ii)	1		1	passed	

30	RF Power	Antenna terminal (conducted)	§2.1046	--	N/A	3+4	1	passed
34	26dB Emission bandwidth		§2.202 §2.1049 §22.917(a) §24.238(a) §27.53(h)(3)	RSS-Gen:4.6.1	99% Power	2	1	For information only
35	99% Occupied bandwidth					2	1	
36	Spurious emissions		§2.1051 §2.1057	RSS-132: 5.5(i)(ii)	43+10log(P) dBc	2	1	passed
37	Band-Edge compliance		§22.917(a)(b) §24.238(a)(b) §27.53(h)(3)	RSS-133: 6.5.1(i)(ii) RSS-139: 6.5(i)(ii)		2	1	Passed
38	Frequency stability		§22.355, table C-1 §24.235 §2.1055(a)(2) §27.54	RSS-132: 5.3 RSS-133: 6.3 RSS-139: 6.3	< ±2.5ppm	2	1	passed

Remarks: 1.) see separate test report TR6-0147-12-14-5d for tests according FCC Part15C

Attestation:

I declare that all measurements were performed by me or under my supervision and that all measurements have been performed and are correct to my best knowledge and belief to Industry Canada standards. All requirements as shown in above table are met in accordance with enumerated standards.

.....
D. Franke
Responsible for test section

GmbH
Im Teebruch 116
45219 Essen
Tel.: + 49 (0) 20 54 / 95 19 - 0
Fax: + 49 (0) 20 54 / 95 19 - 997

.....
Dipl.-Ing. C. Lorenz
Responsible for test report

2. Administrative Data

2.1. Identification of the testing laboratory

Company name:	CETECOM GmbH
Address:	Im Teelbruch 116 45219 Essen - Kettwig Germany
Responsible for testing laboratory:	Dipl.-Ing. Niels Jeß
Deputy:	Dipl.-Ing. Rachid Acharkaoui

2.2. Test location

2.2.1. Test laboratory “CTC”

Company name:	see chapter 2.1. Identification of the testing laboratory
---------------	---

2.3. Organizational items

Responsible for test report and project leader:	Dipl.-Ing. C. Lorenz
Receipt of EUT:	2013-02-18
Date(s) of test:	2013-05-19 to 2013-07-26
Date of report:	2013-07-26

Version of template:	12.11 Lorenz

2.4. Applicant’s details

Applicant’s name:	Gemalto M2M GmbH
Address:	Siemensdamm 50 13629 Berlin Germany
Contact person:	Mr. Thorsten Liebig

2.5. Manufacturer’s details

Manufacturer’s name:	please see Applicant's details
Address:	please see Applicant's details

3. Equipment under test (EUT)

3.1. Technical data of main EUT declared by applicant

Main function		GSM/GPRS/E-GPRS/W-CDMA/LTE Wireless Module	
Type		ALS1-US	
TX-frequency range		FDD Band 2: 1852.4–1907.6 MHz (Uplink), 1930-1990 MHz (Downlink) FDD Band 4: 1712.4–1752.6 MHz (Uplink), 2110-2155 MHz (Downlink) FDD Band 5: 826.4-846.6 MHz (Uplink), 869-894 MHz (Downlink)	
Type of modulation		FDD-Mode Release99: QPSK FDD Mode Release 5+6: 16QAM additional	
Number of channels		FDD Band 2: UARFCN range 9262 – 9400 – 9538 FDD Band 4: UARFCN range 1312 – 1450 – 1513 FDD Band 5: UARFCN range 4132 – 4183 – 4233	
UMTS-HSPA connectivity		<input checked="" type="checkbox"/> Uplink speed: 5.76 Mbps (category 6) <input checked="" type="checkbox"/> Downlink speed: max. 42Mbps	
Test Channels	Band II	Channel 9262 Channel 9400 Channel 9538	
	Band IV	Channel 1312 Channel 1450 Channel 1513	
	Band V	Channel 4132 Channel 4183 Channel 4233	
Emission designator(s)		FDD II MODE (RMC99): 4M17G9W FDD II MODE (HSPA): 4M17F9W FDD IV MODE (RMC99): 4M17G9W FDD IV MODE (HSPA): 4M17F9W FDD V MODE (RMC99): 4M19G9W FDD V MODE (HSPA): 4M19F9W	
Antenna Type		<input type="checkbox"/> Integrated <input type="checkbox"/> External, no RF- connector <input checked="" type="checkbox"/> External, separate RF-connector main TX/RX <input checked="" type="checkbox"/> External, separate RF-connector secondary RX	
Antenna Gain		Max. 0 dBd gain	
MAX PEAK Output Power: Radiated		FDD-Mode 2	28.9 dBm
		FDD-Mode 4	26.6 dBm
		FDD-Mode 5	21.7 dBm
MAX PEAK Output Power: Conducted		FDD-Mode 2	24.4 dBm
		FDD-Mode 4	24.5 dBm
		FDD-Mode 5	24.4 dBm
FCC-ID		QIPALS1-US	
IC		7830A-ALS1US	
Installed option		<input checked="" type="checkbox"/> GSM 900 and GSM 1800 Bands (not usable in USA/Canada) <input checked="" type="checkbox"/> W-CDMA Band I and Band VIII (not usable in USA/Canada)	
Power supply		<input checked="" type="checkbox"/> DC power only: 9-12 Volt on DSB75-Adapter Converted to voltage range of 3.3 V to 4.2 V by DSB75-Adapter board	
Special EMI components		--	
EUT sample type		<input type="checkbox"/> Production	<input checked="" type="checkbox"/> Pre-Production
			<input type="checkbox"/> Engineering
FCC label attached		<input type="checkbox"/> yes	<input checked="" type="checkbox"/> no

3.2. EUT: Type, S/N etc. and short descriptions used in this test report

Short description*)	EUT	Type	S/N serial number	HW hardware status	SW software status
EUT A	Wireless Module	ALS1-US	004401080900 562 (sample#21)	B2 (rev.3)	00.170
EUT B	Wireless Module	ALS1-US	004401080900 430 (sample#35)	B2 (Rev.3)	00.170
EUT C	Wireless Module	ALS1-US	004401080906 320	Rev.4.2	01.010

*) EUT short description is used to simplify the identification of the EUT in this test report.

3.3. Auxiliary Equipment (AE): Type, S/N etc. and short descriptions

AE short description *)	Auxiliary Equipment	Type	S/N serial number	HW hardware status	SW software status
AE 1	SMARTEQ MiniMag. mount antenna 1	2.6m RG174, SMA-m 0dBd, 824-960 / 1710-2170MHz	59801B	1140.26 SMA	-
AE 2	SMARTEQ MiniMag. mount antenna 2	2.6m RG174, SMA-m 0dBd, 824-960 / 1710-2170MHz	59801B	1140.26 SMA	-
AE 3	RS232 cable	2 m	-	-	-
AE 4	DSB75-Adapter	DSB75	-	AH6-DSB75-1	-
AE 5	Handset Votronic	Telephone receiver with RJ11 connector	4017953211 311	HH-SI-30.3/V3.0/0	-
AE 6	USB cable	1m	-	-	-
AE 7	Notebook	DELL D610 D	CTC-PC3	-	Windows XP + Terminal Program
AE 8	Test Adapter	For EUT A/B/C	--	--	--

*) AE short description is used to simplify the identification of the auxiliary equipment in this test report.

3.4. EUT set-ups

EUT set-up no. *)	Combination of EUT and AE	Remarks
Set. 1	EUT A + AE1 + AE2 + AE3 + AE4 + AE5 + AE6 + AE 7 + AE 8	Radiated tests performed: AT commands set the device into operating mode conditions with help of AE7 AE6 is not connected to the EUT during tests
Set. 2	EUT A + AE3 + AE4 + AE5 + AE6 + AE 7 + AE 8	Conducted tests performed: AT commands set the device into operating mode conditions with help of AE7
Set. 3	EUT B + AE4 + AE6 + AE 7 + AE 8	RF-Conducted Output power tests performed: AT commands set the device into operating mode conditions with help of AE7
Set. 4	EUT C + AE4 + AE6 + AE 7 + AE 8	RF-Conducted Output power tests performed: AT commands set the device into operating mode conditions with help of AE7
Set. 5	EUT C + AE1 + AE2 + AE3 + AE4 + AE5 + AE6 + AE 7 + AE 8	Radiated tests performed: AT commands set the device into operating mode conditions with help of AE7 AE6 is not connected to the EUT during tests

*) EUT set-up no. is used to simplify the identification of the EUT set-up in this test report.

3.5. EUT operating modes

EUT operating mode no.*)	Description of operating modes	Additional information
1	FDD-Band 2 or 4 or 5 (Details on each test presented) 12.2 kbps RMC	A communication link (TX-Mode) is established between the mobile station (UE) and the test simulator. The transmitter is operated on its maximum rated output power class: 24dBm nominal. The input signal to the receiver is modulated with normal test modulation. The wanted RF input signal level to the receiver of the mobile station is set to a level to provide a stable communication link according Table E5.1/Table E5.1A as described in 3GPP TS34.121, Annex E.

*) EUT operating mode no. is used to simplify the test report.

3.6. Configuration of cables used for testing

Cable number	Item	Type	S/N serial number	HW hardware status	Cable length
Cable 1	RS232 Port	--	--	--	2.5 m
Cable 2	USB Port	--	--	--	1 m
Cable 3	RJ11 handset line	--	--	--	1.5 m
Cable 4	RF-antenna port 1 (main)	--	--	--	1.5 m
Cable 5	RF-antenna port 2	--	--	--	1.5 m

4. Description of test system set-up's

4.1. Test system set-up for conducted measurements on antenna port

Specification: ANSI C63.10: 2009

General Description: The EUT's RF-signal is coupled out by a suitable antenna coupling connector (1). The signal is first attenuated (2) before it is 0° divided by a power divider (3). One of the signal path is connected to the radio communication tester (4), other branch is connected to the spectrum – analyzer (5). The specific attenuation losses for both signal paths/branches are determined prior to the measurement within a set-up calibration. These are then taken into account by correcting the measurement readings on the spectrum-analyzer.

Schematic:

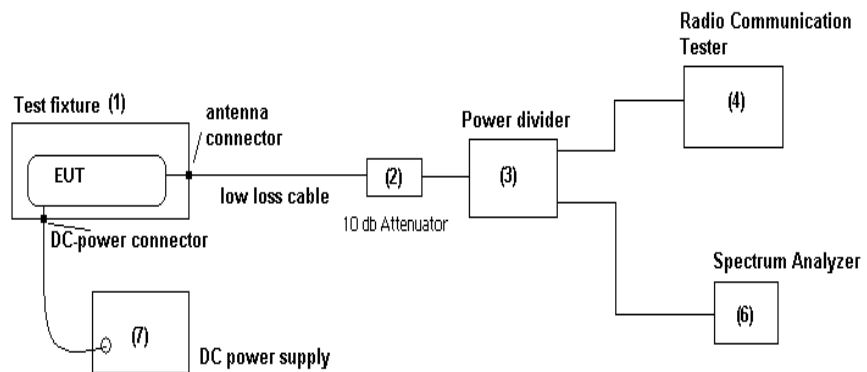

Schematic:

Following modified test set-up schematic apply for tests performed inside the climatic chamber: (Frequency stability)

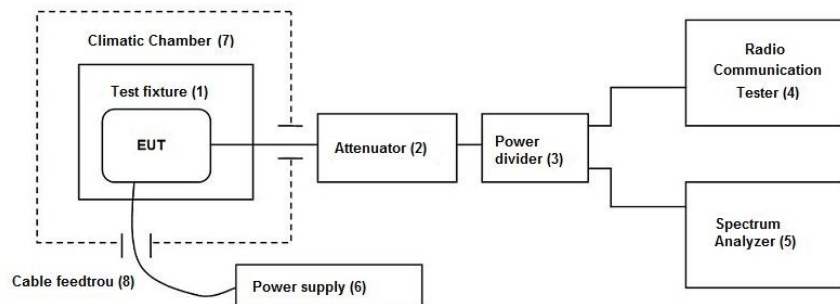

4.2. Test system set-up for radiated spurious emission measurements

Specification: ANSI C63.4-2009 chapter 8, ANSI C63.10-2009 chapter 6.5&6.6

General Description: Evaluating the field emissions have to be done first by an exploratory emissions measurement and a final measurement for most critical frequencies. The tests are performed in a CISPR 16-4 compliant fully anechoic room (FAR) recognized by the regulatory commission. The measurement distance was set to 3 meter for frequencies up to 20 GHz and 1 meter above 20 GHz. A logarithmic periodic antenna is used for the frequency range 30 MHz to 20 GHz. From 20 GHz to 40 GHz a horn antenna is used. The antennas are set to fixed antenna height of 1.55 m and the EUT aligned within 3 dB cone of radiation pattern.

Schematic:

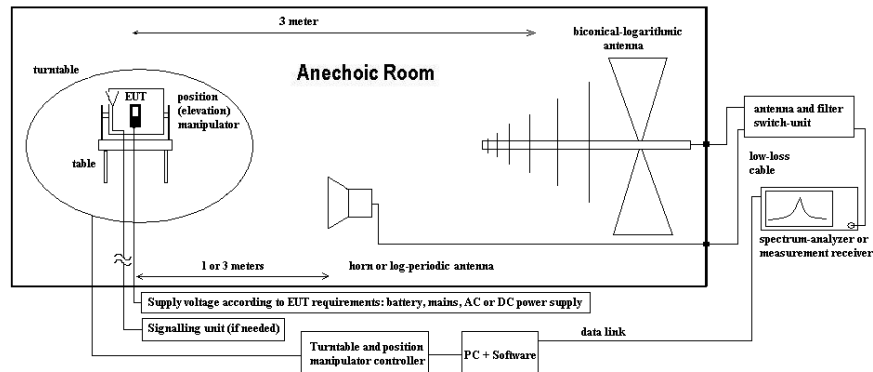

Testing method:

Exploratory, preliminary measurements

The EUT and its associated accessories are placed on a non-conductive position manipulator (tipping device) of 1.55 m height which is placed on the turntable. By rotating the turntable (range 0° to 360°, step 45°) and the EUT itself either on 3-orthogonal axis (portable equipment) or 2-orthogonal axis (defined operational position of EUT) the emission spectrum and its characteristics was recorded with an EMI-receiver, broadband antenna and software.

The measurements are performed in horizontal and vertical polarization of the measurement antennas. The results are documented in a diagram. Critical frequencies (low margin to limit) are saved within a table for further investigations. If various operating modes are supported, further investigations are made to find the worst-case of them. Also the interconnection cables and equipment position were varied in order to maximize the emissions.

Final measurement on critical frequencies

Based on the exploratory measurements, the most critical frequencies are re-measured by maintaining the EUT's worst-case operation mode, cable position, etc.

First a frequency zoom around the critical frequency is done to locate the frequency more precisely. After this step, for all identified critical frequencies, the maximum peak was determined. Following parameters were varied: the turntable angle continuously in the range 0 to 360 degree, the EUT itself either over 3-orthogonal axis (not defined usage position) or 2-orthogonal axis (defined usage position). The measurement antenna height is fixed to 1.55 m.

On the determined worst-case position, a final measurement with necessary bandwidth and detector according standard has been carried out. The readings on the spectrum analyzer are corrected with conversion value between field strength and E(I)RP, so the readings shown are equivalent to ERP/EIRP values. Critical measurements near the limit are re-measured with a substitution method accord. ANSI/TIA/EIA 603 C/D

Formula:

$$E_C = E_R + AF + C_L + D_F - G_A \quad (1)$$

$$E_{C(E)IRP} = E_C - 95.2 \text{ dB}$$

$$M = L_T - E_{C(E)IRP}$$

E_C = Electrical field – corrected value

E_R = Receiver reading

M = Margin

L_T = Limit

AF = Antenna factor

C_L = Cable loss

D_F = Distance correction factor (if used)

G_A = Gain of pre-amplifier (if used)

$E_{C(E)IRP}$ = Electrical field corrected for E(I)RP

All units are dB-units, positive margin means value is below limit.

5. Measurements

5.1. RF-Parameter - RF Peak power output radiated

5.1.1. Test location and equipment (for reference numbers please see chapter 'List of test equipment')

test location	<input checked="" type="checkbox"/> CETECOM Essen (Chapter. 2.2.1)	<input type="checkbox"/> Please see Chapter. 2.2.2	<input type="checkbox"/> Please see Chapter. 2.2.3
test site	<input type="checkbox"/> 441 EMI SAR	<input type="checkbox"/> 487 SAR NSA	<input checked="" type="checkbox"/> 443 FAR
receiver	<input type="checkbox"/> 377 ESCS30	<input type="checkbox"/> 001 ESS	<input type="checkbox"/> 489 ESU 40
spectr. analys.	<input type="checkbox"/> 584 FSU	<input type="checkbox"/> 120 FSEM	<input checked="" type="checkbox"/> 264 FSEK
antenna	<input type="checkbox"/> 574 BTA-L	<input type="checkbox"/> 133 EMCO3115	<input type="checkbox"/> 302 BBHA9170
signalling	<input type="checkbox"/> 392 MT8820A	<input type="checkbox"/> 436 CMU	<input checked="" type="checkbox"/> 546 CMU
otherwise	<input type="checkbox"/> 400 FTC40x15E	<input type="checkbox"/> 401 FTC40x15E	<input type="checkbox"/> 110 USB LWL
DC power	<input checked="" type="checkbox"/> 611 E3636A	<input type="checkbox"/> 463 HP3245A	<input type="checkbox"/> 459 EA 2032-50
line voltage	<input type="checkbox"/> 230 V 50 Hz via public mains	<input type="checkbox"/> 060 110 V/ 60 Hz via PAS 5000	<input type="checkbox"/> 620 ESU 26
			<input type="checkbox"/> 482 Filter Matrix
			<input type="checkbox"/> 378 RadiSense
			<input type="checkbox"/> 494 AG6632A
			<input type="checkbox"/> 498 NGPE 40

5.1.2. Requirements and limits

FCC	§2.1046(a), §22.913, § 24.232(c); §27.50(d)(4)
IC	RSS-132:5.4 + SRSP 503:5.1.3 for FDD Band 5; RSS-133:4.1/6.4 + SRSP-510:5.1.2 for FDD Band 2 RSS-139, Issue 2: 6.4 + PAR PK-AV ≤ 13 dB
Limit	Maximum Power Output of the mobile phone should be determined while measured radiated E(IRP).
	Limit FDD Band 5: 7 Watt ERP (38.4 dBm)
	Limit FDD Band 2: 2 Watt EIRP (33.0 dBm)
	Limit FDD Band 4: 1 Watt EIRP (30.0 dBm)

5.1.3. Test condition and test set-up

link to test system (if used):	<input checked="" type="checkbox"/> air link	<input type="checkbox"/> cable connection	<input type="checkbox"/>
EUT-grounding	<input checked="" type="checkbox"/> none	<input type="checkbox"/> with power supply	<input type="checkbox"/> additional connection
Equipment set up	<input checked="" type="checkbox"/> table top		<input type="checkbox"/> floor standing
Climatic conditions	Temperature: (22±3°C)		Rel. humidity: (40±20)%
Test system set-up	Please see chapter "Test system set-up for radiated spurious emission measurements up to 20 GHz"		
Spectrum Analyzer Settings	Parameter: Scan Mode Span RBW VBW Sweep time Sweep mode Detector	Spectrum analyser mode 100 MHz 10 MHz 10 MHz Coupled repetitive Peak	
Measurement method	<p>The measurements were performed by using the substitution method (ANSI/TIA/EIA 603C/D) with a spectrum-analyzer. This method can be described like follows:</p> <ol style="list-style-type: none"> choosing of suitable spectrum-analyzer settings for performing the measurements. This settings of the spectrum analyzer must be maintained for both stages of the measurements: EUT emission measurements and also for measurements of the substituted level. The maximum level of the peak power was recorded, while the emissions were maximized by rotating the EUT in three orthogonal axes, which was situated on a non-conductive turntable of 1.55 m height ($P_{MEAS,1}$). This was performed for both measuring antenna polarisations (vertical/horizontal), the maximum of both values is used for further measurements and final substitution ($P_{MEAS,1,MAX}$). As the maximum emission is recorded, the EUT is replaced by a frequency dependant suitable antenna, which is connected to a RF-signal generator, which is transmitting on the determined worst-case frequency as determined in step 2. The RF-signal level of the signal generator is adjusted as long the same worst-case level determined first step is measured at the spectrum analyzer ($P_{SMHU}=P_{MEAS,1,MAX}$). Then the RF-signal cable is disconnected from the antenna and connected to a power-level meter. The level is determined ($P_{MEAS,2}$). The final result is calculated by adding the ERP/EIRP gain of the antenna which substitutes the EUT. $P_{EUT,SUBST} = P_{MEAS,2} + G_{ANTENNA}$ 		
Mobile phone settings	A call was established on highest power transmit conditions in RMC99 mode. The measurements were made at the low, middle and high carrier frequencies of each of the supported operating band. Choosing three TX-carrier frequencies of the mobile phone, should be sufficient to demonstrate compliance.		

5.1.4. Results

EUT			Set-up 1, Op.Mode 1				
Operating Mode	Channel		Peak Output Power [dBm]			Antenna Polarisation for maximum Power	Result
	Range	No.	PK	AV			
FDD Band 2	Low	9262	28.9	1.)	EIRP-Value	V	passed
	Middle	9400	26.6				
	High	9538	24.5				

Remark: 1.) see conducted measurements for PAR factor

EUT			Set-up 1, Op.Mode 1				
Operating Mode	Channel		Peak Output Power [dBm]			Antenna Polarisation for maximum Power	Result
	Range	No.	PK	AV			
FDD Band 4	Low	1312	24.3	1.)	EIRP-Value	H	passed
	Middle	1450	25.2				
	High	1513	26.6				

Remark: 1.) see conducted measurements for PAR factor

EUT			Set-up 1, Op.Mode 1				
Operating Mode	Channel		Peak Output Power [dBm]			Antenna Polarisation for maximum Power	Result
	Range	No.	PK	AV			
FDD Band 5	Low	4132	21.7	1.)	ERP-Value	H	passed
	Middle	4183	20.6				
	High	4233	20.3				

Remark: 1.) see conducted measurements for PAR factor

5.2. RF-Parameter - Radiated out of Band RF emissions and Band Edge

5.2.1. Test location and equipments (for reference numbers please see chapter 'List of test equipment')

test location	<input checked="" type="checkbox"/> CETECOM Essen (Chapter. 2.2.1)	<input type="checkbox"/> Please see Chapter. 2.2.2	<input type="checkbox"/> Please see Chapter. 2.2.3
test site	<input type="checkbox"/> 441 EMI SAR	<input type="checkbox"/> 487 SAR NSA	<input checked="" type="checkbox"/> 443 FAR
receiver	<input type="checkbox"/> 377 ESCS30	<input type="checkbox"/> 001 ESS	<input type="checkbox"/> 489 ESU 40
spectr. analys.	<input type="checkbox"/> 584 FSU	<input type="checkbox"/> 120 FSEM	<input checked="" type="checkbox"/> 264 FSEK
antenna	<input checked="" type="checkbox"/> 608 HL 562	<input checked="" type="checkbox"/> 549 HL 025	<input type="checkbox"/> 302 BBHA9170
signaling	<input type="checkbox"/> 017 CMD 65	<input type="checkbox"/> 323 CMD 55	<input type="checkbox"/> 340 CMD 55
signaling	<input type="checkbox"/> 392 MT8820A	<input checked="" type="checkbox"/> 546 CMU	<input type="checkbox"/> 547 CMU
power supply	<input checked="" type="checkbox"/> 611 E3636A	<input type="checkbox"/> 457 EA 3013A	<input type="checkbox"/> 459 EA 2032-50
otherwise	<input type="checkbox"/> 529 6dB divider	<input type="checkbox"/> 530 6dB Att.	<input type="checkbox"/> 110 USB LWL
line voltage	<input type="checkbox"/> 230 V 50 Hz via public mains		<input type="checkbox"/> 060 110 V/ 60 Hz via PAS 5000

5.2.2. Requirements and limits

FCC	§2.1053(a)-radiated , §2.1057(a)(a) , §22.917(a)(b) ; §24.238(a)(b) ; §27.53(h)(3)
IC	RSS-132, Issue 3: 5.5(i)(ii), RSS-133, Issue 4: 6.5.1(i)(ii)&(b), RSS-139, Issue 2: 6.5 (i)(ii)
Limit	„the power of emissions shall be attenuated below the transmitter output power (p) by at least 43+10Log(P) dB“ -> Resulting limits for all power levels of the Mobile Phone: -13dBm

5.2.3. Test condition and test set-up

link to test system (if used):		<input checked="" type="checkbox"/> air link	<input type="checkbox"/> cable connection	<input type="checkbox"/>
EUT-grounding		<input checked="" type="checkbox"/> none	<input type="checkbox"/> with power supply	<input type="checkbox"/> additional connection
Equipment set up		<input checked="" type="checkbox"/> table top		<input type="checkbox"/> floor standing
Climatic conditions		Temperature: (22±3°C)		Rel. humidity: (40±20)%
Test system set-up		Please see chapter “Test system set-up for radiated spurious emission measurements up to 20 GHz”		
Spectrum Analyzer Settings	Parameter:	Spectrum analyser mode		
	Scan Mode Span RBW VBW Sweep time Sweep mode Detector	20 MHz 3 MHz 10 MHz Coupled repetitive Peak		
Measurement method		<p>The spectrum was scanned from 9 kHz to the 10th harmonic of the highest frequency generated within the equipment. A PEAK detector was used except measurements near the block-edge where a AVERAGE detector applied for critical measurements.</p> <p>According chapter 4.2</p> <p>Valid for band-edge compliance: Due to not available exact 1% RBW of the measurement equipment, the lower available RBW was used for the FDD measurements.</p> <p>An additional correction factor of 10 Log (RBW1/ RBW2) to the result was added. RBW1 is the narrower measurement resolution bandwidth (used RBW) and RBW2 is either the 1% emissions bandwidth or 1 MHz (KDB890810).</p> <p>Formula: Band-Edge compliance correction factor for FDD bands 10log(30 kHz/50 kHz) to be used= -2.22 dB</p>		
Mobile phone settings		<p>A call was established on highest power transmit conditions in RMC99 mode.</p> <p>The measurements were made at the low, middle and high carrier frequencies of each of the supported operating band. Choosing three TX-carrier frequencies of the mobile phone, should be sufficient to demonstrate compliance.</p>		

Spectrum-Analyzer settings for FDD band 2

	Start freq. MHz	Stop freq. MHz	R-BW MHz	V-BW MHz	Sweep time sec.	Att. [dB]	Detector
Sweep 1 (subrange 1)	30	1000	1	1	10	10	MaxH-PK
Sweep 1 (subrange 2)	1000	2800	1	1	15	0	MaxH-PK
Sweep 1 (subrange 3)	2800	20000	1	1	60	10	MaxH-PK
Sweep 2a (Block-Edge)	1849	1850	0.05	0.5	30	35	MaxH-PK
Sweep 2b (Block-Edge)	1849	1850	0.05	0.5	30	35	MaxH-AV
Sweep 3a (Block-Edge)	1910	1911	0.05	0.5	30	35	MaxH-PK
Sweep 3b (Block-Edge)	1910	1911	0.05	0.5	30	35	MaxH-AV

Spectrum-analyzer settings for FDD Band 4

	Start freq. MHz	Stop freq. MHz	R-BW MHz	V-BW MHz	Sweep time sec.	Att.	Detector
Sweep 1 (subrange 1)	30	1000	1	10	10	10	MaxH-PK
Sweep 1 (subrange 2)	1000	2800	1	10	15	0	MaxH-PK
Sweep 1 (subrange 3)	2800	20000	1	10	160	10	MaxH-PK
Sweep 2a (Block-Edge)	1709	1710	0.05	0.5	30	35	MaxH-PK
Sweep 2b (Block-Edge)	1709	1710	0.05	0.5	30	35	MaxH-AV
Sweep 3a (Block-Edge)	1755	1756	0.05	0.5	30	35	MaxH-PK
Sweep 3b (Block-Edge)	1755	1756	0.05	0.5	30	35	MaxH-AV

Spectrum-analyzer settings for FDD Band 5

	Start freq. MHz	Stop freq. MHz	R-BW MHz	V-BW MHz	Sweep time sec.	Att.	Detector
Sweep 1 (subrange 1)	30	1000	1	1	10	10	MaxH-PK
Sweep 1 (subrange 2)	1000	2800	1	1	15	0	MaxH-PK
Sweep 1 (subrange 3)	2800	12000	1	1	160	10	MaxH-PK
Sweep 2a (Block-Edge)	823	824	0.05	0.5	30	35	MaxH-PK
Sweep 2b (Block-Edge)	823	824	0.05	0.5	30	35	MaxH-AV
Sweep 3a (Block-Edge)	850	851	0.05	0.5	30	35	MaxH-PK
Sweep 3b (Block-Edge)	850	851	0.05	0.5	30	35	MaxH-AV

5.2.4. Results

The results are presented below in summary form only. For more information please see each diagram enclosed in annex 4.

5.2.4.1. FDD Band 2: Op. Mode 1, Set-up 1

Diagram no.	Carrier Channel		Frequency range	OP-mode no.	Remark	Used detector			Result
	Range	No.				PK	AV	QP	
8.20	Low	9262	30 MHz to 20 GHz	1	Carrier visible on diagram. Not relevant for results	<input checked="" type="checkbox"/>	<input type="checkbox"/>	<input type="checkbox"/>	passed
9.20	Low		1849 – 1850 MHz		Band Edge Compliance Correction of 2.22dB apply: $-22.32 + 2.22 = 20.1$ dBm	<input checked="" type="checkbox"/>	<input type="checkbox"/>	<input type="checkbox"/>	passed
8.21	Middle	9400	30 MHz to 20 GHz		Carrier visible on diagram. Not relevant for results	<input checked="" type="checkbox"/>	<input type="checkbox"/>	<input type="checkbox"/>	passed
8.22	High	9538	30 MHz to 20 GHz		Carrier visible on diagram. Not relevant for results	<input checked="" type="checkbox"/>	<input type="checkbox"/>	<input type="checkbox"/>	passed
9.22	High		1910 – 1911 MHz		Band-Edge compliance: Correction of 2.22dB apply: $-20.83 + 2.22 = 18.6$ dBm	<input checked="" type="checkbox"/>	<input checked="" type="checkbox"/>	<input type="checkbox"/>	passed

Remark: Remark: a mathematical correction of used RBW=30kHz for measurements to required 1% RBW of EBW was used

5.2.4.2. FDD Band 2: Op. Mode 1, Set-up 5

Diagram no.	Carrier Channel		Frequency range	OP-mode no.	Remark	Used detector			Result
	Range	No.				PK	AV	QP	
--	Low	9262	--	1	--	<input type="checkbox"/>	<input type="checkbox"/>	<input type="checkbox"/>	--
--	Low		--		--	<input type="checkbox"/>	<input type="checkbox"/>	<input type="checkbox"/>	--
8.23	Middle	9400	30 MHz to 20 GHz		Carrier visible on diagram. Not relevant for results	<input checked="" type="checkbox"/>	<input type="checkbox"/>	<input type="checkbox"/>	passed
--	High	9538	--		--	<input type="checkbox"/>	<input type="checkbox"/>	<input type="checkbox"/>	--
--	High		--		--	--	<input type="checkbox"/>	<input type="checkbox"/>	<input type="checkbox"/>

Remark: Remark: a mathematical correction of used RBW=30kHz for measurements to required 1% RBW of EBW was used

5.2.4.3. FDD Band 4: Op. Mode 1, Set-up 1

Diagram no.	Carrier Channel		Frequency range	OP-mode no.	Remark	Used detector			Result
	Range	No.				PK	AV	QP	
8.40	Low	1312	30 MHz to 20 GHz	1	Carrier visible on diagram. Not relevant for results	<input checked="" type="checkbox"/>	<input type="checkbox"/>	<input type="checkbox"/>	passed
9.40	Low		1709 - 1710 MHz		Band Edge Compliance Correction of 2.22dB apply: $-21.69 + 2.22 = 19.47$ dBm	<input checked="" type="checkbox"/>	<input checked="" type="checkbox"/>	<input type="checkbox"/>	passed
8.41	Middle	1450	30 MHz to 20 GHz		Carrier visible on diagram. Not relevant for results	<input checked="" type="checkbox"/>	<input type="checkbox"/>	<input type="checkbox"/>	passed
8.42	High	1513	30 MHz to 20 GHz		Carrier visible on diagram. Not relevant for results	<input checked="" type="checkbox"/>	<input type="checkbox"/>	<input type="checkbox"/>	passed
9.41	High		1755 – 1756 MHz		Band-Edge compliance Correction of 2.22dB apply: $-21.7 + 2.22 = 19.48$ dBm	<input checked="" type="checkbox"/>	<input checked="" type="checkbox"/>	<input type="checkbox"/>	passed

Remark: a mathematical correction of used RBW=30kHz for measurements to required 1% RBW of EBW was used

5.2.4.4. FDD Band 5: Op. Mode 1, Set-up 1

Diagram no.	Carrier Channel		Frequency range	OP-mode no.	Remark	Used detector			Result
	Range	No.				PK	AV	QP	
8.50	Low	4132	30 MHz to 12 GHz	1	Carrier visible on diagram. Not relevant for results	<input checked="" type="checkbox"/>	<input type="checkbox"/>	<input type="checkbox"/>	passed
9.50	Low		823 – 824 MHz		Band Edge Compliance Correction of 2.22dB apply: $-29.55 + 2.22 = 27.33$ dBm	<input checked="" type="checkbox"/>	<input type="checkbox"/>	<input type="checkbox"/>	passed
8.51	Middle	4183	30 MHz to 12 GHz		Carrier visible on diagram. Not relevant for results	<input checked="" type="checkbox"/>	<input type="checkbox"/>	<input type="checkbox"/>	passed
8.52	High	4233	30 MHz to 12 GHz		Carrier visible on diagram. Not relevant for results	<input checked="" type="checkbox"/>	<input type="checkbox"/>	<input type="checkbox"/>	passed
9.51	High		849 – 850 MHz		Band-Edge compliance Correction of 2.22dB apply: $-5.43 + 2.22 = 23.21$ dBm	<input checked="" type="checkbox"/>	<input type="checkbox"/>	<input type="checkbox"/>	passed

Remark: a mathematical correction of used RBW=30kHz for measurements to required 1% RBW of EBW was used

5.2.4.5. FDD Band 5: Op. Mode 1, Set-up 5

Diagram no.	Carrier Channel		Frequency range	OP-mode no.	Remark	Used detector			Result
	Range	No.				PK	AV	QP	
--	Low	4132	--	1	--	<input type="checkbox"/>	<input type="checkbox"/>	<input type="checkbox"/>	--
--	Low		--		--	<input type="checkbox"/>	<input type="checkbox"/>	<input type="checkbox"/>	--
8.53	Middle	4183	30 MHz to 12 GHz		Carrier visible on diagram. Not relevant for results	<input checked="" type="checkbox"/>	<input type="checkbox"/>	<input type="checkbox"/>	passed
--	High	4233	--		--	<input type="checkbox"/>	<input type="checkbox"/>	<input type="checkbox"/>	--
--	High		--		--	--	<input type="checkbox"/>	<input type="checkbox"/>	<input type="checkbox"/>

Remark: a mathematical correction of used RBW=30kHz for measurements to required 1% RBW of EBW was used

5.3. RF-Parameter - RF Peak power output conducted

5.3.1. Test location and equipments (for reference numbers please see chapter 'List of test equipment')

test location	<input checked="" type="checkbox"/> CETECOM Essen (Chapter. 2.2.1)	<input type="checkbox"/> Please see Chapter. 2.2.2				
test site	<input type="checkbox"/> 347 Radio.lab. 1	<input checked="" type="checkbox"/> Radio.lab. 2				
spectr. analys.	<input type="checkbox"/> 584 FSU	<input type="checkbox"/> 489 ESU 40	<input type="checkbox"/> 264 FSEK	<input type="checkbox"/> 620 ESU 26		
signaling	<input type="checkbox"/> 392 MT8820A	<input type="checkbox"/> 436 CMU	<input type="checkbox"/> 547 CMU	<input type="checkbox"/> 460 CMU		
otherwise	<input type="checkbox"/> 400 FTC40x15E	<input type="checkbox"/> 401 FTC40x15E	<input type="checkbox"/> 110 USB LWL	<input type="checkbox"/> 482 Filter Matrix	<input type="checkbox"/> 378 RadiSense	
DC power	<input checked="" type="checkbox"/> 611 E3636A	<input type="checkbox"/> 463 HP3245A	<input type="checkbox"/> 459 EA 2032-50	<input type="checkbox"/> 268 EA- 3050	<input type="checkbox"/> 494 AG6632A	<input type="checkbox"/> 498 NGPE 40
otherwise	<input type="checkbox"/> 331 HC 4055	<input type="checkbox"/> 248 6 dB Att.	<input type="checkbox"/> 529 Power div.	<input type="checkbox"/> - cable OTA20		
line voltage	<input type="checkbox"/> 230 V 50 Hz via public mains		<input type="checkbox"/> 060 110 V/ 60 Hz via PAS 5000			

5.3.2. Requirements and limits

FCC	§2.1046
IC	RSS-132:5.4 + SRSP 503:5.1.3 for FDD Band 5; RSS-133:4.1/6.4 + SRSP-510:5.1.2 for FDD Band 2 RSS-139, Issue 2: 6.4 + PAR PK-AV ≤ 13 dB
Limit	Maximum Power Output of the mobile phone should be determined while measured conducted.
	Limit FDD Band 5: 7 Watt ERP (38.4 dBm)
	Limit FDD Band 2: 2 Watt EIRP (33.0 dBm)
	Limit FDD Band 4: 1 Watt EIRP (30.0 dBm)

5.3.3. Test condition and test set-up

Climatic conditions	Temperature: (22±3°C)	Rel. humidity: (40±20)%
Test system set-up	Please see chapter "Test system set-up for conducted measurements on antenna port" ANRITSU	
Measurement method	<p>The measurements were performed with the integrated power measurement function of the „radio communication tester CMU200 from Rohde&Schwarz company. In this way spectrum-analyzers instrument limitations can be avoided or minimized. Instead, CMU manufacturers declared measurement error can be considered for this measurement.</p> <p>The attenuation (insertion loss) at the RF Inputs/Outputs of CMU were set according the path loss of the test set-up, determined in a step before starting the measurements. A suitable artificial antenna or RF-connector is provided by the applicant in order to perform the conducted measurements. Any data provided with the artificial antenna or connector, have been taken in account in order to correct the measurement data. (typical 0.3dB for attenuation of antenna connector)</p> <p>Peak and Average Values have been recorded for each channel and band.</p>	
Mobile phone settings	<p>A call was established on highest power transmit conditions in RMC99 mode.</p> <p>UE is set TX mode, highest transmit power conditions, DTX, MPR or other power saving techniques have been disabled</p> <p>The measurements were made at the low, middle and high carrier frequencies of each of the supported operating band. Choosing three TX-carrier frequencies of the mobile phone, should be sufficient to demonstrate compliance.</p>	

5.3.4. Measurement Results

Measurements have been performed with both hardware versions, latest version shows minor higher power values. The difference in values are within measurement uncertainties.

FDD Band 2									
EUT		Set-up 4, Op. Mode 1							
Test case	Subtest No.	Power[dBm]						Limit	Result
		UARFCN no. 9262		UARFCN no. 9400		UARFCN no. 9538			
		PK	AV	PK	AV	PK	AV	[dBm]	
Release 99 12.2kbps RMC	--	27.6	24.4	27.6	24.0	26.9	24.0	33	Passed

Remark: values within applicant's declared power range (tune-up range)

FDD Band 4									
EUT		Set-up 4, Op. Mode 1							
Test case	Subtest No.	Power[dBm]						Limit	Result
		UARFCN no. 1312		UARFCN no. 1450		UARFCN no. 1513			
		PK	AV	PK	AV	PK	AV	[dBm]	
Release 99 12.2kbps RMC	--	27.5	24.3	27.5	24.3	27.5	24.5	30	Passed

Remark: values within applicant's declared power range (tune-up range)

FDD Band 5									
EUT		Set-up 4, Op. Mode 1							
Test case	Subtest No.	Power[dBm]						Limit	Result
		UARFCN no. 4132		UARFCN no. 4183		UARFCN no. 4233			
		PK	AV	PK	AV	PK	AV	[dBm]	
Release 99 12.2kbps RMC	--	27.4	24.4	27.5	24.2	27.4	24.0	38.4	Passed

Remark: values within applicant's declared power range (tune-up range)

5.4. RF-Parameter - Occupied bandwidth and emission bandwidth

5.4.1. Test location and equipments (for reference numbers please see chapter 'List of test equipment')

test site	<input type="checkbox"/> 347 Radio.lab. 1	<input checked="" type="checkbox"/> Radio.lab. 2			
spectr. analys.	<input type="checkbox"/> 584 FSU	<input type="checkbox"/> 489 ESU	<input type="checkbox"/> 264 FSEK	<input checked="" type="checkbox"/> 620 ESU26	
attenuator	<input checked="" type="checkbox"/> 530 10 dB	<input type="checkbox"/>	<input type="checkbox"/>		
signaling	<input type="checkbox"/> 392 MT8820A	<input type="checkbox"/> 436 CMU	<input checked="" type="checkbox"/> 547 CMU		
DC Power	<input checked="" type="checkbox"/> 611 E3636A	<input type="checkbox"/> 087 EA3013	<input checked="" type="checkbox"/> 354 NGPE 40	<input type="checkbox"/> 086 LNG50-10	
otherwise	<input checked="" type="checkbox"/> 529 6dB divider	<input type="checkbox"/> 431 Near field			
line voltage	<input type="checkbox"/> 230 V 50 Hz via public mains		<input type="checkbox"/> 060 110 V/ 60 Hz via PAS 5000		

5.4.2. Requirements and Limits

FCC	CFR47, §2.202(a), §2.1049, §22.917(b), §24.238(b); §27.53(h)(3)	„the occupied bandwidth is the frequency bandwidth, such that, below it lower and above it upper frequency limits, the mean powers radiated are each equal to 0.5 percent of the total mean power radiated”
IC	RSS-Gen, Issue 3: §4.6.1	
ANSI	C63.10-2009	

5.4.3. Test condition and test set-up

Climatic conditions		Temperature: (22±3°C)	Rel. humidity: (40±20)%
Test system set-up		Please see chapter “Test system set-up for conducted measurements at antenna port”	
Spectrum Analyzer Settings	Parameter	Occupied bandwidth:	Emission bandwidth
	Scan Mode Span RBW VBW Sweep time Sweep mode Detector	Spectrum analyser mode 6 MHz 50 kHz 300 kHz 60 Sec Single max-hold RMS	Spectrum analyser mode 6 MHz 50 kHz 300 kHz Coupled Repetitive, max-hold PK
Measurement method		The used spectrum analyzer FSE or ESU from Rohde & Schwarz contains an integrated function to calculate the occupied bandwidth automatically. From left and right display margin, the upper and lower frequency points where the accumulated power becomes 0.5% of the total power, are calculated. Subtracting the previous determined two frequency points, yields the occupied bandwidth.	Bandwidth defined between 2 markers with are 26dBc compared to highest In-Band Peak Emission.
Mobile phone settings		A call was established on highest power transmit conditions in RMC99 mode. The measurements were made at the low, middle and high carrier frequencies of each of the supported operating band. Choosing three TX-carrier frequencies of the mobile phone, should be sufficient to demonstrate compliance.	

5.4.4. Results

Operating mode/band	Channel no.		Occupied 99% bandwidth [MHz]	26 dBc Emission bandwidth [MHz]
	Range	No.		
Set-up 2, Op-Mode 1				
FDD Band 2	Low	9262	4.1730	4.6346
	Middle	9400	4.1730	4.6538
	High	9538	4.1730	4.6538
Set-up 2, Op-Mode 1				
FDD Band 4	Low	1312	4.1730	4.6346
	Middle	1450	4.1730	4.6346
	High	1512	4.1730	4.6346
Set-up 2, Op-Mode 1				
FDD Band 5	Low	4132	4.1826	4.6730
	Middle	4183	4.1923	4.6923
	High	4233	4.1730	4.6442

Remarks: see diagrams in separate annex 4

5.5. RF-Parameter - Conducted out of Band RF emissions and Band Edge

5.5.1. Test location and equipments (for reference numbers please see chapter 'List of test equipment')

test location	<input checked="" type="checkbox"/> CETECOM Essen (Chapter. 2.2.1)	<input type="checkbox"/> Please see Chapter. 2.2.2	<input type="checkbox"/> Please see Chapter. 2.2.3
test site	<input type="checkbox"/> 347 Radio.lab. 1	<input checked="" type="checkbox"/> Radio.lab. 2	
spectr. analys.	<input type="checkbox"/> 584 FSU	<input type="checkbox"/> 120 FSEM	<input type="checkbox"/> 264 FSEK <input checked="" type="checkbox"/> 489 ESU
signaling	<input type="checkbox"/> 017 CMD 65	<input type="checkbox"/> 323 CMD 55	<input type="checkbox"/> 340 CMD 55
signaling	<input type="checkbox"/> 392 MT8820A	<input type="checkbox"/> 436 CMU	<input checked="" type="checkbox"/> 670 CMU
power supply	<input checked="" type="checkbox"/> 611 E3636A	<input type="checkbox"/> 457 EA 3013A	<input type="checkbox"/> 459 EA 2032-50 <input type="checkbox"/> 268 EA- 3050 <input type="checkbox"/> 494 AG6632A <input type="checkbox"/> 498 NGPE 40
otherwise	<input checked="" type="checkbox"/> 529 6dB divider	<input checked="" type="checkbox"/> 530 10dB Att.	<input type="checkbox"/> 431 Near field
line voltage	<input type="checkbox"/> 230 V 50 Hz via public mains <input type="checkbox"/> 060 110 V/ 60 Hz via PAS 5000		

5.5.2. Requirements and limits

FCC	§2.1051-conducted, §2.1057, §22.917(a)(b), §24.238(a)(b), §27.53(h)(3)
IC	RSS-132, Issue 3: 5.5(i)(ii), RSS-133, Issue 5: 6.5.1(a)(i)(ii), RSS-139, Issue 2: 6.5 (i)(ii)
Limit	„the power of emissions shall be attenuated below the transmitter output power (p) by at least 43+10Log(P) dB“

5.5.3. Test condition and test set-up

Climatic conditions	Temperature: (22±3°C)	Rel. humidity: (40±20)%
Test system set-up	Please see chapter “Test system set-up for conducted measurements on antenna port”	
Measurement method	The spectrum was scanned from 9 kHz to the 10th harmonic of the highest frequency generated within the equipment. A PEAK detector was used except measurements near the block-edge where a AVERAGE detector applied. A suitable artificial antenna or RF-connector is provided by the applicant in order to perform the conducted measurements. Any data provided with the artificial antenna or connector, have been taken in account in order to correct the measurement data. (typical 0.3dB for attenuation of antenna connector)	
Spectrum-Analyzer settings	See below tables	
Mobile phone settings	A call was established on highest power transmit conditions in RMC99 mode. The measurements were made at the low, middle and high carrier frequencies of each of the supported operating band. Choosing three TX-carrier frequencies of the mobile phone, should be sufficient to demonstrate compliance.	

Spectrum-Analyzer settings for FDD Band 2

	Start freq. MHz	Stop freq. MHz	R-BW MHz	V-BW MHz	Sweep time sec.	Att. [dB]	Detector
Sweep 1 (subrange 1)	0.009	0.150	0.0001	-- ^{1.)}	10	25	MaxH-PK
Sweep 1 (subrange 2)	0.150	1	0.009	-- ^{1.)}	10	25	MaxH-PK
Sweep 1 (subrange 3)	1	30	0.1	-- ^{1.)}	5	25	MaxH-PK
Sweep 2 (subrange 1)	30	19500	1	-- ^{1.)}	>60	35	MaxH-PK
Sweep 3a (Block-Edge)	1849	1850	0.05	-- ^{1.)}	30	35	MaxH-PK
Sweep 3b (Block-Edge)	1849	1850	0.05	-- ^{1.)}	30	35	MaxH-AV
Sweep 4a (Block-Edge)	1910	1911	0.05	-- ^{1.)}	30	35	MaxH-PK
Sweep 4b (Block-Edge)	1910	1911	0.05	-- ^{1.)}	30	35	MaxH-AV

Remark: 1.) EMI 6dB receiver mode used

Spectrum-Analyzer Settings FDD Band 4

	Start freq. MHz	Stop freq. MHz	R-BW MHz	V-BW MHz	Sweep time sec.	Att.	Detector
Sweep 1 (subrange 1)	0.009	0.150	0.0001	-- ^{1.)}	10	25	MaxH-PK
Sweep 1 (subrange 2)	0.150	1	0.009	-- ^{1.)}	10	25	MaxH-PK
Sweep 1 (subrange 3)	1	30	0.1	-- ^{1.)}	5	25	MaxH-PK
Sweep 2 (subrange 1)	30	18000	1	-- ^{1.)}	>60	35	MaxH-PK
Sweep 3a (Block-Edge)	1709	1710	0.05	-- ^{1.)}	30	35	MaxH-PK
Sweep 3b (Block-Edge)	1709	1710	0.05	-- ^{1.)}	30	35	MaxH-AV
Sweep 4a (Block-Edge)	1755	1756	0.05	-- ^{1.)}	30	35	MaxH-PK
Sweep 4b (Block-Edge)	1755	1756	0.05	-- ^{1.)}	30	35	MaxH-AV

Remark: 1.) EMI 6dB receiver mode used

Spectrum-Analyzer Settings FDD Band 5

	Start freq. MHz	Stop freq. MHz	R-BW MHz	V-BW MHz	Sweep time sec.	Att.	Detector
Sweep 1 (subrange 1)	0.009	0.150	0.0001	-- ^{1.)}	10	25	MaxH-PK
Sweep 1 (subrange 2)	0.150	1	0.009	-- ^{1.)}	10	25	MaxH-PK
Sweep 1 (subrange 3)	1	30	0.1	-- ^{1.)}	5	25	MaxH-PK
Sweep 2 (subrange 1)	30	9000	1	-- ^{1.)}	>60	35	MaxH-PK
Sweep 3a (Block-Edge)	823	824	0.05	-- ^{1.)}	30	35	MaxH-PK
Sweep 3b (Block-Edge)	823	824	0.05	-- ^{1.)}	30	35	MaxH-AV
Sweep 4a (Block-Edge)	850	851	0.05	-- ^{1.)}	30	35	MaxH-PK
Sweep 4b (Block-Edge)	850	851	0.05	-- ^{1.)}	30	35	MaxH-AV

Remark: 1.) EMI 6dB receiver mode used

5.5.4. Results

The results are presented below in summary form only. For more information please see each diagram enclosed in annex 4.

5.5.4.1. FDD Band 2: Op. Mode 1, Set-up 2

Diagram no.	Carrier Channel		Frequency range	OP-mode no.	Remark	Used detector			Result
	Range	No.				PK	AV	QP	
36.60	Low	9262	9kHz to 30MHz	1	--	<input checked="" type="checkbox"/>	<input type="checkbox"/>	<input type="checkbox"/>	passed
36.61	Low		30 MHz to 19.5MHz		Carrier visible on diagram, not relevant for results	<input checked="" type="checkbox"/>	<input type="checkbox"/>	<input type="checkbox"/>	passed
37.60	Low		1849 – 1850 MHz		Band Edge Compliance	<input checked="" type="checkbox"/>	<input type="checkbox"/>	<input type="checkbox"/>	passed
36.62	Middle	9400	9kHz to 30MHz		--	<input checked="" type="checkbox"/>	<input type="checkbox"/>	<input type="checkbox"/>	passed
36.63	Middle		30 MHz to 19.5MHz		Carrier visible on diagram, not relevant for results	<input checked="" type="checkbox"/>	<input type="checkbox"/>	<input type="checkbox"/>	passed
36.64	High		9538		9kHz to 30MHz	--	<input checked="" type="checkbox"/>	<input type="checkbox"/>	<input type="checkbox"/>
36.65	High	30 MHz to 19.5MHz			Carrier visible on diagram, not relevant for results	<input checked="" type="checkbox"/>	<input type="checkbox"/>	<input type="checkbox"/>	passed
37.61	High	1910 – 1911 MHz			Band-Edge compliance	<input checked="" type="checkbox"/>	<input type="checkbox"/>	<input type="checkbox"/>	passed

Remark: --

5.5.4.2. FDD Band 4: Op. Mode 1, Set-up 2

Diagram no.	Carrier Channel		Frequency range	OP-mode no.	Remark	Used detector			Result
	Range	No.				PK	AV	QP	
36.70	Low	1312	9kHz to 30MHz	1	--	<input checked="" type="checkbox"/>	<input type="checkbox"/>	<input type="checkbox"/>	passed
36.71	Low		30 MHz to 19.5MHz		Carrier visible on diagram, not relevant for results	<input checked="" type="checkbox"/>	<input type="checkbox"/>	<input type="checkbox"/>	passed
37.70	Low		1709 -1710 MHz		Band Edge Compliance	<input checked="" type="checkbox"/>	<input type="checkbox"/>	<input type="checkbox"/>	passed
36.72	Middle	1450	9kHz to 30MHz		--	<input checked="" type="checkbox"/>	<input type="checkbox"/>	<input type="checkbox"/>	passed
36.73	Middle		30 MHz to 19.5MHz		Carrier visible on diagram, not relevant for results	<input checked="" type="checkbox"/>	<input type="checkbox"/>	<input type="checkbox"/>	passed
36.74	High		1513		9kHz to 30MHz	--	<input checked="" type="checkbox"/>	<input type="checkbox"/>	<input type="checkbox"/>
36.75	High	30 MHz to 19.5MHz			Carrier visible on diagram, not relevant for results	<input checked="" type="checkbox"/>	<input type="checkbox"/>	<input type="checkbox"/>	passed
37.71	High	1755 - 1756 MHz			Band-Edge compliance	<input checked="" type="checkbox"/>	<input type="checkbox"/>	<input type="checkbox"/>	passed

Remark: --

5.5.4.3. FDD Band 5: Op. Mode 1, Set-up 2

Diagram no.	Carrier Channel		Frequency range	OP-mode no.	Remark	Used detector			Result
	Range	No.				PK	AV	QP	
36.40	Low	4132	9kHz to 30MHz	1	--	<input checked="" type="checkbox"/>	<input type="checkbox"/>	<input type="checkbox"/>	passed
36.41	Low		30 MHz to 9GHz		Carrier visible on diagram, not relevant for results	<input checked="" type="checkbox"/>	<input type="checkbox"/>	<input type="checkbox"/>	passed
37.40	Low		823 – 824 MHz		Band Edge Compliance	<input checked="" type="checkbox"/>	<input type="checkbox"/>	<input type="checkbox"/>	passed
36.42	Middle	4183	9kHz to 30MHz		--	<input checked="" type="checkbox"/>	<input type="checkbox"/>	<input type="checkbox"/>	passed
36.43	Middle		30 MHz to 9GHz		Carrier visible on diagram,	<input checked="" type="checkbox"/>	<input type="checkbox"/>	<input type="checkbox"/>	passed
36.44	High	4233	9kHz to 30MHz		--	<input checked="" type="checkbox"/>	<input type="checkbox"/>	<input type="checkbox"/>	passed
36.45	High		30 MHz to 9GHz		Carrier visible on diagram,	<input checked="" type="checkbox"/>	<input type="checkbox"/>	<input type="checkbox"/>	passed
37.41	High		849 – 850 MHz		Band-Edge compliance	<input checked="" type="checkbox"/>	<input type="checkbox"/>	<input type="checkbox"/>	passed

Remark: --

5.6. RF-Parameter - Frequency stability on temperature and voltage variations

5.6.1. Test location and equipments (for reference numbers please see chapter 'List of test equipment')

test location	<input checked="" type="checkbox"/> CETECOM Essen (Chapter. 2.2.1)	<input type="checkbox"/> Please see Chapter. 2.2.2	<input type="checkbox"/> Please see Chapter. 2.2.3
test site	<input checked="" type="checkbox"/> 347 Radio.lab.1	<input type="checkbox"/> Radio.lab.2	<input type="checkbox"/>
spectr. analys.	<input type="checkbox"/> 584 FSU	<input type="checkbox"/> 489 ESU 40	<input type="checkbox"/> 264 FSEK <input type="checkbox"/> 620 ESU 26
signaling	<input type="checkbox"/> 392 MT8820A	<input type="checkbox"/> 436 CMU	<input checked="" type="checkbox"/> 547 CMU
DC power	<input type="checkbox"/> 456 EA 3013A	<input type="checkbox"/> 457 EA 3013A	<input type="checkbox"/> 459 EA 2032-50 <input type="checkbox"/> 268 EA- 3050 <input type="checkbox"/> 494 AG6632A <input type="checkbox"/> 498 NGPE 40
otherwise	<input checked="" type="checkbox"/> 529 6dB divider	<input checked="" type="checkbox"/> 530 10dB Att.	<input type="checkbox"/> 431 Near field
Climatic test chamber	<input checked="" type="checkbox"/> 331 HC 4055		
line voltage	<input type="checkbox"/> 230 V 50 Hz via public mains		<input type="checkbox"/> 060 110 V/ 60 Hz via PAS 5000

5.6.2. Requirements and limits

FCC	§2.1055(a)(1) , §22.355, §24.235, §27.54
IC	RSS-132, Issue 3: 5.3, RSS-133, Issue 6: 6.3; RSS-139, Issue 2: 6.3
Limit	<i>"The frequency stability shall be sufficient to ensure that the fundamental emission stays within the authorized frequency block"</i>

5.6.3. Test condition and test set-up

Test system set-up	Please see chapter "Test system set-up for conducted measurements on antenna port" In order to maintain the voltage constant over the time period of the tests, a dummy battery was connected to a laboratory power supply. The power supply voltage was controlled on the input of the power supply terminals of the EUT.
Measurement method	The RF Channel spacing is 200 kHz according W-CDMA-Spec, with a guard band. The aim of the EUT is to function under all extreme conditions within authorized sub-bands in regard to temperature and voltage variations. The frequency deviation was recorded with base station's build in capability. (CMU) As the standard requires that the fundamental emissions stays within the authorized band, a limit of 0.1ppm is considered low enough to ensure this.
Mobile phone settings	A call was established on highest power transmit conditions in RMC99 mode. The measurements were made at the low, middle and high carrier frequencies of each of the supported operating band. Choosing three TX-carrier frequencies of the mobile phone, should be sufficient to demonstrate compliance. Tests have been done in Rel99, 12.2 kbps RMC operating mode.

5.6.3.1. Frequency shift of carrier against a voltage range at constant nominal temperature of 20° Celsius

- 1.) determine the carrier frequency for the lowest and highest channel at room temperature and nominal voltage [20°C]
- 2.) The voltage was reduced in 0.1 Volt steps to the lower end point, where the mobile phone stops working. (this shall be specified by the manufacturer) Record the carrier frequency shift within 2 minutes after powering on the mobile phone, to prevent for self heating effects.
- 3.) The voltage was increased in 0.1 Volt steps to the upper declared voltage of the battery. Record the carrier frequency shift within 2 minutes after powering on the mobile phone, to prevent for self heating effects.

5.6.4. Measurement Results:

5.6.4.1. FDD Band 2

Voltage	Nominal Frequency	Maximum frequency error		Verdict
[V]	[MHz]	[Hz]	[ppm]	Limit=0.1ppm
3,20	1,88E+09	-12	-0,006	passed
3,30		-11	-0,006	
3,40		-12	-0,006	
3,50		-12	-0,006	
3,60		-11	-0,006	
3,70		-13	-0,007	
3,80		-11	-0,006	
3,90		-13	-0,007	
4,00		-12	-0,006	
4,10		-11	-0,006	
4,20		-12	-0,006	

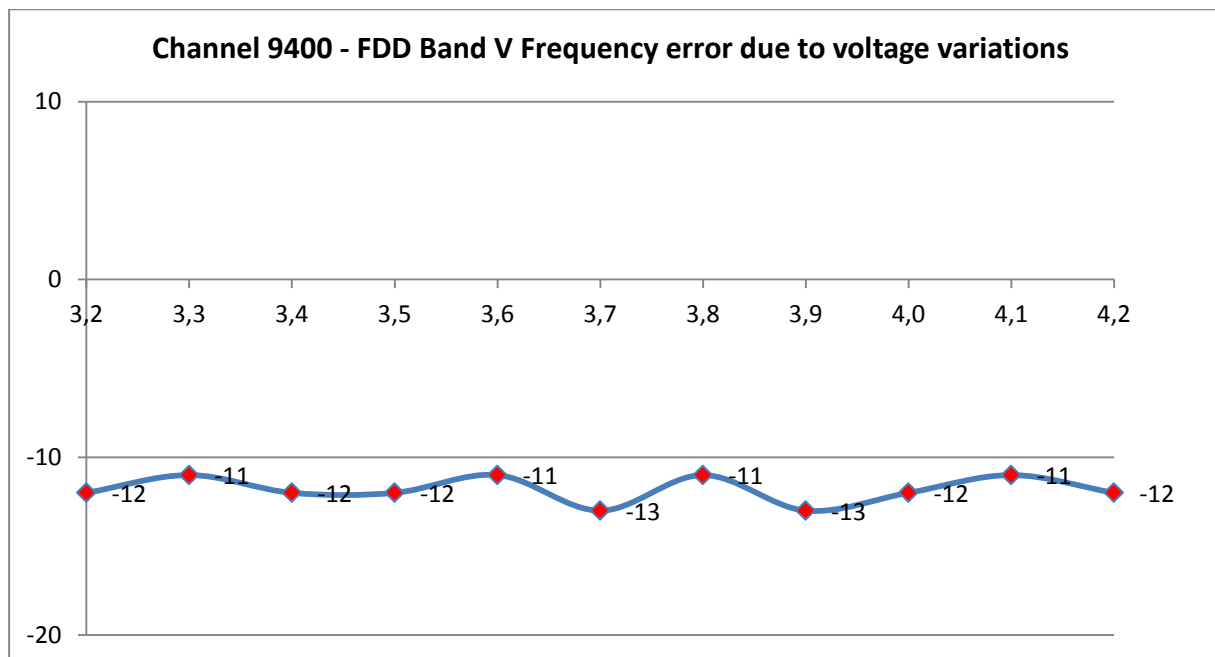

5.6.4.2. FDD Band 4

Voltage	Nominal Frequency	Maximum frequency error		Verdict
[V]	[MHz]	[Hz]	[ppm]	Limit=0.1ppm
3,20	1,74E+09	-16	-0,009	passed
3,30		-16	-0,009	
3,40		-16	-0,009	
3,50		-17	-0,010	
3,60		-16	-0,009	
3,70		-16	-0,009	
3,80		-15	-0,009	
3,90		-15	-0,009	
4,00		-15	-0,009	
4,10		-14	-0,008	
4,20		-13	-0,007	

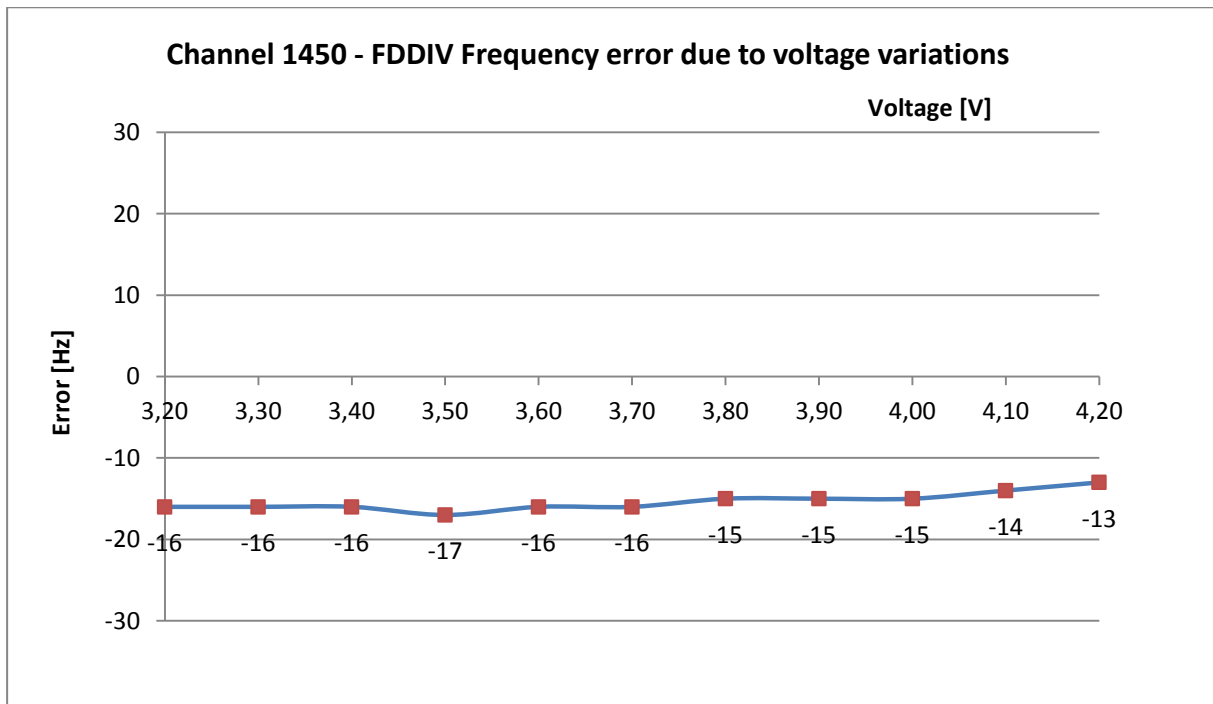

5.6.4.3. FDD Band 5

Voltage	Nominal Frequency	Maximum frequency error		Verdict
[V]	[MHz]	[Hz]	[ppm]	Limit=0.1ppm
3,20	8,3660E+08	5	0,006	passed
3,30		-4	-0,005	
3,40		4	0,005	
3,50		4	0,005	
3,60		-5	-0,006	
3,70		-5	-0,006	
3,80		5	0,006	
3,90		4	0,005	
4,00		-4	-0,005	
4,10		4	0,005	
4,20		-4	-0,005	

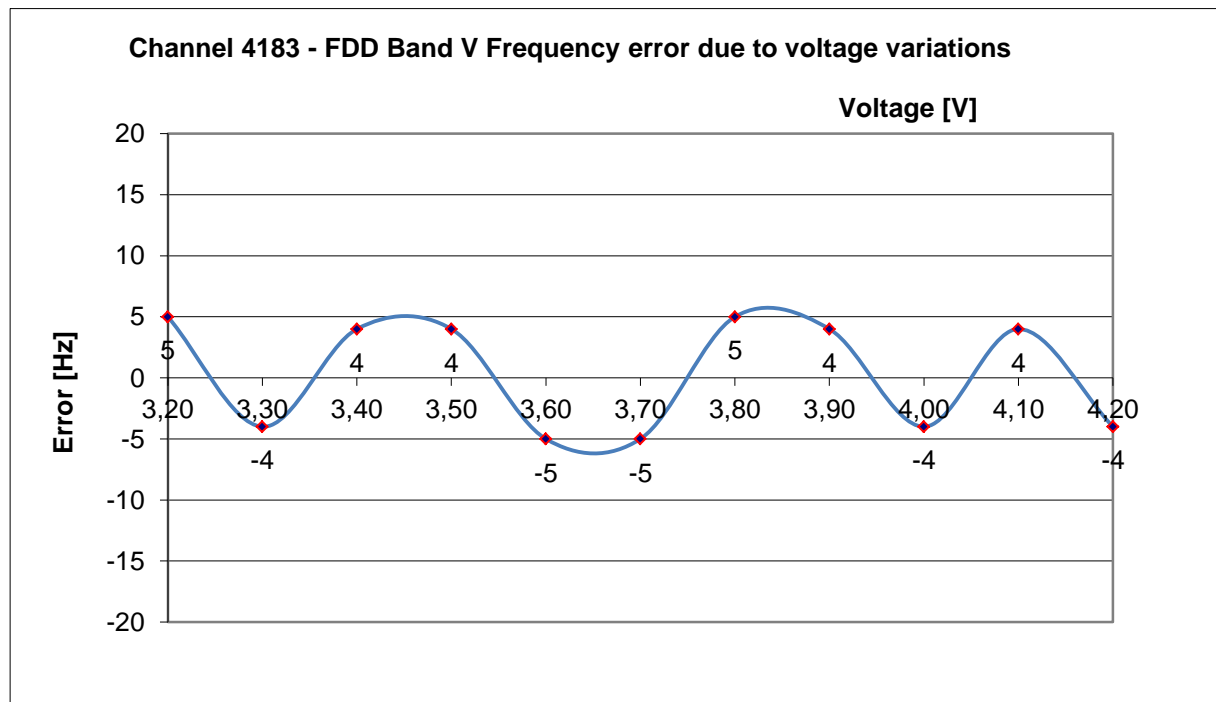

5.6.4.4. Frequency shift of carrier against temperature at constant power supply voltage

- 1.) determine the carrier frequency for the lowest, middle and highest channel at room temperature and nominal voltage [20°C]
- 2.) expose the mobile station to -30°C, wait sufficient time to have constant temperature.
- 3.) Perform the carrier frequencies measurements in 10°C increments from -30°C to +60°C. For about half hour at the specified temperature the mobile was powered-off. After powering-on, the measurements were made within 2 minute for the channel lower channel, in order to prevent self-warming of the mobile.

5.6.4.5. FDD Band 2

Temperature	Maximum frequency error						Verdict Limit=±0.1ppm
	Channel 9262	Channel 9400	Channel 9538	Channel 9262	Channel 9400	Channel 9538	
	[Hz]			[ppm]			
-30°C	-12,06	-9,33	-9,39	-0,007	-0,005	-0,005	Passed
-20°C	-14,29	-10,19	-6,13	-0,008	-0,005	-0,003	
-10°C	-16,90	-11,06	-6,00	-0,009	-0,006	-0,003	
0°C	-17,21	-10,95	-8,16	-0,009	-0,006	-0,004	
10°C	-17,60	-12,68	-10,42	-0,010	-0,007	-0,005	
20°C	7,37	-12,4	5,24	0,004	-0,007	0,003	
30°C	-10,75	-12,74	-17,21	-0,006	-0,007	-0,009	
40°C	-8,89	-13,50	-18,85	-0,005	-0,007	-0,010	
50°C	9,00	-14,02	-21,17	0,005	-0,007	-0,011	

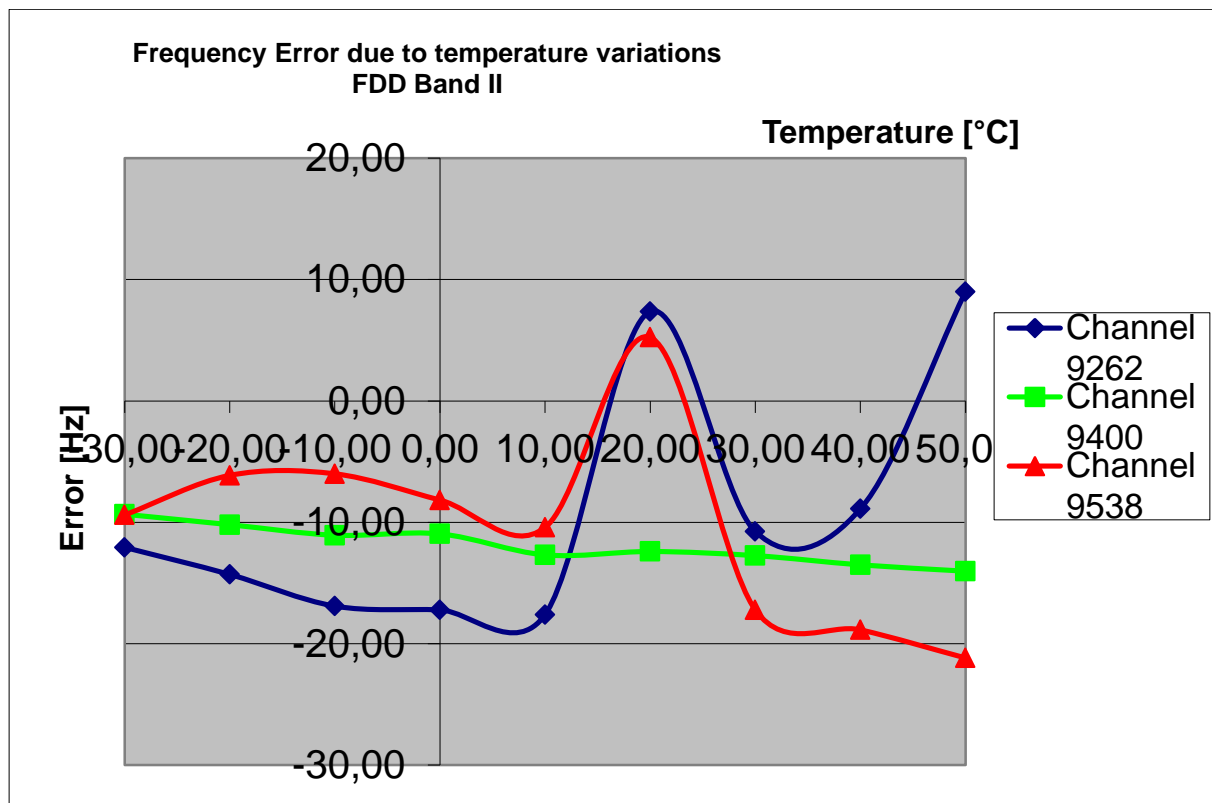

5.6.4.6. FDD Band 4

Maximum frequency error							Verdict Limit=±0.1ppm
Temperature	Channel 1312	Channel 1450	Channel 1513	Channel 4132	Channel 4183	Channel 4233	
	[Hz]			[ppm]			
-30°C	-12,26	--	-12,46	-0,015	--	-0,015	Passed
-20°C	-21,28	--	18,34	-0,026	--	0,022	
-10°C	-30,47	--	20,26	-0,037	--	0,024	
0°C	-28,38	--	18,18	-0,034	--	0,021	
10°C	-18,12	--	11,91	-0,022	--	0,014	
20°C	-14,45	--	-11,82	-0,017	--	-0,014	
30°C	16,12	--	-21,91	0,020	--	-0,026	
40°C	29,25	--	-29,98	0,035	--	-0,035	
50°C	27,75	--	-33,92	0,034	--	-0,040	

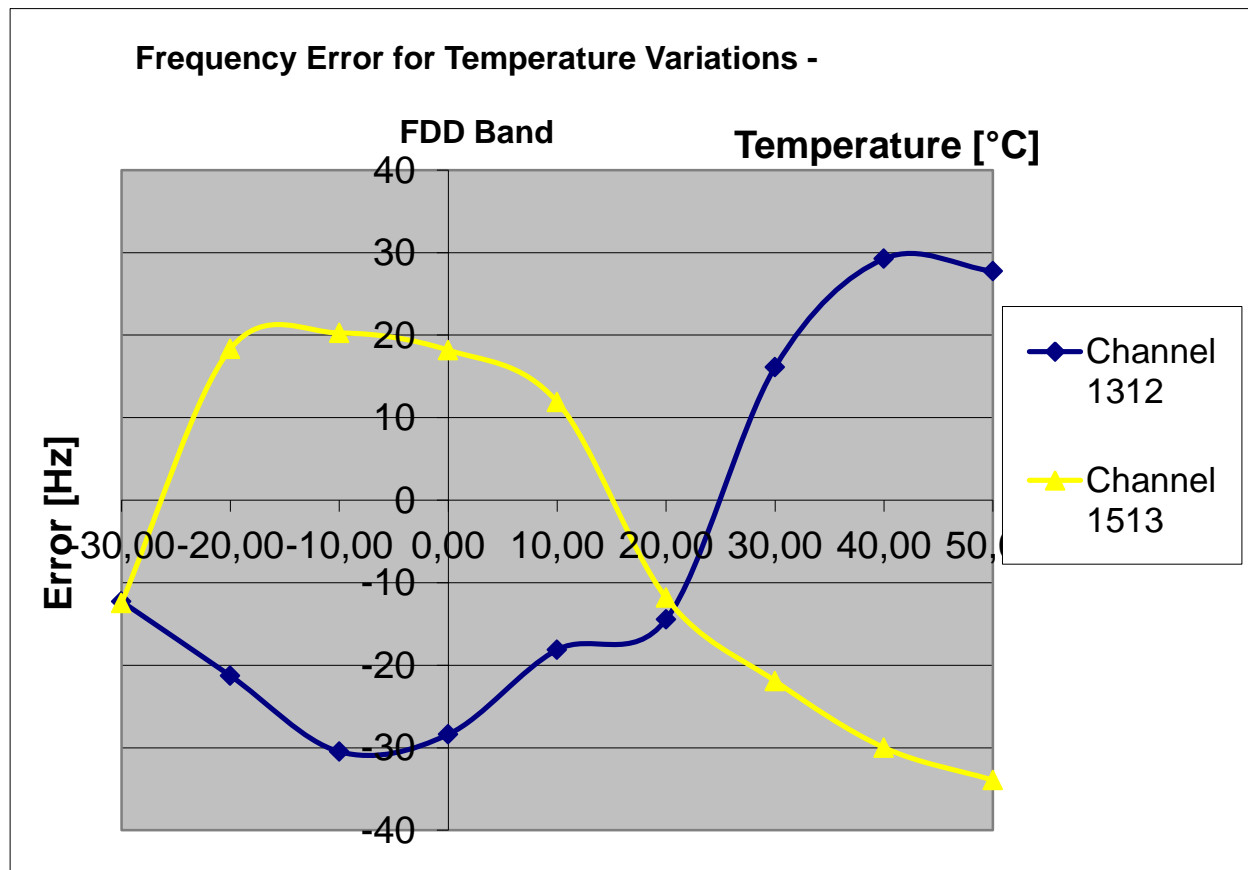

5.6.4.7. FDD Band 5

Maximum frequency error							Verdict Limit=±0.1ppm
Temperature	Channel 4132	Channel 4183	Channel 4233	Channel 4132	Channel 4183	Channel 4233	
	[Hz]			[ppm]			
-30°C	7,5	5,76	7,06	0,009	0,007	0,008	Passed
-20°C	-6,88	-5,18	6,98	-0,008	-0,006	0,008	
-10°C	-6,43	4,34	7,64	-0,008	0,005	0,009	
0°C	-7,38	4,77	5,92	-0,009	0,006	0,007	
10°C	-6,24	-5,15	4,34	-0,008	-0,006	0,005	
20°C	-5,7	-4,45	-6,08	-0,007	-0,005	-0,007	
30°C	5,64	-4,63	-6,79	0,007	-0,006	-0,008	
40°C	9,96	6,66	-7,65	0,012	0,008	-0,009	
50°C	7,09	-4,79	-7,56	0,009	-0,006	-0,009	

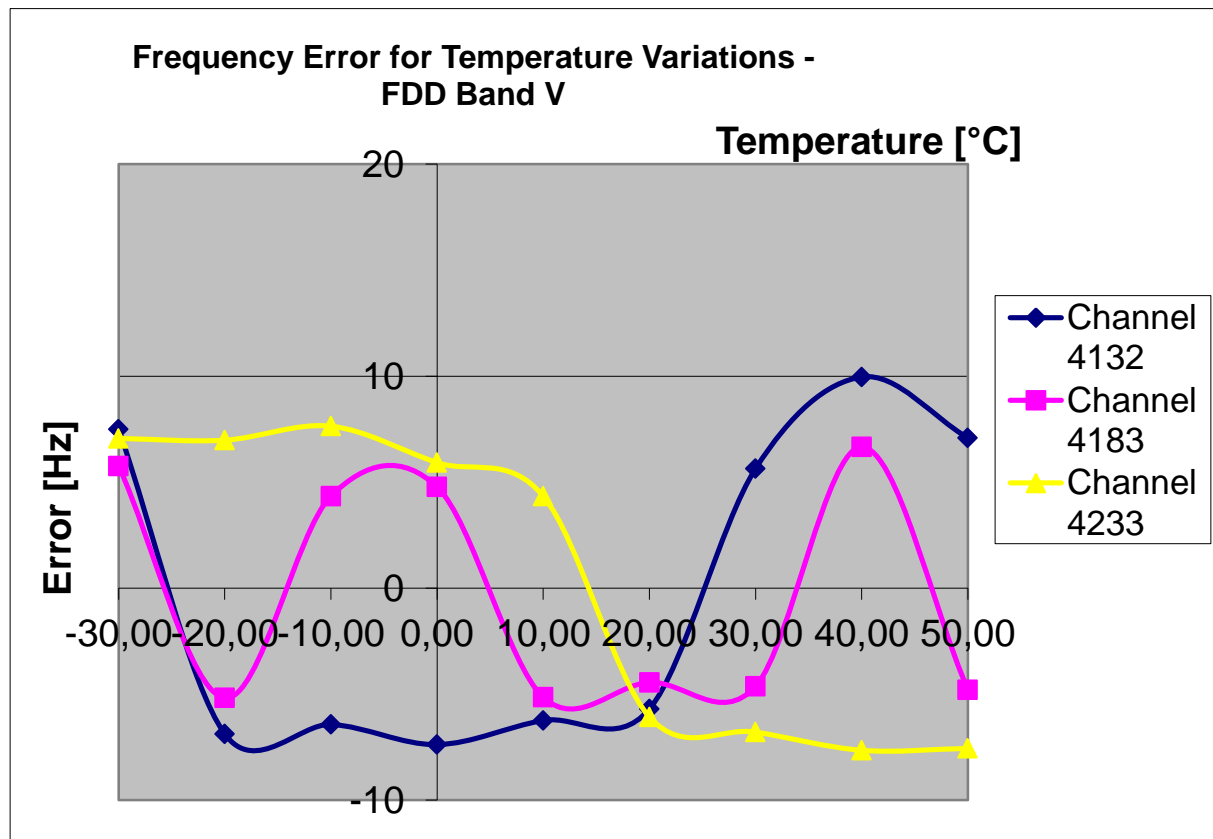

5.7. Measurement uncertainties

The reported uncertainties are calculated based on the standard uncertainty multiplied with the appropriate coverage factor **k**, such that a confidence level of approximately 95% is achieved.

For uncertainty determination, each component used in the concrete measurement set-up was taken in account and it's contribution to the overall uncertainty according it's statistical distribution calculated.

Following table shows expectable uncertainties for each measurement type performed.

RF-Measurement	Frequency range	Calculated uncertainty based on a confidence level of 95%	Remarks:
Power Output conducted	9 kHz .. 20 GHz	1.0 dB	--
Power Output radiated	30 MHz .. 4 GHz	3.17 dB	Substitution method
Conducted emissions on antenna ports	9 kHz .. 20 GHz	1.0 dB	--
Radiated emissions enclosure	150 kHz .. 30 MHz	5.0 dB	Magnetic field
	30 MHz .. 1 GHz	4.2 dB	E-Field
	1 GHz .. 20 GHz	3.17 dB	Substitution method
Occupied bandwidth	9 kHz .. 4 GHz	0.1272 ppm (Delta Marker)	Frequency error
		1.0 dB	Power
Emission bandwidth	9 kHz .. 4 GHz	0.1272 ppm (Delta Marker)	Frequency error
		1.0 dB	Power
Frequency stability	9 kHz .. 20 GHz	0.0636 ppm	--
Conducted emissions on AC-mains port (U _{CISPR})	9 kHz .. 150 kHz	4.0 dB	--
	150 kHz .. 30 MHz	3.6 dB	--

Table: measurement uncertainties, valid for conducted/radiated measurements

6. Abbreviations used in this report

The abbreviations	
ANSI	American National Standards Institute
AV , AVG, CAV	Average detector
EIRP	Equivalent isotropically radiated power, determined within a separate measurement
EGPRS	Enhanced General Packet Radio Service
EUT	Equipment Under Test
FCC	Federal Communications Commission, USA
IC	Industry Canada
n.a.	not applicable
Op-Mode	Operating mode of the equipment
PK	Peak
RBW	resolution bandwidth
RF	Radio frequency
RSS	Radio Standards Specification, Dokuments from Industry Canada
Rx	Receiver
TCH	Traffic channel
Tx	Transmitter
QP	Quasi peak detector
VBW	Video bandwidth
ERP	Effective radiated power

7. Accreditation details of CETECOM’s laboratories and test sites

Ref.-No.	Accreditation Certificate	Valid for laboratory area or test site	Accreditation Body
-	D-PL-12047-01-01	All laboratories and test sites of CETECOM GmbH, Essen	DAkkS, Deutsche Akkreditierungsstelle GmbH
337 487 558 348 348	736496	Radiated Measurements 30 MHz to 1 GHz, 3 m / 10 m (OATS) Radiated Measurements 30 MHz to 1 GHz, 3 m (SAR) Radiated Measurements above 1 GHz, 3 m (FAR) Mains Ports Conducted Interference Measurements Telecommunication Ports Conducted Interference Measur.	FCC, Federal Communications Commission Laboratory Division, USA (MRA US-EU 0003)
337 487 550 558	3462D-1 3462D-2 3462D-2 3462D-3	Radiated Measurements 30 MHz to 1 GHz, 3 m / 10 m (OATS) Radiated Measurements 30 MHz to 1 GHz, 3 m (SAR) Radiated Measurements 1 GHz to 6 GHz, 3 m (SAR) Radiated Measurements above 1 GHz, 3 m (FAR)	IC, Industry Canada Certification and Engineering Bureau
337 487 550 348 348	R-2665 R-2666 G-301 C-2914 T-1967	Radiated Measurements 30 MHz to 1 GHz, 3 m / 10 m (OATS) Radiated Measurements 30 MHz to 1 GHz, 3 m (SAR) Radiated Measurements 1 GHz to 6 GHz, 3 m (SAR) Mains Ports Conducted Interference Measurements Telecommunication Ports Conducted Interference Measur.	VCCI, Voluntary Control Council for Interference by Information Technology Equipment, Japan
OATS = Open Area Test Site, SAR = Semi Anechoic Room, FAR = Fully Anechoic Room			

8. Instruments and Ancillary

8.1. Used equipment “CTC”

The “Ref.-No” in the left column of the following tables allows the clear identification of the laboratory equipment.

8.1.1. Test software and firmware of equipment

Ref.-No.	Equipment	Type	Serial-No.	Version of Firmware or Software during the test
001	EMI Test Receiver	ESS	825132/017	Firm.= 1.21 , OTP=2.0, GRA=2.0
012	Signal Generator (EMS-cond.)	SMY 01	839069/027	Firm.= V 2.02
013	Power Meter (EMS cond.)	NRVD	839111/003	Firm.= V 1.51
017	Digital Radiocommunication Tester	CMD 60 M	844365/014	Firmware = V 3.52 .22.01.99, DECT = D2.87 13.01.99
053	Audio Analyzer	UPA3	860612/022	Firm. V 4.3
119	RT Harmonics Analyzer dig. Flickermeter	B10	G60547	Firm.= V 3.1DHG
140	Signal Generator	SMHU	831314/006	Firm.= 3.21
261	Thermal Power Sensor	NRV-Z55	825083/0008	EPROM-Datum 02.12.04, SE EE 1 B
262	Power Meter	NRV-S	825770/0010	Firm.= 2.6
263	Signal Generator	SMP 04	826190/0007	Firm.=3.21
264	Spectrum Analyzer	FSEK 30	826939/005	Bios=2.1, Analyzer= 3.20
295	Racal Digital Radio Test Set	6103	1572	UNIT Firmware= 4.04, SW-Main=4.04, SW-BBP=1.04, SW-DSP=1.02, Hardboot=1.02, Softboot=2.02
298	Univ. Radio Communication Tester	CMU 200	832221/091	R&S Test Firmware =3.53 /3.54 (current Testsoftw. f. all band used
323	Digital Radiocommunication Tester	CMD 55	825878/0034	Firm.= 3.52 .22.01.99
331	Climatic Test Chamber -40/+80 Grad	HC 4055	43146	TSI 1.53
335	CTC-EMS-Conducted	System EMS Conducted	-	EMC 32 V 8.52
340	Digital Radiocommunication Tester	CMD 55	849709/037	Firm.= 3.52 .22.01.99
355	Power Meter	URV 5	891310/027	Firm.= 1.31
365	10V Insertion Unit 50 Ohm	URV5-Z2	100880	Eprom Data = 31.03.08
366	Ultra Compact Simulator	UCS 500 M4	V0531100594	Firm. UCS 500=001925/3.06a02, rc=ISMIEC 4.10
371	Bluetooth Tester	CBT32	100153	CBT V5.30+ SW-Option K55, K57
377	EMI Test Receiver	ESCS 30	100160	Firm.= 2.30, OTP= 02.01, GRA= 02.36
378	Broadband RF Field Monitor	RadiSense III	03D00013SNO-08	Firm.= V.03D13
383	Signal Generator	SME 03	842 828 /034	Firm.= 4.61
389	Digital Multimeter	Keithley 2000	0583926	Firm. = A13 (Mainboard) A02 (Display)
392	Radio Communication Tester	MT8820A	6K00000788	Firm.= 4.50 #005, IPL=4.01#001,OS=4.02#001, GSM=4.41#013, W-CDMA= 4.54#004, scenario= 4.52#002
436	Univ. Radio Communication Tester	CMU 200	103083	R&S Test Firmware Base=5.14, Mess-Software= GSM;5.14 WCDMA:5.14 (current Testsoftw. F. all band
441	CTC-SAR-EMI Cable Loss	System EMI field (SAR)	-	EMC 32 Version 8.52
442	CTC-SAR-EMS	System EMS field (SAR)	-	EMC 32 Version 8.40
443	CTC-FAR-EMI-RSE	System CTC-FAR-EMI-RSE	-	Spuri 7.2.5 or EMC 32 Ver. 8.53
444	CTC-FAR-EMS field	System-EMS-Field (FAR)	-	EMC 32 Version 8.40
460	Univ. Radio Communication Tester	CMU 200	108901	R&S Test Firmware Base=5.14, GSM=5.14 WCDMA=5.14 (current Testsoftw.,f. all band to be used,
489	EMI Test Receiver	ESU40	1000-30	Firmware=4.43 SP3, Bios=V5.1-16-3, Spec. =01.00
491	ESD Simulator dito	ESD dito	dito307022	V 2.30
524	Voltage Drop Simulator	VDS 200	0196-16	Software Nr: 000037 Version V4.20a01
526	Burst Generator	EFT 200 A	0496-06	Software Nr. 000034 Version V2.32
527	Micro Pulse Generator	MPG 200 B	0496-05	Software-Nr. 000030 Version V2.43
528	Load Dump Simulator	LD 200B	0496-06	Software-Nr. 000031 Version V2.35a01
546	Univ. Radio Communication Tester	CMU 200	106436	R&S Test Firmware Base=5.14, GSM=5.14 WCDMA=5.14 (current Testsoftw.,f. all band to be used
547	Univ. Radio Communication Tester	CMU 200	835390/014	R&S Test Firmware Base=V5.1403 (current Testsoftw., f. all band used, GSM = 5.14 WCDMA: = 5.14
584	Spectrum Analyzer	FSU 8	100248	2.82_SP3
594	Wideband Radio Communication Tester	CMW 500	101757	Firmware Base=2.0.20.9, LTE=2.0.20.8, CDMA= 2.0.10
597	Univ. Radio Communication Tester	CMU 200	100347	R&S Test Firmware Base=5.01, GSM=5.02 WCDMA= not installed, Mainboard= µP1=V.850
598	Spectrum Analyzer	FSEM 30 (Reserve)	831259/013	Firmware Bios 3.40 , Analyzer 3.40 Sp 2
620	EMI Test Receiver	ESU 26	100362	4.43_SP3
642	Wideband Radio Communication Tester	CMW 500	126089	Setup V03.26, Test programm component V02.12.01

8.1.2. Single instruments and test systems

Ref.-No.	Equipment	Type	Serial-No.	Manufacturer	Interval of calibration	Remark	Cal due
001	EMI Test Receiver	ESS	825132/017	Rohde & Schwarz	12 M	-	31.03.2014
005	AC - LISN (50 Ohm/50µH, test site 1)	ESH2-Z5	861741/005	Rohde & Schwarz	24/12 M	-	31.03.2014
007	Single-Line V-Network (50 Ohm/5µH)	ESH3-Z6	892563/002	Rohde & Schwarz	24/12 M	-	31.03.2014
009	Power Meter (EMS-radiated)	NRV	863056/017	Rohde & Schwarz	24 M	-	31.03.2015
016	Line Impedance Simulating Network	Op. 24-D	B6366	Spitzenberger+Spies	36 M	-	31.03.2016
020	Horn Antenna 18 GHz (Subst 1)	3115	9107-3699	EMCO	36/12 M	-	31.03.2014
021	Loop Antenna (H-Field)	6502	9206-2770	EMCO	36 M	-	31.03.2015
030	Loop Antenna (H-field)	HFH-Z2	879604/026	Rohde & Schwarz	36 M	-	31.03.2015
033	RF-current probe (100kHz-30MHz)	ESH2-Z1	879581/18	Rohde & Schwarz	24 M	-	31.03.2015
057	relay-switch-unit (EMS system)	RSU	494440/002	Rohde & Schwarz	pre-m	1a	
060	power amplifier (DC-2kHz)	PAS 5000	B6363	Spitzenberger+Spies	-	3	
066	notch filter (WCDMA; FDD1)	WRCT 1900/2200-5/40-10EEK	5	Wainwright GmbH	12 M	1g	30.06.2014
086	DC - power supply, 0 -10 A	LNG 50-10	-	Heinzinger Electronic	pre-m	2	
087	DC - power supply, 0 -5 A	EA-3013 S	-	Elektro Automatik	pre-m	2	
090	Helmholtz coil: 2x10 coils in series	-	-	RWTÜV	-	4	
091	USB-LWL-Converter	OLS-1	007/2006	Ing. Büro Scheiba	-	4	
099	passive voltage probe	ESH2-Z3	299.7810.52	Rohde & Schwarz	36 M	-	31.03.2015
100	passive voltage probe	Probe TK 9416	without	Schwarzbeck	36 M	-	31.03.2015
110	USB-LWL-Converter	OLS-1	-	Ing. Büro Scheiba	-	4	
119	RT Harmonics Analyzer dig. Flickermeter	B10	G60547	BOCONSULT	36 M	-	31.03.2016
134	horn antenna 18 GHz (Subst 2)	3115	9005-3414	EMCO	pre-m	-	
136	adjustable dipole antenna (Dipole 1)	3121C-DB4	9105-0697	EMCO	36 M	-	31.03.2015
140	Signal Generator	SMHU	831314/006	Rohde & Schwarz	24 M	-	31.03.2014
248	attenuator	SMA 6dB 2W	-	Radiall	pre-m	2	
249	attenuator	SMA 10dB 10W	-	Radiall	pre-m	2	
252	attenuator	N 6dB 12W	-	Radiall	pre-m	2	
256	attenuator	SMA 3dB 2W	-	Radiall	pre-m	2	
257	hybrid	4031C	04491	Narda	pre-m	2	
260	hybrid coupler	4032C	11342	Narda	pre-m	2	
261	Thermal Power Sensor	NRV-Z55	825083/0008	Rohde & Schwarz	24 M	-	31.03.2014
262	Power Meter	NRV-S	825770/0010	Rohde & Schwarz	24 M	-	31.03.2014
263	Signal Generator	SMP 04	826190/0007	Rohde & Schwarz	36 M	-	31.03.2016
264	Spectrum Analyzer	FSEK 30	826939/005	Rohde & Schwarz	12 M	-	31.03.2014
265	peak power sensor	NRV-Z33, Model 04	840414/009	Rohde & Schwarz	24 M	-	31.03.2014
266	peak power sensor	NRV-Z31, Model 04	843383/016	Rohde & Schwarz	24 M	-	31.03.2014
267	notch filter GSM 850	WRCA 800/960-6EEK	9	Wainwright GmbH	pre-m	2	
270	termination	1418 N	BB6935	Weinschel	pre-m	2	
271	termination	1418 N	BE6384	Weinschel	pre-m	2	
272	attenuator (20 dB) 50 W	Model 47	BF6239	Weinschel	pre-m	2	
273	attenuator (10 dB) 100 W	Model 48	BF9229	Weinschel	pre-m	2	
274	attenuator (10 dB) 50 W	Model 47 (10 dB) 50 W	BG0321	Weinschel	pre-m	2	
275	DC-Block	Model 7003 (N)	C5129	Weinschel	pre-m	2	
276	DC-Block	Model 7006 (SMA)	C7061	Weinschel	pre-m	2	
279	power divider	1515 (SMA)	LH855	Weinschel	pre-m	2	
287	pre-amplifier 25MHz - 4GHz	AMF-2D-100M4G-35-10P	379418	Miteq	12 M	1c	30.06.2014
291	high pass filter GSM 850/900	WHJ 2200-4EE	14	Wainwright GmbH	12 M	1c	30.06.2014
298	Univ. Radio Communication Tester	CMU 200	832221/091	Rohde & Schwarz	pre-m	3	
300	AC LISN (50 Ohm/50µH, 1-phase)	ESH3-Z5	892 239/020	Rohde & Schwarz	24/12 M	-	31.03.2014
301	attenuator (20 dB) 50W, 18GHz	47-20-33	AW0272	Lucas Weinschel	pre-m	2	
302	horn antenna 40 GHz (Meas 1)	BBHA9170	155	Schwarzbeck	36 M	-	31.03.2014
303	horn antenna 40 GHz (Subst 1)	BBHA9170	156	Schwarzbeck	36 M	-	31.03.2014
331	Climatic Test Chamber -40/+80 Grad	HC 4055	43146	Heraeus Vötsch	24 M	-	30.11.2014
341	Digital Multimeter	Fluke 112	81650455	Fluke	24 M	-	31.03.2014
342	Digital Multimeter	Voltcraft M-4660A	IB 255466	Voltcraft	24 M	-	31.03.2015
347	laboratory site	radio lab.	-	-	-	5	
348	laboratory site	EMI conducted	-	-	-	5	
354	DC - Power Supply 40A	NGPE 40/40	448	Rohde & Schwarz	pre-m	2	
355	Power Meter	URV 5	891310/027	Rohde & Schwarz	24 M	-	31.03.2014
356	power sensor	NRV-Z1	882322/014	Rohde & Schwarz	24 M	-	31.03.2015
357	power sensor	NRV-Z1	861761/002	Rohde & Schwarz	24 M	-	31.03.2015
371	Bluetooth Tester	CBT32	100153	R&S	24 M	-	31.03.2014
373	Single-Line V-Network (50 Ohm/5µH)	ESH3-Z6	100535	Rohde & Schwarz	24/12 M	-	31.03.2014
376	Horn Antenna 6 GHz	BBHA9120 E	BBHA 9120 E.179	Schwarzbeck	12 M	-	31.03.2014
377	EMI Test Receiver	ESCS 30	100160	Rohde & Schwarz	12 M	-	31.03.2014
389	Digital Multimeter	Keithley 2000	0583926	Keithley	24 M	-	31.03.2015
392	Radio Communication Tester	MT8820A	6K00000788	Anritsu	12 M	-	31.03.2014
431	Model 7405	Near-Field Probe Set	9305-2457	EMCO	-	4	
436	Univ. Radio Communication Tester	CMU 200	103083	Rohde & Schwarz	12 M	-	31.03.2014
441	CTC-SAR-EMI Cable Loss	System EMI field (SAR) Cable	-	CETECOM	12 M	5	31.10.2013

Ref.-No.	Equipment	Type	Serial-No.	Manufacturer	Interval of calibration	Remark	Cal due
443	CTC-FAR-EMI-RSE	System CTC-FAR-EMI-RSE	-	ETS-Lindgren / CETECOM	12 M	5	15.07.2014
449	notch filter WCDMA FDD V	WRCT 824.0/894.0-5/40-8SSK	1	Wainwright	12 M	1c	30.06.2014
454	Oscilloscope	HM 205-3	9210 P 29661	Hameg	-	4	
456	DC-Power supply 0-5 A	EA 3013 S	207810	Elektro Automatik	pre-m	2	
459	DC -Power supply 0-5 A , 0-32 V	EA-PS 2032-50	910722	Elektro Automatik	pre-m	2	
460	Univ. Radio Communication Tester	CMU 200	108901	Rohde & Schwarz	12 M	-	31.03.2014
463	Universal source	HP3245A	2831A03472	Agilent	-	4	
466	Digital Multimeter	Fluke 112	89210157	Fluke USA	24 M	-	31.03.2014
467	Digital Multimeter	Fluke 112	89680306	Fluke USA	24 M	-	31.03.2014
468	Digital Multimeter	Fluke 112	90090455	Fluke USA	24 M	-	31.03.2014
477	ReRadiating GPS-System	AS-47	-	Automotive Cons. Fink	-	3	
480	power meter (Fula)	NRVS	838392/031	Rohde & Schwarz	24 M	-	31.03.2015
482	filter matrix	Filter matrix SAR 1	-	CETECOM (Brl)	-	1d	
487	System CTC NSA-Verification SAR-EMI	System EMI field (SAR) NSA	-	ETS Lindgren / CETECOM	24 M	-	30.06.2015
489	EMI Test Receiver	ESU40	1000-30	Rohde & Schwarz	12 M	-	31.03.2014
502	band reject filter	WRCG 1709/1786-1699/1796-	SN 9	Wainwright	pre-m	2	
503	band reject filter	WRCG 824/849-814/859-	SN 5	Wainwright	pre-m	2	
512	notch filter GSM 850	WRCA 800/960-02/40-6EEK	SN 24	Wainwright	12 M	1c	30.06.2014
517	relais switch matrix	HF Relais Box Keithley	SE 04	Keithley	pre-m	2	
523	Digital Multimeter	L4411A	MY46000154	Agilent	24 M	-	31.03.2015
529	6 dB Broadband resistive power divider	Model 1515	LH 855	Weinschel	pre-m	2	
530	10 dB Broadband resistive power divider	R 416110000	LOT 9828	-	pre-m	2	
546	Univ. Radio Communication Tester	CMU 200	106436	R&S	12 M	-	31.03.2014
547	Univ. Radio Communication Tester	CMU 200	835390/014	Rohde & Schwarz	12 M	-	31.03.2014
548	Digital-Barometer	GBP 2300	without	Greisinger GmbH	36 M	-	30.06.2015
549	Log-Per-Antenna	HL025	1000060	Rohde & Schwarz	36/12 M	-	31.03.2015
552	high pass filter 2,8-18GHz	WHKX 2.8/18G-10SS	4	Wainwright	12 M	1c	30.06.2013
558	System CTC FAR S-VSWR	System CTC FAR S-VSWR	-	CTC	24 M	-	31.07.2013
574	Biconilog Hybrid Antenna	BTA-L	980026L	Frankonia	36/12 M	-	31.03.2016
584	Spectrum Analyzer	FSU 8	100248	Rohde & Schwarz	24 M	-	31.03.2014
594	Wideband Radio Communication Tester	CMW 500	101757	Rohde & Schwarz	24 M	-	31.03.2014
597	Univ. Radio Communication Tester	CMU 200	100347	Rohde & Schwarz	12 M	-	31.03.2014
598	Spectrum Analyzer	FSEM 30 (Reserve)	831259/013	Rohde & Schwarz	24 M	-	13.01.2015
600	power meter	NRVD (Reserve)	834501/018	Rohde & Schwarz	24 M	-	31.03.2015
601	medium-sensitivity diode sensor	NRV-Z5 (Reserve)	8435323/003	Rohde & Schwarz	24 M	-	31.03.2015
602	peak power sensor	NRV-Z32 (Reserve)	835080	Rohde & Schwarz	24 M	-	31.03.2015
608	UltraLog-Antenna	HL 562	830547/009	Rohde & Schwarz	36/12 M	-	31.03.2014
611	DC power supply	E3632A	KR 75305854	Agilent	pre-m	2	
612	DC power supply	E3632A	MY 40001321	Agilent	pre-m	2	
613	Attenuator	R416120000 20dB 10W	Lot. 9828	Radiall	pre-m	2	
616	Digitalmultimeter	Fluke 177	88900339	Fluke	24 M	-	31.03.2014
617	Power Splitter/Combiner	ZFSC-2-2-S+	S F987001108	Mini Circuits	-	2	
618	Power Splitter/Combiner	50PD-634	600994	JFW Industries USA	-	2	
619	Power Splitter/Combiner	50PD-634	600995	JFW Industries, USA	-	3	
620	EMI Test Receiver	ESU 26	100362	Rohde-Schwarz	12 M	-	01.03.2014
621	Step Attenuator 0-139 dB	RSP	100017	Rohde & Schwarz	pre-m	2	
625	Generic Test Load USB	Generic Test Load USB	-	CETECOM	-	2	
627	data logger	OPUS 1	201.0999.9302.6.4.1.4 3	G. Luft GmbH	24 M	-	30.05.2014
634	Spectrum Analyzer	FSM (HF-Unit)	826188/010	Rohde & Schwarz	pre-m	2	
636	Thermal Imaging camera	Ti32	Ti32-12060213	Fluke Corporation	24 M	-	31.07.2014
637	High Speed HDMI with Ethernet 1m	HDMI cable with Ethernet 1m	-	KogiLink	-	2	
638	HDMI Kabel with Ethernet 1,5 m flach	HDMI cable with Ethernet	-	Reichelt	-	2	
640	HDMI cable 2m rund	HDMI cable 2m rund	-	Reichelt	-	2	
641	HDMI cable with Ethernet	Certified HDMI cable with	-	PureLink	-	2	
642	Wideband Radio Communication Tester	CMW 500	126089	Rohde&Schwarz	24 M	-	31.03.2014
644	Amplifier	ZX60-2534M+	SN865701299	Mini-Circuits	-	-	
670	Univ. Radio Communication Tester	CMU 200	106833	Rohde & Schwarz	12 M	-	31.03.2014
671	DC-power supply 0-5 A	EA-3013S	-	Elektro Automatik	pre-m	2	

8.1.3. Legend

Note / remarks		Calibrated during system calibration:
	1a	System CTC-SAR-EMS (Ref.-No. 442)

	1b	System-CTC-EMS-Conducted (Ref.-No. 335)
	1c	System CTC-FAR-EMI-RSE (Ref.-No . 443)
	1d	System CTC-SAR-EMI (Ref.-No . 441)
	1e	System CTC-OATS (EMI radiated) (Ref.-No. 337)
	1 f	System CTC-CTIA-OTA (Ref.-No . 420)
	1 g	System CTC-FAR-EMS (Ref.-No . 444)
	2	Calibration or equipment check immediately before measurement
	3	Regulatory maintained equipment for functional check or support purpose
	4	Ancillary equipment without calibration e.g. mechanical equipment or monitoring equipment
	5	Test System

Interval of calibration	12 M	12 month
	24 M	24 month
	36 M	36 month
	24/12 M	Calibration every 24 months, between this every 12 months internal validation
	36/12 M	Calibration every 36 months, between this every 12 months internal validation
	Pre-m	Check before starting the measurement
	-	Without calibration