



- Rugged low profile design
- Excellent bandwidth

The Panorama LPB low profile antenna range has been designed to perform even in extreme environments. At only 82mm (3.22") high and protected by a robust high impact radome the antenna is almost impervious to daily wear, tear and impact.

The LPB offers excellent performance across a wide bandwidth. Mounted on a 400 x 400mm groundplane the LPB covers public safety / LTE frequencies across 700 and 800MHz as well as all global cellular frequencies from 698-960 MHz and 1710-2700MHz making it an extremely versatile product.

Supplied with a convenient adhesive pad and either a short pigtail for connection to a cable extension or an integrated 5m low loss cable run the antenna is cost effective to install and adaptable to any install environment.

Technical Drawing

(Nominal measures)

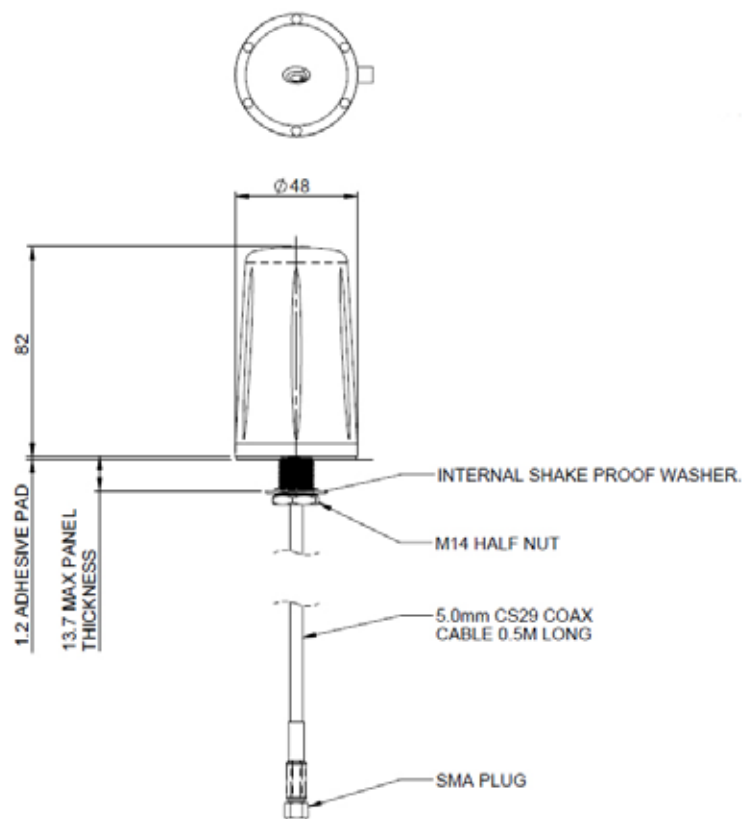

Typical VSWR

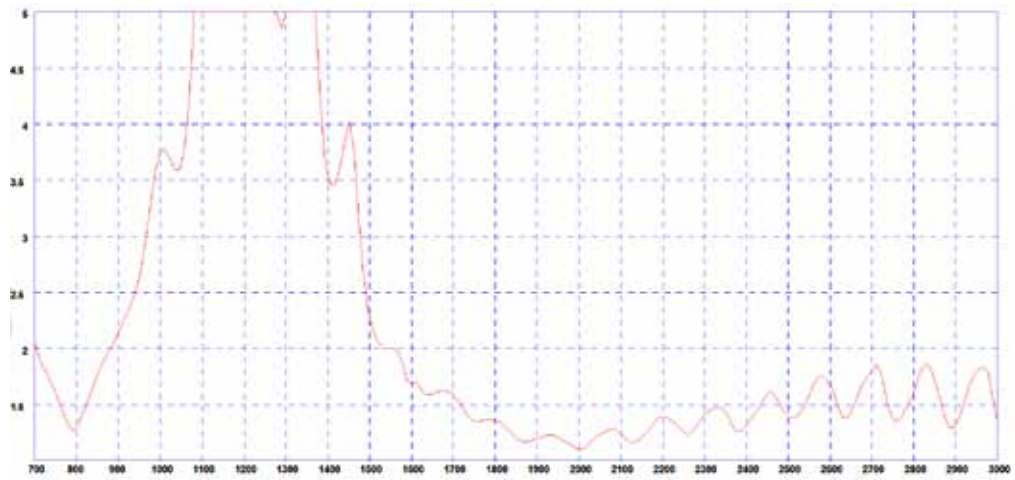

Typical Efficiency

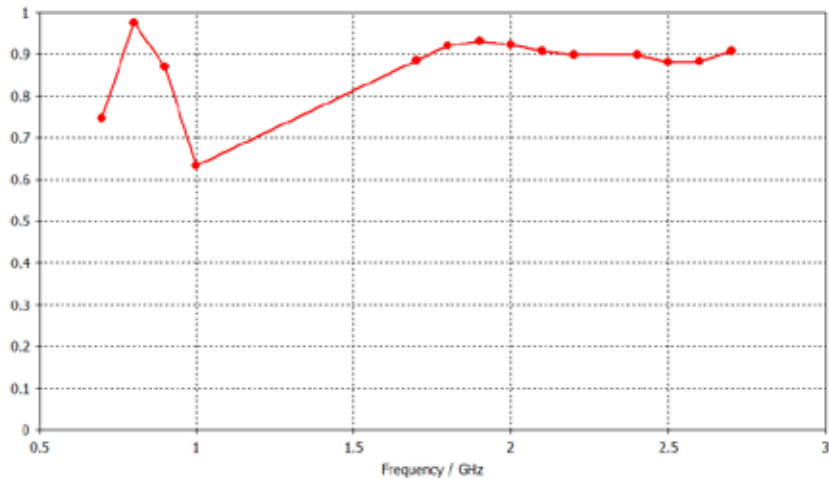

3D Gain Plot (700MHz)

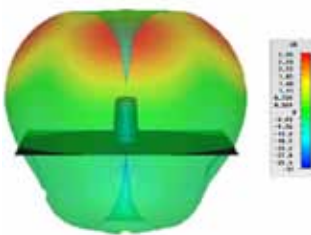

3D Gain Plot (800MHz)

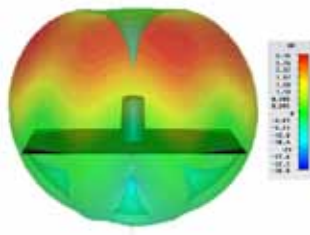

3D Gain Plot (900MHz)

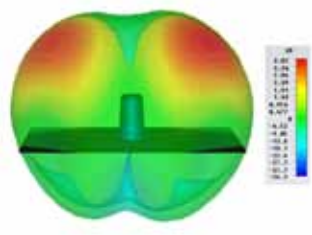

3D Gain Plot (1800MHz)

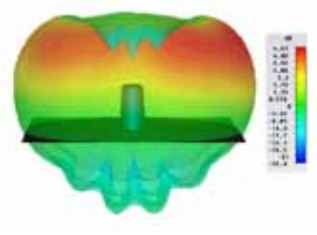

3D Gain Plot (1900MHz)

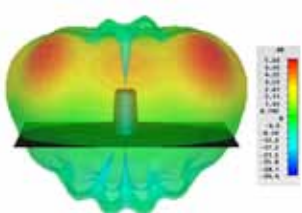

3D Gain Plot (2100MHz)

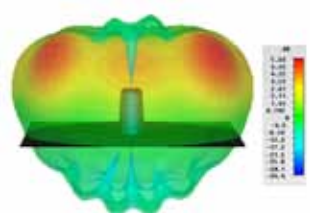

3D Gain Plot (2400MHz)

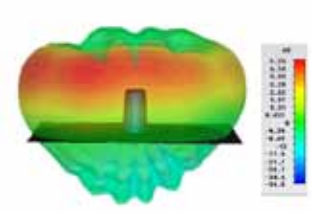

3D Gain Plot (2600MHz)

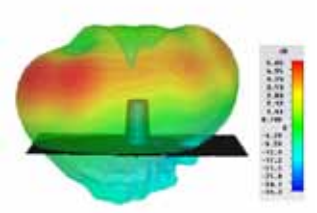

All measurements taken on a 400 x 400mm groundplane with 0.5m of cable

Part No.		LPB-7-27-05SP	LPB-7-27-5SP	LPB-7-27-5F
Electrical Data				
Frequency Range (MHz)		698-960 / 1710-2700		
Operational Band		700/800/900/1800/1900/2100/ 2400/2600		
Peak Realised Gain: Isotropic	700 MHz	3dBi		
	800 MHz	3dBi		
	900 MHz	4dBi		
	1800 MHz	4dBi		
	1900 MHz	5dBi		
	2100 MHz	5dBi		
	2400 MHz	5dBi		
	2600 MHz	5dBi		
VSWR		<2.5:1		
Polarisation		Vertical		
Pattern		Omni-directional		
Impedance		50Ω		
Max Input Power (W)		30		
Mechanical Data				
Dimensions (mm)	Height	82 (3.22")		
	Diameter	48(1.89")		
Operating Temp (°C)		-40° / +80°C (-40° / 176°F)		
Material		High Impact UV Stable ABS		
Colour		Black		
Mounting Data				
Fixing		Panel mount		
Hole Diameter (mm)		14 (0.5")		
Max Panel Thickness (mm)		13 (0.5")		
Cable Data				
Type		5mm low loss coax		
Diameter (mm)		5(0.19")		
Length (m)	0.5(19.6")	5(16')	5(16')	
Termination	SMA plug	SMA plug	FME plug	



Panorama Antennas Ltd
Frogmore, London, SW18 1HF, United Kingdom

T: +44 (0)20 8877 4444
F: +44 (0)20 8877 4477
E: sales@panorama-antennas.com
www.panorama-antennas.com

Waiver: The data given above is indicative of the performance of the product/s under particular conditions and does not imply a guarantee of performance. These specifications are subject to change without notice.

Copyright © Panorama Antennas Ltd. All rights reserved.

www.panorama-antennas.com/