

TEST RESULTS (Cont):

Highest Channel

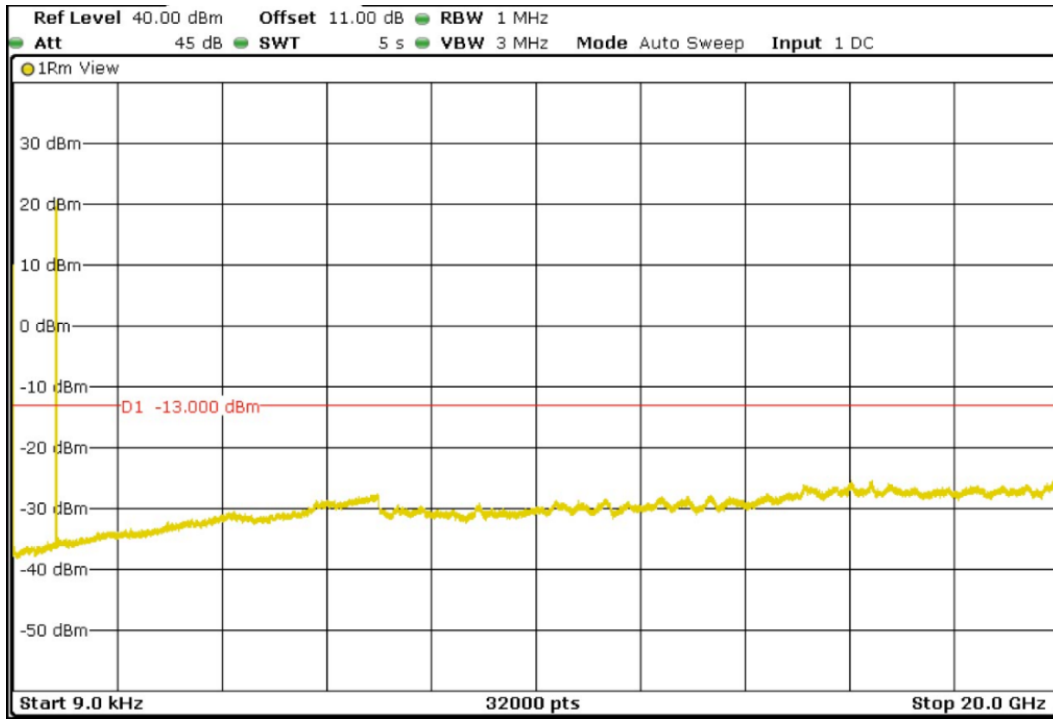

LTE QPSK MODULATION. BW = 3 MHz

Lowest Channel

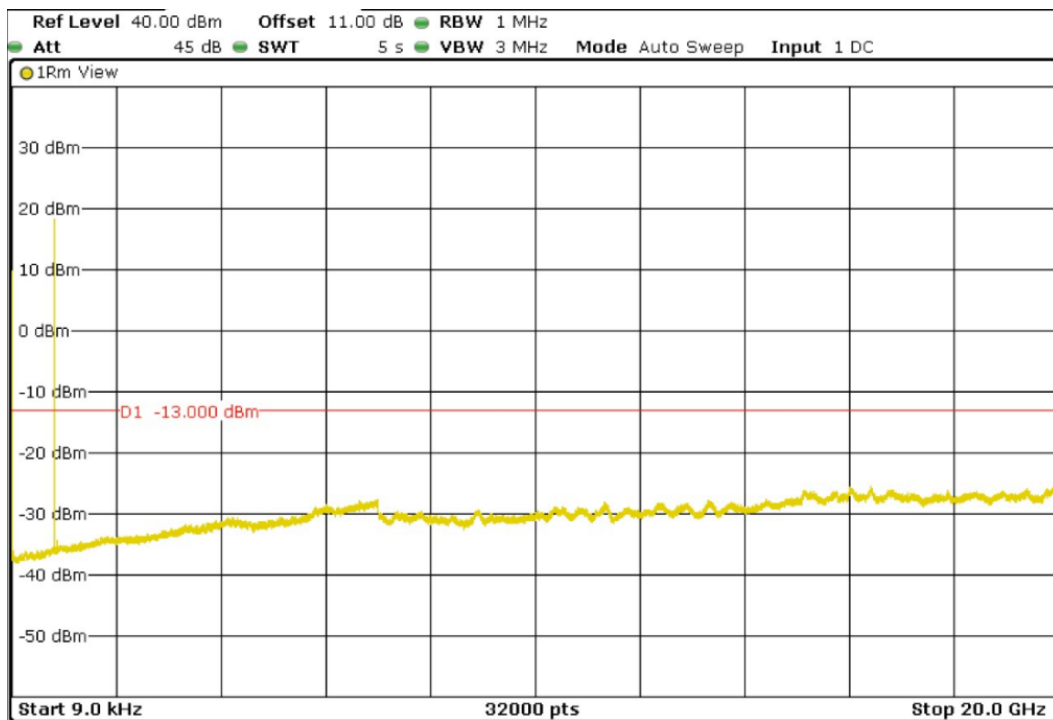

TEST RESULTS (Cont):

LTE QPSK MODULATION. BW = 15 MHz

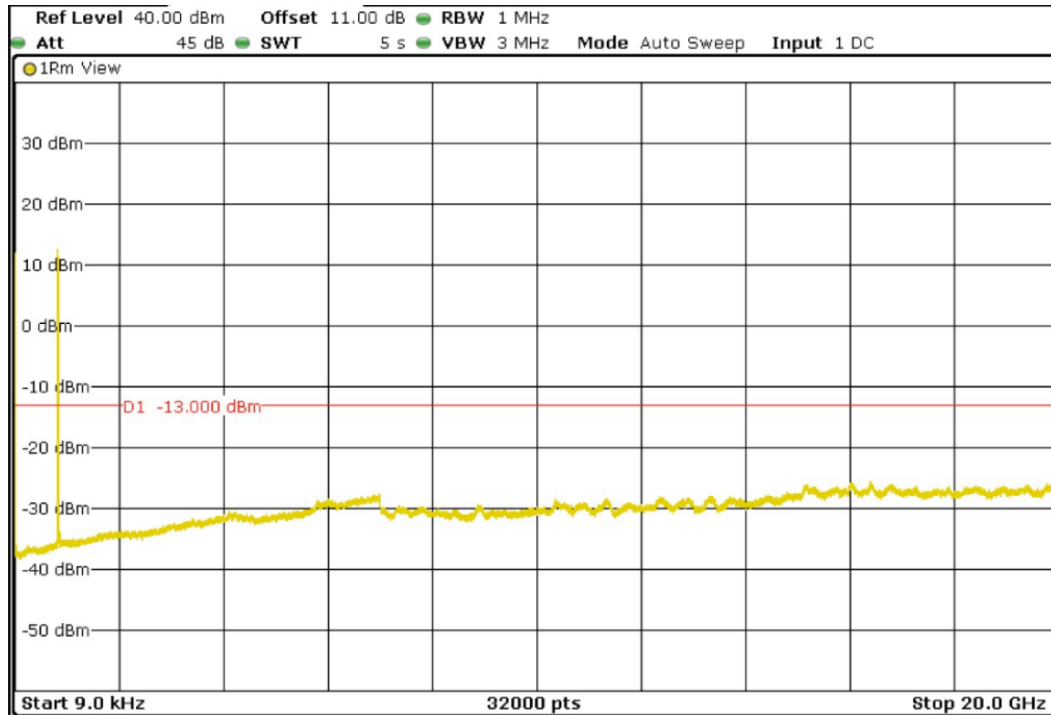

TESTED SAMPLES:	S/01
TESTED CONDITIONS MODES:	TC#02
TEST RESULTS:	PASS
<p><u>Frequency range 9 kHz – 18 GHz</u></p> <p>LTE QPSK MODULATION. BW = 1.4 MHz</p> <p>Lowest Channel The spurious signals were detected more than 10 dB below the limit in the frequency range.</p> <p>Middle Channel The spurious signals were detected more than 10 dB below the limit in the frequency range.</p> <p>Highest Channel The spurious signals were detected more than 10 dB below the limit in the frequency range.</p> <p>LTE QPSK MODULATION. BW = 3 MHz</p> <p>Lowest Channel The spurious signals were detected more than 10 dB below the limit in the frequency range.</p> <p>Middle Channel The spurious signals were detected more than 10 dB below the limit in the frequency range.</p> <p>Highest Channel The spurious signals were detected more than 10 dB below the limit in the frequency range.</p> <p>LTE QPSK MODULATION. BW = 5 MHz</p> <p>Lowest Channel The spurious signals were detected more than 10 dB below the limit in the frequency range.</p> <p>Middle Channel The spurious signals were detected more than 10 dB below the limit in the frequency range.</p> <p>Highest Channel The spurious signals were detected more than 10 dB below the limit in the frequency range.</p> <p>LTE QPSK MODULATION. BW = 10 MHz</p> <p>Lowest Channel The spurious signals were detected more than 10 dB below the limit in the frequency range.</p> <p>Middle Channel The spurious signals were detected more than 10 dB below the limit in the frequency range.</p> <p>Highest Channel The spurious signals were detected more than 10 dB below the limit in the frequency range.</p> <p>LTE QPSK MODULATION. BW = 15 MHz</p> <p>Lowest Channel The spurious signals were detected more than 10 dB below the limit in the frequency range.</p> <p>Middle Channel The spurious signals were detected more than 10 dB below the limit in the frequency range.</p> <p>Highest Channel The spurious signals were detected more than 10 dB below the limit in the frequency range.</p>	

TEST RESULTS (Cont):

LTE QPSK MODULATION. BW = 1.4 MHz

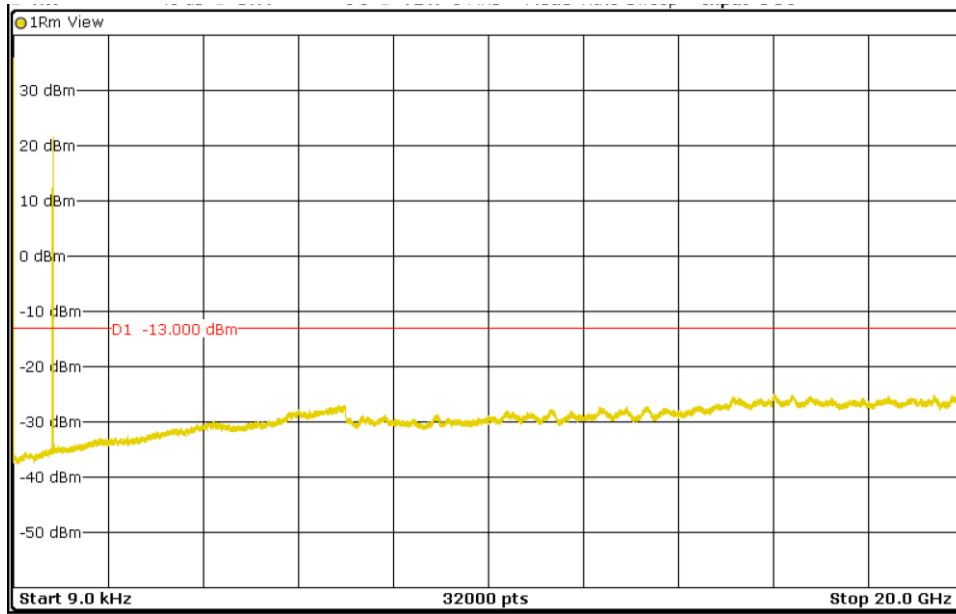

LTE QPSK MODULATION. BW = 3 MHz

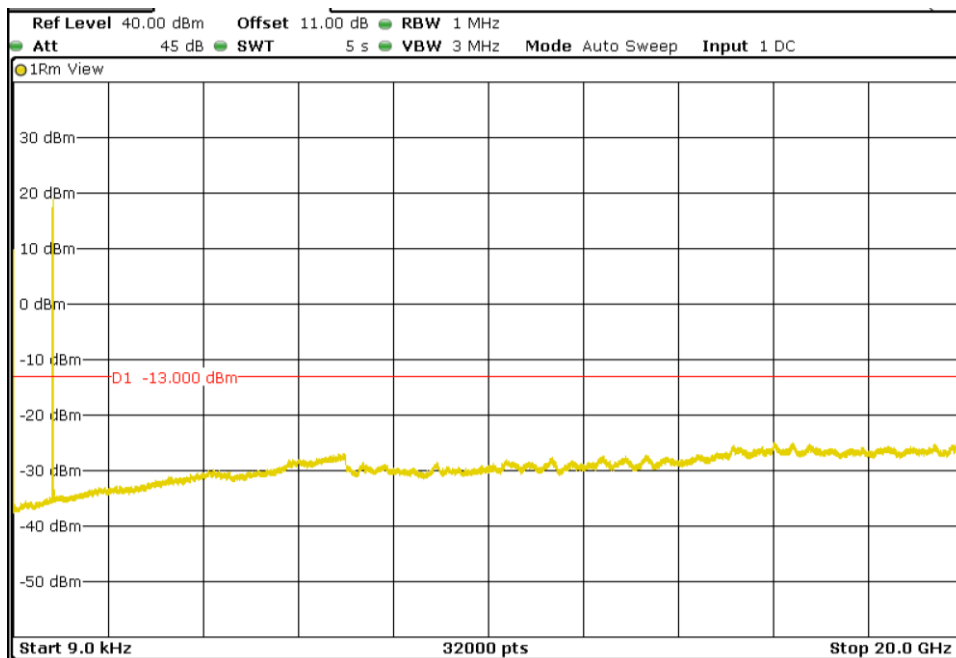

TEST RESULTS (Cont):

LTE QPSK MODULATION. BW = 5 MHz

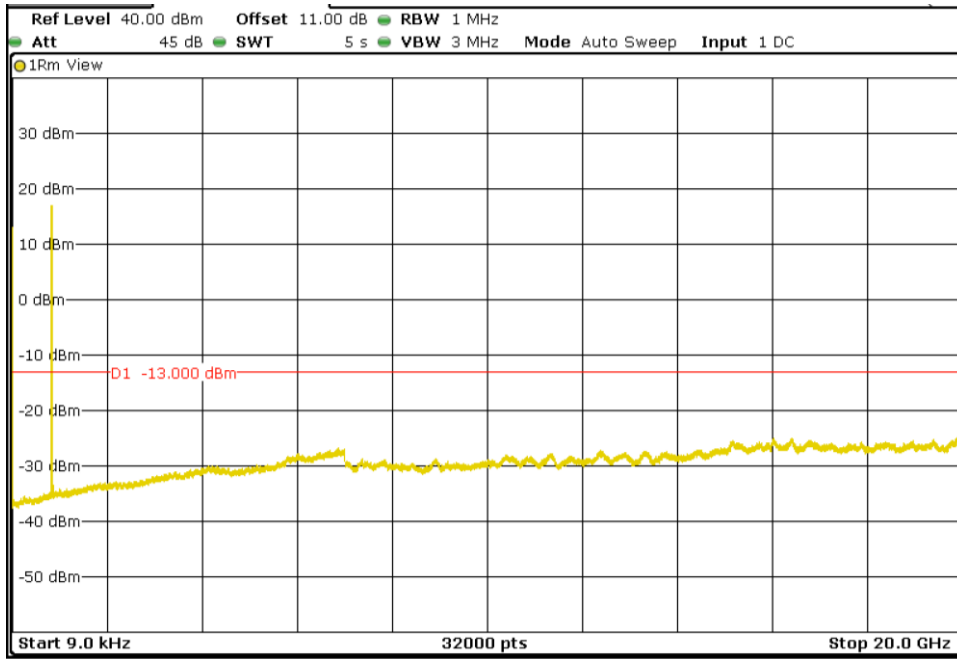

LTE QPSK MODULATION. BW = 10 MHz

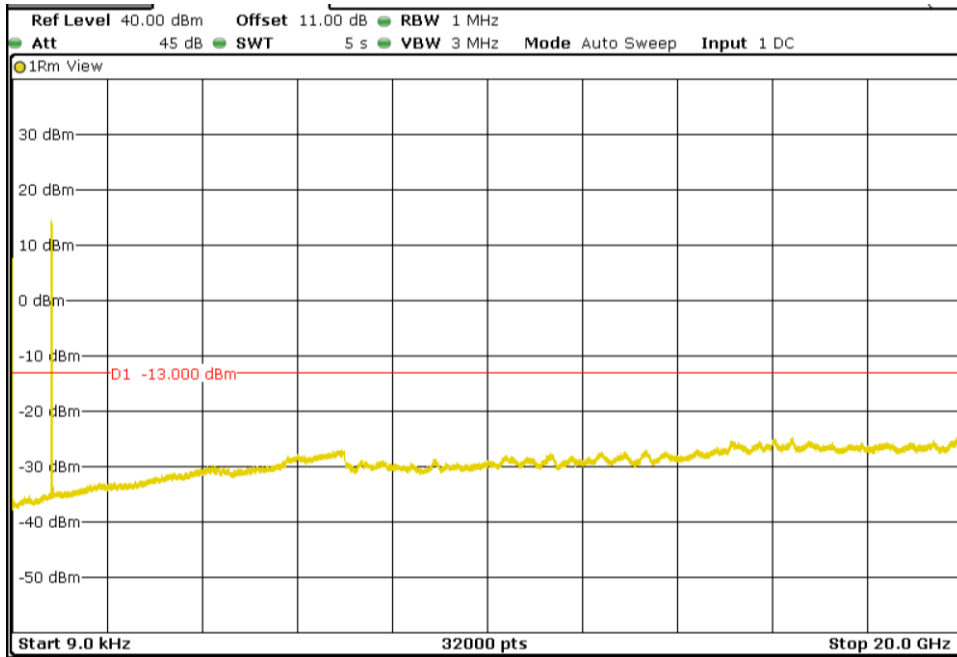

TEST RESULTS (Cont):

LTE QPSK MODULATION. BW = 15 MHz

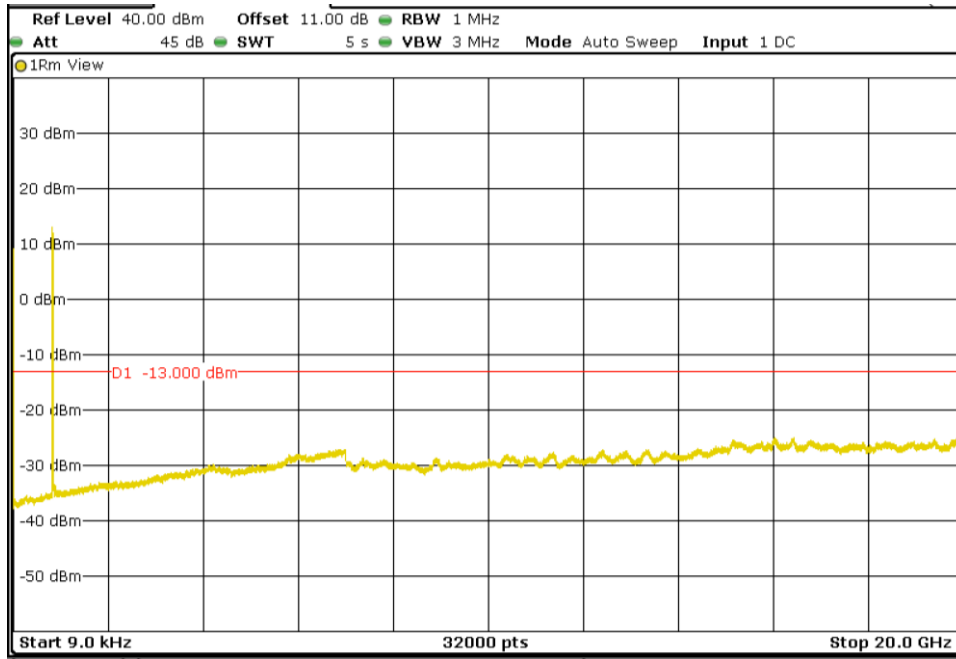

TEST A.6: SPURIOUS EMISSIONS AT ANTENNA TERMINALS AT BLOCK EDGES

LIMITS:	Product standard:	FCC Part 90
	Test standard:	FCC §2.1051 and 90.691

LIMITS

According to specification, the power of emissions shall be attenuated below the transmitter power (P) by a factor of at least $43 + 10 \log (P)$ dB P in watts.

At P_o transmitting power of 2 watts (33 dBm), the specified minimum attenuation becomes $43+10\log (P_o)$. and the level in dBm relative to P_o becomes:

$$P_o \text{ (dBm)} - [43 + 10 \log (P_o \text{ in watts})] = -13 \text{ dBm}$$

TEST SETUP

The EUT RF output connector was connected to a spectrum analyzer and to the Universal Radio Communication Tester R&S CMW500 (selecting maximum transmission power of the EUT and different modes of modulation) using a 50-ohm attenuator and a power splitter.

The reading of the spectrum analyzer is corrected with the attenuation loss of connection between output terminal of EUT and input of the spectrum analyzer.

For LTE mode the configuration of modulation which is the worst case for conducted power was used.

As indicated in FCC part 90, in the 1 MHz bands immediately outside and adjacent to the licensee's frequency block or band, a resolution bandwidth of at least one percent of the emission bandwidth of the fundamental emission of the transmitter may be employed.

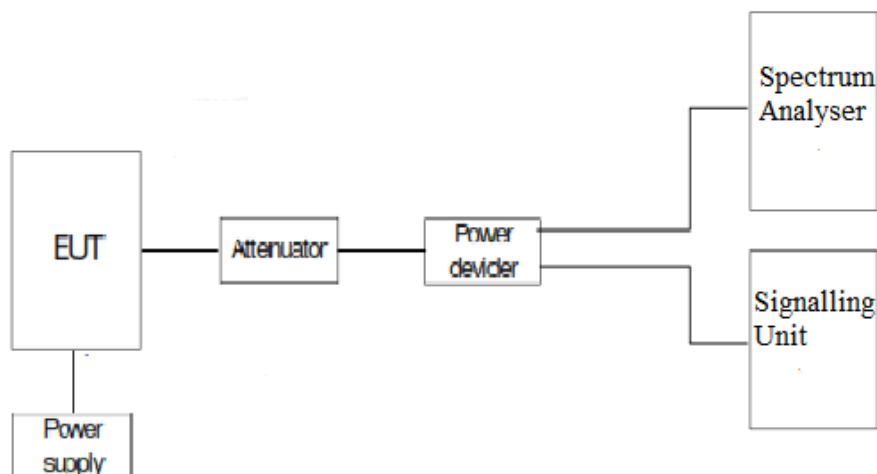

TESTED SAMPLES:	S/01
TESTED CONDITIONS MODES:	TC#01
TEST RESULTS:	PASS

RESULTS

LTE QPSK MODULATION	RB=1. Offset=0. BW=1.4 MHz	RB=1. Offset =0. BW = 3 MHz	RB=1. Offset =0. BW = 5 MHz	RB=1. Offset =0. BW = 10 MHz	RB=1. Offset =0. BW = 15 MHz
Maximum measured level at lowest Block Edge at antenna port (dBm)	-18.34	-21.4	-22.9	-36.83	-34.9

LTE QPSK MODULATION:	RB= All. Offset=0. BW=1.4 MHz	RB= All. Offset =0. BW = 3 MHz	RB= All. Offset =0. BW = 5 MHz	RB= All. Offset =0. BW = 10 MHz	RB= All. Offset =0. BW = 15 MHz
Maximum measured level at lowest Block Edge at antenna port (dBm)	-21.83	-24.89	-26.05	-32.5	-36.78

LTE QPSK MODULATION:	RB= 1. Offset=Max. BW=1.4 MHz	RB= 1. Offset=Max. BW = 3 MHz	RB= 1. Offset=Max. BW = 5 MHz	RB= 1. Offset=Max. BW = 10 MHz	RB= 1. Offset=Max. BW = 15 MHz
Maximum measured level at highest Block Edge at antenna port (dBm)	-29.6	-27.94	-26.28	-34.56	

LTE QPSK MODULATION:	RB= All. Offset=0. BW=1.4 MHz	RB= All. Offset =0. BW = 3 MHz	RB= All. Offset =0. BW = 5 MHz	RB= All. Offset =0. BW = 10 MHz	RB= All. Offset =0. BW = 15 MHz
Maximum measured level at highest Block Edge at antenna port (dBm)	-24.78	-25.22	-29.31	-32.56	

TEST RESULTS (Cont):

LTE QPSK MODULATION. RB = 1. Offset = 0. BW = 1.4 MHz

Lowest Channel

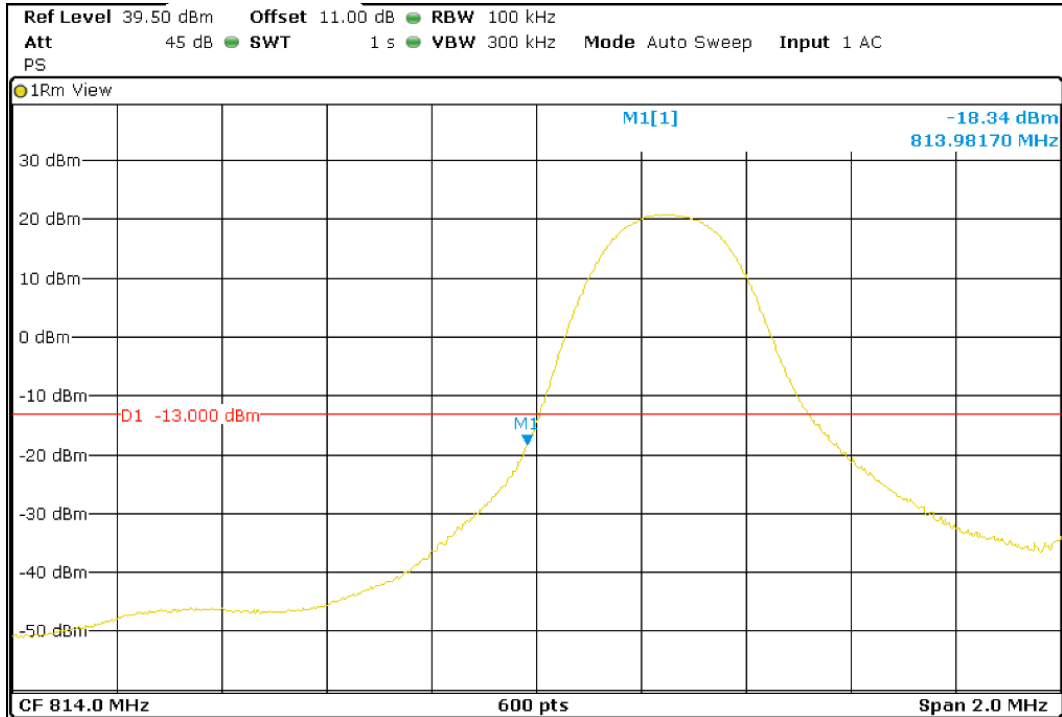

Highest Channel

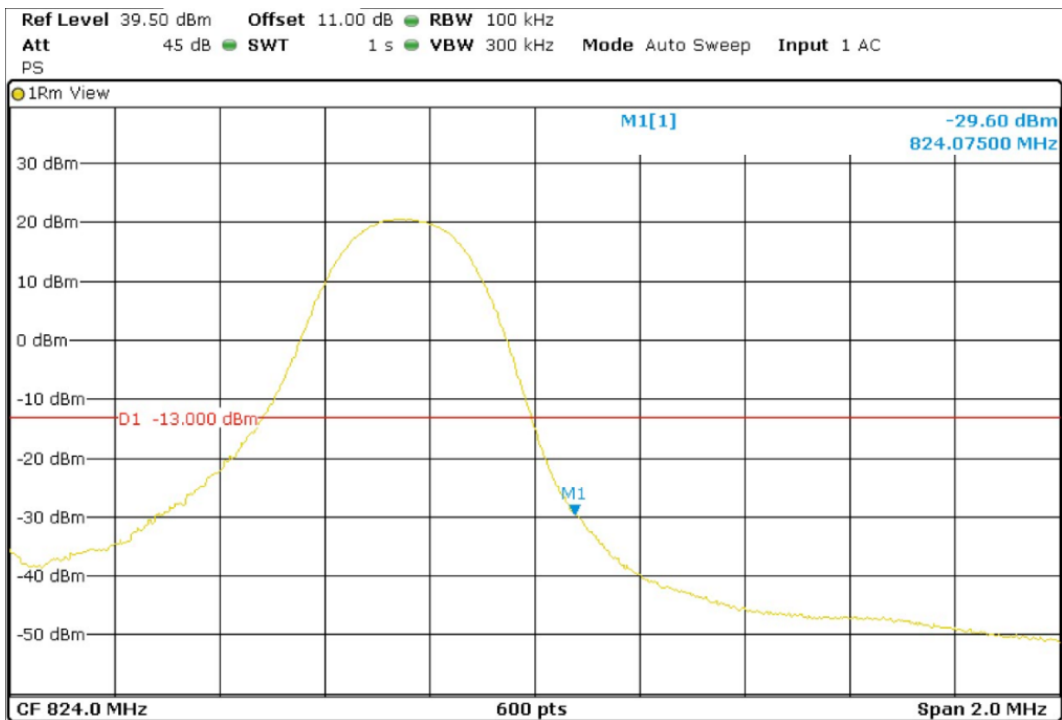

TEST RESULTS (Cont):

LTE QPSK MODULATION. RB = 6. Offset = 0. BW = 1.4 MHz

Lowest Channel

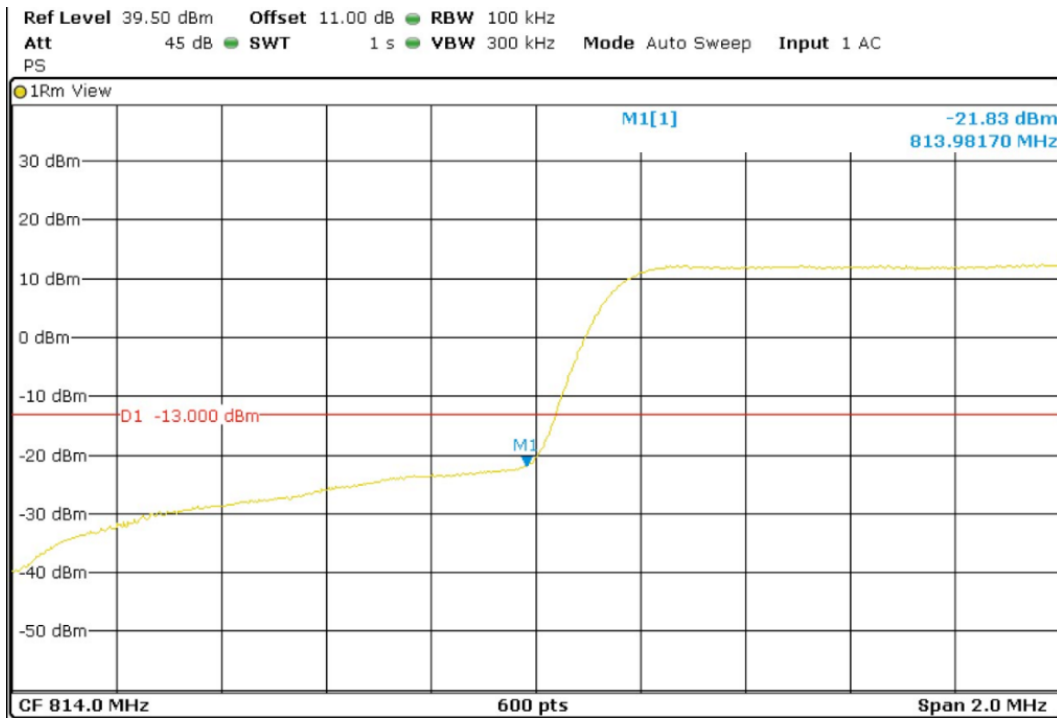

Highest Channel

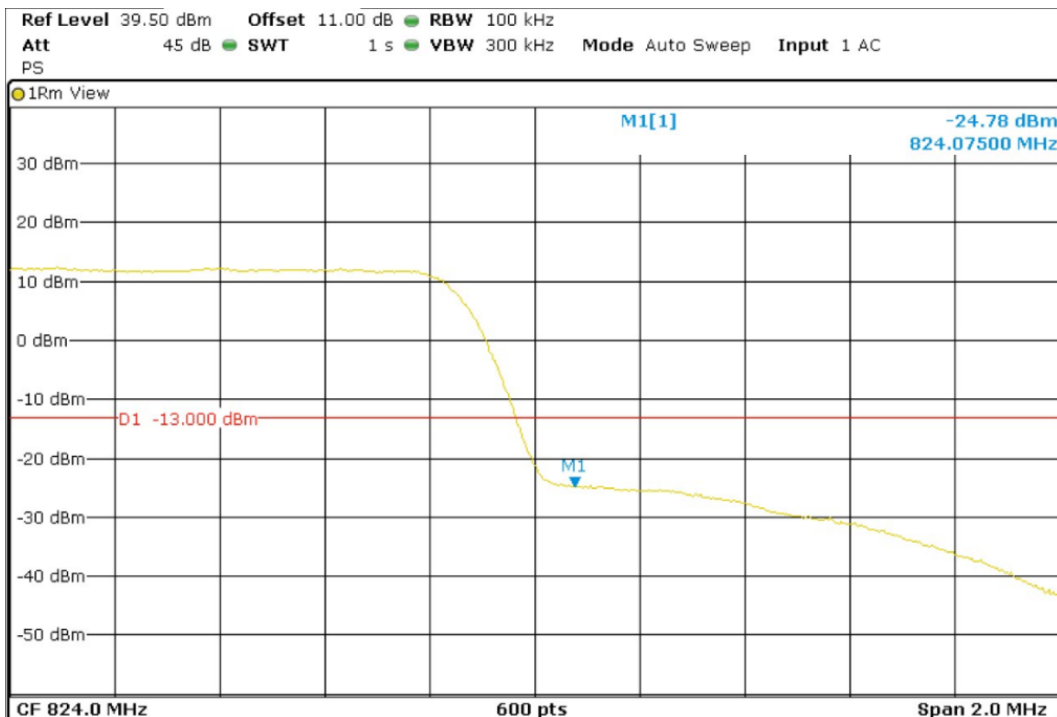

TEST RESULTS (Cont):

LTE QPSK MODULATION. RB = 1. Offset = 0. BW = 3 MHz

Lowest Channel

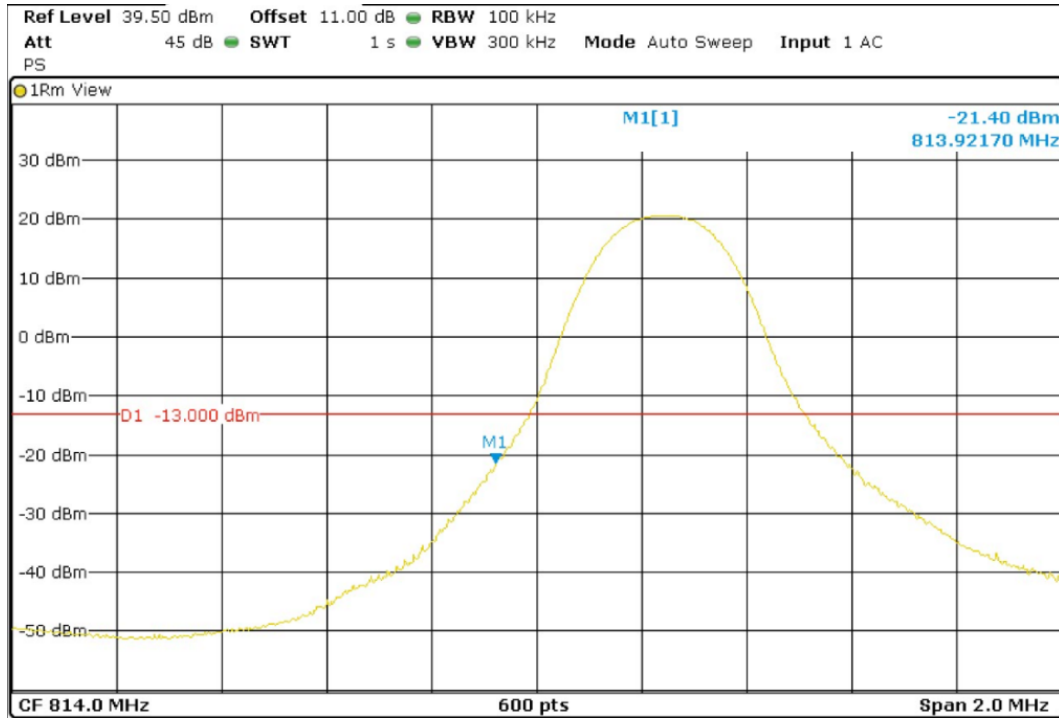

Highest Channel

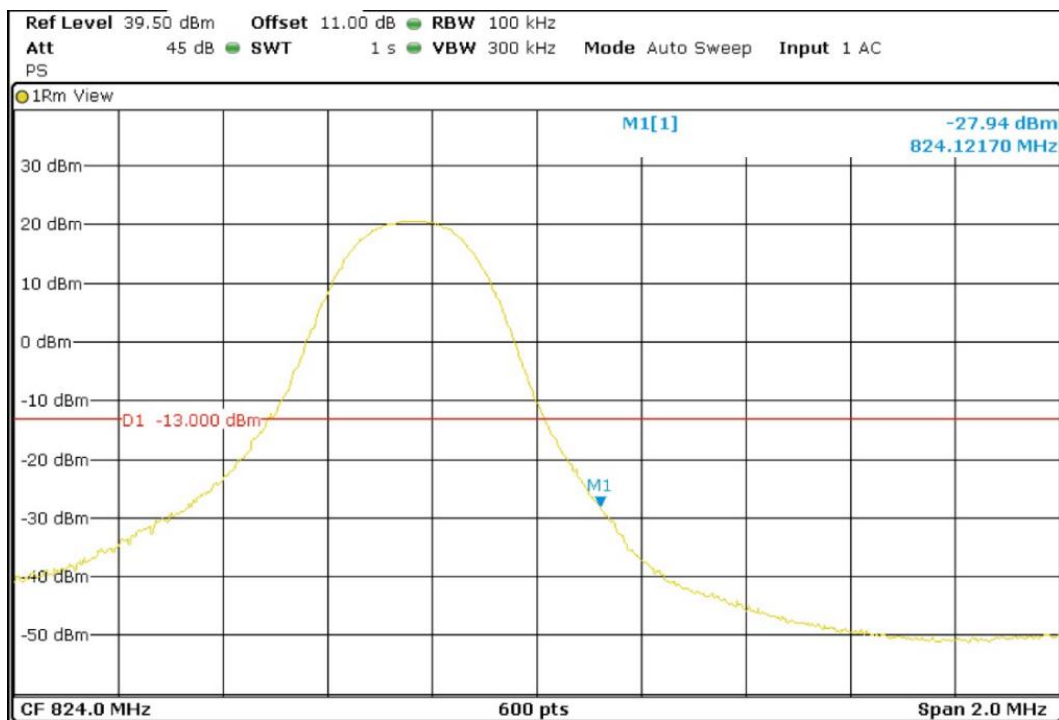

TEST RESULTS (Cont):

LTE QPSK MODULATION. RB = 15. Offset = 0. BW = 3 MHz

Lowest Channel

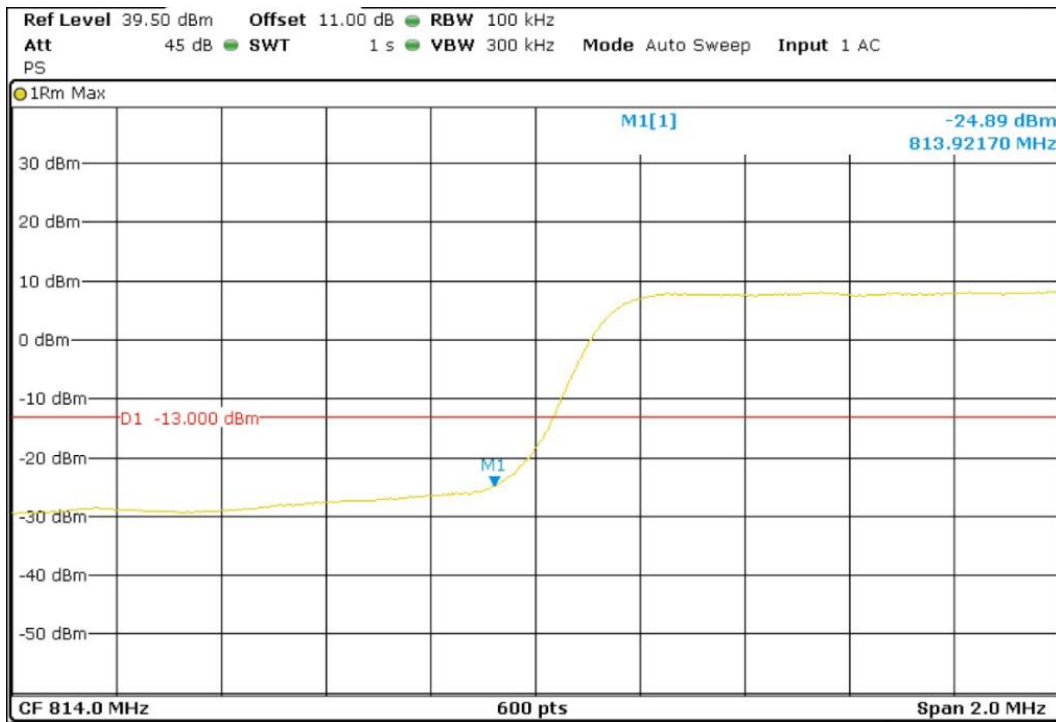

Highest Channel

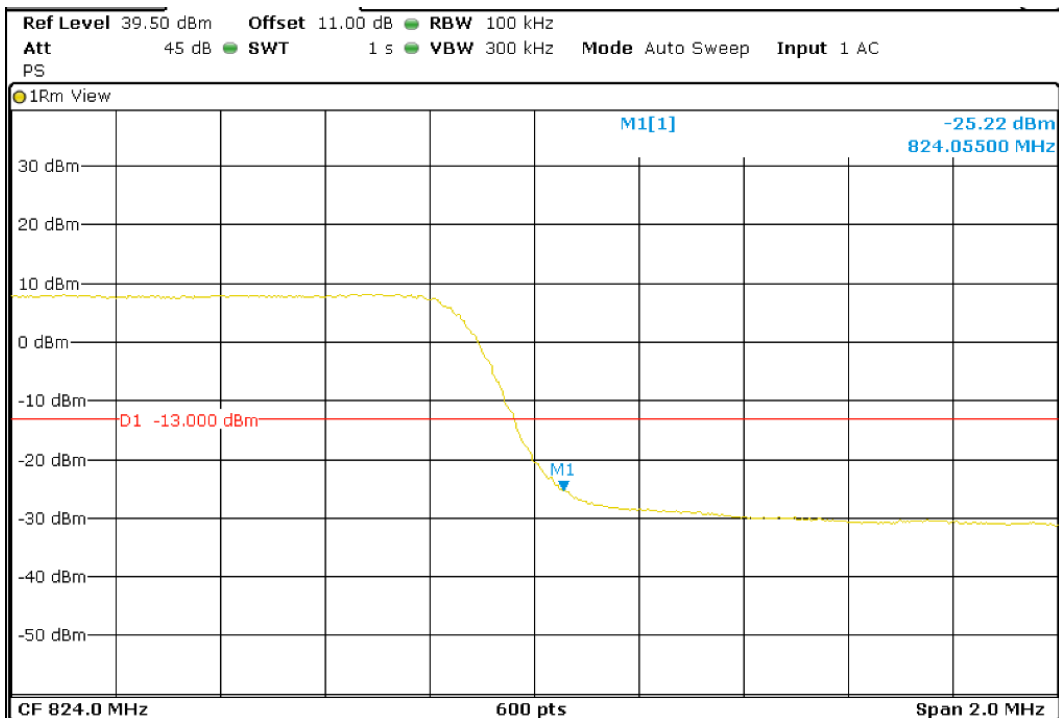

TEST RESULTS (Cont):

LTE QPSK MODULATION. RB = 1. Offset = 0. BW = 5 MHz

Lowest Channel

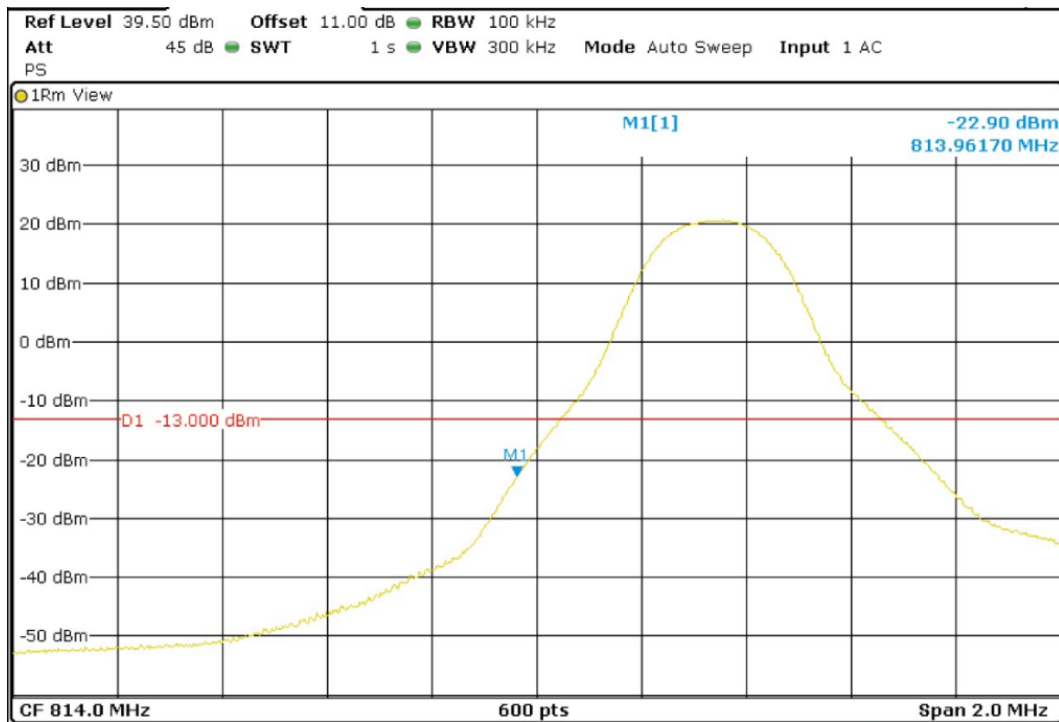

Highest Channel

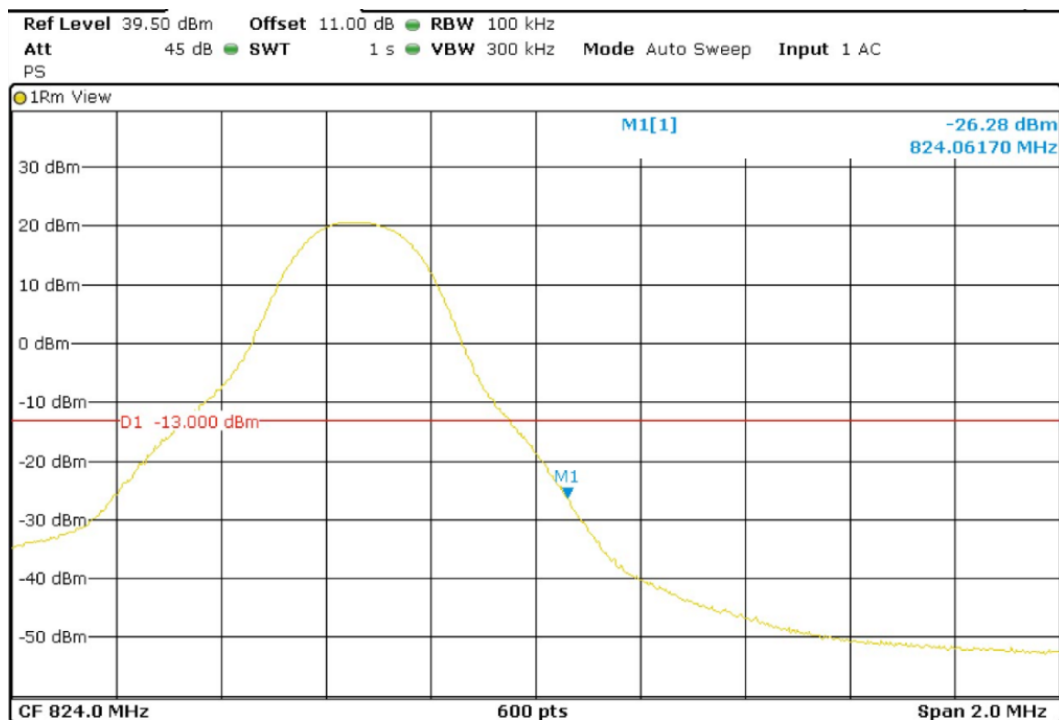

TEST RESULTS (Cont):

LTE QPSK MODULATION. RB = 25. Offset = 0. BW = 5 MHz

Lowest Channel

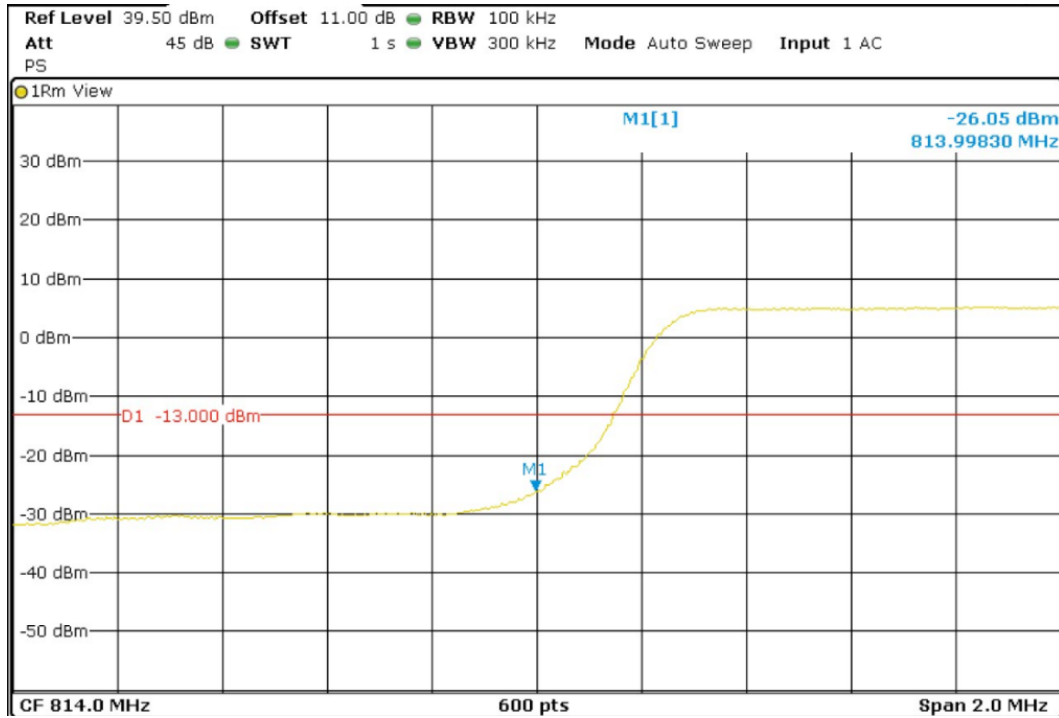

Highest Channel

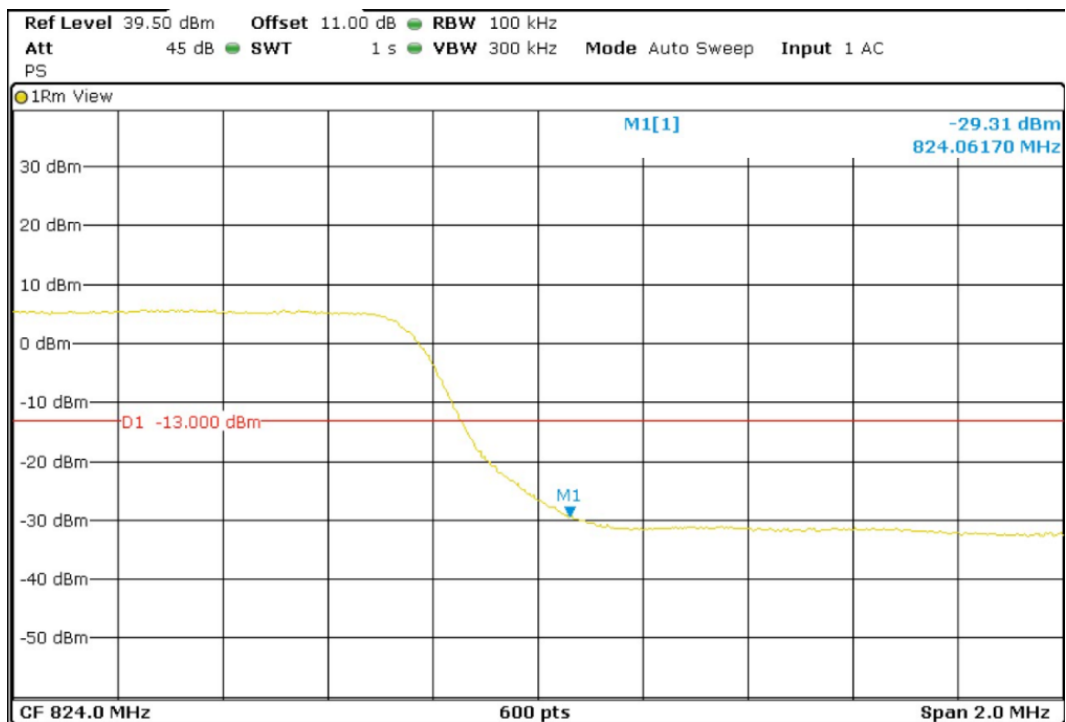

TEST RESULTS (Cont):

LTE QPSK MODULATION. RB = 1. Offset = 0. BW = 10 MHz

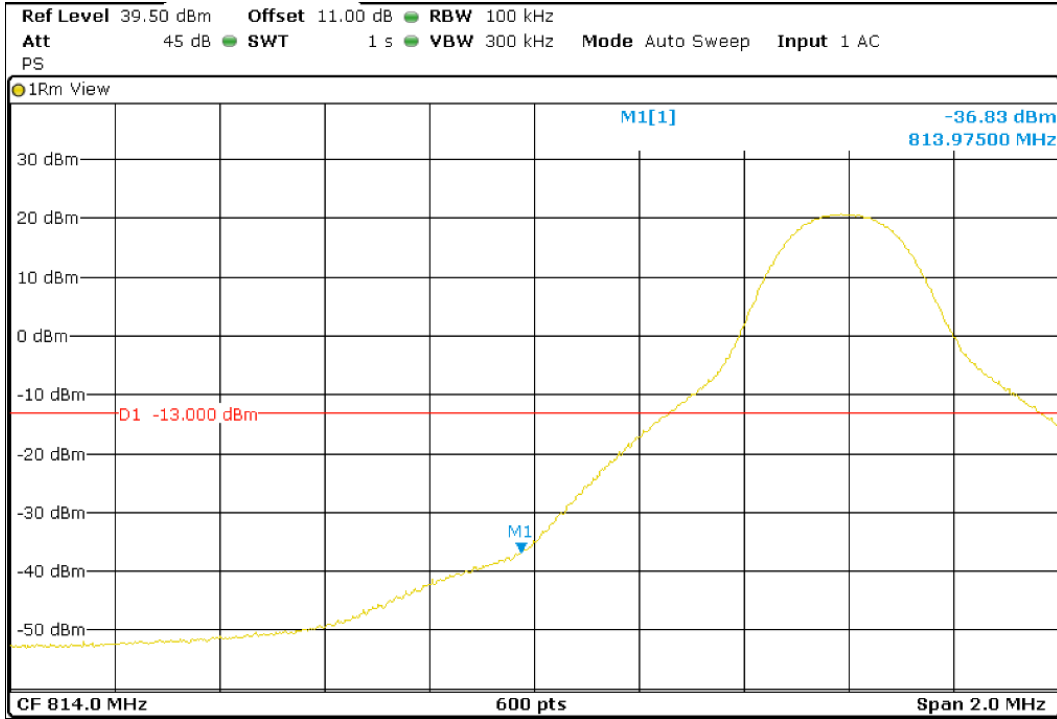

LTE QPSK MODULATION. RB = 1. Offset = Max. BW = 10 MHz

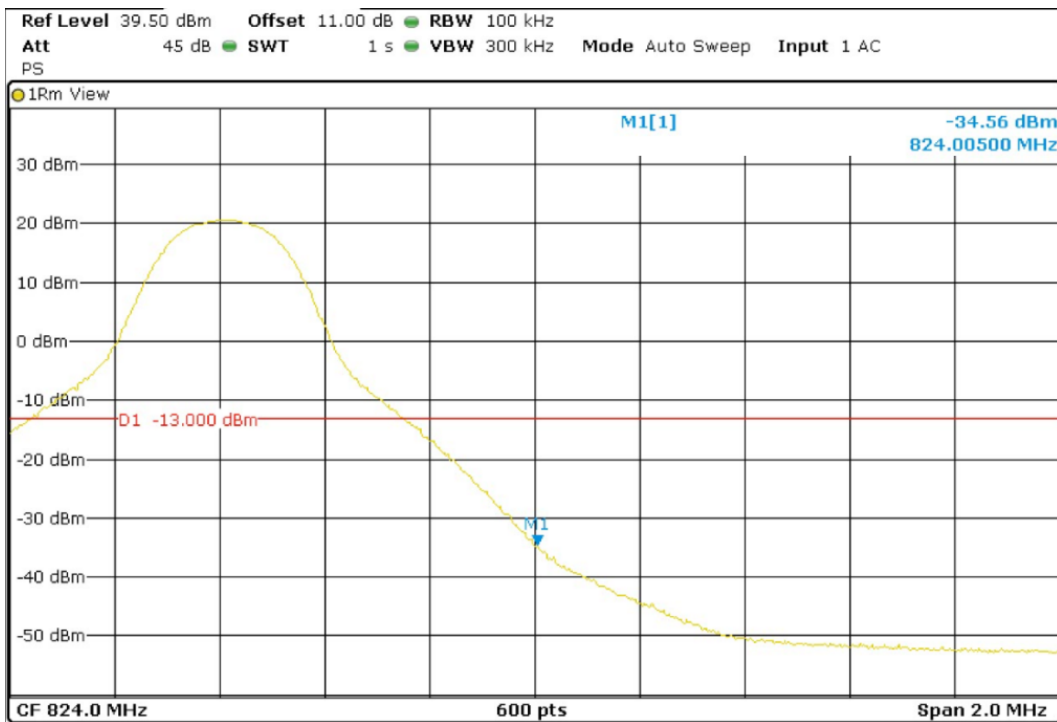

TEST RESULTS (Cont):

LTE QPSK MODULATION. RB = 50. Offset = 0. BW = 10 MHz

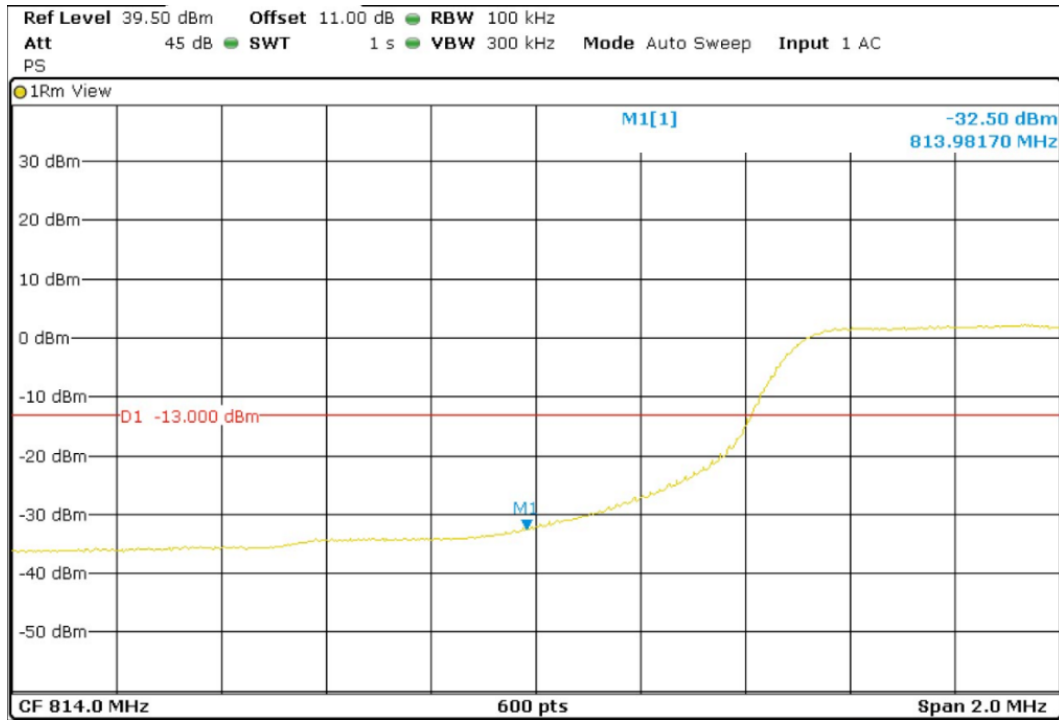

LTE QPSK MODULATION. RB = 50. Offset = 0. BW = 10 MHz

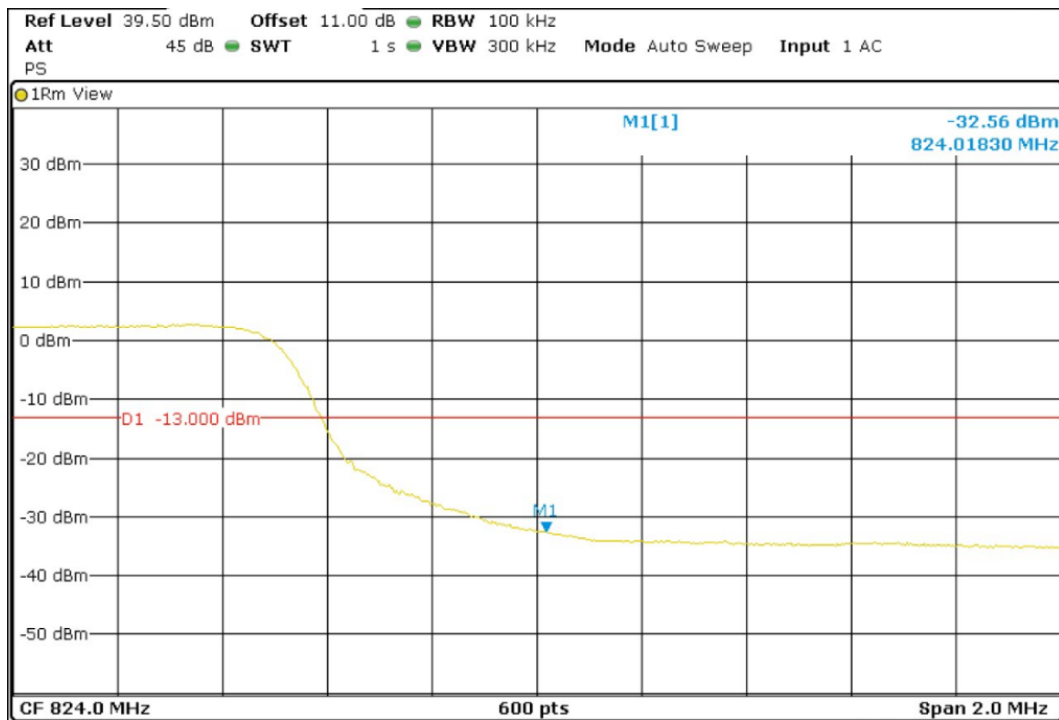

TEST RESULTS (Cont):

LTE QPSK MODULATION. RB = 1. Offset = 0. BW = 15 MHz

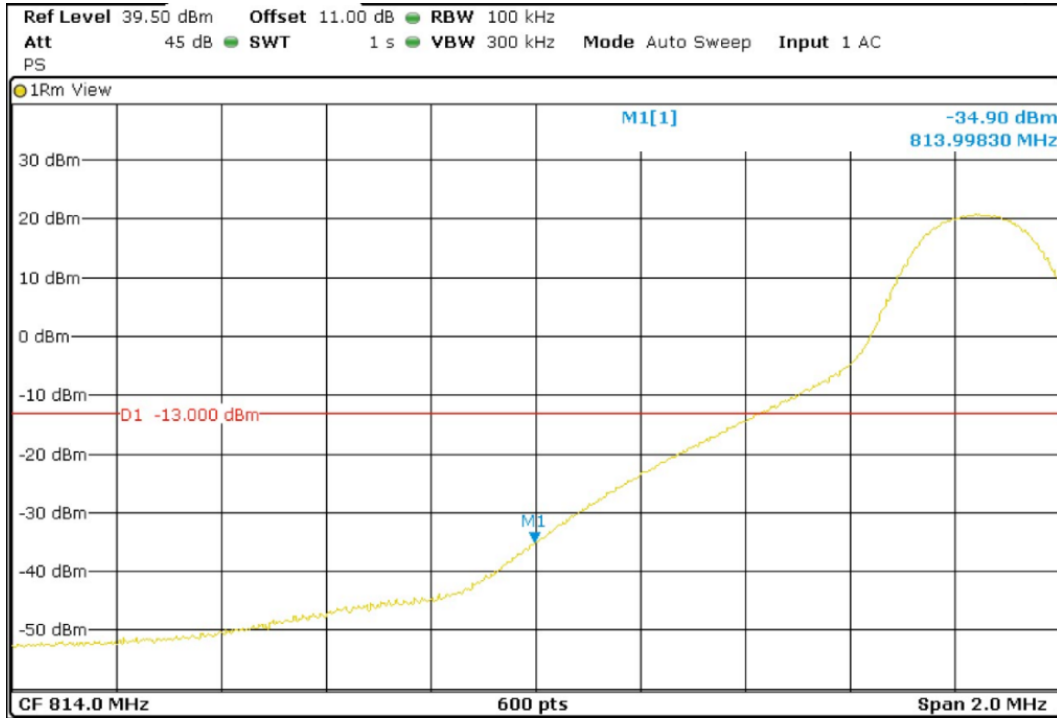

LTE QPSK MODULATION. RB = 75. Offset = 0. BW = 15 MHz

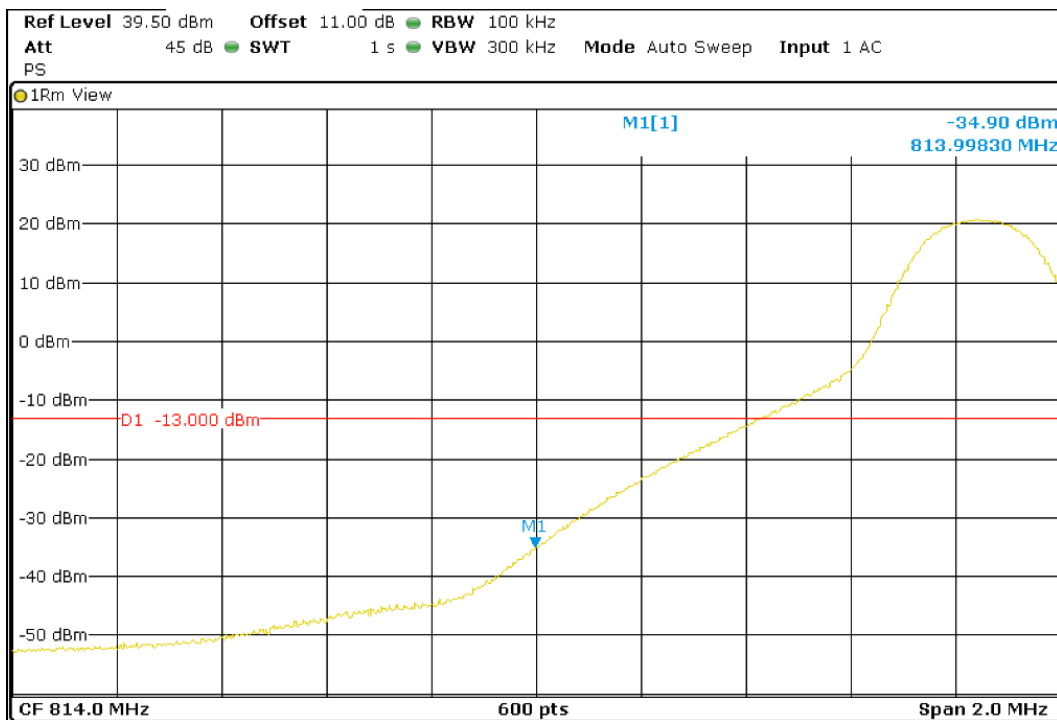

TEST A.7: RADIATED EMISSIONS

LIMITS:	Product standard:	FCC Part 90.
	Test standard:	FCC §2.1051

LIMITS

According to specification, the power of emissions shall be attenuated below the transmitter power (P) by a factor of at least $43 + 10 \log(P)$ dB. P in watts.

At P_o transmitting power of 2 watts (33 dBm), the specified minimum attenuation becomes $43 + 10 \log(P_o)$, and the level in dBm relative to P_o becomes:

$$P_o \text{ (dBm)} - [43 + 10 \log(P_o \text{ in watts})] = -13 \text{ dBm}$$

TEST SETUP

The measurement was performed with the EUT inside an anechoic chamber. The spectrum was scanned from 30 MHz to at least the 10th harmonic of the highest frequency generated within the equipment.

The EUT was placed on a non-conductive stand at a 3-meter distance from the measuring antenna for measurements below 1 GHz and at 1-meter distance for measurements above 1 GHz.

Detected emissions were maximized at each frequency by rotating the EUT and adjusting the measuring antenna height and polarization. The maximum reading was recorded.

Radiated measurements < 1GHz

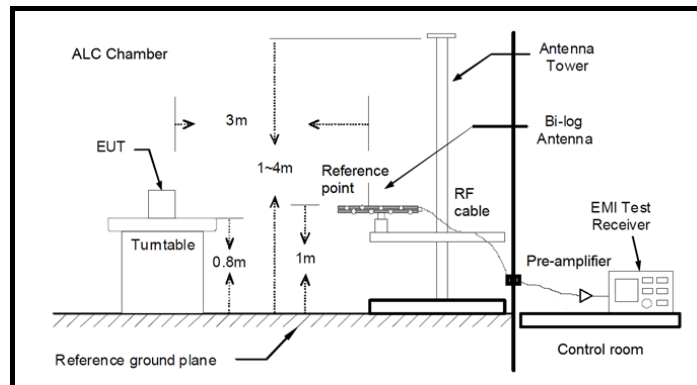

Radiated measurements > 1GHz

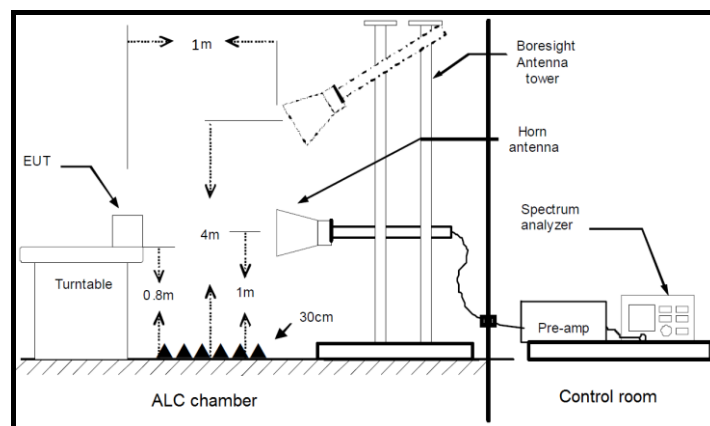

TESTED SAMPLES:	S/01
TESTED CONDITIONS MODES:	TC#01
TEST RESULTS:	PASS

RESULTS

A preliminary scan determined the QPSK 3 MHz bandwidth as the worst case. The configuration of Resource Blocks which is the worst case for conducted power was used.

The following plots show the results for this configuration.

LTE QPSK MODULATION. RB = 1. Offset = 0. BW = 3 MHz

TEST RESULTS (Cont):	Low Channel
-----------------------------	-------------

FREQUENCY RANGE: 30-1000 MHz

Frequency (MHz)	PK+_CLRWR (dBm)	PK+_MAXH (dBm)	Comment
30.291000	-62.38	-59.40	
814.245000	14.15	18.99	Fundamental
861.290000	-45.90	-35.83	

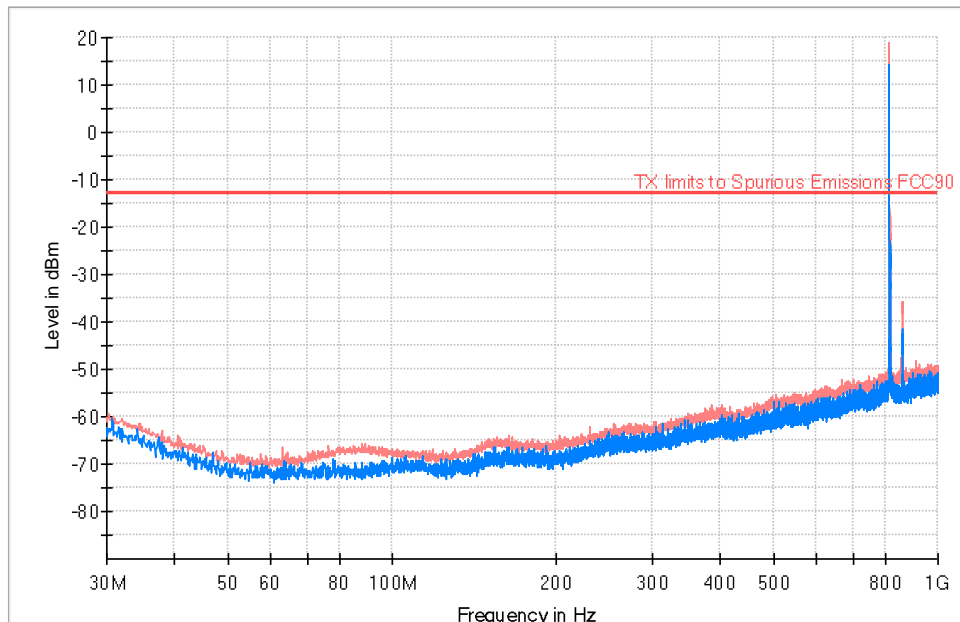

— PK+_MAXH — PK+_CLRWR — TX limits to Spurious Emissions FCC90

TEST RESULTS (Cont):

Low Channel

FREQUENCY RANGE: 1-10 GHz

Frequency (MHz)	PK+_CLRWR (dBm)	PK+_MAXH (dBm)
2154.000000	-46.45	-42.22
3972.500000	-39.78	-34.25
8059.500000	-30.30	-24.92

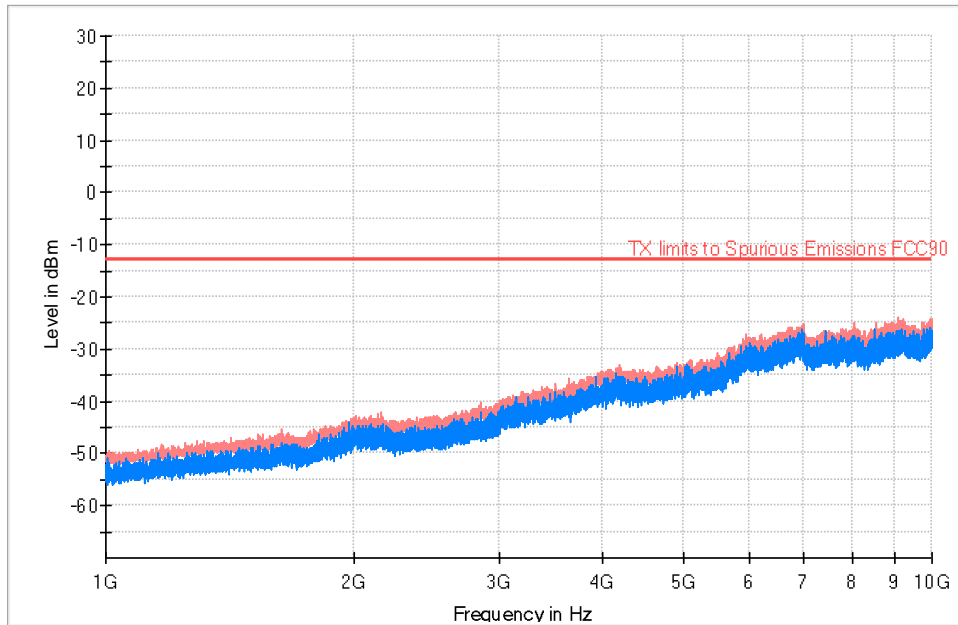

— PK+_MAXH — PK+_CLRWR — TX limits to Spurious Emissions FCC90

TEST RESULTS(Cont.):

Middle Channel

FREQUENCY RANGE: 30-1000 MHz

Frequency (MHz)	PK+_CLRWR (dBm)	PK+_MAXH (dBm)	Comment
40.282000	-68.94	-63.63	
817.834000	6.21	18.63	Fundamental
864.297000	-39.85	-36.65	

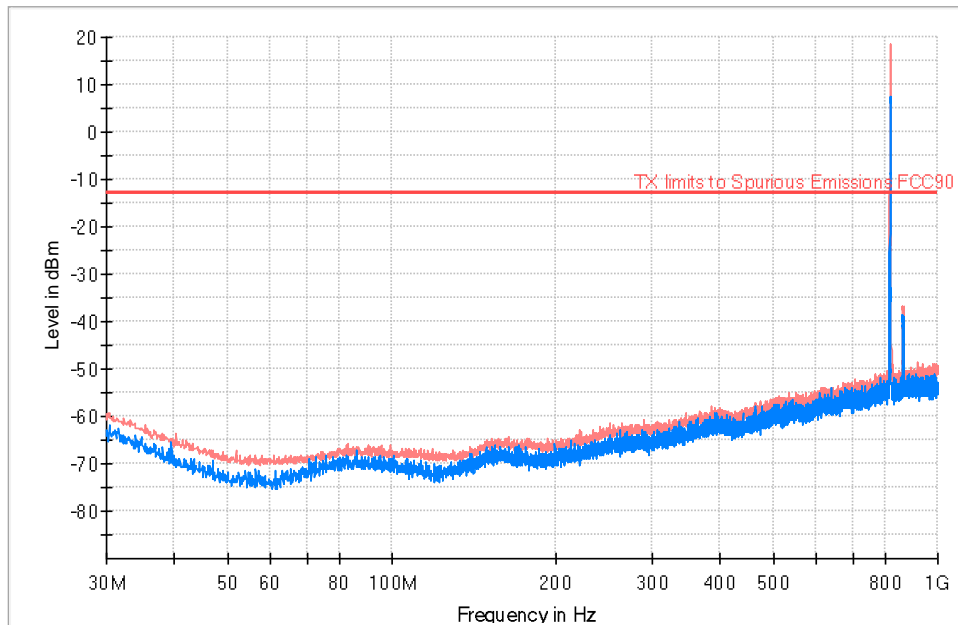

— PK+_MAXH — PK+_CLRWR — TX limits to Spurious Emissions FCC90

TEST RESULTS (Cont):

Middle Channel

FREQUENCY RANGE: 1-10 GHz

Frequency (MHz)	PK+_CLRWR (dBm)	PK+_MAXH (dBm)
2496.600000	-46.68	-42.44
6975.500000	-27.86	-25.07
9091.500000	-27.71	-23.99

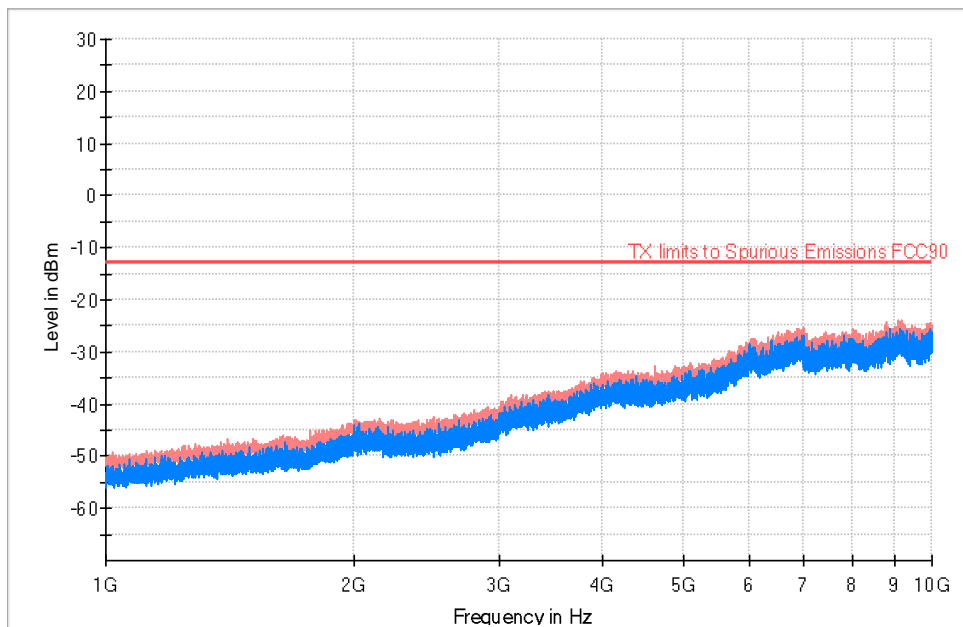

— PK+_MAXH — PK+_CLRWR — TX limits to Spurious Emissions FCC90

TEST RESULTS(Cont.):

High Channel

FREQUENCY RANGE: 30-1000 MHz

Frequency (MHz)	PK+_CLRWR (dBm)	PK+_MAXH (dBm)	Comment
30.097000	-60.51	-60.13	
821.326000	13.24	19.89	Fundamental
867.207000	-40.43	-36.31	

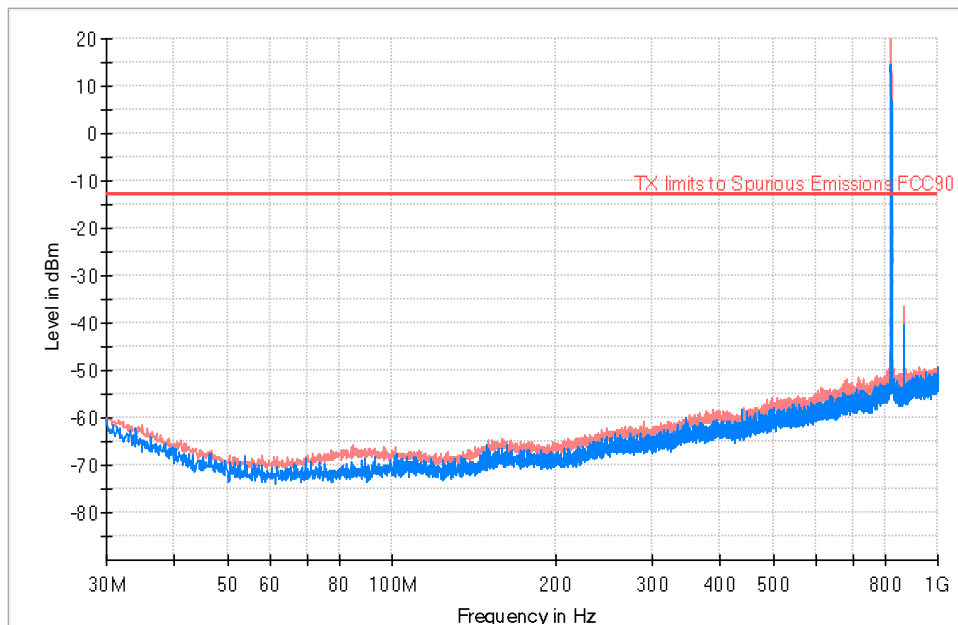

— PK+_MAXH — PK+_CLRWR — TX limits to Spurious Emissions FCC90

TEST RESULTS (Cont):

High Channel

FREQUENCY RANGE: 1-10 GHz

Frequency (MHz)	PK+_CLRWR (dBm)	PK+_MAXH (dBm)
2464.000000	-47.94	-40.66
8817.500000	-30.61	-23.66
9129.000000	-27.05	-24.00

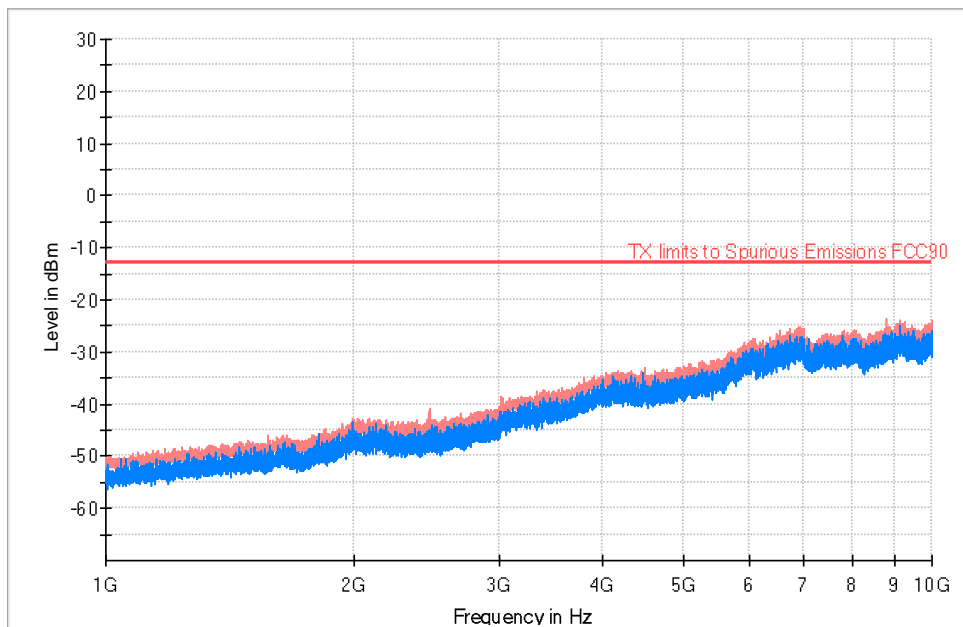

— PK+_MAXH — PK+_CLRWR — TX limits to Spurious Emissions FCC90