

TEST RESULTS (Cont):

Highest Channel 99% Occupied Bandwidth

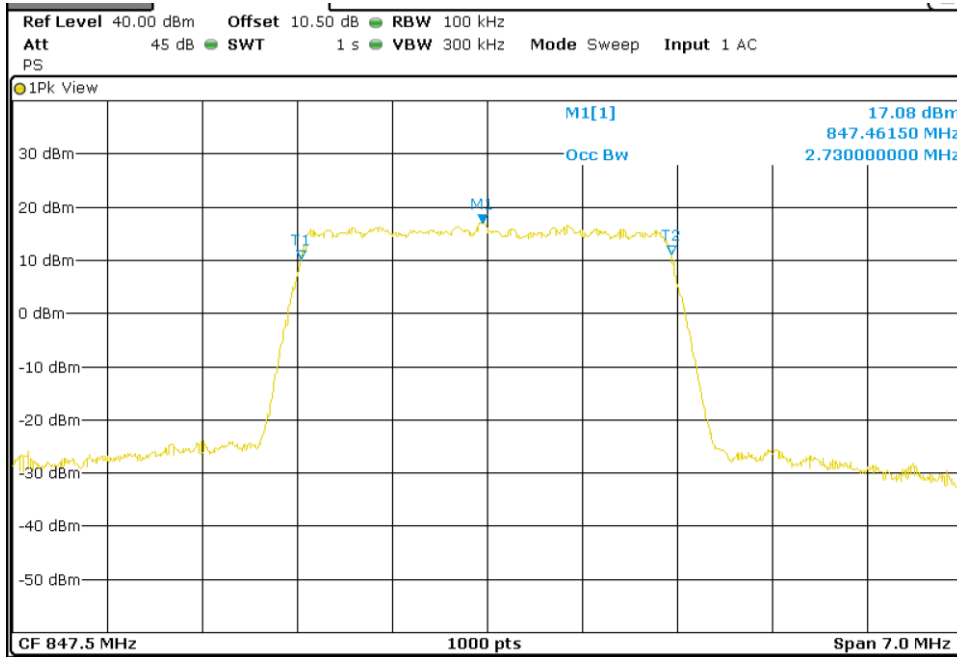

Highest Channel 26dBc Bandwidth kHz

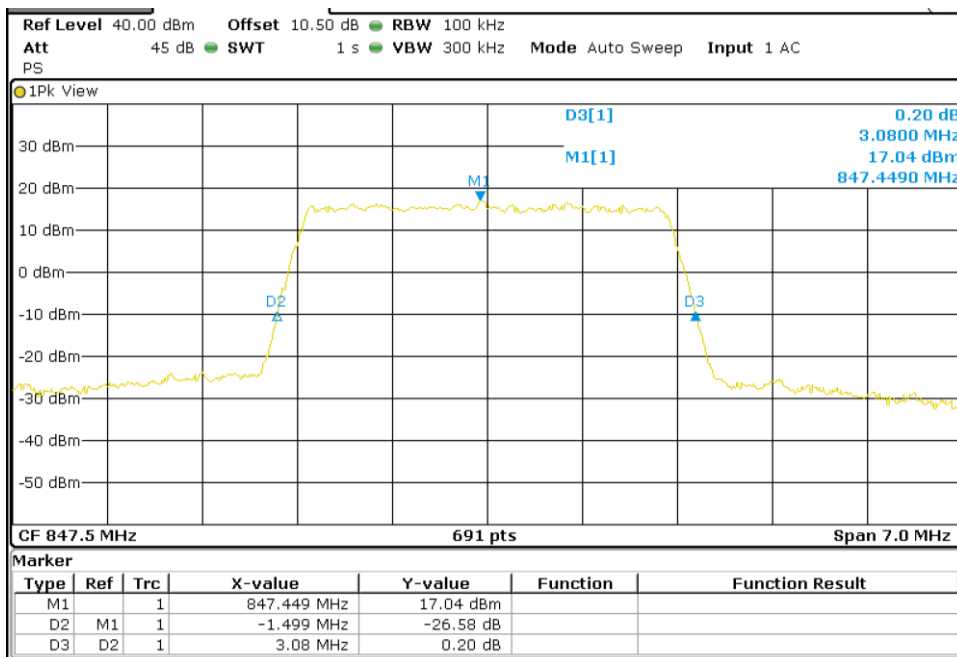

TEST RESULTS (Cont):

LTE QPSK MODULATION. BW = 5 MHz

Lowest Channel 99% Occupied Bandwidth

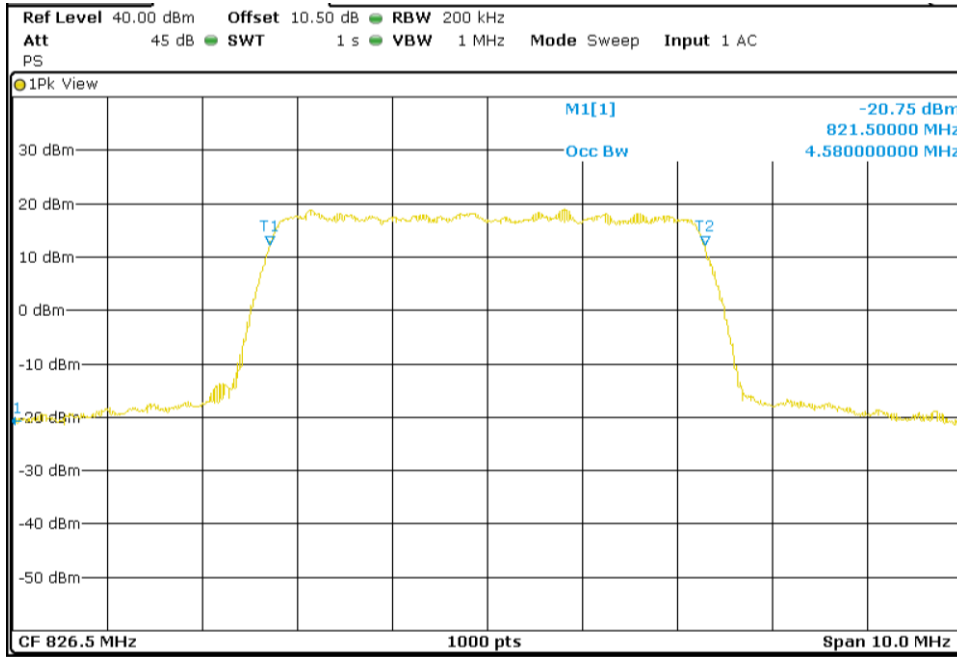

Lowest Channel 26dBc Bandwidth kHz

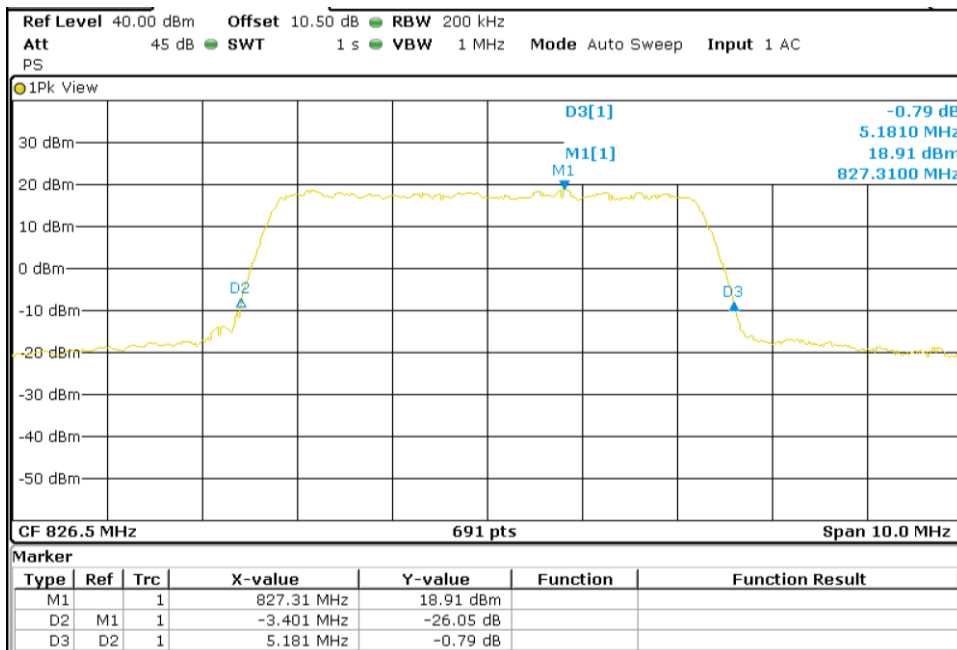

TEST RESULTS (Cont):

Middle Channel 99% Occupied Bandwidth

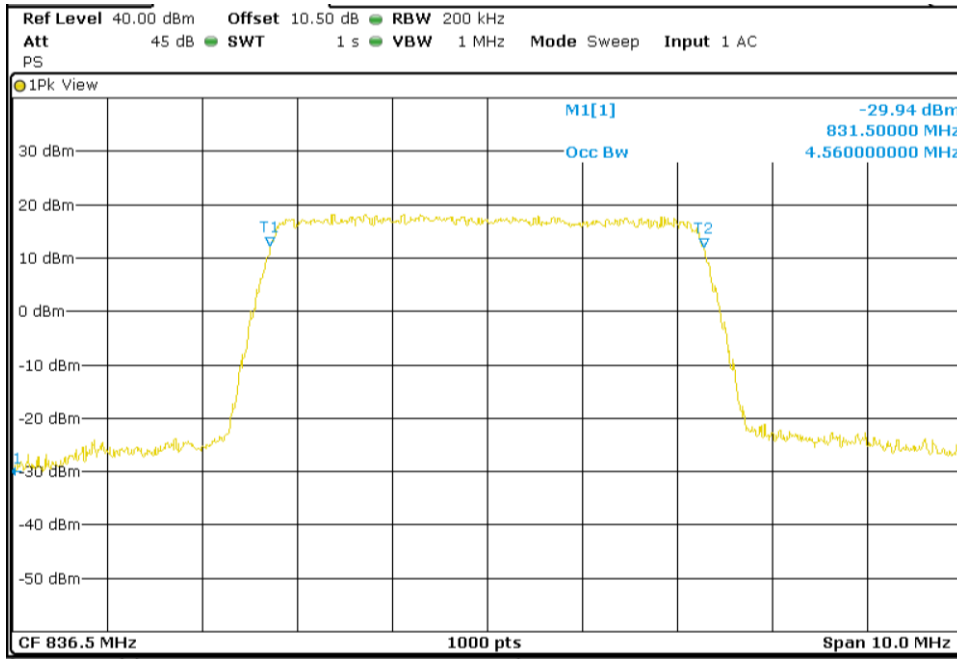

Middle Channel 26dBc Bandwidth kHz

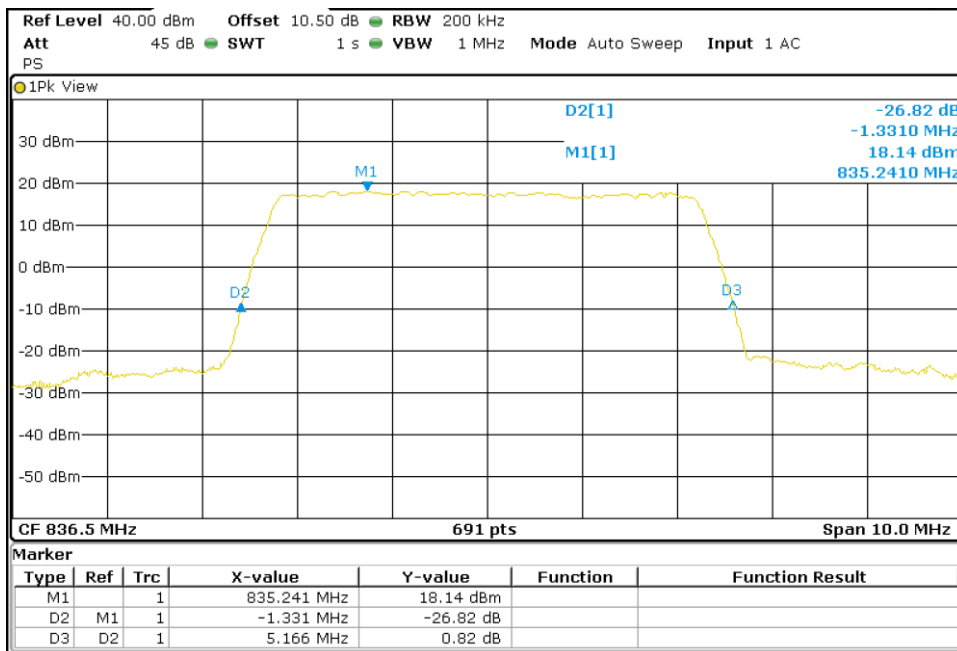

TEST RESULTS (Cont):

Highest Channel 99% Occupied Bandwidth

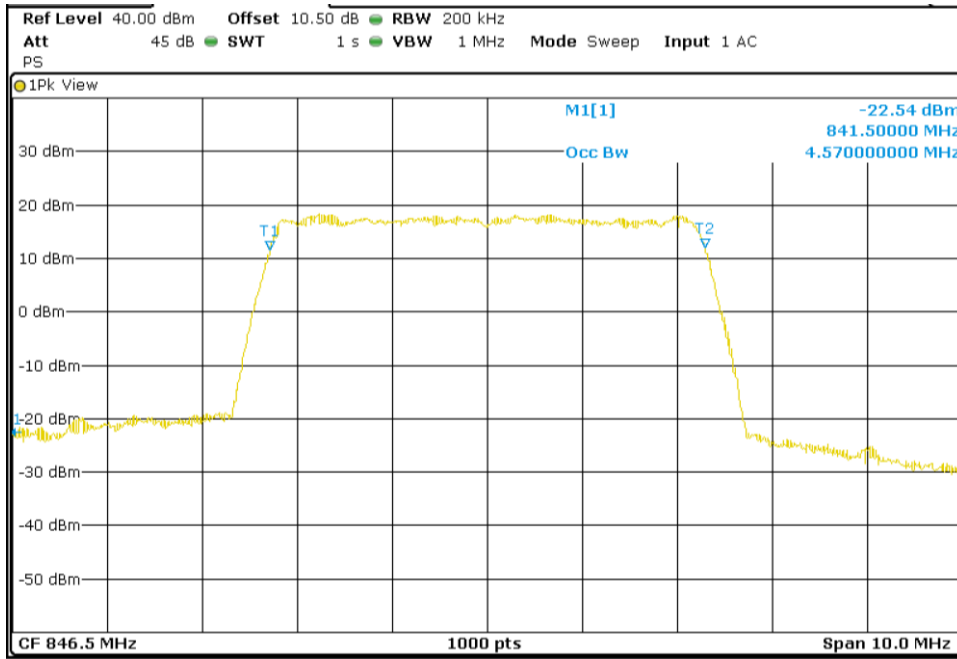

Highest Channel 26dBc Bandwidth kHz

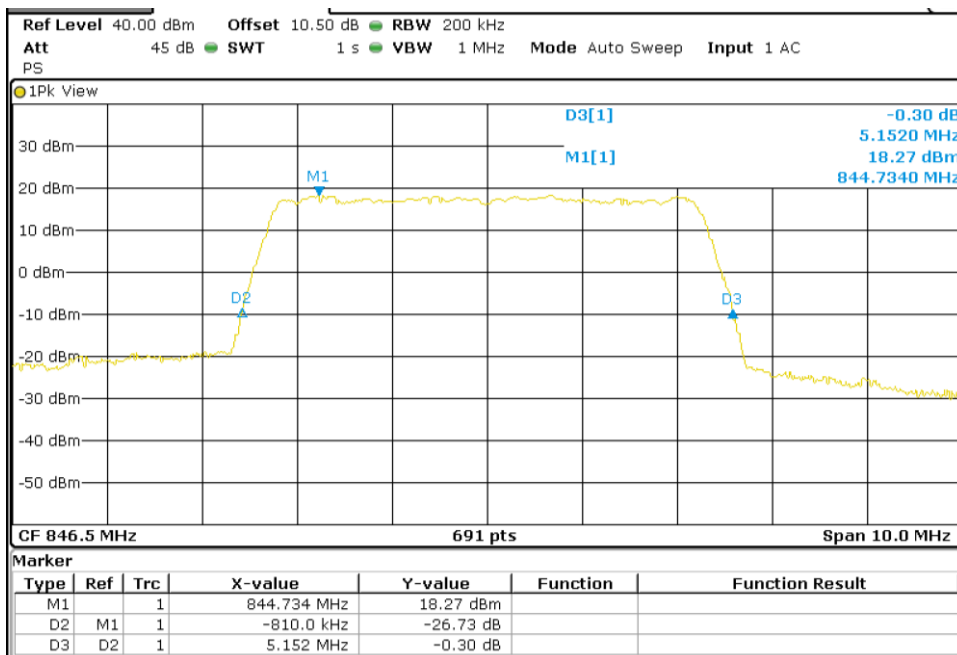

TEST RESULTS (Cont):

LTE 16QAM MODULATION. BW = 5 MHz

Lowest Channel 99% Occupied Bandwidth

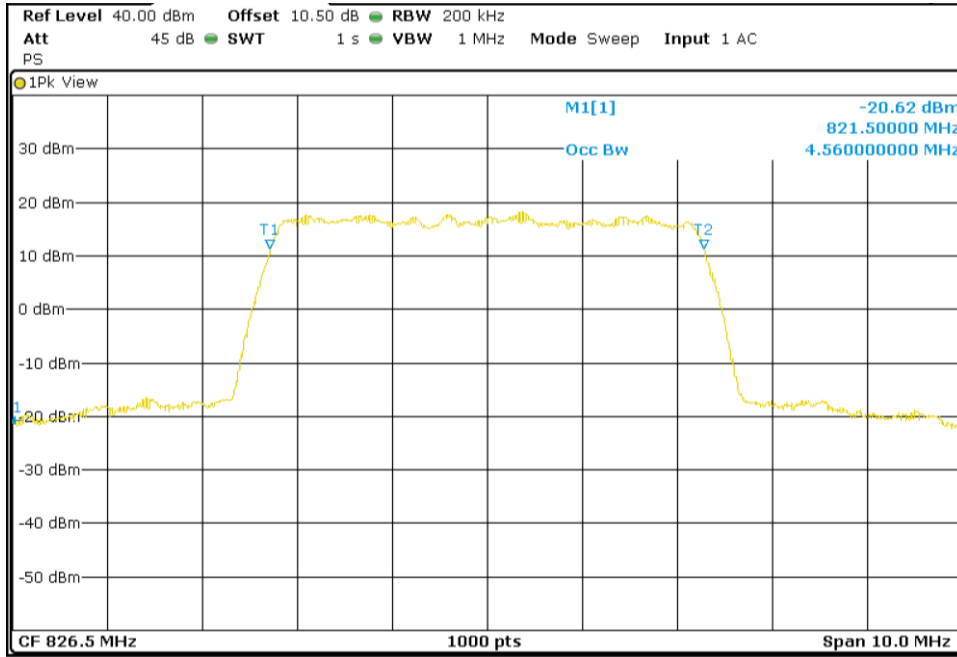

Lowest Channel 26dBc Bandwidth kHz

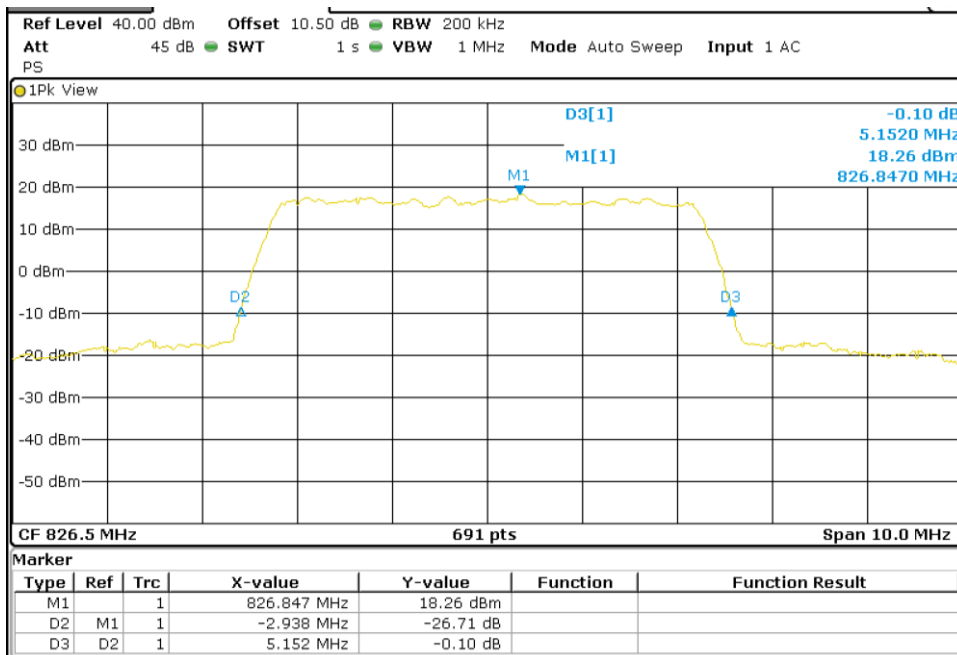

TEST RESULTS (Cont):

Middle Channel 99% Occupied Bandwidth

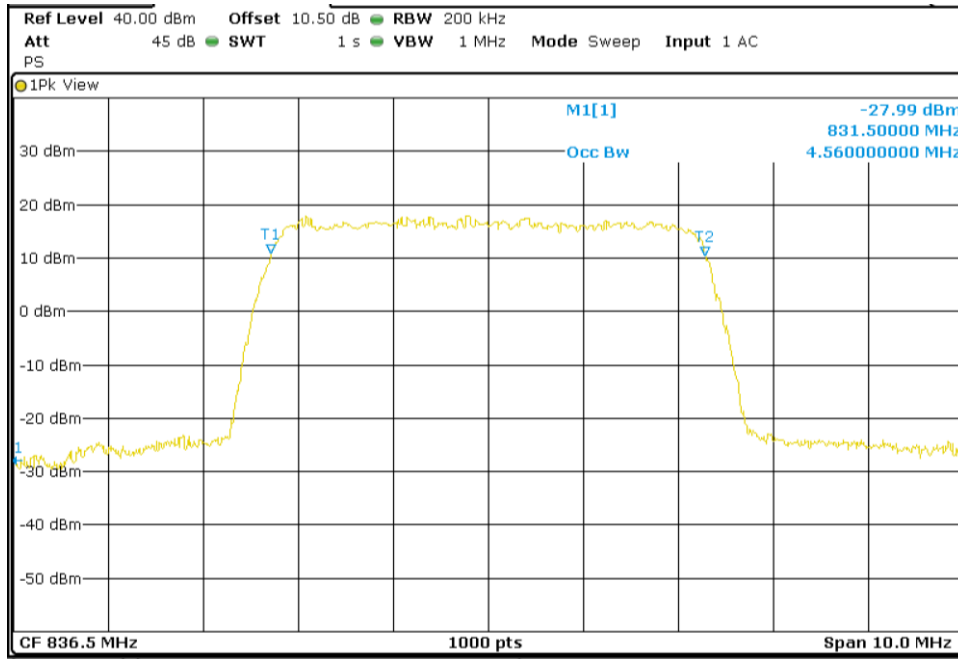

Middle Channel 26dBc Bandwidth kHz

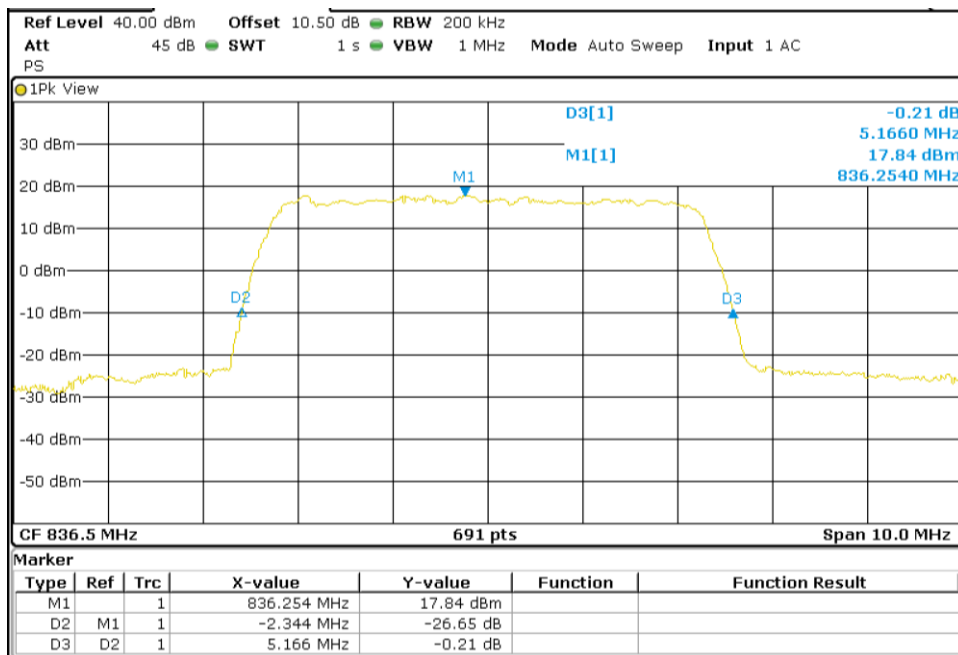

TEST RESULTS (Cont):

Highest Channel 99% Occupied Bandwidth

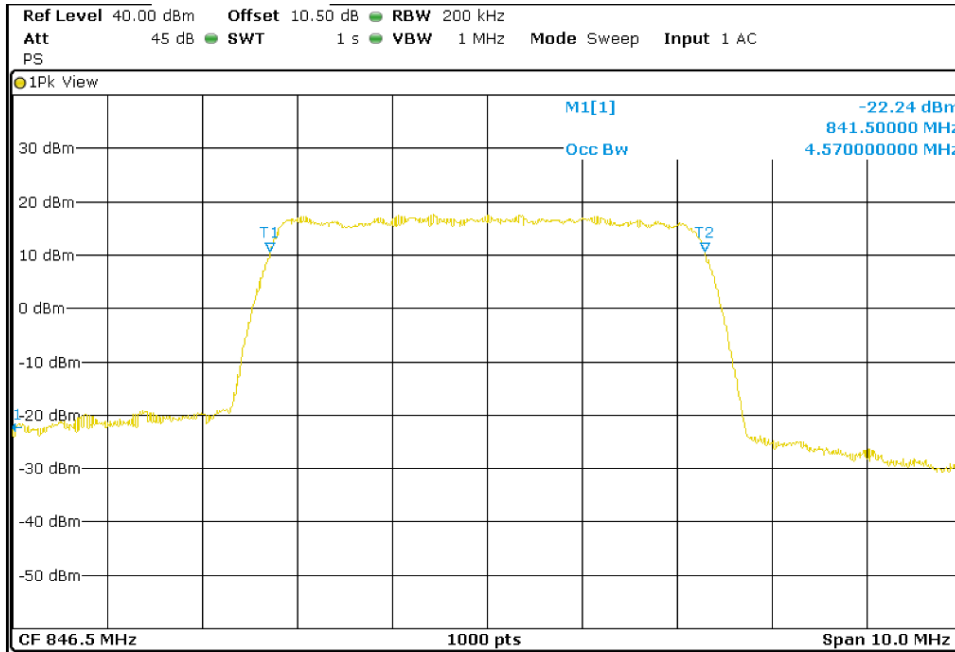

Highest Channel 26dBc Bandwidth kHz

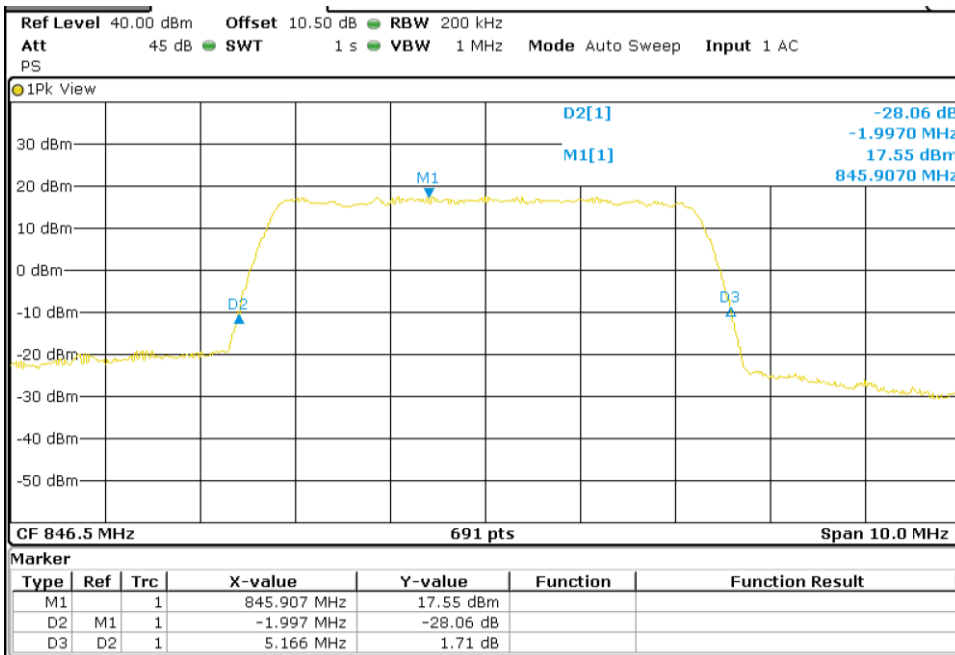

TEST RESULTS (Cont):

LTE QPSK MODULATION. BW = 10 MHz

Lowest Channel 99% Occupied Bandwidth

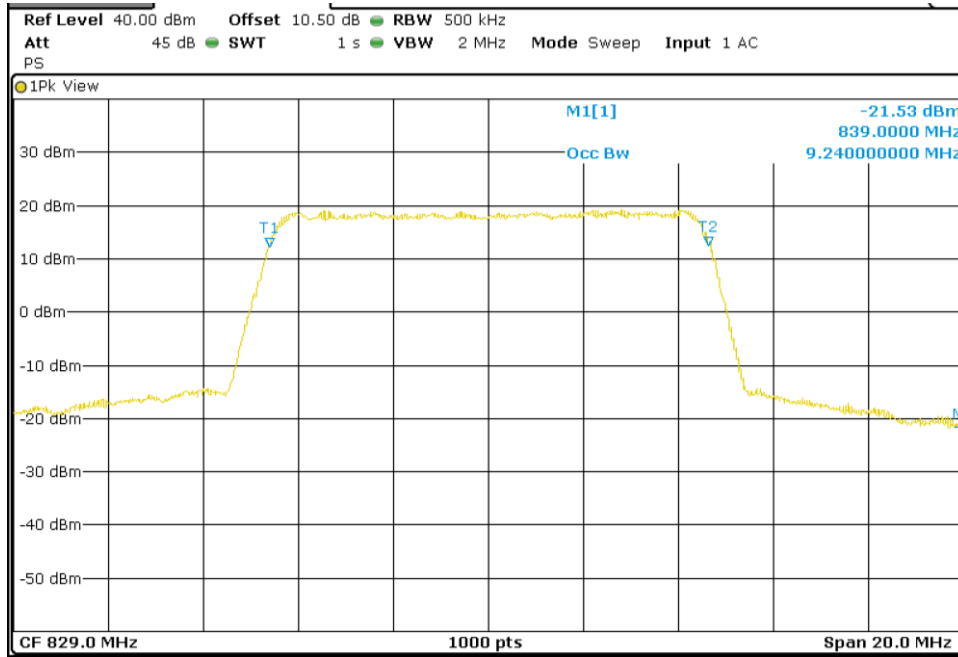

Lowest Channel 26dBc Bandwidth kHz

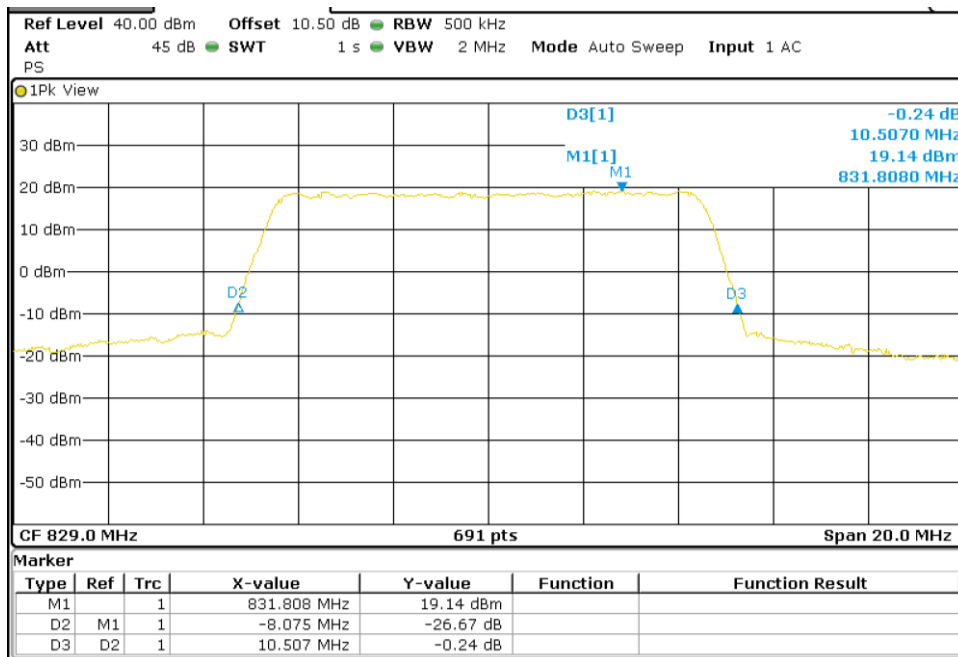

TEST RESULTS (Cont):

Middle Channel 99% Occupied Bandwidth

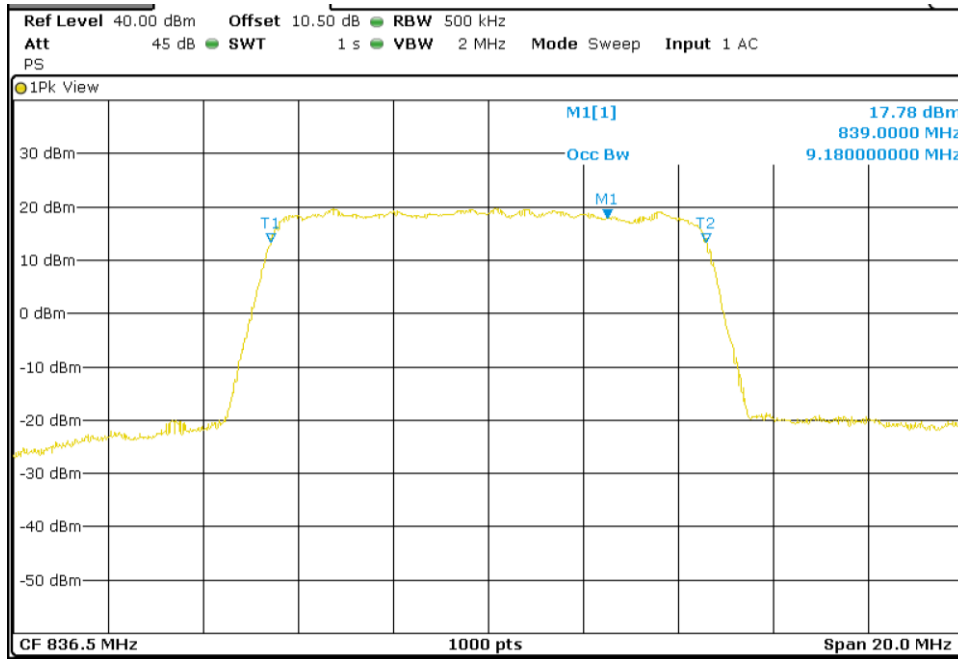

Middle Channel 26dBc Bandwidth kHz

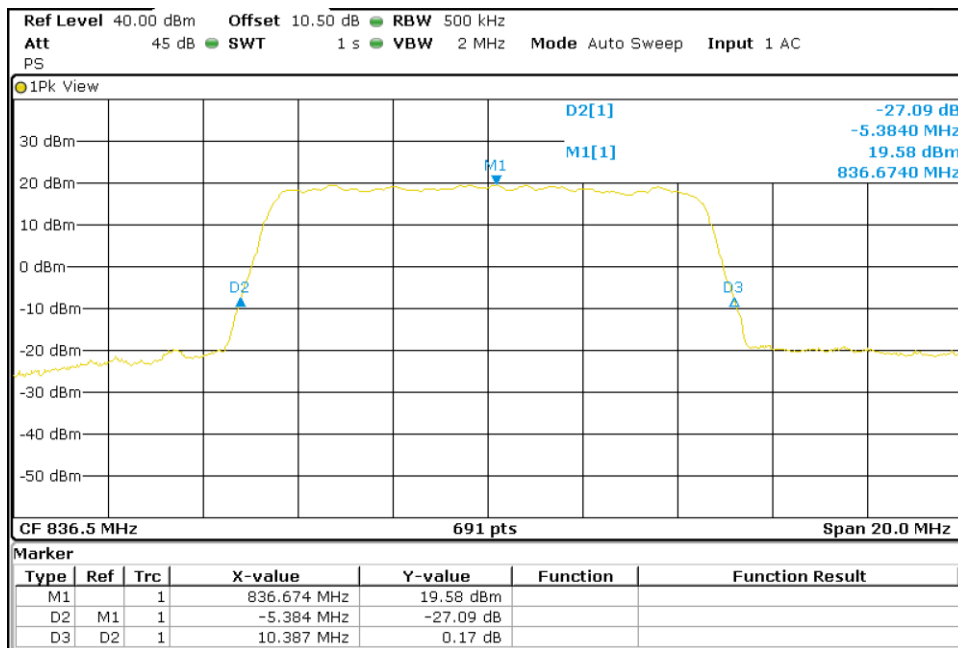

TEST RESULTS (Cont):

Highest Channel 99% Occupied Bandwidth

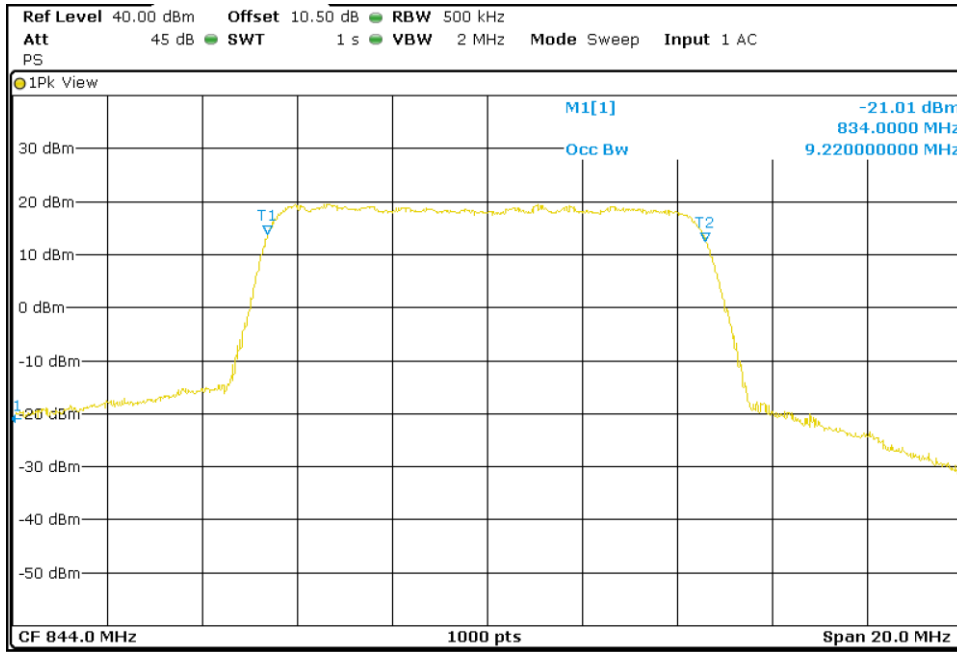

Highest Channel 26dBc Bandwidth kHz

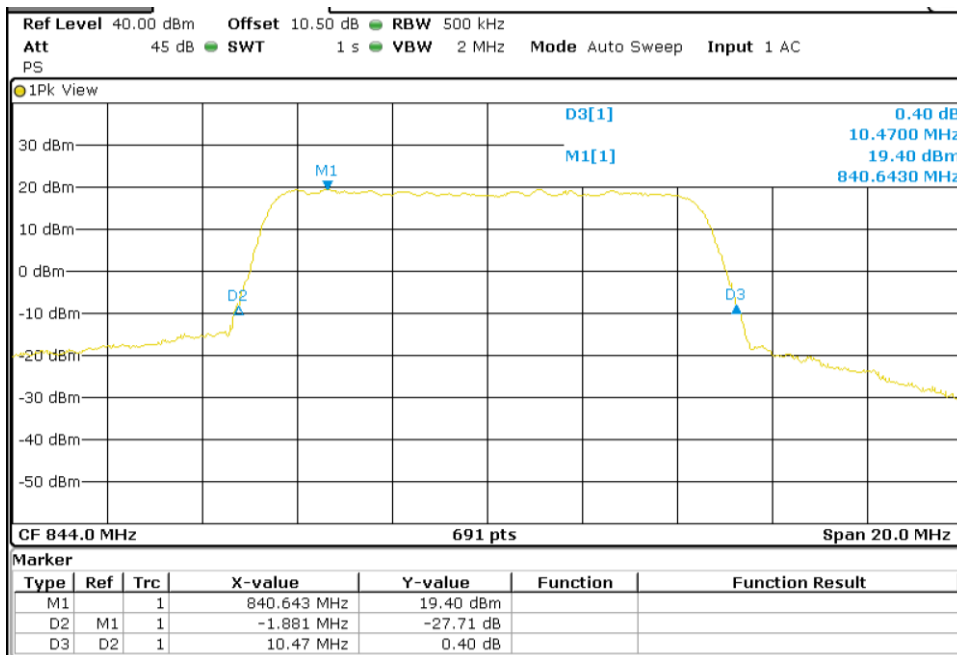

TEST RESULTS (Cont):

LTE 16QAM MODULATION. BW = 10 MHz

Lowest Channel 99% Occupied Bandwidth

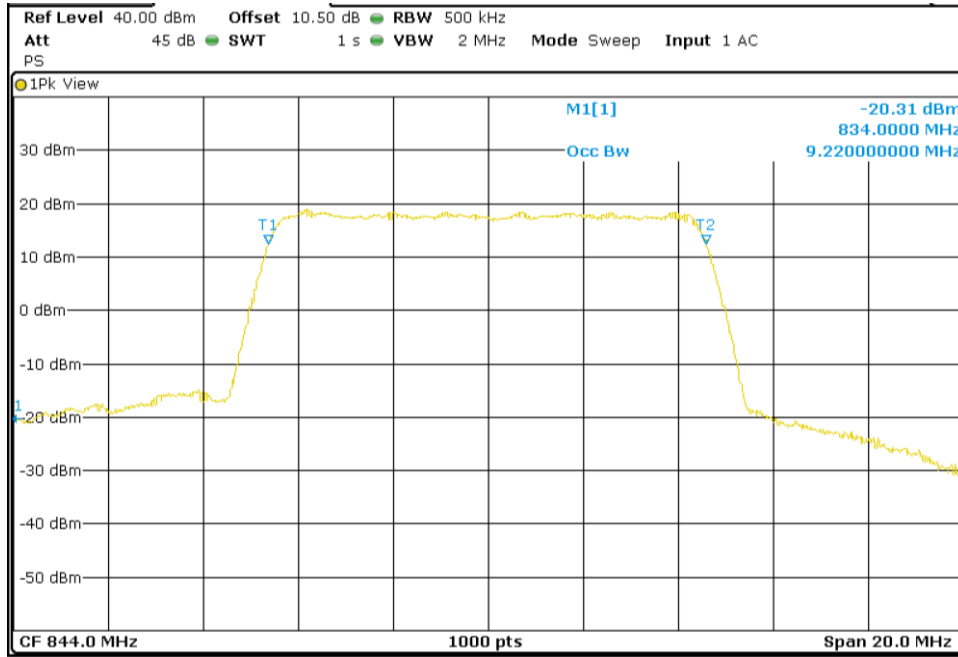

Lowest Channel 26dBc Bandwidth kHz

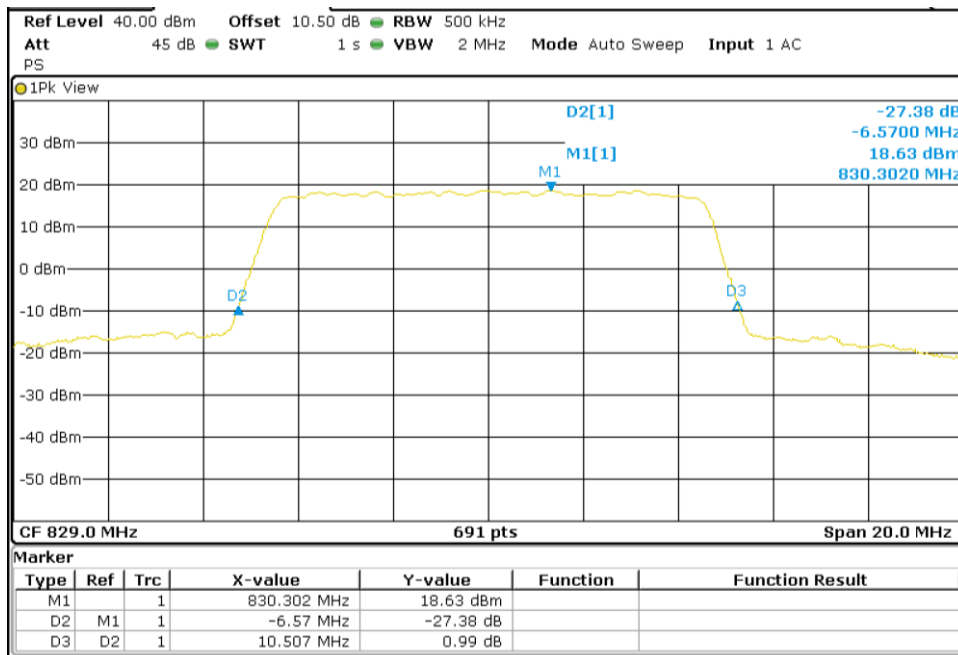

TEST RESULTS (Cont):

Middle Channel 99% Occupied Bandwidth

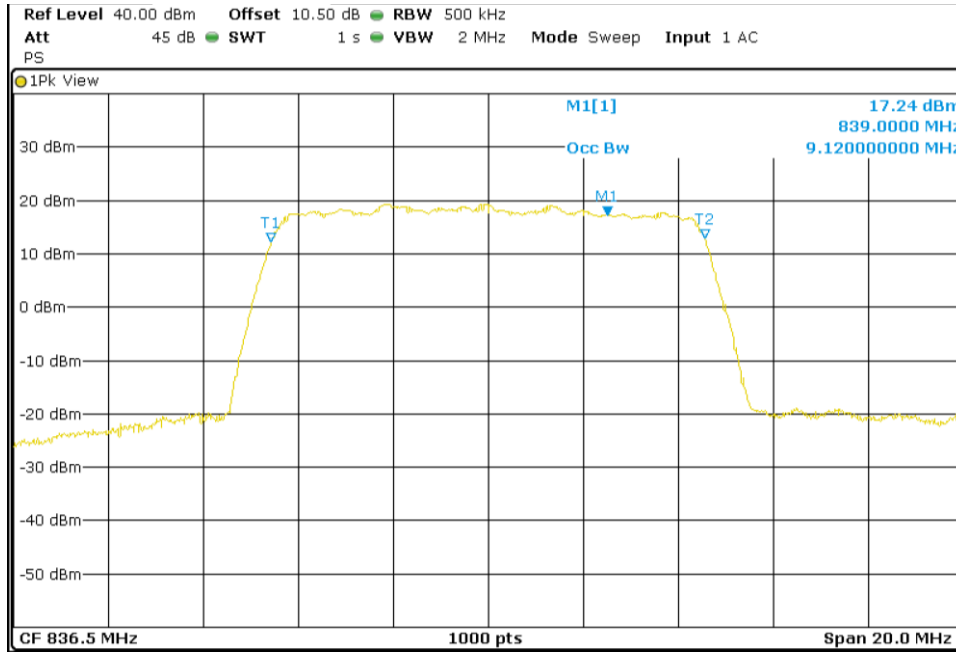

Middle Channel 26dBc Bandwidth kHz

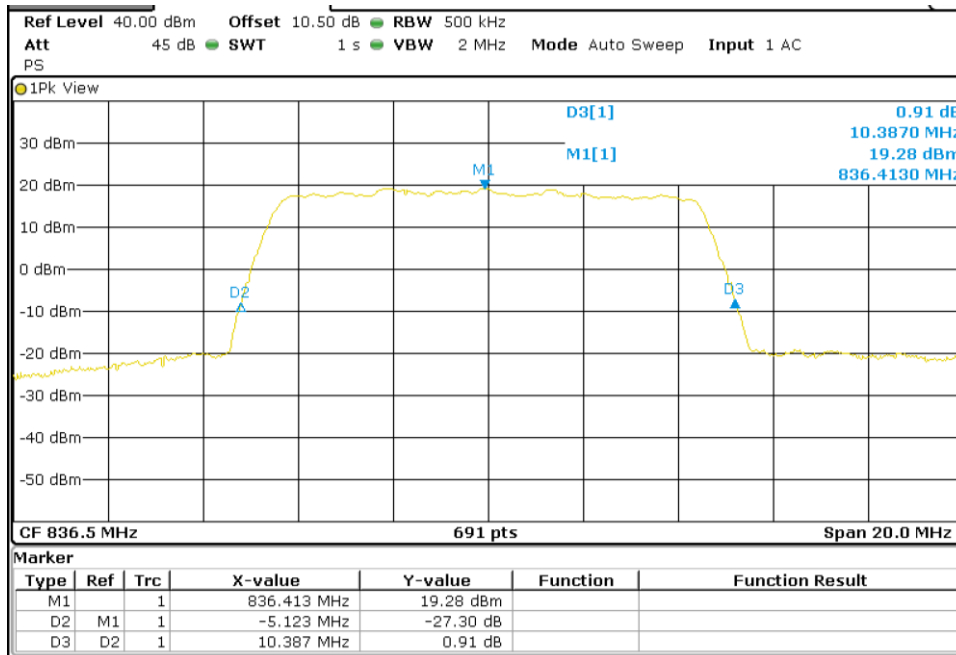

TEST RESULTS (Cont):

Highest Channel 99% Occupied Bandwidth

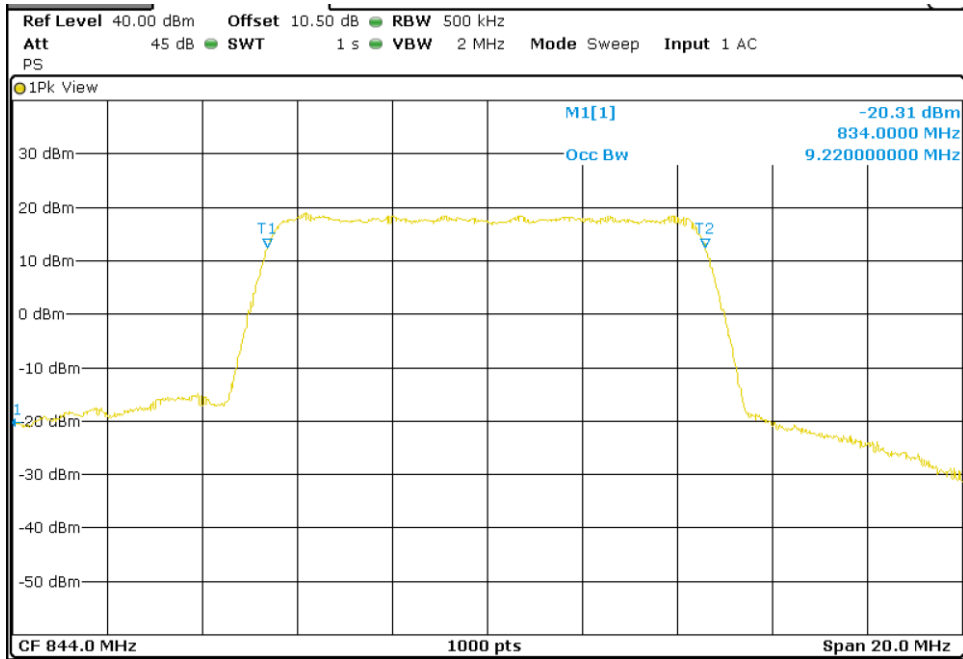

Highest Channel 26dBc Bandwidth kHz

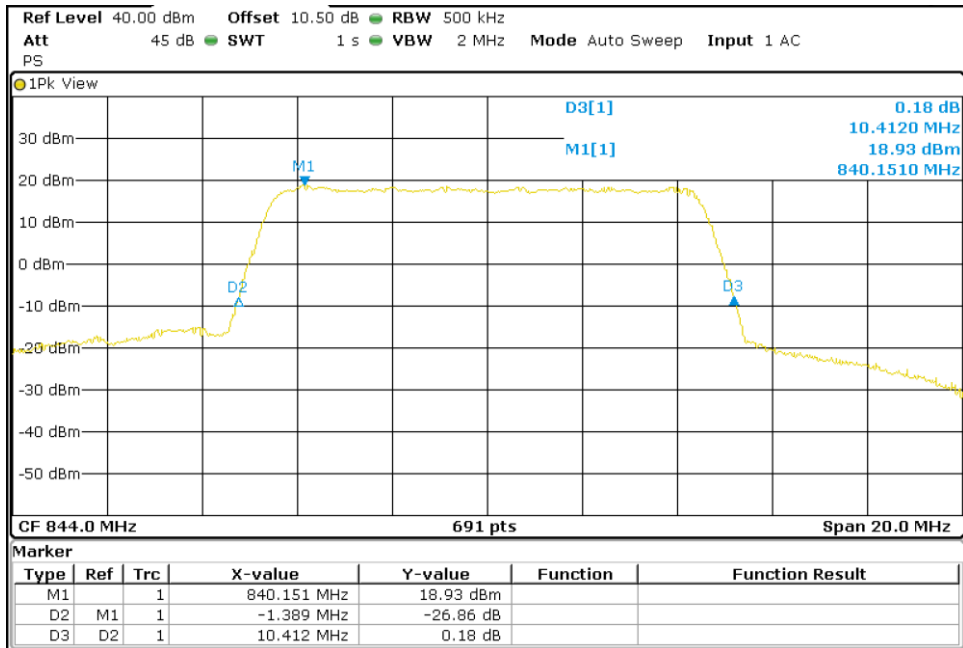

TEST RESULTS (Cont):

LTE QPSK MODULATION. BW = 15 MHz

Lowest Channel 99% Occupied Bandwidth

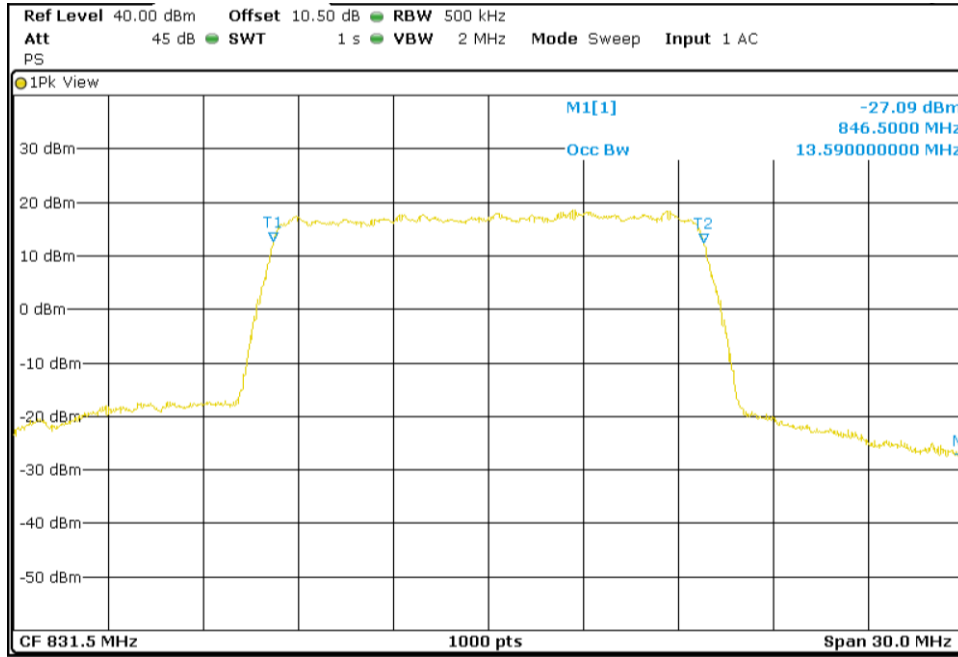

Lowest Channel 26dBc Bandwidth kHz

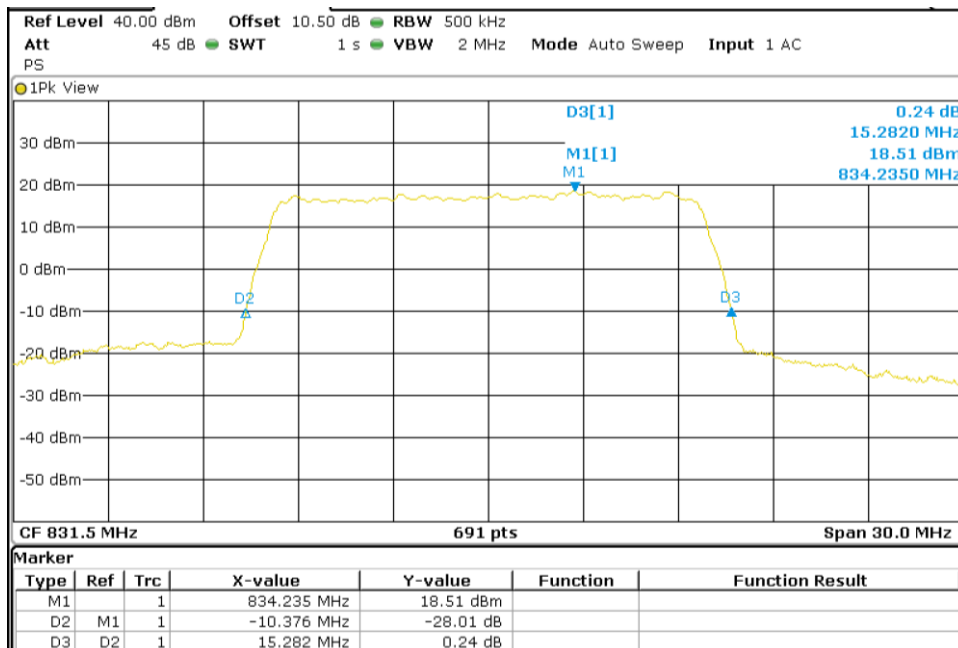

TEST RESULTS (Cont):

Middle Channel 99% Occupied Bandwidth

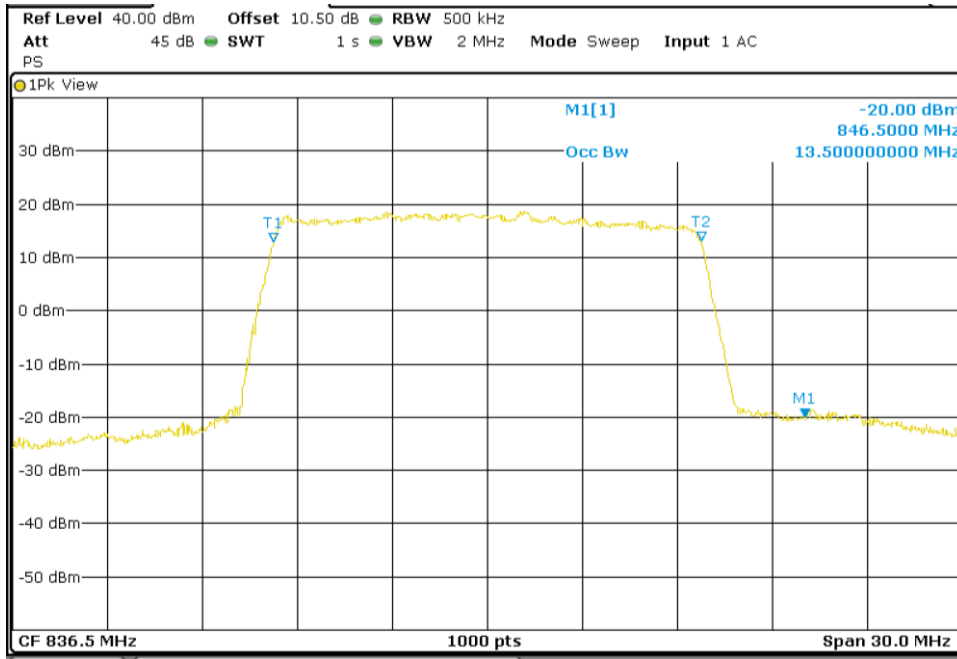

Middle Channel 26dBc Bandwidth kHz

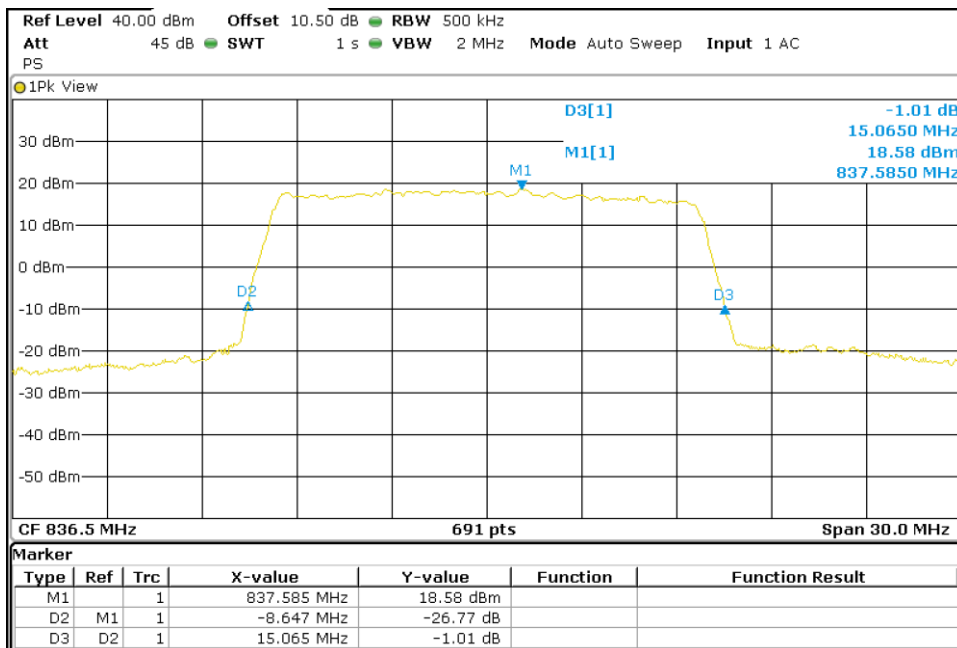

TEST RESULTS (Cont):

Highest Channel 99% Occupied Bandwidth

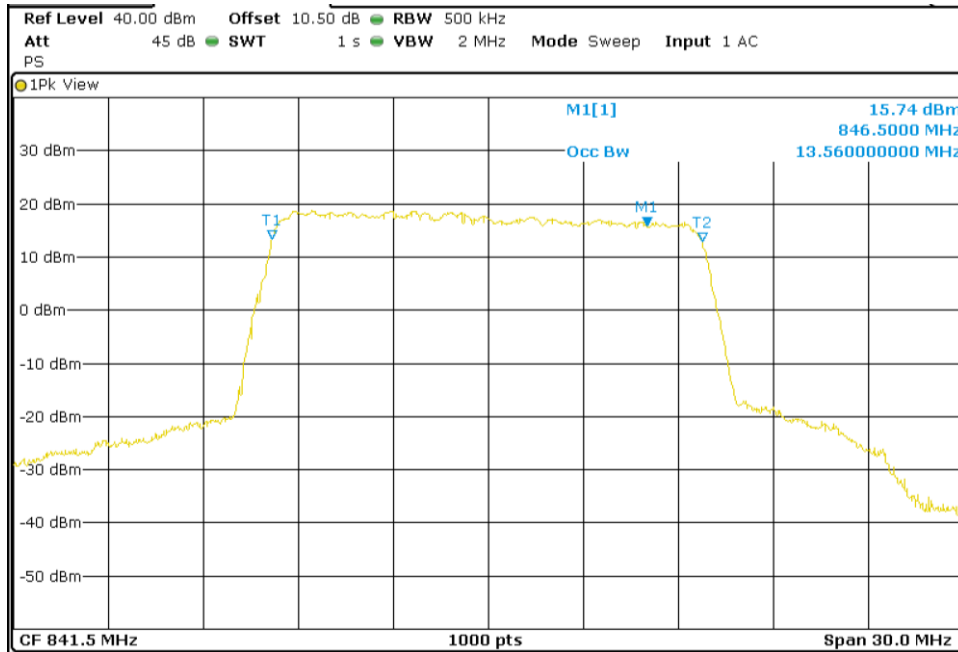

Highest Channel 26dBc Bandwidth kHz

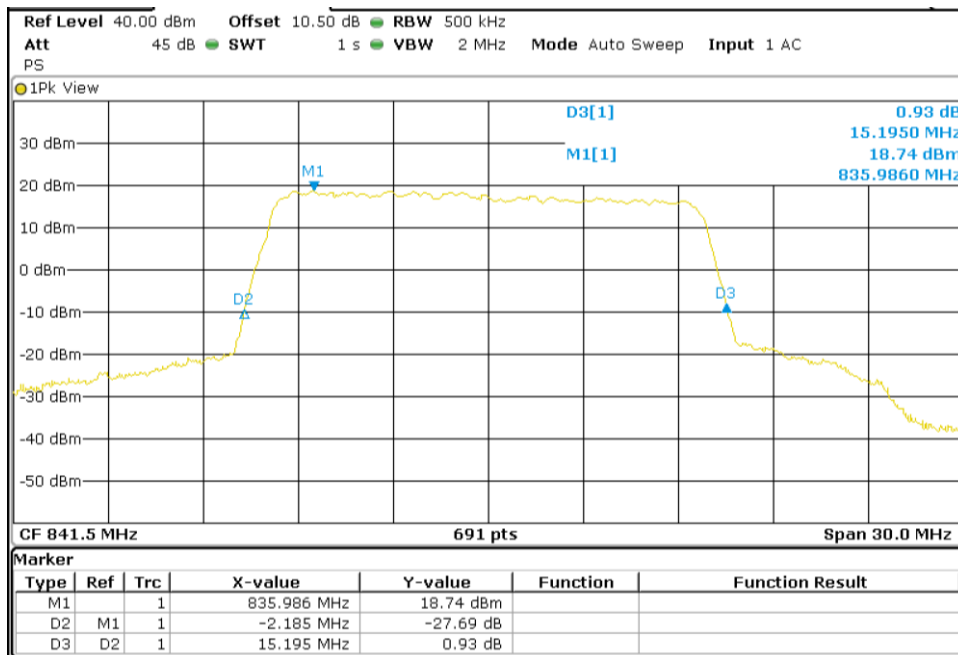

TEST RESULTS (Cont):

LTE 16QAM MODULATION. BW = 15 MHz

Lowest Channel 99% Occupied Bandwidth

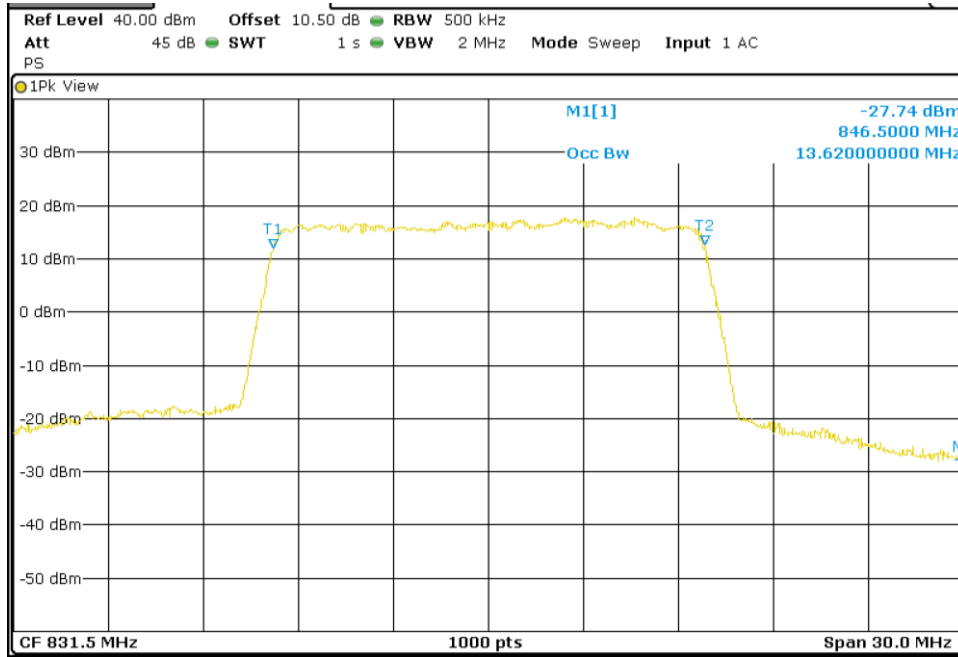

Lowest Channel 26dBc Bandwidth kHz

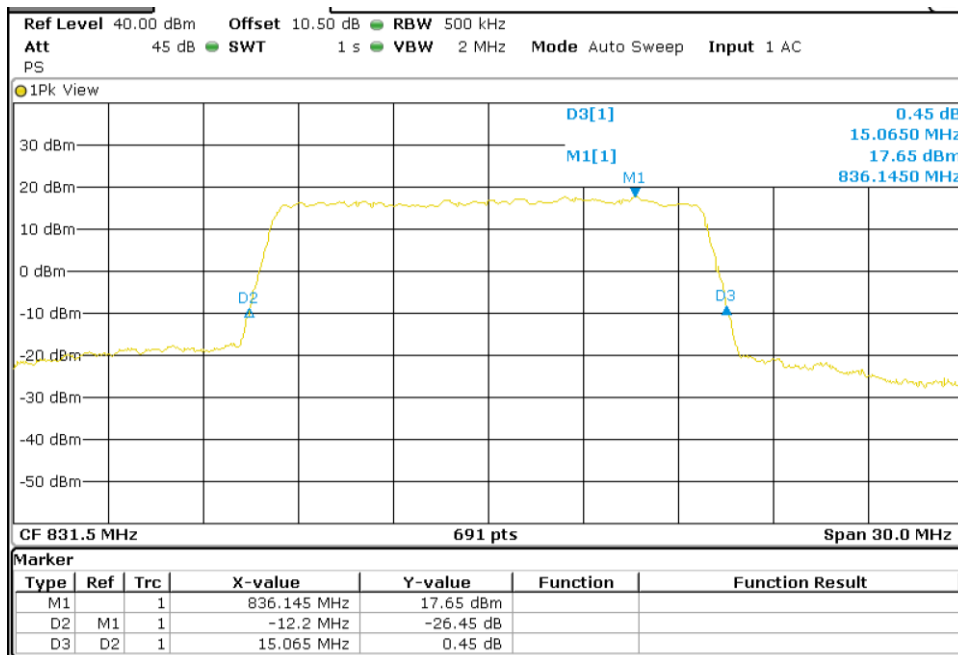

TEST RESULTS (Cont):

Middle Channel 99% Occupied Bandwidth

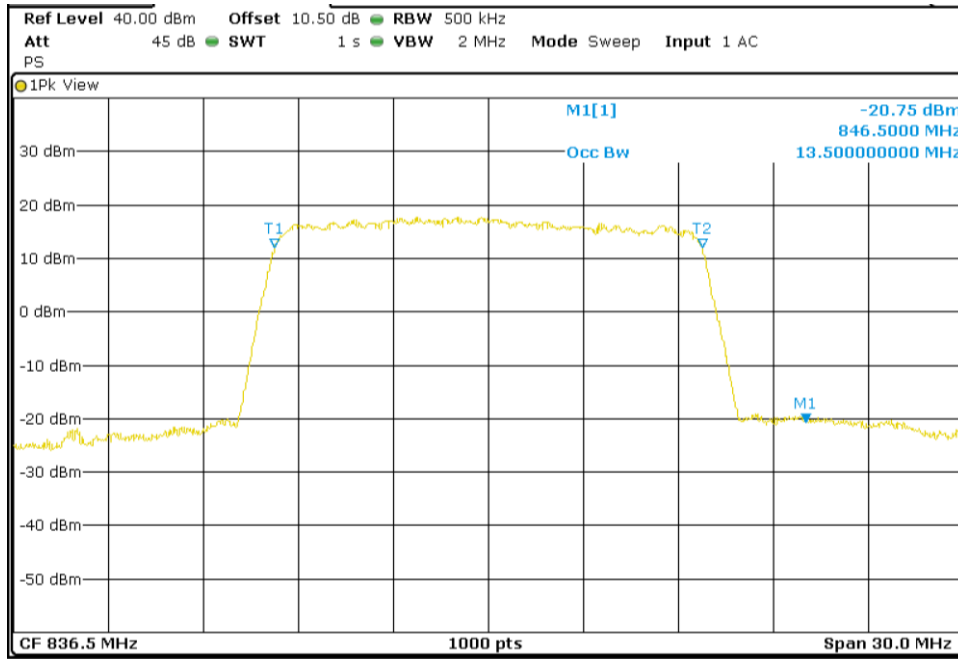

Middle Channel 26dBc Bandwidth kHz

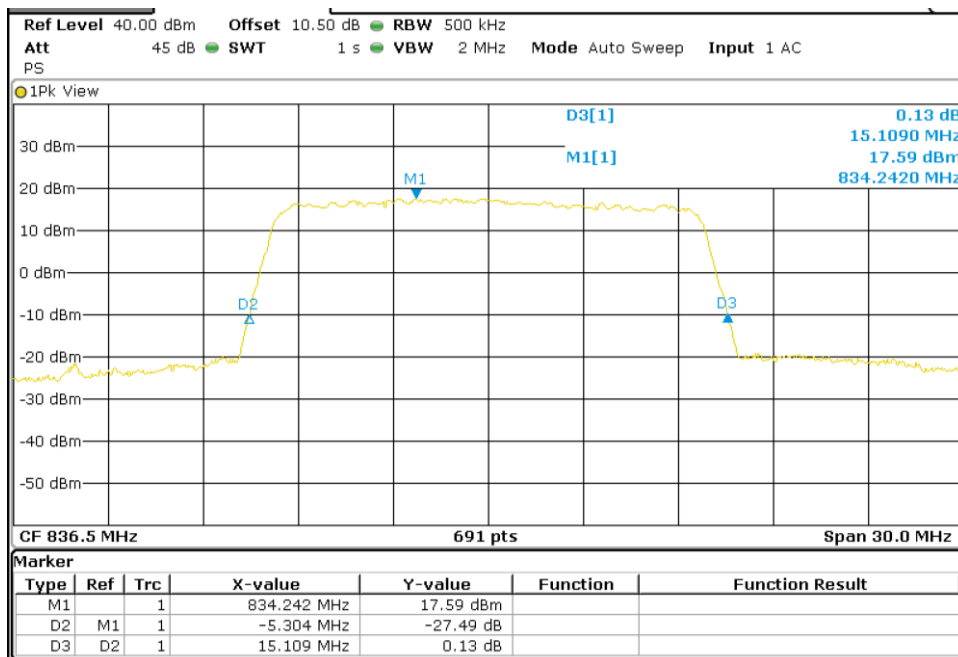

TEST RESULTS (Cont):

Highest Channel 99% Occupied Bandwidth

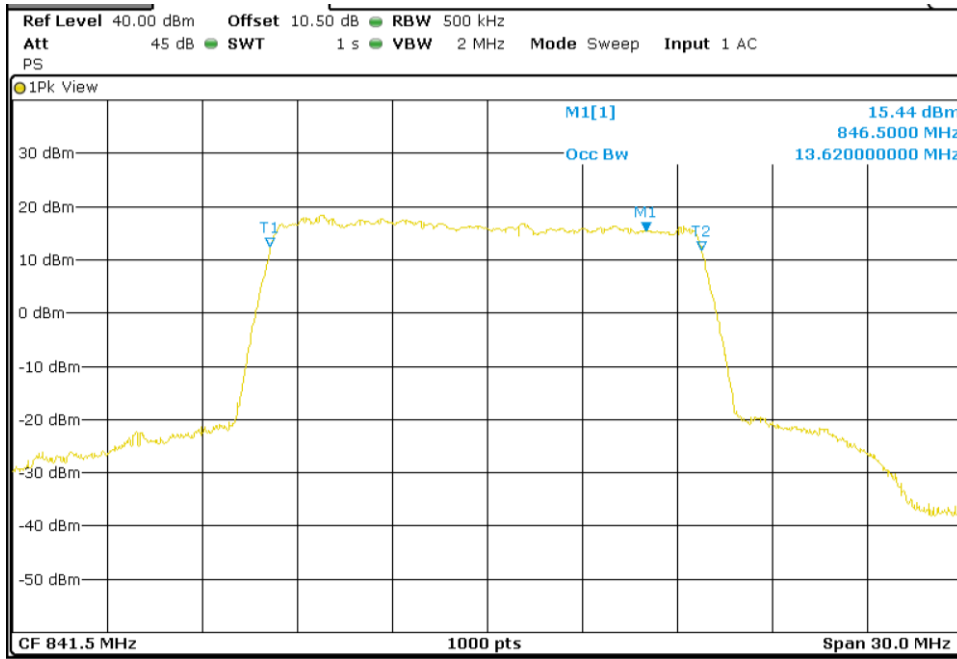

Highest Channel 26dBc Bandwidth kHz

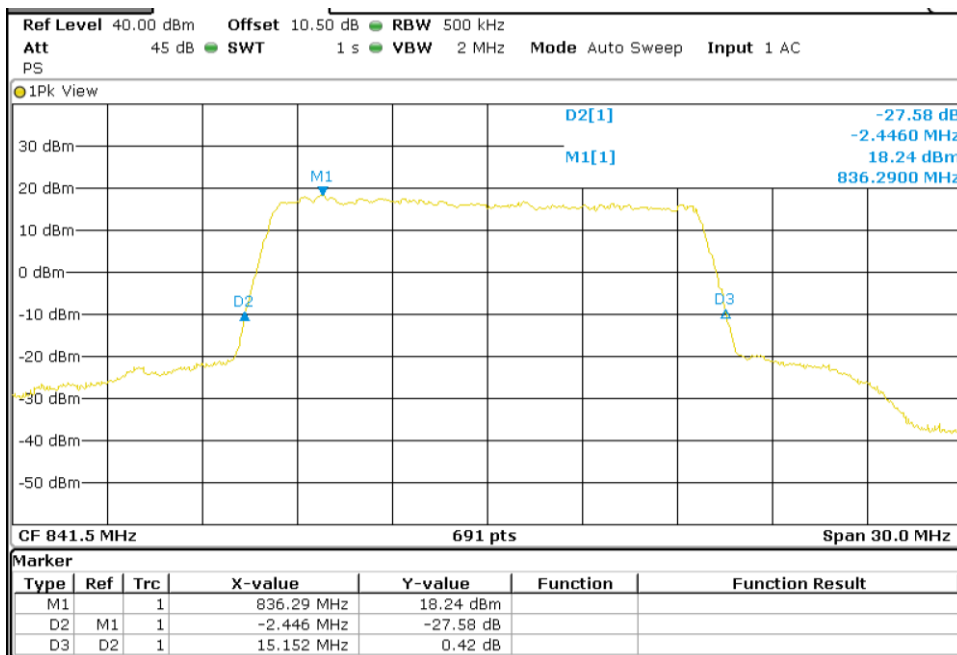

TESTED SAMPLES:	S/01
TESTED CONDITIONS MODES:	TC#02
TEST RESULTS:	PASS

LTE QPSK MODULATION. BW = 1.4 MHz

Frequency	824.0
99% Occupied bandwidth (MHz)	1.11

LTE 16QAM MODULATION. BW = 1.4 MHz

Frequency	824.0
99% Occupied bandwidth (MHz)	1.11

LTE QPSK MODULATION. BW = 3 MHz

Frequency	824.0
99% Occupied bandwidth (MHz)	2.70

LTE 16QAM MODULATION. BW = 3 MHz

Frequency	824.0
99% Occupied bandwidth (MHz)	2.69

LTE QPSK MODULATION. BW = 5 MHz

Frequency	824.0
99% Occupied bandwidth (MHz)	4.52

TEST RESULTS (Cont):		
LTE 16QAM MODULATION. BW = 5 MHz		
	Frequency	824.0
	99% Occupied bandwidth (MHz)	4.50
LTE QPSK MODULATION. BW = 10 MHz		
	Frequency	824.0
	99% Occupied bandwidth (MHz)	8.96
LTE 16QAM MODULATION. BW = 10 MHz		
	Frequency	824.0
	99% Occupied bandwidth (MHz)	8.94
LTE QPSK MODULATION. BW = 15 MHz		
	Frequency	824.0
	99% Occupied bandwidth (MHz)	13.44
LTE 16QAM MODULATION. BW = 15 MHz		
	Frequency	824.0
	99% Occupied bandwidth (MHz)	13.41

TEST RESULTS (Cont):

LTE QPSK MODULATION. BW = 1.4 MHz

99% Occupied Bandwidth

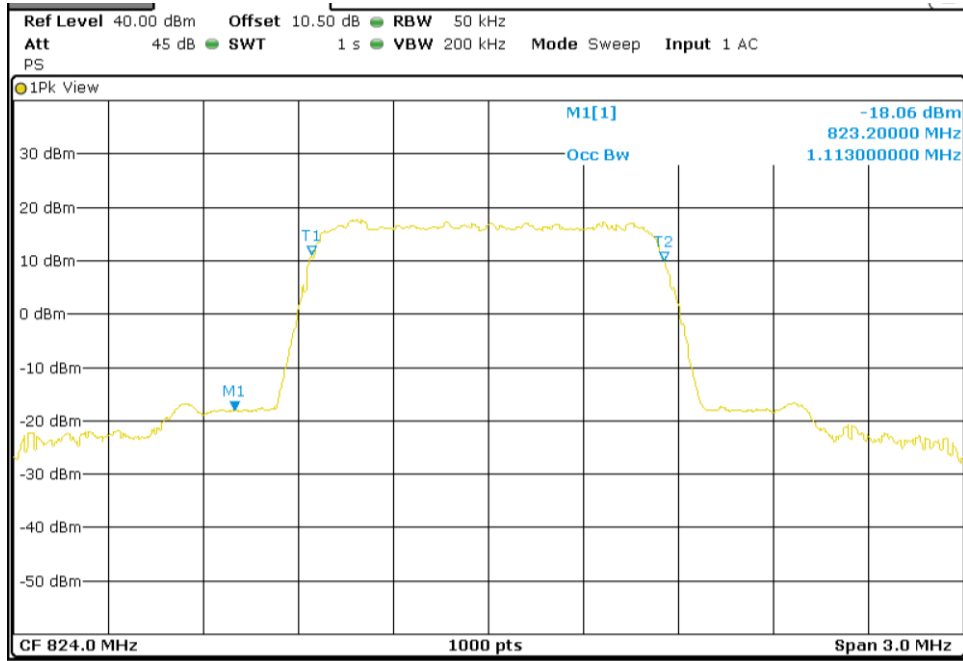

LTE 16QAM MODULATION. BW = 1.4 MHz

99% Occupied Bandwidth

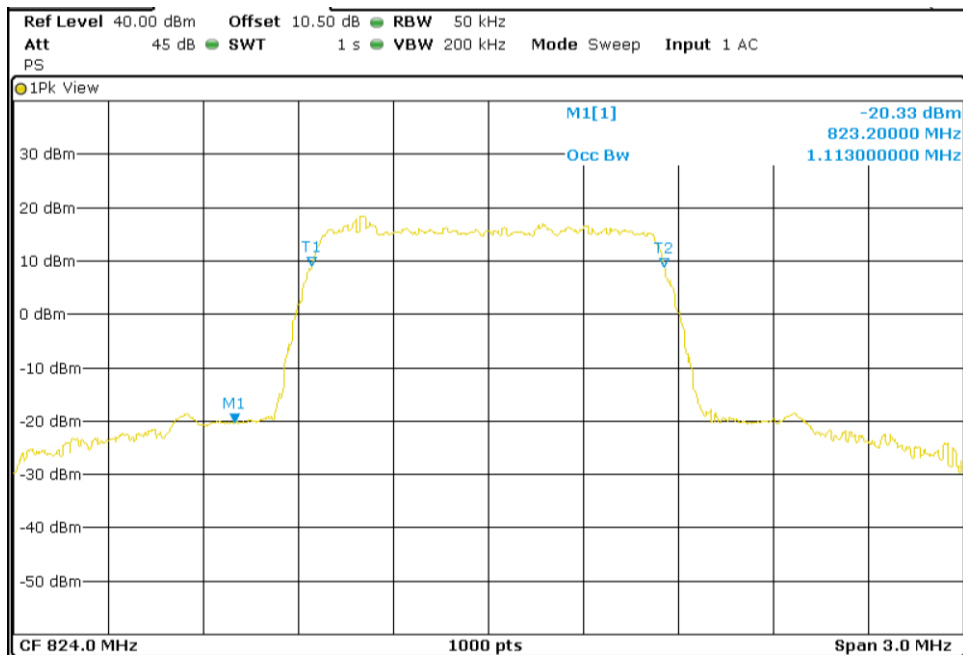

TEST RESULTS (Cont):

LTE QPSK MODULATION. BW = 3 MHz

99% Occupied Bandwidth

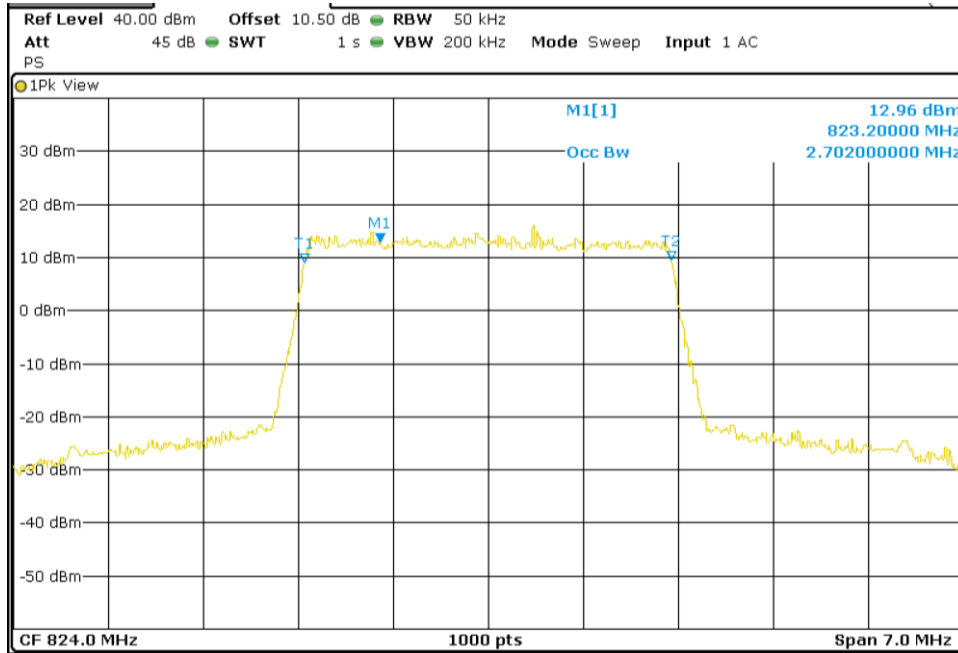

LTE 16QAM MODULATION. BW = 3 MHz

99% Occupied Bandwidth

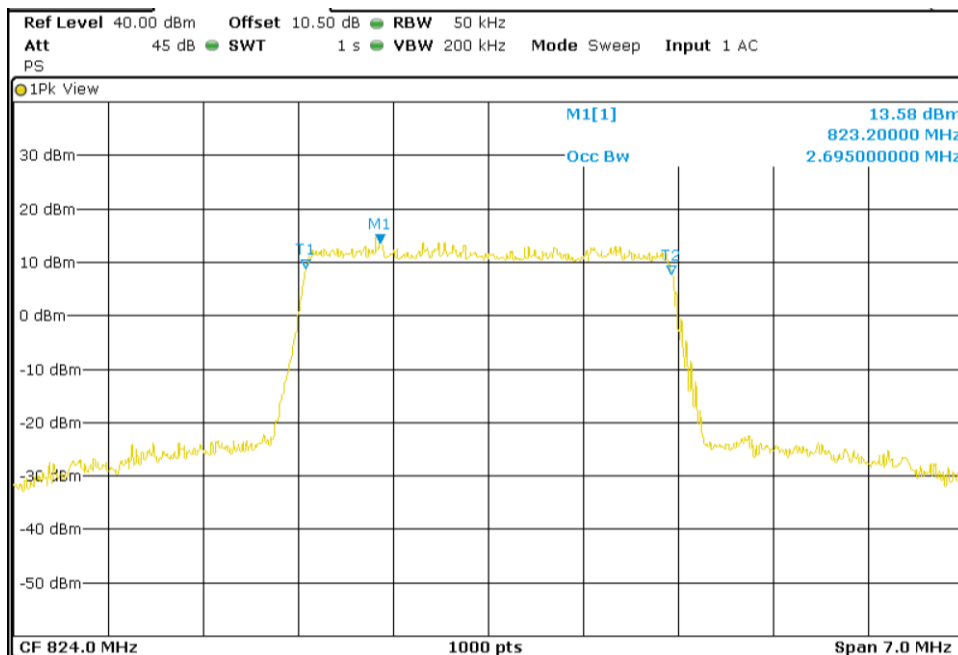

TEST RESULTS (Cont):

LTE QPSK MODULATION. BW = 5 MHz

99% Occupied Bandwidth

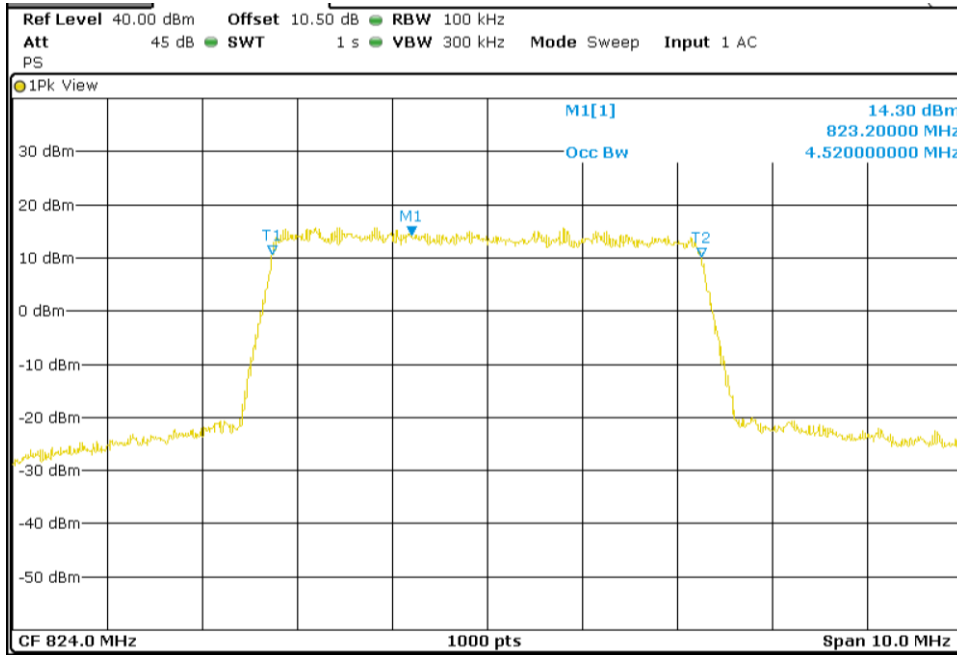

LTE 16QAM MODULATION. BW = 5 MHz

99% Occupied Bandwidth

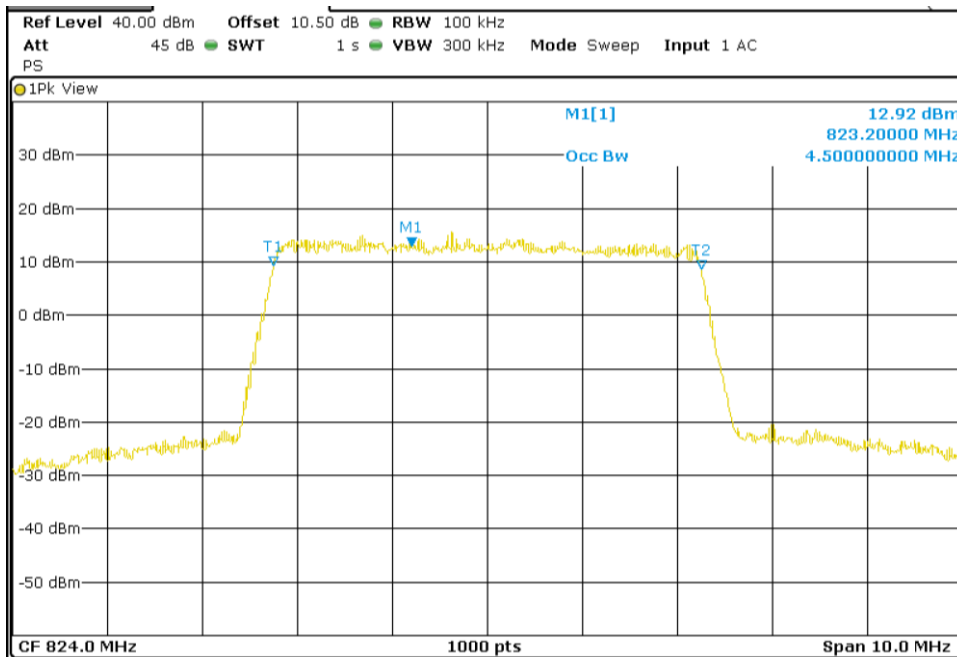

TEST RESULTS (Cont):

LTE QPSK MODULATION. BW = 10 MHz

99% Occupied Bandwidth

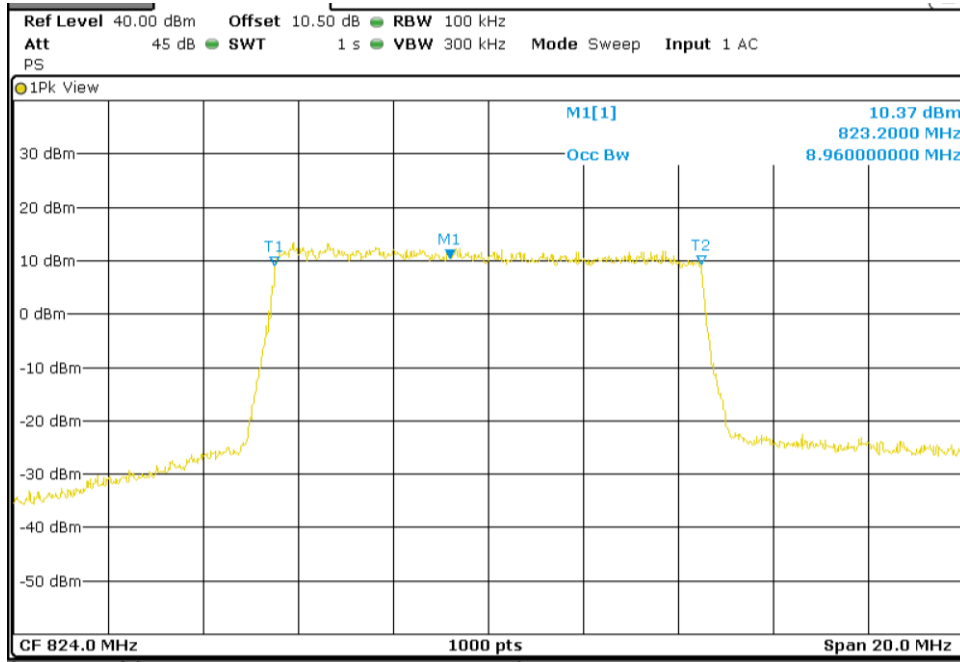

LTE 16QAM MODULATION. BW = 10 MHz

99% Occupied Bandwidth

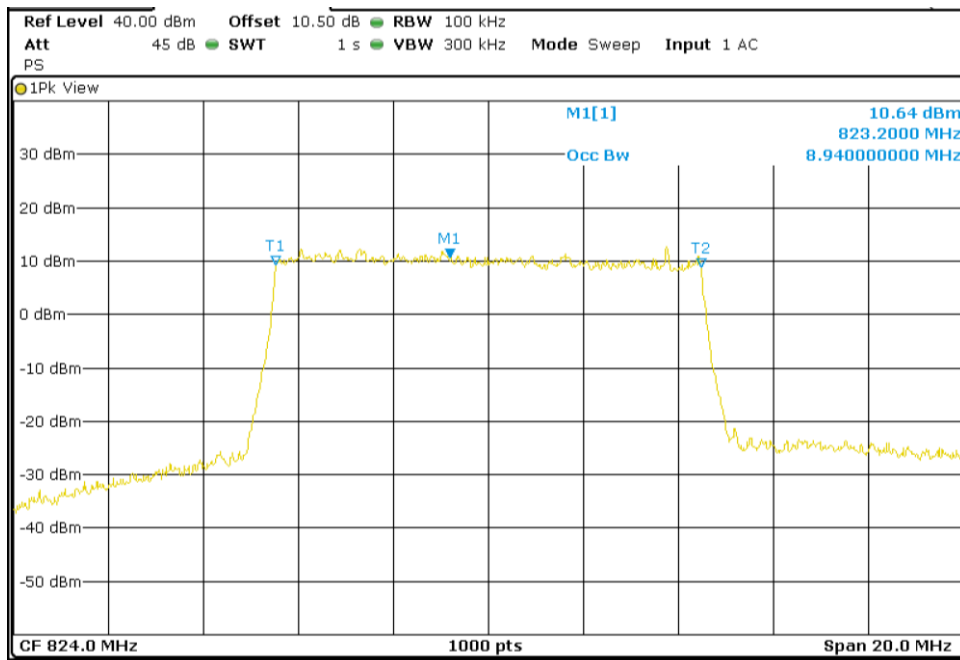

TEST RESULTS (Cont):

LTE QPSK MODULATION. BW = 15 MHz

99% Occupied Bandwidth

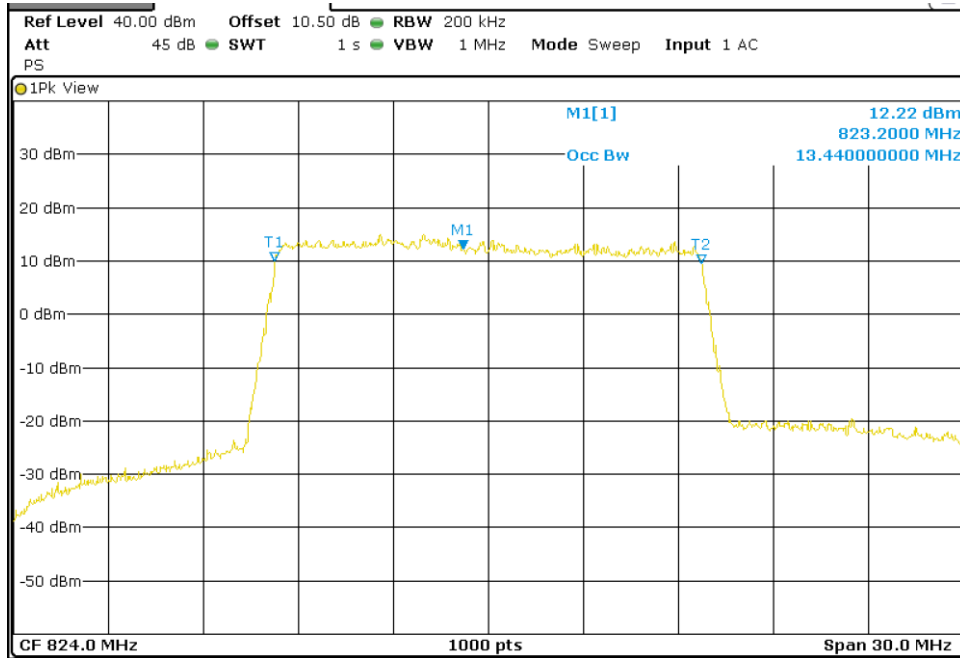

LTE 16QAM MODULATION. BW = 15 MHz

99% Occupied Bandwidth

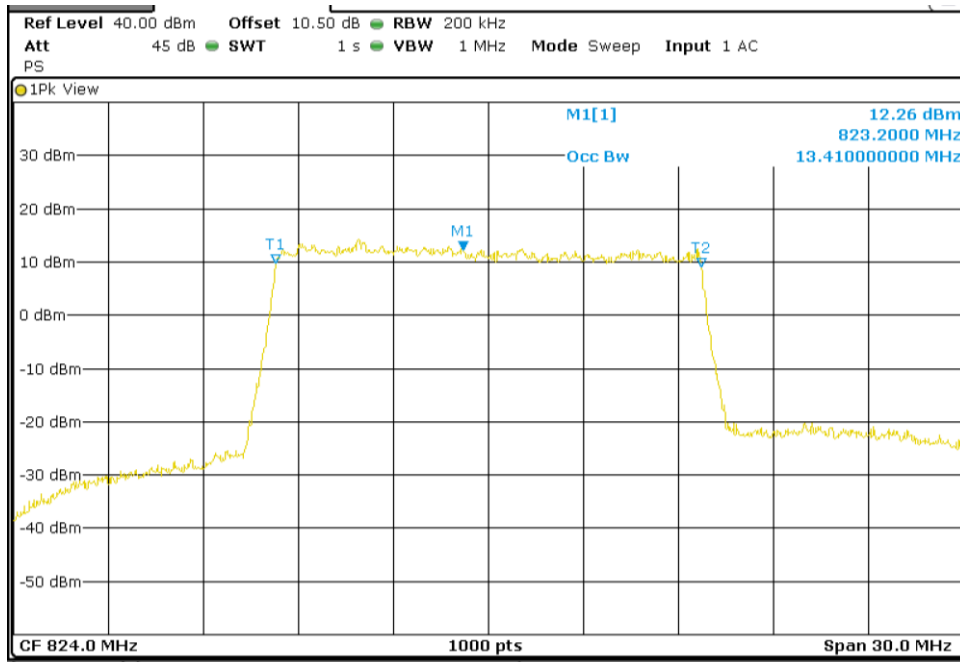

TEST A.5: SPURIOUS EMISSIONS AT ANTENNA TERMINALS

LIMITS:	Product standard:	FCC Part 22 / IC RSS-132
	Test standard:	FCC §2.1051 and § 22.917 / RSS-132 Clause 5.5

LIMITS

According to specification, the power of emissions shall be attenuated below the transmitter power (P) by a factor of at least $43 + 10 \log (P)$ dB. P in watts.

At P_o transmitting power of 2 watts (33 dBm), the specified minimum attenuation becomes $43+10\log (P_o)$. and the level in dBm relative to P_o becomes:

$$P_o \text{ (dBm)} - [43 + 10 \log (P_o \text{ in watts})] = -13 \text{ dBm}$$

TEST SETUP

The EUT RF output connector was connected to a spectrum analyzer and to the Universal Radio Communication Tester R&S CMW500 (selecting maximum transmission power of the EUT and different modes of modulation) using a 50-ohm attenuator and a power splitter.

The spectrum was investigated from 9 kHz to 18 GHz for LTE Band 26.

The reading of the spectrum analyzer is corrected with the attenuation loss of connection between output terminal of EUT and input of the spectrum analyzer.

For LTE mode the configuration of Resource Blocks and modulation which is the worst case for conducted power was used.

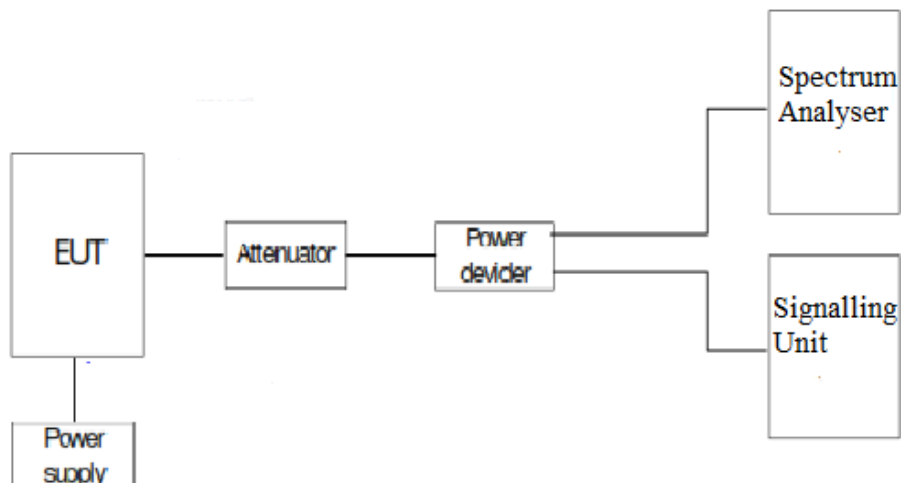

TESTED SAMPLES:	S/01
TESTED CONDITIONS MODES:	TC#01
TEST RESULTS:	PASS

Frequency range 9 kHz – 18 GHz

LTE QPSK MODULATION. BW = 1.4 MHz

Lowest Channel

The spurious signals were detected more than 10 dB below the limit in the frequency range.

Middle Channel

The spurious signals were detected more than 10 dB below the limit in the frequency range.

Highest Channel

The spurious signals were detected more than 10 dB below the limit in the frequency range.

LTE QPSK MODULATION. BW = 3 MHz

Lowest Channel

The spurious signals were detected more than 10 dB below the limit in the frequency range.

Middle Channel

The spurious signals were detected more than 10 dB below the limit in the frequency range.

Highest Channel

The spurious signals were detected more than 10 dB below the limit in the frequency range.

LTE QPSK MODULATION. BW = 5 MHz

Lowest Channel

The spurious signals were detected more than 10 dB below the limit in the frequency range.

Middle Channel

The spurious signals were detected more than 10 dB below the limit in the frequency range.

Highest Channel

The spurious signals were detected more than 10 dB below the limit in the frequency range.

LTE QPSK MODULATION. BW = 10 MHz

Lowest Channel

The spurious signals were detected more than 10 dB below the limit in the frequency range.

Middle Channel

The spurious signals were detected more than 10 dB below the limit in the frequency range.

Highest Channel

The spurious signals were detected more than 10 dB below the limit in the frequency range.

LTE QPSK MODULATION. BW = 15 MHz

Lowest Channel

The spurious signals were detected more than 10 dB below the limit in the frequency range.

Middle Channel

The spurious signals were detected more than 10 dB below the limit in the frequency range.

Highest Channel

The spurious signals were detected more than 10 dB below the limit in the frequency range.

TEST RESULTS (Cont):

Highest Channel

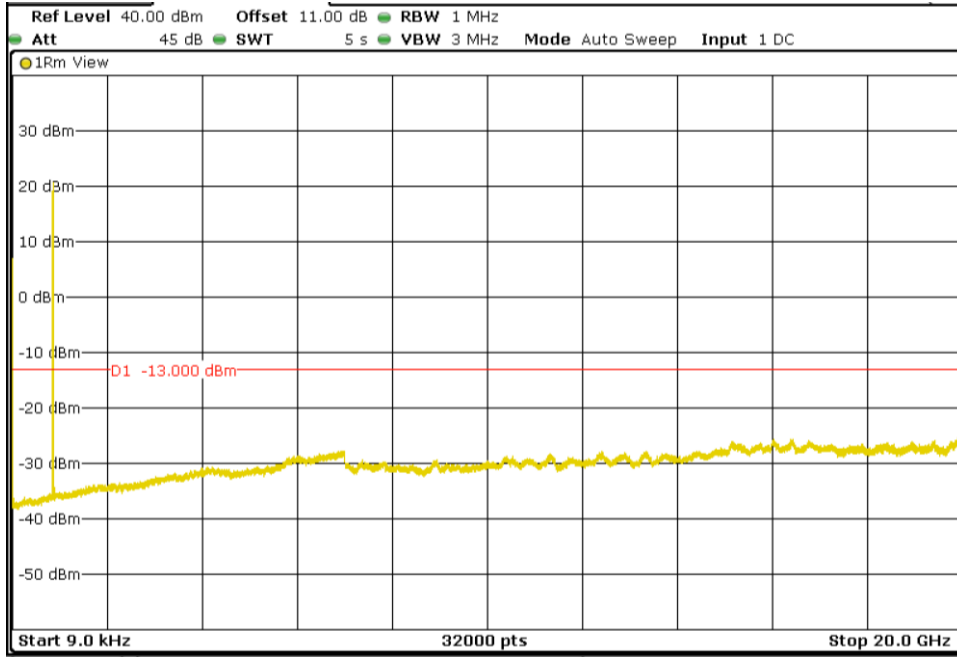

LTE QPSK MODULATION. BW = 3 MHz

Lowest Channel

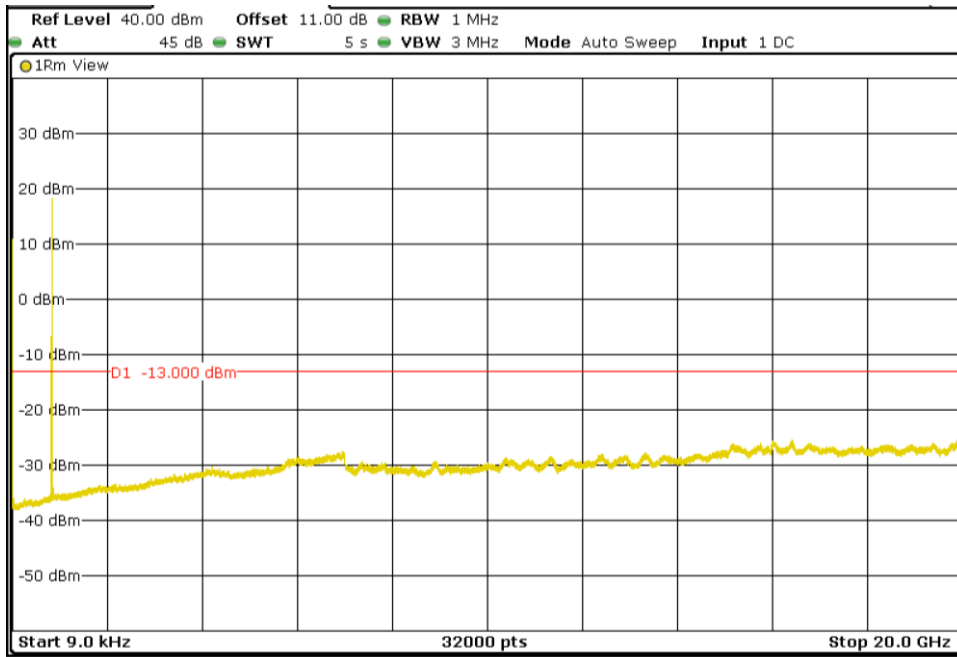

TEST RESULTS (Cont):

Middle Channel

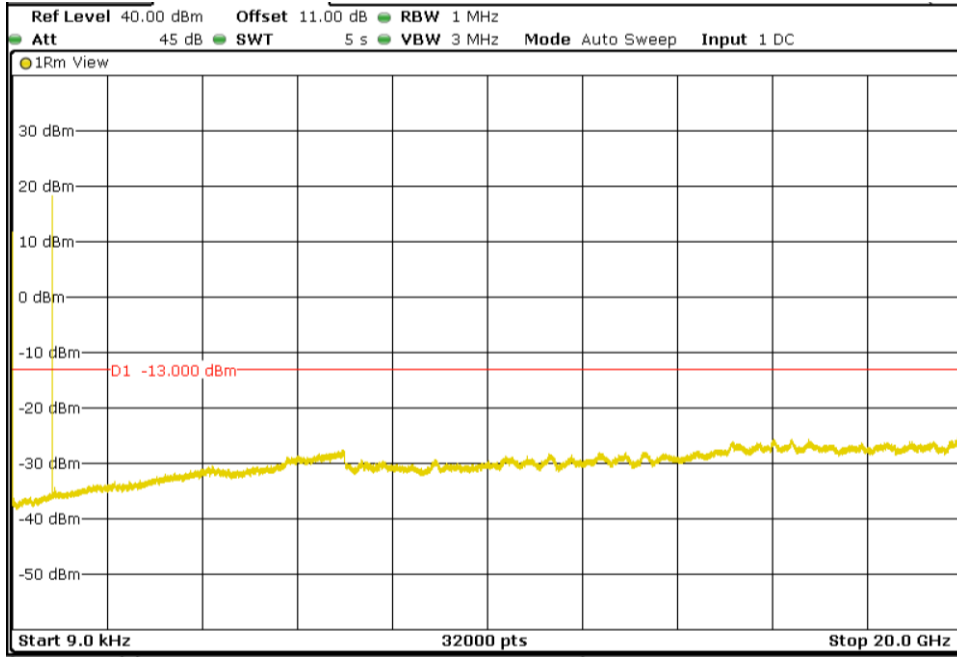

Highest Channel

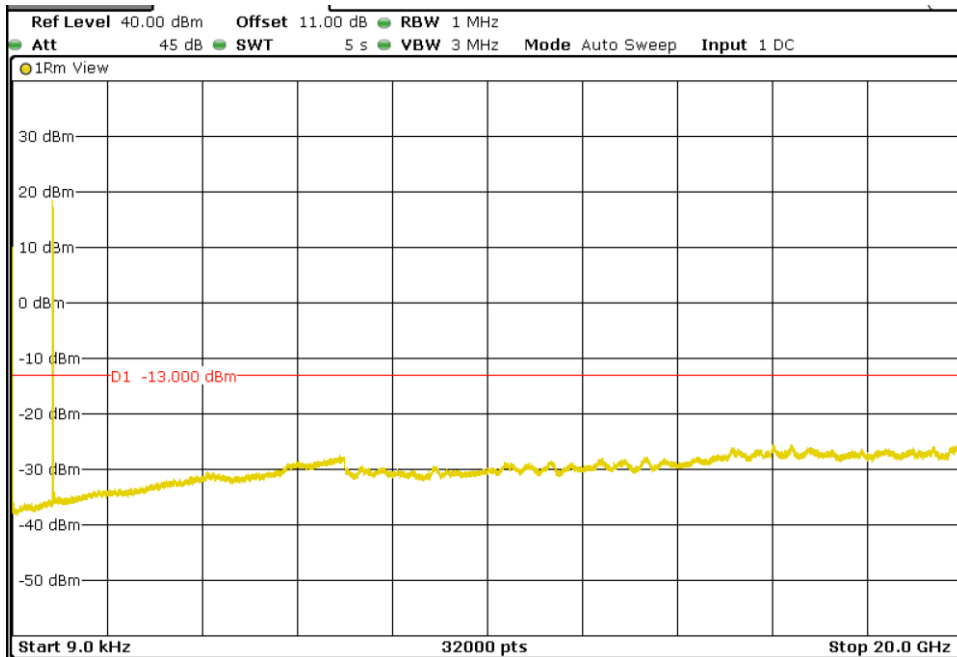

TEST RESULTS (Cont):

LTE QPSK MODULATION. BW = 5 MHz

Lowest Channel

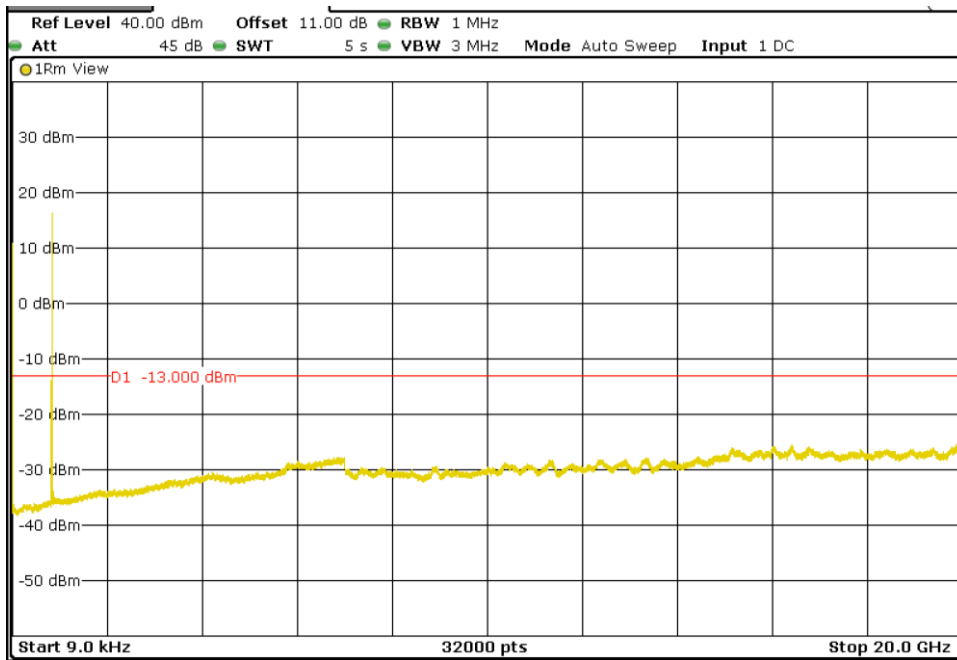

Middle Channel

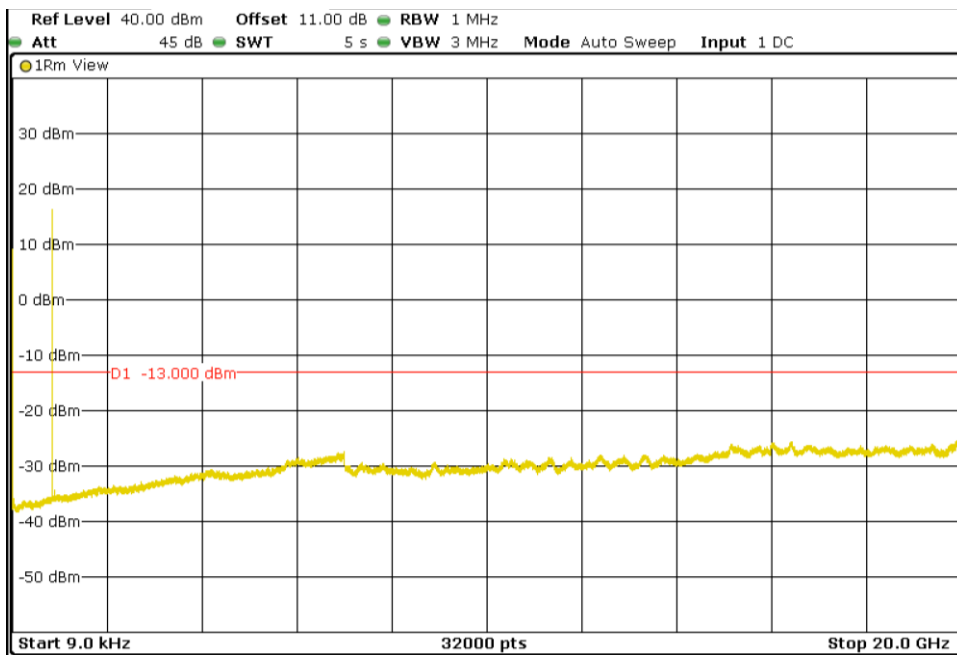

TEST RESULTS (Cont):

Highest Channel

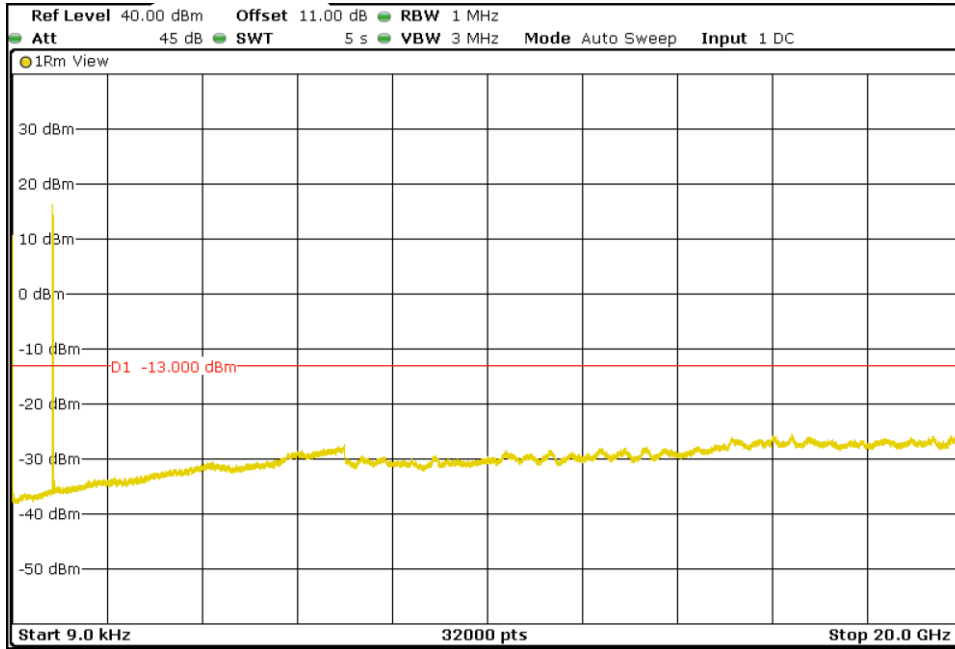

LTE QPSK MODULATION. BW = 10 MHz

Lowest Channel

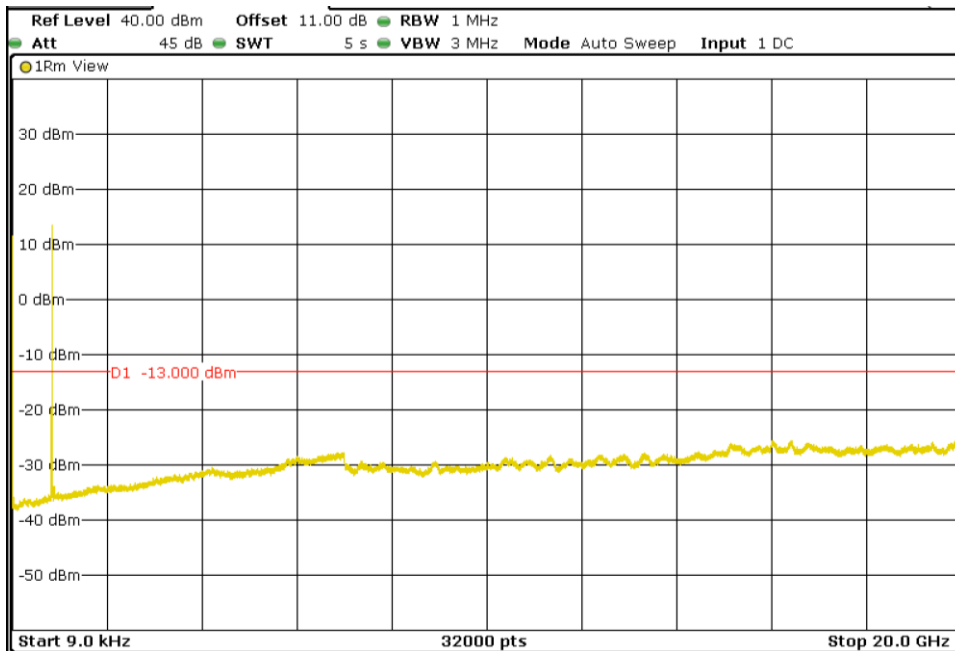

TEST RESULTS (Cont):

Middle Channel

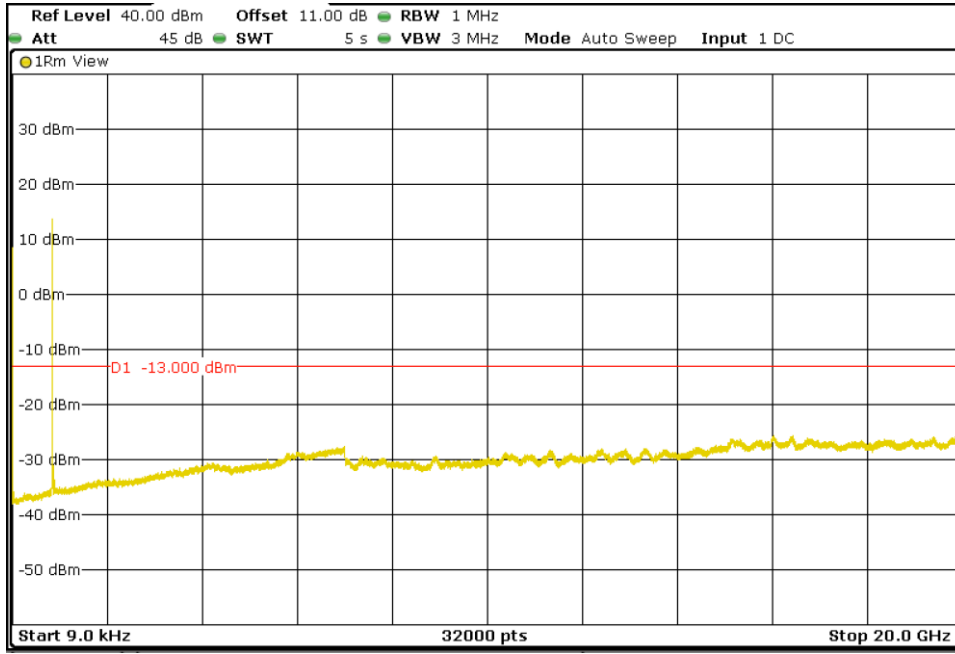

Highest Channel

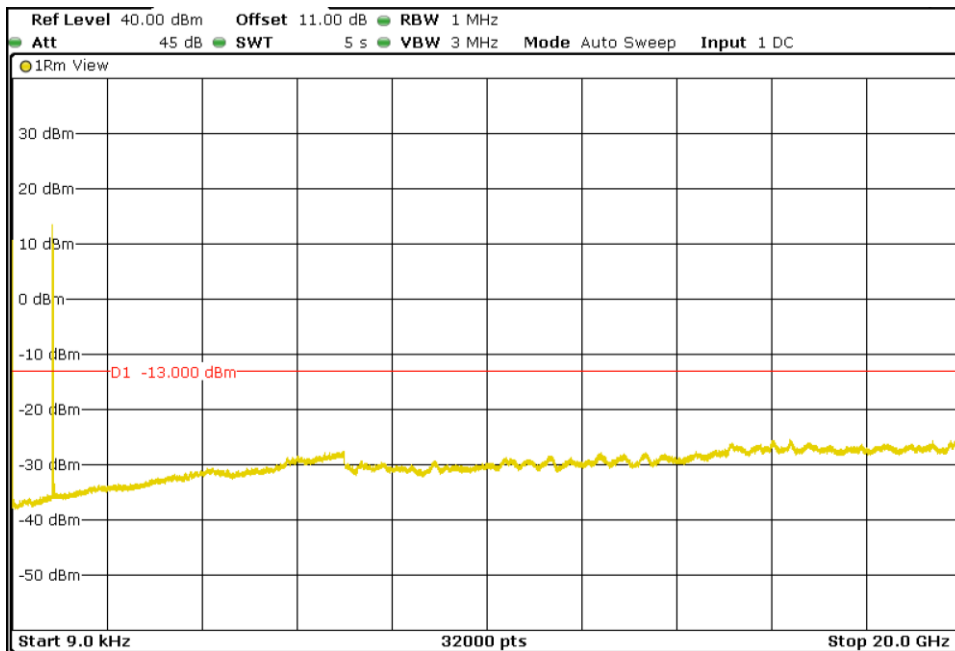

TEST RESULTS (Cont):

LTE QPSK MODULATION. BW = 15 MHz

Lowest Channel

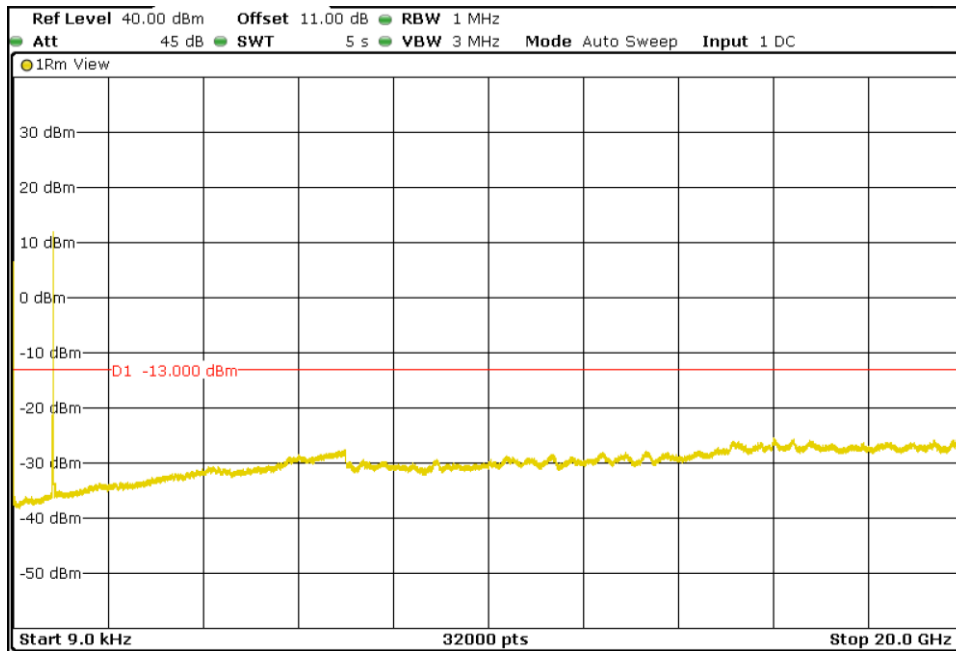

Middle Channel

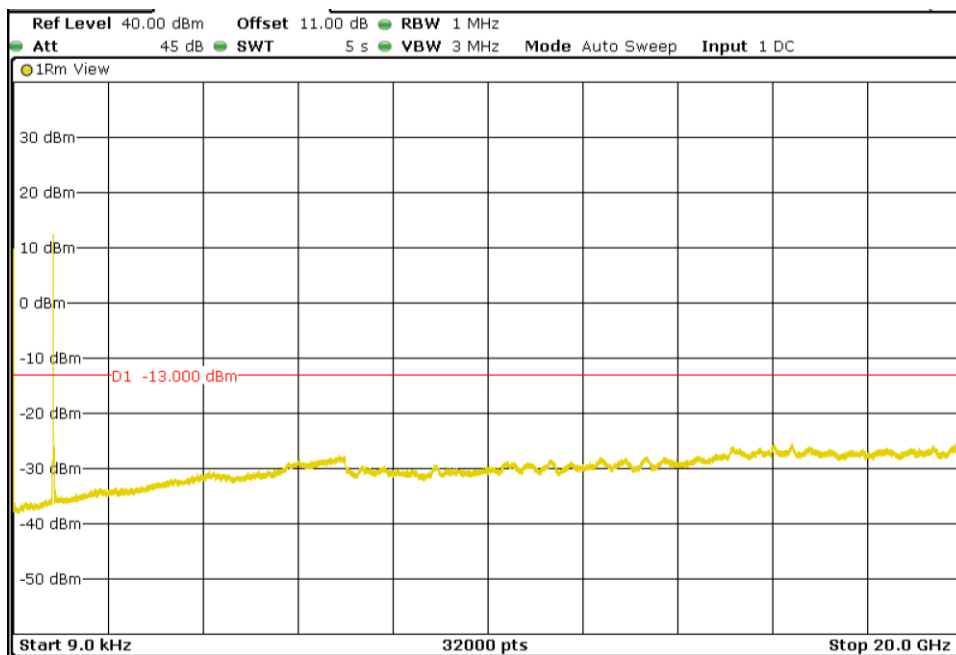

TEST RESULTS (Cont):

Highest Channel

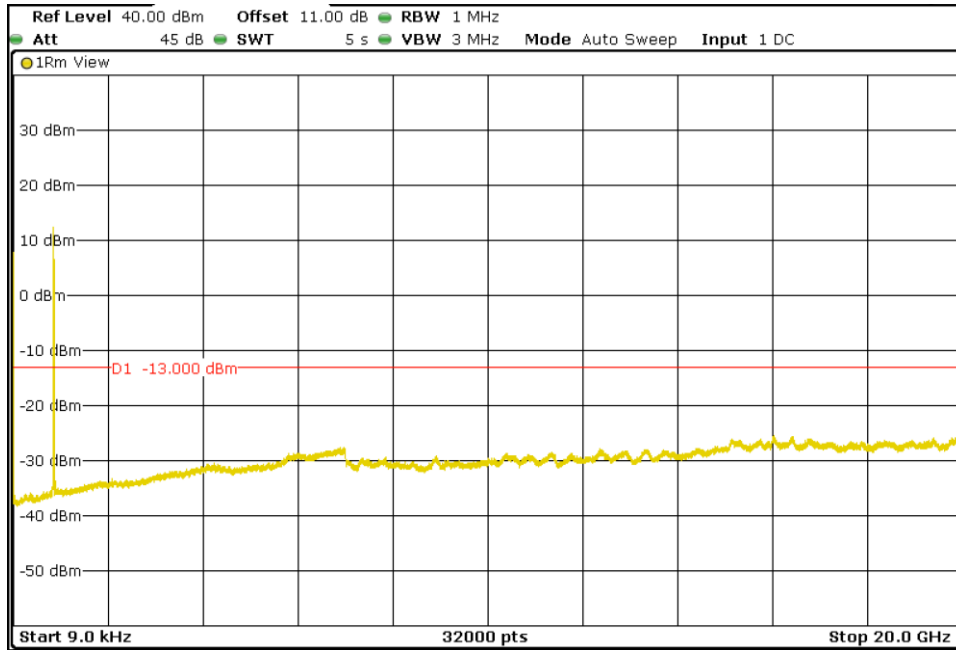

TESTED SAMPLES:	S/01
TESTED CONDITIONS MODES:	TC#02
TEST RESULTS:	PASS
<p><u>Frequency range 9 kHz – 18 GHz</u></p> <p>LTE QPSK MODULATION. BW = 1.4 MHz</p> <p>Lowest Channel The spurious signals were detected more than 10 dB below the limit in the frequency range.</p> <p>Middle Channel The spurious signals were detected more than 10 dB below the limit in the frequency range.</p> <p>Highest Channel The spurious signals were detected more than 10 dB below the limit in the frequency range.</p> <p>LTE QPSK MODULATION. BW = 3 MHz</p> <p>Lowest Channel The spurious signals were detected more than 10 dB below the limit in the frequency range.</p> <p>Middle Channel The spurious signals were detected more than 10 dB below the limit in the frequency range.</p> <p>Highest Channel The spurious signals were detected more than 10 dB below the limit in the frequency range.</p> <p>LTE QPSK MODULATION. BW = 5 MHz</p> <p>Lowest Channel The spurious signals were detected more than 10 dB below the limit in the frequency range.</p> <p>Middle Channel The spurious signals were detected more than 10 dB below the limit in the frequency range.</p> <p>Highest Channel The spurious signals were detected more than 10 dB below the limit in the frequency range.</p> <p>LTE QPSK MODULATION. BW = 10 MHz</p> <p>Lowest Channel The spurious signals were detected more than 10 dB below the limit in the frequency range.</p> <p>Middle Channel The spurious signals were detected more than 10 dB below the limit in the frequency range.</p> <p>Highest Channel The spurious signals were detected more than 10 dB below the limit in the frequency range.</p> <p>LTE QPSK MODULATION. BW = 15 MHz</p> <p>Lowest Channel The spurious signals were detected more than 10 dB below the limit in the frequency range.</p> <p>Middle Channel The spurious signals were detected more than 10 dB below the limit in the frequency range.</p> <p>Highest Channel The spurious signals were detected more than 10 dB below the limit in the frequency range.</p>	

TEST RESULTS (Cont):

LTE QPSK MODULATION. BW = 1.4 MHz

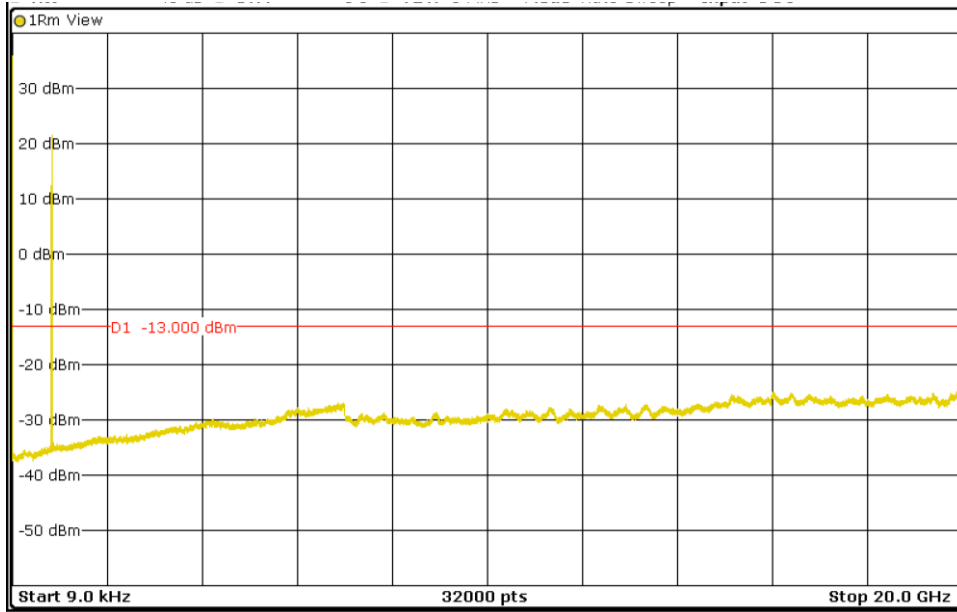

LTE QPSK MODULATION. BW = 3 MHz

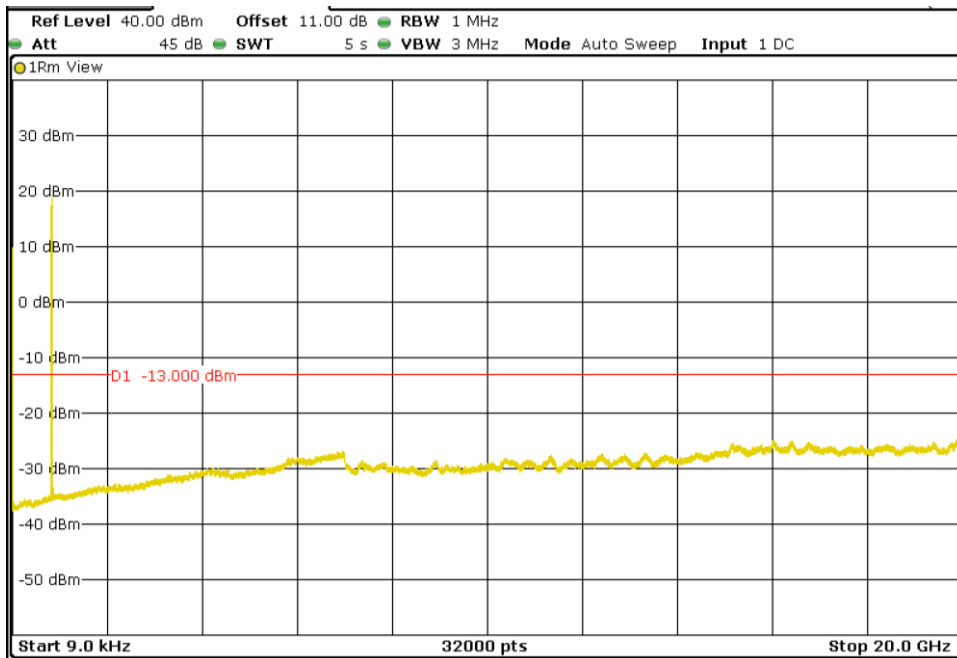

TEST RESULTS (Cont):

LTE QPSK MODULATION. BW = 5 MHz

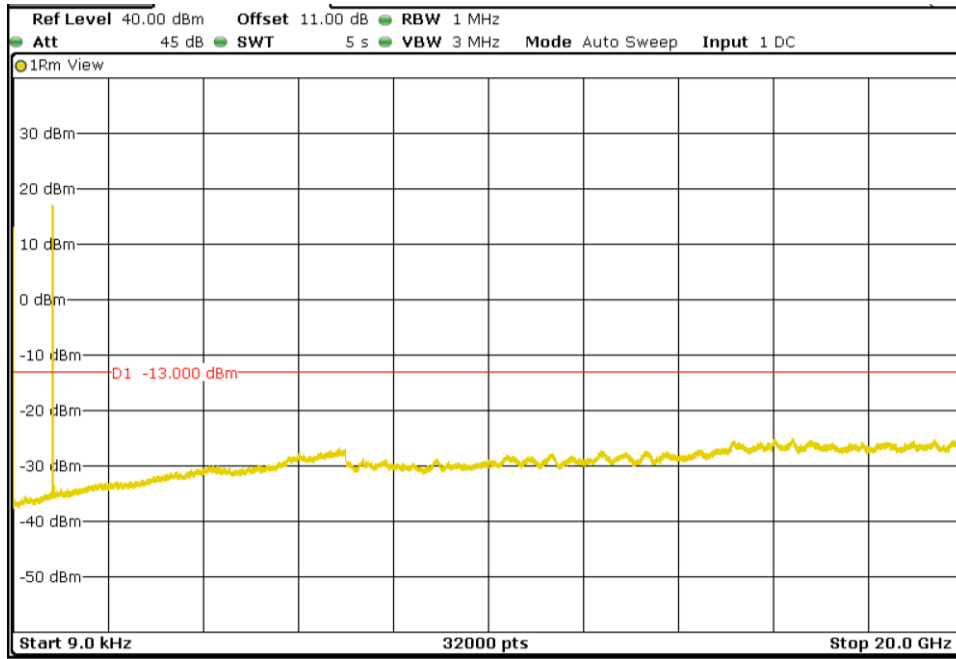

LTE QPSK MODULATION. BW = 10 MHz

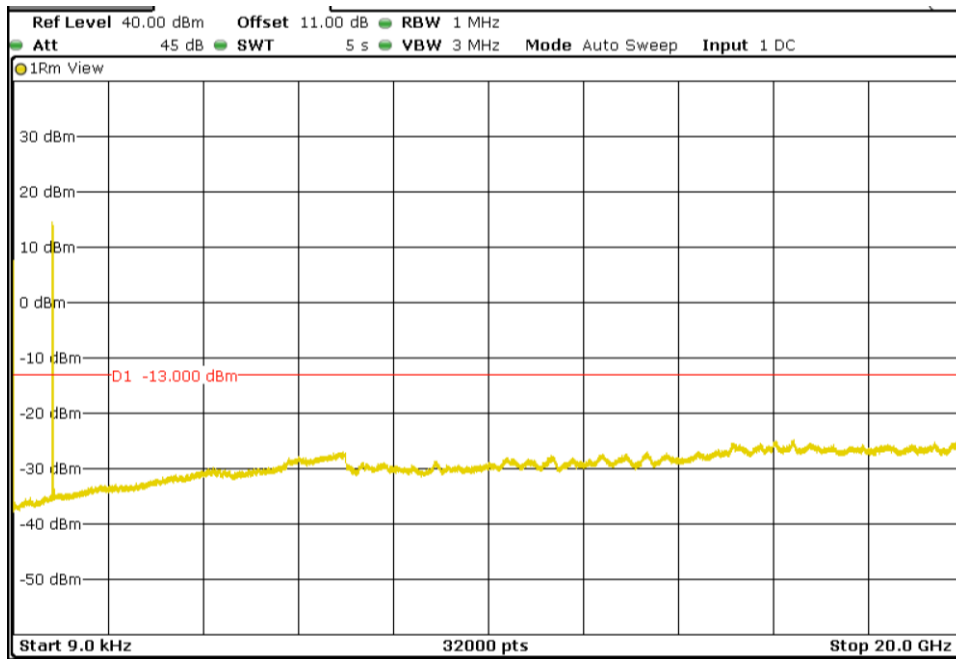

TEST RESULTS (Cont):

LTE QPSK MODULATION. BW = 15 MHz

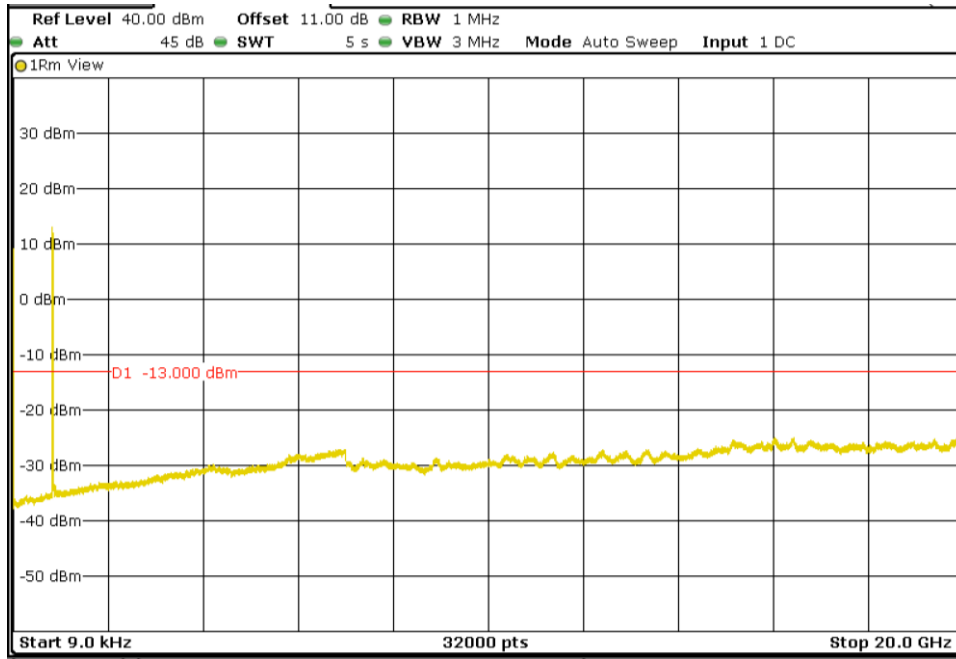

TEST A.6: SPURIOUS EMISSIONS AT ANTENNA TERMINALS AT BLOCK EDGES

LIMITS:	Product standard:	FCC Part 22 / IC RSS-132
	Test standard:	FCC §2.1051 and 22.917 / RSS- Clause 5.5.

LIMITS

According to specification, the power of emissions shall be attenuated below the transmitter power (P) by a factor of at least $43 + 10 \log (P)$ dB. P in watts.

At P_o transmitting power of 2 watts (33 dBm), the specified minimum attenuation becomes $43+10\log (P_o)$. and the level in dBm relative to P_o becomes:

$$P_o \text{ (dBm)} - [43 + 10 \log (P_o \text{ in watts})] = -13 \text{ dBm}$$

TEST SETUP

The EUT RF output connector was connected to a spectrum analyzer and to the Universal Radio Communication Tester R&S CMW500 (selecting maximum transmission power of the EUT and different modes of modulation) using a 50-ohm attenuator and a power splitter.

The reading of the spectrum analyzer is corrected with the attenuation loss of connection between output terminal of EUT and input of the spectrum analyzer.

For LTE mode the configuration of modulation which is the worst case for conducted power was used.

As indicated in FCC part 22, in the 1 MHz bands immediately outside and adjacent to the licensee's frequency block or band, a resolution bandwidth of at least one percent of the emission bandwidth of the fundamental emission of the transmitter may be employed.

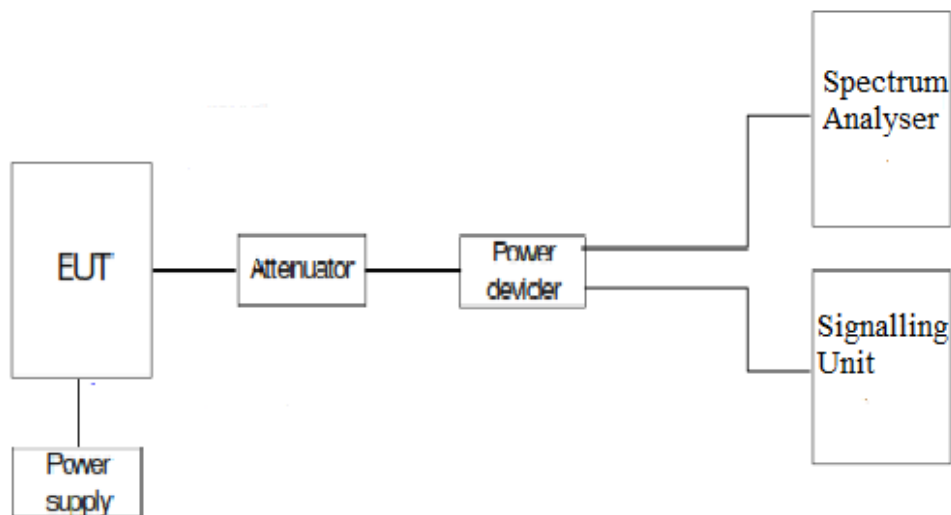

TESTED SAMPLES:	S/01
TESTED CONDITIONS MODES:	TC#01
TEST RESULTS:	PASS

LTE QPSK MODULATION	RB=1 Offset =0 BW = 1.4 MHz	RB=1 Offset =0 BW = 3 MHz	RB=1. Offset =0 BW = 5 MHz	RB=1 Offset =0 BW = 10 MHz	RB=1 Offset =0 BW = 15 MHz
Maximum measured level at lowest Block Edge at antenna port (dBm)	-23.17	-15.21	-25.06	-34.44	-29.58

LTE QPSK MODULATION	RB=6 Offset =0 BW = 1.4 MHz	RB=15 Offset =0 BW = 3 MHz	RB=25 Offset =0 BW = 5 MHz	RB=50 Offset =0 BW = 10 MHz	RB=1 Offset =0 BW = 10 MHz
Maximum measured level at lowest Block Edge at antenna port (dBm)	-23.54	-21.72	-24.81	-29.71	-29.43

LTE QPSK MODULATION	RB=1 Offset =5 BW = 1.4 MHz	RB=1 Offset =14 BW = 3 MHz	RB=1 Offset =24 BW = 5 MHz	RB=1 Offset =49 BW = 10 MHz	RB=1 Offset =0 BW = 10 MHz
Maximum measured level at Highest Block Edge at antenna port (dBm)	-28.26	-17.67	-23.62	-35.07	-30.42

LTE QPSK MODULATION	RB=6 Offset =0 BW = 1.4 MHz	RB=15 Offset =0 BW = 3 MHz	RB=25 Offset =0 BW = 5 MHz	RB=50 Offset =0 BW = 10 MHz	RB=1 Offset =0 BW = 10 MHz
Maximum measured level at Highest Block Edge at antenna port (dBm)	-29.64	-25.15	-29.43	-33.00	-30.56

TEST RESULTS (Cont):

LTE QPSK MODULATION. RB = 1. Offset = 0. BW = 1.4 MHz

Lowest Channel

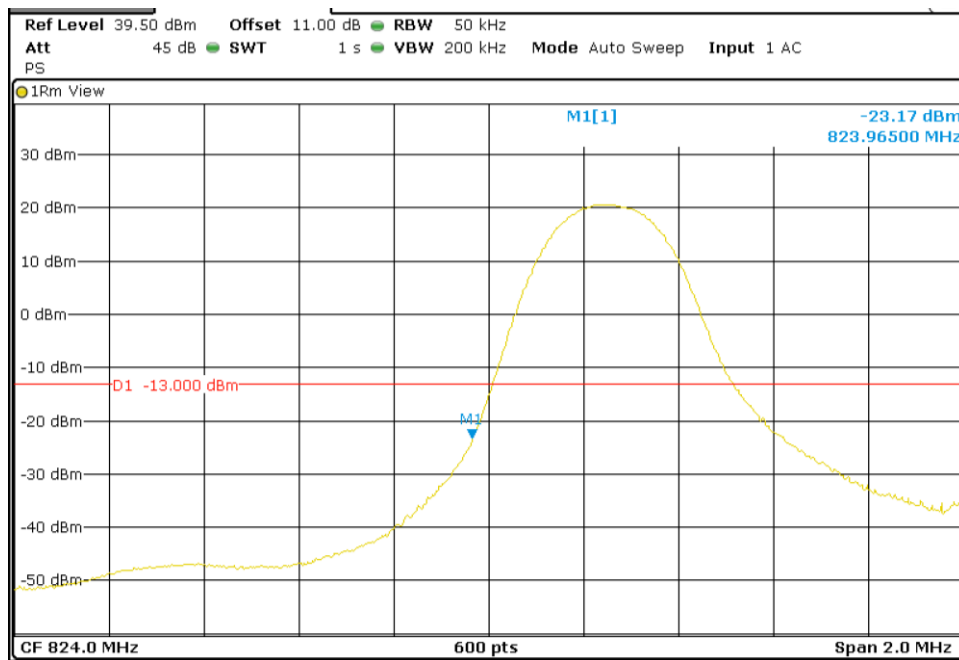

Highest Channel

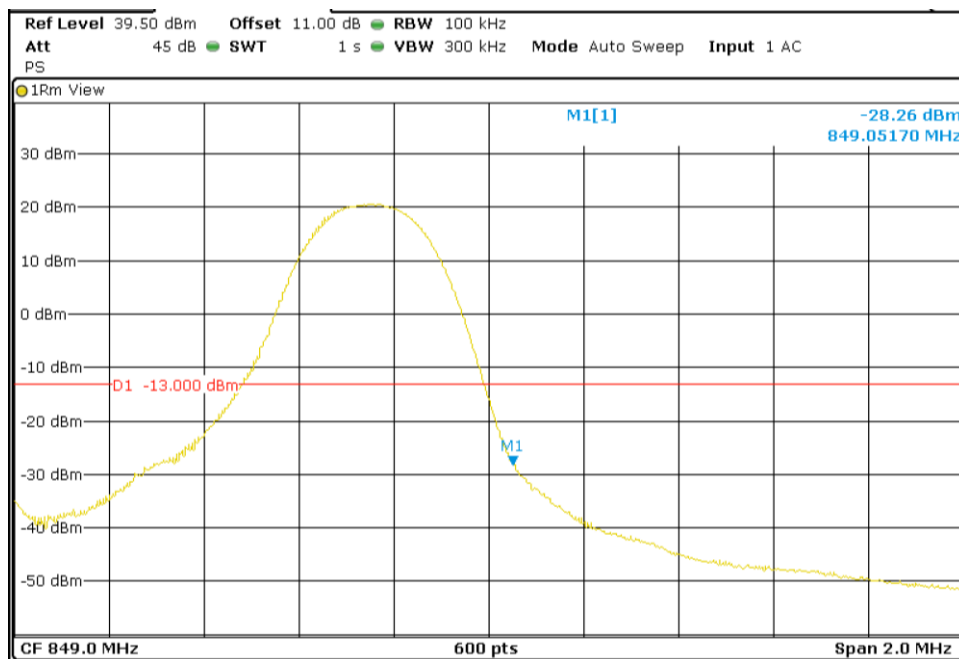

TEST RESULTS (Cont):

LTE QPSK MODULATION. RB = 6. Offset = 0. BW = 1.4 MHz

Lowest Channel

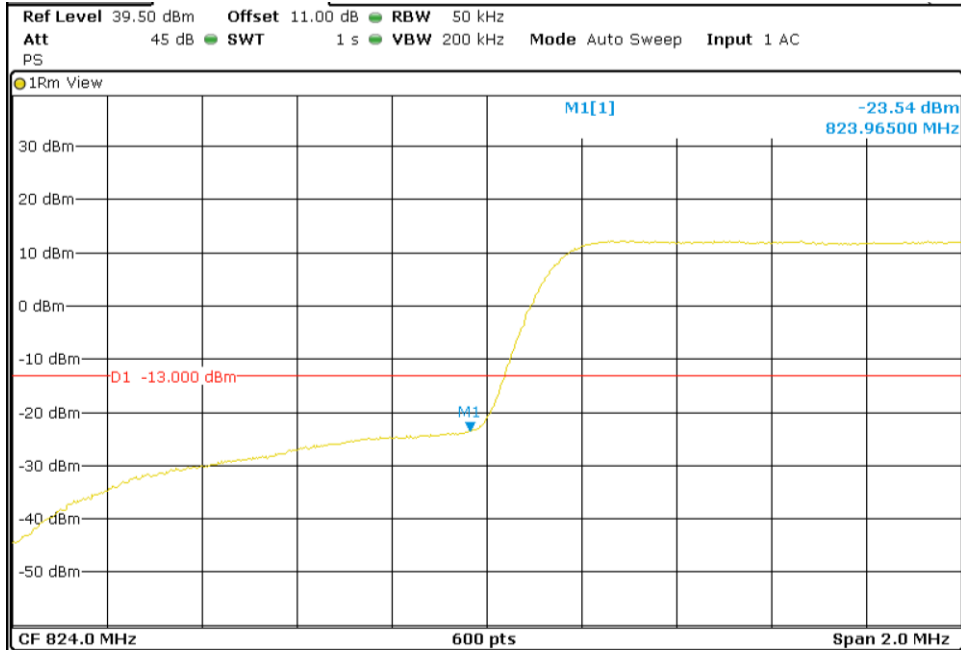

Highest Channel

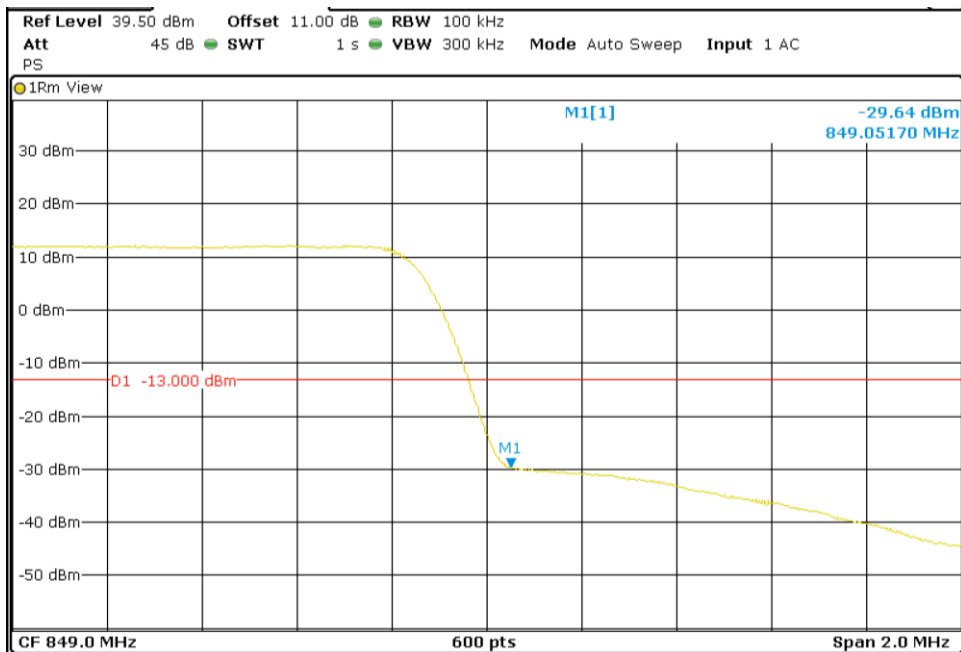

TEST RESULTS (Cont):

LTE QPSK MODULATION. RB = 1. Offset = 0. BW = 3 MHz

Lowest Channel

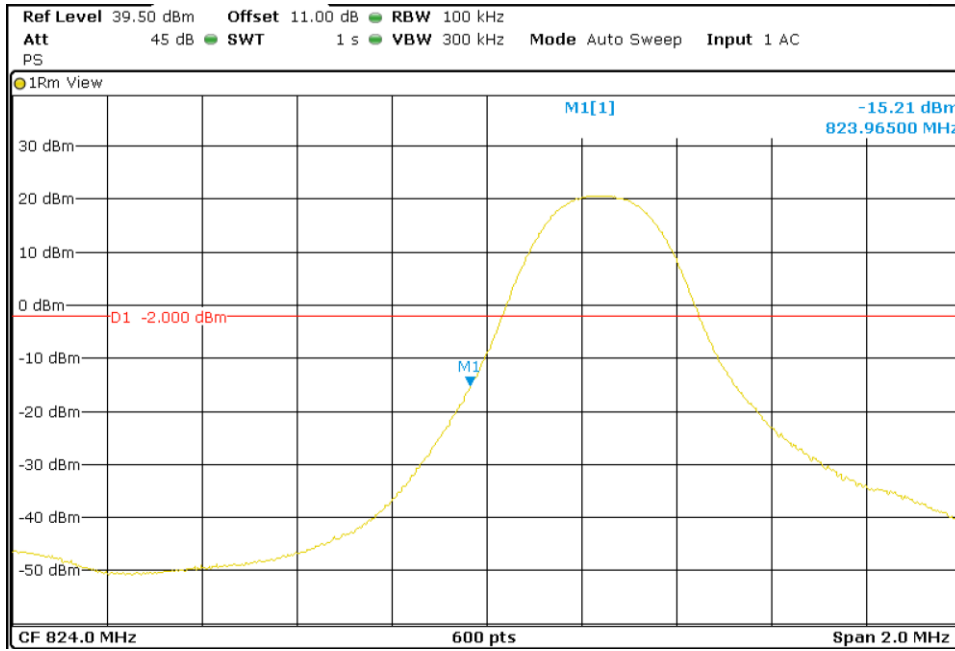

Highest Channel

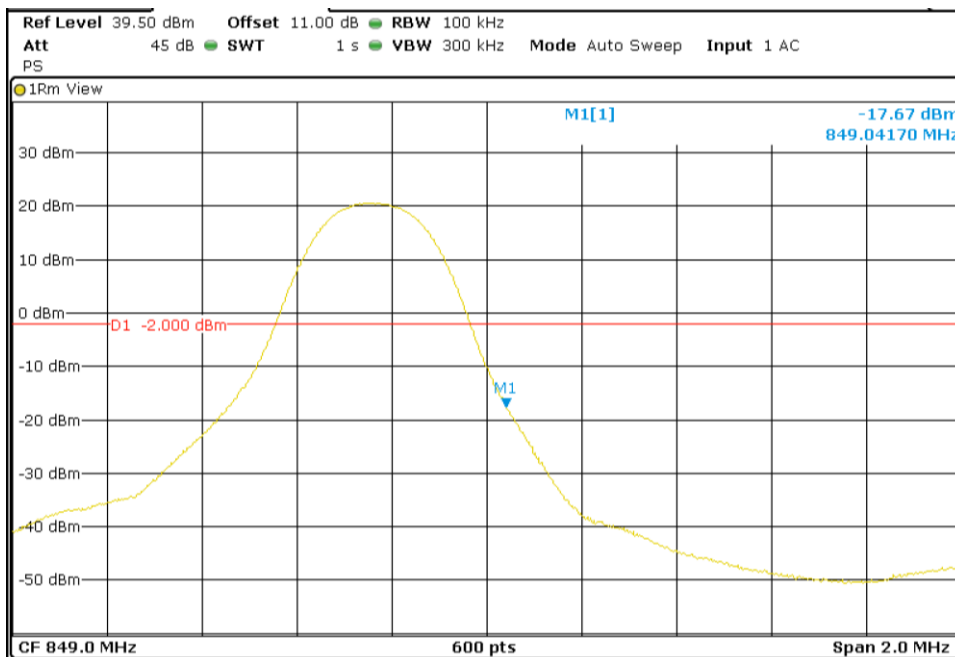

TEST RESULTS (Cont):

LTE QPSK MODULATION. RB = 15. Offset = 0. BW = 3 MHz

Lowest Channel

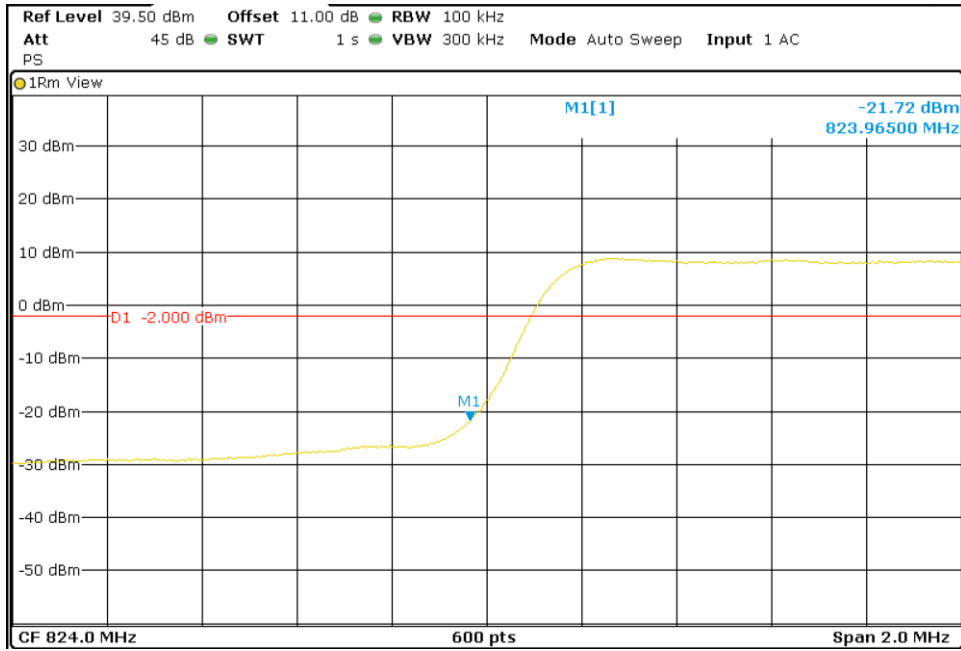

Highest Channel

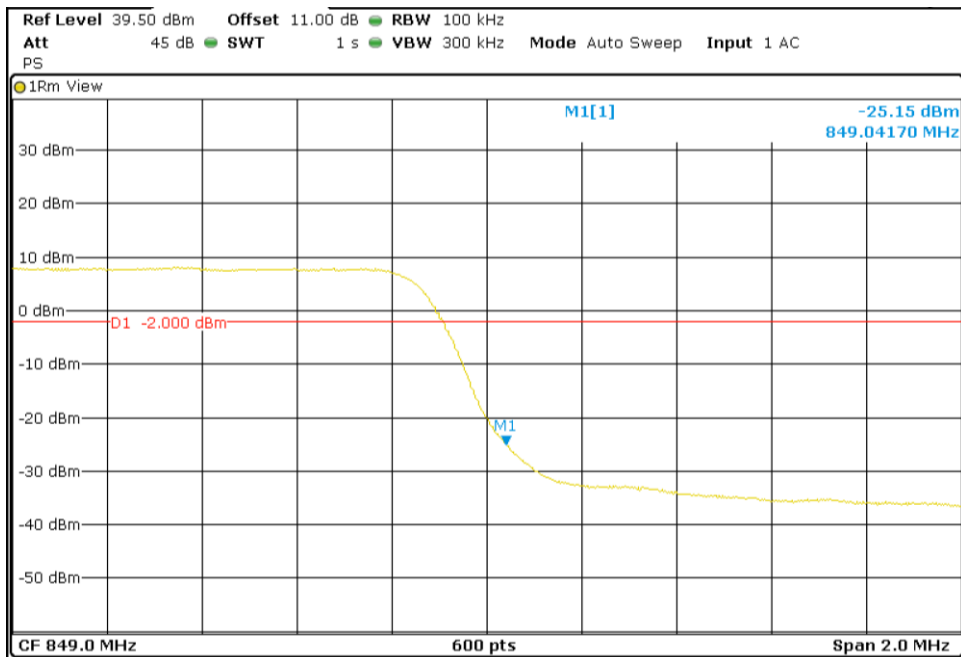

TEST RESULTS (Cont):

LTE QPSK MODULATION. RB = 1. Offset = 0. BW = 5 MHz

Lowest Channel

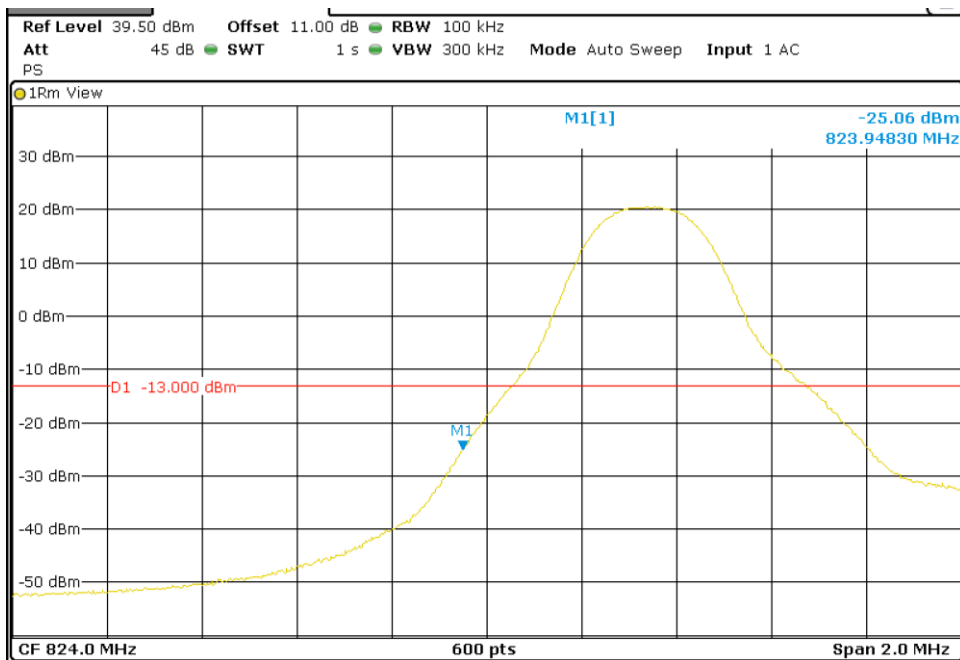

Highest Channel

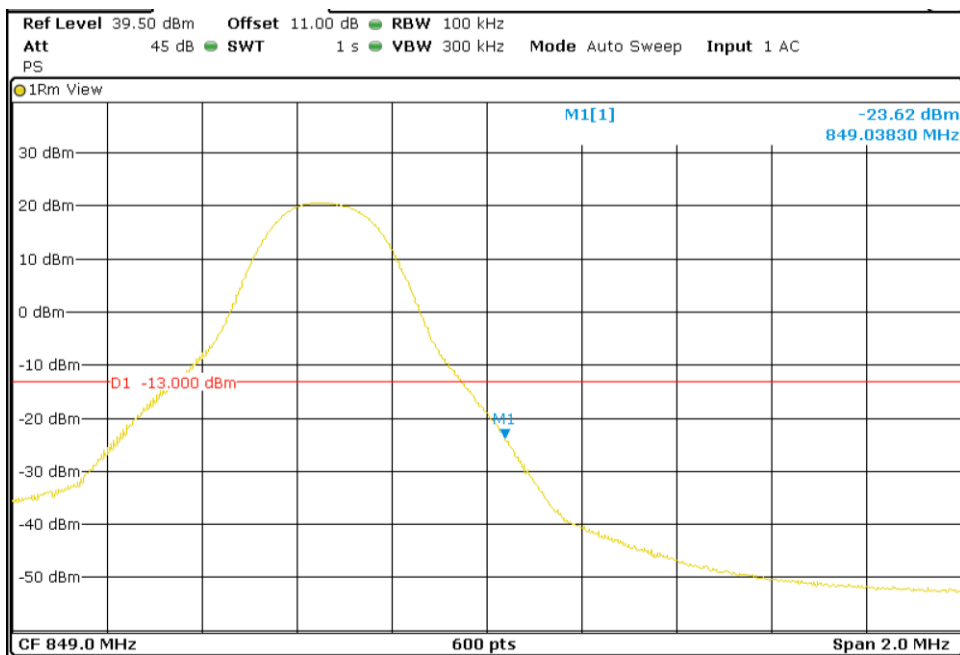

TEST RESULTS (Cont):

LTE QPSK MODULATION. RB = 25. Offset = 0. BW = 5 MHz

Lowest Channel

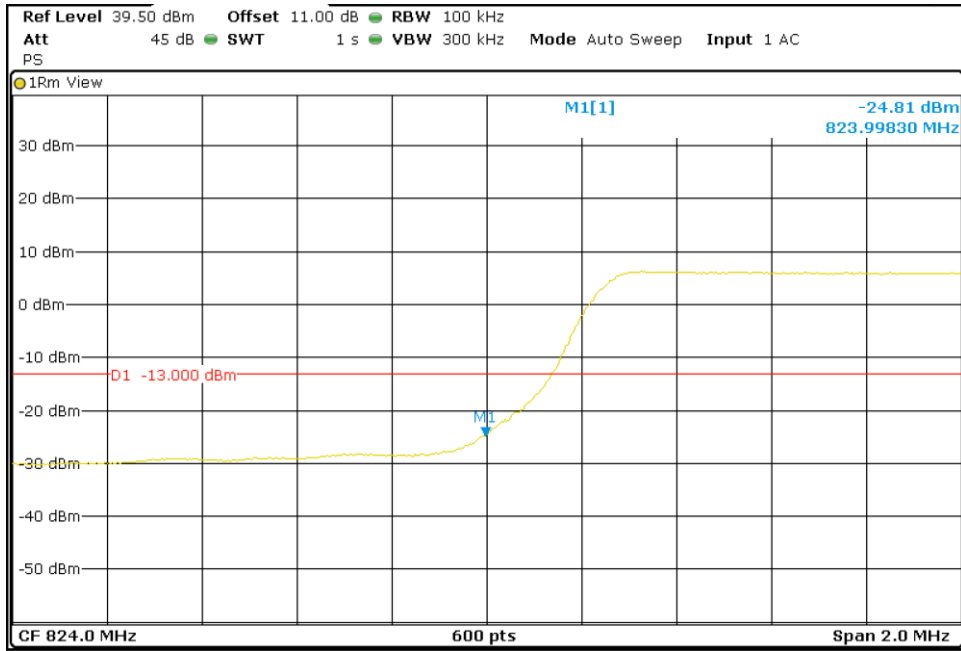

Highest Channel

