



FCC LISTED, REGISTRATION
 NUMBER: 2764.01

ISED LISTED REGISTRATION
 NUMBER: 23595-1

Test report No:

2456ERM.004A1

Test report

REFERENCE STANDARD:
 USA FCC Part 27
 CANADA ISED RSS-199

Identification of item tested	Wireless Module
Trademark	Cinterion ALAS5-W
Model and /or type reference	ALAS5-W
Other identification of the product	FCC ID: QIPALAS5-W IC: 7830A-ALAS5W
Features	Wireless Module supporting 2G, 3G and 4G Cellular Technologies
Manufacturer	Gemalto M2M GmbH Werinherstr. 81, 81541 Munich, Germany.
Test method requested, standard	USA FCC Part 27 10-1-18 Edition CANADA IC RSS-199 Issue 3, Dec. 2016. Measurement Guidance 971168 D01 v02r02 for certification of Licensed Digital Transmitters. ANSI C63.26 – 2015.
Summary	IN COMPLIANCE
Approved by (name / position & signature)	Domingo Galvez EMC&RF Lab Manager
Date of issue	04-10-2019
Report template No	FDT08_21

Index

Competences and guarantees	3
General conditions	3
Uncertainty	3
Data provided by the client.....	4
Usage of samples	4
Test sample description	5
Identification of the client.....	6
Testing period and place.....	6
Document history	6
Environmental conditions	7
Remarks and comments	8
Testing verdicts.....	8
Summary	8
List of equipment used during the test.....	9
Appendix A: Test Results for FCC Part 27/ IC RSS-199	10

Competences and guarantees

DEKRA Certification Inc. is a testing laboratory accredited by A2LA (The American Association for Laboratory Accreditation), to perform the tests indicated in the Certificate 2764.01.

DEKRA Certification Inc. is a testing laboratory competent to carry out the tests described in this report.

To assure the traceability to other national and international laboratories, DEKRA Certification Inc. has a calibration and maintenance program for its measurement equipment.

DEKRA Certification Inc. guarantees the reliability of the data presented in this report, which is the result of the measurements and the tests performed to the item under test on the date and under the conditions stated on the report and, it is based on the knowledge and technical facilities available at DEKRA Certification at the time of performance of the test.

DEKRA Certification Inc. is liable to the client for the maintenance of the confidentiality of all information related to the item under test and the results of the test.

The results presented in this Test Report apply only to the item under test established in this document.

IMPORTANT: No parts of this report may be reproduced or quoted out of context, in any form or by any means, except in full, without the previous written permission of DEKRA Certification Inc.

General conditions

1. This report is only referred to the item that has undergone the test.
2. This report does not constitute or imply on its own an approval of the product by the Certification Bodies or competent Authorities.
3. This document is only valid if complete; no partial reproduction can be made without previous written permission of DEKRA Certification Inc.
4. This test report cannot be used partially or in full for publicity and/or promotional purposes without previous written permission of DEKRA Certification Inc. and the Accreditation Bodies.

Uncertainty

Uncertainty (factor $k=2$) was calculated according to the DEKRA Certification internal document PODT000.

Frequency (MHz)	U(k=2)	Units
30-180	3.82	dB
180-1000	2.61	dB
1000-18000	2.92	dB
18000-40000	2.15	dB

Data provided by the client

Wireless Module supporting 2G, 3G and 4G Cellular Technologies.

DEKRA declines any responsibility with respect to the information provided by the client and that may affect the validity of results.

Usage of samples

Samples undergoing test have been selected by: The client.

Sample S/01 is composed of the following elements:

Control N°	Description	Model	Serial N°	Date of reception
2456.03	Cinterion® ALAS5	ALAS5-W	004401083195152	2/7/2019
2456.04	GPS Antenna	AA62	162CT15170382	2/7/2019
2456.05	Antenna	Panorama_LPBEM-7-27-	-	2/7/2019
2456.06	Antenna	Panorama_LPBEM-7-27--	-	2/7/2019

1. Sample S/01 was used for the following test(s):
All conducted and radiated tests indicated in appendix A.

Test sample description

Ports..... :	Port name and description		Cable				
			Specified length [m]	Attached during test		Shielded	
	No Data Provided			<input type="checkbox"/>		<input type="checkbox"/>	
				<input type="checkbox"/>		<input type="checkbox"/>	
				<input type="checkbox"/>		<input type="checkbox"/>	
				<input type="checkbox"/>		<input type="checkbox"/>	
Supplementary information to the ports..... :	No Data Provided						
Rated power supply	Voltage and Frequency		Reference poles				
			L1	L2	L3	N	PE
	<input type="checkbox"/>	AC: 230Vac / 50Hz.	<input type="checkbox"/>	<input type="checkbox"/>	<input type="checkbox"/>	<input type="checkbox"/>	<input type="checkbox"/>
	<input type="checkbox"/>	AC:	<input type="checkbox"/>	<input type="checkbox"/>	<input type="checkbox"/>	<input type="checkbox"/>	<input type="checkbox"/>
	<input checked="" type="checkbox"/>	DC:3.3 to 4.2V					
<input checked="" type="checkbox"/>	DC: 3.8V						
Rated Power	No Data Provided						
Clock frequencies	No Data Provided						
Other parameters.....	No Data Provided						
Software version	Rev. 00.030						
Hardware version.....	Rev2.14a						
Dimensions in cm (L x W x D)	40mm x 36mm x 3mm						
Mounting position..... :	<input type="checkbox"/>	Table top equipment					
	<input type="checkbox"/>	Wall/Ceiling mounted equipment					
	<input type="checkbox"/>	Floor standing equipment					
	<input type="checkbox"/>	Hand-held equipment					
	<input type="checkbox"/>	Other:					
Modules/parts	Module/parts of test item		Type		Manufacturer		
	No Data provided						

Accessories (not part of the test item)	Description	Type	Manufacturer
Documents as provided by the applicant.....	Description	File name	Issue date
	Equipment declaration data	FDT30_15_Declaration_Equipment_Data_Gemalto_ALAS5-W_signed	2019-03-14

Copy of marking plate:



Identification of the client

Gemalto M2M GmbH
 Werinherstr. 81, 81541 Munich, Germany

Testing period and place

Test Location	DEKRA Certification, Inc.
Date (start)	02-13-2019
Date (finish)	04-09-2019

Document history

Report number	Date	Description
2456ERM.004	03-18-2019	First release
2456ERM.004A1	04-10-2019	Second release

Modifications to the reference test report

It was introduced the following modifications in respect to the test report number 2456ERM.004 related with the samples, in the next clauses and sub-clauses:

Clauses/ Sub-Clauses	Modification	Justification
Page:38-62/A.4: Occupied Bandwidth	Occupied Bandwidth and -26db Bandwidth plots were modified	The plots were updated with new Resolution bandwidth values.

This modification test report cancels and replaces the test reports 2456ERM.004.

Environmental conditions

In the control chamber, the following limits were not exceeded during the test:

Temperature	Min. = 15 °C Max. = 35 °C
Relative humidity	Min. = 30 % Max. = 75 %
Air pressure	Min. = 860 mbar Max. = 1060 mbar

In the semi anechoic chamber, the following limits were not exceeded during the test.

Temperature	Min. = 15 °C Max. = 35 °C
Relative humidity	Min. = 30 % Max. = 75 %
Air pressure	Min. = 860 mbar Max. = 1060 mbar

In the chamber for conducted measurements, the following limits were not exceeded during the test:

Temperature	Min. = 15 °C Max. = 35 °C
Relative humidity	Min. = 30 % Max. = 60 %
Air pressure	Min. = 860 mbar Max. = 1060 mbar

Remarks and comments

The tests have been performed by the technical personnel: Sravani Gollamudi and Koji Nishimoto.

Testing verdicts

Not applicable :	N/A
Pass :	P
Fail :	F
Not measured :	N/M

Summary

FCC PART 27 /IC RSS-199 PARAGRAPH					
Report Section	FCC Spec Clause	RSS Spec Clause	Test Description	Verdict	Remark
A.1	§2.1046 and §27.50	RSS-199 Clause 4.4	RF Output power	P	N/A
A.2	§2.1047 and §27.50	RSS-199 Clause 4.1	Modulation characteristics	P	N/A
A.3	§2.1055 and §27.54	RSS-199 Clause 4.3	Frequency stability	P	N/A
A.4	§ 2.1049	RSS-199 Clause 4.2	Occupied Bandwidth	P	N/A
A.5	§2.1051 and §27.53	RSS-199 Clause 4.5	Spurious emissions at antenna terminals	P	N/A
A.6	§27.53	RSS-199 Clause 4.5	Spurious emissions at antenna terminals at Block edges	P	N/A
A.7	§2.1053 and §27.53	RSS-199 Clause 4.5	Radiated emissions	P	N/A
<u>Supplementary information and remarks:</u>					
N/A					

List of equipment used during the test

Conducted Measurements

CONTROL NUMBER	DESCRIPTION	LAST CALIBRATION	NEXT CALIBRATION
1014	Signal analyzer Rohde & Schwarz FSV40	2017/03	2019/03
1149	Wideband Radio Communication Tester Rohde & Schwarz CMW 500	2018/07	2020/07
1041	EMI Test Receiver Rohde & Schwarz ESR 7	2017/04	2019/03
101	Climatic chamber Espec	2019/10	2020/10

Radiated Measurements

CONTROL NUMBER	DESCRIPTION	LAST CALIBRATION	NEXT CALIBRATION
1179	Semi anechoic Absorber Lined Chamber Frankonia SAC 3 plus "L"	N/A	N/A
1064	BiconicalLog antenna ETS LINDGREN 3142E	2017/03	2020/03
1057	Double-ridge Waveguide Horn antenna 1-18 GHz	2017/03	2020/03
1056	Double-ridge Waveguide Horn antenna 18- 40 GHz	2016/12	2019/12
1012	Spectrum analyzer Rohde & Schwarz ESR26	2018/09	2020/09
1014	Spectrum analyzer Rohde & Schwarz FSV40	2017/03	2019/03
1015,1017, 1019, 1020	Rohde & Schwarz EMC32 software	N/A	N/A

Appendix A: Test Results for FCC Part 27/ IC RSS-199

Appendix A Content

PRODUCT INFORMATION	12
DESCRIPTION OF TEST CONDITIONS	13
TEST A.1: RF OUTPUT POWER.....	14
TEST A.2: MODULATION CHARACTERISTICS	32
TEST A.3: FREQUENCY STABILITY	34
TEST A.4: OCCUPIED BANDWIDTH	36
TEST A.5: SPURIOUS EMISSIONS AT ANTENNA TERMINALS.....	63
TEST A.6: SPURIOUS EMISSIONS AT ANTENNA TERMINALS AT BLOCK EDGES.....	71
TEST A.7: RADIATED EMISSIONS.....	81

PRODUCT INFORMATION

The following information is provided by the client

Information	Description
Modulation	QPSK, QAM
Maximum RF Output Power	23 dBm
Operation mode:	
- Operating Frequency Range	LTE Band 38: 2570-2615 MHz
- Nominal Channel Bandwidth	LTE Band 38: 5/ 10/ 15/ 20 MHz
Extreme operating conditions	
- Temperature range	T _{nom} = +15 to + 35 T _{min} = -30 T _{max} = +50
Antenna type	External attachable Antenna.
Antenna gain	5 dBi
Nominal Voltage	
- Supply Voltage	3.8 Vdc
- Type of power source	DC voltage from power supply.

DESCRIPTION OF TEST CONDITIONS

The worst case was found when positioned as the table below. Following channel(s) was (were) selected for the final test as listed below:

TEST CONDITIONS	DESCRIPTION												
<p>TC#01 LTE Band 38</p>	<p><u>Power supply (V):</u> $V_{nominal} = 3.8 \text{ Vdc}$</p> <p><u>Test Frequencies for Conducted tests:</u> <u>5 MHz Bandwidth:</u> -Lowest Channel: 37775(2572.5 MHz) -Middle Channel: 38000(2595 MHz) -Highest Channel: 38225(2617.5 MHz) <u>10 MHz Bandwidth:</u> -Lowest Channel: 37800(2575 MHz) -Middle Channel: 38000(2595 MHz) -Highest Channel: 38200(2615 MHz) <u>15 MHz Bandwidth:</u> -Lowest Channel: 37825(2577.5 MHz) -Middle Channel: 38000(2595 MHz) -Highest Channel: 38175(2612.5 MHz) <u>20 MHz Bandwidth:</u> -Lowest Channel: 37850(2580 MHz) -Middle Channel: 38000(2595 MHz) -Highest Channel: 38150(2610 MHz)</p> <p><u>Test Frequencies for Radiated tests:</u></p> <table border="1" data-bbox="451 1514 1308 1780"> <thead> <tr> <th>Available Frequencies</th> <th>Tested Frequency</th> <th>Channel Bandwidth</th> <th>Modulation</th> <th>Mode</th> </tr> </thead> <tbody> <tr> <td rowspan="3">2570 to 2610 MHz</td> <td>2580 MHz</td> <td rowspan="3">20 MHz</td> <td rowspan="3">QPSK</td> <td rowspan="3">1 RB</td> </tr> <tr> <td>2595 MHz</td> </tr> <tr> <td>2610 MHz</td> </tr> </tbody> </table> <p>Note: This device was tested under all bandwidths, RB configurations and modulations. The worst case found in QPSK modulation.</p>	Available Frequencies	Tested Frequency	Channel Bandwidth	Modulation	Mode	2570 to 2610 MHz	2580 MHz	20 MHz	QPSK	1 RB	2595 MHz	2610 MHz
Available Frequencies	Tested Frequency	Channel Bandwidth	Modulation	Mode									
2570 to 2610 MHz	2580 MHz	20 MHz	QPSK	1 RB									
	2595 MHz												
	2610 MHz												

TEST A.1: RF OUTPUT POWER

LIMITS:	Product standard:	FCC Part 27 / IC RSS-199
	Test standard:	FCC §2.1046 and §27.50 / RSS-199 Clause 4.4

LIMITS

Fixed, mobile, and portable (hand-held) stations operating in the band are limited to 1-watt EIRP (30 dBm). Fixed stations operating in the band are limited to a maximum antenna height of 10 meters above ground. Mobile and portable stations operating in these bands must employ a means for limiting power to the minimum necessary for successful communications.

The peak-to-average ratio (PAR) of the transmission shall not exceed 13 dB.

RSS-199 Clause 6.5

The equivalent isotropically radiated power (e.i.r.p.) for mobile and portable transmitters shall not exceed two watts.

The peak-to-average power ratio (PAPR) of the transmission shall not exceed 13 dB.

TEST SETUP

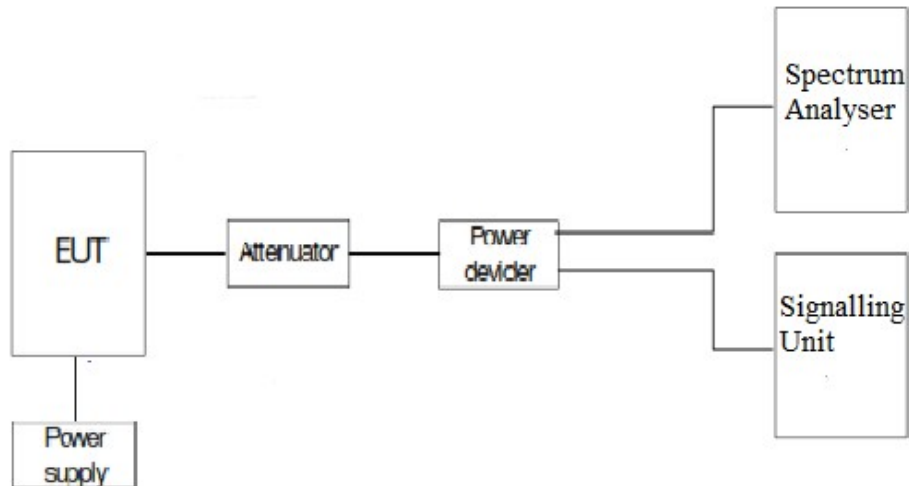

TESTED SAMPLES:	S/01
TESTED CONDITIONS MODES:	TC#01
TEST RESULTS:	PASS

LTE QPSK AND 16QAM MODULATION. Bandwidth = 5 MHz

Channel	Average power at antenna port (dBm)	Maximum declared antenna gain (dBi)	Maximum E.I.R.P. average power (dBm)	PAPR (dB)
Lowest	22.64	5.0	27.64	8.7
Middle	22.52	5.0	27.52	11.39
Highest	22.49	5.0	27.49	9.83
Measurement uncertainty (dB)			<±0.95	

LTE QPSK AND 16QAM MODULATION. Bandwidth = 10 MHz

Channel	Average power at antenna port (dBm)	Maximum declared antenna gain (dBi)	Maximum E.I.R.P. average power (dBm)	PAPR (dB)
Lowest	22.6	5.0	27.60	10.14
Middle	22.62	5.0	27.62	10.67
Highest	22.49	5.0	27.49	9.1
Measurement uncertainty (dB)			<±0.95	

LTE QPSK AND 16QAM MODULATION. Bandwidth = 15 MHz

Channel	Average power at antenna port (dBm)	Maximum declared antenna gain (dBi)	Maximum E.I.R.P. average power (dBm)	PAPR (dB)
Lowest	22.62	5.0	27.62	8.43
Middle	22.71	5.0	27.71	8.87
Highest	22.61	5.0	27.61	9.45
Measurement uncertainty (dB)			<±0.95	

LTE QPSK AND 16QAM MODULATION. Bandwidth = 20 MHz

Channel	Average power at antenna port (dBm)	Maximum declared antenna gain (dBi)	Maximum E.I.R.P. average power (dBm)	PAPR (dB)
Lowest	22.67	5.0	27.67	9.01
Middle	22.79	5.0	27.79	10.84
Highest	22.7	5.0	27.7	8.29
Measurement uncertainty (dB)			<±0.95	

Test Results(Cont.)						
BANDWIDTH (MHz)	CHANNEL FREQUENCY (MHz)	MODULATION	RB SIZE	RB OFFSET	AVERAGE POWER (dBm)	PAPR (dB)
5	Low (37775) 2572.5MHz	QPSK	1	0	22.62	8.7
			1	12	22.57	
			1	24	22.64	
			12	0	21.55	
			12	6	21.56	
			12	11	21.55	
		16-QAM	25	0	21.6	8.55
			1	0	21.91	
			1	12	21.9	
			1	24	21.92	
			12	0	20.63	
			12	6	20.64	
	Middle (38000) 2595 MHz	QPSK	12	11	20.56	9.68
			25	0	20.56	
			1	0	22.52	
			1	12	22.46	
			1	24	22.43	
			12	0	21.65	
		16-QAM	12	6	21.6	11.39
			12	11	21.61	
			25	0	21.63	
			1	0	22.01	
			1	12	21.94	
			1	24	21.91	
High (38225) 2617.5 MHz	QPSK	12	0	20.78	9.83	
		12	6	20.74		
		12	11	20.69		
		25	0	20.64		
		1	0	22.49		
		1	12	22.46		
	16-QAM	1	24	22.41	8.75	
		12	0	21.46		
		12	6	21.46		
		12	11	21.44		
		25	0	21.46		
		1	0	21.95		
1	12	21.88				
1	24	21.82				
12	0	20.55				
12	6	20.58				
12	11	20.54				
25	0	20.49				

TEST RESULTS (Cont):						
BANDWIDTH (MHz)	CHANNEL FREQUENCY (MHz)	MODULATION	RB SIZE	RB OFFSET	AVERAGE POWER (dBm)	PAPR (dB)
10	Low (37800) 2575 MHz	QPSK	1	0	22.6	10.14
			1	24	22.6	
			1	49	22.52	
			25	0	21.64	
			25	12	21.65	
			25	24	21.6	
		50	0	21.65		
		16-QAM	1	0	21.71	7.59
			1	24	21.71	
			1	49	21.65	
			25	0	20.66	
			25	12	20.74	
	25		24	20.63		
	Middle 38000 2595	QPSK	1	0	22.62	10.67
			1	24	22.58	
			1	49	22.56	
			25	0	21.69	
			25	12	21.67	
			25	24	21.57	
		50	0	21.66		
		16-QAM	1	0	21.72	10.61
			1	24	21.67	
			1	49	21.61	
			25	0	20.61	
25			12	20.64		
25	24		20.53			
High 38200 2615	QPSK	1	0	22.49	8.87	
		1	24	22.42		
		1	49	22.35		
		25	0	21.51		
		25	12	21.47		
		25	24	21.41		
	50	0	21.46			
	16-QAM	1	0	21.74	9.1	
		1	24	21.6		
		1	49	21.59		
		25	0	20.42		
		25	12	20.44		
25		24	20.38			
50	0	20.47				

TEST RESULTS (Cont):						
BANDWIDTH (MHz)	CHANNEL FREQUENCY (MHz)	MODULATION	RB SIZE	RB OFFSET	AVERAGE POWER (dBm)	PAPR (dB)
15	Low 37825 2577.5	QPSK	1	0	22.62	8.43
			1	37	22.53	
			1	74	22.57	
			36	0	21.62	
			36	18	21.66	
			36	37	21.55	
		75	0	21.63		
		16-QAM	1	0	21.72	7.57
			1	37	21.64	
			1	74	21.68	
			36	0	20.62	
			36	18	20.65	
	36		37	20.55		
	Middle 38000 2595	QPSK	1	0	22.71	8.87
			1	37	22.55	
			1	74	22.51	
			36	0	21.72	
			36	18	21.65	
			36	37	21.57	
		75	0	21.61		
		16-QAM	1	0	21.8	7.54
			1	37	21.69	
			1	74	21.62	
			36	0	20.72	
36			18	20.68		
36	37		20.6			
High 38175 2612.5	QPSK	1	0	22.61	9.25	
		1	37	22.51		
		1	74	22.45		
		36	0	21.62		
		36	18	21.52		
		36	37	21.45		
	75	0	21.47			
	16-QAM	1	0	22.14	9.45	
		1	37	22		
		1	74	21.98		
		36	0	20.58		
		36	18	20.5		
36		37	20.45			
75	0	20.53				

TEST RESULTS (Cont):						
BANDWIDTH (MHz)	CHANNEL FREQUENCY (MHz)	MODULATION	RB SIZE	RB OFFSET	AVERAGE POWER (dBm)	PAPR (dB)
20	Low 37850 2580	QPSK	1	0	22.67	9.01
			1	49	22.57	
			1	99	22.59	
			50	0	21.68	
			50	24	21.6	
			50	49	21.66	
		100	0	21.61		
		16-QAM	1	0	22.03	7.1
			1	49	21.88	
			1	99	21.91	
			50	0	20.72	
			50	24	20.67	
	50		49	20.68		
	Middle 38000 2595	QPSK	1	0	22.79	10.84
			1	49	22.65	
			1	99	22.55	
			50	0	21.62	
			50	24	21.69	
			50	49	21.56	
		100	0	21.68		
		16-QAM	1	0	21.9	9.97
			1	49	21.7	
			1	99	21.66	
			50	0	20.61	
50			24	20.66		
50	49		20.55			
High 38150 2610	QPSK	1	0	22.7	8.29	
		1	49	22.54		
		1	99	22.44		
		50	0	21.57		
		50	24	21.58		
		50	49	21.49		
	100	0	21.58			
	16-QAM	1	0	21.74	7.88	
		1	49	21.6		
		1	99	21.52		
		50	0	20.6		
		50	24	20.61		
50		49	20.52			
100	0	20.57				

TEST RESULTS (Cont):

PAPR
 Bandwidth = 5 MHz. Modulation QPSK. RB Size: 1. RB Offset: 0.
 Lowest channel

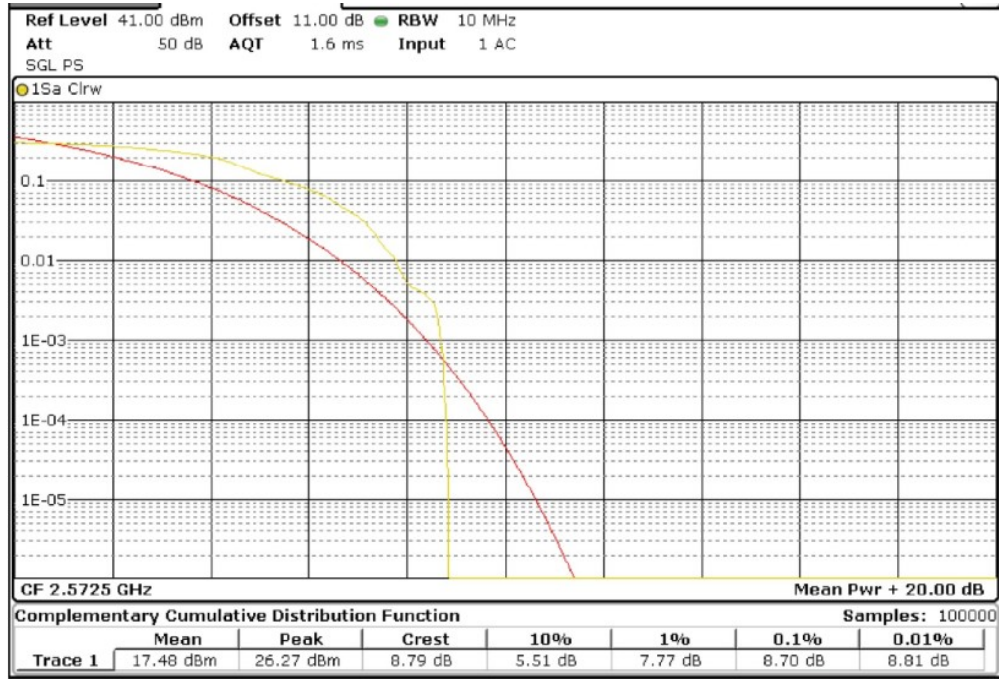

Middle channel

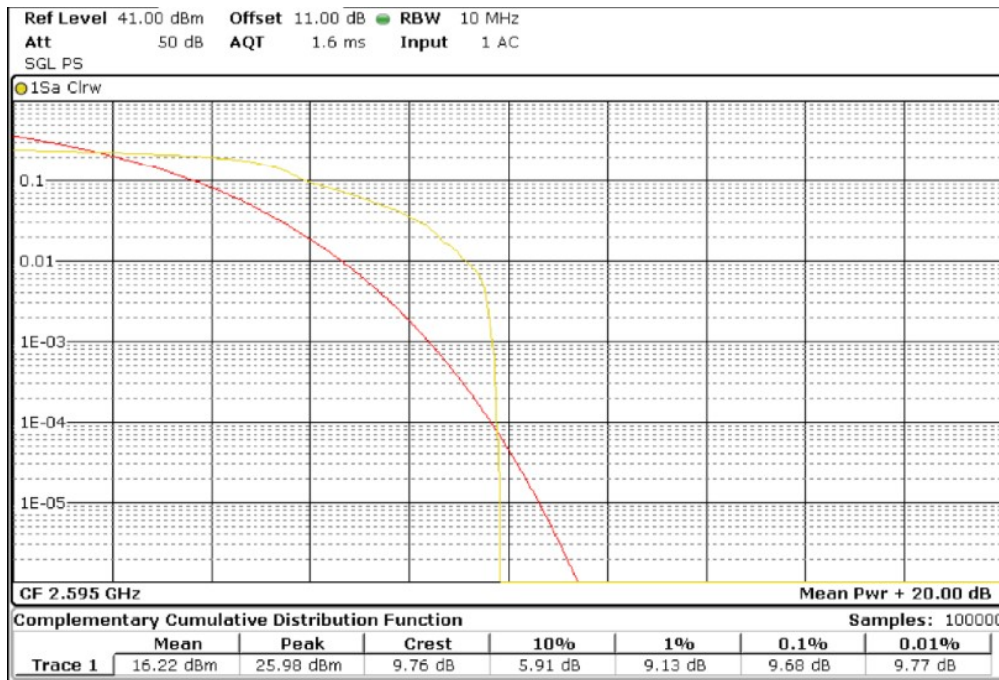

TEST RESULTS (Cont):

Highest channel

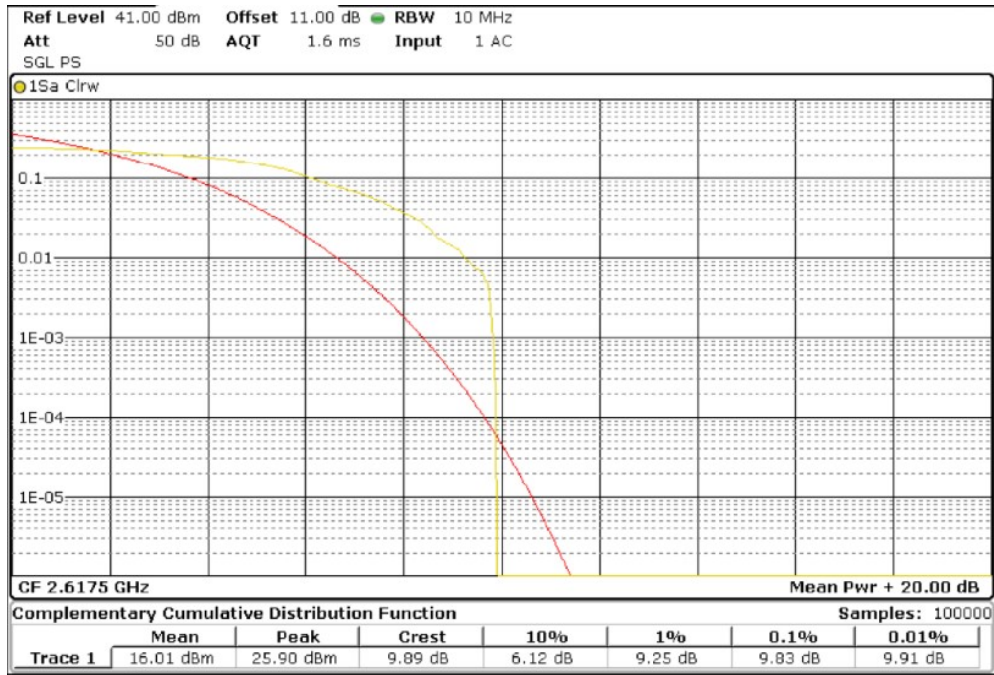

PAPR

Bandwidth = 5 MHz. Modulation 16QAM. RB Size: 1. RB Offset: 0.

Lowest channel

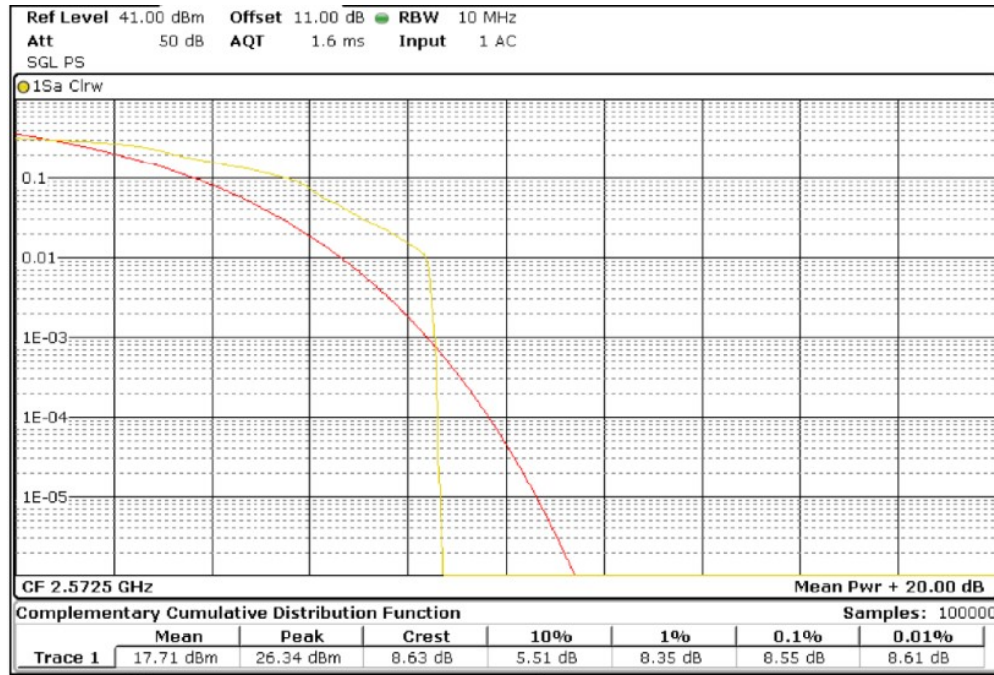

TEST RESULTS (Cont):

Middle channel

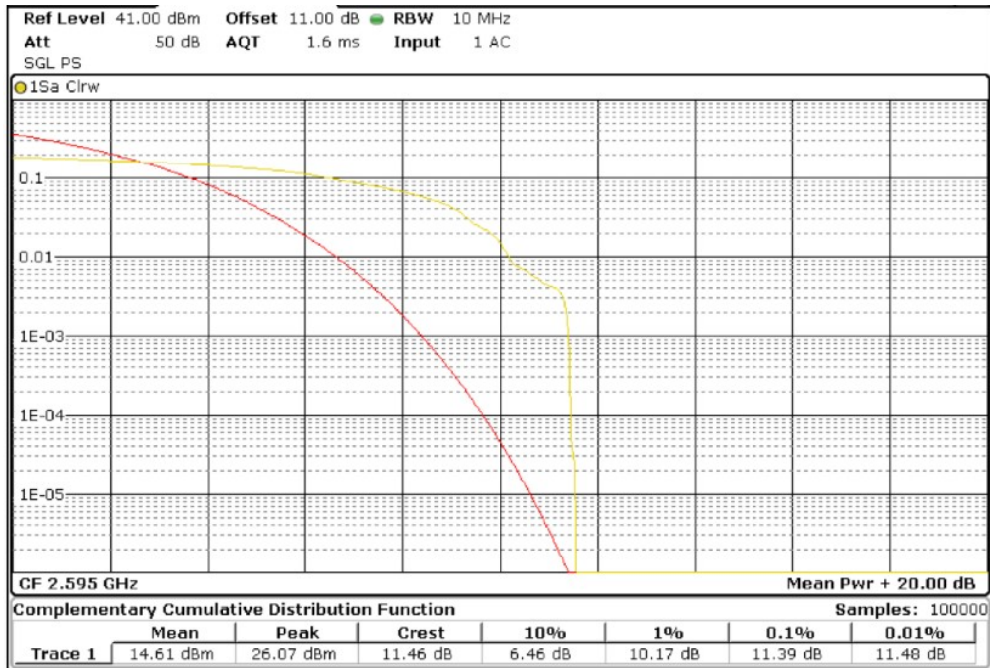

Highest channel



TEST RESULTS (Cont):

PAPR
 Bandwidth = 10 MHz. Modulation QPSK. RB Size: 1. RB Offset: 0.
 Lowest channel

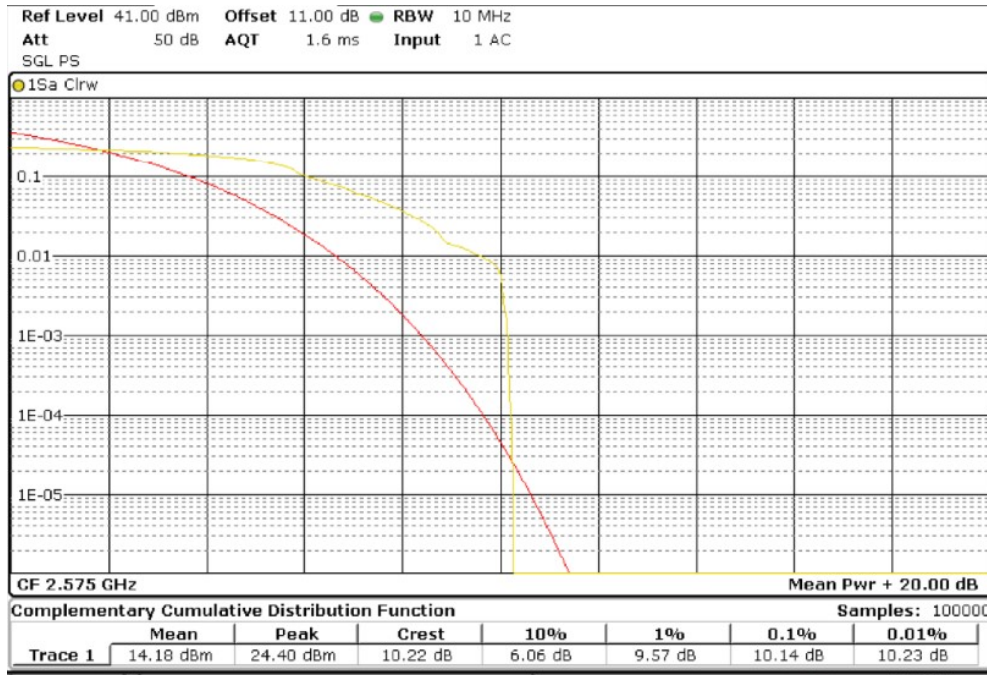

Middle channel

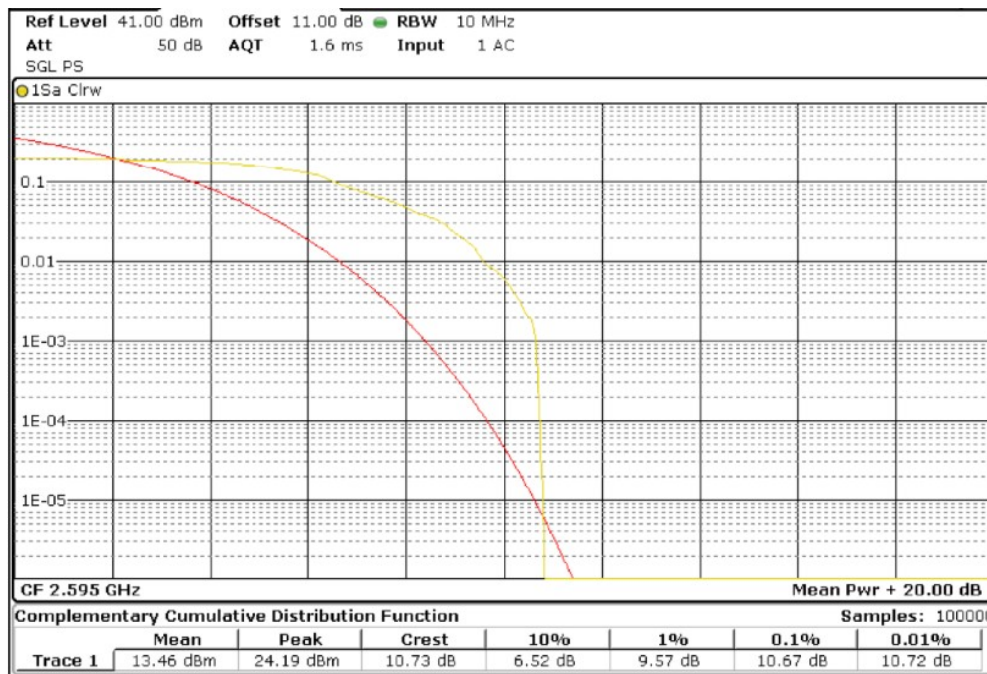

TEST RESULTS (Cont):

Highest channel

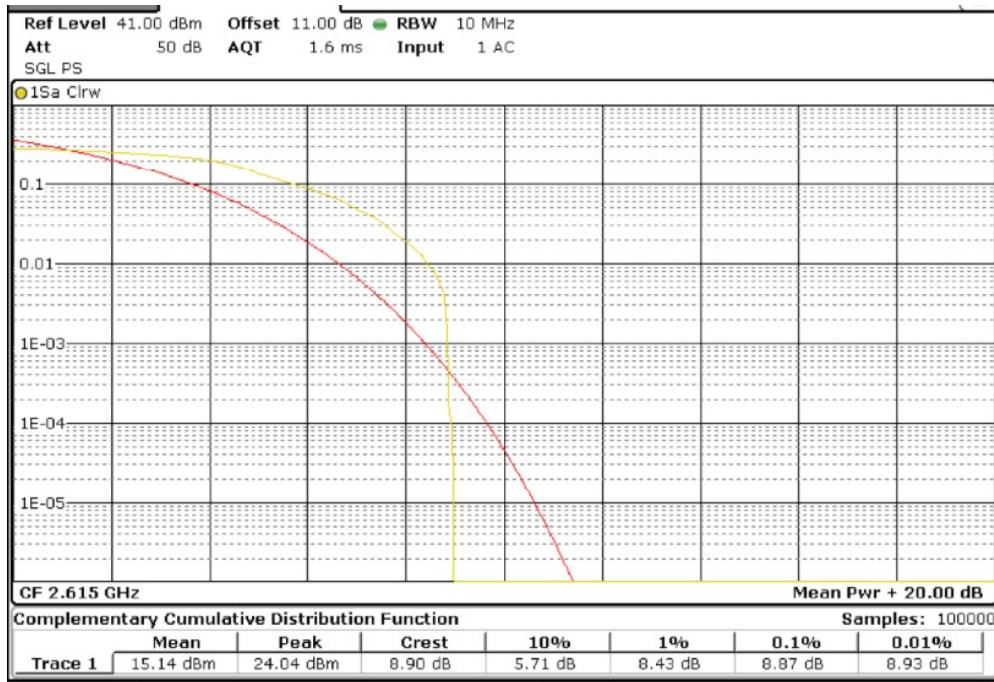

PAPR

Bandwidth = 10 MHz. Modulation 16QAM. RB Size: 1. RB Offset: 0.

Lowest channel

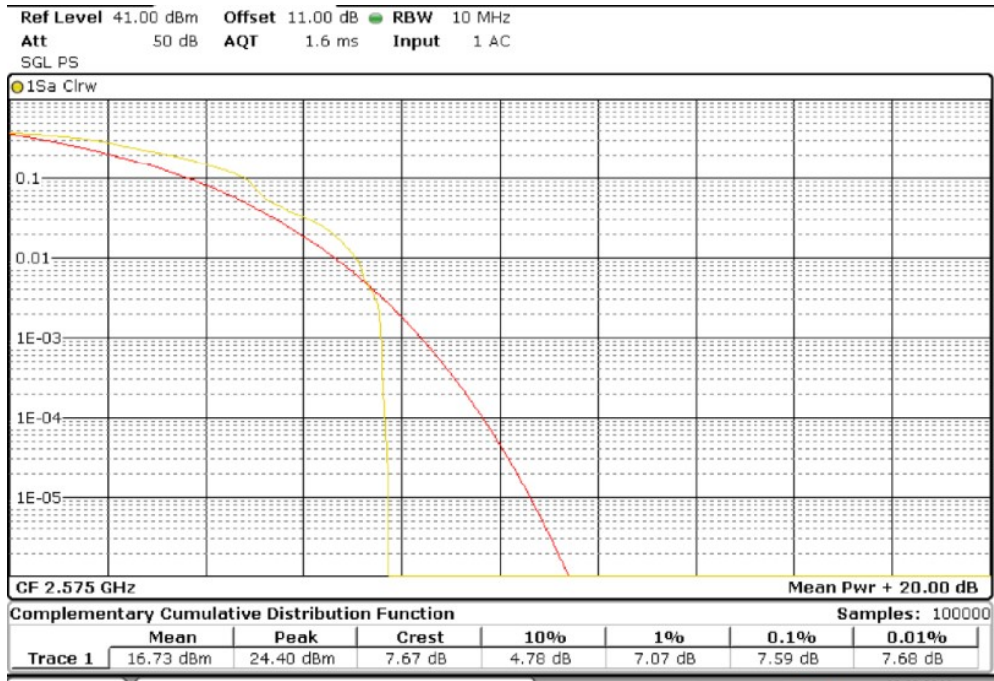

TEST RESULTS (Cont):

Middle channel



Highest channel

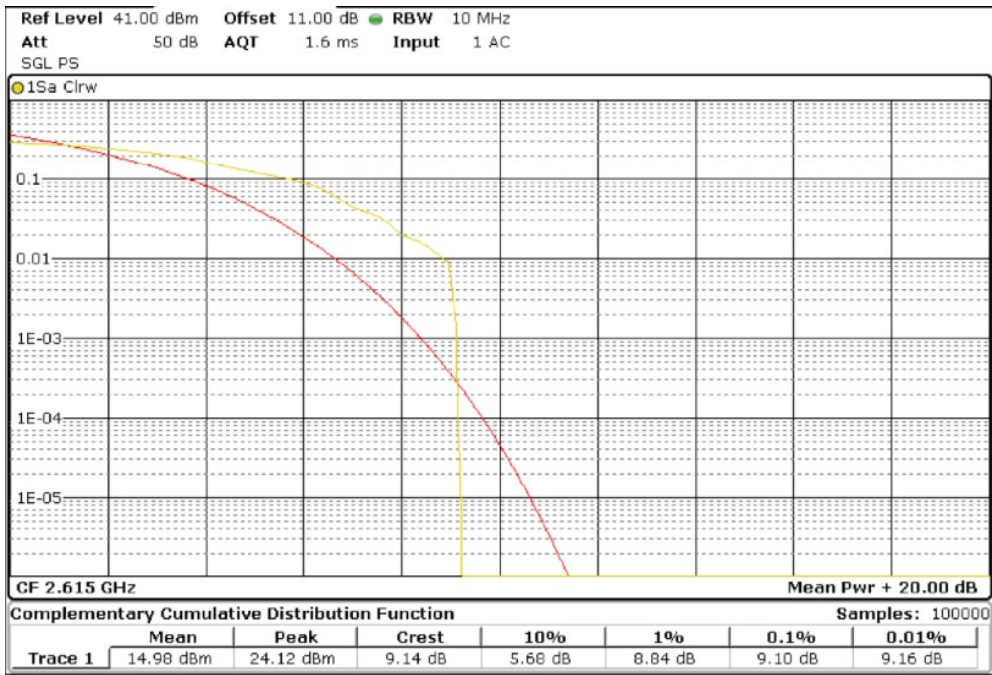

TEST RESULTS (Cont):

PAPR
 Bandwidth = 15 MHz. Modulation QPSK. RB Size: 1. RB Offset: 0.
 Lowest channel

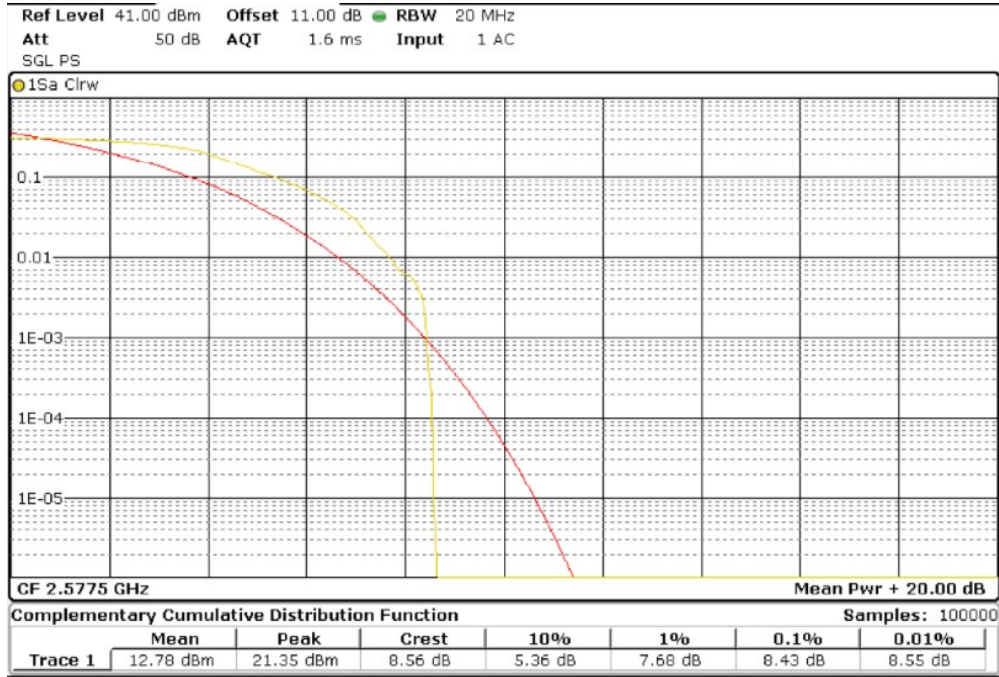

Middle channel

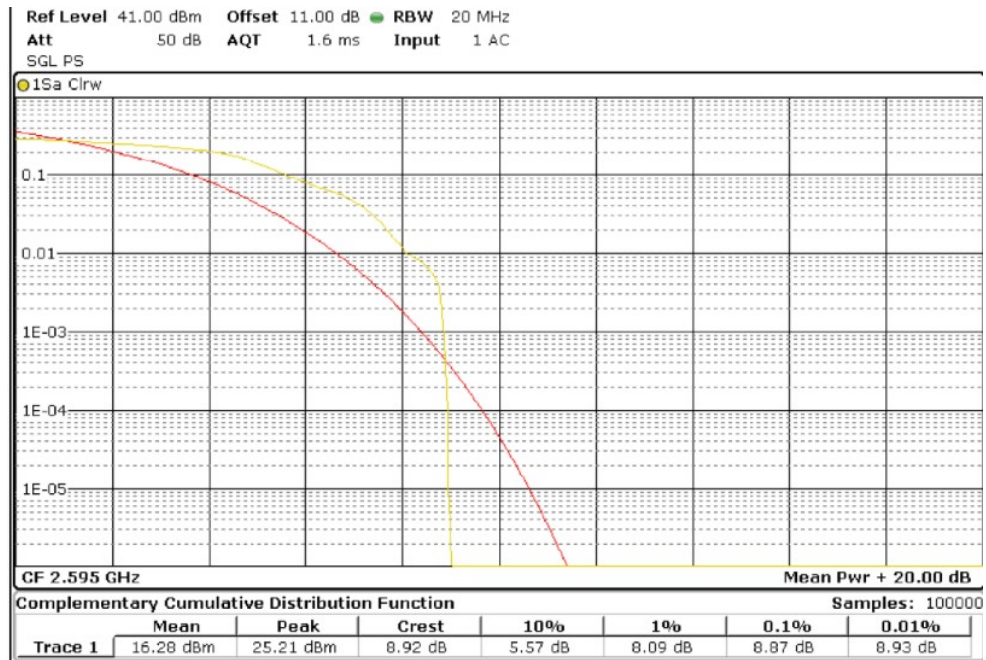

TEST RESULTS (Cont):

Highest channel

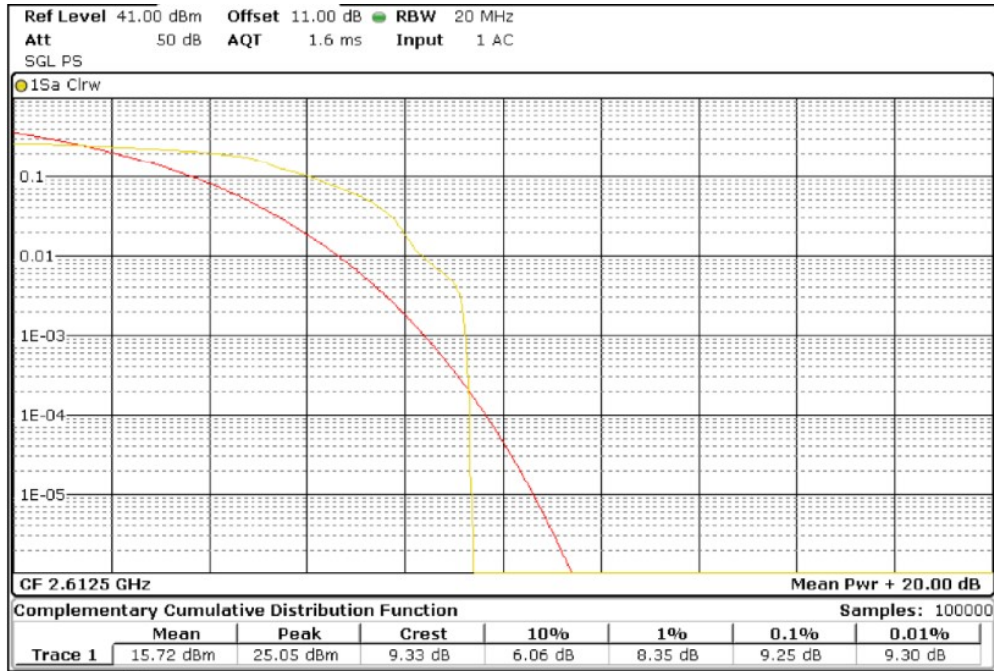

Bandwidth = 15 MHz. Modulation 16QAM. RB Size: 1. RB Offset: 0.
 Lowest channel



TEST RESULTS (Cont):

Middle channel

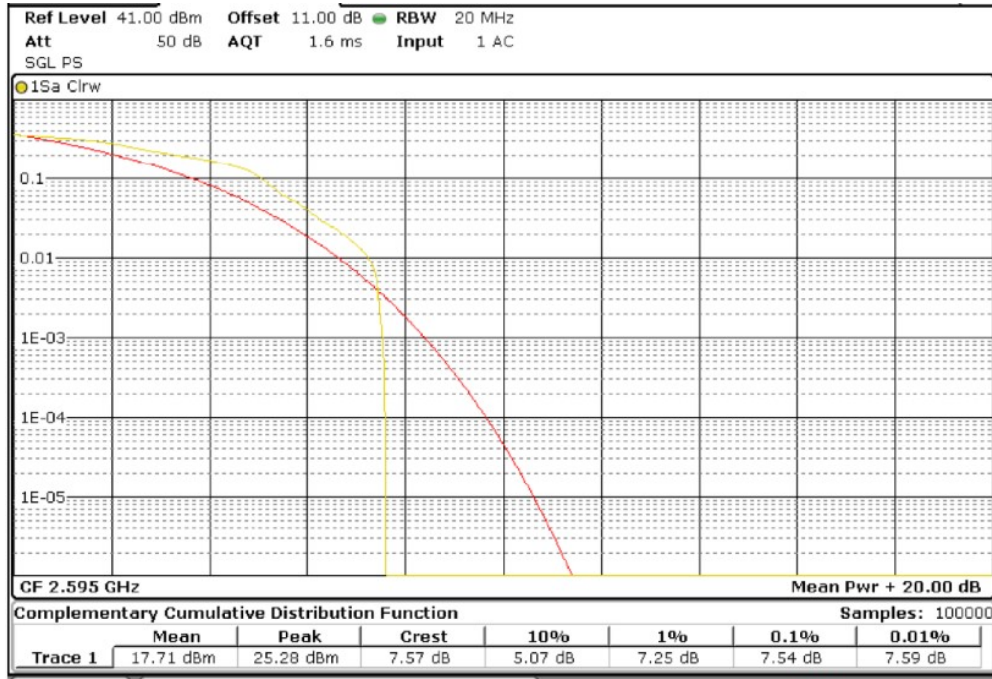

Highest channel

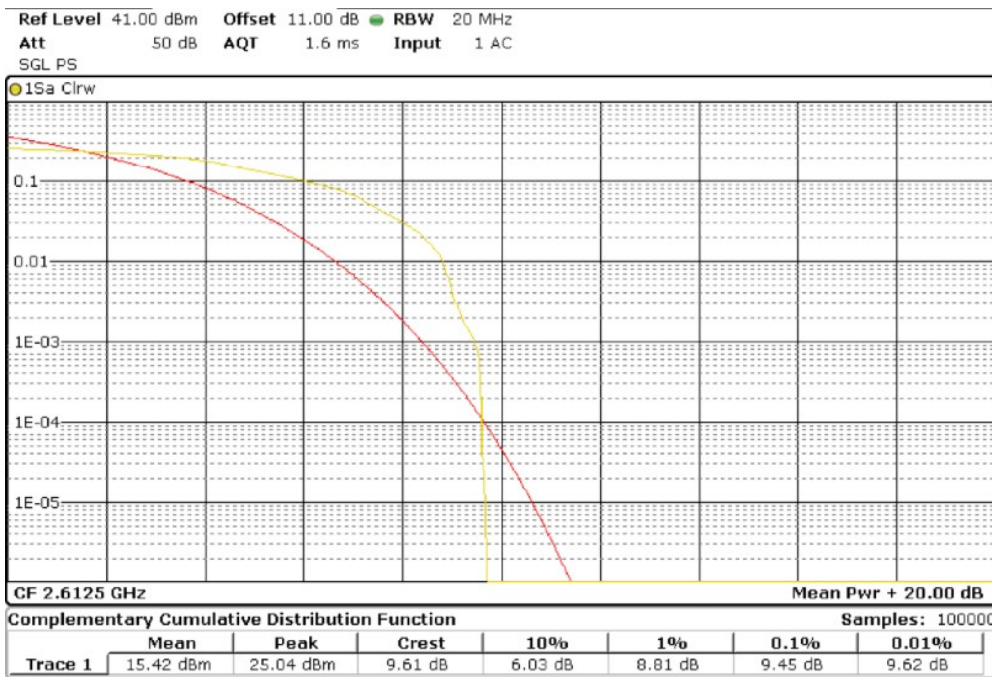

TEST RESULTS (Cont):

Bandwidth = 20 MHz. Modulation QPSK. RB Size: 1. RB Offset: 0.
 Lowest channel

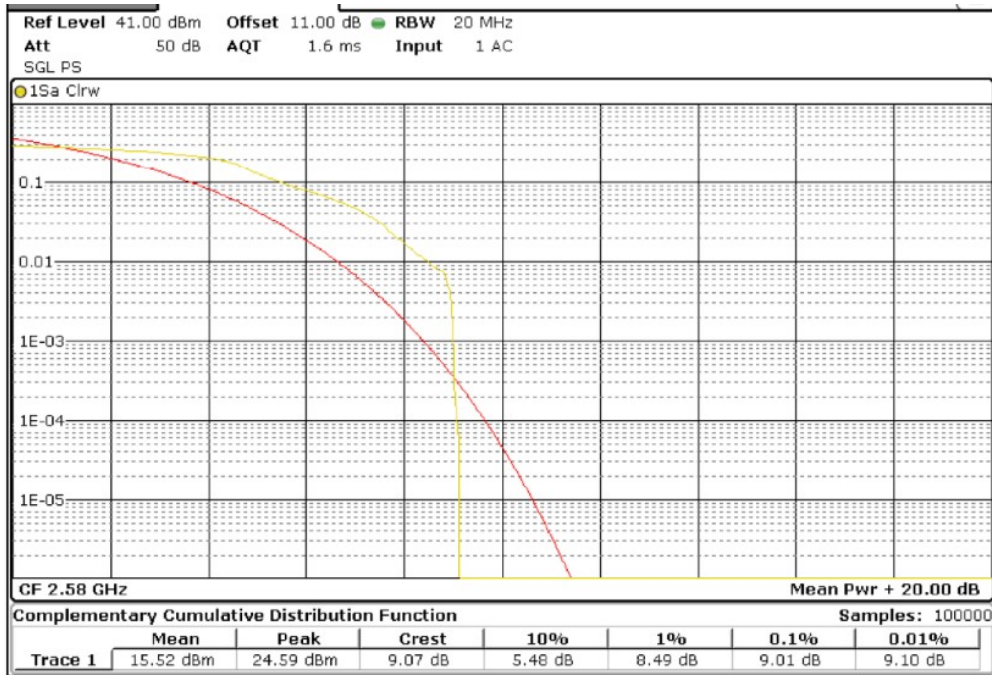

Middle channel

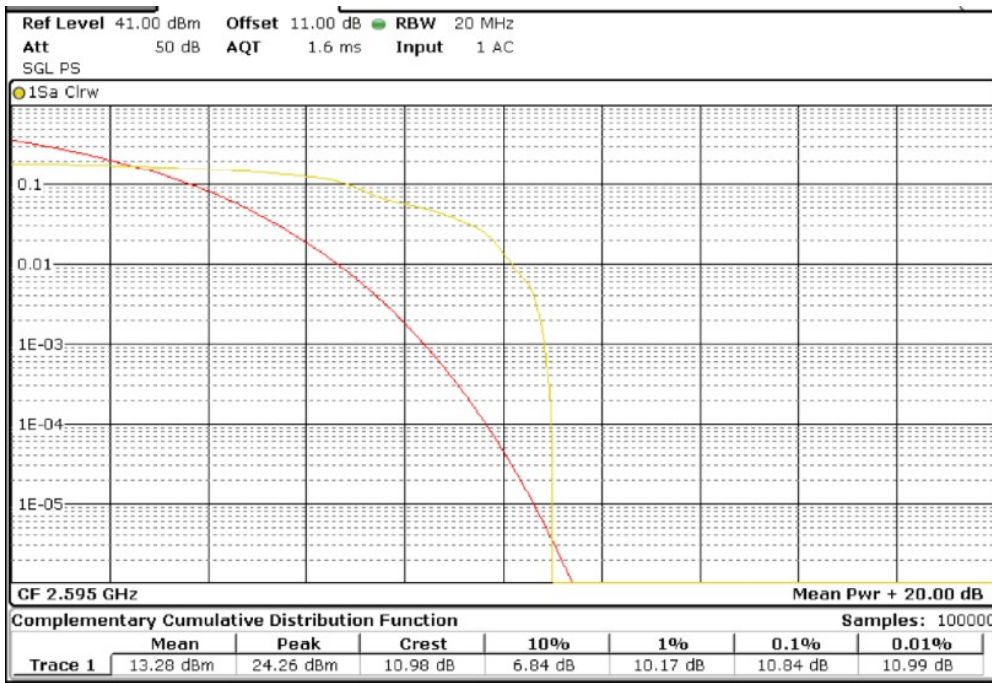

TEST RESULTS (Cont):

Highest channel

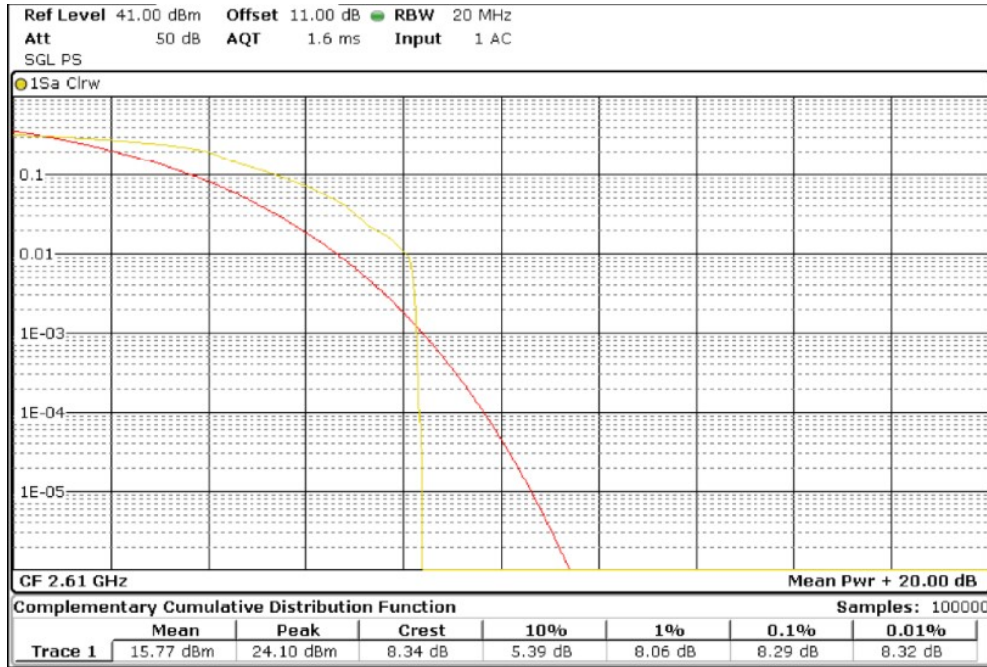

Bandwidth = 20 MHz. Modulation 16QAM. RB Size: 1. RB Offset: 0.
 Lowest channel

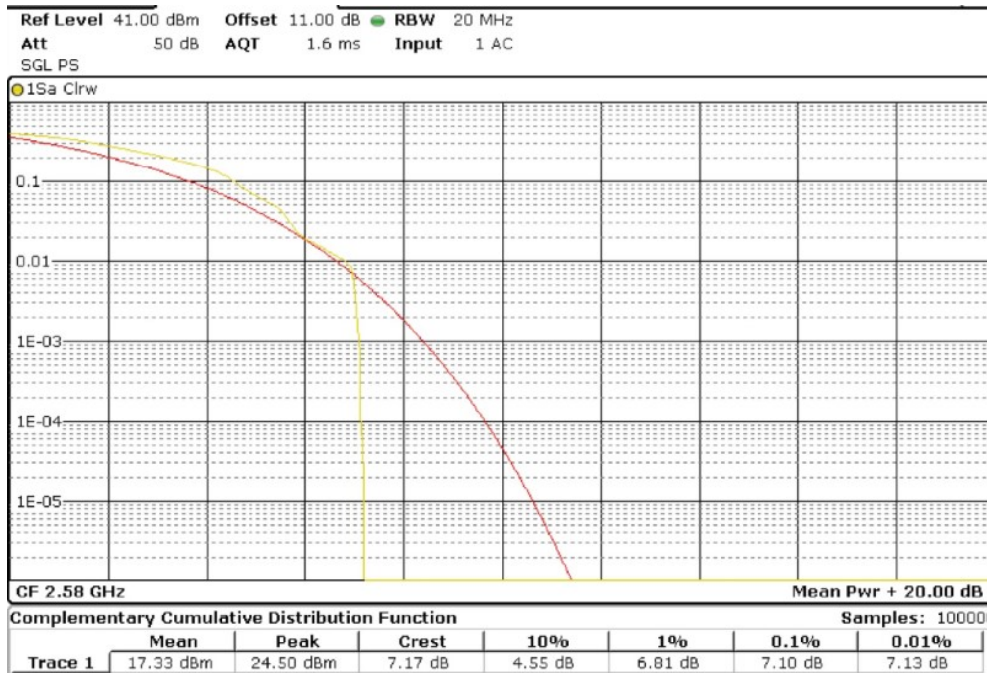

TEST RESULTS (Cont):

Middle channel

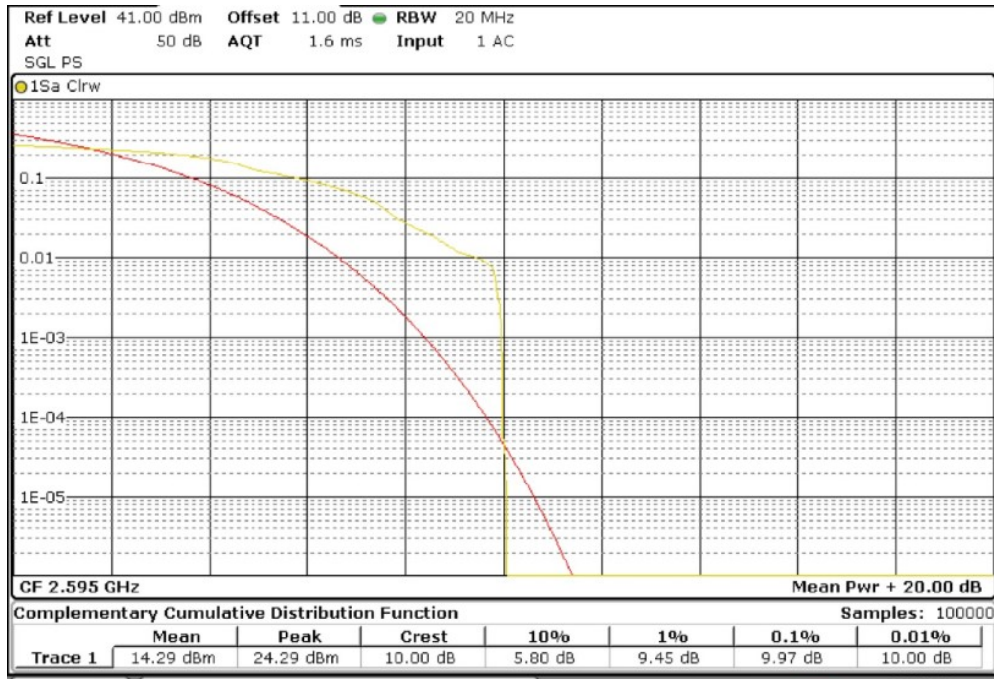

Highest channel



TEST A.2: MODULATION CHARACTERISTICS

LIMITS:	Product standard:	FCC Part 27 / IC RSS-199
	Test standard:	FCC §2.1047 and §27.50 / RSS-199 Clause 4.1

LIMITS

A curve or equivalent data which shows that the equipment will meet the modulation requirements of the rules under which the equipment is to be licensed.

TEST SETUP

For LTE the EUT operates with QPSK and 16QAM modulation modes in which the information is digitized and coded into a bit stream. The RF transmission is multiplexed using Orthogonal Frequency Division Multiplexing (OFDM) using different possible arrangement of subcarriers (Resource Blocks RB).

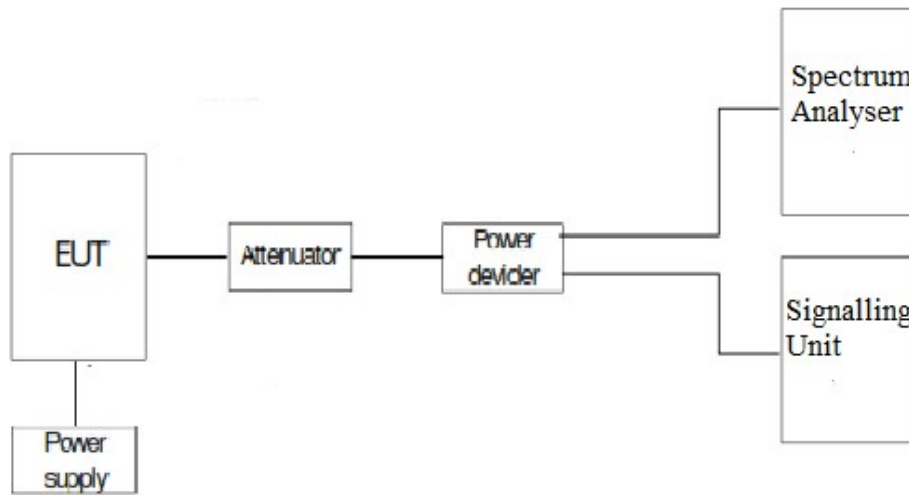

TESTED SAMPLES:	S/01
TESTED CONDITIONS MODES:	TC#01
TEST RESULTS:	PASS

QPSK Modulation

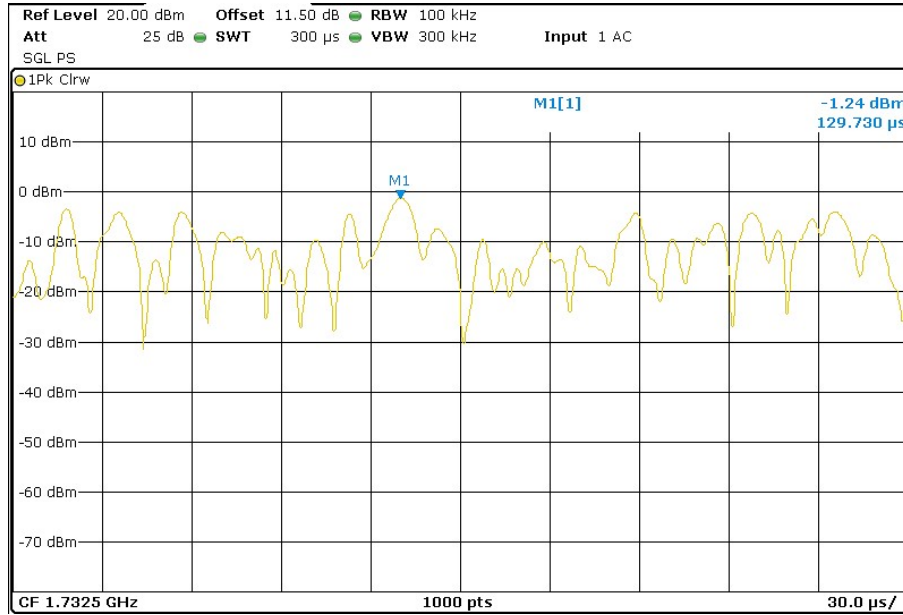

16QAM Modulation

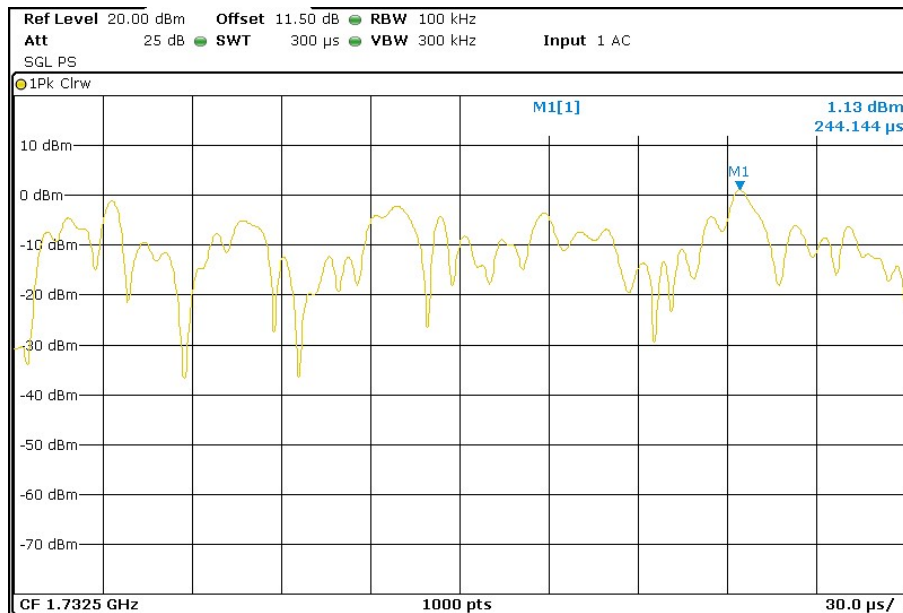

TEST A.3: FREQUENCY STABILITY

LIMITS:	Product standard:	FCC Part 27 / IC RSS-199
	Test standard:	FCC §2.1055 and § 27.54 / RSS-199 Clause 4.3

LIMITS

The frequency stability shall be enough to ensure that the fundamental emissions stay within the authorized bands of operation.

TEST SETUP

The frequency tolerance measurements over temperature variations were made over the temperature range of -30°C to $+50^{\circ}\text{C}$. The EUT was placed inside a climatic chamber and the temperature was raised hourly in 10°C steps from -30°C up to $+50^{\circ}\text{C}$.

The supply voltage was varied between 85% and 115% of nominal voltage.

The EUT was set in “call mode” in the middle channel using the Universal Radio Communication tester R&S CMW500 and the maximum frequency error was measured using the built-in calibrated frequency meter.

For LTE mode the QPSK modulation was used for the test as it is the worst case for conducted power.

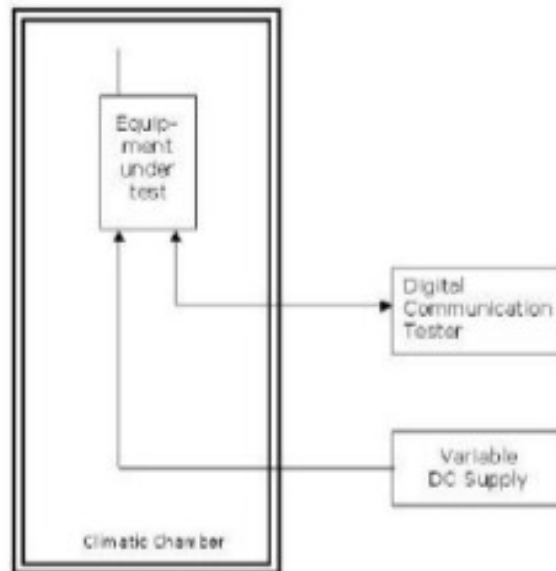

TESTED SAMPLES:	S/01
TESTED CONDITIONS MODES:	TC#01
TEST RESULTS:	PASS

LTE QPSK MODULATION. BW = 5 MHz

Frequency stability over temperature variations

Temperature (°C)	Frequency Error (Hz)	Frequency Error (ppm)	Frequency Error (%)
50	-4.56	-0.0129	-0.00000129
40	0.27	-0.0127	-0.00000127
30	2.2	-0.0069	-0.00000069
20	-11.27	-0.0094	-0.00000094
10	6.84	-0.0051	-0.00000051
0	-4.32	-0.0077	-0.00000077
-10	9.77	-0.0072	-0.00000072
-20	-1.8	-0.0097	-0.00000097
-30	-3.2	-0.0070	-0.00000070

Frequency stability over voltage variations

Battery Supply voltage	Voltage (V)	Frequency Error (Hz)	Frequency Error (ppm)	Frequency Error (%)
Vmax	4.37	-11.8	-0.0082	-0.00000082
Vmin	3.23	-14.82	-0.0110	-0.00000110

TEST A.4: OCCUPIED BANDWIDTH

LIMITS:	Product standard:	FCC Part 27 / IC RSS-199
	Test standard:	FCC § 2.1049 / RSS-199 Clause 4.2

LIMITS

Reference only.

TEST SETUP

The occupied bandwidth measurement was performed at the output terminals of the EUT using an attenuator, power splitter and spectrum analyzer. The EUT was controlled via the Universal Radio Communication tester R&S CMW500 selecting maximum transmission power of the EUT and different modes of modulation. The 99% occupied bandwidth and the -26 dBc bandwidth were measured directly using the built-in bandwidth measuring option of spectrum analyzer.

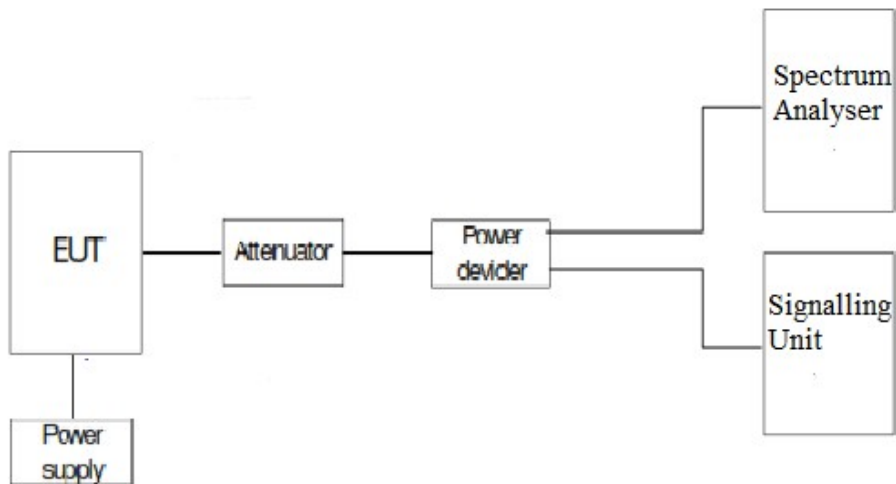

TESTED SAMPLES:	S/01
TESTED CONDITIONS MODES:	TC#01
TEST RESULTS:	PASS

RESULTS

LTE QPSK MODULATION. BW = 5 MHz

Channel	Lowest	Middle	Highest
99% Occupied bandwidth (MHz)	4.67	4.64	4.68
-26 dBc bandwidth (MHz)	5.36	5.38	5.47

LTE 16QAM MODULATION. BW = 5 MHz

Channel	Lowest	Middle	Highest
99% Occupied bandwidth (MHz)	4.65	4.67	4.66
-26 dBc bandwidth (MHz)	5.32	5.38	5.34

LTE QPSK MODULATION. BW = 10 MHz

Channel	Lowest	Middle	Highest
99% Occupied bandwidth (MHz)	9.20	9.23	9.23
-26 dBc bandwidth (MHz)	10.42	10.42	10.45

LTE 16QAM MODULATION. BW = 10 MHz

Channel	Lowest	Middle	Highest
99% Occupied bandwidth (MHz)	9.20	9.17	9.20
-26 dBc bandwidth (MHz)	10.39	10.30	10.39

LTE QPSK MODULATION. BW = 15 MHz

Channel	Lowest	Middle	Highest
99% Occupied bandwidth (MHz)	13.60	13.55	13.50
-26 dBc bandwidth (MHz)	15.11	15.08	15.07

TEST RESULTS (Cont):

LTE 16QAM MODULATION. BW = 15 MHz

Channel	Lowest	Middle	Highest
99% Occupied bandwidth (MHz)	13.55	13.60	13.60
-26 dBc bandwidth (MHz)	15.11	15.17	15.15

LTE QPSK MODULATION. BW = 20 MHz

Channel	Lowest	Middle	Highest
99% Occupied bandwidth (MHz)	18.40	18.33	18.40
-26 dBc bandwidth (MHz)	20.52	20.38	20.40

LTE 16QAM MODULATION. BW = 20 MHz

Channel	Lowest	Middle	Highest
99% Occupied bandwidth (MHz)	17.93	17.93	18.00
-26 dBc bandwidth (MHz)	19.71	19.68	19.80

LTE QPSK MODULATION. BW = 5 MHz

Lowest Channel 99% Occupied Bandwidth

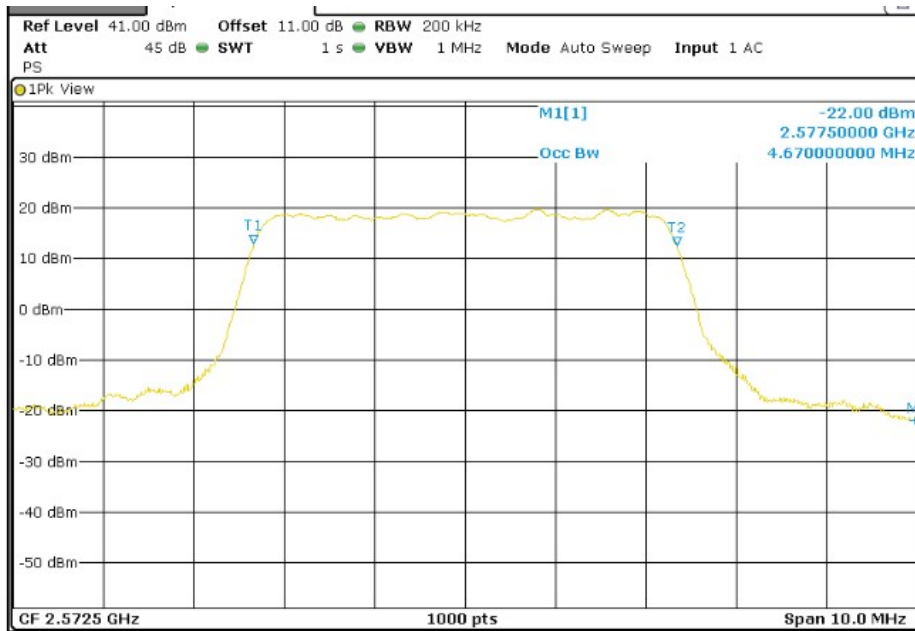

TEST RESULTS (Cont):

Lowest Channel -26dBc Bandwidth kHz

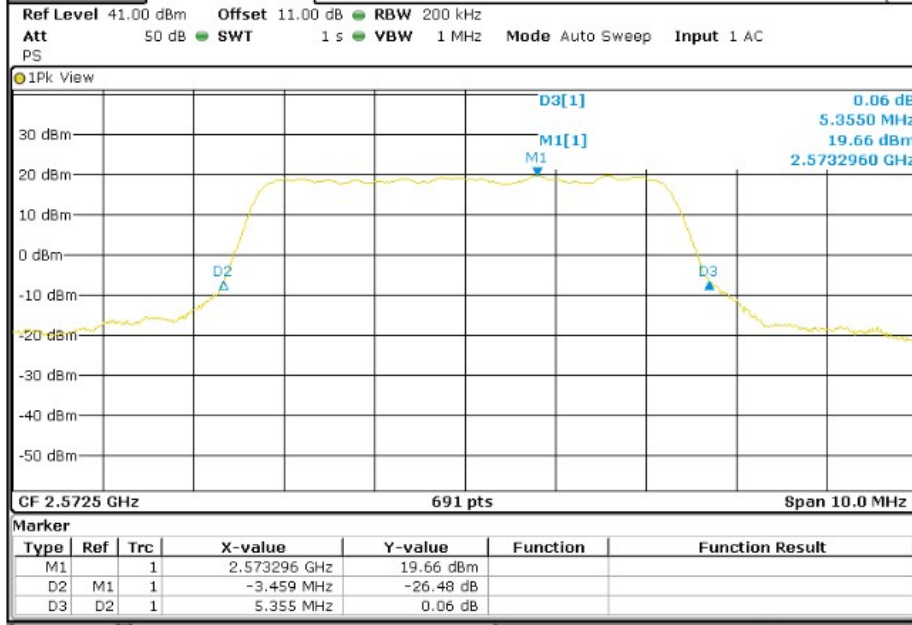

Middle Channel 99% Occupied Bandwidth

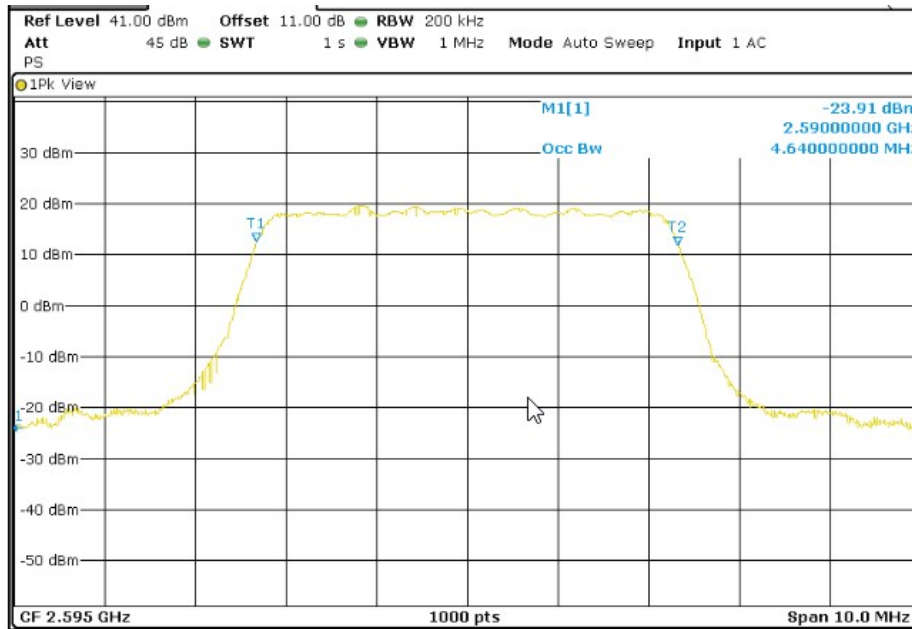

TEST RESULTS (Cont):

Middle Channel 26dBc Bandwidth kHz

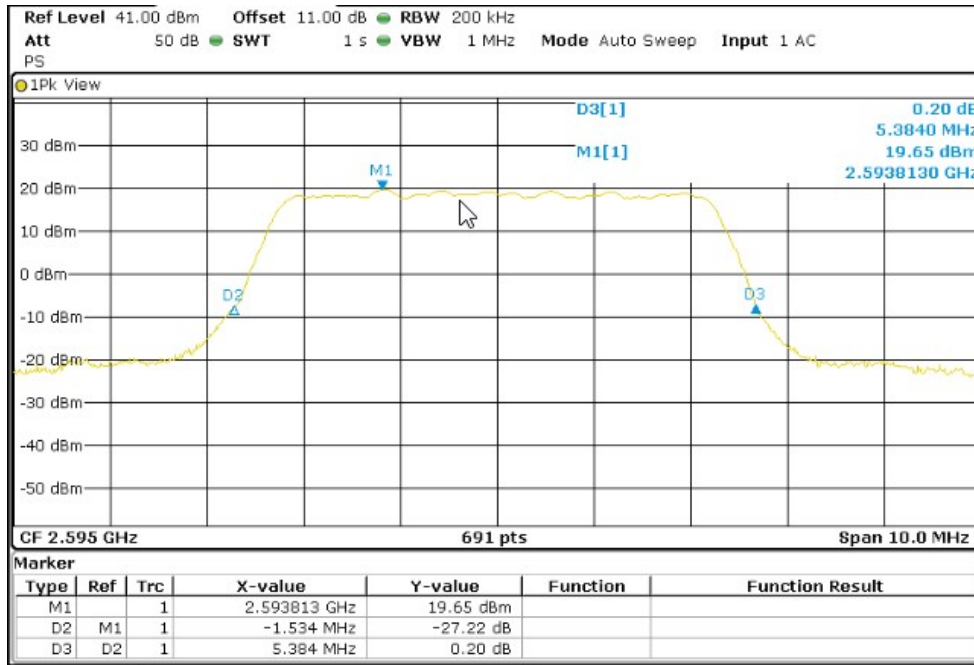

Highest Channel 99% Occupied Bandwidth

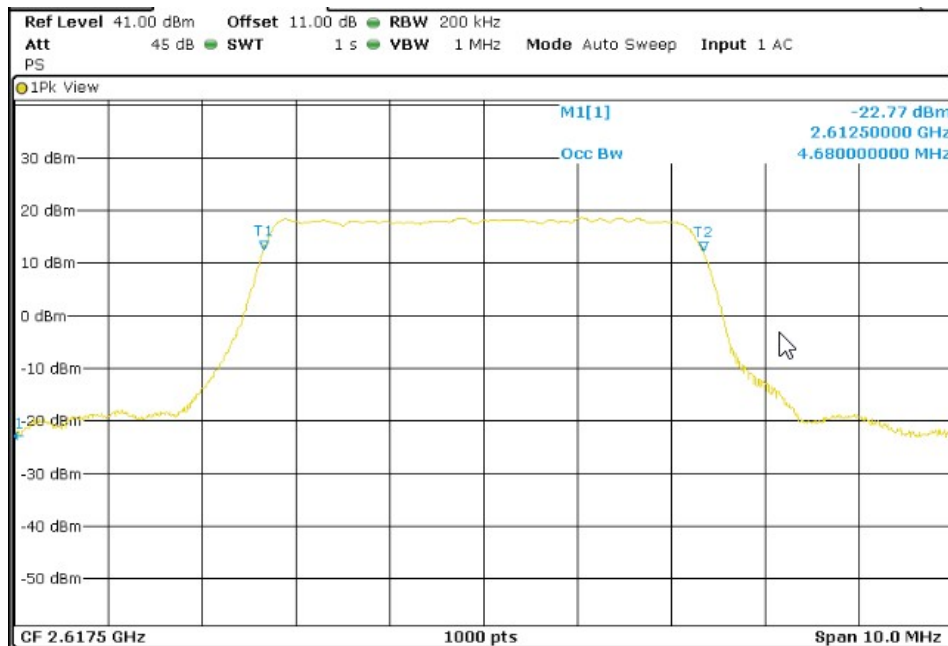

TEST RESULTS (Cont):

Highest Channel 26dBc Bandwidth kHz

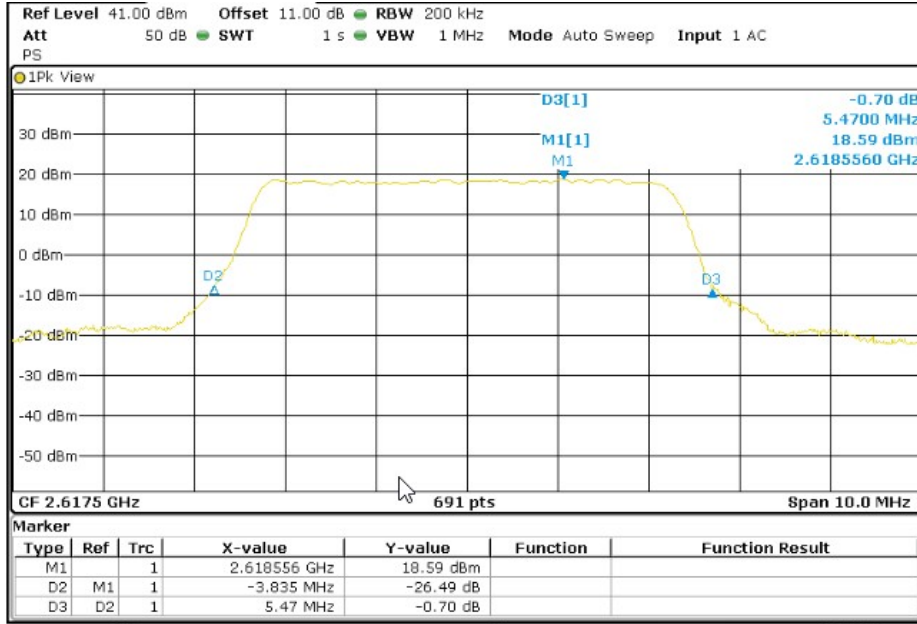

LTE 16QAM MODULATION. BW = 5 MHz

Lowest Channel 99% Occupied Bandwidth

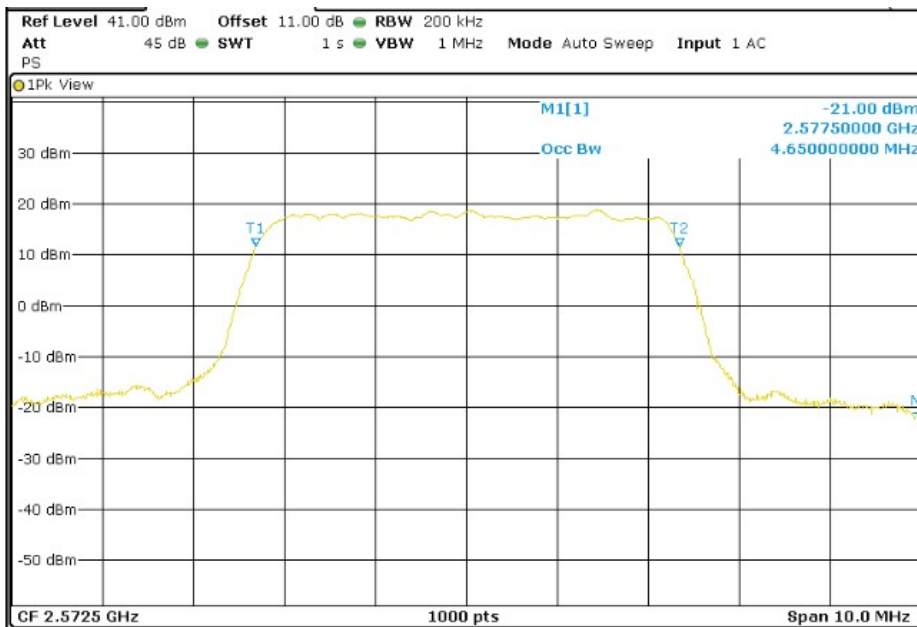

TEST RESULTS (Cont):

Lowest Channel -26dBc Bandwidth kHz

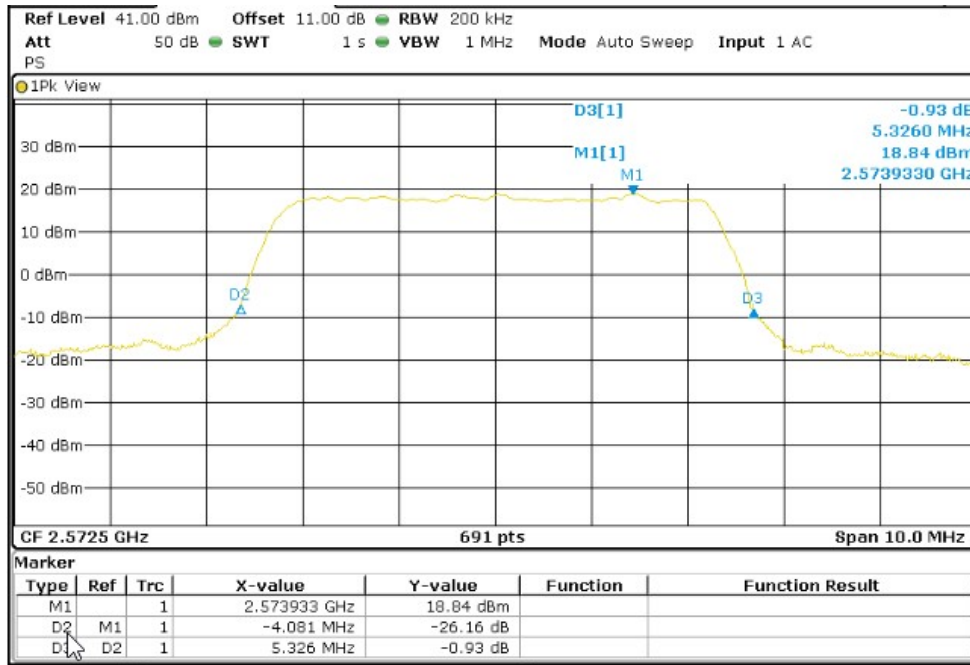

Middle Channel 99% Occupied Bandwidth

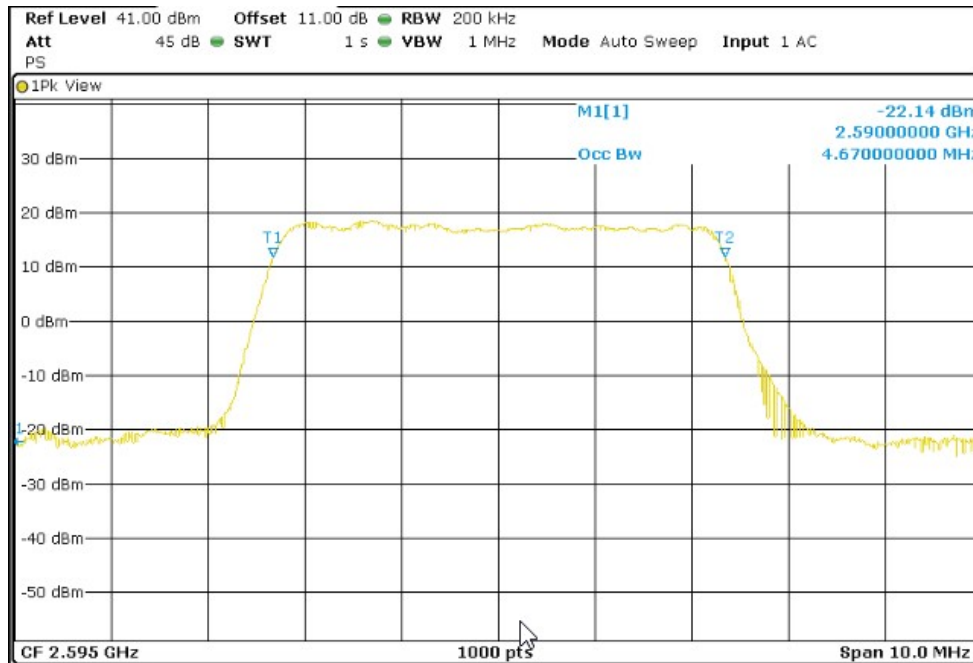

TEST RESULTS (Cont):

Middle Channel 26dBc Bandwidth kHz

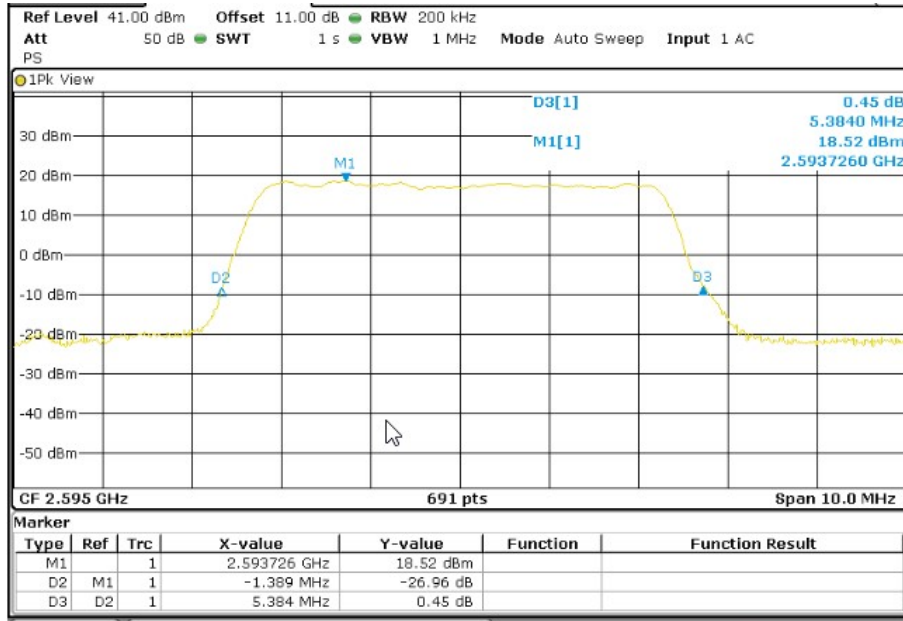

Highest Channel 99% Occupied Bandwidth

