

TEST RESULTS (Cont):

PAPR

Bandwidth = 15 MHz. Modulation QPSK. RB Size: 1. RB Offset: 0.
 Lowest channel

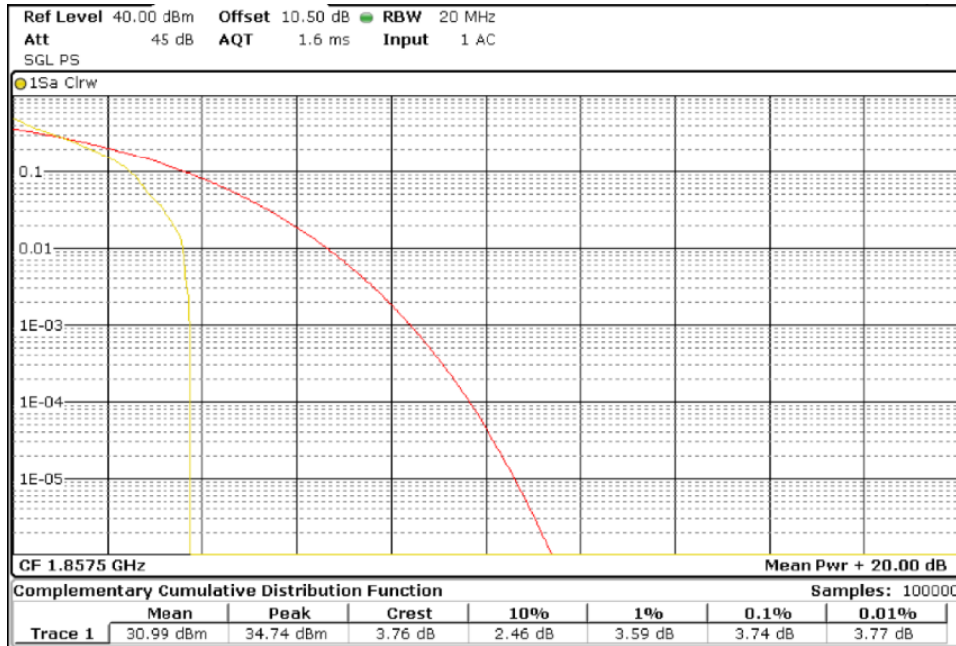

Middle channel

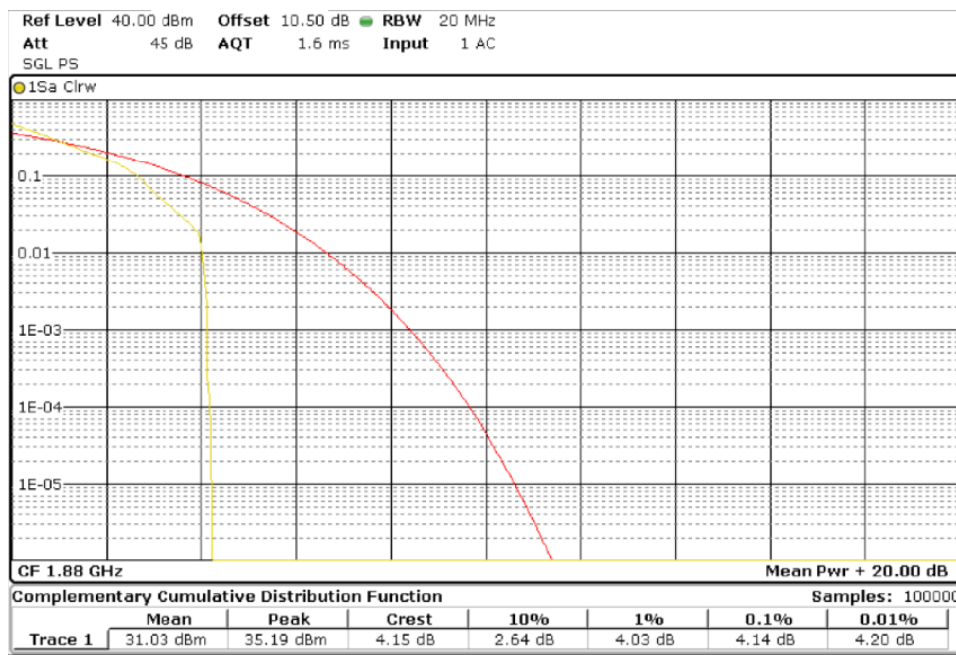

TEST RESULTS (Cont):

Highest channel

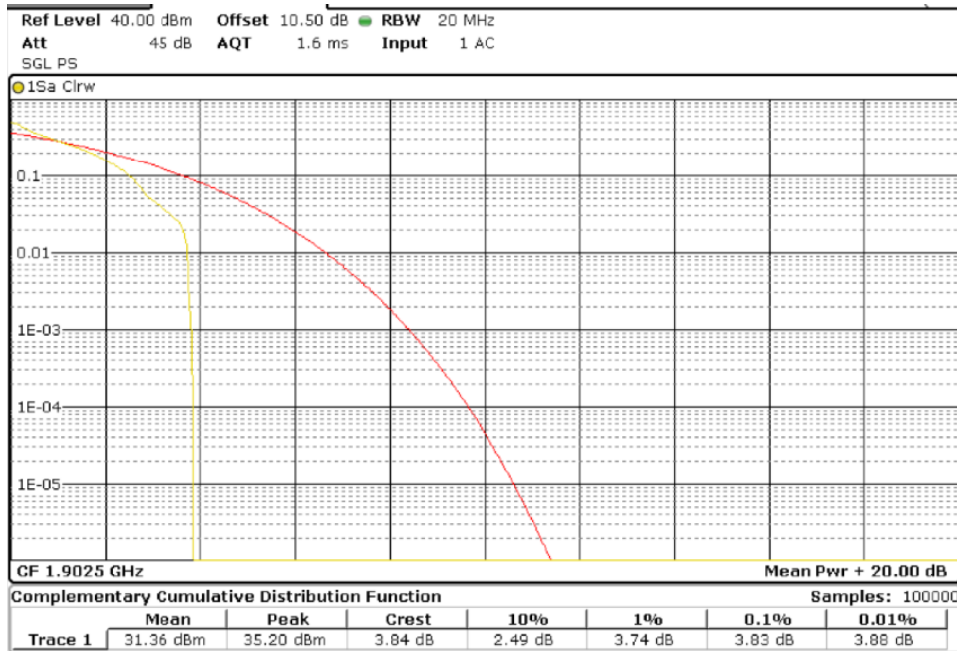

Bandwidth = 15 MHz. Modulation 16QAM. RB Size: 1. RB Offset: 0.
 Lowest channel

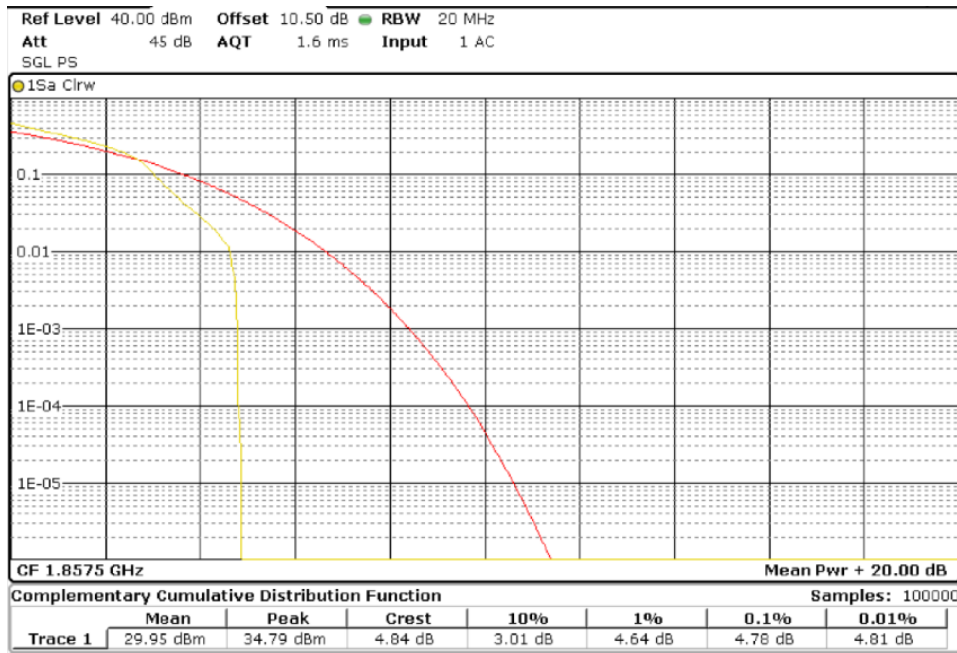

TEST RESULTS (Cont):

Middle channel

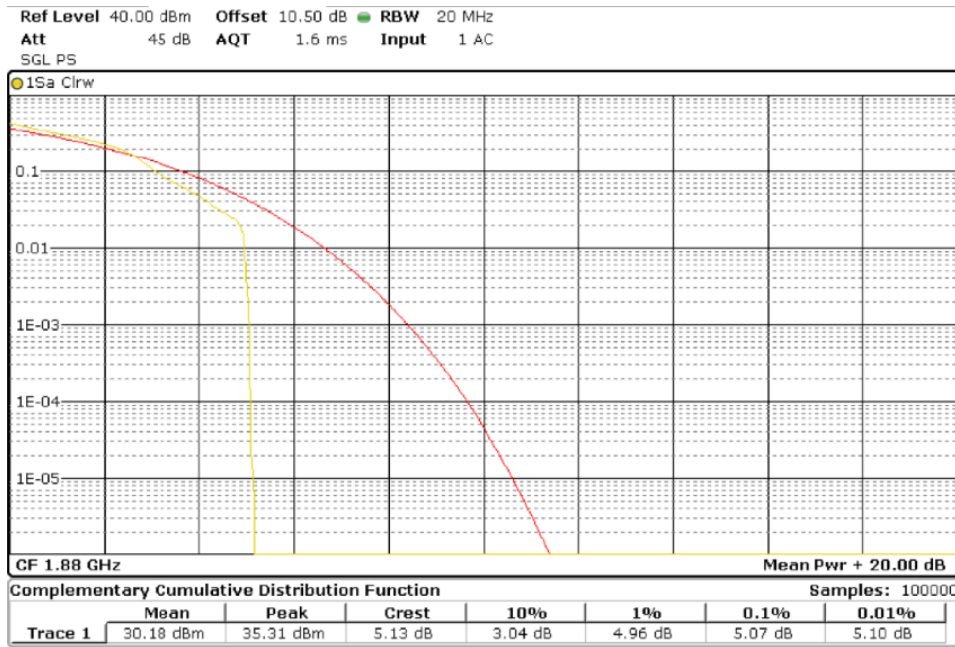

Highest channel

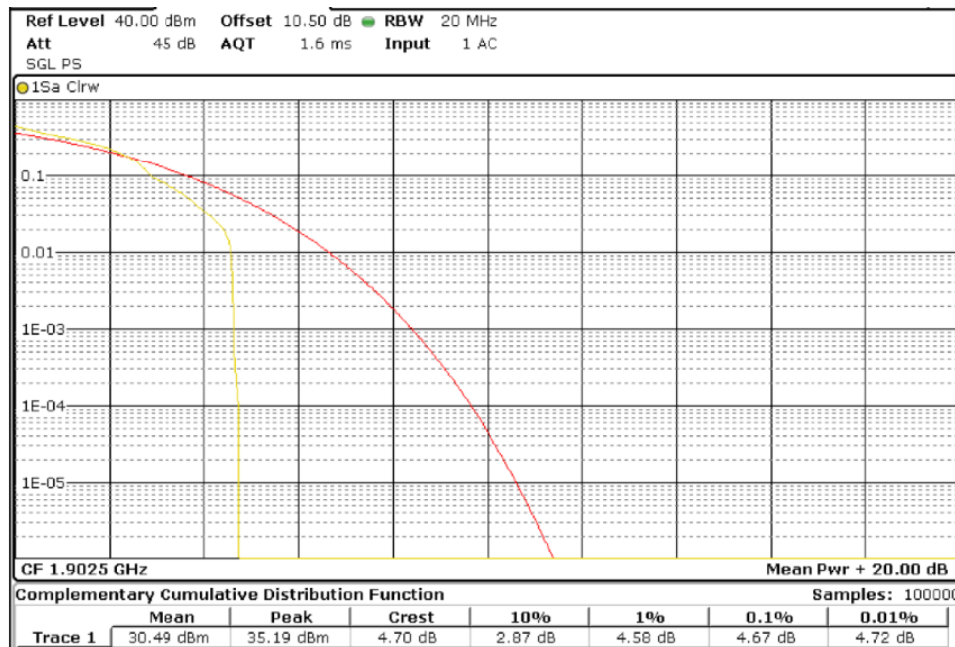

TEST RESULTS (Cont):

Bandwidth = 20 MHz. Modulation QPSK. RB Size: 1. RB Offset: 0.
 Lowest channel

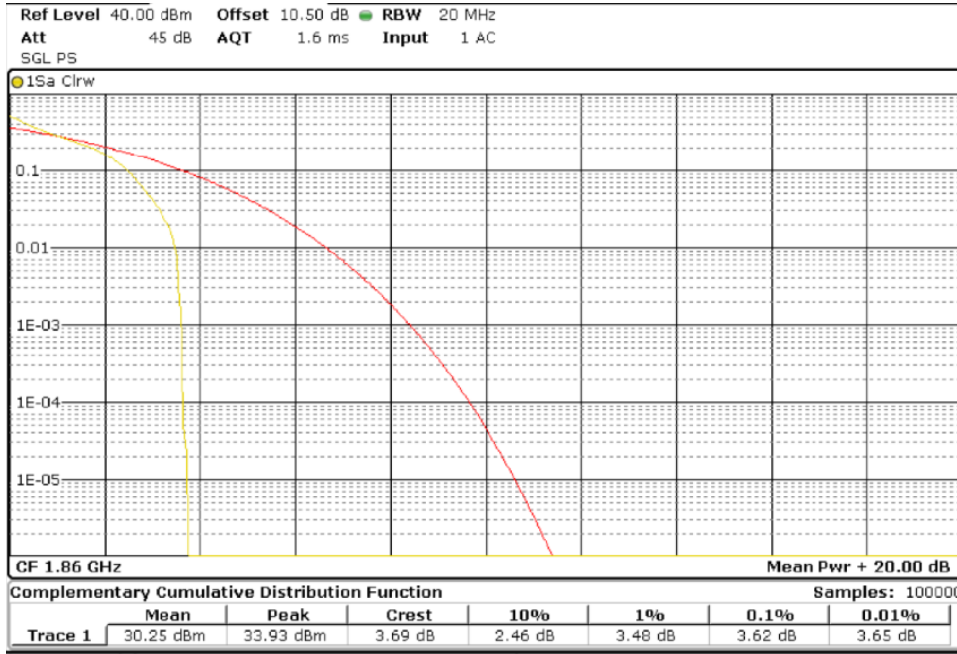

Middle channel

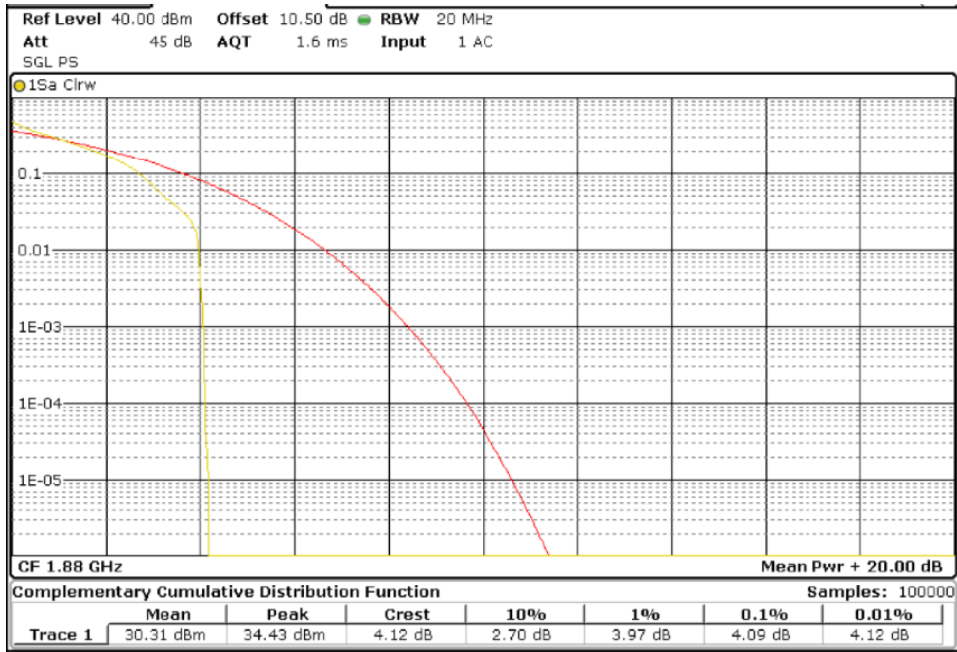

TEST RESULTS (Cont):

Highest channel

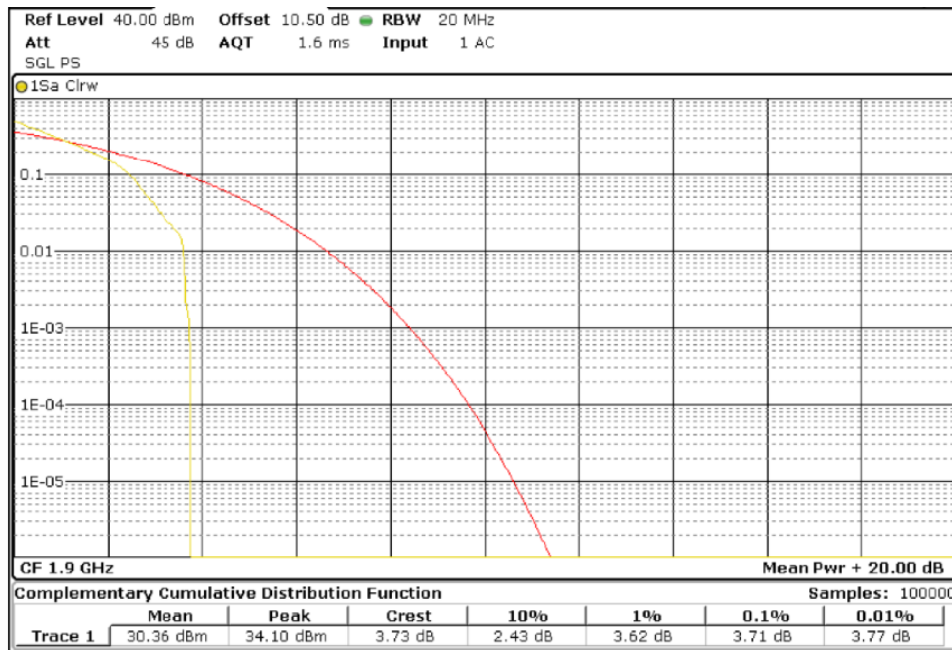

Bandwidth = 20 MHz. Modulation 16QAM. RB Size: 1. RB Offset: 0.
 Lowest channel

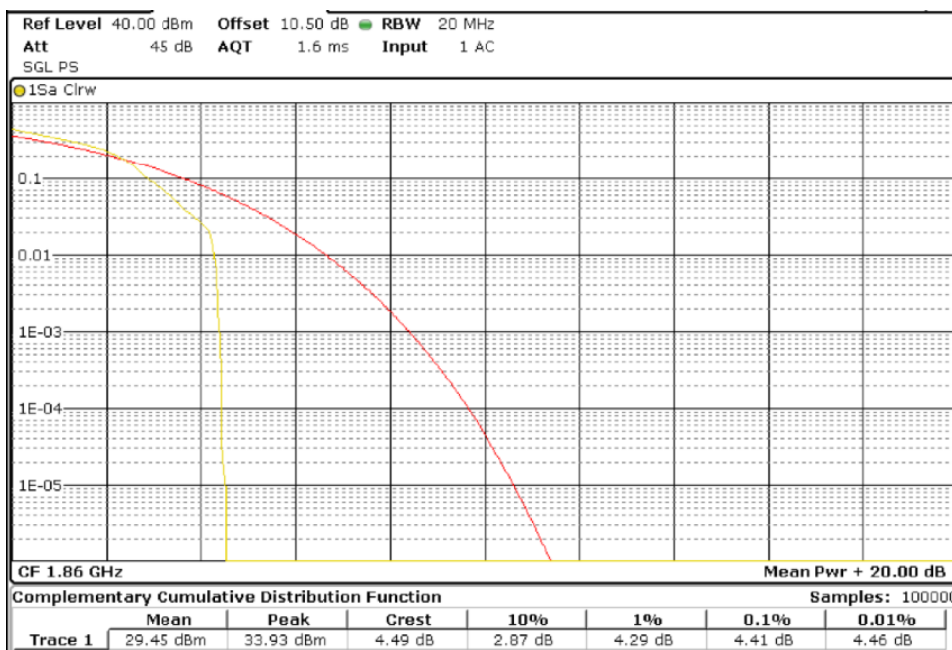

TEST RESULTS (Cont):

Middle channel

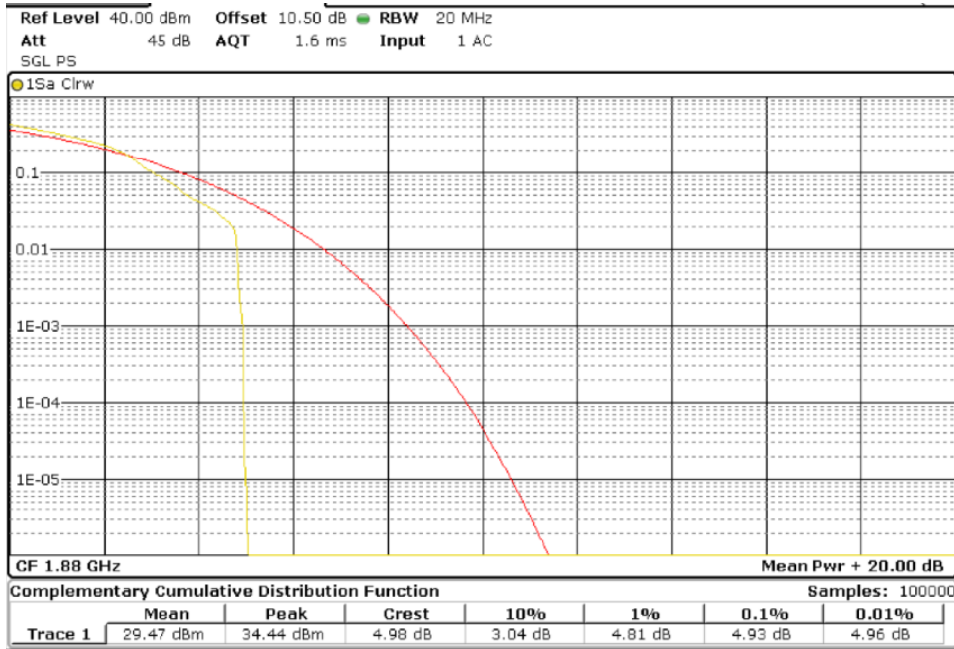

Highest channel

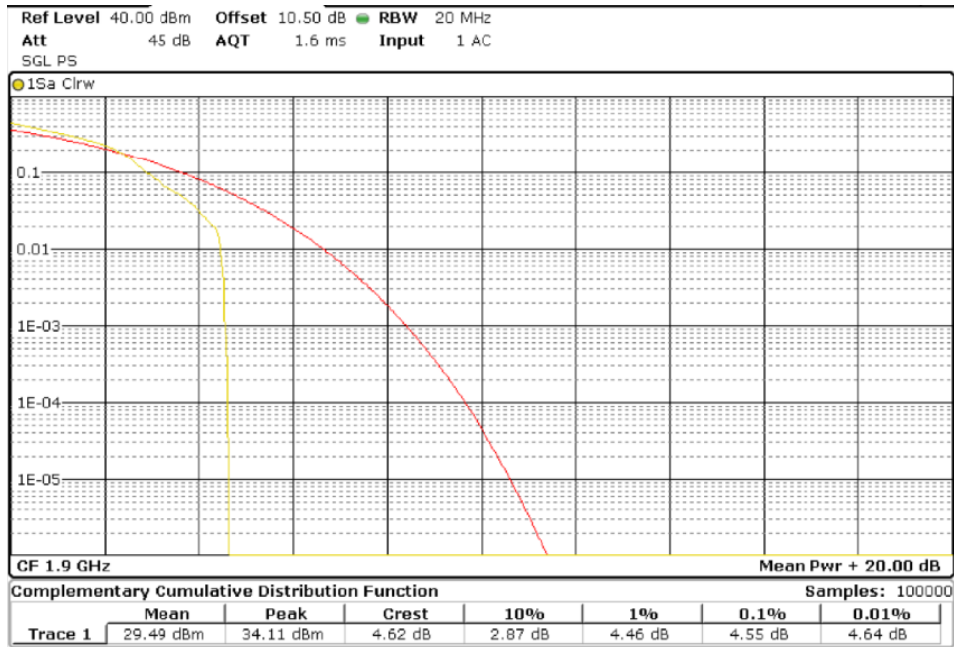

TEST C.2: MODULATION CHARACTERISTICS

LIMITS:	Product standard:	FCC Part 24 / IC RSS-133
	Test standard:	FCC §2.1047 and §24.236. RSS-133 Clause 6.3

LIMITS

A curve or equivalent data which shows that the equipment will meet the modulation requirements of the rules under which the equipment is to be licensed.

TEST SETUP

For LTE the EUT operates with QPSK and 16QAM modulation modes in which the information is digitized and coded into a bit stream. The RF transmission is multiplexed using Orthogonal Frequency Division Multiplexing (OFDM) using different possible arrangement of subcarriers (Resource Blocks RB).

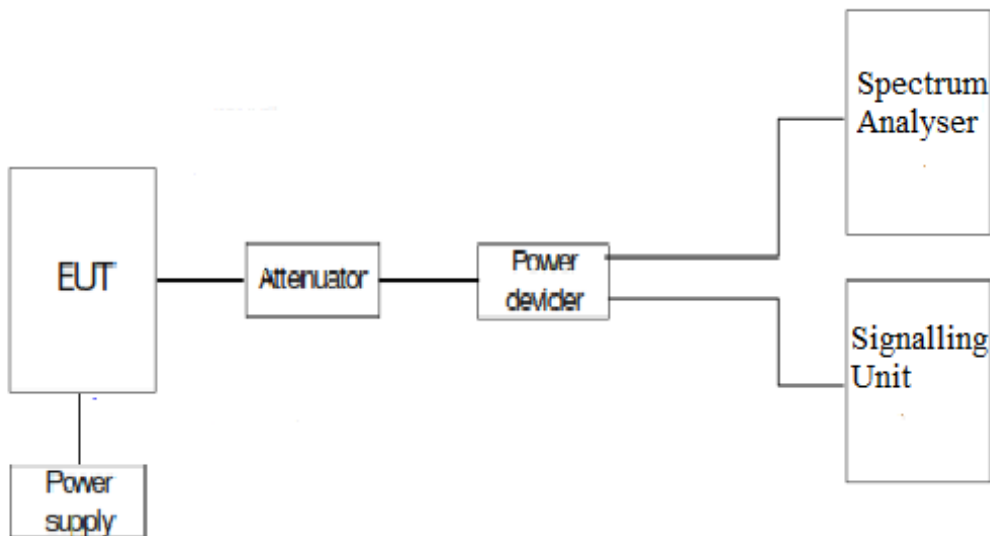

TESTED SAMPLES:	S/01
TESTED CONDITIONS MODES:	TC#01
TEST RESULTS:	PASS

QPSK Modulation

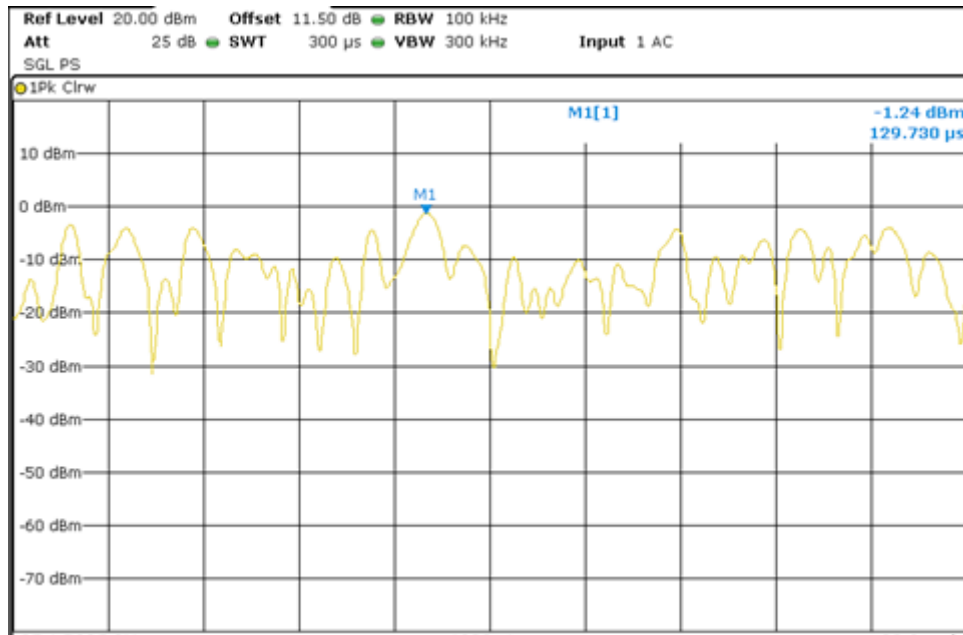

16QAM Modulation

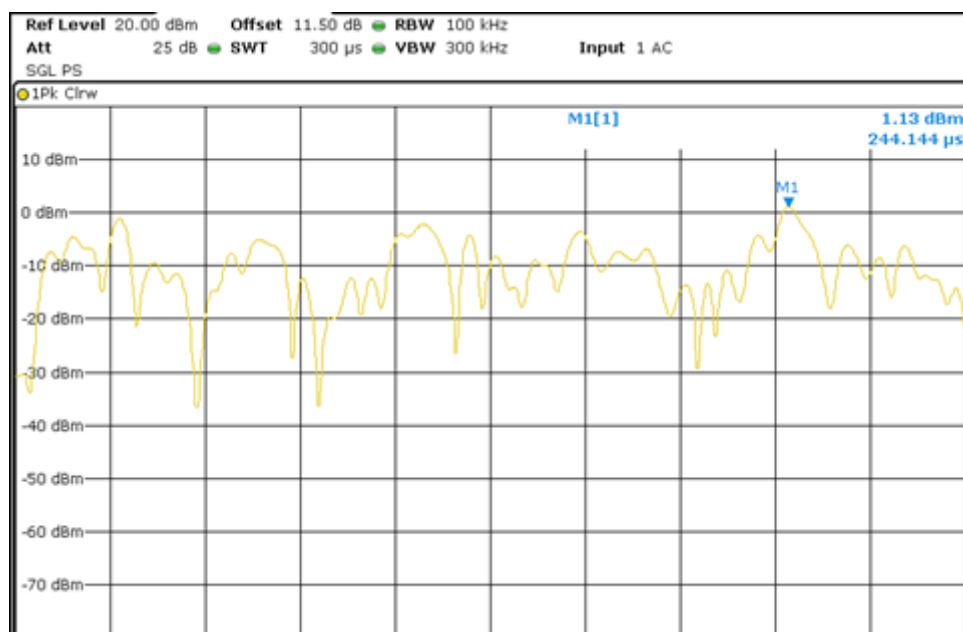

TEST C.3: FREQUENCY STABILITY

LIMITS:	Product standard:	FCC Part 24 / IC RSS-133
	Test standard:	FCC §2.1055 and § 24.235/ RSS-133 Clause 6.5

LIMITS

The frequency stability shall be enough to ensure that the fundamental emissions stay within the authorized bands of operation.

TEST SETUP

The frequency tolerance measurements over temperature variations were made over the temperature range of -30°C to $+50^{\circ}\text{C}$. The EUT was placed inside a climatic chamber and the temperature was raised hourly in 10°C steps from -30°C up to $+50^{\circ}\text{C}$.

The supply voltage was varied between 85% and 115% of nominal voltage.

The EUT was set in “call mode” in the middle channel using the Universal Radio Communication tester R&S CMW500 and the maximum frequency error was measured using the built-in calibrated frequency meter.

For LTE mode the QPSK modulation was used for the test as it is the worst case for conducted power.

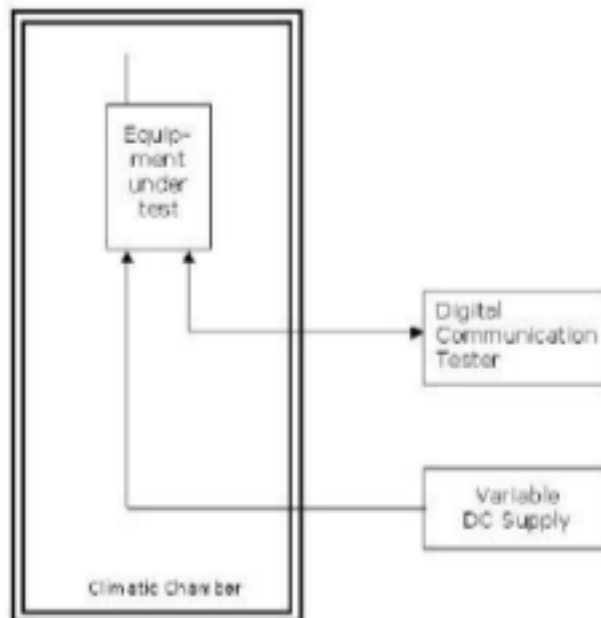

TESTED SAMPLES:	S/01
TESTED CONDITIONS MODES:	TC#01
TEST RESULTS:	PASS

LTE QPSK MODULATION. BW = 5 MHz

Frequency stability over temperature variations

Temperature (°C)	Frequency Error (Hz)	Frequency Error (ppm)	Frequency Error (%)
50	10.41	0.0055	0.00000055
40	7.38	0.0039	0.00000039
30	5.15	0.0027	0.00000027
20	4.81	0.0026	0.00000026
10	5.65	0.0030	0.00000030
0	6.88	0.0037	0.00000037
-10	10.71	0.0057	0.00000057
-20	8.54	0.0045	0.00000045
-30	6.18	0.0033	0.00000033

Frequency stability over voltage variations

Battery Supply voltage	Voltage (V)	Frequency Error (Hz)	Frequency Error (ppm)	Frequency Error (%)
Vmax	4.4	10.53	0.0056	0.00000056
Vmin	3.3	10.11	0.0054	0.00000054

TEST C.4: OCCUPIED BANDWIDTH

LIMITS:	Product standard:	FCC Part 24 / IC RSS-133
	Test standard:	FCC § 2.1049/ RSS-133 Clause 2.3

LIMITS

Reference only.

TEST SETUP

The occupied bandwidth measurement was performed at the output terminals of the EUT using an attenuator, power splitter and spectrum analyzer. The EUT was controlled via the Universal Radio Communication Tester R&S CMW500 selecting maximum transmission power of the EUT and different modes of modulation. The 99% occupied bandwidth and the -26 dBc bandwidth were measured directly using the built-in bandwidth measuring option of spectrum analyzer.

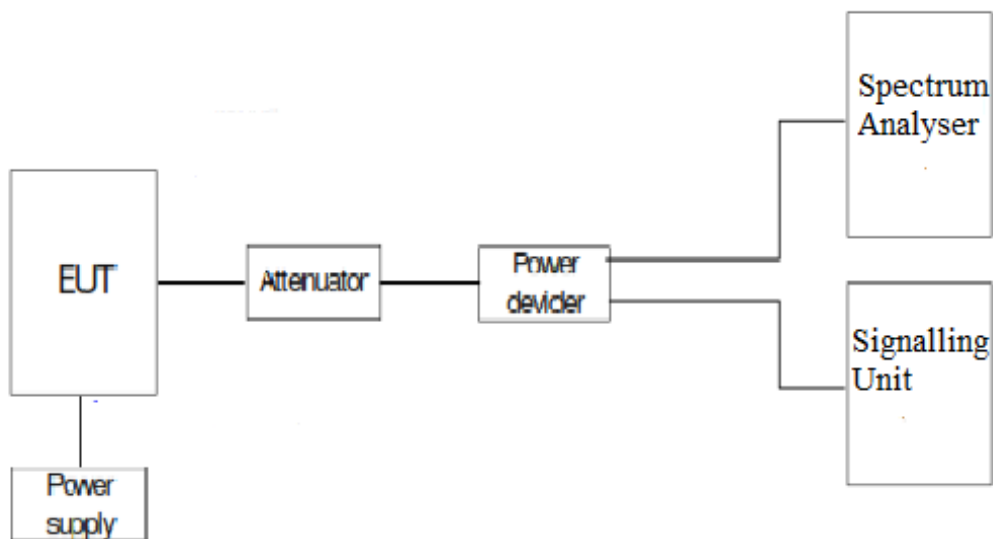

TESTED SAMPLES:	S/01
TESTED CONDITIONS MODES:	TC#01
TEST RESULTS:	PASS

LTE QPSK MODULATION. BW = 1.4 MHz

Channel	Lowest	Middle	Highest
99% Occupied bandwidth (MHz)	1.11	1.12	1.12
-26 dBc bandwidth (MHz)	1.27	1.28	1.28

LTE 16QAM MODULATION. BW = 1.4 MHz

Channel	Lowest	Middle	Highest
99% Occupied bandwidth (MHz)	1.11	1.10	1.11
-26 dBc bandwidth (MHz)	1.28	1.27	1.28

LTE QPSK MODULATION. BW = 3 MHz

Channel	Lowest	Middle	Highest
99% Occupied bandwidth (MHz)	2.74	2.74	2.74
-26 dBc bandwidth (MHz)	3.11	3.10	3.09

LTE 16QAM MODULATION. BW = 3 MHz

Channel	Lowest	Middle	Highest
99% Occupied bandwidth (MHz)	2.73	2.74	2.72
-26 dBc bandwidth (MHz)	3.10	3.10	3.10

LTE QPSK MODULATION. BW = 5 MHz

Channel	Lowest	Middle	Highest
99% Occupied bandwidth (MHz)	4.60	4.58	4.59
-26 dBc bandwidth (MHz)	5.21	5.15	5.14

LTE 16QAM MODULATION. BW = 5 MHz

Channel	Lowest	Middle	Highest
99% Occupied bandwidth (MHz)	4.57	4.56	4.56
-26 dBc bandwidth (MHz)	5.16	5.15	5.14

TEST RESULTS (Cont):

LTE QPSK MODULATION. BW = 10 MHz

Channel	Lowest	Middle	Highest
99% Occupied bandwidth (MHz)	9.00	8.98	9.04
-26 dBc bandwidth (MHz)	9.98	9.90	9.99

LTE 16QAM MODULATION. BW = 10 MHz

Channel	Lowest	Middle	Highest
99% Occupied bandwidth (MHz)	9.00	8.98	9.00
-26 dBc bandwidth (MHz)	9.95	9.90	9.93

LTE QPSK MODULATION. BW = 15 MHz

Channel	Lowest	Middle	Highest
99% Occupied bandwidth (MHz)	13.38	13.41	13.41
-26 dBc bandwidth (MHz)	14.67	14.59	14.50

LTE 16QAM MODULATION. BW = 15 MHz

Channel	Lowest	Middle	Highest
99% Occupied bandwidth (MHz)	13.41	13.41	13.38
-26 dBc bandwidth (MHz)	14.58	14.67	14.59

LTE QPSK MODULATION. BW = 20 MHz

Channel	Lowest	Middle	Highest
99% Occupied bandwidth (MHz)	17.84	17.84	17.84
-26 dBc bandwidth (MHz)	19.27	19.14	19.16

LTE 16QAM MODULATION. BW = 20 MHz

Channel	Lowest	Middle	Highest
99% Occupied bandwidth (MHz)	17.84	17.88	17.80
-26 dBc bandwidth (MHz)	19.21	19.25	19.22

TEST RESULTS (Cont):

LTE QPSK MODULATION. BW = 1.4 MHz

Lowest Channel 99% Occupied Bandwidth

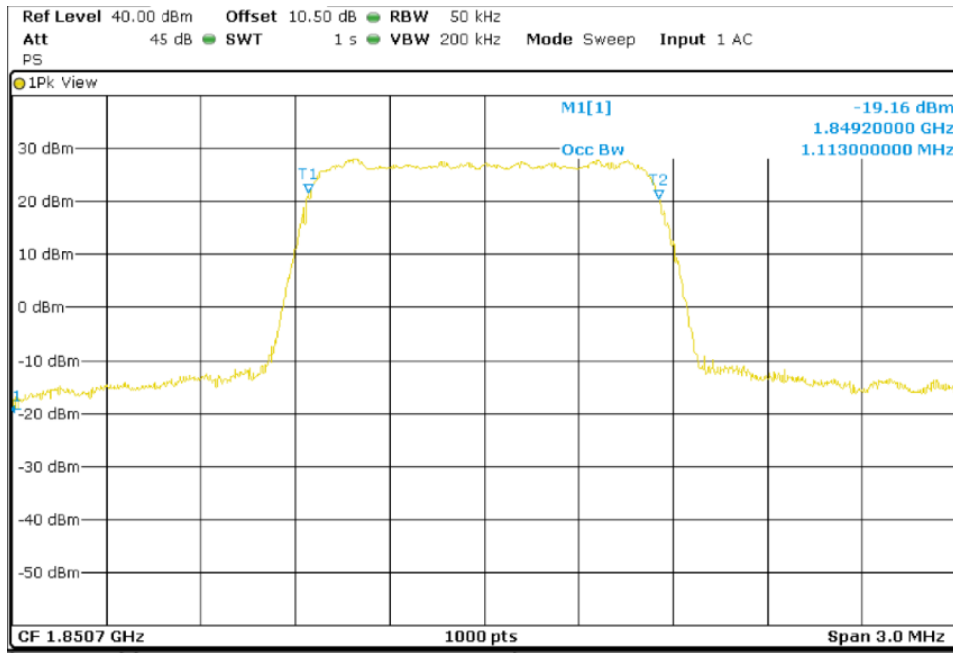

Lowest Channel -26dBc Bandwidth kHz

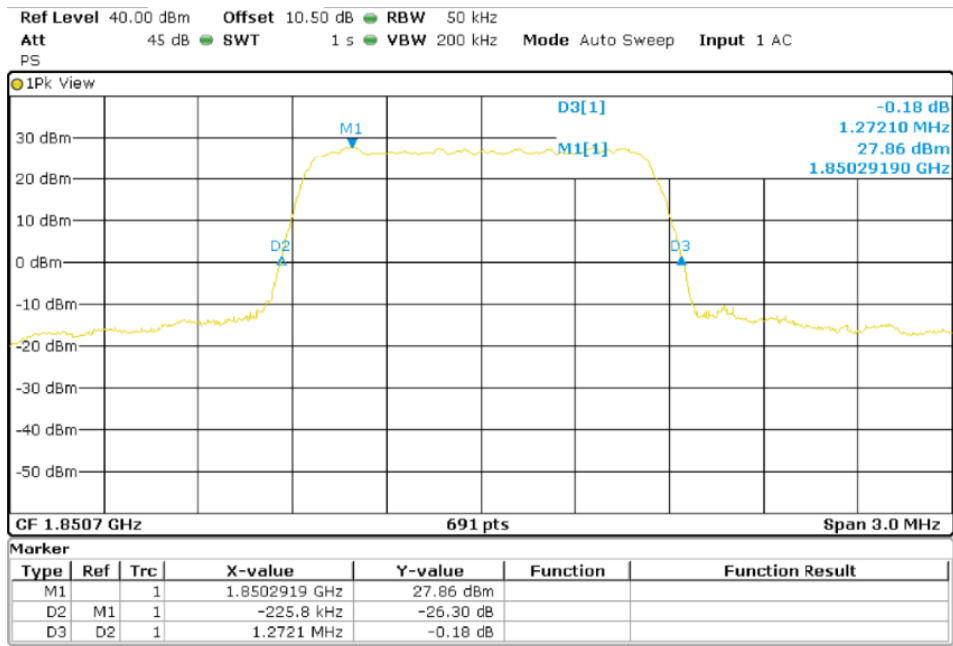

TEST RESULTS (Cont):

Middle Channel 99% Occupied Bandwidth

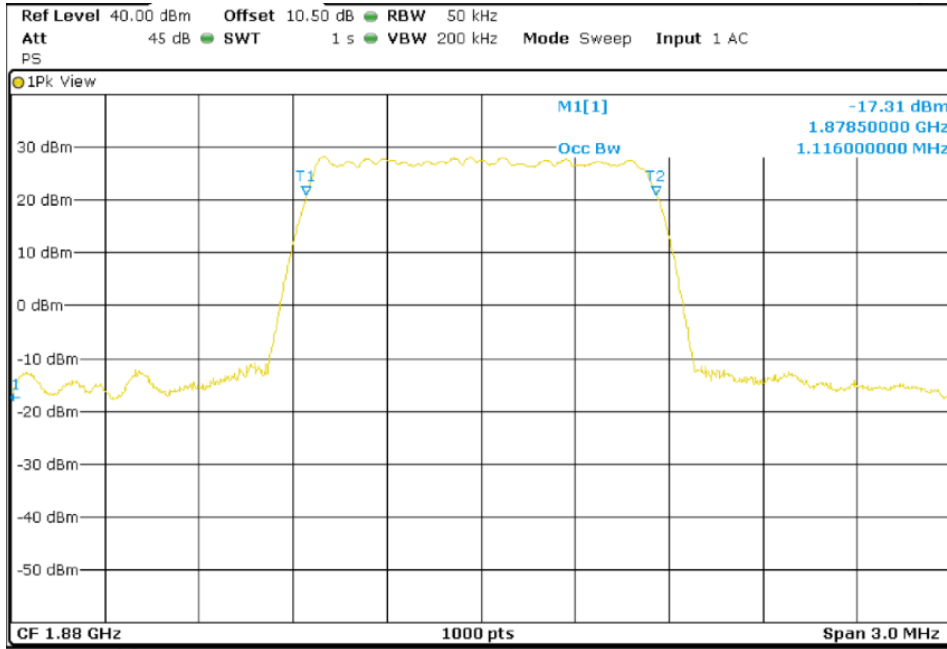

Middle Channel -26dBc Bandwidth kHz

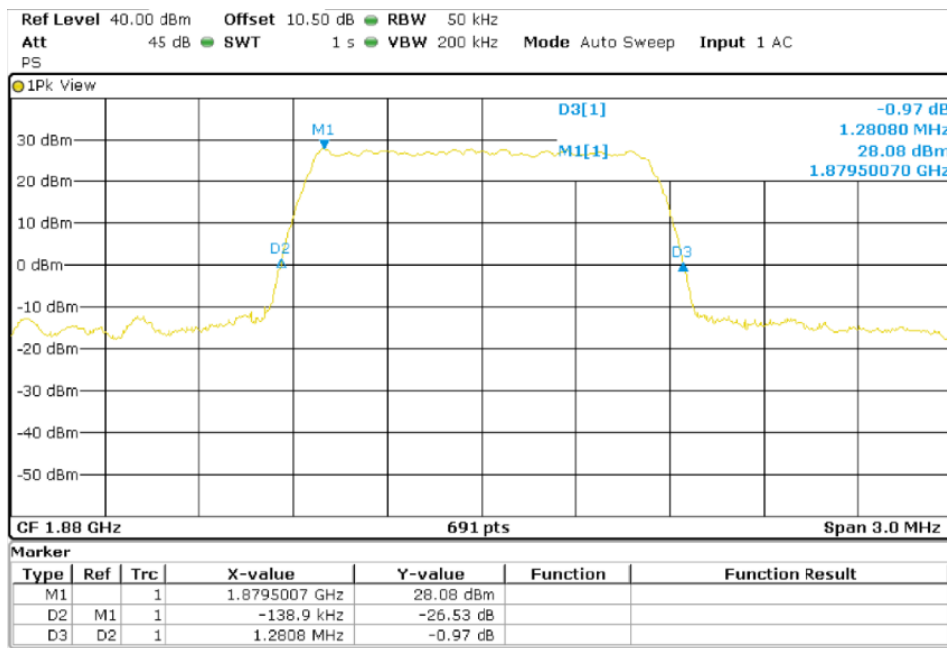

TEST RESULTS (Cont):

Highest Channel 99% Occupied Bandwidth

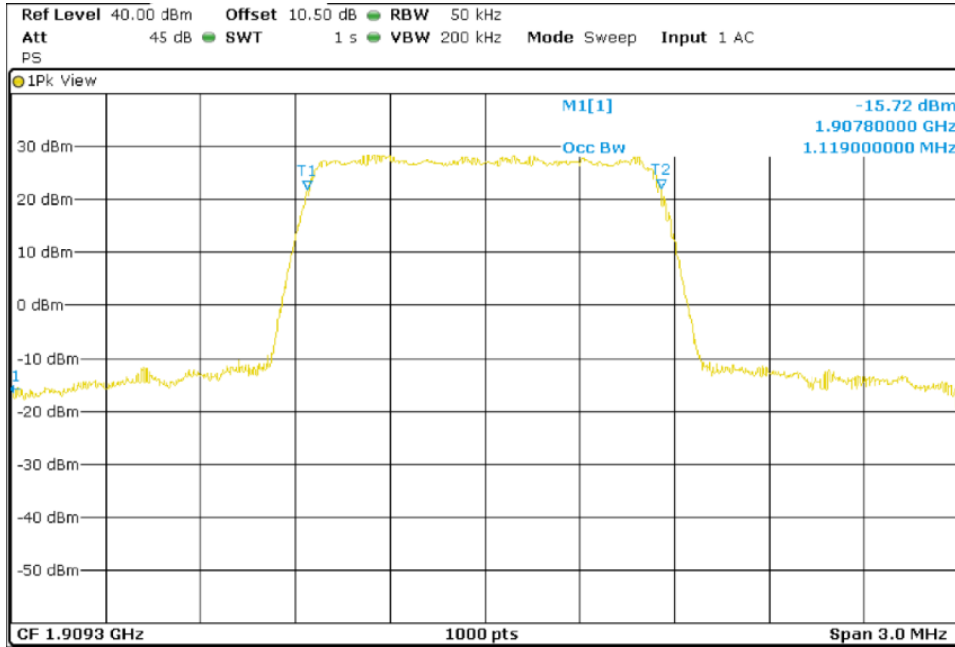

Highest Channel -26dBc Bandwidth kHz

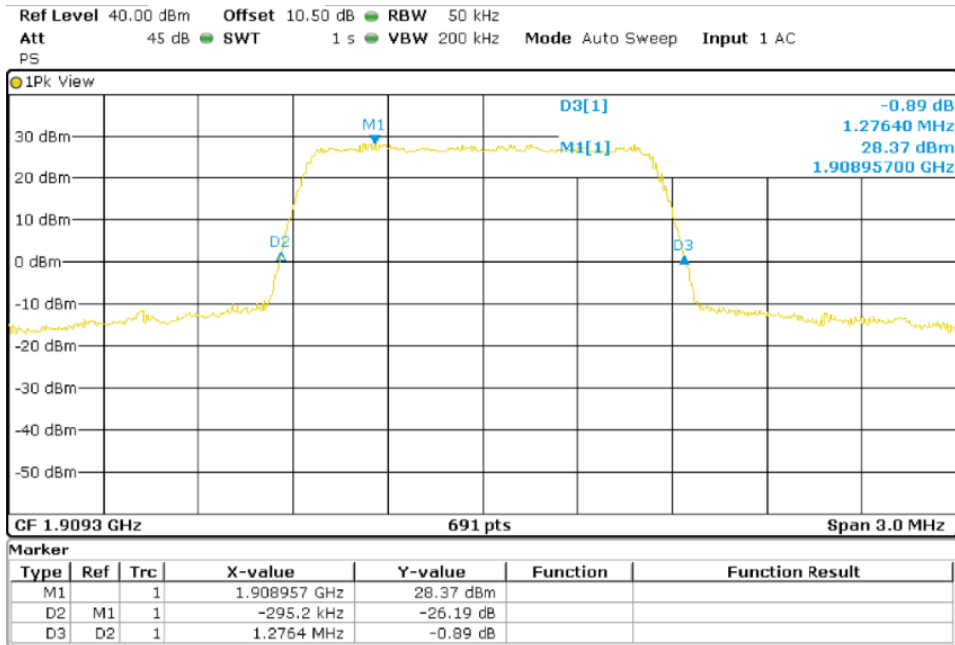

TEST RESULTS (Cont):

LTE 16QAM MODULATION. BW = 1.4 MHz

Lowest Channel 99% Occupied Bandwidth

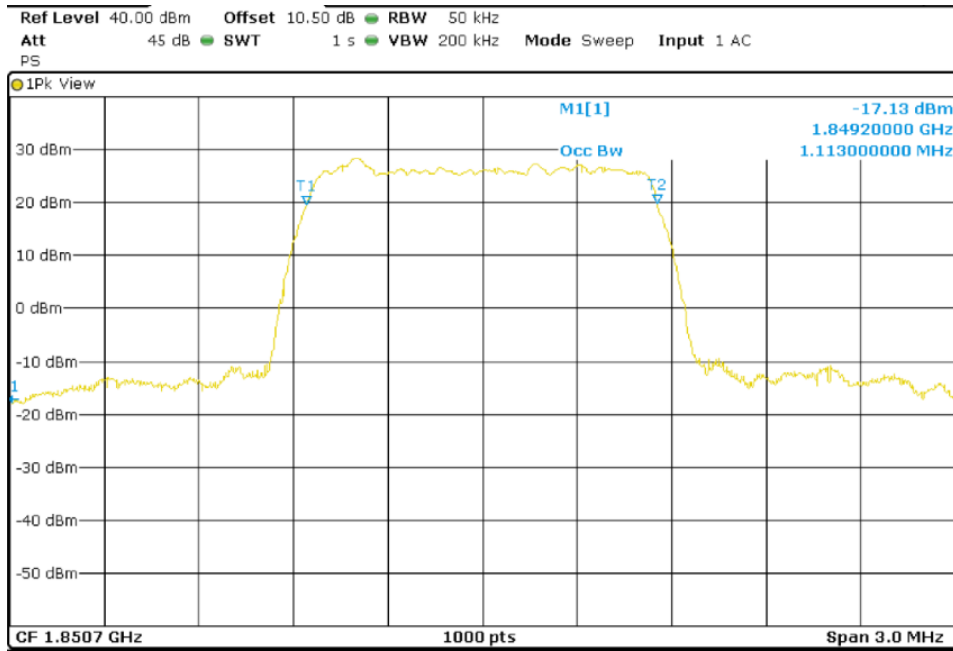

Lowest Channel -26dBc Bandwidth kHz

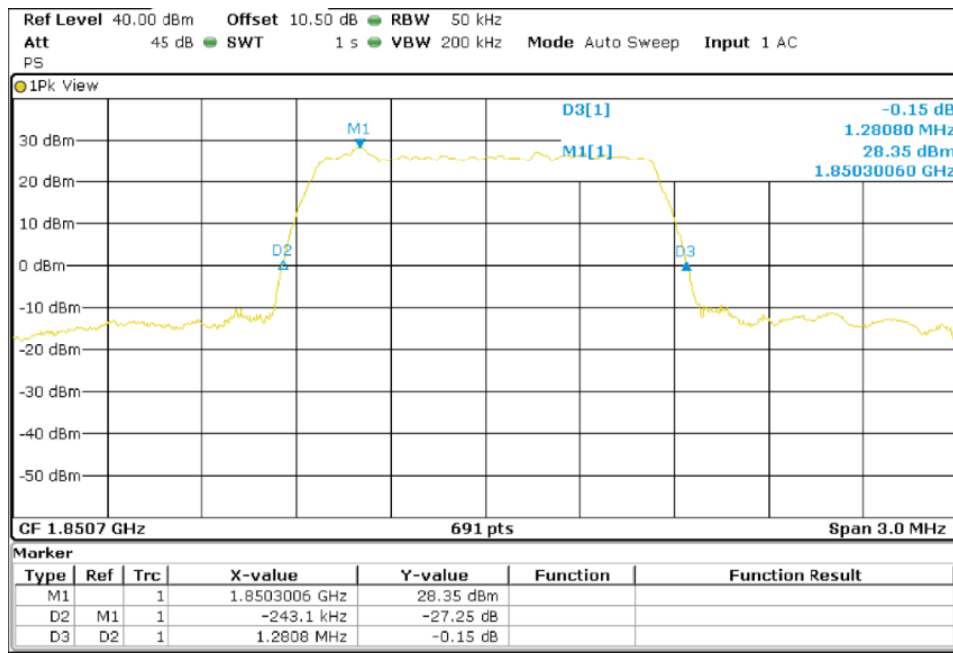

TEST RESULTS (Cont):

Middle Channel 99% Occupied Bandwidth

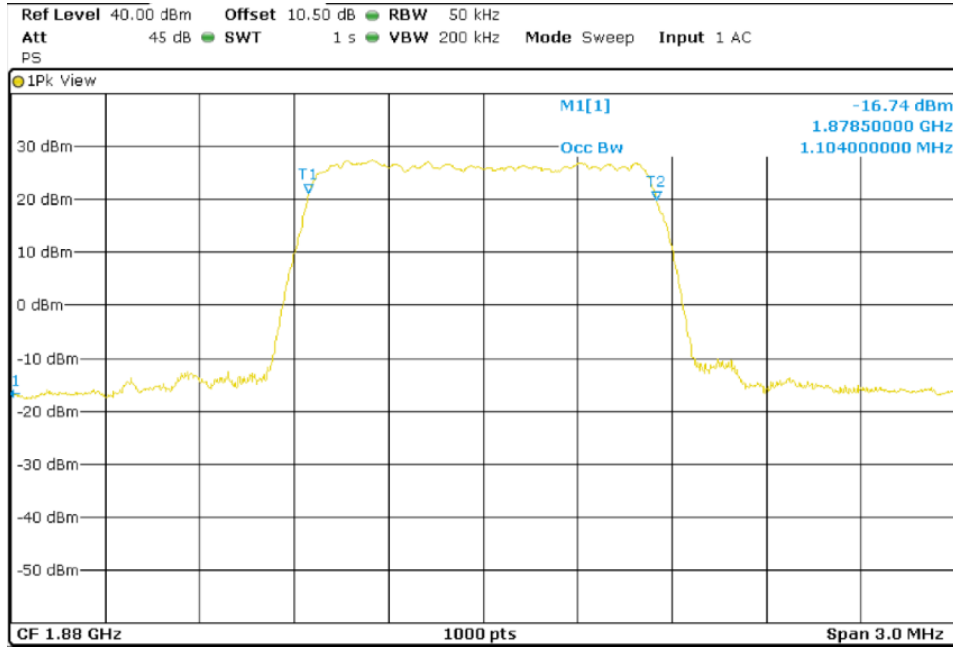

Middle Channel -26dBc Bandwidth kHz

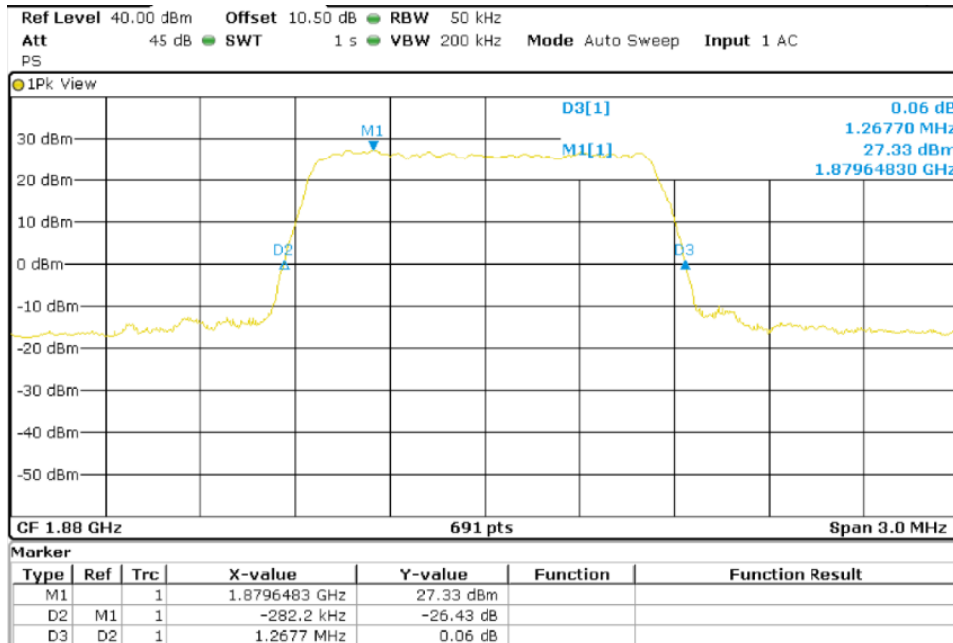

TEST RESULTS (Cont):

Highest Channel 99% Occupied Bandwidth

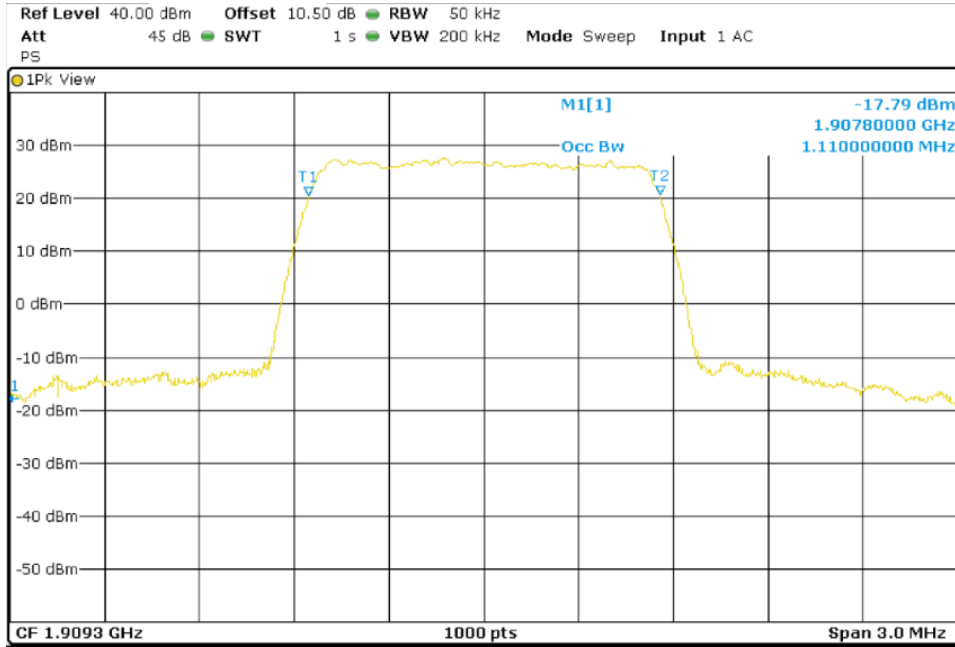

Highest Channel -26dBc Bandwidth kHz

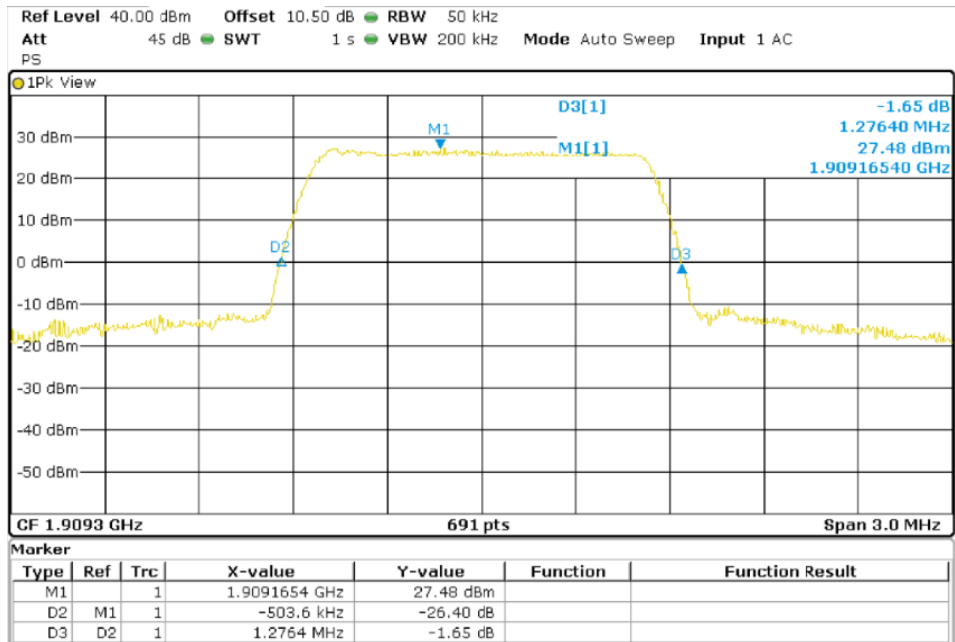

TEST RESULTS (Cont):

LTE QPSK MODULATION. BW = 3 MHz

Lowest Channel 99% Occupied Bandwidth

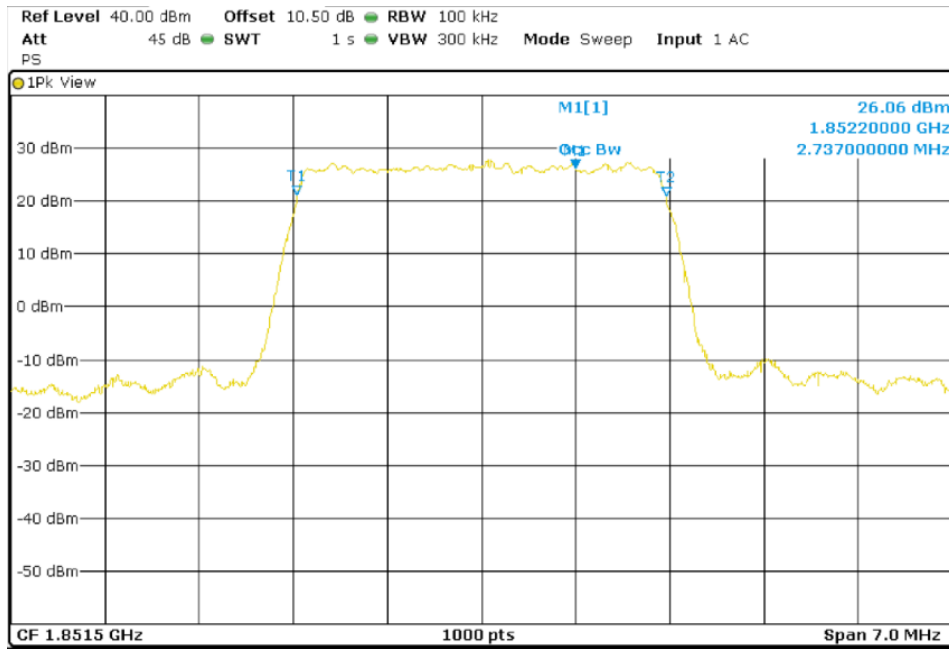

Lowest Channel -26dBc Bandwidth kHz

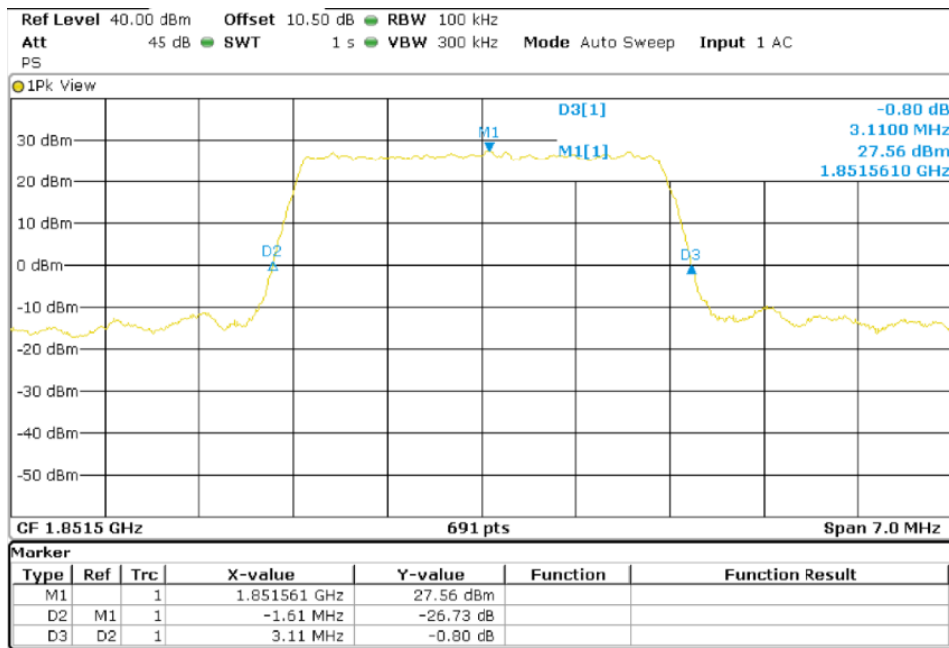

TEST RESULTS (Cont):

Middle Channel 99% Occupied Bandwidth

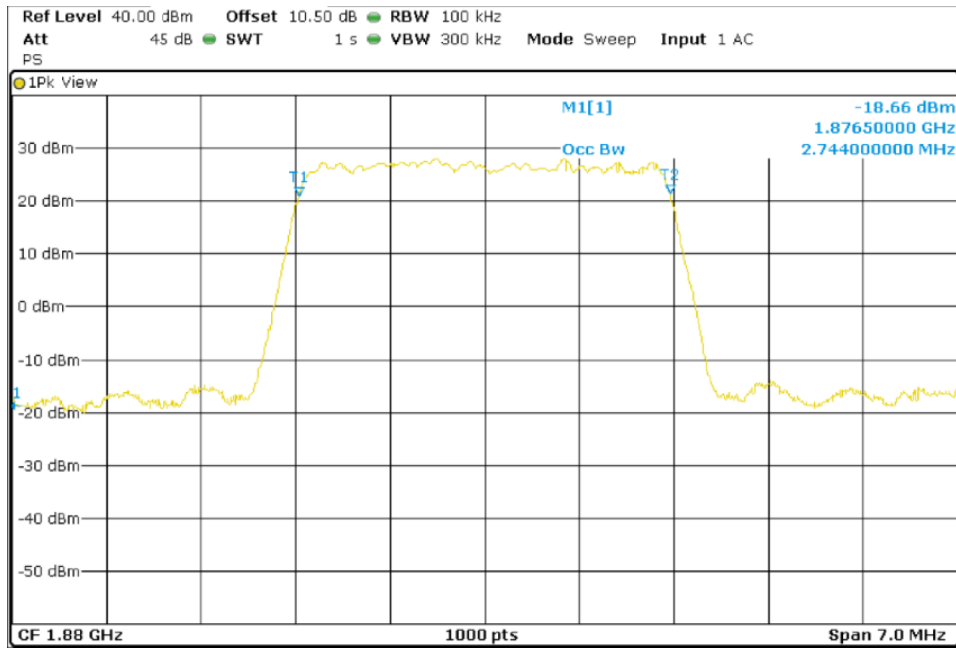

Middle Channel -26dBc Bandwidth kHz

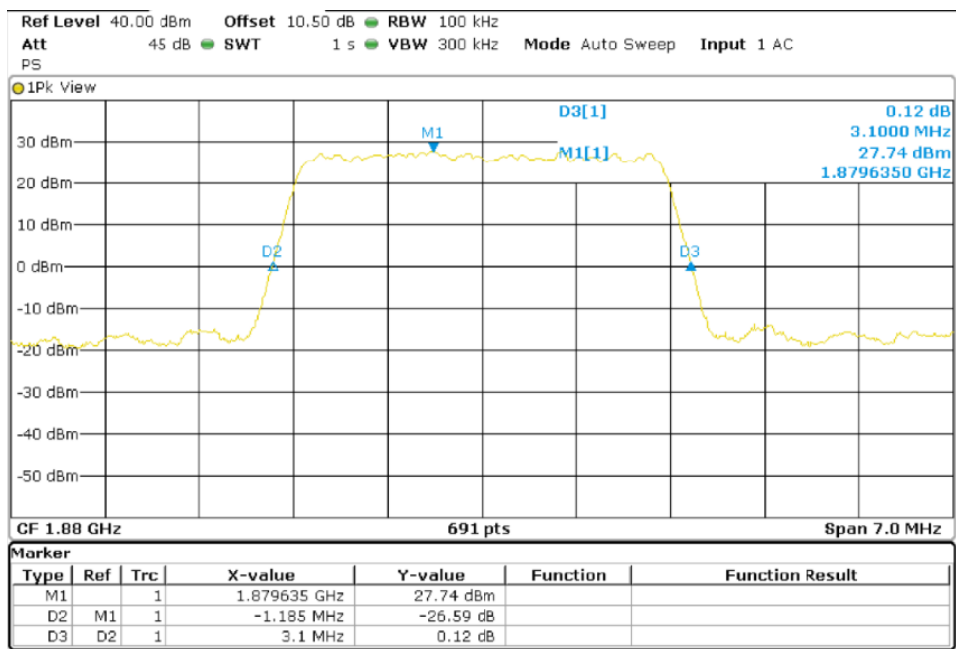

TEST RESULTS (Cont):

Highest Channel 99% Occupied Bandwidth

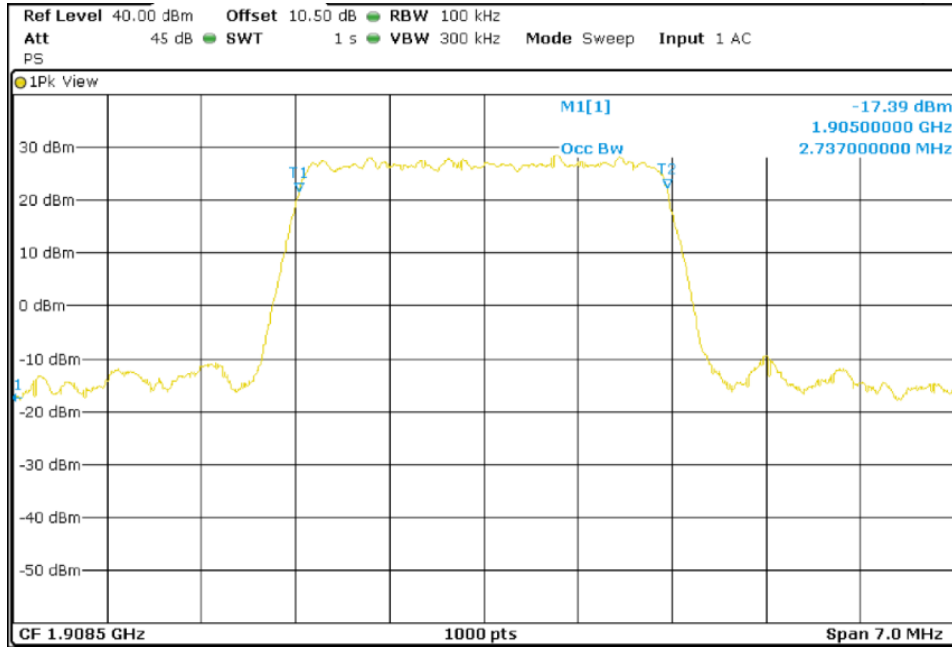

Highest Channel -26dBc Bandwidth kHz

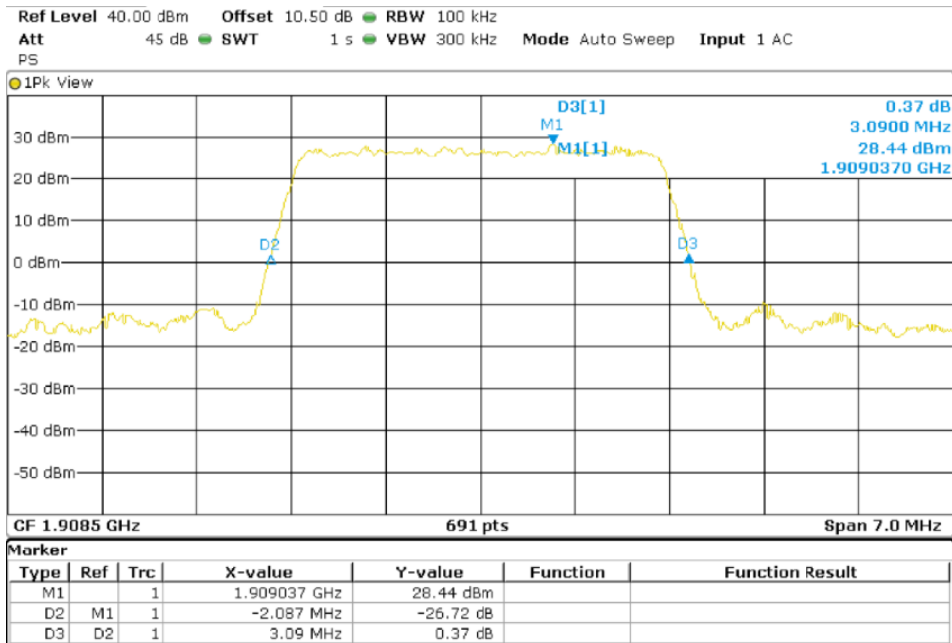

TEST RESULTS (Cont):

LTE 16QAM MODULATION. BW = 3 MHz

Lowest Channel 99% Occupied Bandwidth

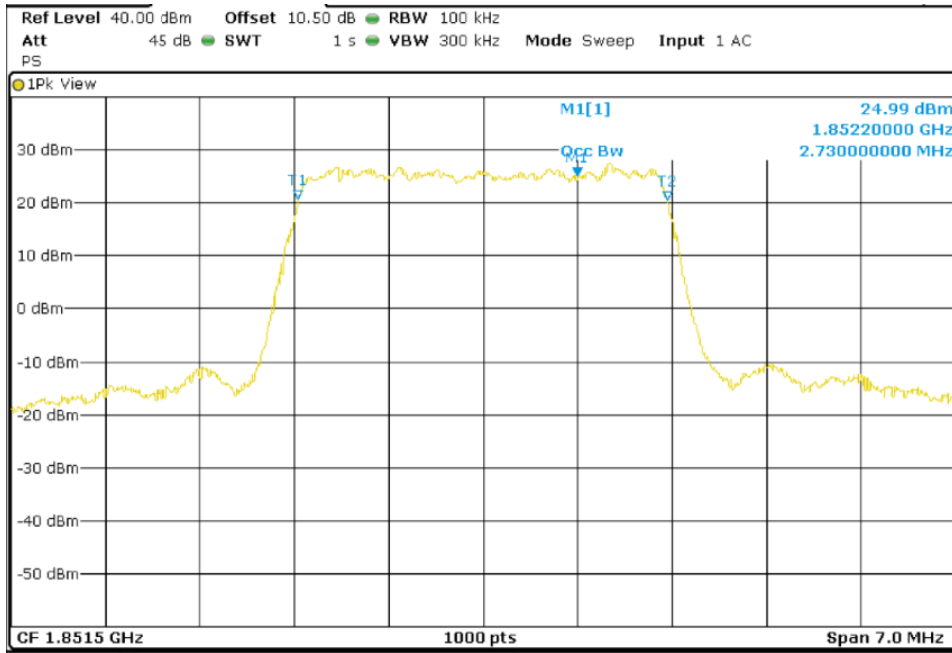

Lowest Channel -26dBc Bandwidth kHz

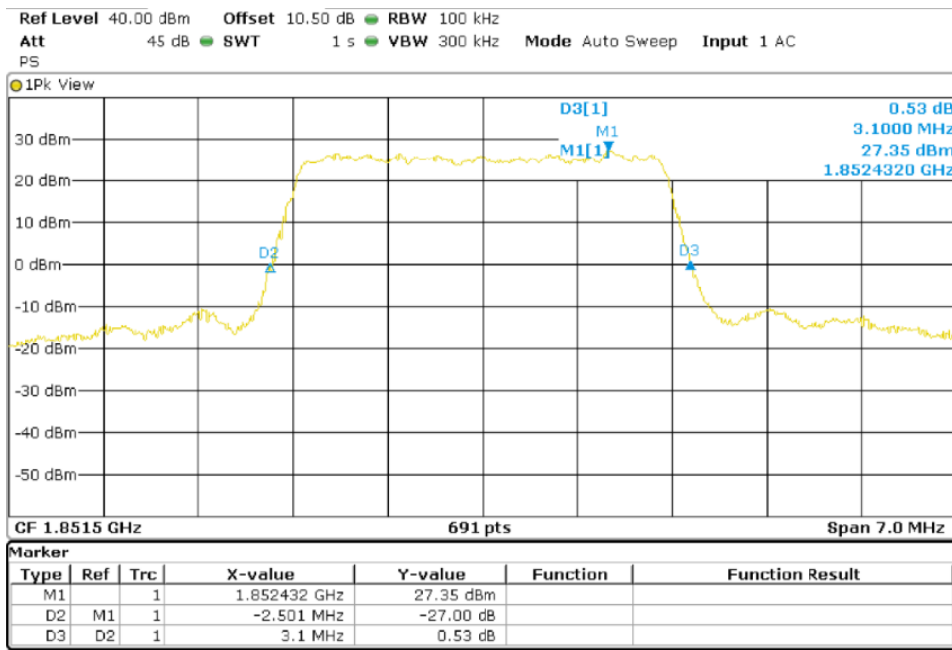

TEST RESULTS (Cont):

Middle Channel 99% Occupied Bandwidth

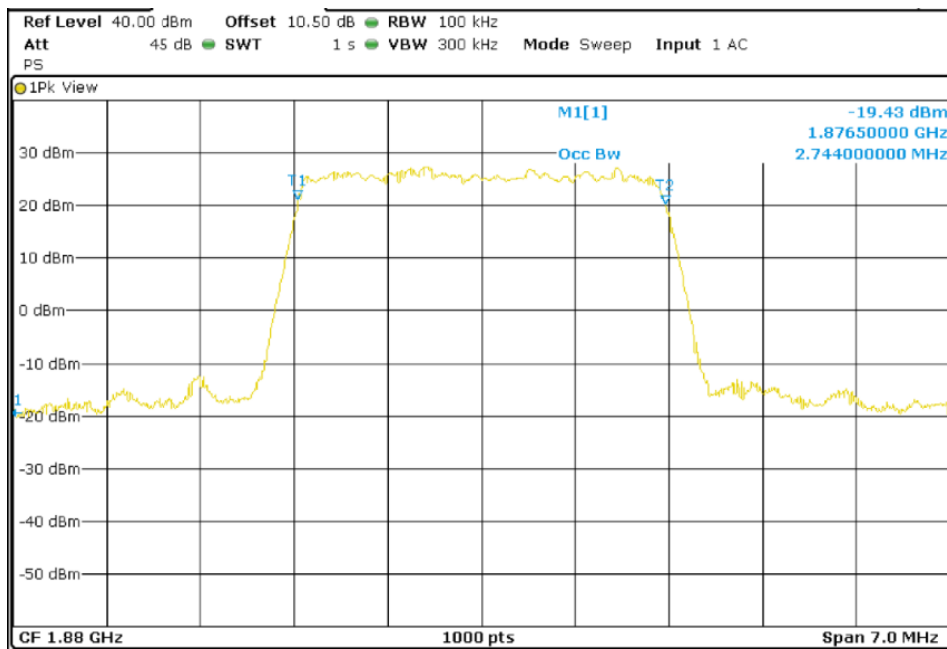

Middle Channel -26dBc Bandwidth kHz

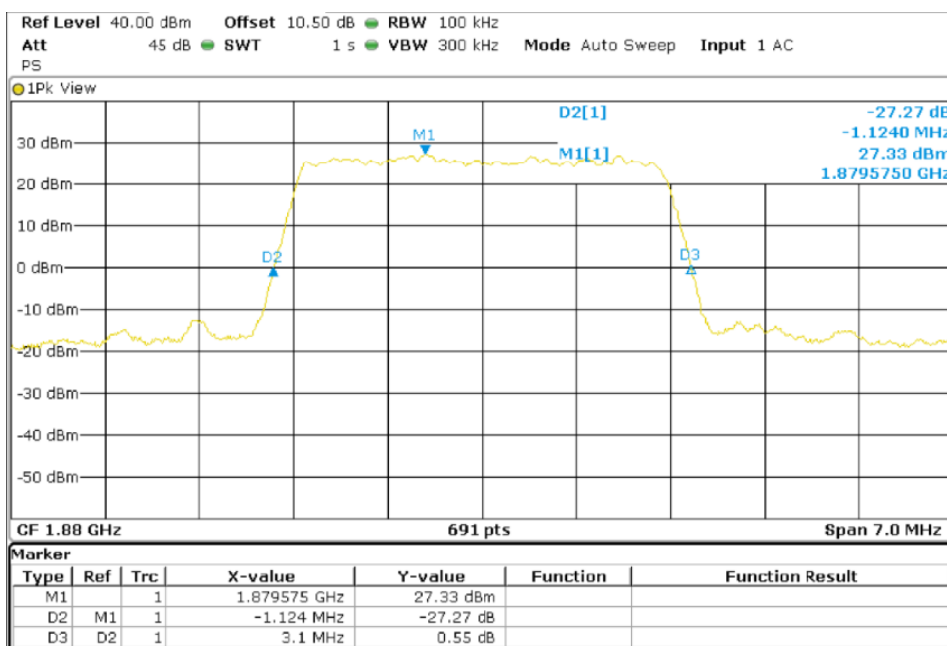

TEST RESULTS (Cont):

Highest Channel 99% Occupied Bandwidth

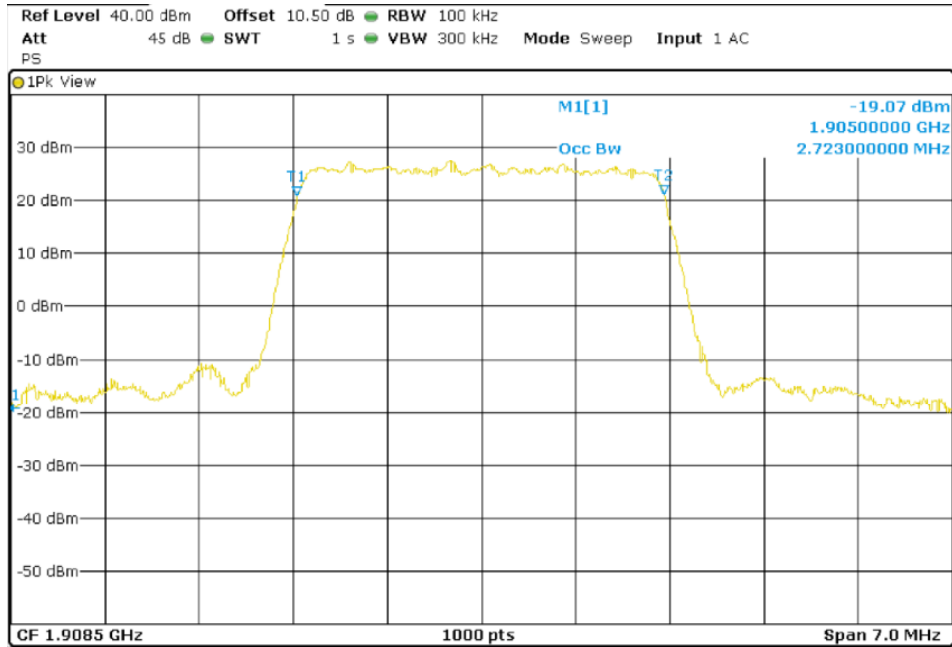

Highest Channel -26dBc Bandwidth kHz

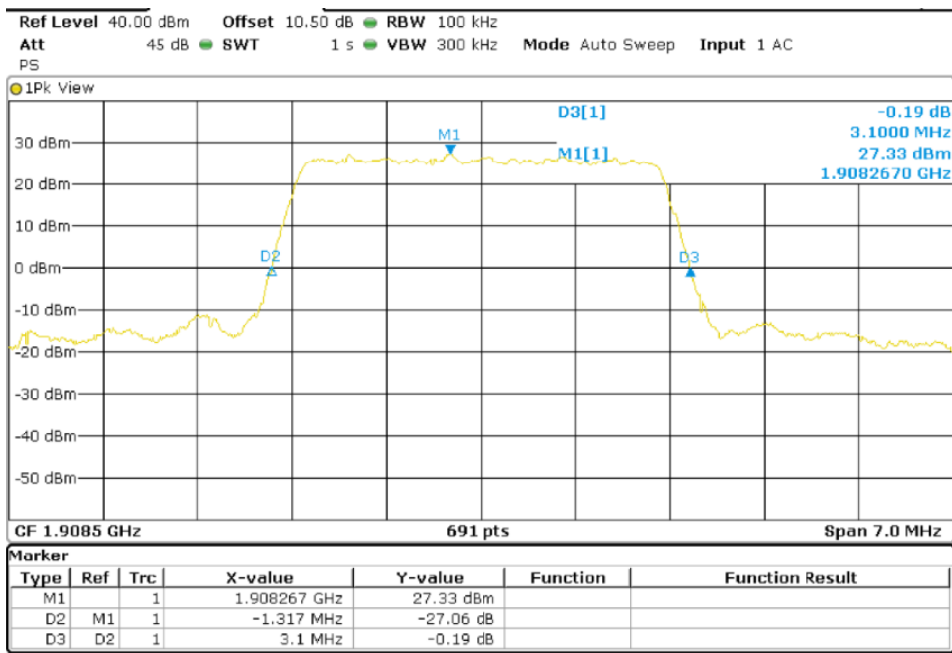

TEST RESULTS (Cont):

LTE QPSK MODULATION. BW = 5 MHz

Lowest Channel 99% Occupied Bandwidth

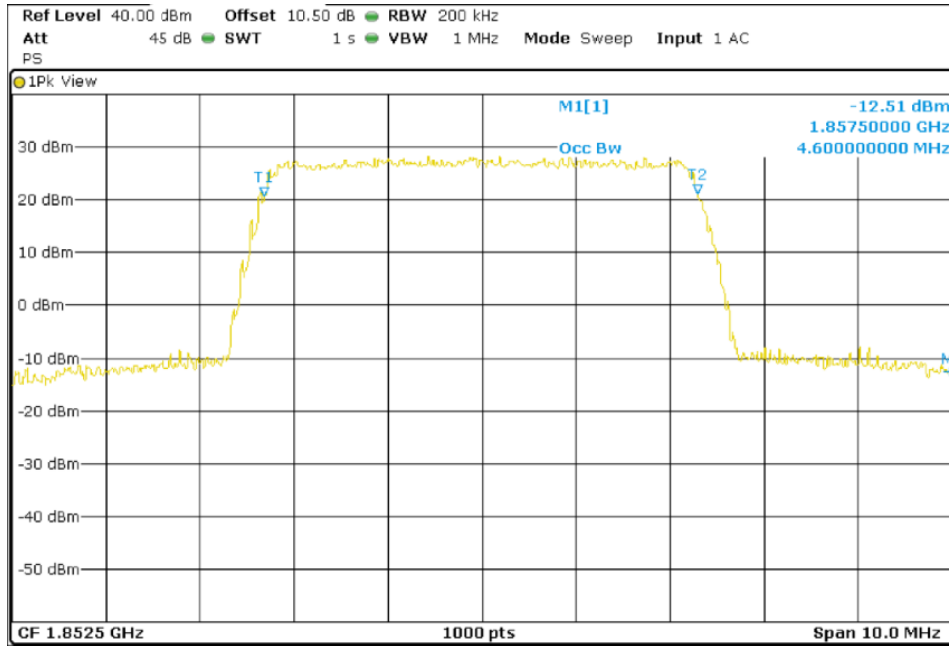

Lowest Channel -26dBc Bandwidth kHz

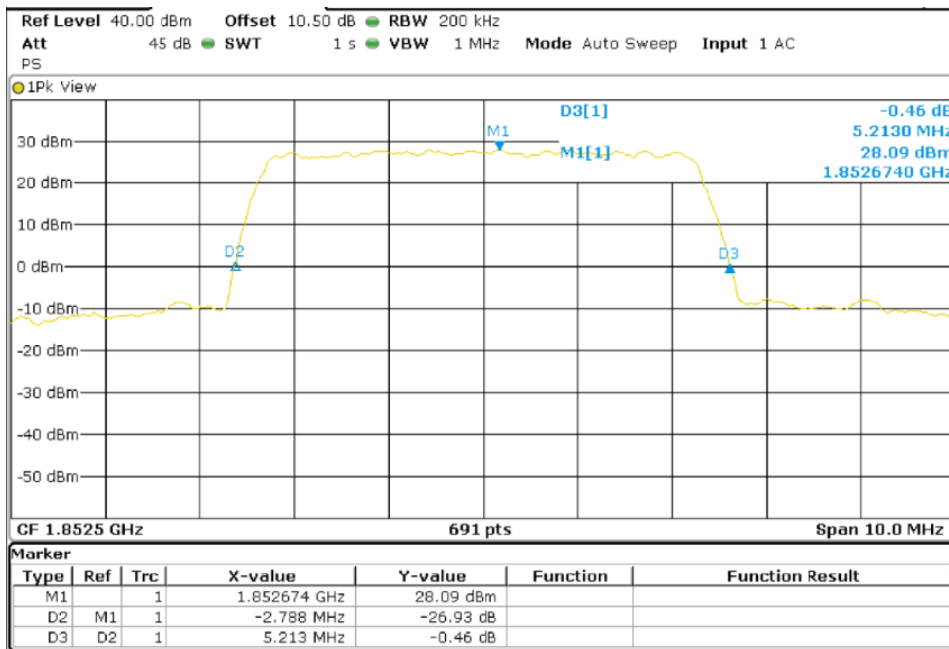

TEST RESULTS (Cont):

Middle Channel 99% Occupied Bandwidth

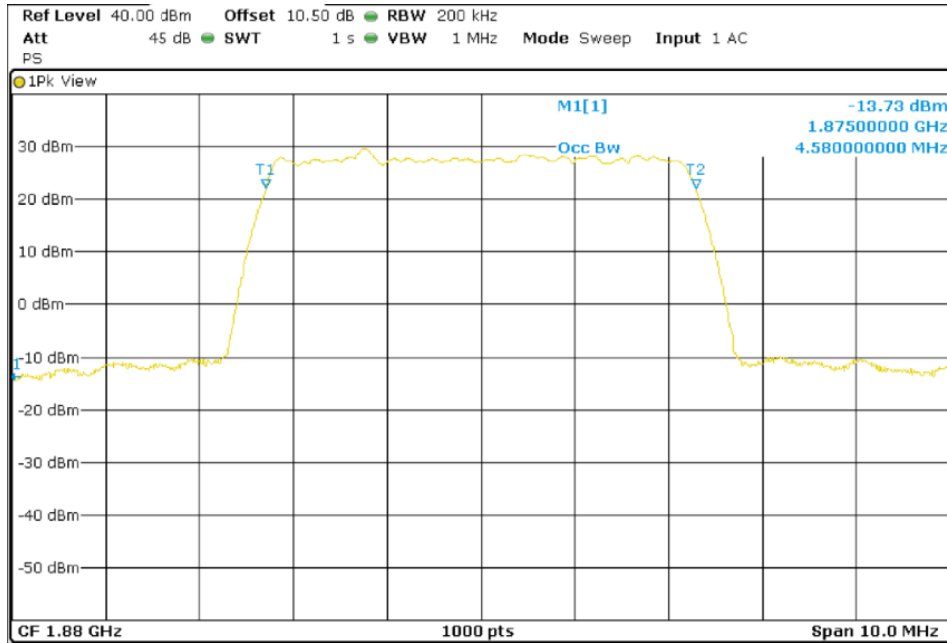

Middle Channel -26dBc Bandwidth kHz

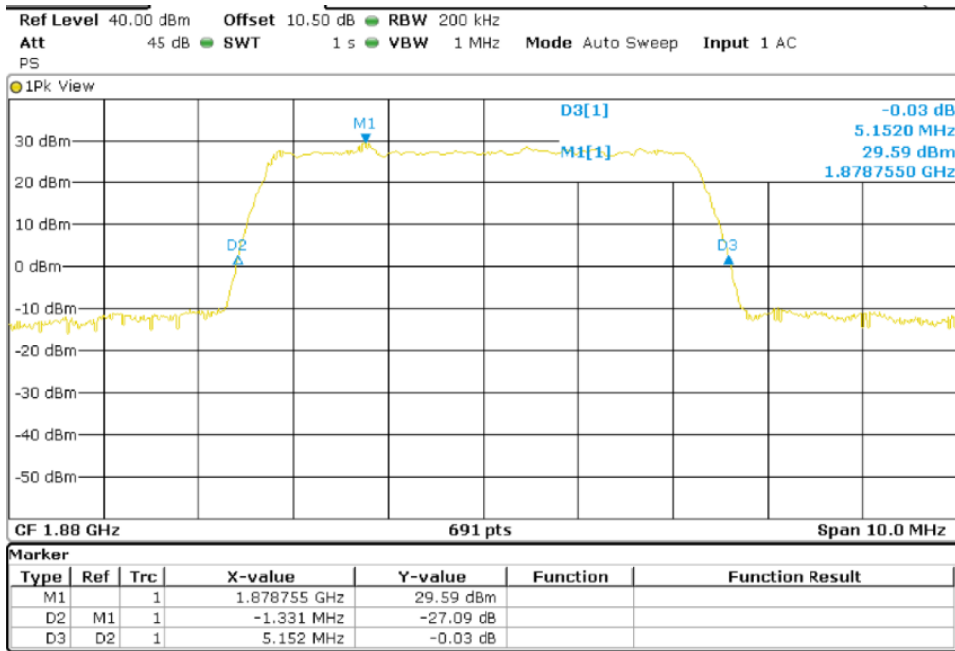

TEST RESULTS (Cont):

Highest Channel 99% Occupied Bandwidth

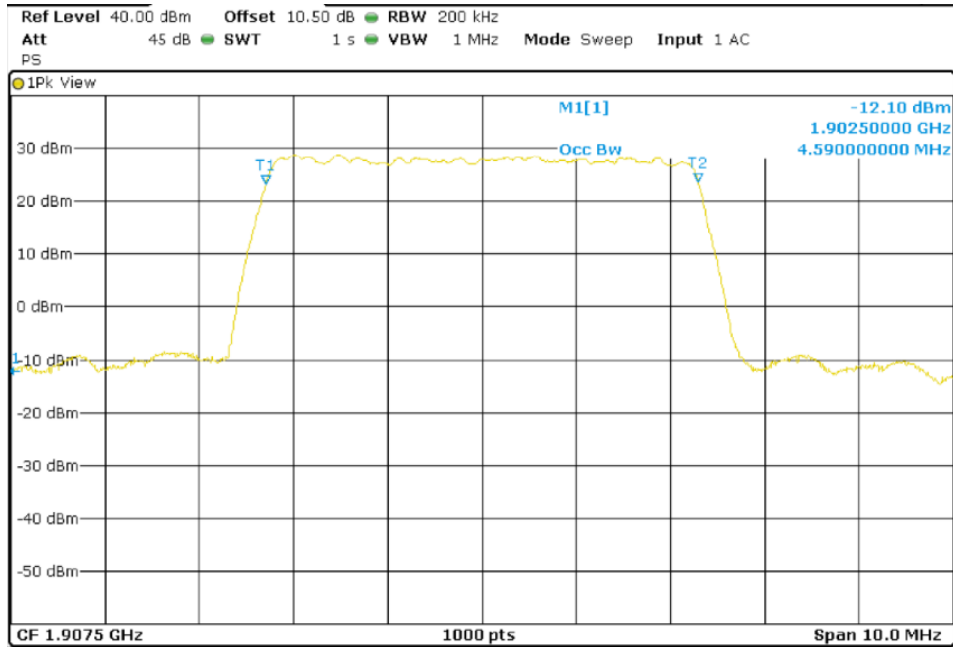

Highest Channel -26dBc Bandwidth kHz

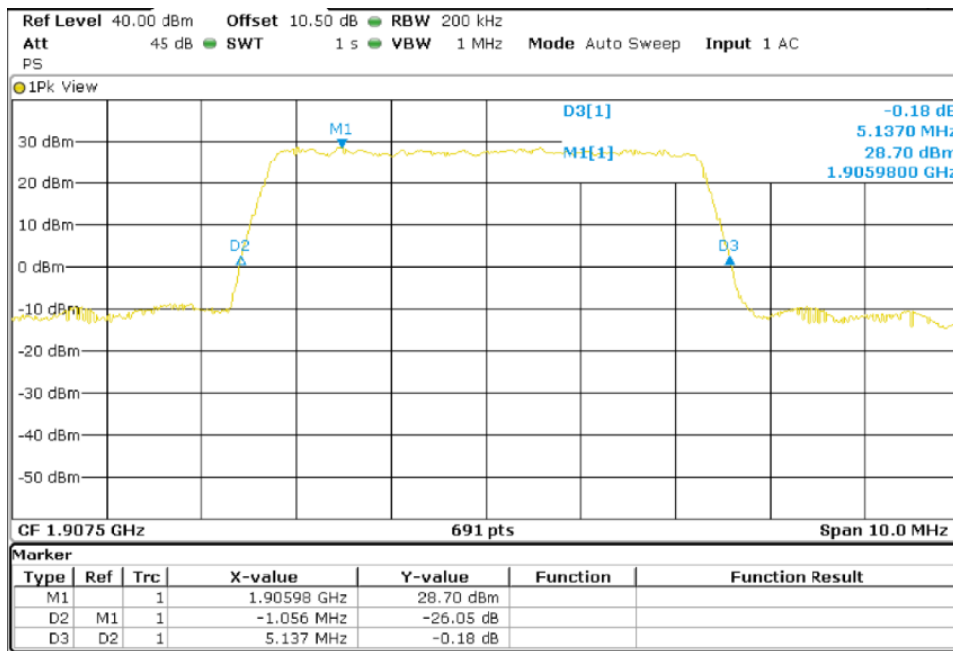

TEST RESULTS (Cont):

LTE 16QAM MODULATION. BW = 5 MHz

Lowest Channel 99% Occupied Bandwidth

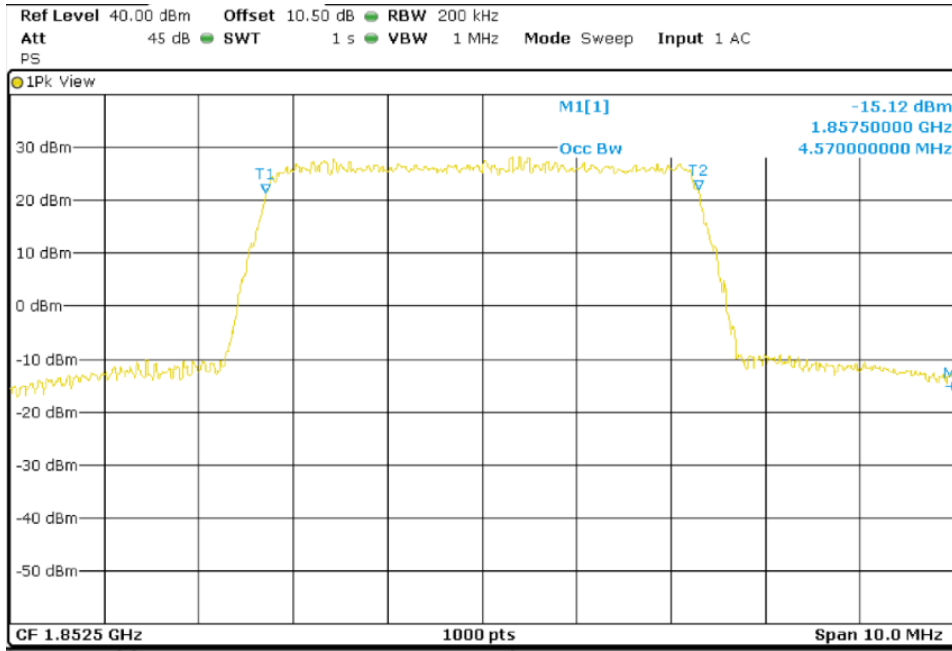

Lowest Channel -26dBc Bandwidth kHz

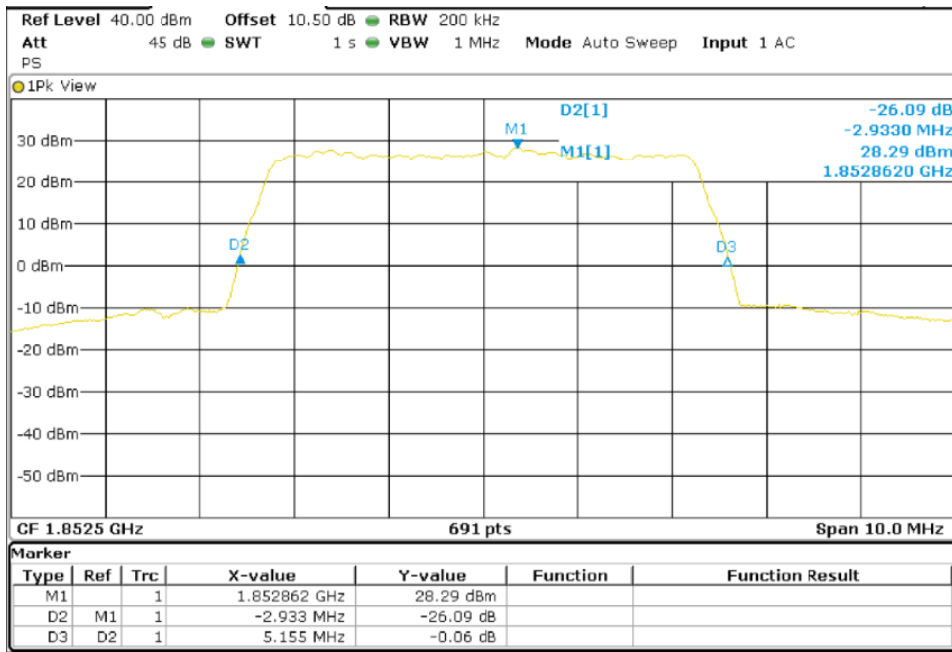

TEST RESULTS (Cont):

Middle Channel 99% Occupied Bandwidth

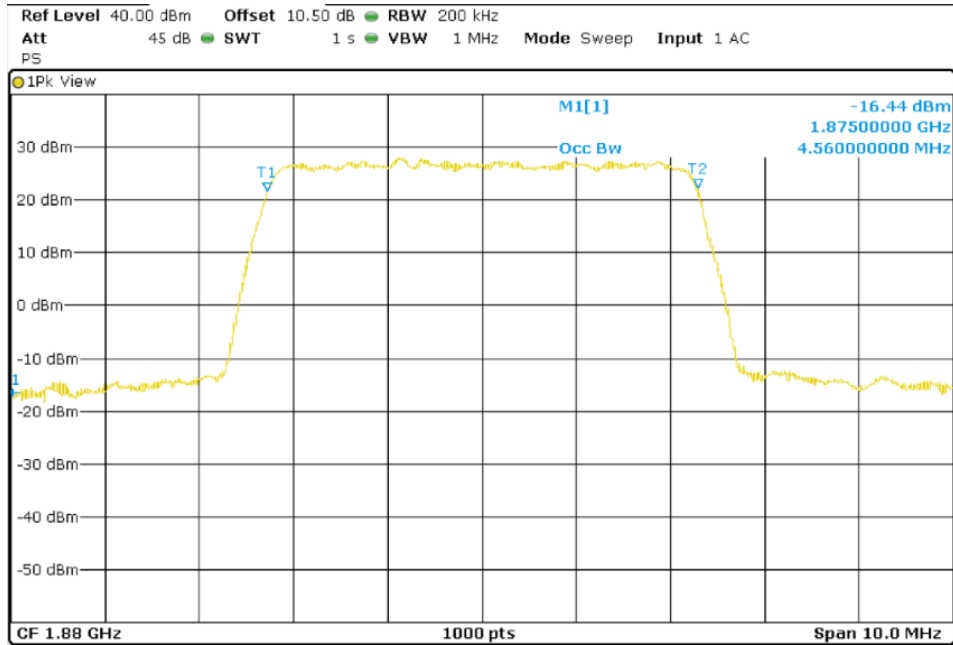

Middle Channel -26dBc Bandwidth kHz

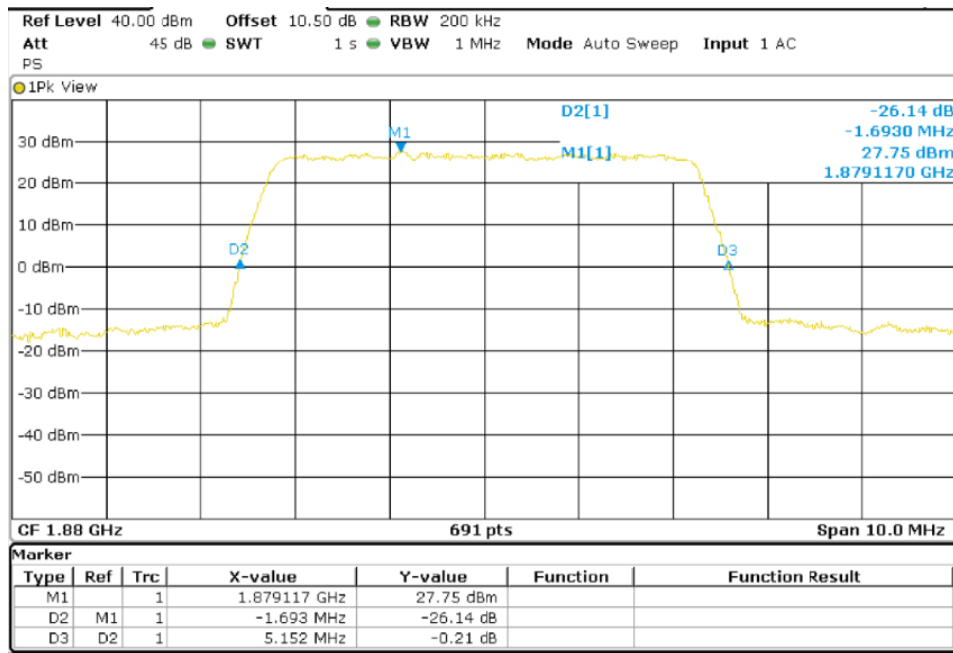

TEST RESULTS (Cont):

Highest Channel 99% Occupied Bandwidth

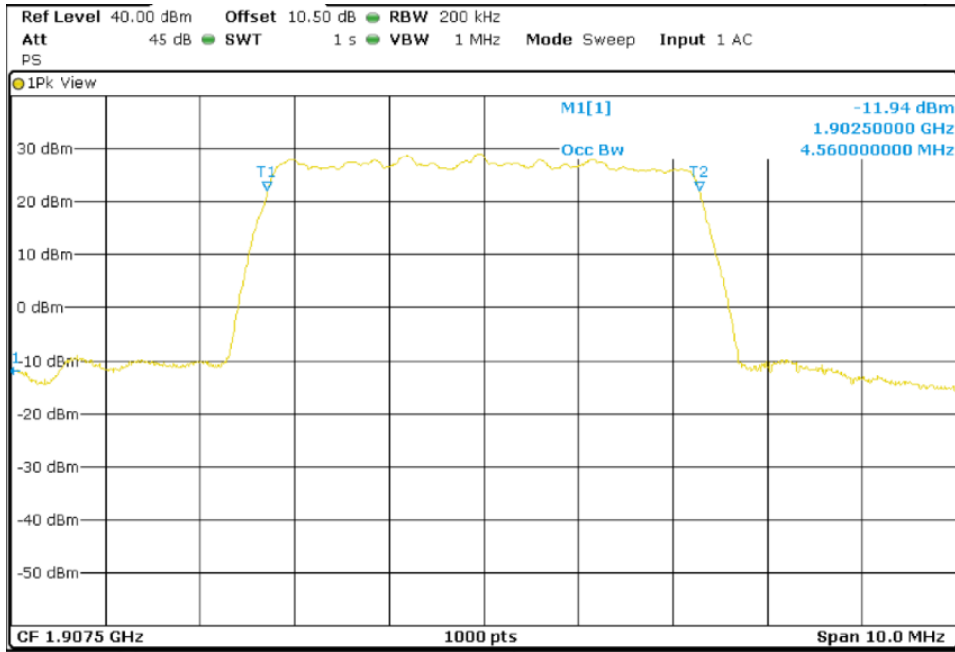

Highest Channel -26dBc Bandwidth kHz

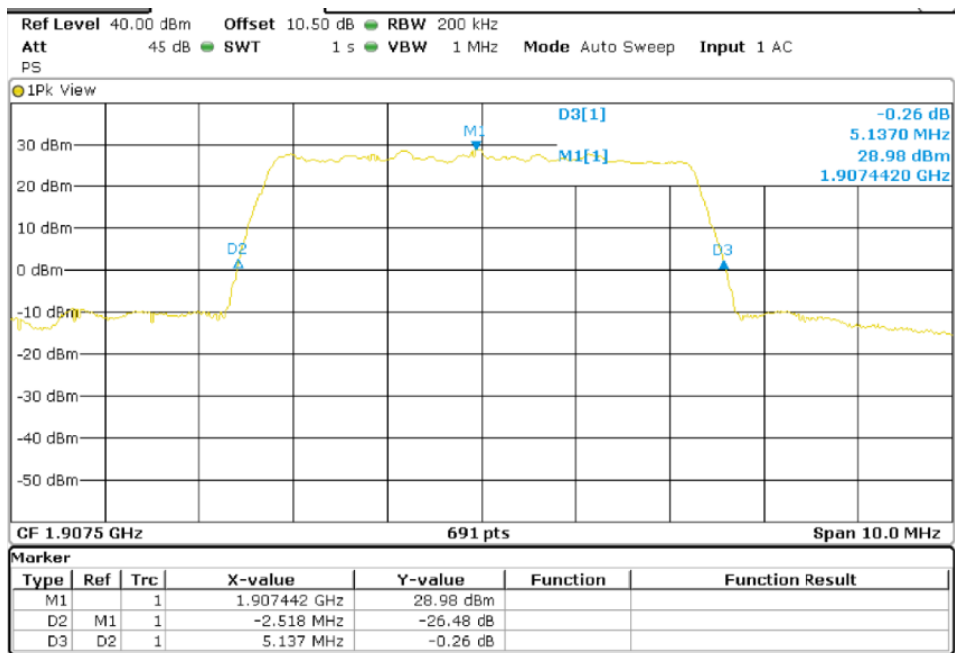

TEST RESULTS (Cont):

LTE QPSK MODULATION. BW = 10 MHz
 Lowest Channel 99% Occupied Bandwidth

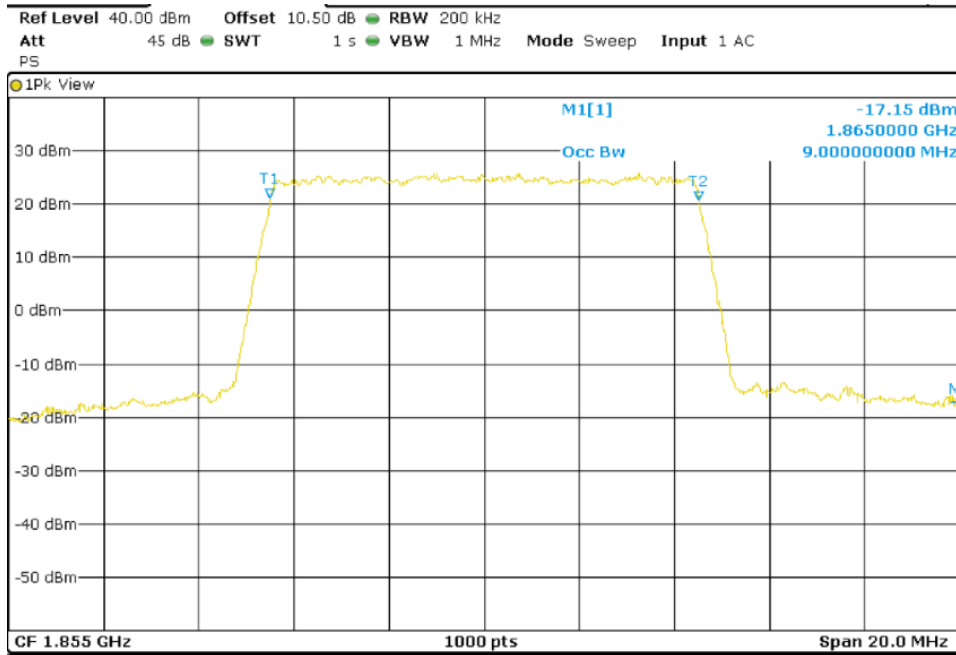

Lowest Channel -26dBc Bandwidth kHz

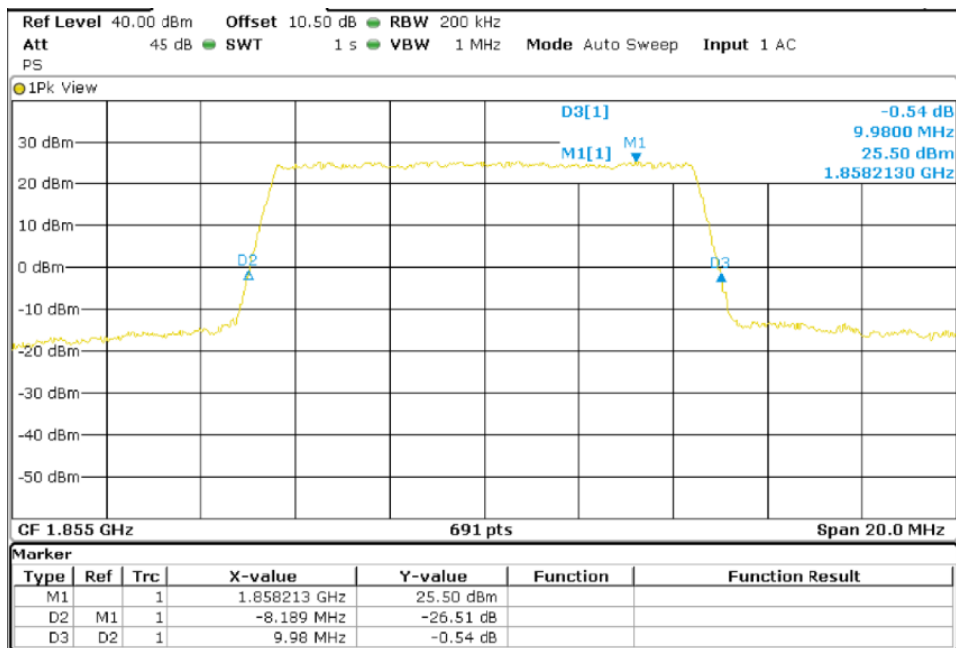

TEST RESULTS (Cont):

Middle Channel 99% Occupied Bandwidth

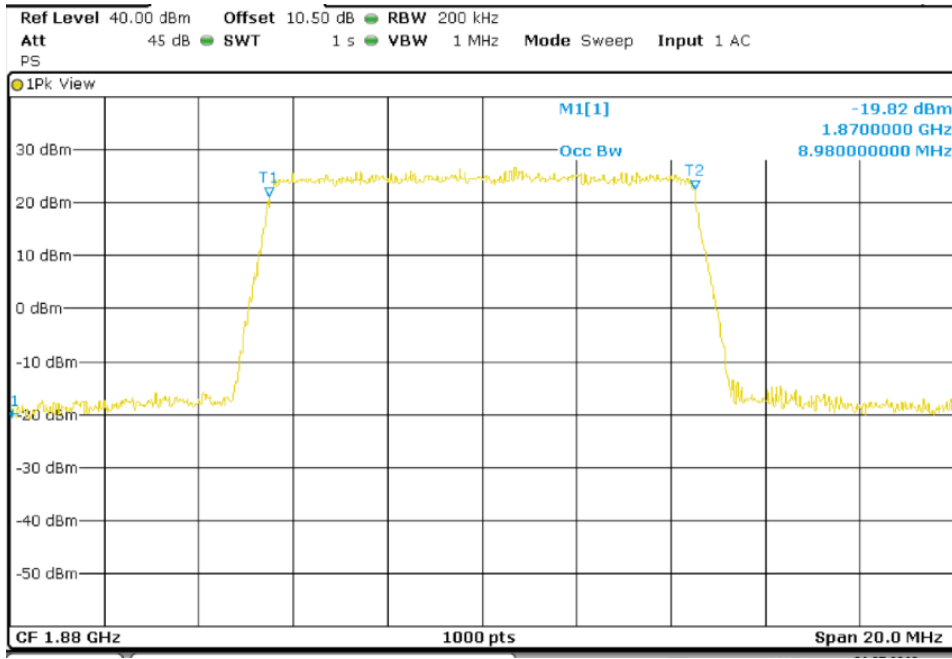

Middle Channel -26dBc Bandwidth kHz

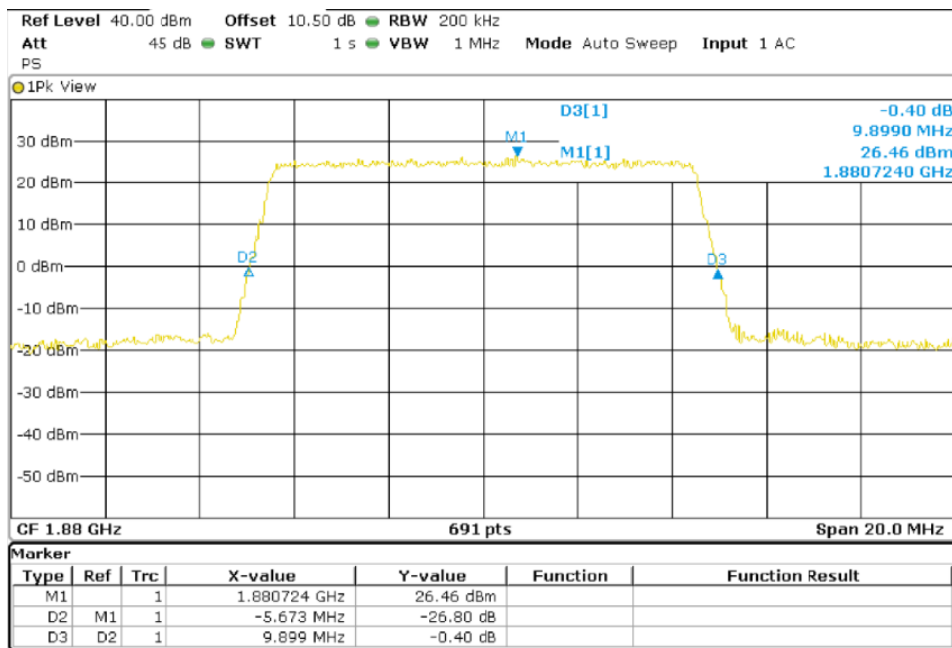

TEST RESULTS (Cont):

Highest Channel 99% Occupied Bandwidth

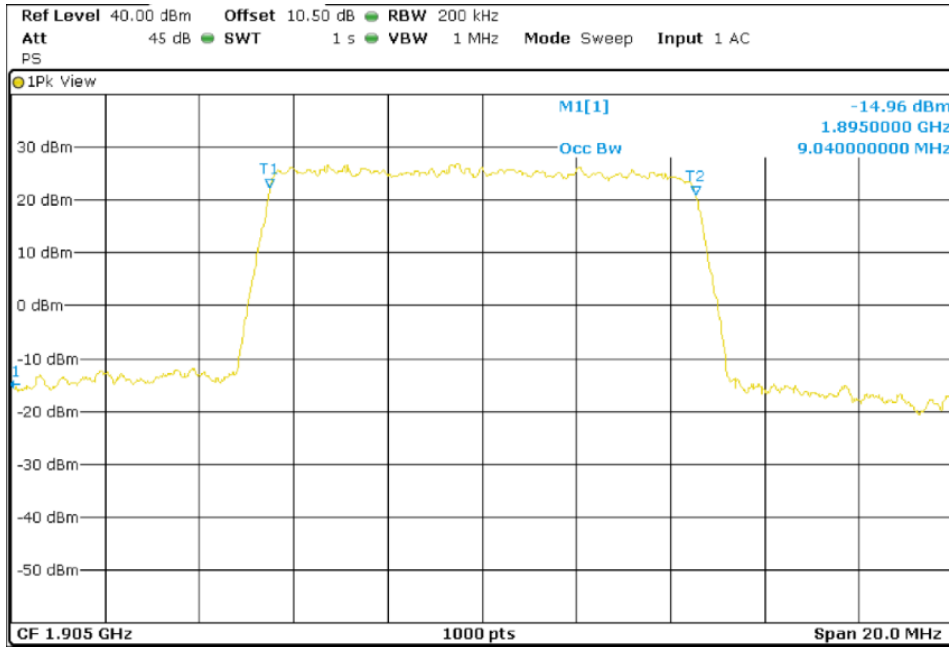

Highest Channel -26dBc Bandwidth kHz

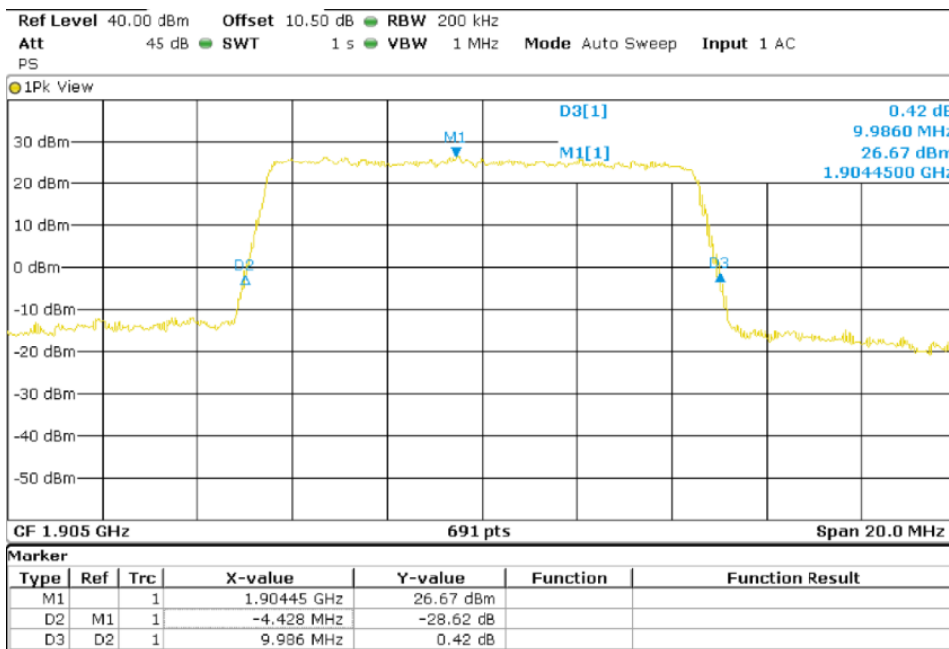

TEST RESULTS (Cont):

LTE 16QAM MODULATION. BW = 10 MHz

Lowest Channel 99% Occupied Bandwidth

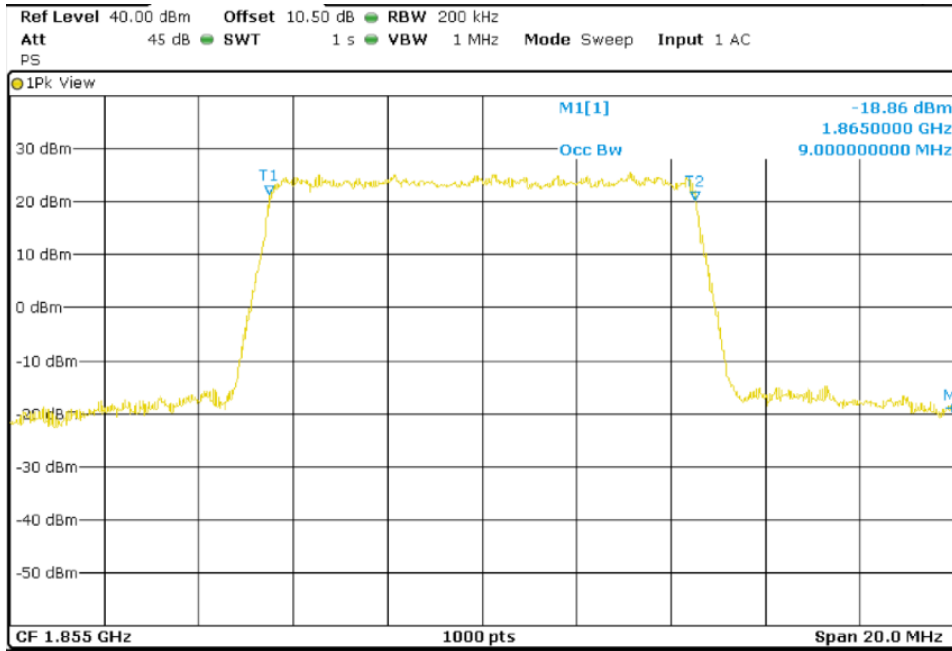

Lowest Channel -26dBc Bandwidth kHz

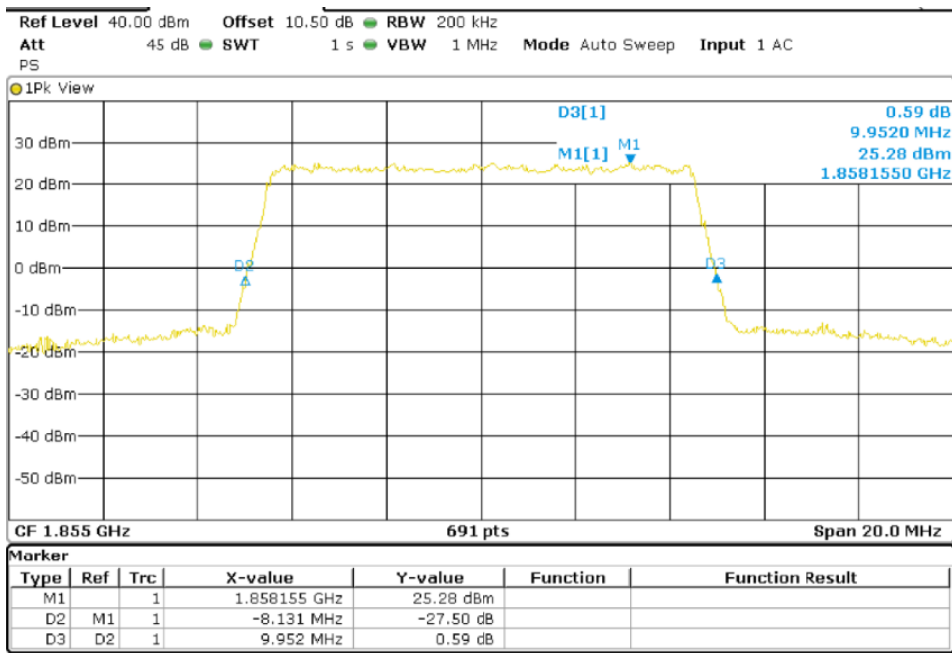

TEST RESULTS (Cont):

Middle Channel 99% Occupied Bandwidth

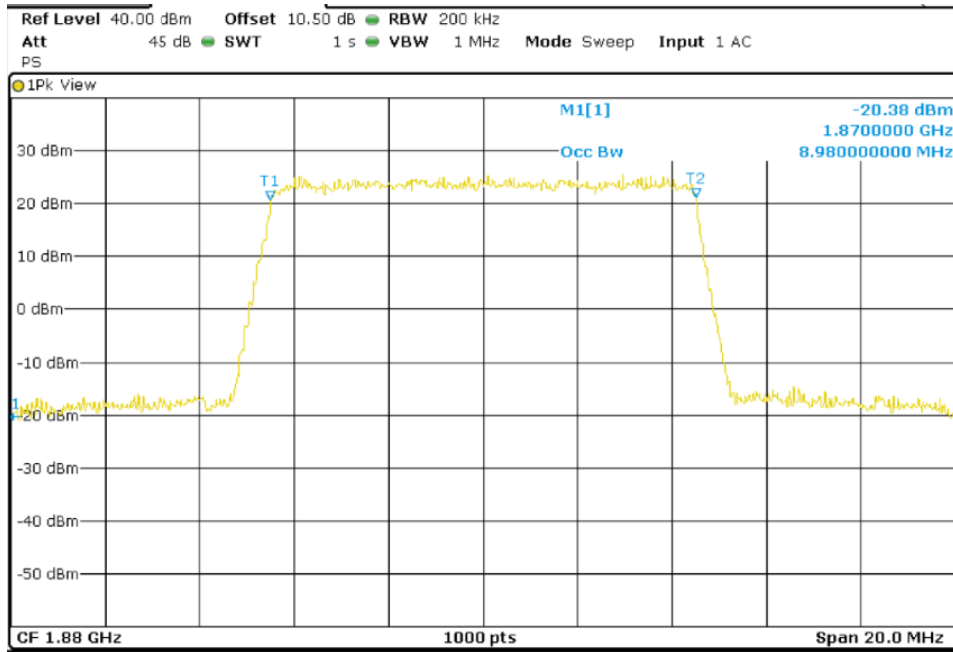

Middle Channel -26dBc Bandwidth kHz

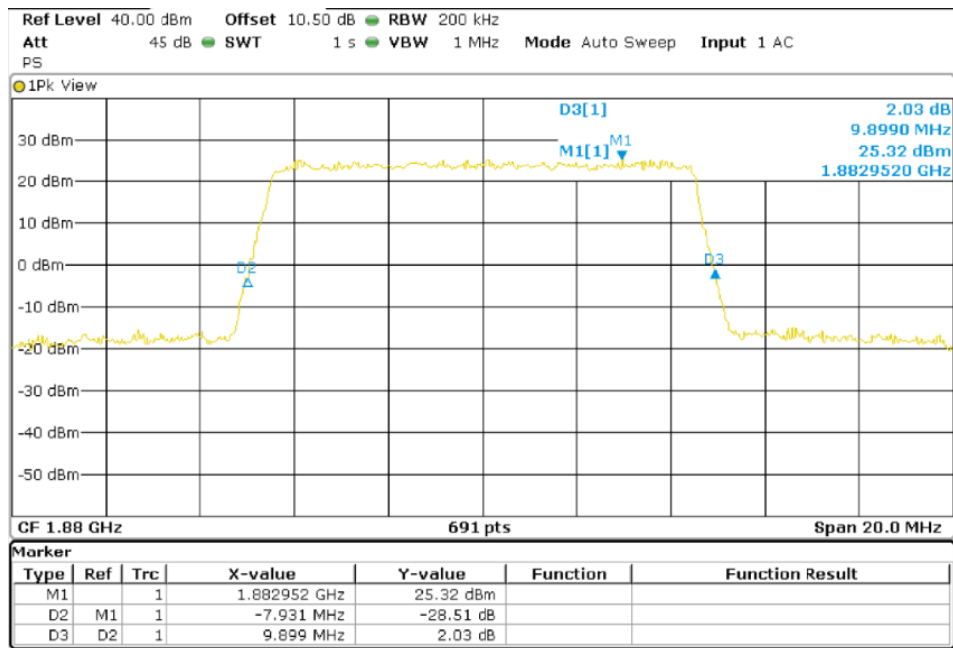

TEST RESULTS (Cont):

Highest Channel 99% Occupied Bandwidth

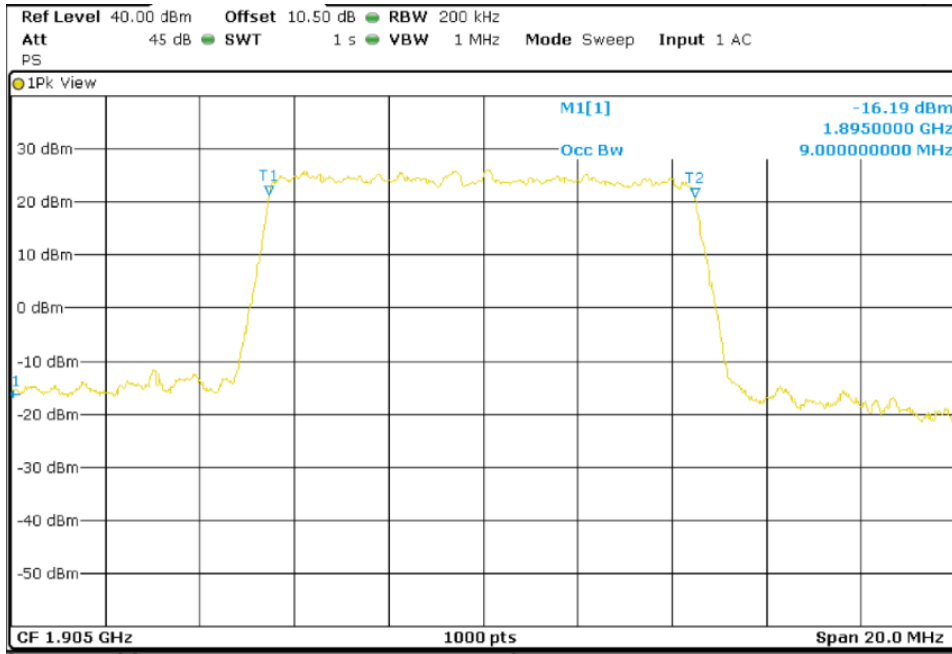

Highest Channel -26dBc Bandwidth kHz

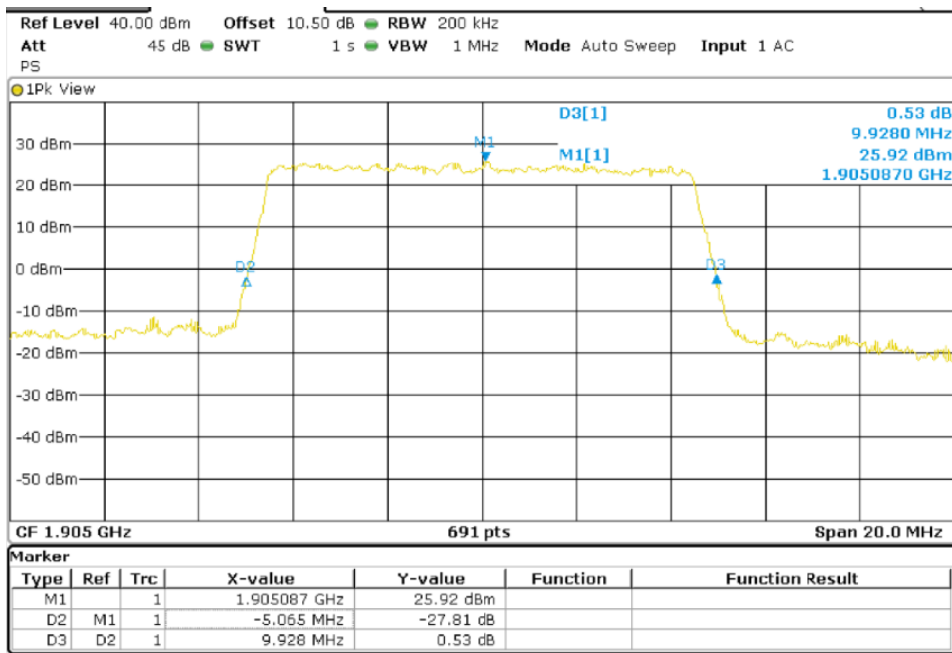

TEST RESULTS (Cont):

LTE QPSK MODULATION. BW = 15 MHz
 Lowest Channel 99% Occupied Bandwidth

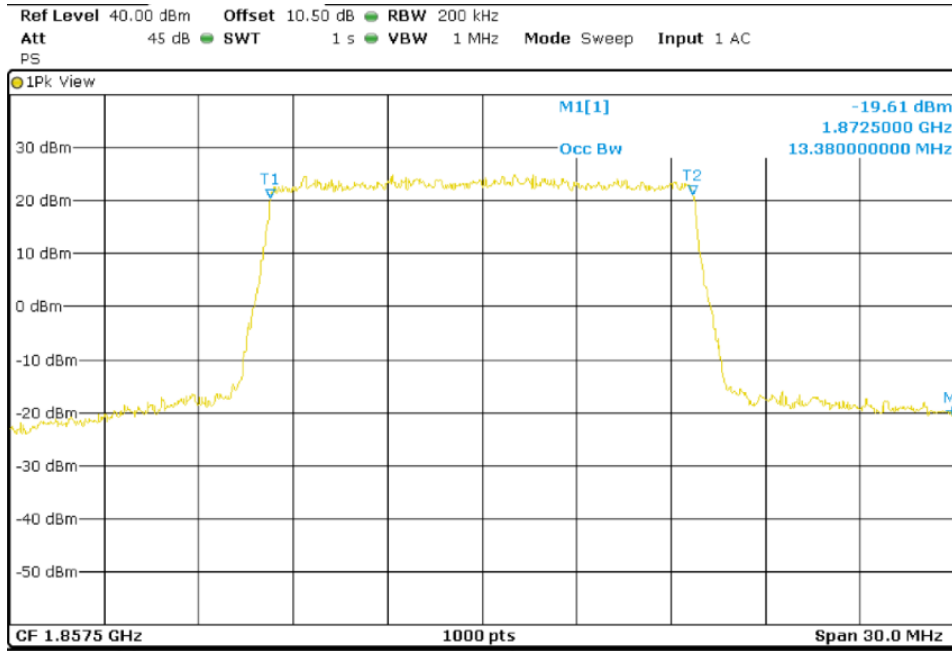

Lowest Channel -26dBc Bandwidth kHz

