

TEST RESULTS (Cont):

Highest Channel 99% Occupied Bandwidth

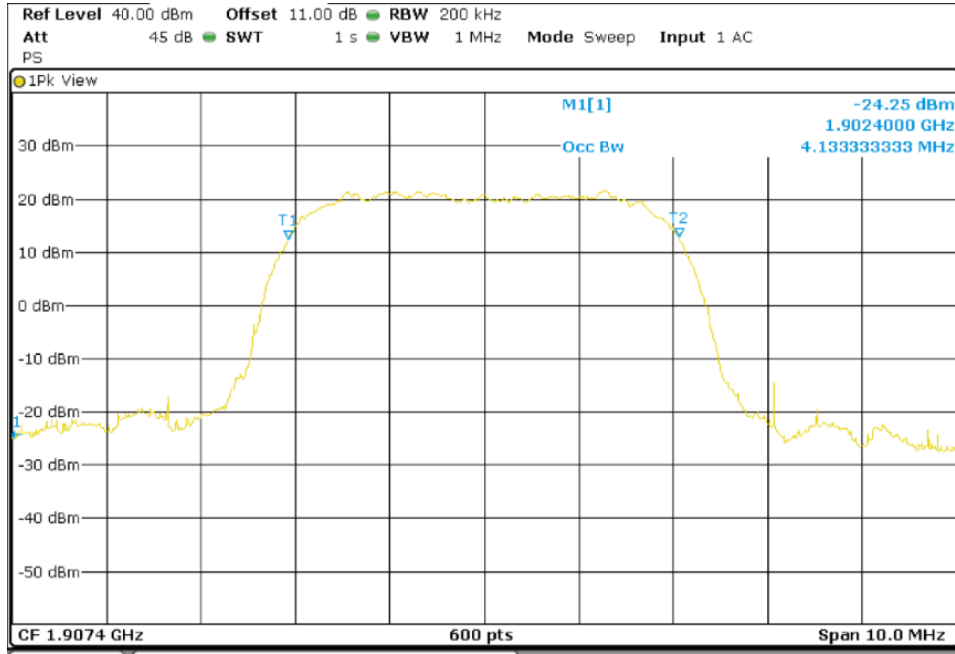

Highest Channel 26dBc Bandwidth kHz

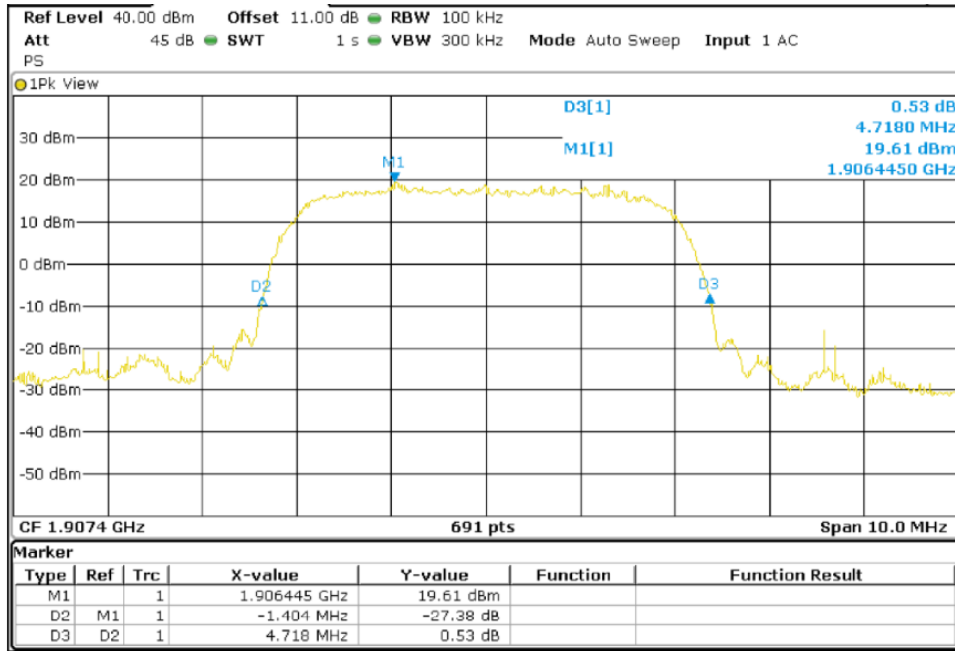

TEST B.5: SPURIOUS EMISSIONS AT ANTENNA TERMINALS

LIMITS:	Product standard:	FCC Part 24 / IC RSS-133
	Test standard:	FCC §2.1051 and § 24.238 / RSS-133 Clause 6.5

LIMITS

According to specification, the power of emissions shall be attenuated below the transmitter power (P) by a factor of at least $43 + 10 \log (P)$ dB. P in watts.

At P_o transmitting power of 2 watts (33 dBm), the specified minimum attenuation becomes $43+10\log (P_o)$. and the level in dBm relative to P_o becomes:

$$P_o \text{ (dBm)} - [43 + 10 \log (P_o \text{ in watts})] = -13 \text{ dBm}$$

TEST SETUP

The EUT RF output connector was connected to a spectrum analyzer and to the Universal Radio Communication Tester R&S CMW500 (selecting maximum transmission power of the EUT and different modes of modulation) using a 50-ohm attenuator and a power splitter.

The reading of the spectrum analyzer is corrected with the attenuation loss of connection between output terminal of EUT and input of the spectrum analyzer.

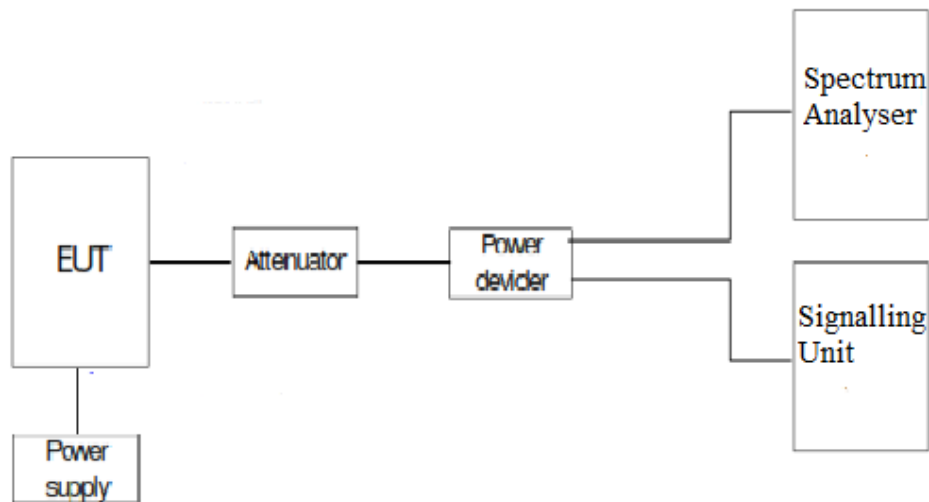

TESTED SAMPLES:	S/01
TESTED CONDITIONS MODES:	TC#01
TEST RESULTS:	PASS

Frequency range 9 KHz – 26 GHz

WCDMA MODULATION.

Lowest Channel

No spurious signal was found at less than 10 dB respect to the limit in the frequency range.

Middle Channel

No spurious signal was found at less than 10 dB respect to the limit in the frequency range.

Highest Channel

No spurious signal was found at less than 10 dB respect to the limit in the frequency range.

TEST RESULTS (Cont.):

WCDMA MODULATION.

Lowest Channel

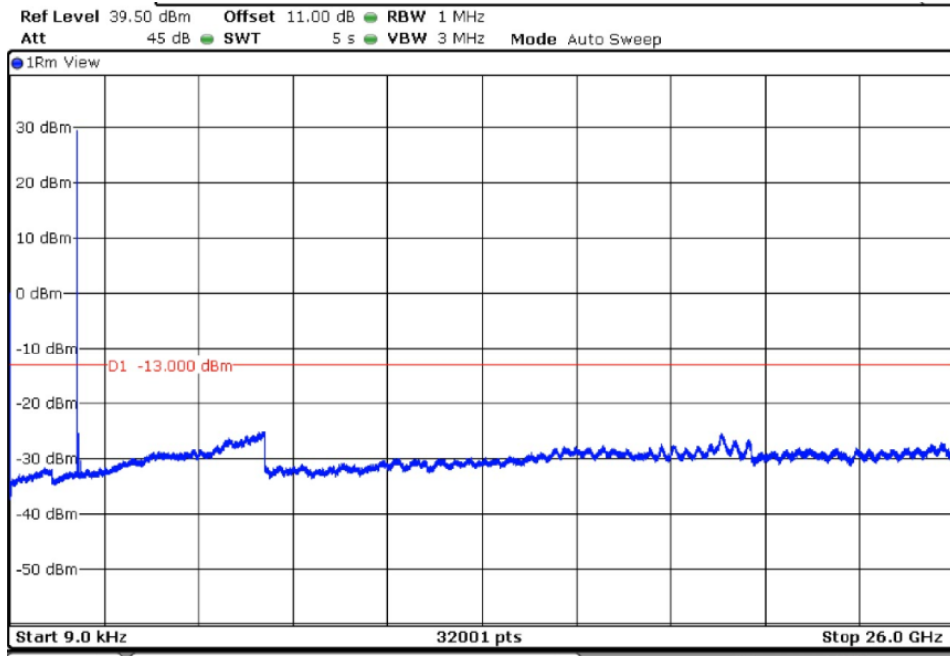

Middle Channel

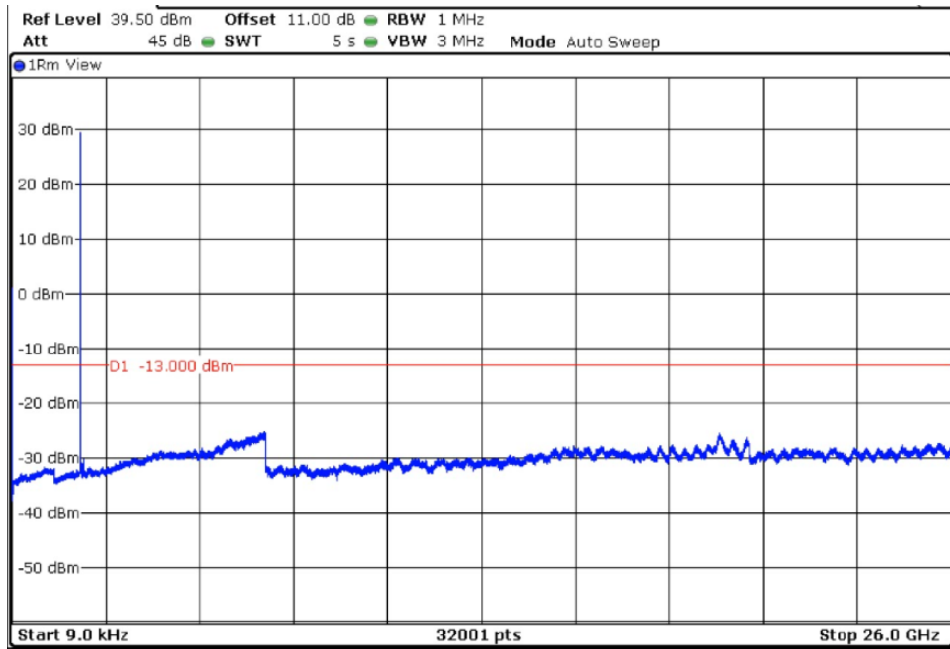

TEST RESULTS (Cont):

Highest Channel

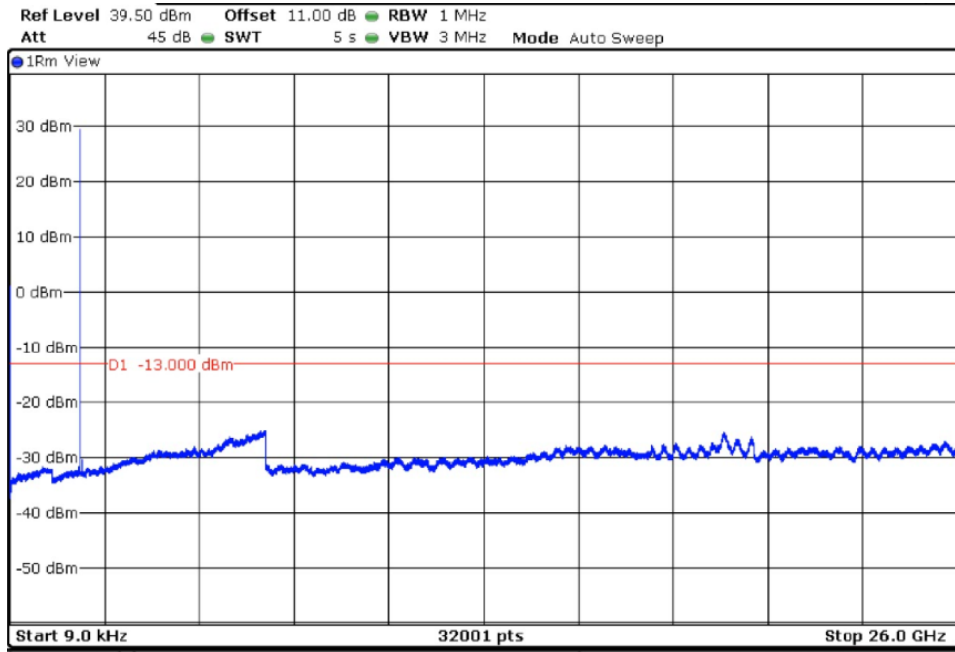

TEST B.6: SPURIOUS EMISSIONS AT ANTENNA TERMINALS AT BLOCK EDGES

LIMITS:	Product standard:	FCC Part 24 / IC RSS-133
	Test standard:	FCC § 24.238 / RSS 133- Clause 6.5

LIMITS

According to specification, the power of emissions shall be attenuated below the transmitter power (P) by a factor of at least $43 + 10 \log (P)$ dB. P in watts.

At P_o transmitting power of 2 watts (33 dBm), the specified minimum attenuation becomes $43+10\log (P_o)$. and the level in dBm relative to P_o becomes:

$$P_o \text{ (dBm)} - [43 + 10 \log (P_o \text{ in watts})] = -13 \text{ dBm}$$

TEST SETUP

The EUT RF output connector was connected to a spectrum analyzer and to the Universal Radio Communication Tester R&S CMW500 (selecting maximum transmission power of the EUT and different modes of modulation) using a 50-ohm attenuator and a power splitter.

The reading of the spectrum analyzer is corrected with the attenuation loss of connection between output terminal of EUT and input of the spectrum analyzer.

For LTE mode the configuration of modulation which is the worst case for conducted power was used.

As indicated in FCC part 24, in the 1 MHz bands immediately outside and adjacent to the licensee's frequency block or band, a resolution bandwidth of at least one percent of the emission bandwidth of the fundamental emission of the transmitter may be employed.

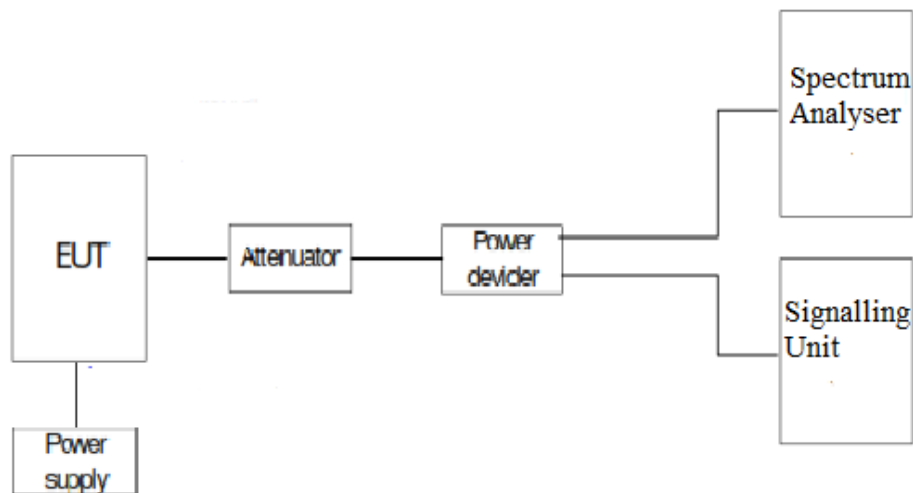

TESTED SAMPLES:	S/01
TESTED CONDITIONS MODES:	TC#01
TEST RESULTS:	PASS

WCDMA MODULATION	Low Channel	High Channel
Maximum measured level at lowest and Highest Block Edge at antenna port (dBm)	-30.42	-30.04

TEST RESULTS (Cont):

WCDMA MODULATION.

Lowest Channel

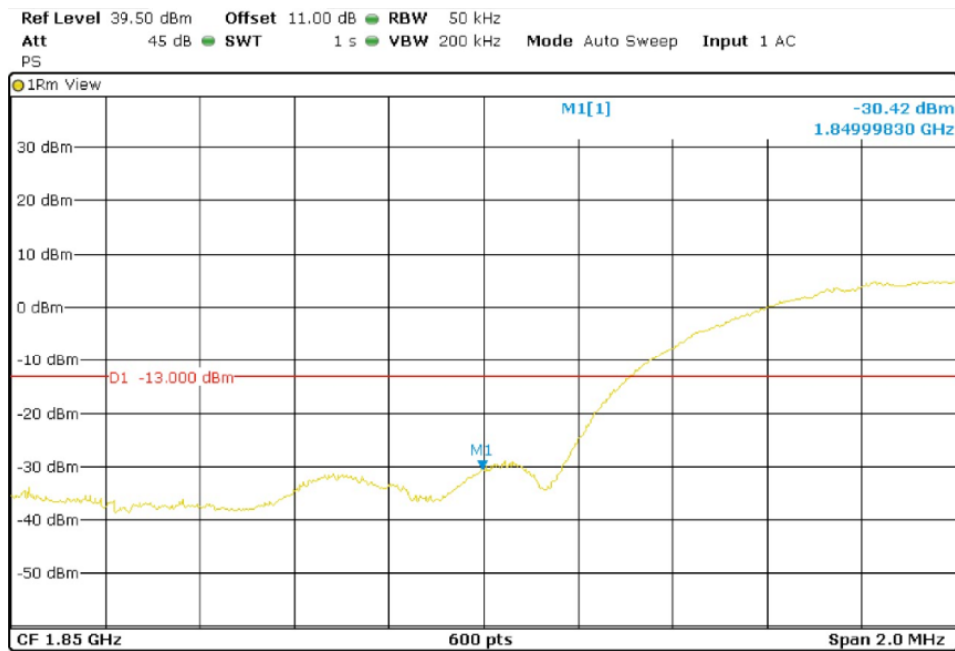

Highest Channel

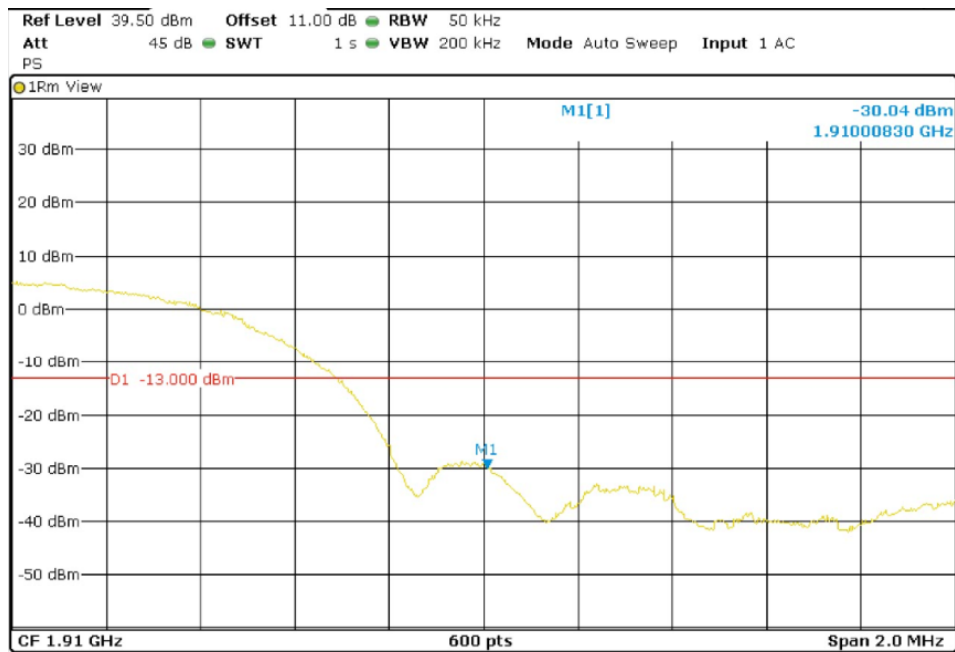

TEST B.7: RADIATED EMISSIONS

LIMITS:	Product standard:	FCC Part 24 / IC RSS-133
	Test standard:	FCC §2.1053 and §24.238 /RSS-133 Clause 6.5

LIMITS

According to specification, the power of emissions shall be attenuated below the transmitter power (P) by a factor of at least $43 + 10 \log (P)$ dB. P in watts.

At P_o transmitting power of 2 watts (33 dBm), the specified minimum attenuation becomes $43+10\log (P_o)$. and the level in dBm relative to P_o becomes:

$$P_o \text{ (dBm)} - [43 + 10 \log (P_o \text{ in watts})] = -13 \text{ dBm}$$

TEST SETUP

The measurement was performed with the EUT inside an anechoic chamber. The spectrum was scanned from 30 MHz to at least the 10th harmonic of the highest frequency generated within the equipment.

The EUT was placed on a non-conductive stand at a 3-meter distance from the measuring antenna for measurements below 1 GHz and at 1-meter distance for measurements above 1 GHz.

Detected emissions were maximized at each frequency by rotating the EUT and adjusting the measuring antenna height and polarization. The maximum reading was recorded.

Radiated measurements < 1GHz

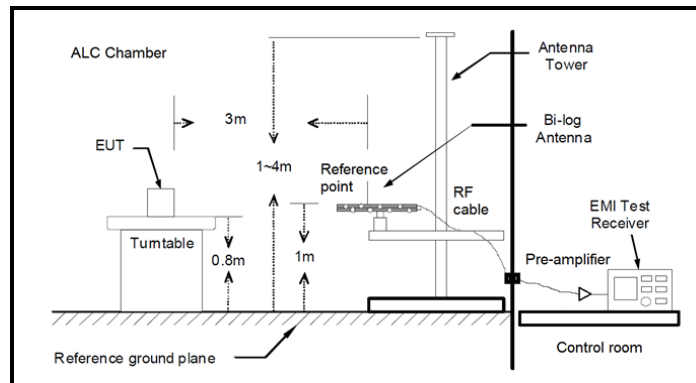

Radiated measurements > 1GHz

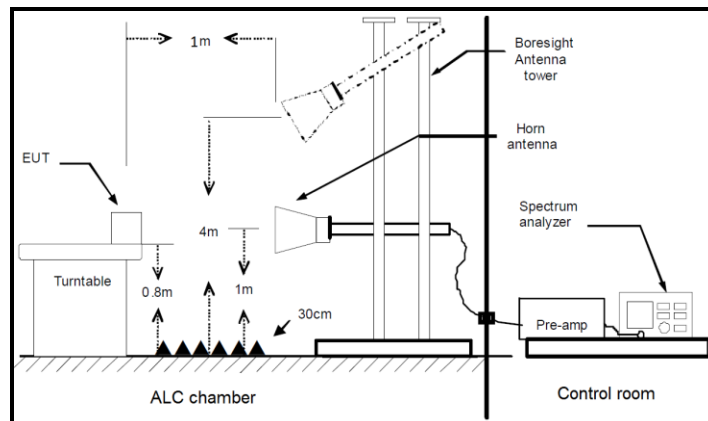

TESTED SAMPLES:	S/01
TESTED CONDITIONS MODES:	TC#01
TEST RESULTS:	PASS

A preliminary scan determined the WCDMA Modulation as the worst case. The following plots show the results for this configuration.

TEST RESULTS (Cont):	Low Channel
-----------------------------	-------------

FREQUENCY RANGE: 30-1000 MHz

Maximizations

Frequency (MHz)	PK+ CLRWR (dBm)	PK+ MAXH (dBm)	Comment
485.512000	-62.61	-55.27	
665.673333	-58.63	-51.95	
980.891000	-51.82	-48.29	

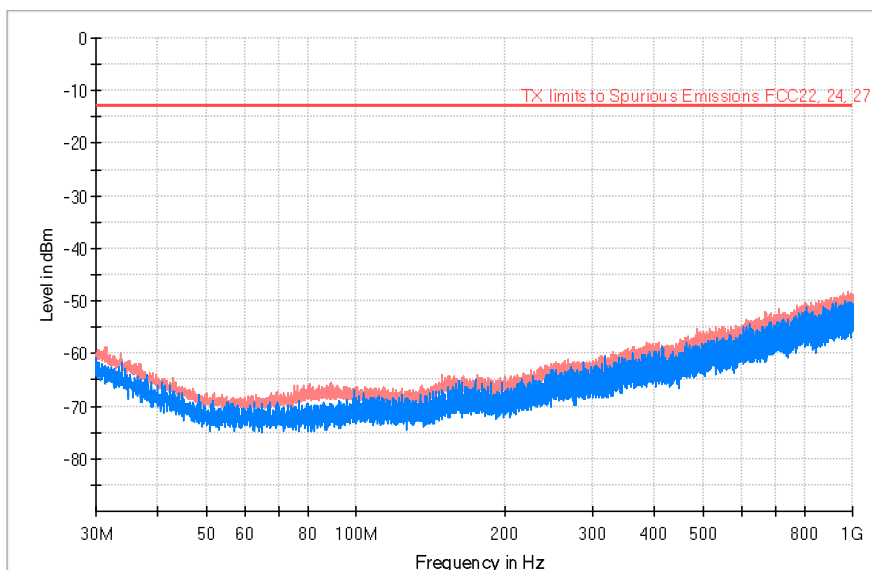

— PK+ _MAXH — PK+ _CLRWR — TX limits to Spurious Emissions FCC22, 24, 27

TEST RESULTS (Cont):

Low Channel

FREQUENCY RANGE: 1-18 GHz

Frequency (MHz)	PK+ CLRWR (dBm)	PK+ MAXH (dBm)	Comment
1859.000000	17.96	23.70	Fundamental
11827.500000	-50.51	-43.04	
16352.000000	-44.35	-38.28	

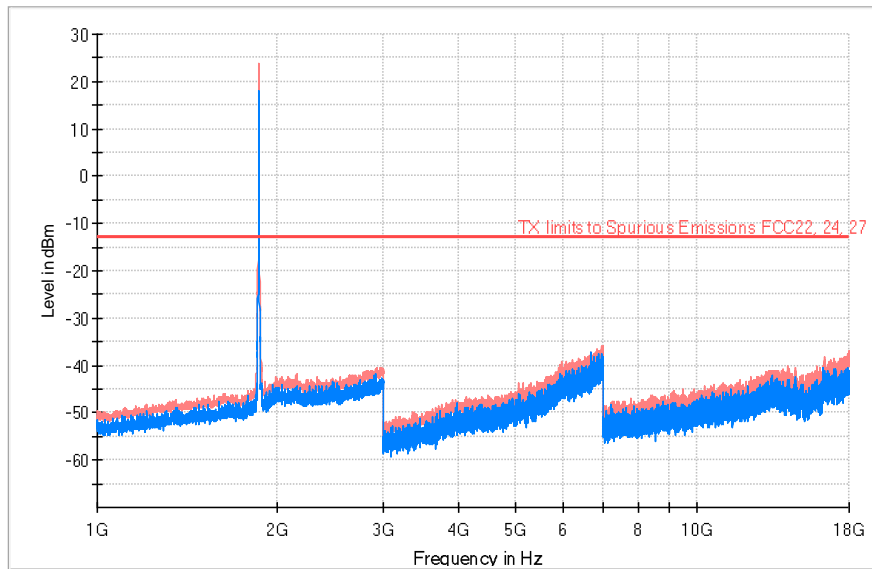

— PK+ MAXH — PK+ CLRWR — TX limits to Spurious Emissions FCC22, 24, 27

TEST RESULTS (Cont):

Low Channel

FREQUENCY RANGE: 18-20 GHz

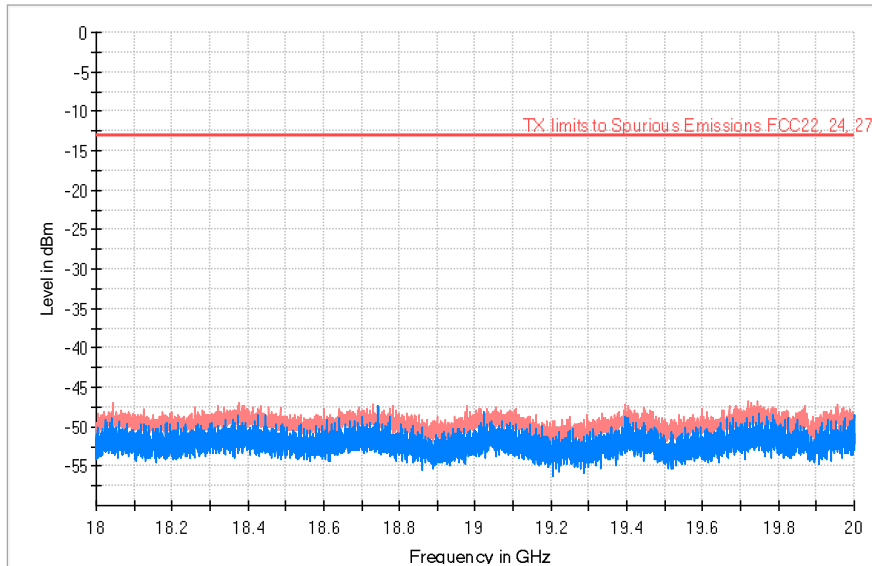

— PK+_MAXH — PK+_CLPWR — TX limits to Spurious Emissions FCC22, 24, 27

TEST RESULTS (Cont):

Mid Channel

FREQUENCY RANGE: 30MHz -1 GHz

Maximizations

Frequency (MHz)	PK+ _CLRWR (dBm)	PK+ _MAXH (dBm)	Comment
30.711333	-62.94	-57.80	
830.153000	-56.79	-49.42	
989.750333	-52.63	-48.63	

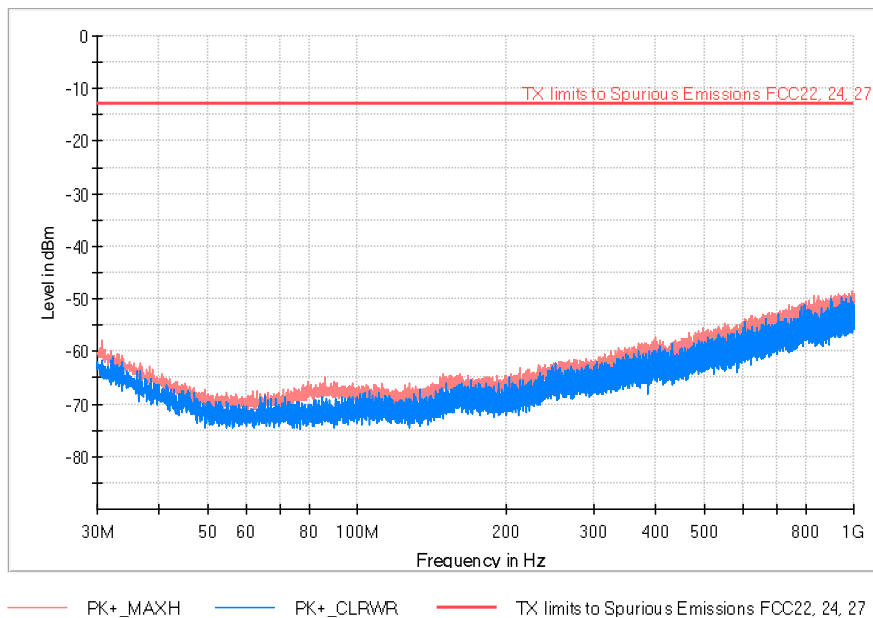

TEST RESULTS (Cont):	Mid Channel
-----------------------------	-------------

FREQUENCY RANGE: 1-18 GHz

Frequency (MHz)	PK+ _CLRWR (dBm)	PK+ _MAXH (dBm)	Comment
1879.000000	16.76	23.61	Fundamental
3501.000000	-54.91	-48.33	
9495.000000	-49.38	-44.35	

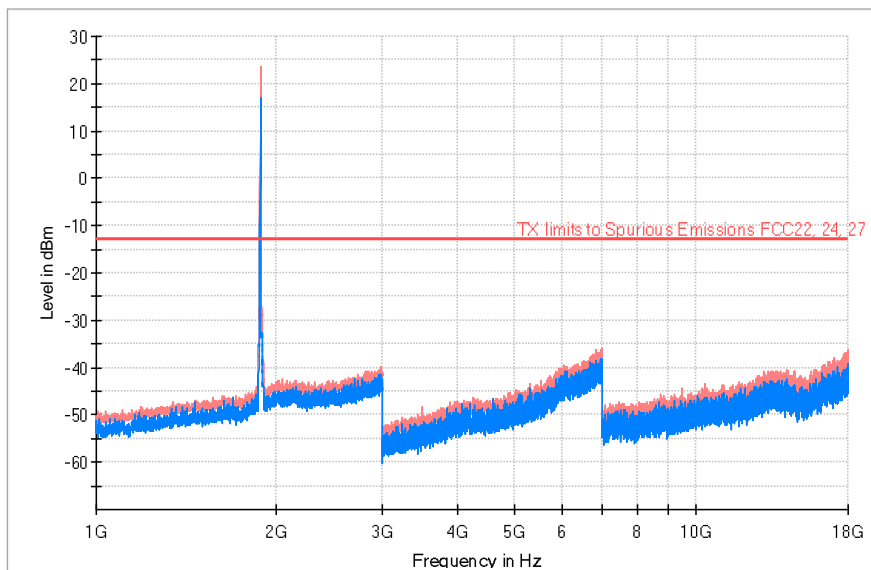

— PK+ _MAXH — PK+ _CLRWR — TX limits to Spurious Emissions FCC22, 24, 27

TEST RESULTS (Cont):

Mid Channel

FREQUENCY RANGE: 18-20 GHz

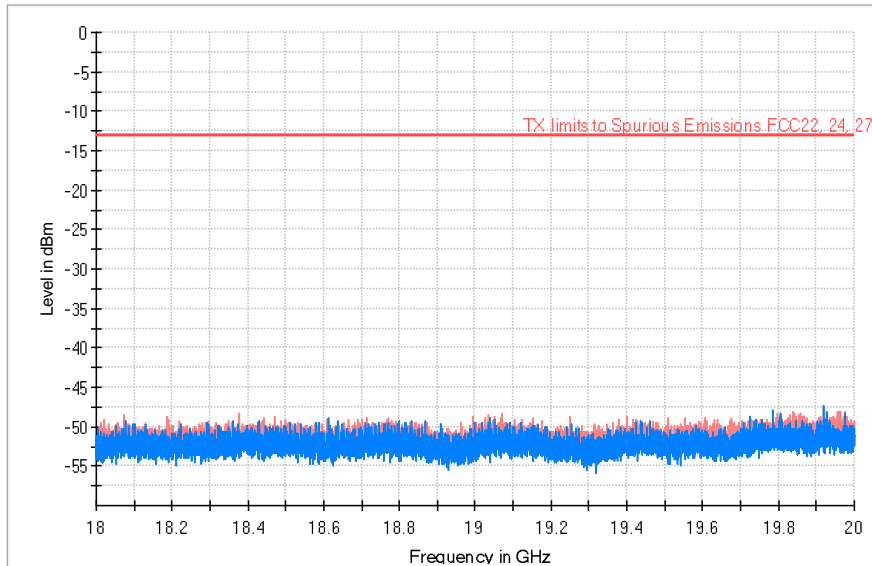

PK+_MAXH PK+_CLPWR TX limits to Spurious Emissions FCC22, 24, 27

TEST RESULTS (Cont):

High Channel

FREQUENCY RANGE: 30MHz-1 GHz

Frequency (MHz)	PK+_CLRWR (dBm)	PK+_MAXH (dBm)	Comment
32.780667	-66.25	-59.58	
65.987000	-73.88	-66.32	
401.801000	-64.29	-55.67	
970.512000	-55.09	-47.89	

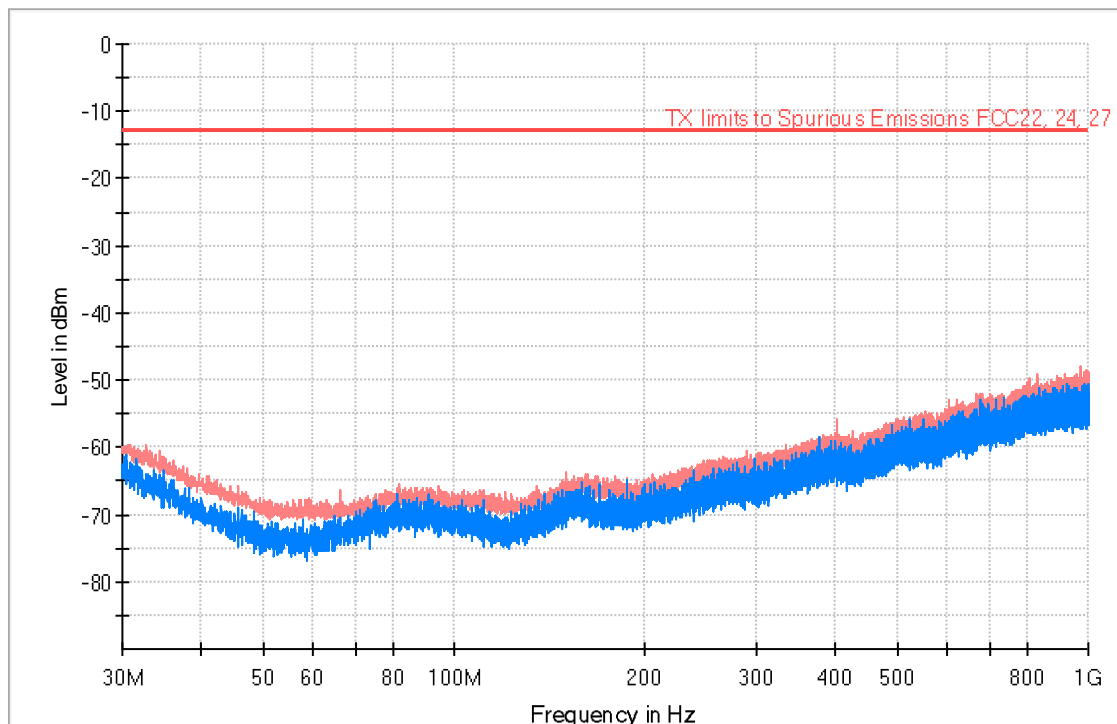

— PK+_MAXH — PK+_CLRWR — TX limits to Spurious Emissions FCC22, 24, 27

TEST RESULTS(Cont.):

High Channel

FREQUENCY RANGE: 1-18 GHz

Frequency (MHz)	PK+_CLRWR (dBm)	PK+_MAXH (dBm)	Comment
1899.000000	17.89	23.65	Fundamental
11942.000000	-48.09	-42.01	
17667.000000	-44.68	-36.73	

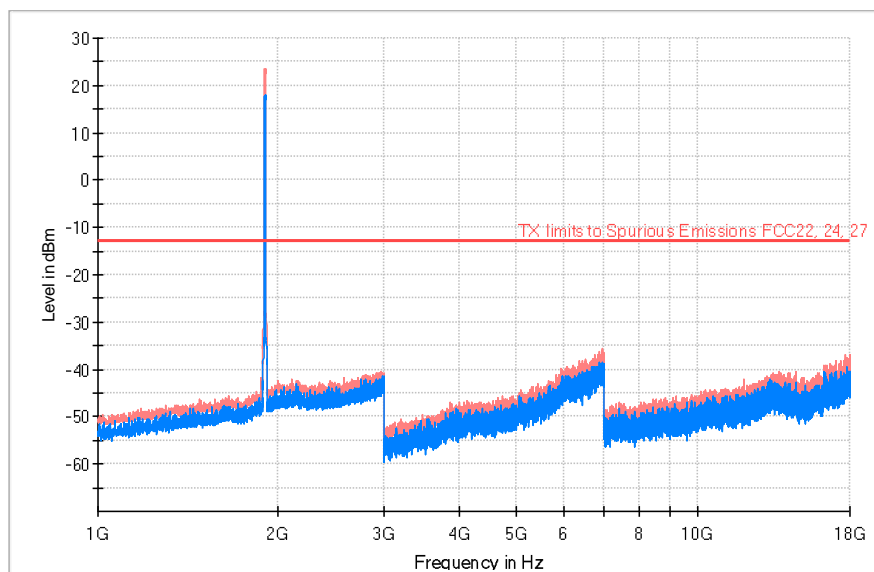

— PK+_MAXH — PK+_CLRWR — TX limits to Spurious Emissions FCC22, 24, 27

TEST RESULTS (Cont):

High Channel

FREQUENCY RANGE: 18-20 GHz

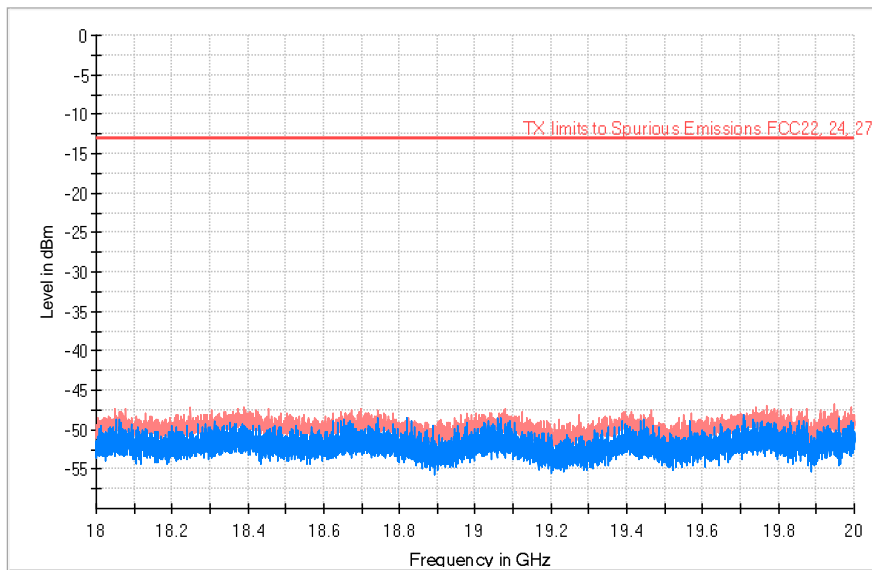

— PK+_MAXH — PK+_CLRWR — TX limits to Spurious Emissions FCC22, 24, 27

Appendix C: Test Results for LTE

FCC Part 24/ IC RSS-133

Appendix C Content

PRODUCT INFORMATION	81
DESCRIPTION OF TEST CONDITIONS	82
TEST C.1: RF OUTPUT POWER	83
TEST C.2: MODULATION CHARACTERISTICS	109
TEST C.3: FREQUENCY STABILITY	111
TEST C.4: OCCUPIED BANDWIDTH	113
TEST C.5: SPURIOUS EMISSIONS AT ANTENNA TERMINALS	152
TEST C.6: SPURIOUS EMISSIONS AT ANTENNA TERMINALS AT BLOCK EDGES.....	164
TEST C.7: RADIATED EMISSIONS.....	178

PRODUCT INFORMATION

The following information is provided by the client

Information	Description
Modulation	QPSK, QAM
Maximum RF Output Power	25 dBm
Operation mode:	
- Operating Frequency Range	Band 2: 1850-1910 MHz
- Nominal Channel Bandwidth	Band 2: 1.4 / 3 / 5 / 10 / 15 / 20 MHz
Extreme operating conditions	
- Temperature range	T _{nom} = +15 to + 35 T _{min} = -30 T _{max} = +50
Antenna type	External attachable Antenna.
Antenna gain	4 dBi
Nominal Voltage	
- Supply Voltage	3.8 Vdc
- Type of power source	DC Power supply

DESCRIPTION OF TEST CONDITIONS

The worst case was found when positioned as the table below. Following channel(s) was (were) selected for the final test as listed below:

TEST CONDITIONS	DESCRIPTION										
<p style="text-align: center;">TC#01 LTE Band 2</p>	<p><u>Power supply (V):</u> $V_{\text{nominal}} = 3.8 \text{ Vdc}$</p> <p><u>Test Frequencies for Conducted tests:</u></p> <p><u>1.4 MHz Bandwidth:</u> -Lowest Channel: 18607(1850.7 MHz) -Middle Channel: 18900(1880 MHz) -Highest Channel: 19193(1909.3 MHz)</p> <p><u>3 MHz Bandwidth:</u> -Lowest Channel: 18615(1851.5 MHz) -Middle Channel: 18900(1880 MHz) -Highest Channel: 19185(1908.5 MHz)</p> <p><u>5 MHz Bandwidth:</u> -Lowest Channel: 18625(1852.5 MHz) -Middle Channel: 18900(1880 MHz) -Highest Channel: 19175(1907.5 MHz)</p> <p><u>10 MHz Bandwidth:</u> -Lowest Channel: 18650(1855 MHz) -Middle Channel: 18900(1880 MHz) -Highest Channel: 19150(1905 MHz)</p> <p><u>15 MHz Bandwidth:</u> -Lowest Channel: 18675(1857.5 MHz) -Middle Channel: 18900(1880 MHz) -Highest Channel: 19125(1902.5 MHz)</p> <p><u>20 MHz Bandwidth:</u> -Lowest Channel: 18700(1860 MHz) -Middle Channel: 18900(1880 MHz) -Highest Channel: 19100(1900 MHz)</p> <p><u>Test Frequencies for Radiated tests:</u></p> <table border="1" data-bbox="413 1682 1334 1888"> <thead> <tr> <th>Available Frequencies</th> <th>Tested Frequency</th> <th>Channel Bandwidth</th> <th>Modulation</th> <th>Mode</th> </tr> </thead> <tbody> <tr> <td>1850 to 1910 MHz</td> <td>1860 MHz 1880 MHz 1900 MHz</td> <td>20 MHz</td> <td>QPSK</td> <td>1 RB</td> </tr> </tbody> </table> <p>Note: This device was tested under all bandwidths, RB configurations and modulations. The worst case found in QPSK modulation.</p>	Available Frequencies	Tested Frequency	Channel Bandwidth	Modulation	Mode	1850 to 1910 MHz	1860 MHz 1880 MHz 1900 MHz	20 MHz	QPSK	1 RB
Available Frequencies	Tested Frequency	Channel Bandwidth	Modulation	Mode							
1850 to 1910 MHz	1860 MHz 1880 MHz 1900 MHz	20 MHz	QPSK	1 RB							

TEST C.1: RF OUTPUT POWER

LIMITS:	Product standard:	FCC Part 24 / IC RSS-133
	Test standard:	FCC §2.1046 and §24.232. RSS-133 Clause 6.4

LIMITS

Fixed, mobile, and portable (hand-held) stations are limited to 2-watt EIRP (30 dBm). Fixed stations are limited to a maximum antenna height of 10 meters above ground. Mobile and portable stations operating in these bands must employ a means for limiting power to the minimum necessary for successful communications.

The peak-to-average ratio (PAR) of the transmission shall not exceed 13 dB.

RSS-133 Clause 6.4

The equivalent isotropically radiated power (e.i.r.p.) for transmitters shall not exceed the limits given in SRSP-510. Moreover, base station transmitters operating in the band 1930-1995 MHz shall not have output power exceeding 100 watts.

In addition, the transmitter's peak-to-average power ratio (PAPR) shall not exceed 13 dB for more than 0.1% of the time using a signal corresponding to the highest PAPR during periods of continuous transmission.

TEST SETUP

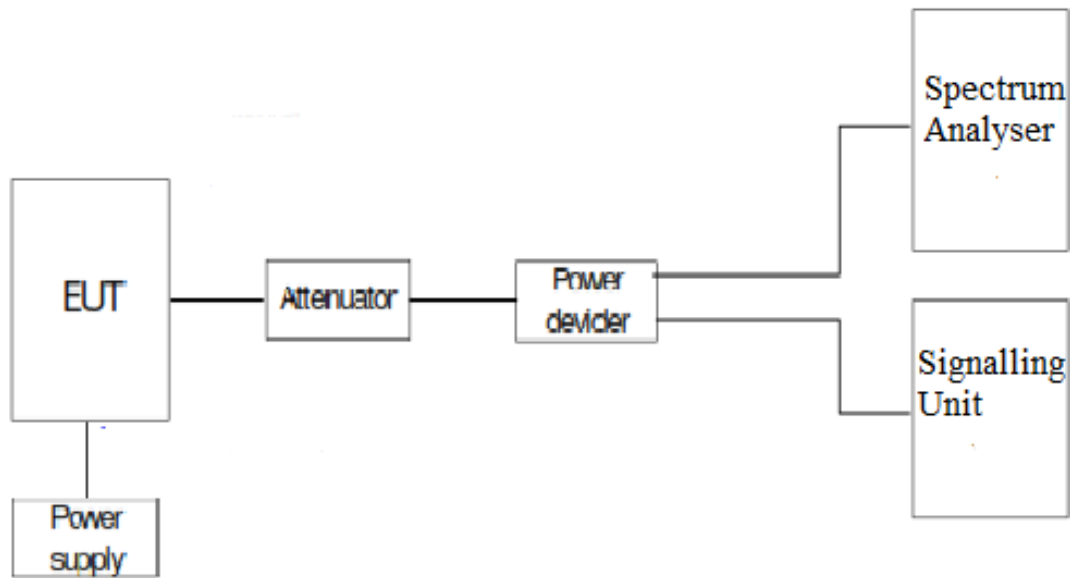

TESTED SAMPLES:	S/01			
TESTED CONDITIONS MODES:	TC#01			
TEST RESULTS:	PASS			
LTE QPSK AND 16QAM MODULATION. Bandwidth = 1.4 MHz				
Channel	Average power at antenna port (dBm)	Maximum declared antenna gain (dBi)	Maximum E.I.R.P. average power (dBm)	PAPR (dB)
Lowest	22.83	4.0	26.83	5.04
Middle	22.87	4.0	26.87	5.16
Highest	23.07	4.0	27.07	4.81
LTE QPSK AND 16QAM MODULATION. Bandwidth = 3 MHz				
Channel	Average power at antenna port (dBm)	Maximum declared antenna gain (dBi)	Maximum E.I.R.P. average power (dBm)	PAPR (dB)
Lowest	22.85	4.0	26.85	4.84
Middle	22.92	4.0	26.92	5.01
Highest	23.14	4.0	27.14	4.81
LTE QPSK AND 16QAM MODULATION. Bandwidth = 5 MHz				
Channel	Average power at antenna port (dBm)	Maximum declared antenna gain (dBi)	Maximum E.I.R.P. average power (dBm)	PAPR (dB)
Lowest	22.81	4.0	26.81	4.70
Middle	22.94	4.0	26.94	4.93
Highest	23.05	4.0	27.05	4.81
LTE QPSK AND 16QAM MODULATION. Bandwidth = 10 MHz				
Channel	Average power at antenna port (dBm)	Maximum declared antenna gain (dBi)	Maximum E.I.R.P. average power (dBm)	PAPR (dB)
Lowest	23.04	4.0	27.04	4.72
Middle	23.12	4.0	27.12	4.87
Highest	23.06	4.0	27.06	4.81
LTE QPSK AND 16QAM MODULATION. Bandwidth = 15 MHz				
Channel	Average power at antenna port (dBm)	Maximum declared antenna gain (dBi)	Maximum E.I.R.P. average power (dBm)	PAPR (dB)
Lowest	22.98	4.0	26.98	4.78
Middle	22.96	4.0	26.96	5.07
Highest	23.16	4.0	27.16	4.67
LTE QPSK AND 16QAM MODULATION. Bandwidth = 20 MHz				
Channel	Average power at antenna port (dBm)	Maximum declared antenna gain (dBi)	Maximum E.I.R.P. average power (dBm)	PAPR (dB)
Lowest	23.11	4.0	27.11	4.41
Middle	23.19	4.0	27.19	4.93
Highest	23.22	4.0	27.22	4.55
Measurement uncertainty (dB)			<±0.95	

TEST RESULTS (Cont):						
Bandwidth (MHz)	Channel Location Frequency (MHz) Channel Number	Modulation	Resource Block Size	Resource Block Offset	Average power at antenna port (dBm)	PAPR (dB)
1.4	Lowest (18607 (1850.7 MHz))	QPSK	1	0	22.77	4.06
			1	5	22.74	
			3	0	22.75	
			3	2	22.83	
			6	0	21.77	
		16-QAM	1	0	21.97	5.04
			1	5	21.95	
			3	0	21.78	
			3	2	21.83	
			6	0	20.84	
	Middle (18900 (1880 MHz))	QPSK	1	0	22.73	4.26
			1	5	22.76	
			3	0	22.82	
			3	2	22.87	
			6	0	21.77	
		16-QAM	1	0	21.98	5.16
			1	5	21.98	
			3	0	21.76	
			3	2	21.83	
			6	0	20.9	
Highest (19193 (1909.3 MHz))	QPSK	1	0	22.95	4.41	
		1	5	22.97		
		3	0	23		
		3	2	23.07		
		6	0	21.97		
	16-QAM	1	0	21.91	4.81	
		1	5	21.93		
		3	0	21.95		
		3	2	21.99		
		6	0	21.07		

TEST RESULTS (Cont):						
Bandwidth (MHz)	Channel Location Frequency (MHz) Channel Number	Modulation	Resource Block Size	Resource Block Offset	Average power at antenna port (dBm)	PAPR (dB)
3	Lowest (18650 (1855 MHz))	QPSK	1	0	22.82	3.91
			1	14	22.74	
			8	0	21.87	
			8	7	21.81	
			15	0	21.88	
		16-QAM	1	0	22.06	4.84
			1	14	22.02	
			8	0	21.04	
			8	7	21	
			15	0	20.87	
	Middle (18900 (1880 MHz))	QPSK	1	0	22.86	4.14
			1	14	22.84	
			8	0	21.85	
			8	7	21.88	
			15	0	21.86	
		16-QAM	1	0	22.1	5.01
			1	14	22.08	
			8	0	21.04	
			8	7	21.05	
			15	0	20.93	
Highest (19185 (1908.5 MHz))	QPSK	1	0	23.05	4.35	
		1	14	23.01		
		8	0	22.05		
		8	7	22.05		
		15	0	22.07		
	16-QAM	1	0	22.25	4.81	
		1	14	22.22		
		8	0	21.15		
		8	7	21.16		
		15	0	21.12		

TEST RESULTS (Cont):						
Bandwidth (MHz)	Channel Location Frequency (MHz) Channel Number	Modulation	Resource Block Size	Resource Block Offset	Average power at antenna port (dBm)	PAPR (dB)
5	Lowest (18625 (1852.5 MHz))	QPSK	1	0	22.81	3.91
			1	24	22.78	
			12	0	21.9	
			12	11	21.87	
			25	0	21.86	
		16-QAM	1	0	21.95	4.70
			1	24	21.9	
			12	0	20.93	
			12	11	20.93	
			25	0	20.88	
	Middle (18900 (1880 MHz))	QPSK	1	0	22.94	4.12
			1	24	22.88	
			12	0	21.85	
			12	11	21.86	
			25	0	21.86	
		16-QAM	1	0	21.94	4.93
			1	24	21.93	
			12	0	20.97	
			12	11	21	
			25	0	20.9	
Highest (19175 (1907.5 MHz))	QPSK	1	0	23.05	4.35	
		1	24	23.04		
		12	0	22.09		
		12	11	22.1		
		25	0	22.1		
	16-QAM	1	0	22.43	4.81	
		1	24	22.51		
		12	0	21.02		
		12	11	21		
		25	0	21.11		

TEST RESULTS (Cont):						
BANDWIDTH (MHz)	CHANNEL FREQUENCY (MHz)	MODULATION	RB SIZE	RB OFFSET	AVERAGE POWER (dBm)	PAPR (dB)
10	Lowest (18650 (1855 MHz))	QPSK	1	0	23.04	3.86
			1	24	22.81	
			1	49	23.01	
			25	0	21.9	
			25	24	21.86	
			50	0	21.91	
		16-QAM	1	0	22.3	4.72
			1	24	22.07	
			1	49	22.36	
			25	0	21.03	
			25	24	21.01	
			50	0	20.89	
	Middle (18900 (1880 MHz))	QPSK	1	0	23.12	4.03
			1	24	22.85	
			1	49	23.04	
			25	0	21.92	
			25	24	21.92	
			50	0	21.94	
		16-QAM	1	0	22.29	4.87
			1	24	22.06	
			1	49	22.27	
			25	0	20.97	
			25	24	20.95	
			50	0	20.91	
Highest (19150 (1905 MHz))	QPSK	1	0	23.1	4.23	
		1	24	23.06		
		1	49	23.06		
		25	0	22.16		
		25	24	22.13		
		50	0	22.15		
	16-QAM	1	0	22.24	4.81	
		1	24	22.23		
		1	49	22.25		
		25	0	21.24		
		25	24	21.23		
		50	0	21.11		

TEST RESULTS (Cont):						
BANDWIDTH (MHz)	CHANNEL FREQUENCY (MHz)	MODULATION	RB SIZE	RB OFFSET	AVERAGE POWER (dBm)	PAPR (dB)
15	Lowest (18675 (1857.5 MHz))	QPSK	1	0	22.98	3.74
			1	37	22.81	
			1	74	22.89	
			36	0	21.93	
			36	37	21.89	
			75	0	21.91	
		16-QAM	1	0	22.23	4.78
			1	37	22.16	
			1	74	22.18	
			36	0	21.01	
			36	37	20.99	
			75	0	20.91	
	Middle (18900 (1880 MHz))	QPSK	1	0	22.96	4.14
			1	37	22.83	
			1	74	22.9	
			36	0	21.93	
			36	37	21.95	
			75	0	21.92	
		16-QAM	1	0	22.19	5.07
			1	37	22.08	
			1	74	22.13	
			36	0	20.99	
			36	37	20.95	
			75	0	20.92	
Highest (19125 (1902.5 MHz))	QPSK	1	0	23.16	3.83	
		1	37	23.07		
		1	74	23.08		
		36	0	22.16		
		36	37	22.07		
		75	0	22.12		
	16-QAM	1	0	22.09	4.67	
		1	37	21.98		
		1	74	22.05		
		36	0	21.17		
		36	37	21.13		
		75	0	21.1		

TEST RESULTS (Cont):						
BANDWIDTH (MHz)	CHANNEL FREQUENCY (MHz)	MODULATION	RB SIZE	RB OFFSET	AVERAGE POWER (dBm)	PAPR (dB)
20	Lowest (18700 (1860 MHz))	QPSK	1	0	23.11	3.62
			1	49	22.81	
			1	99	23.01	
			50	0	22.01	
			50	49	21.96	
			100	0	21.98	
		16-QAM	1	0	22.14	4.41
			1	49	21.89	
			1	99	22.08	
			50	0	21.02	
	50		49	21.95		
	Middle (18900 (1880 MHz))	QPSK	1	0	23.19	4.09
			1	49	22.88	
			1	99	23.11	
			50	0	21.97	
			50	49	21.89	
			100	0	21.96	
		16-QAM	1	0	22.63	4.93
			1	49	22.26	
			1	99	22.54	
			50	0	20.93	
	50		49	20.94		
	Highest (19100 (1900 MHz))	QPSK	1	0	23.22	3.71
			1	49	23	
1			99	23		
50			0	22.14		
50			49	22.13		
100			0	22.13		
16-QAM		1	0	22.93	4.55	
		1	49	22.67		
		1	99	22.68		
		50	0	21.15		
	50	49	21.11			
			100	0	21.2	

TEST RESULTS (Cont):

PAPR
 Bandwidth = 1.4 MHz. Modulation QPSK. RB Size: 1. RB Offset: 0.
 Lowest channel

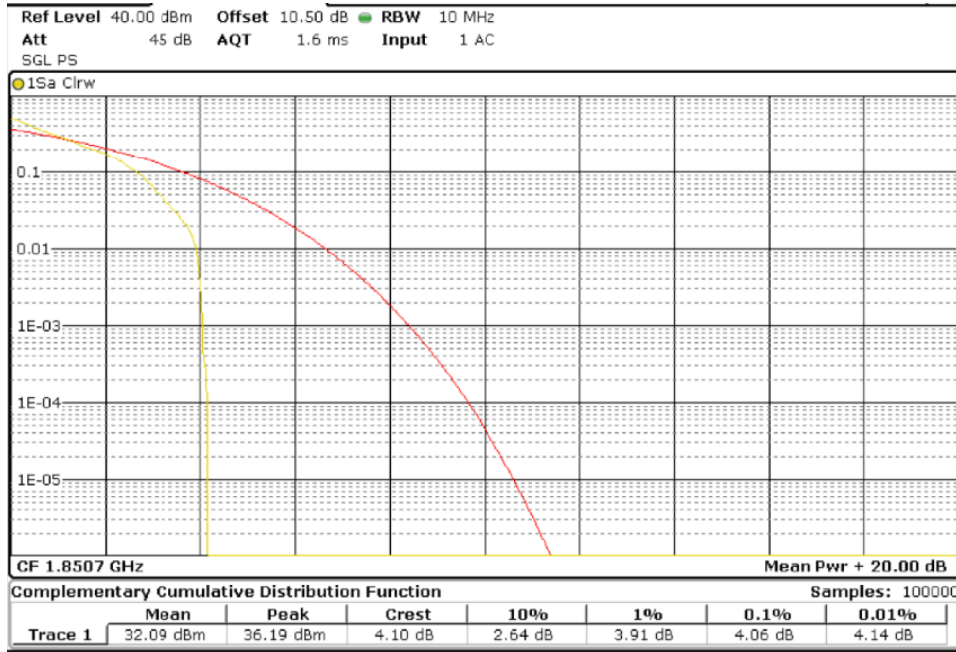

Middle channel

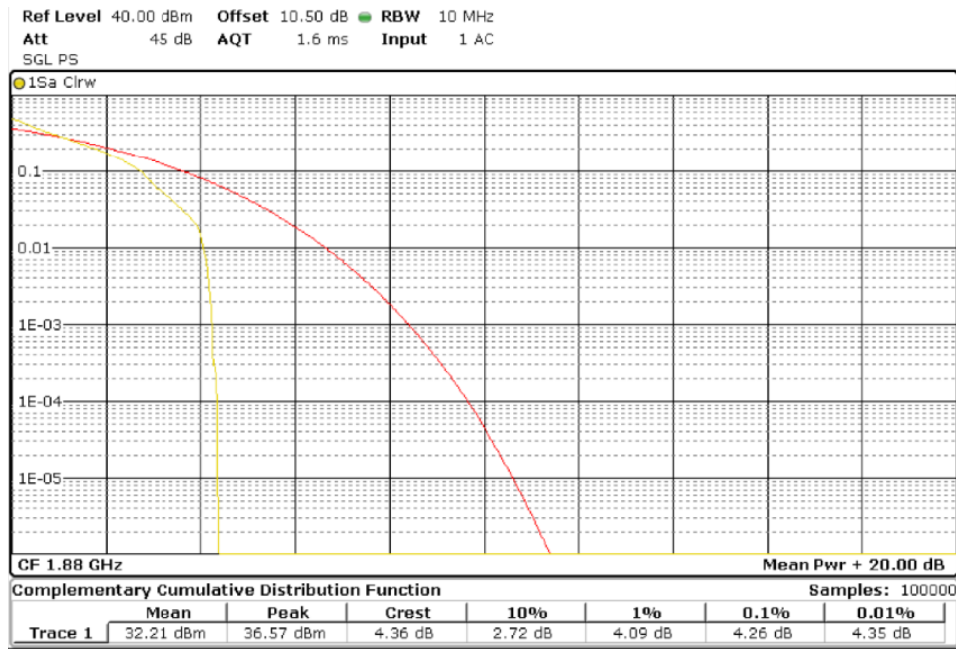

TEST RESULTS (Cont):

Highest channel

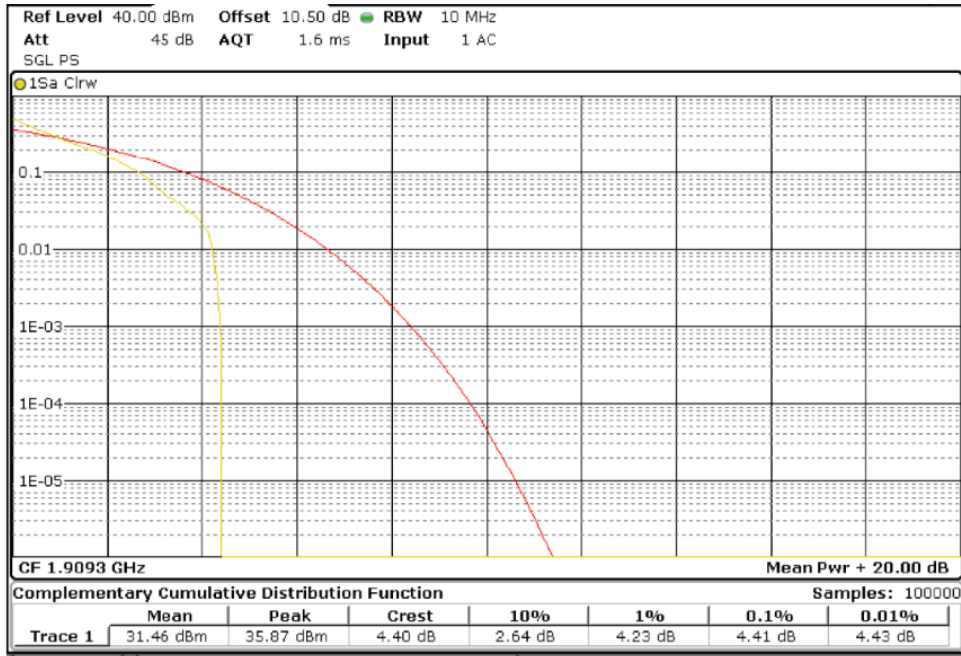

PAPR

Bandwidth = 1.4 MHz. Modulation 16QAM. RB Size: 1. RB Offset: 0.

Lowest channel

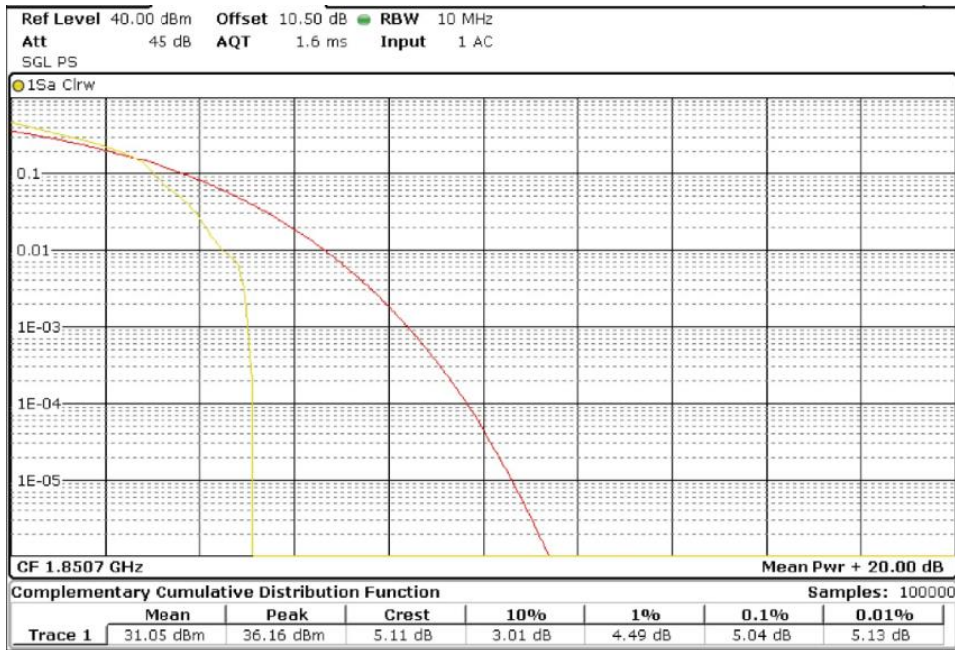

TEST RESULTS (Cont):

Middle channel

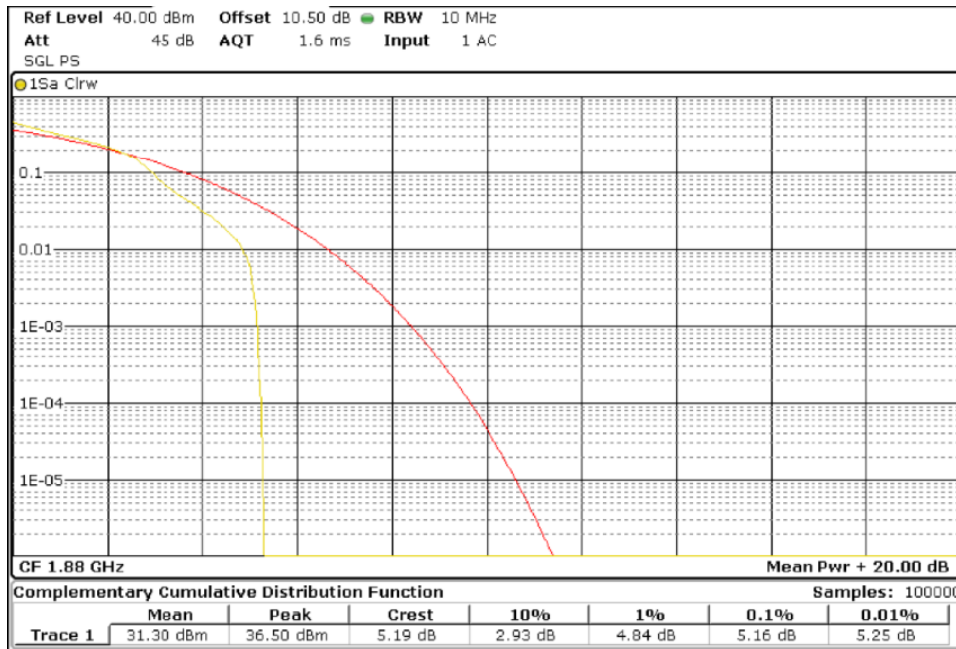

Highest channel

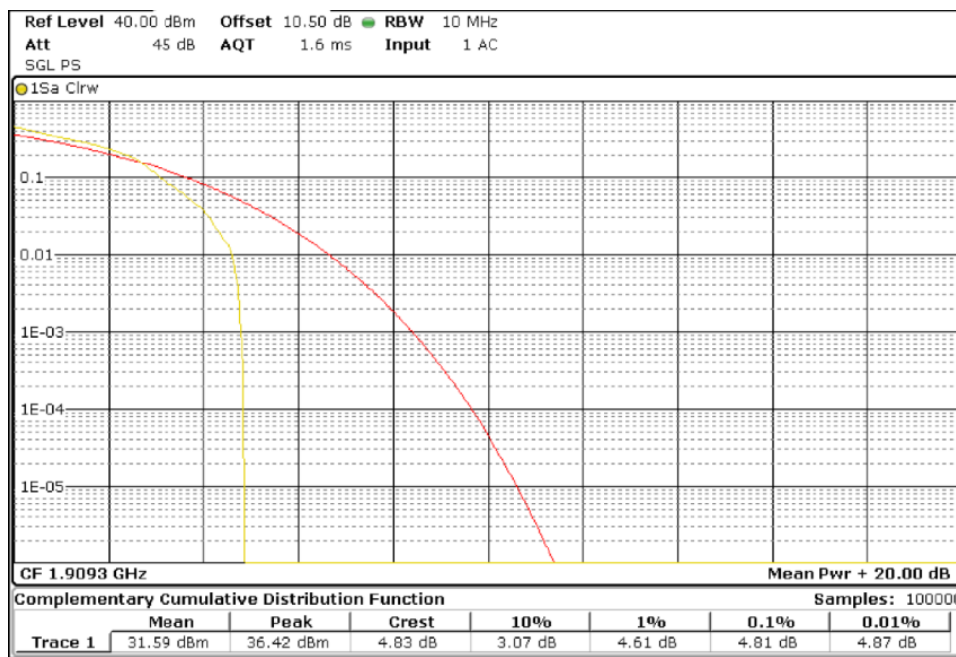

TEST RESULTS (Cont):

PAPR
 Bandwidth = 3 MHz. Modulation QPSK. RB Size: 1. RB Offset: 0.
 Lowest channel

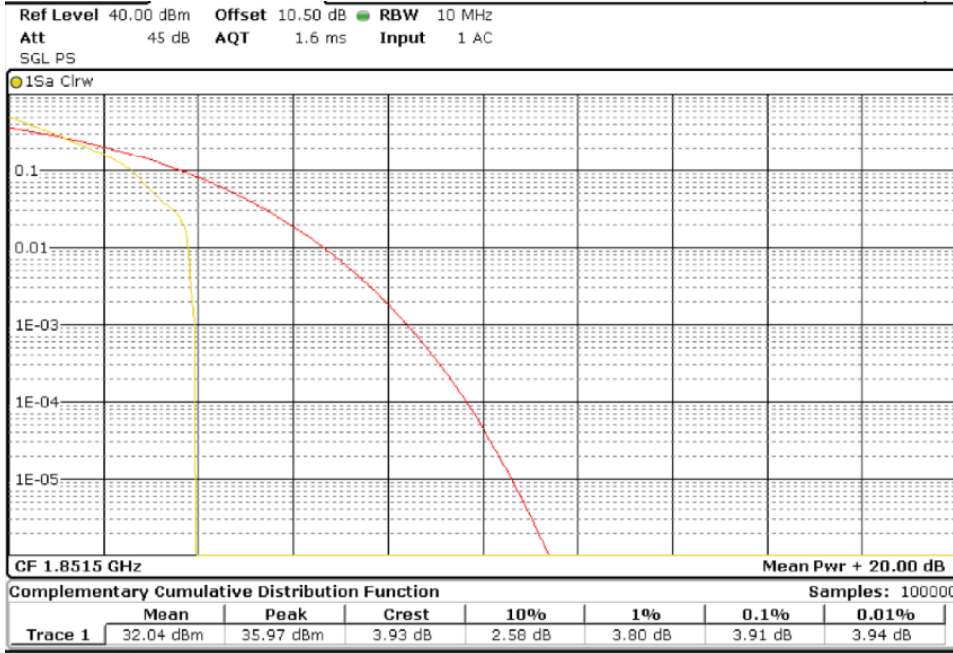

Middle channel

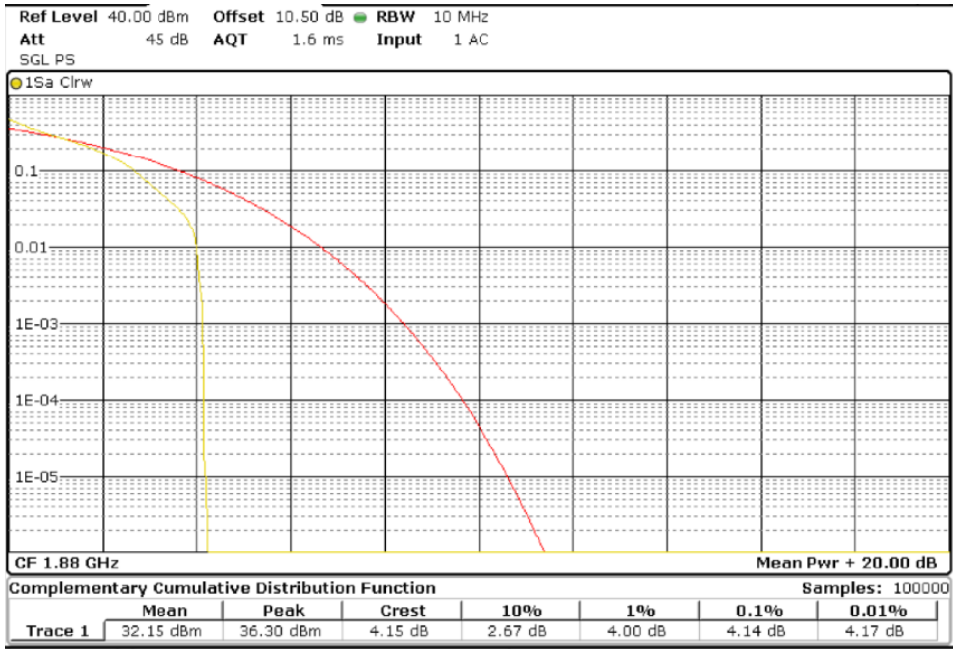

TEST RESULTS (Cont):

Highest channel

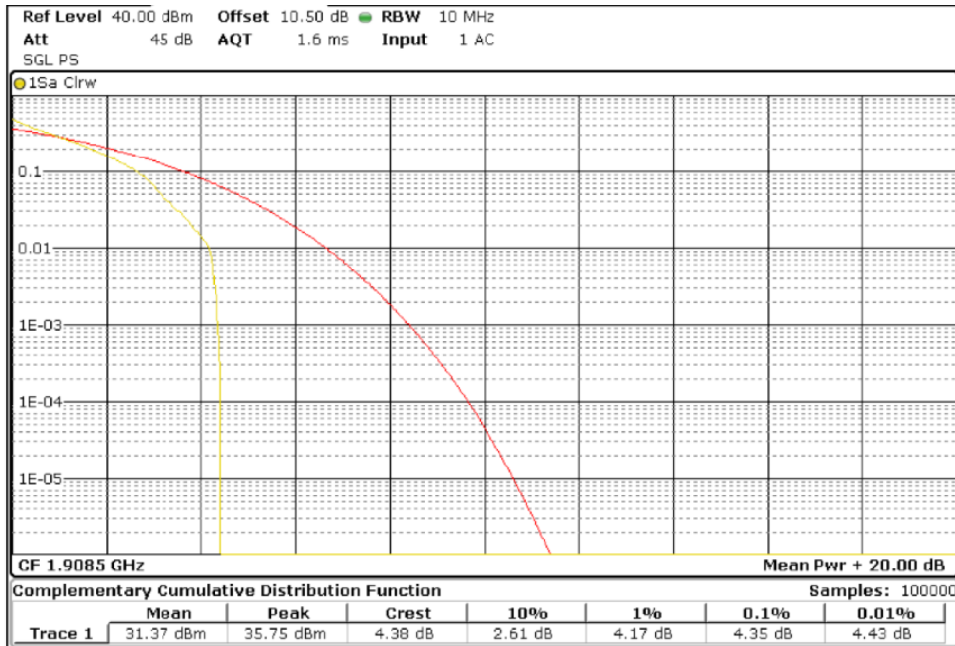

PAPR

Bandwidth = 3 MHz. Modulation 16QAM. RB Size: 1. RB Offset: 0.

Lowest channel

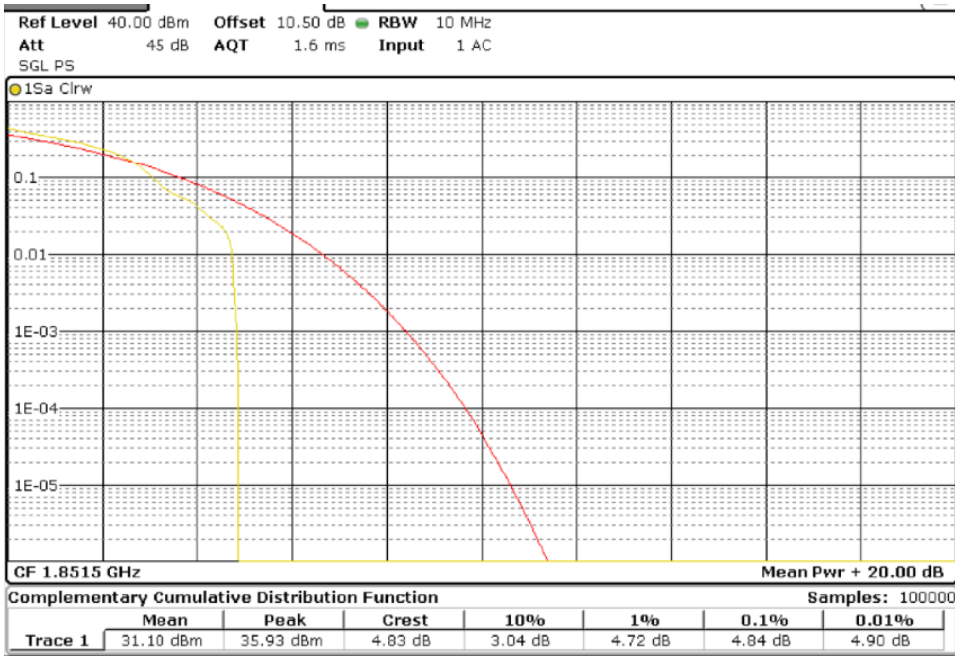

TEST RESULTS (Cont):

Middle channel

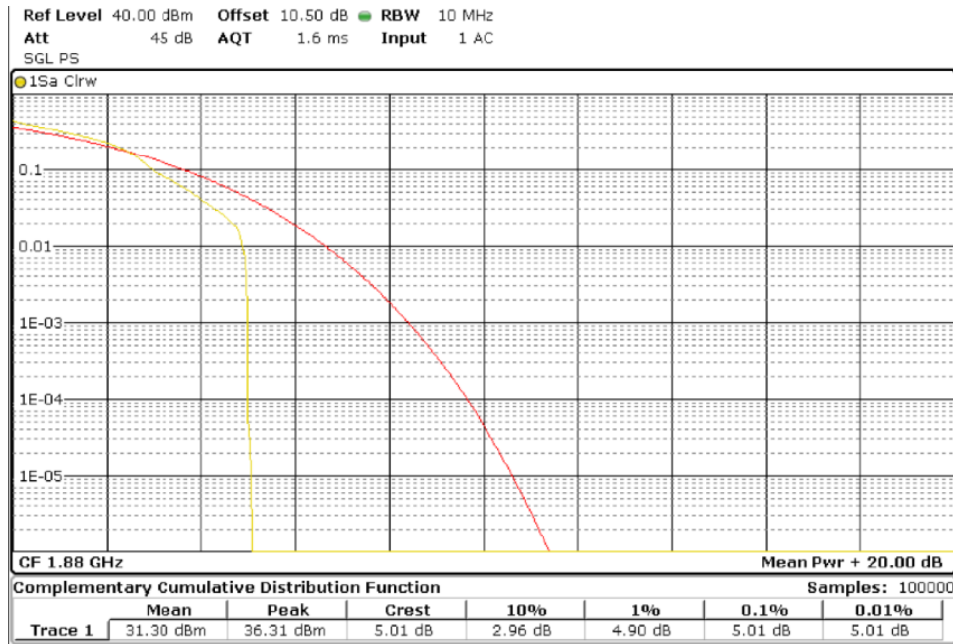

Highest channel

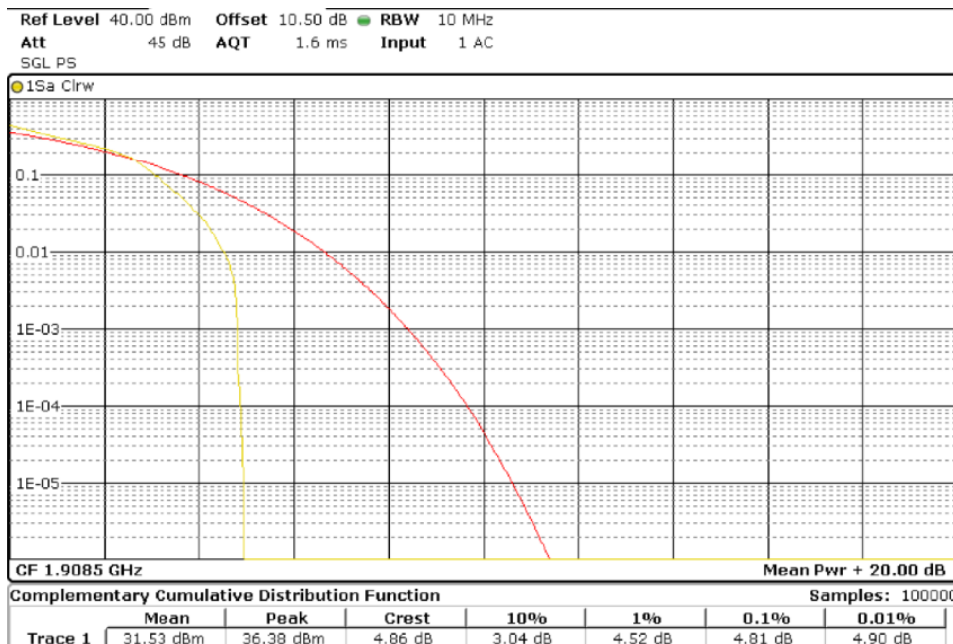

TEST RESULTS (Cont):

PAPR

Bandwidth = 5 MHz. Modulation QPSK. RB Size: 1. RB Offset: 0.
 Lowest channel

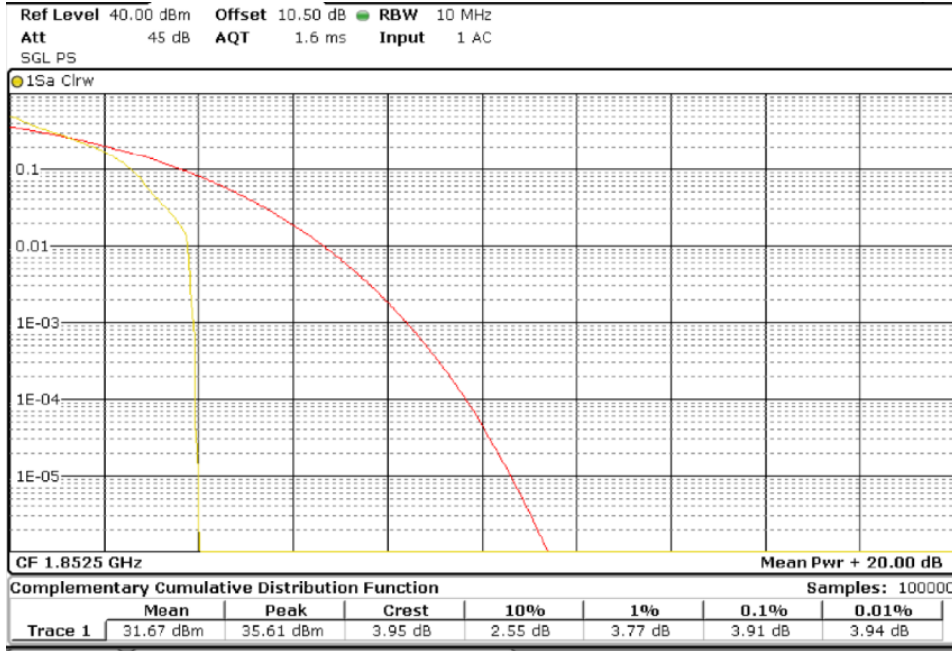

Middle channel

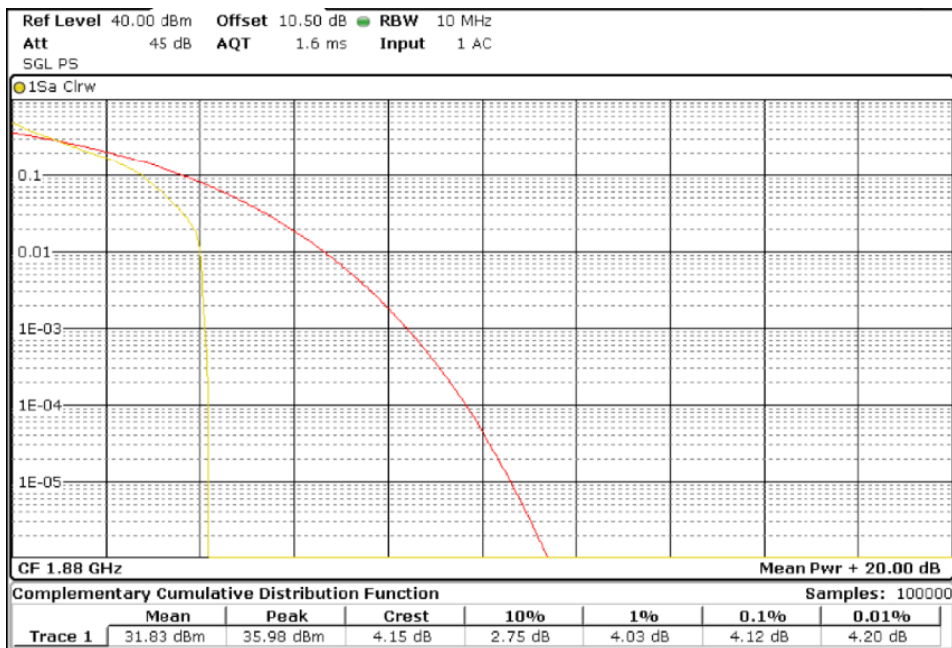

TEST RESULTS (Cont):

Highest channel

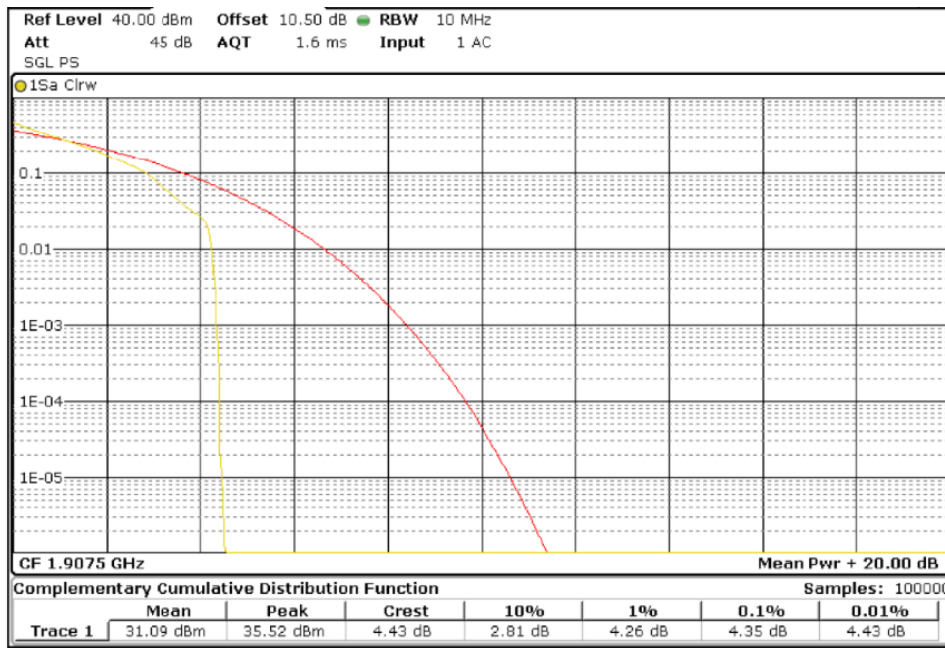

Bandwidth = 5 MHz. Modulation 16QAM. RB Size: 1. RB Offset: 0.
 Lowest channel

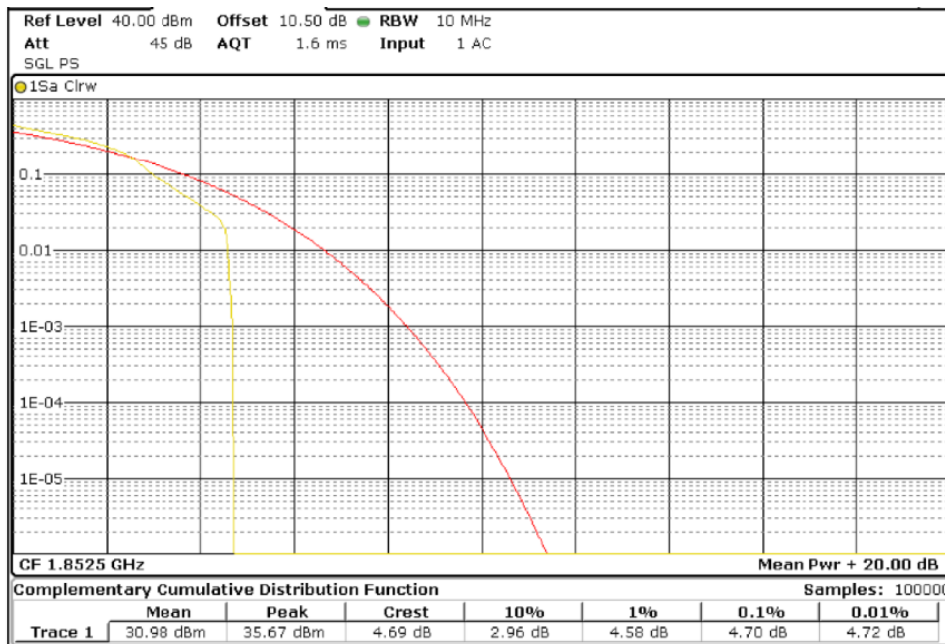

TEST RESULTS (Cont):

Middle channel

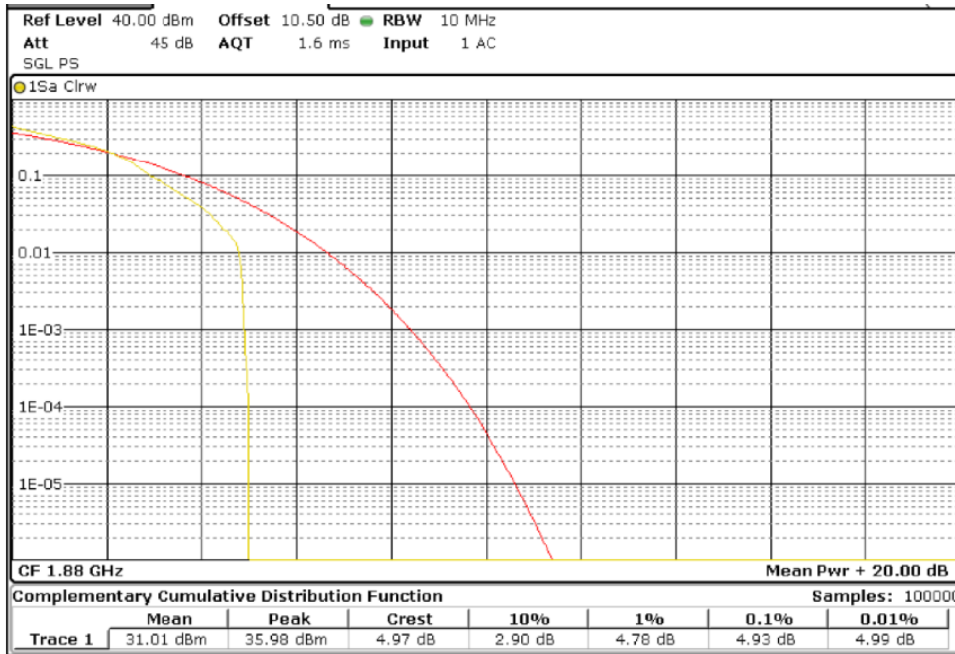

Highest channel

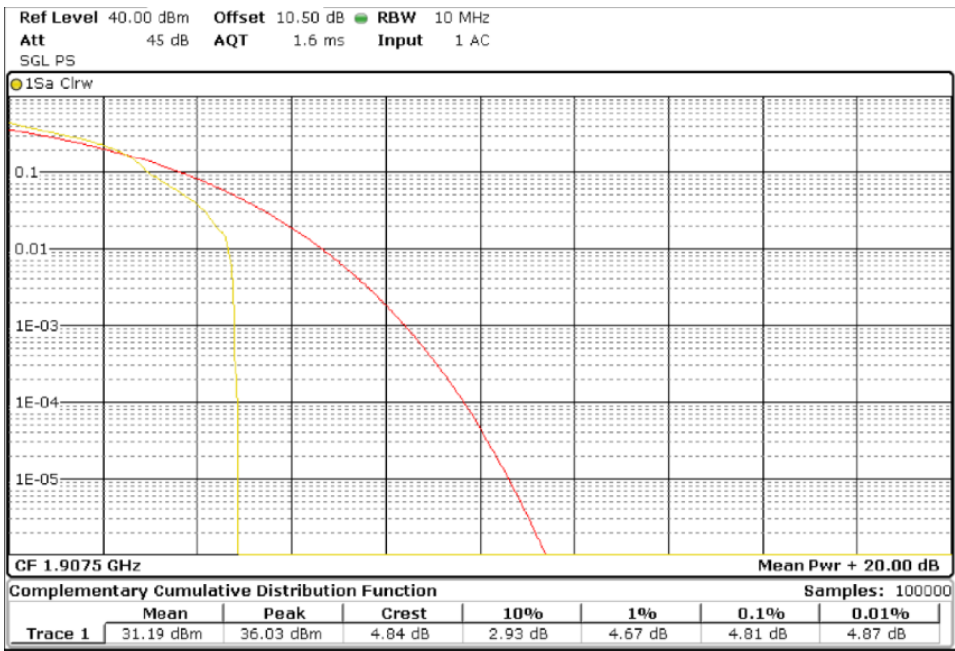

TEST RESULTS (Cont):

Bandwidth = 10 MHz. Modulation QPSK. RB Size: 1. RB Offset: 0.
 Lowest channel

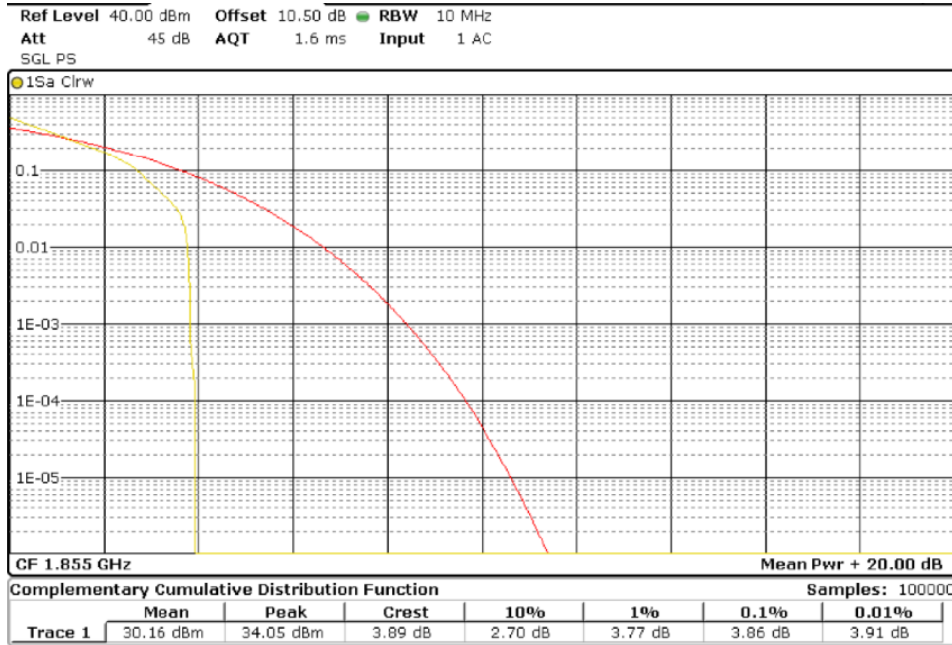

Middle channel

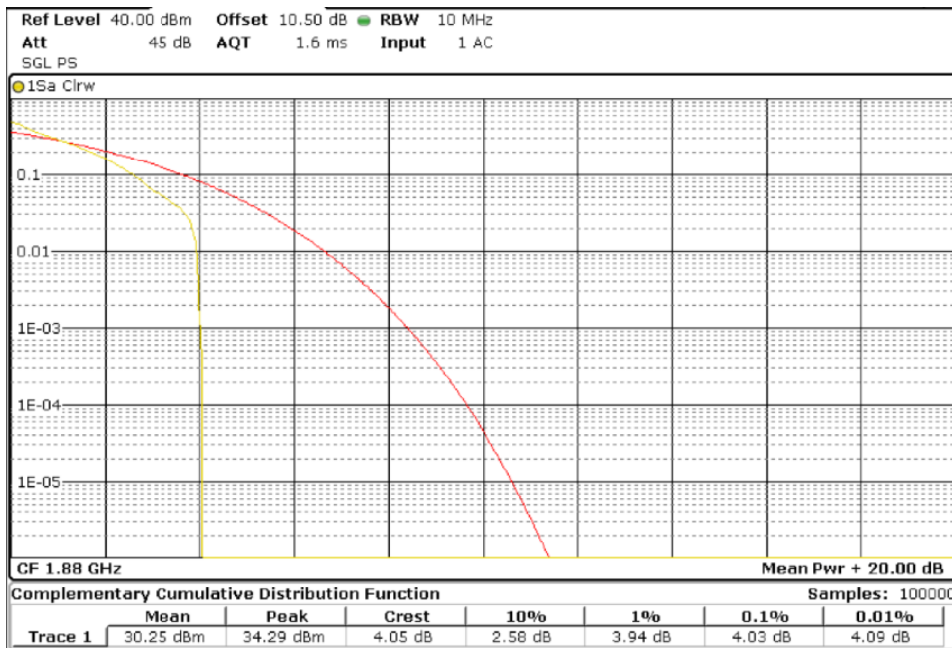

TEST RESULTS (Cont):

Highest channel

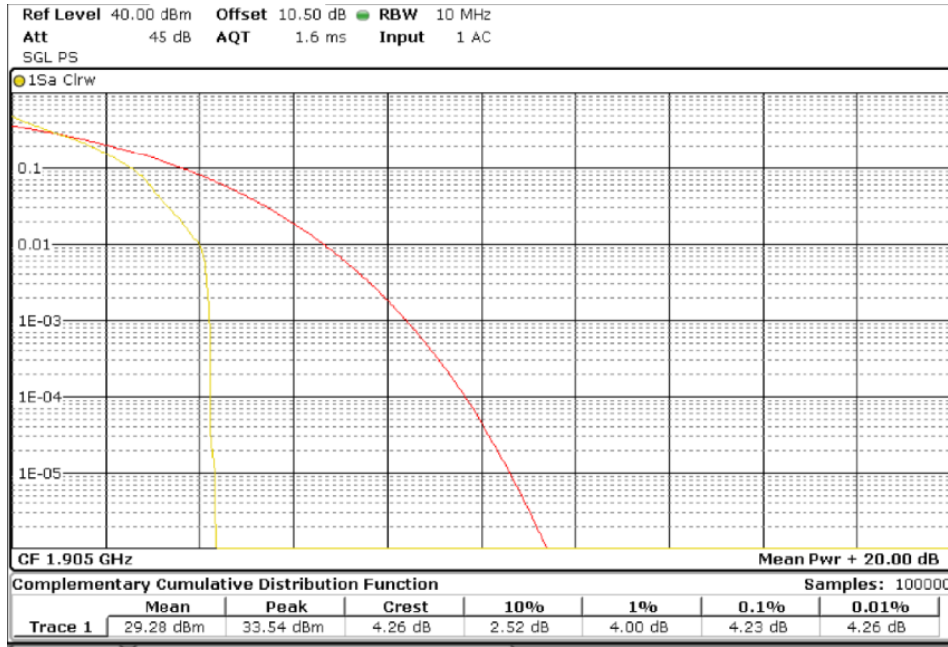

Bandwidth = 10 MHz. Modulation 16QAM. RB Size: 1. RB Offset: 0.
 Lowest channel

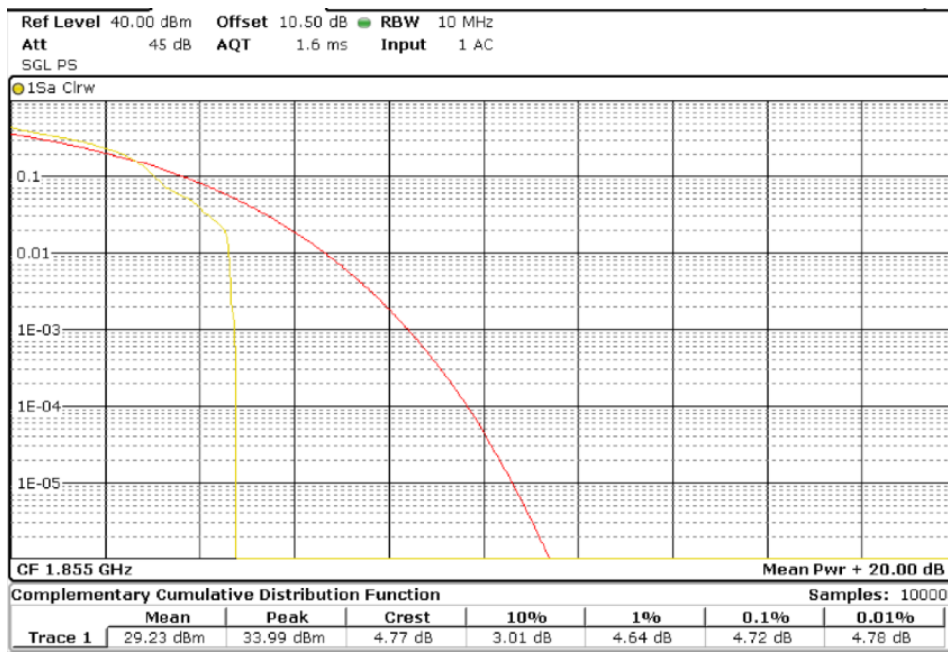

TEST RESULTS (Cont):

Middle channel

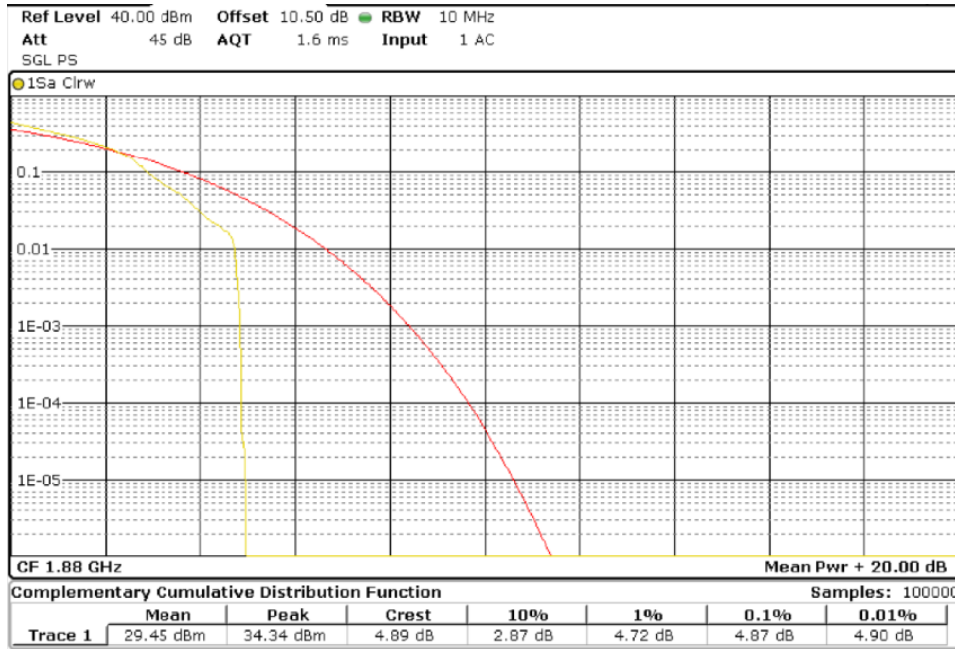

Highest channel

