

TEST RESULTS (Cont):

Highest Channel

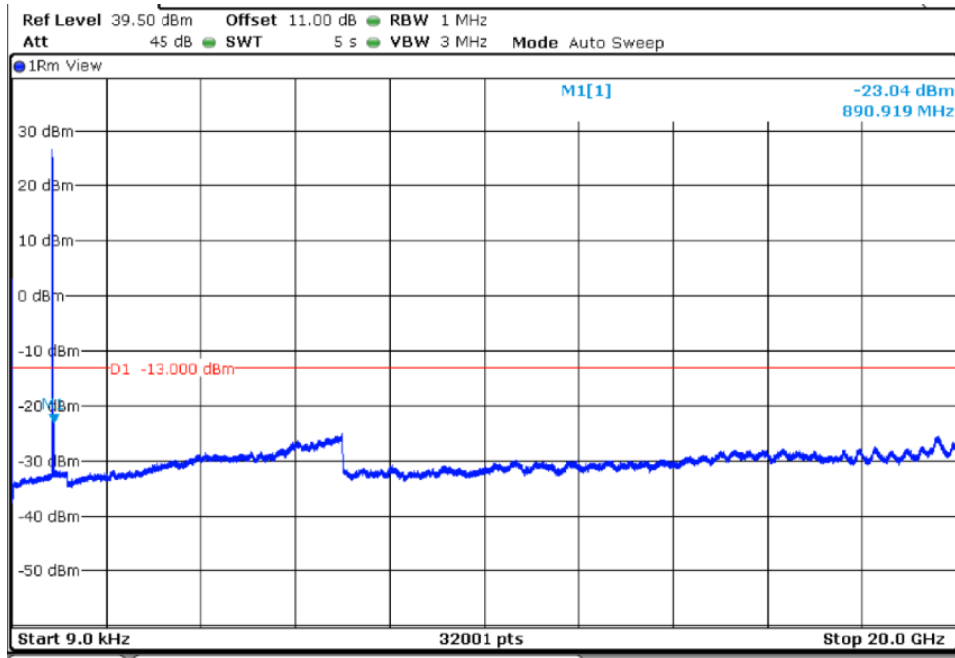

LTE QPSK MODULATION. BW = 10 MHz

Lowest Channel

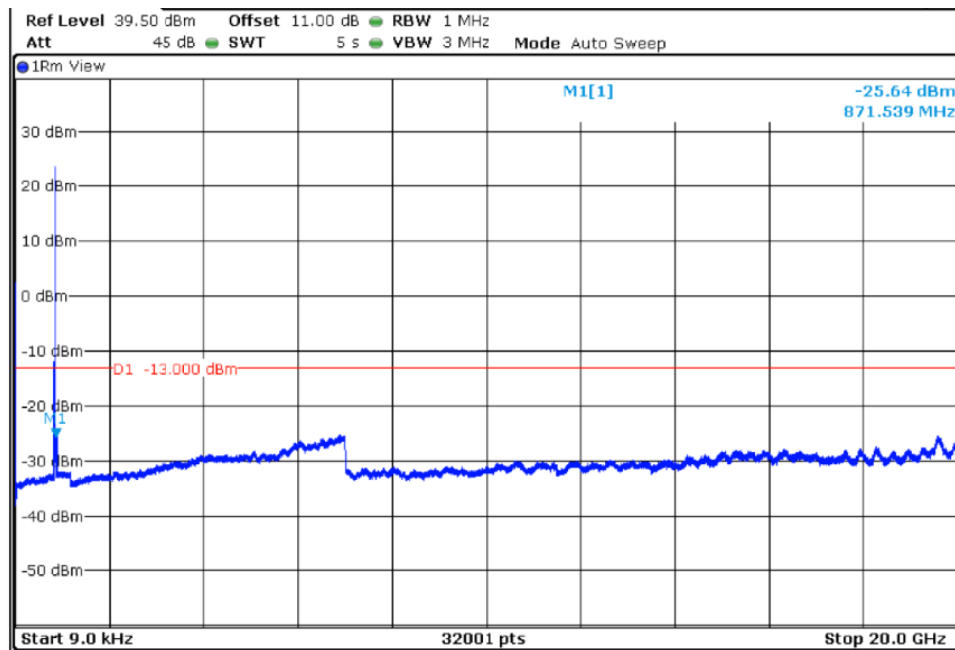

TEST RESULTS (Cont):

Middle Channel

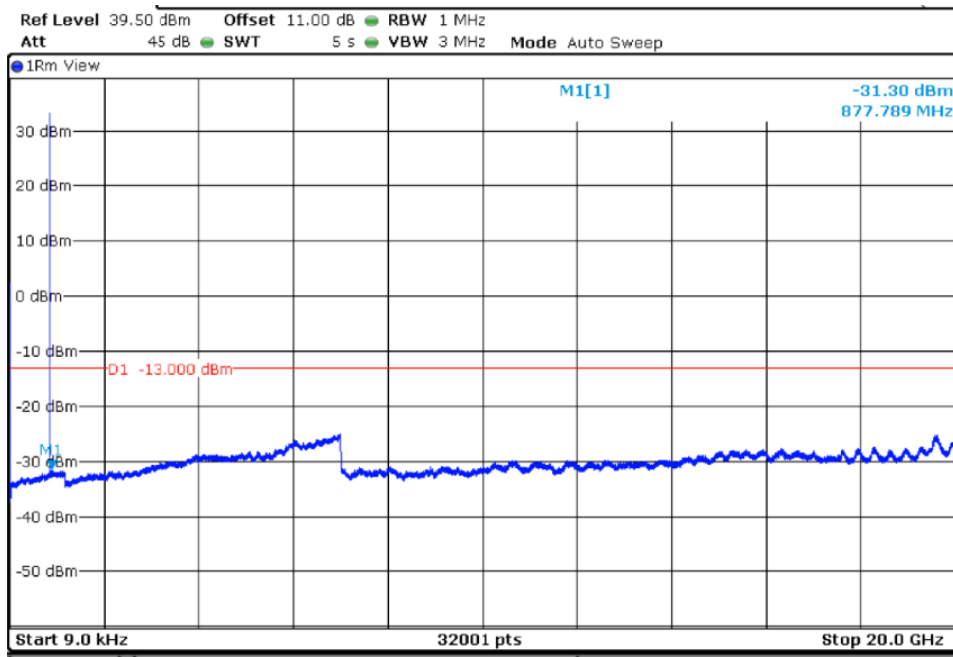

Highest Channel

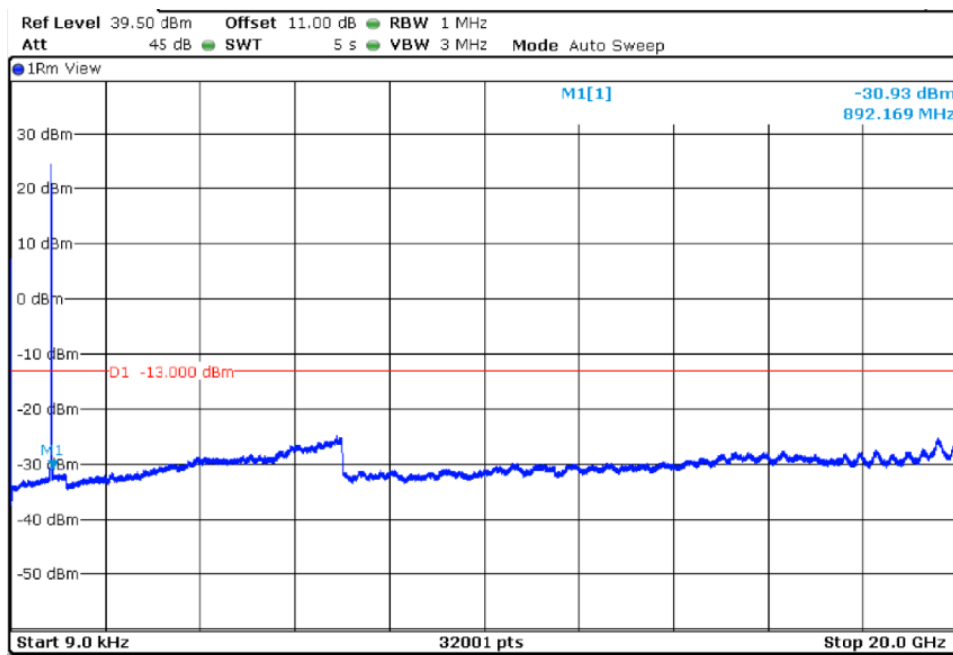

<b>TESTED SAMPLES:</b>	S/01
<b>TESTED CONDITIONS MODES:</b>	TC#02
<b>TEST RESULTS:</b>	PASS

Frequency range 9 kHz – 18 GHz

GPRS MODULATION.

Lowest Channel

No spurious signal was found at less than 20 dB respect to the limit in the frequency range.

Middle Channel

No spurious signal was found at less than 20 dB respect to the limit in the frequency range.

Highest Channel

No spurious signal was found at less than 20 dB respect to the limit in the frequency range.

GPRS MODULATION.

Lowest Channel

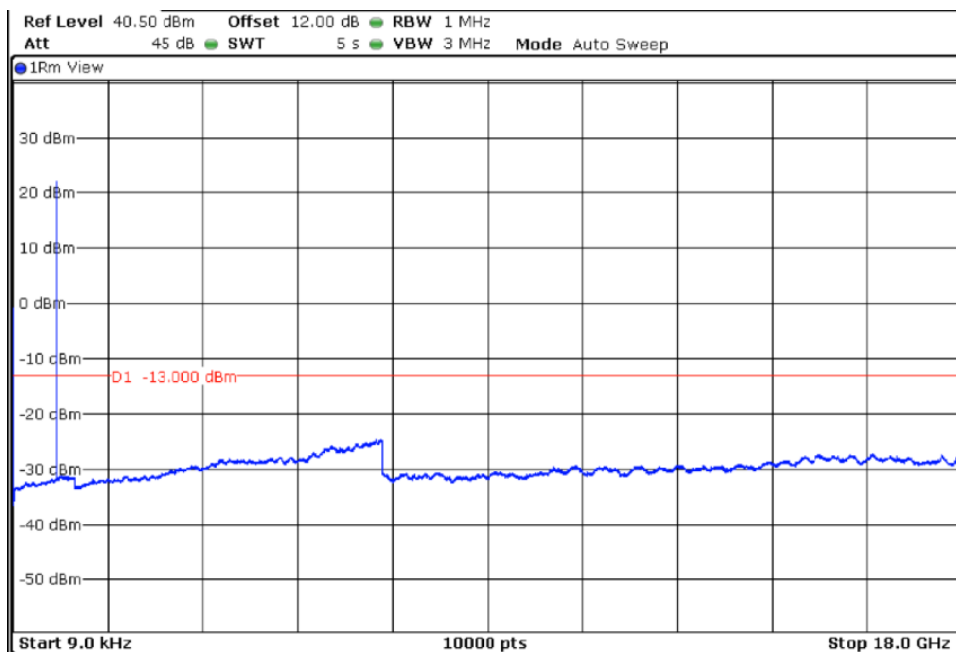

**TEST RESULTS (Cont):**

Middle Channel

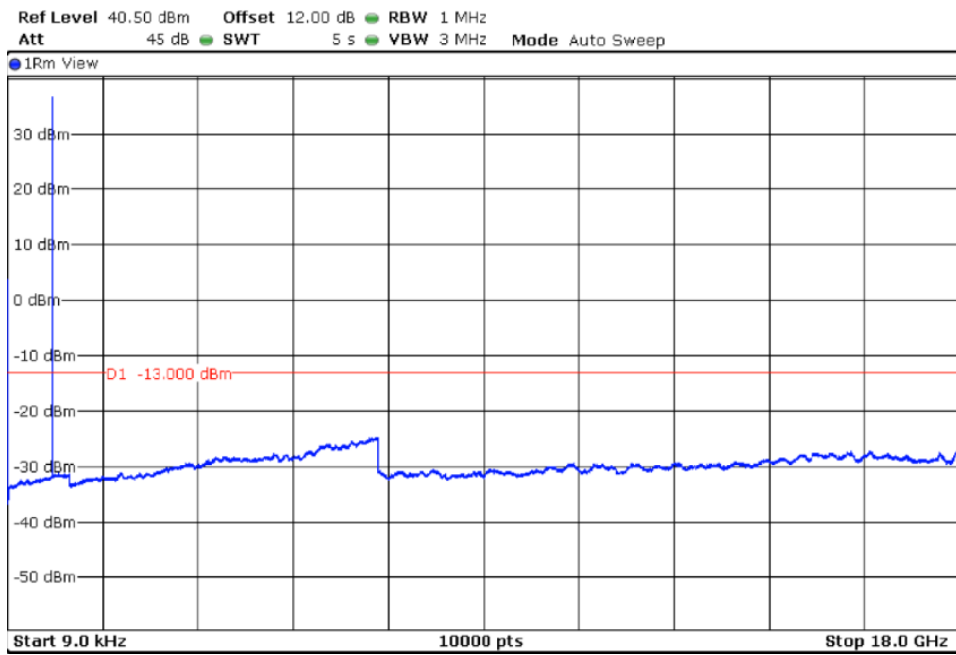

Highest Channel

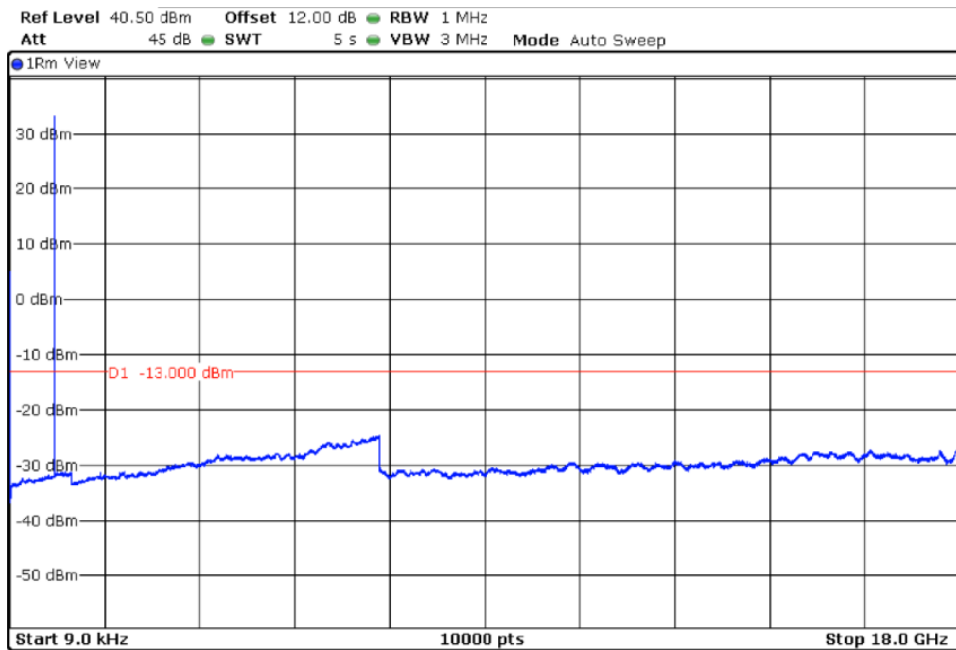

**TESTED SAMPLES:**

S/01

<b>TESTED CONDITIONS MODES:</b>	TC#03
<b>TEST RESULTS:</b>	PASS

Frequency range 9 kHz – 18 GHz

WCDMA MODULATION.

Lowest Channel

No spurious signal was found at less than 20 dB respect to the limit in the frequency range.

Middle Channel

No spurious signal was found at less than 20 dB respect to the limit in the frequency range.

Highest Channel

No spurious signal was found at less than 20 dB respect to the limit in the frequency range.

WCDMA MODULATION.

Lowest Channel

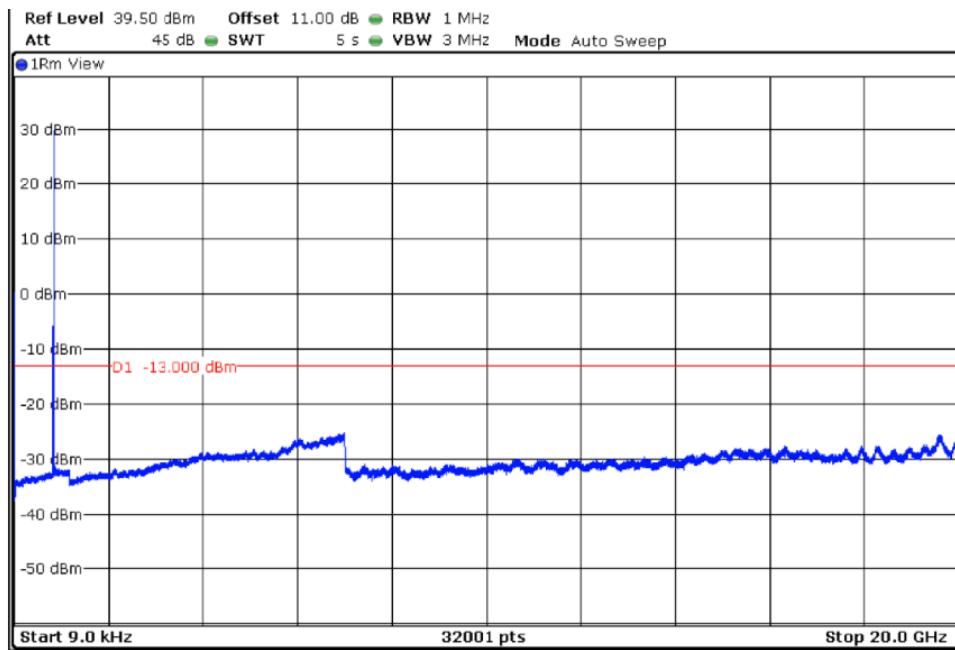

**TEST RESULTS (Cont):**

Middle Channel

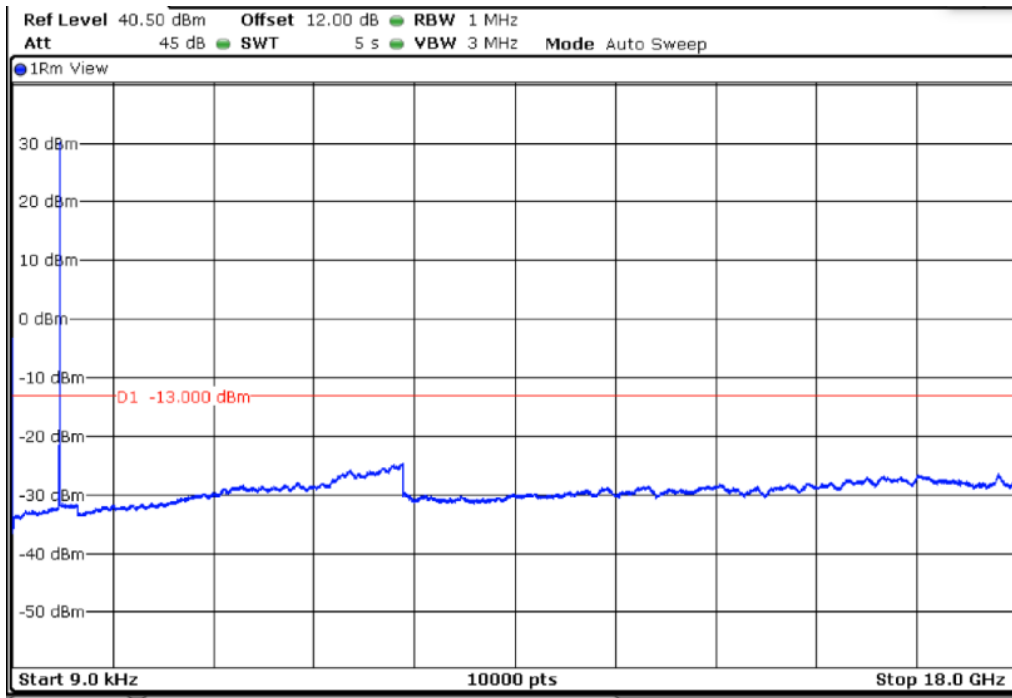

Highest Channel

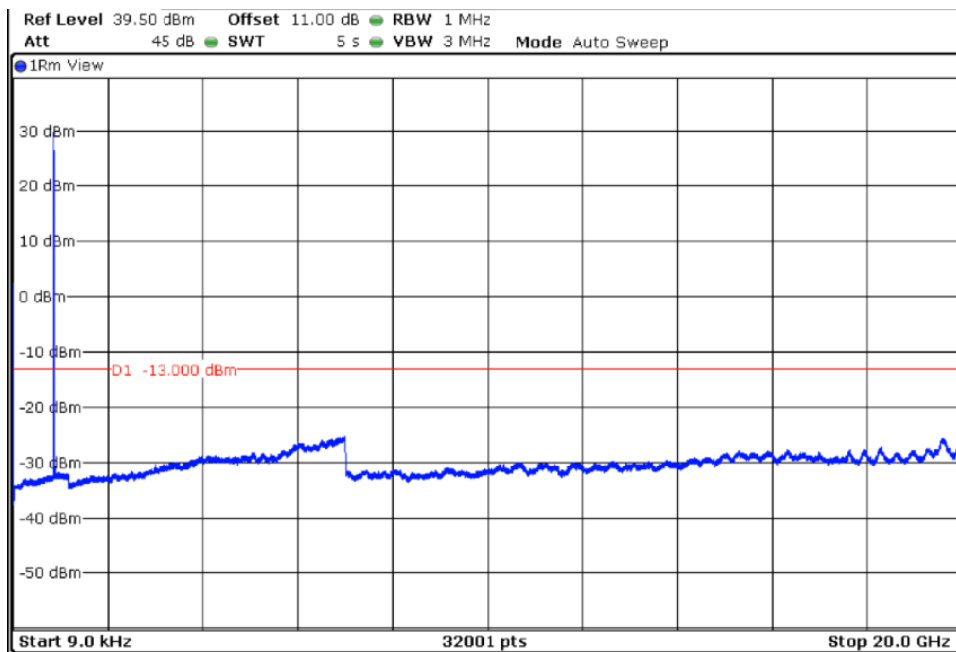

**TEST A6: SPURIOUS EMISSIONS AT ANTENNA TERMINALS AT BLOCK EDGES**

<b>LIMITS:</b>	Product standard:	FCC Part 22 / IC RSS-132
	Test standard:	FCC §2.1051 and 22.917 / RSS- Clause 5.5.

LIMITS

According to specification, the power of emissions shall be attenuated below the transmitter power (P) by a factor of at least  $43 + 10 \log (P)$  dB. P in watts.

At  $P_o$  transmitting power of 2 watts (33 dBm), the specified minimum attenuation becomes  $43 + 10 \log (P_o)$ , and the level in dBm relative to  $P_o$  becomes:

$$P_o \text{ (dBm)} - [43 + 10 \log (P_o \text{ in watts})] = -13 \text{ dBm}$$

**TEST SETUP**

The EUT RF output connector was connected to a spectrum analyzer and to the Universal Radio Communication Tester R&S CMW500 (selecting maximum transmission power of the EUT and different modes of modulation) using a 50-ohm attenuator and a power splitter.

The reading of the spectrum analyzer is corrected with the attenuation loss of connection between output terminal of EUT and input of the spectrum analyzer.

For LTE mode the configuration of modulation which is the worst case for conducted power was used.

As indicated in FCC part 22, in the 1 MHz bands immediately outside and adjacent to the licensee's frequency block or band, a resolution bandwidth of at least one percent of the emission bandwidth of the fundamental emission of the transmitter may be employed.

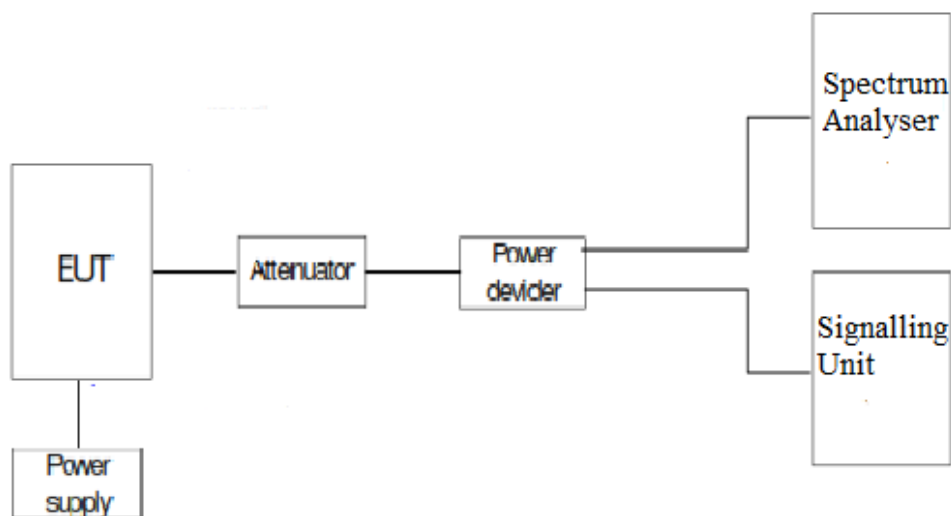

<b>TESTED SAMPLES:</b>	S/01
<b>TESTED CONDITIONS MODES:</b>	TC#01
<b>TEST RESULTS:</b>	PASS

LTE QPSK MODULATION	RB=1 Offset =0 BW = 1.4 MHz	RB=1 Offset =0 BW = 3 MHz	RB=1. Offset =0 BW = 5 MHz	RB=1 Offset =0 BW = 10 MHz
Maximum measured level at lowest Block Edge at antenna port (dBm)	-23.09	-19.82	-21.85	-20.63

LTE QPSK MODULATION	RB=6 Offset =0 BW = 1.4 MHz	RB=15 Offset =0 BW = 3 MHz	RB=25 Offset =0 BW = 5 MHz	RB=50 Offset =0 BW = 10 MHz
Maximum measured level at lowest Block Edge at antenna port (dBm)	-20.88	-21.81	-20.71	-20.87

LTE QPSK MODULATION	RB=1 Offset =5 BW = 1.4 MHz	RB=1 Offset =14 BW = 3 MHz	RB=1 Offset =24 BW = 5 MHz	RB=1 Offset =49 BW = 10 MHz
Maximum measured level at Highest Block Edge at antenna port (dBm)	-26.45	-22.93	-23.49	-28.76

LTE QPSK MODULATION	RB=6 Offset =0 BW = 1.4 MHz	RB=15 Offset =0 BW = 3 MHz	RB=25 Offset =0 BW = 5 MHz	RB=50 Offset =0 BW = 10 MHz
Maximum measured level at Highest Block Edge at antenna port (dBm)	-20.35	-22.11	-21.24	-24.49



**TEST RESULTS (Cont):**

LTE QPSK MODULATION. RB = 1. Offset = 0. BW = 1.4 MHz

Lowest Channel

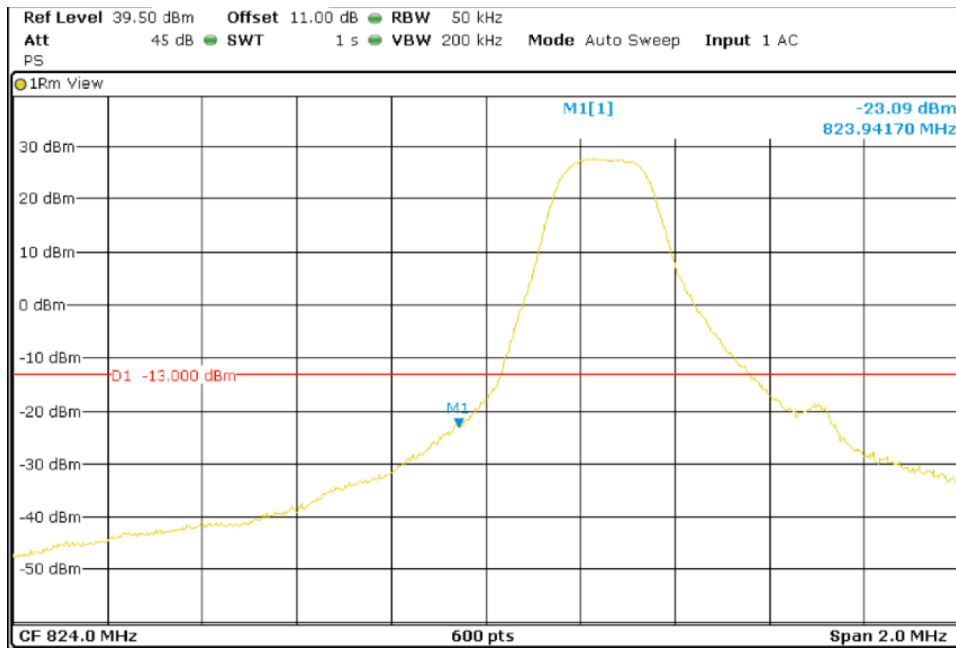

Highest Channel

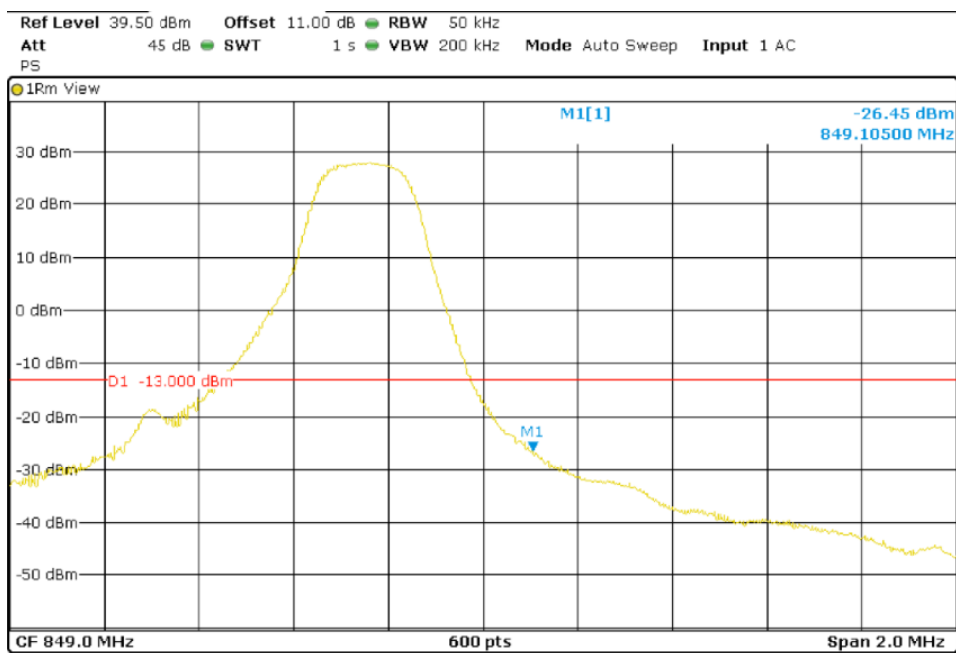

**TEST RESULTS (Cont):**

LTE QPSK MODULATION. RB = 6. Offset = 0. BW = 1.4 MHz

Lowest Channel

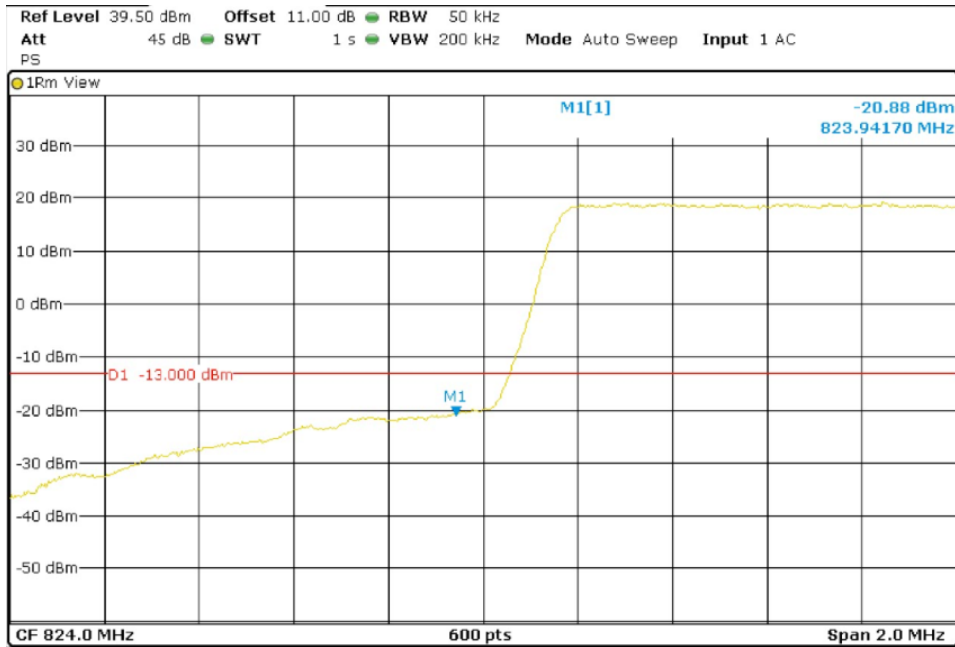

Highest Channel

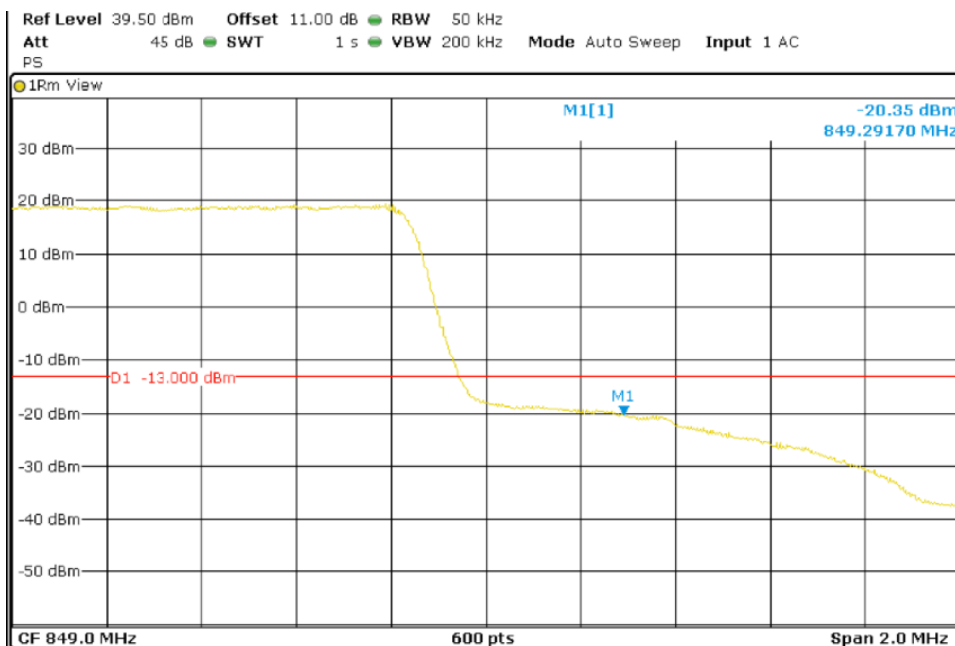

**TEST RESULTS (Cont):**

LTE QPSK MODULATION. RB = 1. Offset = 0. BW = 3 MHz

Lowest Channel

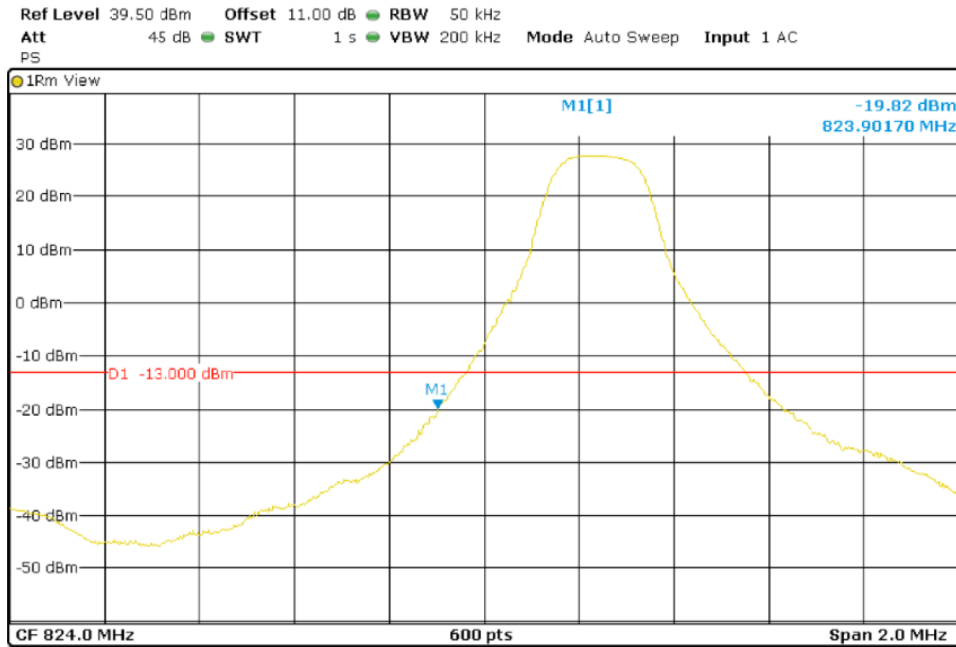

Highest Channel

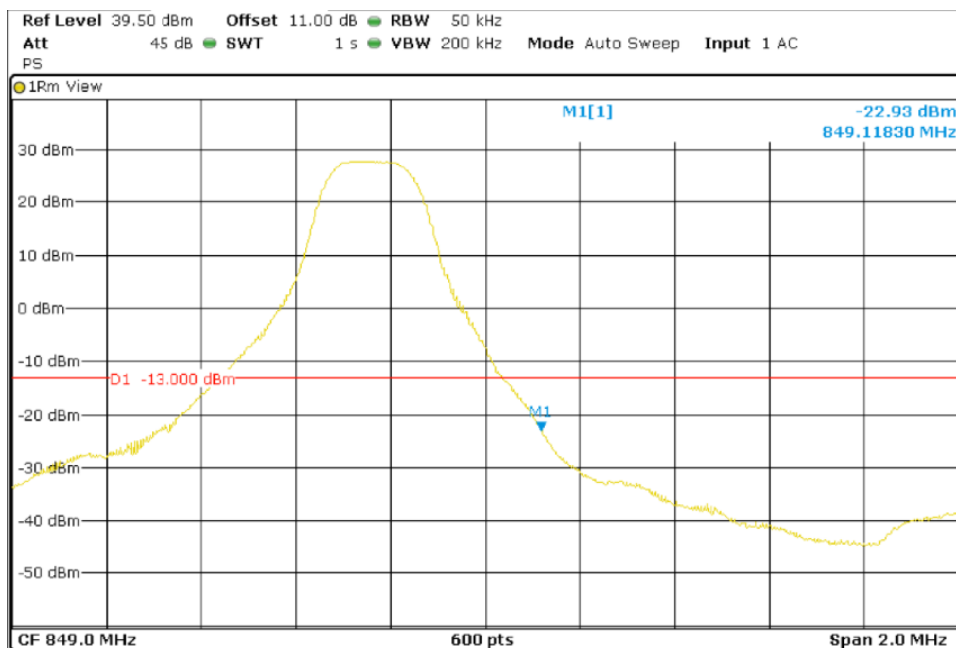

**TEST RESULTS (Cont):**

LTE QPSK MODULATION. RB = 15. Offset = 0. BW = 3 MHz

Lowest Channel

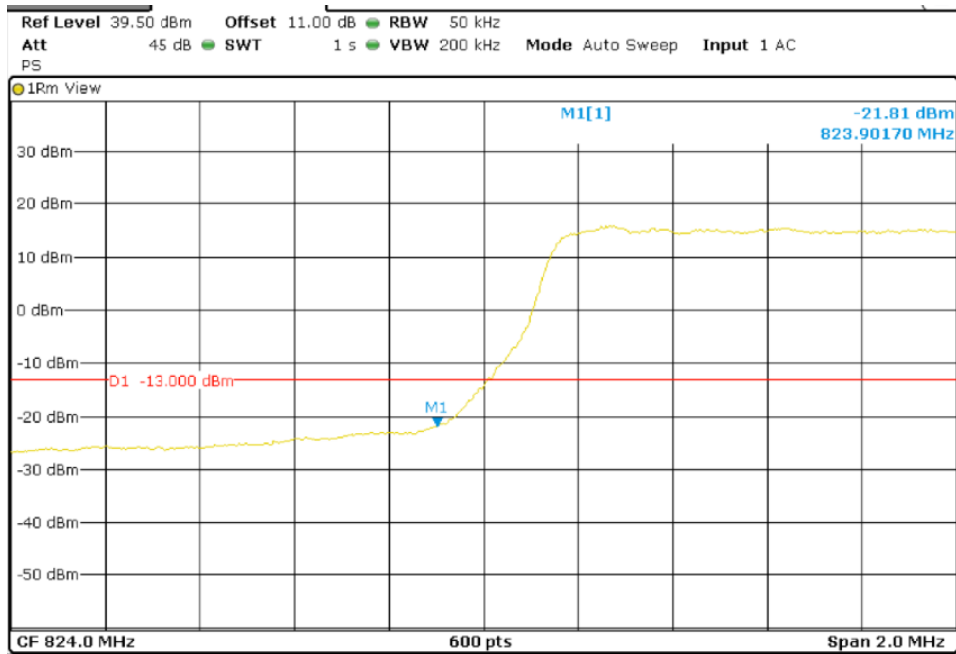

Highest Channel

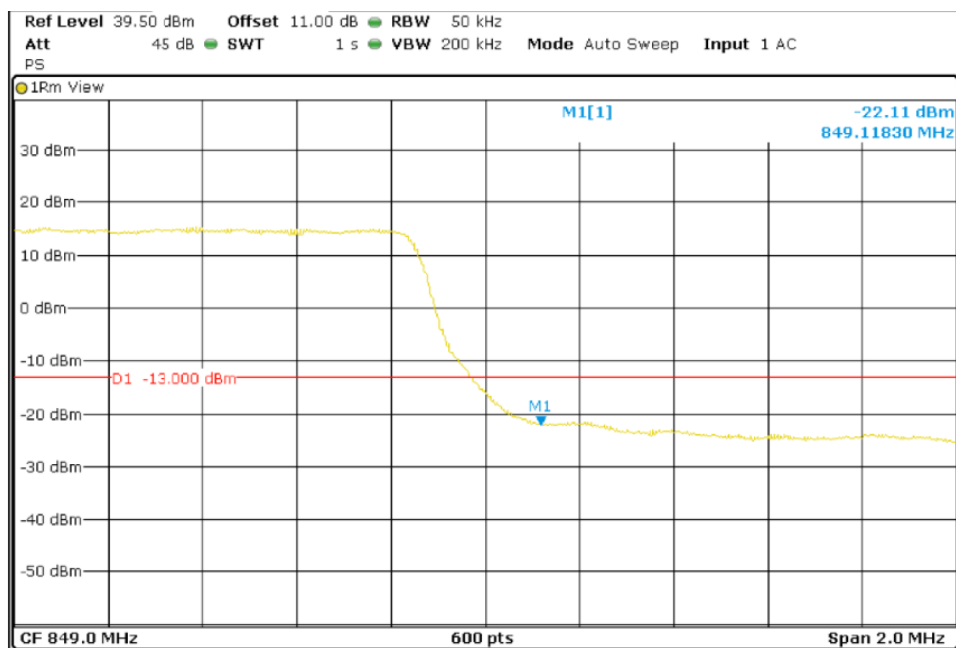

**TEST RESULTS (Cont):**

LTE QPSK MODULATION. RB = 1. Offset = 0. BW = 5 MHz

Lowest Channel

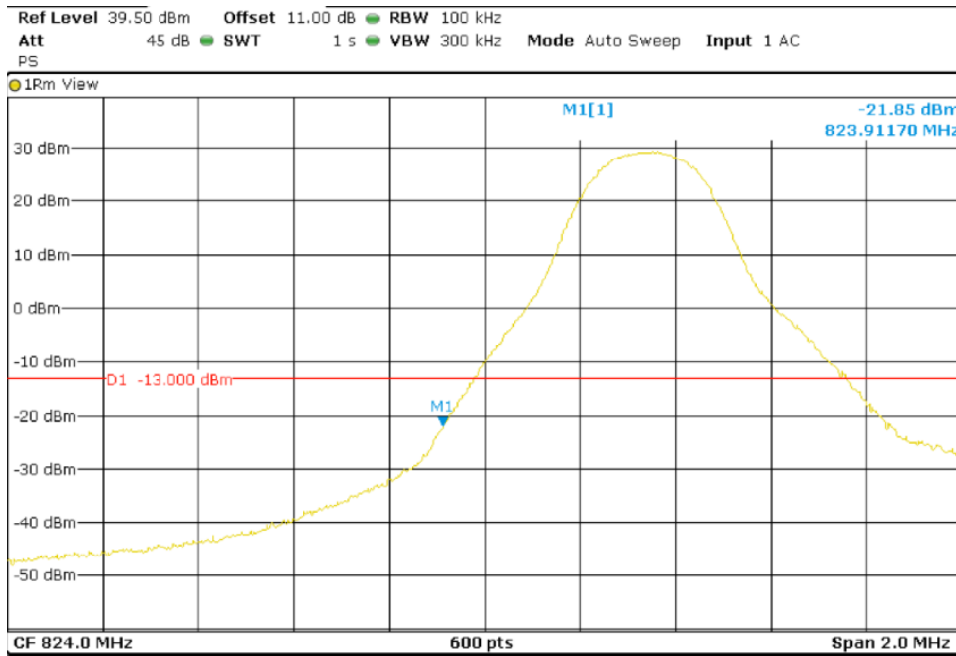

Highest Channel

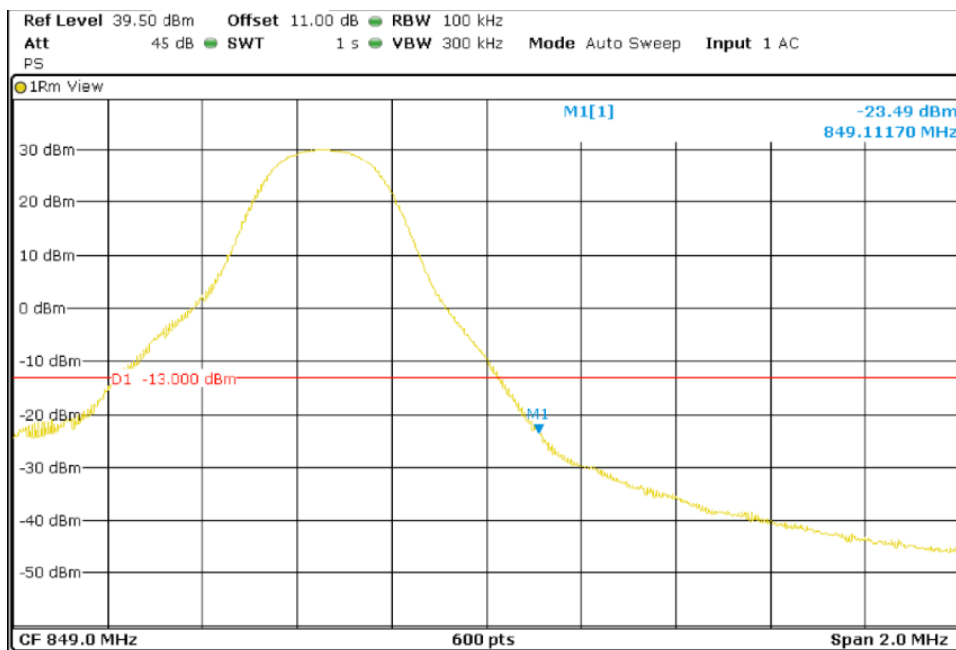

**TEST RESULTS (Cont):**

LTE QPSK MODULATION. RB = 25. Offset = 0. BW = 5 MHz

Lowest Channel

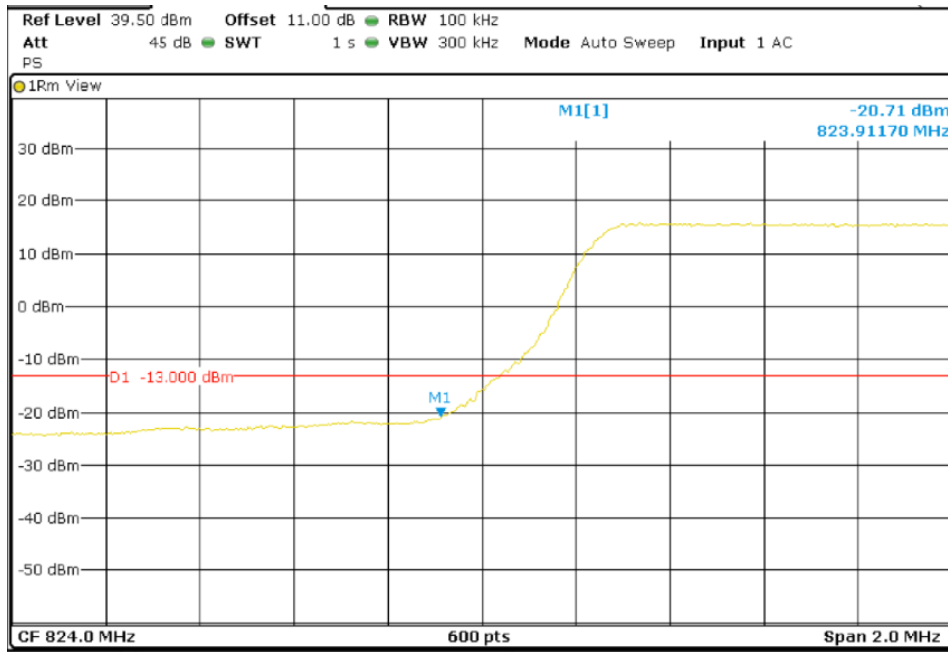

Highest Channel

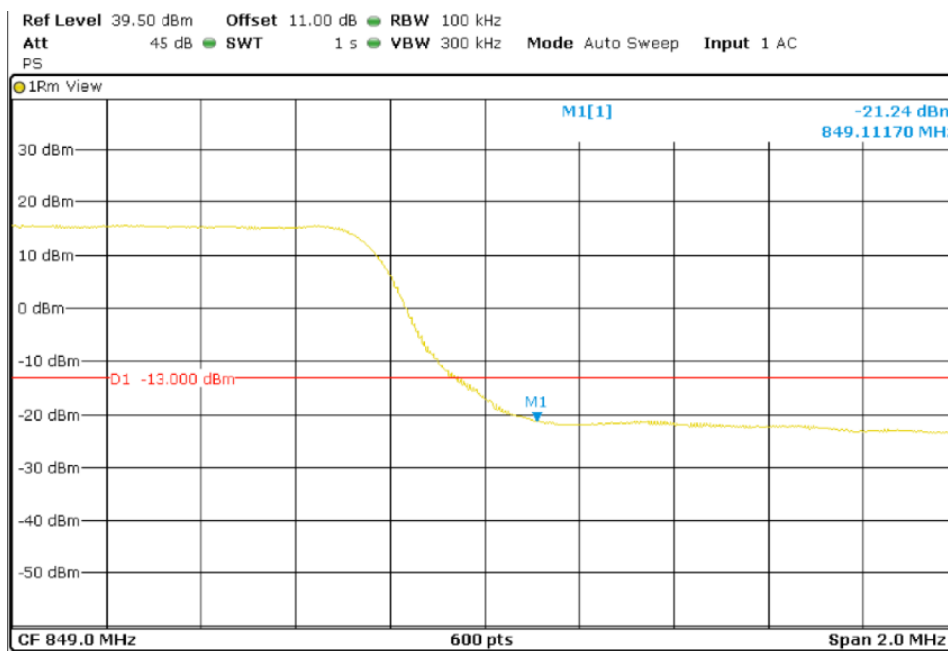

**TEST RESULTS (Cont):**

LTE QPSK MODULATION. RB = 1. Offset = 0. BW = 10 MHz

Lowest Channel

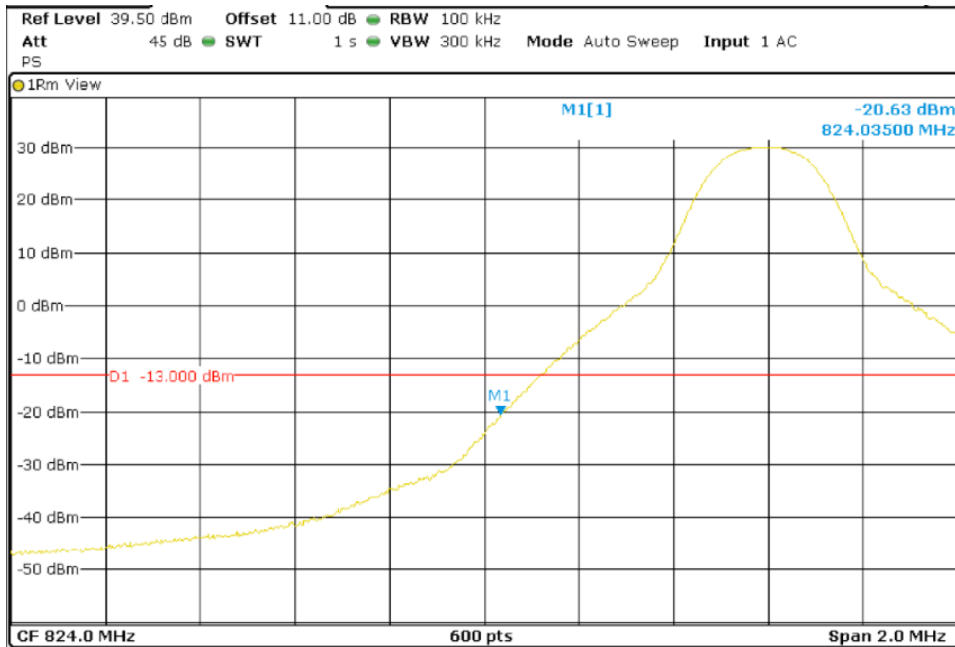

Highest Channel

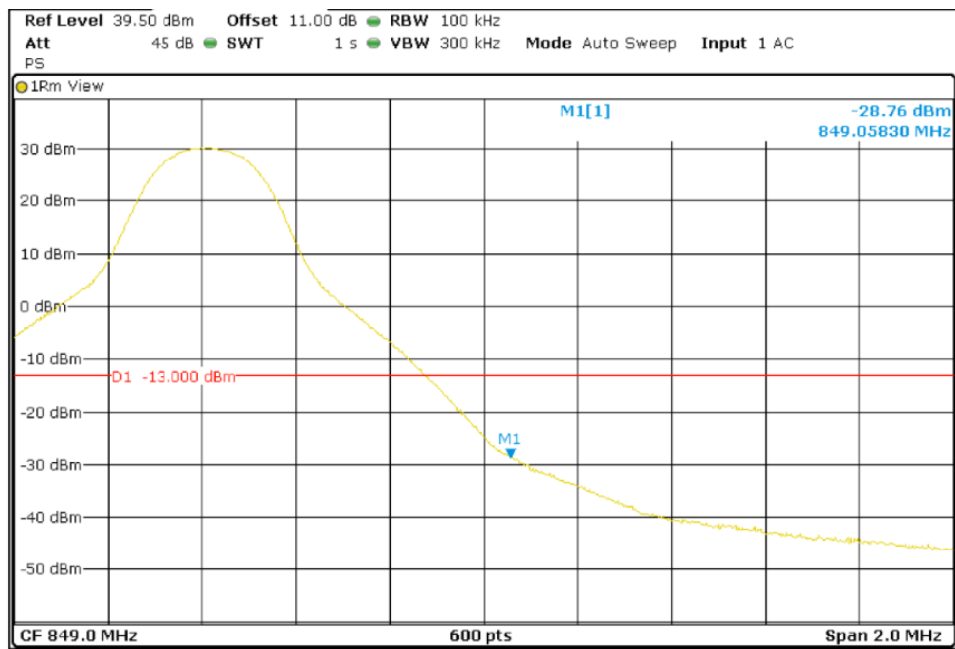

**TEST RESULTS (Cont):**

LTE QPSK MODULATION. RB = 50. Offset = 0. BW = 10 MHz

Lowest Channel

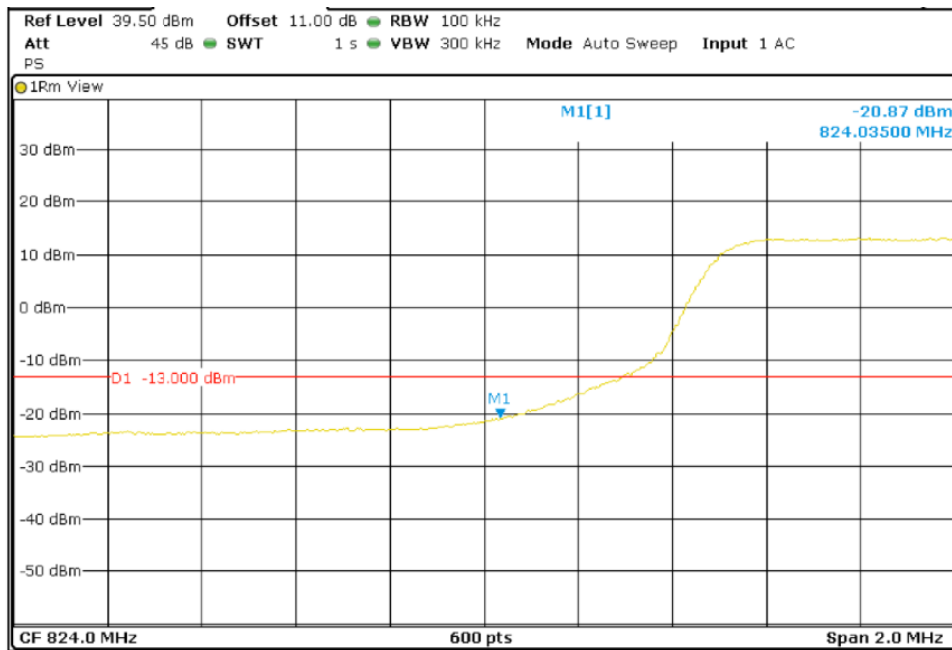

Highest Channel

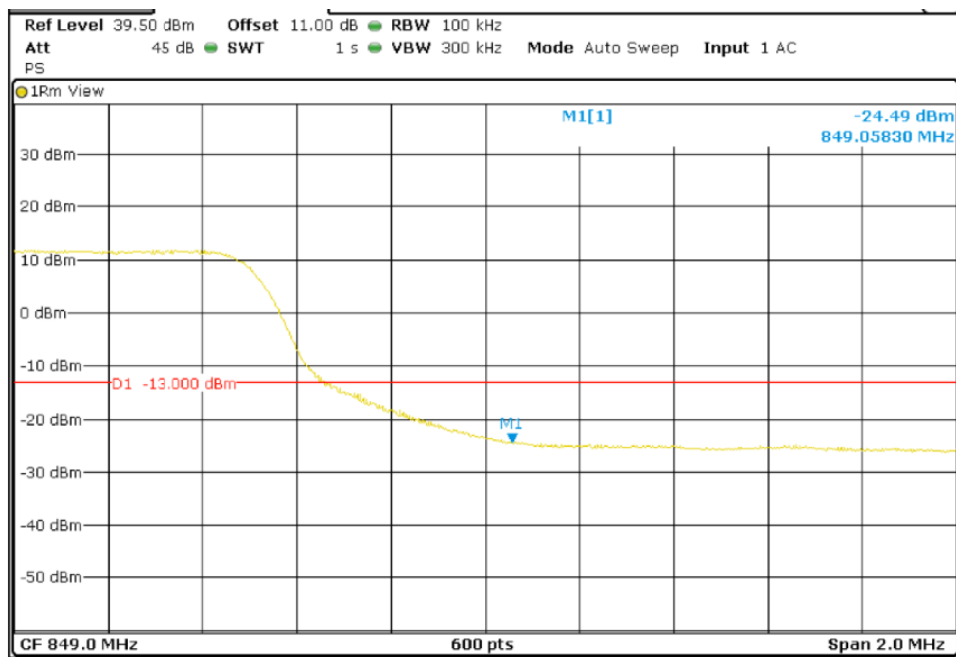



<b>TESTED SAMPLES:</b>	S/01
<b>TESTED CONDITIONS MODES:</b>	TC#02
<b>TEST RESULTS:</b>	PASS

GPRS Modulation

MODULATION	GPRS
Maximum measured level at highest Block Edge at antenna port (dBm)	-18.04

MODULATION	GPRS
Maximum measured level at highest Block Edge at antenna port (dBm)	-16.42

Lowest Channel

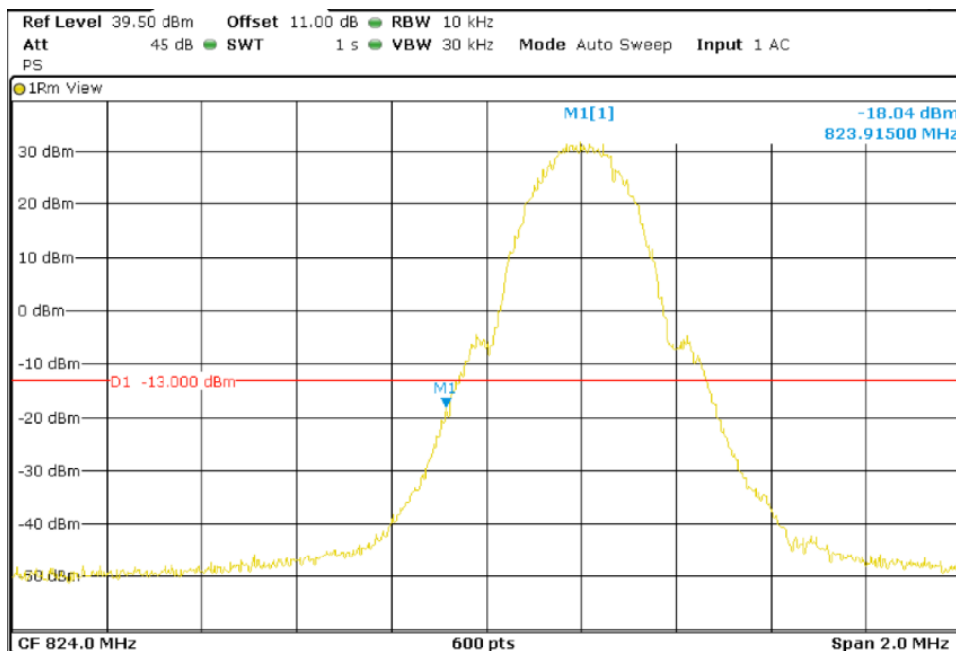

**TEST RESULTS (Cont):**

Highest Channel

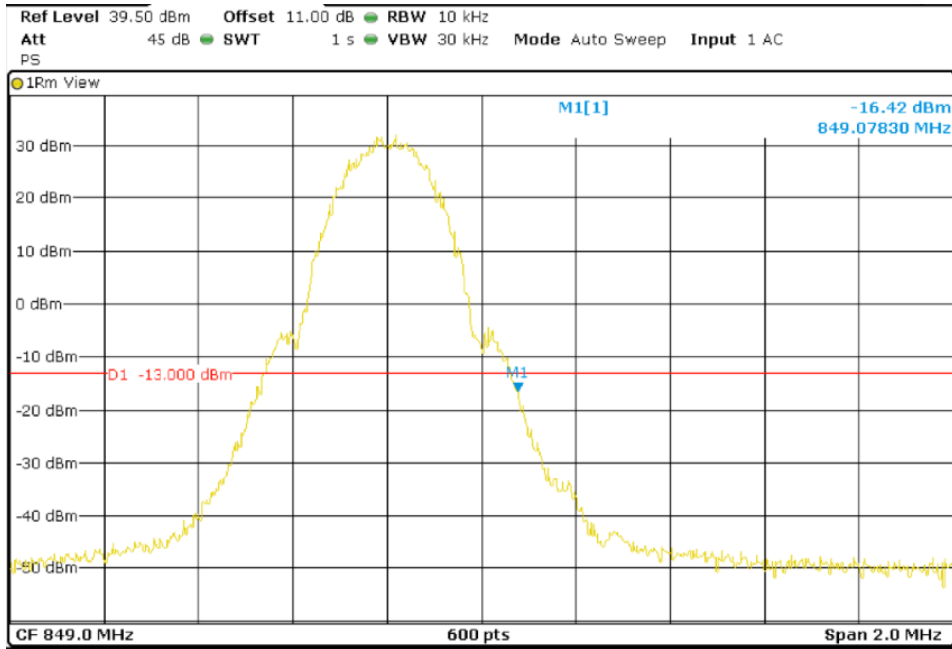

<b>TESTED SAMPLES:</b>	S/01
<b>TESTED CONDITIONS MODES:</b>	TC#03
<b>TEST RESULTS:</b>	PASS

WCDMA Modulation

MODULATION	WCDMA
Maximum measured level at highest Block Edge at antenna port (dBm)	-27.74
MODULATION	WCDMA
Maximum measured level at highest Block Edge at antenna port (dBm)	-28.83

**TEST RESULTS (Cont):**

**WCDMA MODULATION**

Lowest Channel

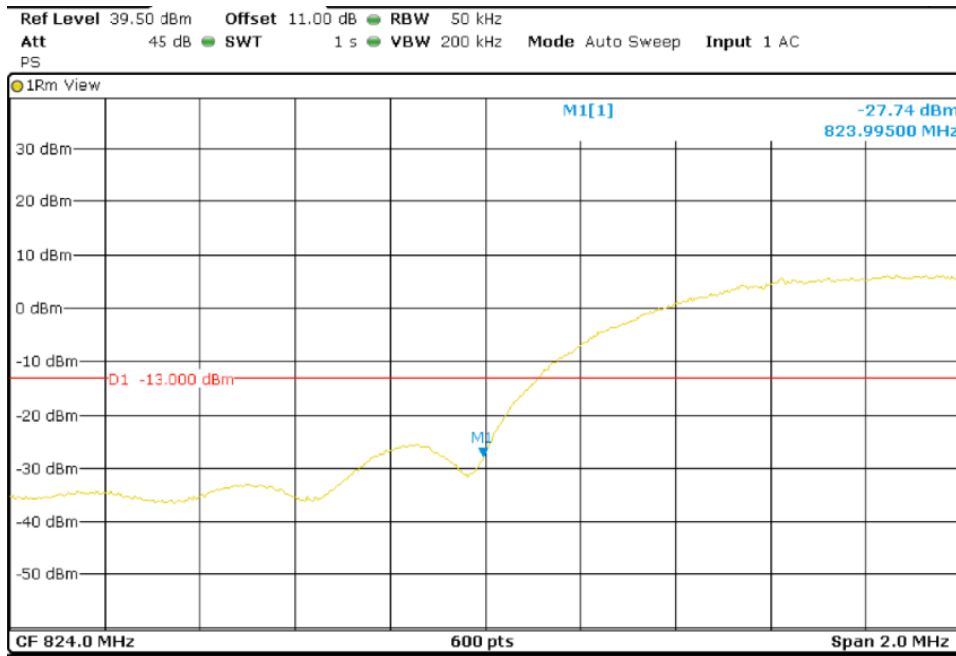

Highest Channel

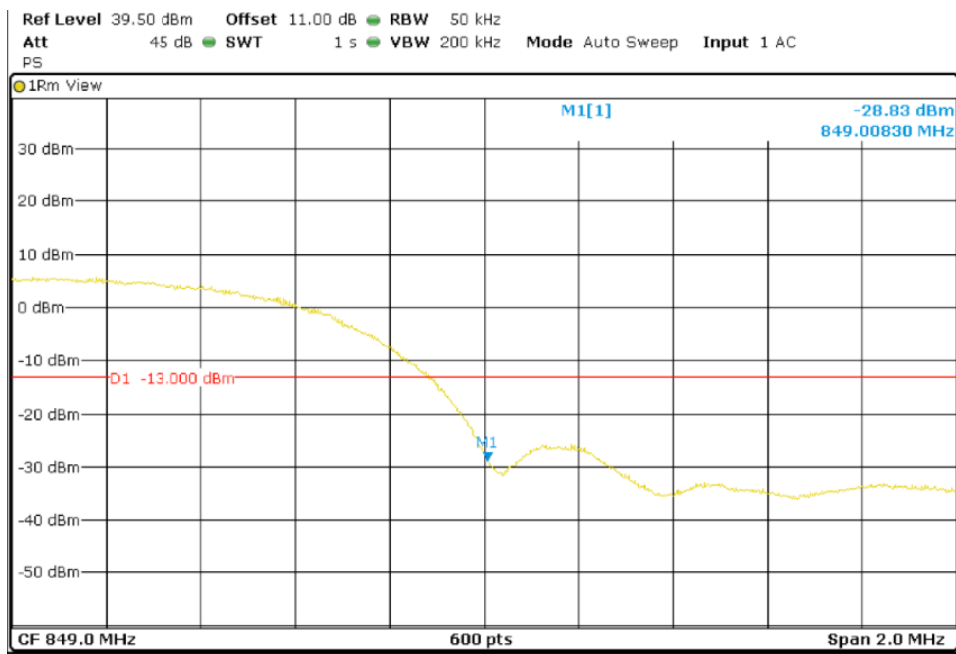

## TEST A7: RADIATED EMISSIONS

<b>LIMITS:</b>	Product standard:	FCC Part 22 / IC RSS-132.
	Test standard:	FCC §2.1053 and §22.917 / RSS-132 Clause 5.5.

### LIMITS

According to specification, the power of emissions shall be attenuated below the transmitter power (P) by a factor of at least  $43 + 10 \log(P)$  dB. P in watts.

At  $P_o$  transmitting power of 2 watts (33 dBm), the specified minimum attenuation becomes  $43 + 10 \log(P_o)$ , and the level in dBm relative to  $P_o$  becomes:

$$P_o \text{ (dBm)} - [43 + 10 \log(P_o \text{ in watts})] = -13 \text{ dBm}$$

### TEST SETUP

The measurement was performed with the EUT inside an anechoic chamber. The spectrum was scanned from 30 MHz to at least the 10th harmonic of the highest frequency generated within the equipment.

The EUT was placed on a non-conductive stand at a 3-meter distance from the measuring antenna for measurements below 1 GHz and at 1-meter distance for measurements above 1 GHz.

Detected emissions were maximized at each frequency by rotating the EUT and adjusting the measuring antenna height and polarization. The maximum reading was recorded.

#### Radiated measurements < 1GHz

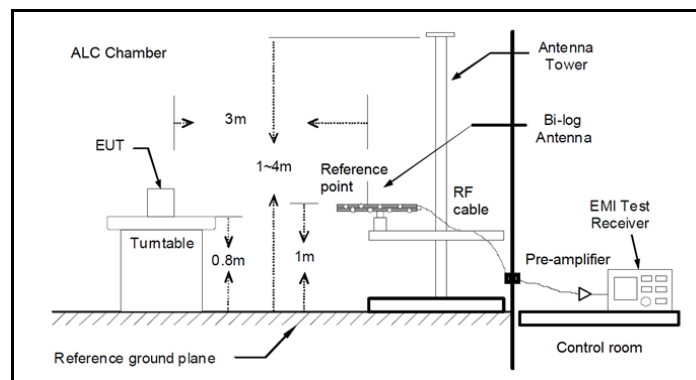

#### Radiated measurements > 1GHz

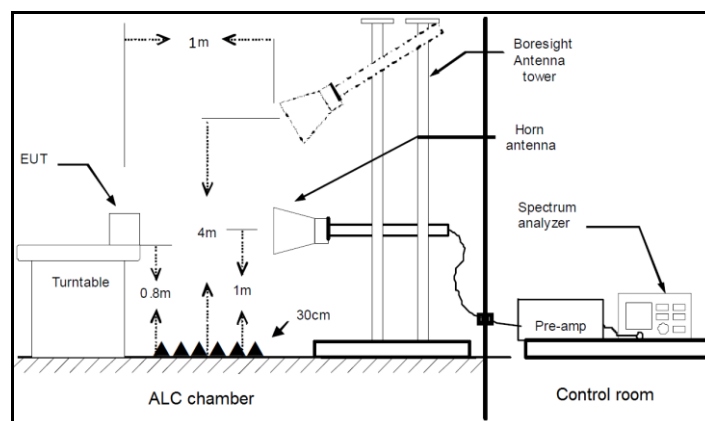

<b>TESTED SAMPLES:</b>	S/01
<b>TESTED CONDITIONS MODES:</b>	TC#01
<b>TEST RESULTS:</b>	PASS

**RESULTS**

A preliminary scan determined the QPSK 3 MHz bandwidth as the worst case. The configuration of Resource Blocks which is the worst case for conducted power was used.

The following plots show the results for this configuration.

LTE QPSK MODULATION. RB = 1. Offset = 0. BW = 3 MHz

<b>TEST RESULTS (Cont):</b>	Lowest Channel
-----------------------------	----------------

**FREQUENCY RANGE: 30-1000 MHz**

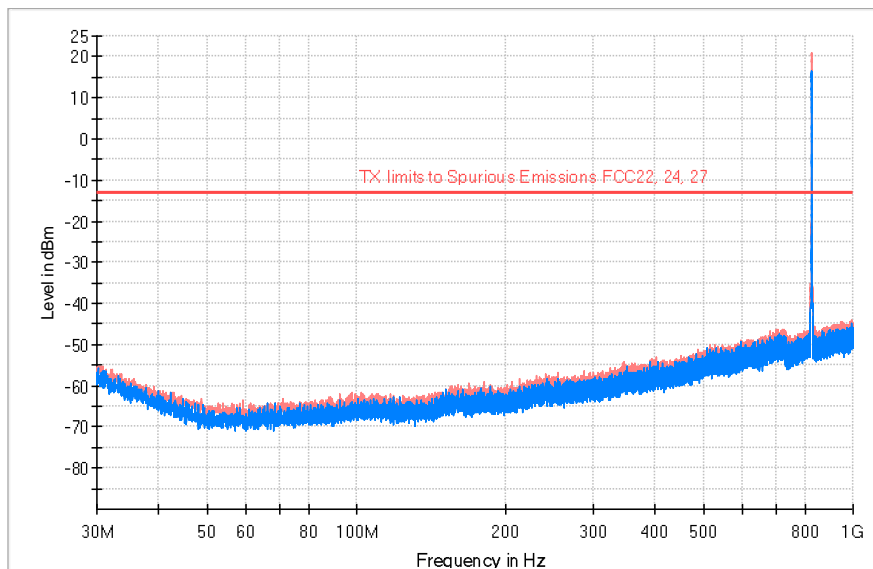

— PK+\_MAXH    — PK+\_CLRWR    — TX limits to Spurious Emissions FCC22, 24, 27

Frequency (MHz)	PK+_CLRWR (dBm)	PK+_MAXH (dBm)	Comment
30.873000	-57.36	-55.11	
824.333000	15.97	20.94	<b>Fundamental</b>
991.561000	-46.93	-43.94	

**TEST RESULTS (Cont):**

Lowest Channel

**FREQUENCY RANGE: 1-10 GHz**

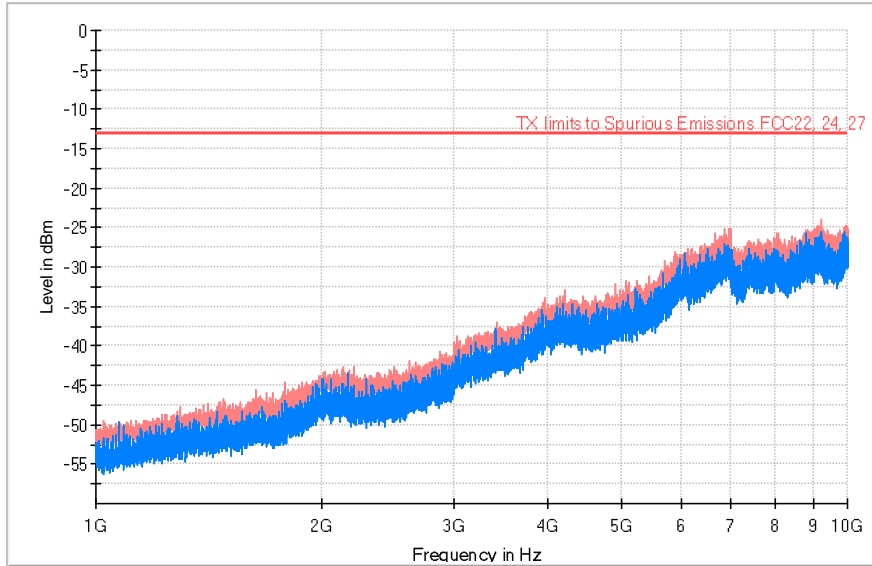

— PK+\_MAXH    — PK+\_CLRWR    — TX limits to Spurious Emissions FCC22, 24, 27

Frequency (MHz)	PK+_CLRWR (dBm)	PK+_MAXH (dBm)	Comment
4204.500000	-36.89	-32.85	
4919.000000	-35.46	-32.07	
6668.000000	-30.15	-25.80	
9214.500000	-30.11	-24.04	

**TEST RESULTS (Cont):**

Middle Channel

**FREQUENCY RANGE: 30 MHz-1 GHz**

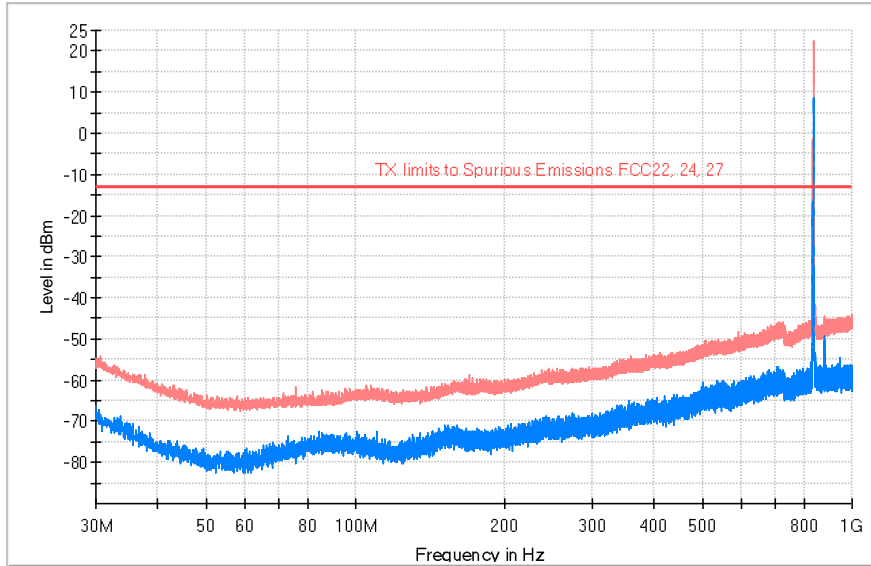

PK+\_MAXH    PK+\_CLRWR    TX limits to Spurious Emissions FCC22, 24, 27

Frequency (MHz)	PK+_CLRWR (dBm)	PK+_MAXH (dBm)	Comment
30.614333	-68.31	-54.15	
835.326333	8.11	22.53	
881.433667	-51.73	-44.35	<b>Fundamental</b>
997.639667	-59.78	-44.19	

**TEST RESULTS (Cont):**

Middle Channel

**FREQUENCY RANGE: 1-10 GHz**

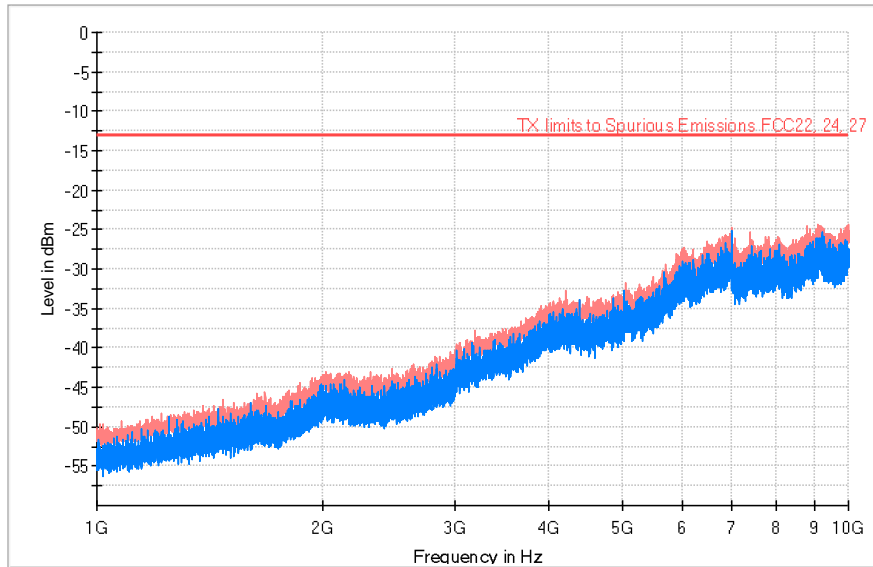

— PK+\_MAXH    — PK+\_CLRWR    — TX limits to Spurious Emissions FCC22, 24, 27

Frequency (MHz)	PK+_CLRWR (dBm)	PK+_MAXH (dBm)	Comment
4212.500000	-37.51	-32.79	
5059.500000	-35.93	-31.73	
6983.500000	-25.04	-25.04	
9115.500000	-28.69	-24.26	



**TEST RESULTS (Cont):**

Highest Channel

**FREQUENCY RANGE: 30 MHz-1 GHz**

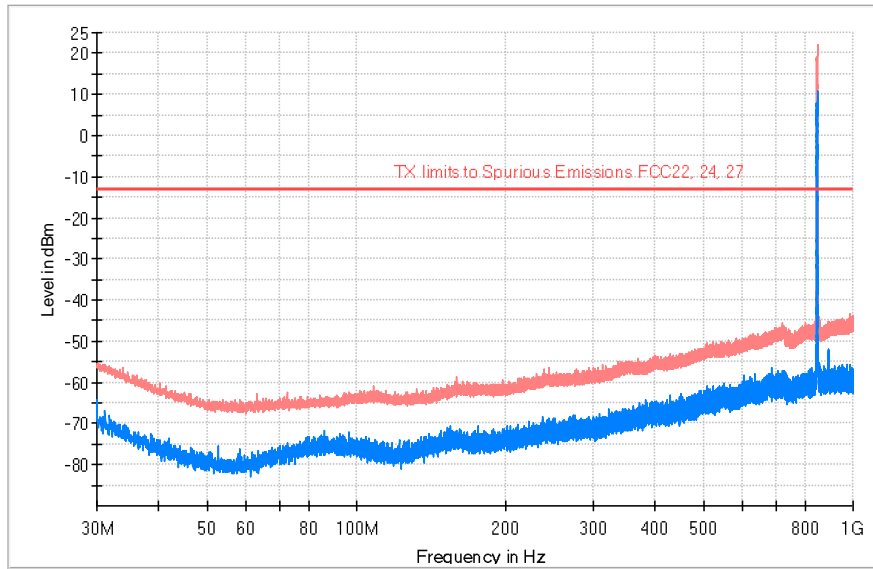

PK+\_MAXH    PK+\_CLRWR    TX limits to Spurious Emissions FCC22, 24, 27

Frequency (MHz)	PK+_CLRWR (dBm)	PK+_MAXH (dBm)	Comment
30.226333	-69.79	-55.20	
846.222667	10.76	22.11	<b>Fundamental</b>
986.969667	-58.11	-43.48	

**TEST RESULTS (Cont):**

Highest Channel

**FREQUENCY RANGE: 1-10 GHz**

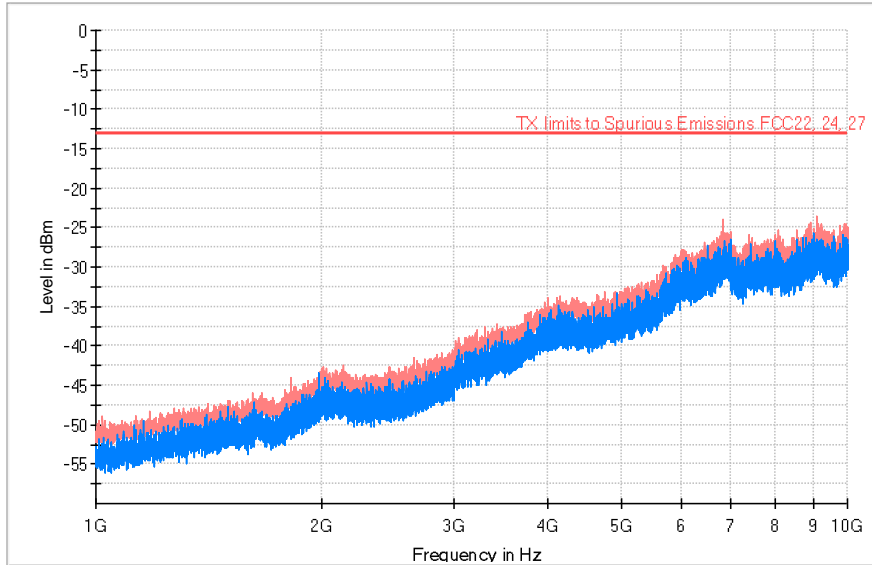

— PK+\_MAXH    — PK+\_CLRWR    — TX limits to Spurious Emissions FCC22, 24, 27

Frequency (MHz)	PK+_CLRWR (dBm)	PK+_MAXH (dBm)	Comment
3410.000000	-41.40	-37.23	
4299.500000	-37.50	-33.89	
6835.000000	-31.31	-23.87	
9105.500000	-30.44	-23.66	

<b>TESTED SAMPLES:</b>	S/01
<b>TESTED CONDITIONS MODES:</b>	TC#02
<b>TEST RESULTS:</b>	PASS

**RESULTS**

A preliminary scan determined the GPRS Mode as the worst case. The configuration of Resource Blocks which is the worst case for conducted power was used.

The following tables and plots show the results for this configuration.

<b>TEST RESULTS (Cont):</b>	Lowest Channel
-----------------------------	----------------

**FREQUENCY RANGE: 30-1000 MHz**

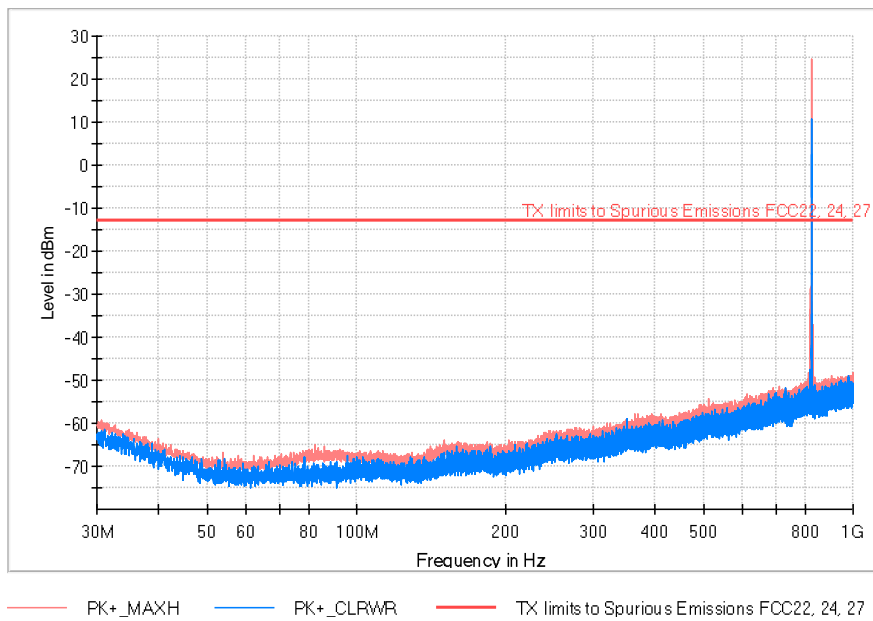

Frequency (MHz)	PK+_CLRWR (dBm)	PK+_MAXH (dBm)	Comment
30.711333	-65.37	-59.25	
512.445667	-60.84	-54.24	
824.365333	-54.52	24.63	

**TEST RESULTS (Cont):**

Lowest Channel

**FREQUENCY RANGE: 1-10 GHz**

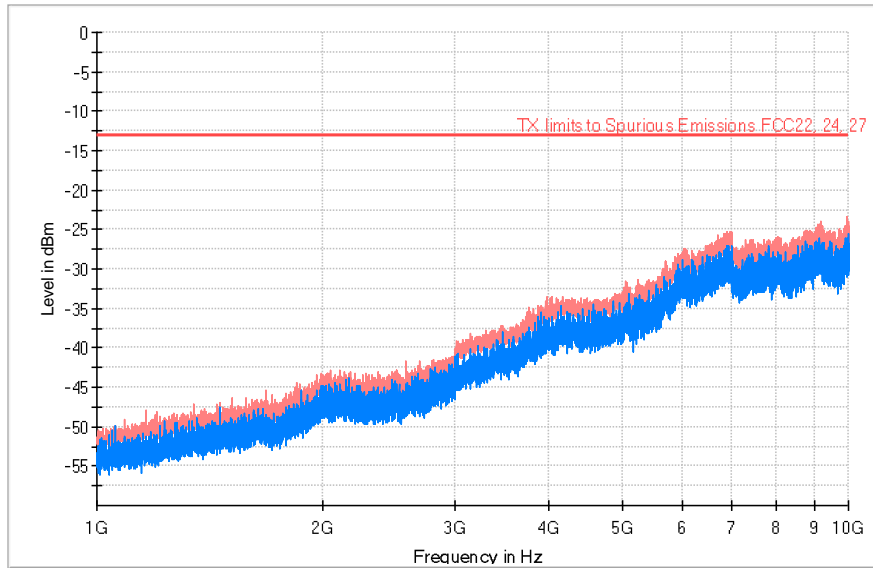

— PK+\_MAXH — PK+\_CLRWR — TX limits to Spurious Emissions FCC22, 24, 27

**Maximizations**

Frequency (MHz)	PK+_CLRWR (dBm)	PK+_MAXH (dBm)
2105.600000	-46.74	-42.84
3977.500000	-36.92	-33.44
9949.500000	-29.43	-23.35

**TEST RESULTS (Cont):**

Middle Channel

**FREQUENCY RANGE: 30 MHz-1 GHz**

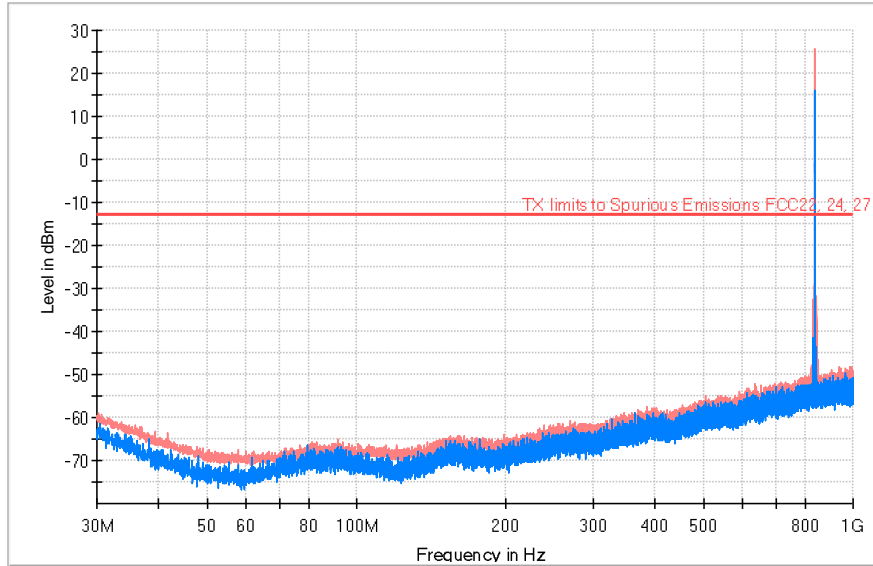

— PK+\_MAXH — PK+\_CLRWR — TX limits to Spurious Emissions FCC22, 24, 27

Frequency (MHz)	PK+_CLRWR (dBm)	PK+_MAXH (dBm)	Comment
41.672333	-72.19	-63.61	
632.434667	-58.24	-52.19	
836.716667	-0.61	25.64	

**TEST RESULTS (Cont):**

Middle Channel

FREQUENCY RANGE: 1-10 GHz

**Maximizations**

Frequency (MHz)	PK+_CLRWR (dBm)	PK+_MAXH (dBm)
1992.600000	-47.65	-42.96
3962.500000	-37.59	-34.30
6996.500000	-28.49	-25.11

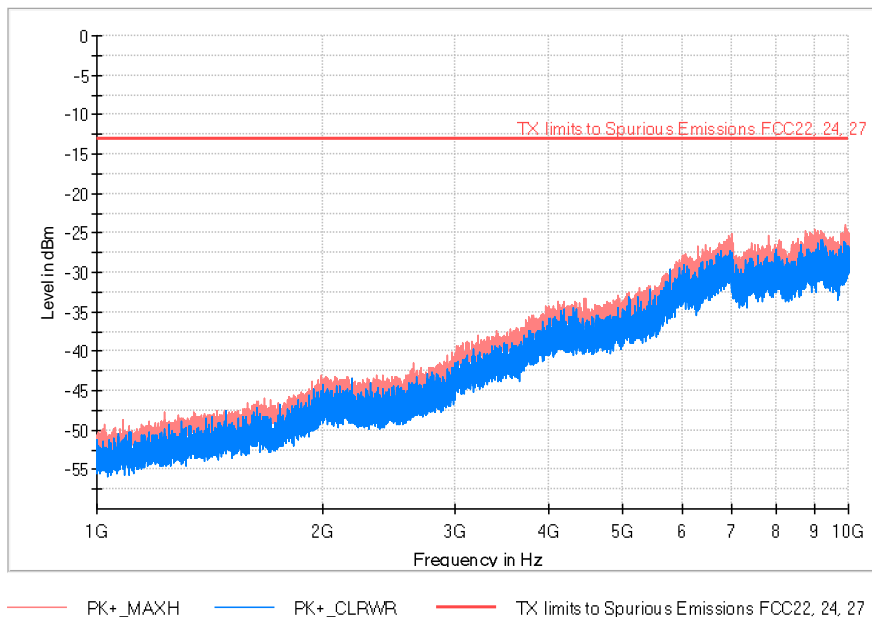

<b>TEST RESULTS (Cont):</b>	Highest Channel
-----------------------------	-----------------

**FREQUENCY RANGE: 30 MHz-1 GHz**

Frequency (MHz)	PK+ _CLRWR (dBm)	PK+ _MAXH (dBm)	Comment
30.420333	-52.97	-49.37	
664.024333	-48.08	-40.78	
848.712333	4.11	25.19	

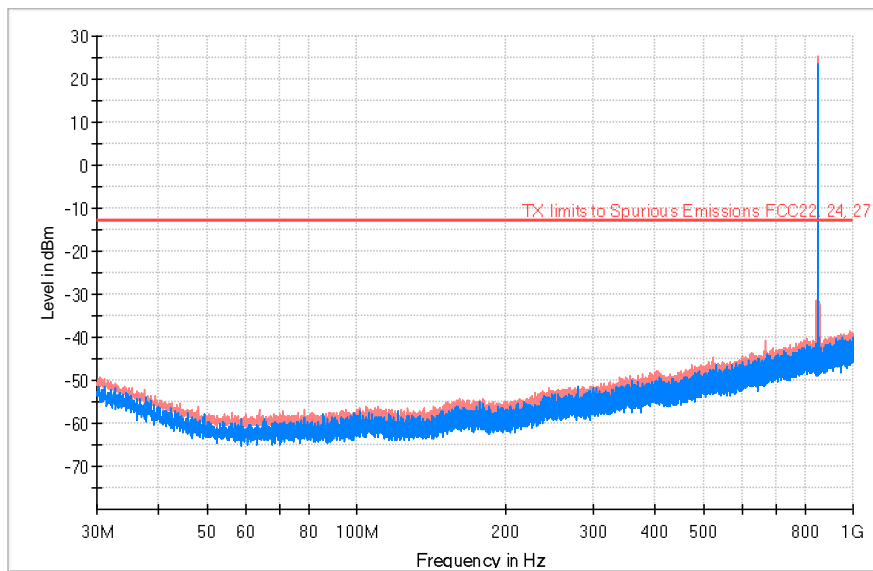

— PK+ \_MAXH    — PK+ \_CLRWR    — TX limits to Spurious Emissions FCC22, 24, 27

**TEST RESULTS (Cont):**

Highest Channel

**FREQUENCY RANGE: 1-10 GHz**

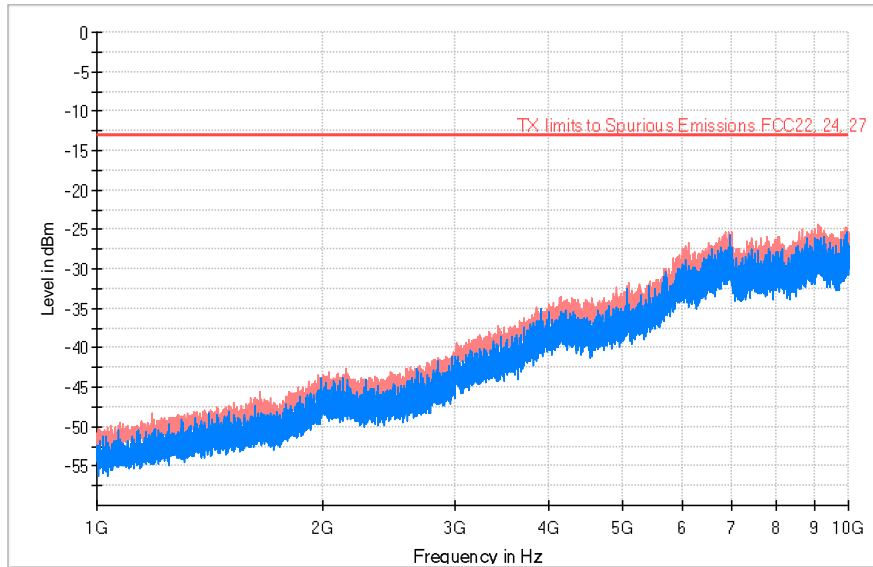

— PK+\_MAXH    — PK+\_CLRWR    — TX limits to Spurious Emissions FCC22, 24, 27

**Maximizations**

Frequency (MHz)	PK+_CLRWR (dBm)	PK+_MAXH (dBm)
2146.600000	-47.9	-42.6
6977.500000	-29.6	-25.2
8677.000000	-31.1	-25.0



<b>TESTED SAMPLES:</b>	S/01
<b>TESTED CONDITIONS MODES:</b>	TC#03
<b>TEST RESULTS:</b>	PASS

**RESULTS**

A preliminary scan determined the WCDMA Mode as the worst case. The configuration of Resource Blocks which is the worst case for conducted power was used.

The following tables and plots show the results for this configuration.

<b>TEST RESULTS (Cont):</b>	Lowest Channel
-----------------------------	----------------

**FREQUENCY RANGE: 30-1000 MHz**

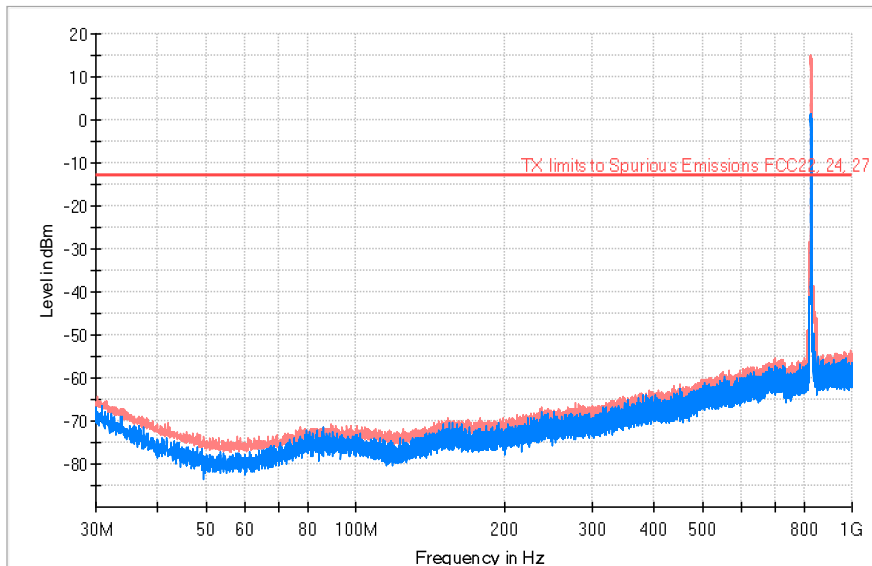

— PK+\_MAXH — PK+\_CLRWR — TX limits to Spurious Emissions FCC22, 24, 27

Frequency (MHz)	PK+_CLRWR (dBm)	PK+_MAXH (dBm)	Comment
30.258667	-70.35	-64.22	
827.566333	0.73	15.09	<b>Fundamental</b>
993.048333	-57.13	-53.60	
847.871667	-60.20	-45.93	

**TEST RESULTS (Cont):**

Lowest Channel

**FREQUENCY RANGE: 1-10 GHz**

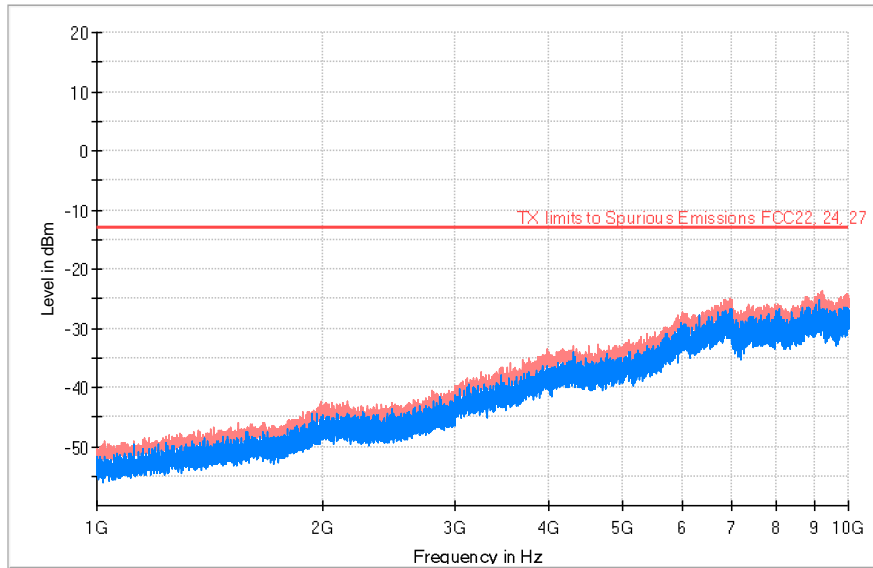

— PK+\_MAXH — PK+\_CLRWR — TX limits to Spurious Emissions FCC22, 24, 27

**Maximizations**

Frequency (MHz)	PK+_CLRWR (dBm)	PK+_MAXH (dBm)
3982.000000	-36.45	-33.51
6967.000000	-29.88	-24.84
9224.000000	-29.51	-23.71

**TEST RESULTS (Cont):**

Middle Channel

**FREQUENCY RANGE: 30 MHz-1 GHz**

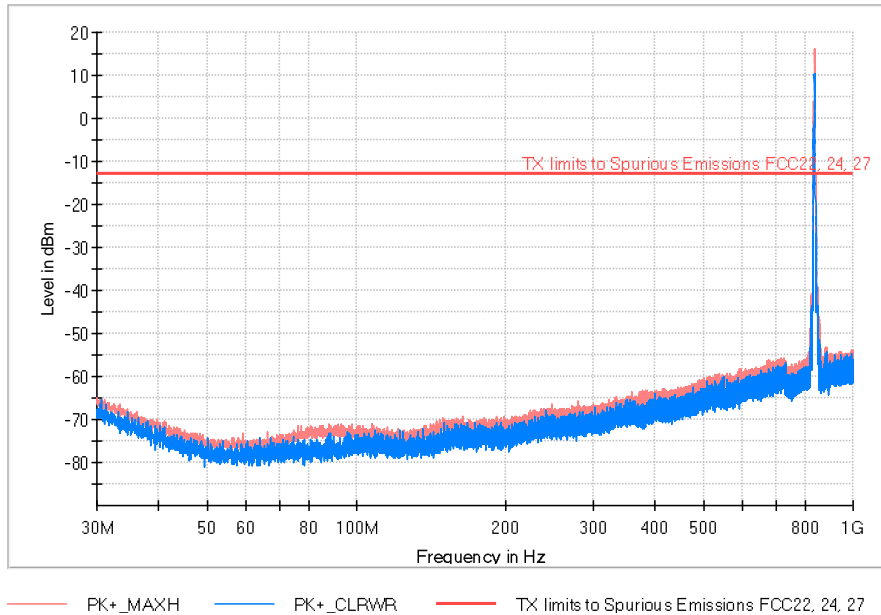

**Maximizations**

Frequency (MHz)	PK+_CLRWR (dBm)	PK+_MAXH (dBm)	Comment
30.064667	-69.58	-65.02	
837.492667	10.41	16.18	<b>Fundamental</b>
881.595333	-59.15	-53.11	

**TEST RESULTS (Cont):**

Middle Channel

**FREQUENCY RANGE: 1-10 GHz**

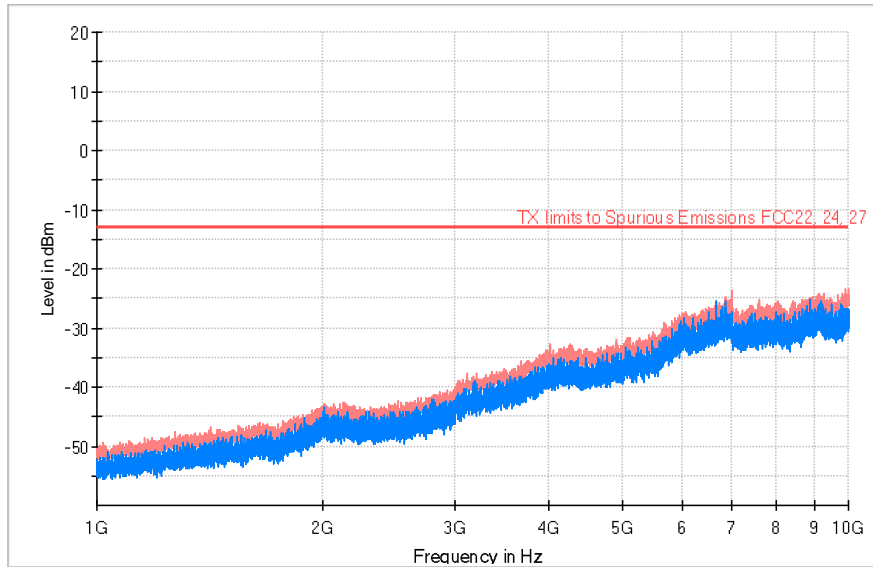

— PK+\_MAXH — PK+\_CLRWR — TX limits to Spurious Emissions FCC22, 24, 27

**Maximizations**

Frequency (MHz)	PK+_CLRWR (dBm)	PK+_MAXH (dBm)
4008.000000	-37.79	-32.73
6978.500000	-29.46	-23.70
7618.000000	-28.96	-25.20

**TEST RESULTS (Cont):**

Highest Channel

**FREQUENCY RANGE: 30 MHz-1 GHz**

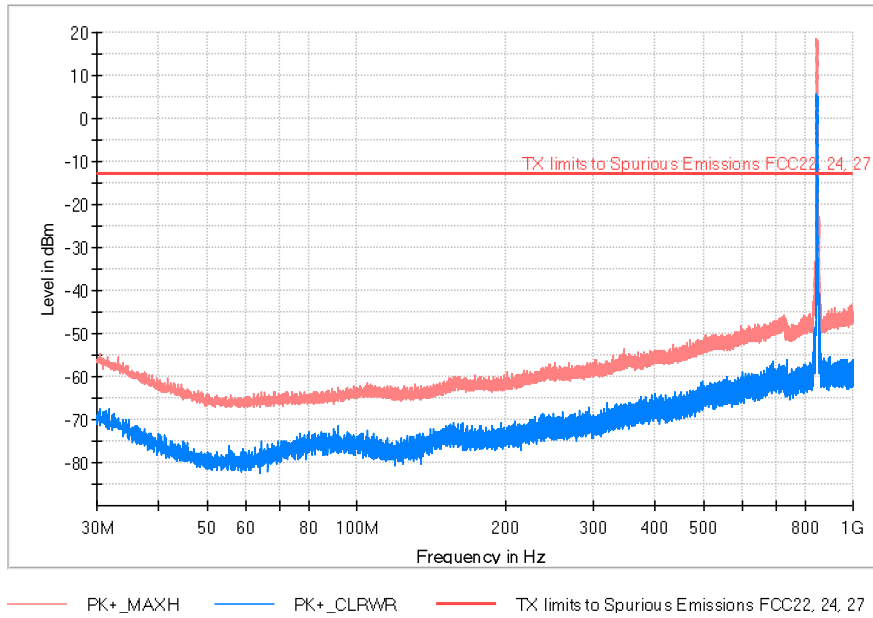

**Maximizations**

Frequency (MHz)	PK+_CLRWR (dBm)	PK+_MAXH (dBm)	Comment
345.120667	-69.26	-53.66	
845.155667	5.36	18.59	Fundamental
893.364667	-60.41	-44.66	

**TEST RESULTS (Cont):**

Highest Channel

FREQUENCY RANGE: 1-10 GHz

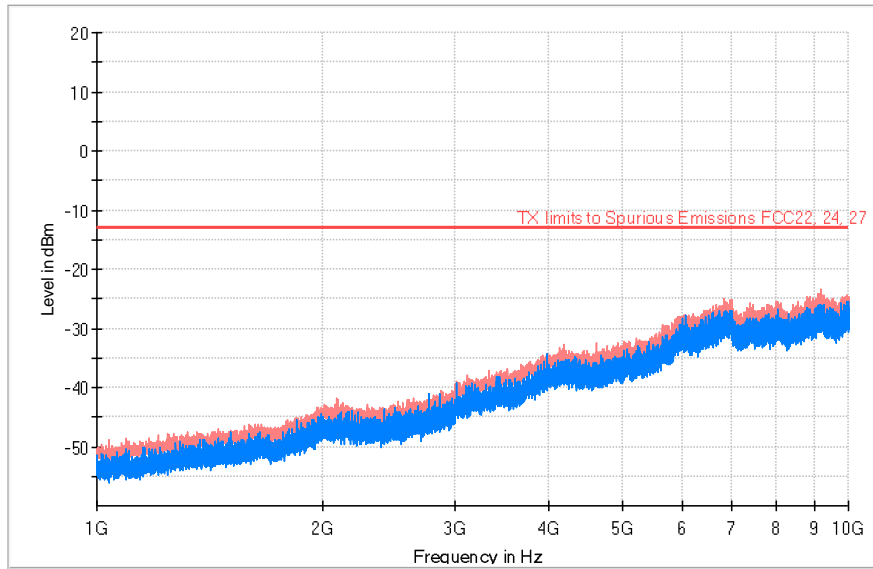

— PK+\_MAXH — PK+\_CLRWR — TX limits to Spurious Emissions FCC22, 24, 27

**Maximizations**

Frequency (MHz)	PK+_CLRWR (dBm)	PK+_MAXH (dBm)
2082.800000	-46.81	-41.80
4180.000000	-38.19	-32.64
6841.500000	-29.40	-24.99
9176.000000	-29.10	-23.50