



Inter**Lab**[®]

FCC Measurement/Technical Report on

GSM Module

Siemens Cellular Engine TC65i

Report Reference: MDE_SIEM_0714_FCCb

Test Laboratory:

7 layers AG
Borsigstrasse 11
40880 Ratingen
Germany
email: info@7Layers.de



DAT-P-192/99-01

Note:

The following test results relate only to the devices specified in this document. This report shall not be reproduced in parts without the written approval of the testing laboratory.

7 layers AG
Borsigstrasse 11
40880 Ratingen, Germany
Phone: +49 (0) 2102 749 0
Fax: +49 (0) 2102 749 350
www.7Layers.com

*Aufsichtsratsvorsitzender •
Chairman of the Supervisory Board:
Markus Becker
Vorstand • Board:
Dr. Hans-Jürgen Meckelburg
René Schildknecht*

*Registergericht • registered in:
Düsseldorf, HRB 44096
USt-IdNr • VAT Nr:
DE 203159652
TAX No. 147/5869/0385*

InterLab[®] is a registered trademark of 7 layers AG



Table of Contents

0 Summary	3
0.1 Technical Report Summary	3
0.2 Measurement Summary	4
1 Administrative Data	5
1.1 Testing Laboratory	5
1.2 Project Data	5
1.3 Applicant Data	5
1.4 Manufacturer Data	5
2 Testobject Data	6
2.1 General EUT Description	6
2.2 EUT Main components	7
2.3 Ancillary Equipment	7
2.4 EUT Setups	7
2.5 Operating Modes	8
3 Test Results	9
3.1 RF Power Output	9
3.2 Frequency stability	11
3.3 Spurious emissions at antenna terminals	14
3.4 Field strength of spurious radiation	17
3.5 Emission and Occupied Bandwidth	20
3.6 Band edge compliance	23
4 Test Equipment	25
5 Photo Report	28
6 Setup Drawings	32
7 Annex	34
Measurement Plots	



0 Summary

0.1 Technical Report Summary

Type of Authorization

Certification for a GSM cellular radiotelephone device

Applicable FCC Rules

Prepared in accordance with the requirements of FCC Rules and Regulations as listed in 47 CFR Ch.1 Parts 0 to 19 and Parts 20 to 69 (10-1-07 Edition). The following subparts are applicable to the results in this test report.

Part 2

Subpart J - Equipment Authorization Procedures, Certification

§ 2.1046 Measurement required: RF power output

§ 2.1049 Measurement required: Occupied bandwidth

§ 2.1051 Measurement required: Spurious emissions at antenna terminals

§ 2.1053 Measurement required: Field strength of spurious radiation

§ 2.1055 Measurement required: Frequency stability

§ 2.1057 Frequency spectrum to be investigated

Part 22

Subpart C – Operational and Technical Requirements

§ 22.355 Frequency tolerance

Subpart H – Cellular Radiotelephone Service

§ 22.913 Effective radiated power limits

§ 22.917 Emission limitations for cellular equipment

Summary Test

The EUT complied with all performed tests as listed in chapter 0.2 Measurement Summary.

0.2 Measurement Summary

RF Power Output

The measurement was performed according to FCC §2.1046 10-1-07

OP-Mode	Setup	Port	Final Result
op-mode 1	Setup_a02	antenna connector	passed
op-mode 2	Setup_a02	antenna connector	passed
op-mode 3	Setup_a02	antenna connector	passed

Frequency stability

The measurement was performed according to FCC §2.1055 10-1-07

OP-Mode	Setup	Port	Final Result
op-mode 2	Setup_a02	antenna connector	passed

Spurious emissions at antenna terminals

The measurement was performed according to FCC §2.1051 10-1-07

OP-Mode	Setup	Port	Final Result
op-mode 1	Setup_a02	antenna connector	passed
op-mode 2	Setup_a02	antenna connector	passed
op-mode 3	Setup_a02	antenna connector	passed

Field strength of spurious radiation

The measurement was performed according to FCC §2.1053 10-1-07

OP-Mode	Setup	Port	Final Result
op-mode 1	Setup_a01	enclosure	passed
op-mode 2	Setup_a01	enclosure	passed
op-mode 3	Setup_a01	enclosure	passed

Emission and Occupied Bandwidth

The measurement was performed according to FCC §2.1049 10-1-07

OP-Mode	Setup	Port	Final Result
op-mode 1	Setup_a02	antenna connector	passed
op-mode 2	Setup_a02	antenna connector	passed
op-mode 3	Setup_a02	antenna connector	passed

Band edge compliance

The measurement was performed according to FCC §2.1053 10-1-07

OP-Mode	Setup	Port	Final Result
op-mode 1	Setup_a02	antenna connector	passed
op-mode 3	Setup_a02	antenna connector	passed

Responsible for
Accreditation Scope:

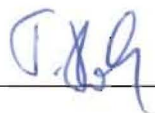

7 layers AG, Borsigstr. 11
40880 Ratingen, Germany
Phone +49 (0)2102-749 0

Responsible
for Test Report:

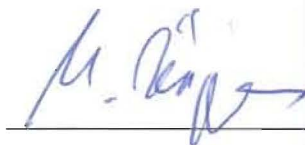



1 Administrative Data

1.1 Testing Laboratory

Company Name: 7 Layers AG
Address Borsigstr. 11
40880 Ratingen
Germany

This facility has been fully described in a report submitted to the FCC and accepted under the registration number 96716 .

The test facility is also accredited by the following accreditation organisation:
- Deutscher Akkreditierungs Rat DAR-Registration no. DAT-P-192/99-01

Responsible for Accreditation Scope: Dipl.-Ing. Bernhard Retka
Dipl.-Ing. Robert Machulec
Dipl.-Ing. Thomas Hoell

Report Template Version: 2007-08-29

1.2 Project Data

Responsible for testing and report: Dr. Ing. Michael Küppers
Receipt of EUT: 2008-03-03
Date of Test(s): 2008-04-15 to 2008-04-29
Date of Report: 2008-06-23

1.3 Applicant Data

Company Name: Siemens AG
Address: Siemensdamm 50
13629 Berlin
Germany
Contact Person: Mr. Hussein Halawi

1.4 Manufacturer Data

Company Name: Siemens AG
Address: Siemensdamm 50
13629 Berlin
Germany
Contact Person: Mr. Hussein Halawi



2 Testobject Data

2.1 General EUT Description

Equipment under Test:	GSM Module
Type Designation:	Siemens Cellular Engine TC65i
Kind of Device:	GSM 850/900/1800/1900 Transceiver
(optional)	
Voltage Type:	DC
Nominal Voltage:	4.5 V
Maximum Voltage:	4.5 V
Minimum Voltage:	3.8 V

General product description:

The Equipment Under Test (EUT) is a GSM 850/900/1800/1900 module and supports GSM.

The manufacturer declared that nominal voltage is equal to high voltage.

In GSM 850 mode the EUT operates in channel blocks A and B from 824.2 MHz (lowest channel = 128) to 848.8 MHz (highest channel = 251).

The EUT provides the following ports:

Ports

- antenna connector
- enclosure
- data connector

The main components of the EUT are listed and described in Chapter 2.2



2.2 EUT Main components

Type, S/N, Short Descriptions etc. used in this Test Report

Short Description	Equipment under Test	Type Designation	Serial No.	HW Status	SW Status	Date of Receipt
EUT A (Code: 01422c01) Remark: EUT A is equipped with a permanent antenna connector	GSM Module	Siemens Cellular Engine TC65i	IMEI: 0044010801 96399	B2.1.0	Rev 00.101	2008-04-07

NOTE: The short description is used to simplify the identification of the EUT in this test report.

2.3 Ancillary Equipment

For the purposes of this test report, ancillary equipment is defined as equipment which is used in conjunction with the EUT to provide operational and control features to the EUT. It is necessary to configure the system in a typical fashion, as a customer would normally use it. But nevertheless Ancillary Equipment can influence the test results.

Short Description	Equipment under Test	Type Designation	HW Status	SW Status	Serial no.	FCC ID
AE1	DSB75 Evaluation Board	DSB75_B1_005	-	-	A5B009001 50933	-
AE2	DSB75 flex cable	-	-	-	-	-
AE3	Laptop	Lifebook S7020	-	Win XP	YBBY01774 5	-
AE4	AC Charger	CP293663-01	-	-	-	-
AE5 (Code: 01420ant1)	External antenna	Skycross WBA ELEMENT 2-2645	08/02/05	-	-	-

Remark: antenna gain of AE5 is 1.65 dBi or -0.49 dBD.

2.4 EUT Setups

This chapter describes the combination of EUT's and ancillary equipment used for testing.

Setup No.	Combination of EUTs	Description
setup_a01	EUT A + AE1 + AE2 + AE3 + AE4 + AE 5	setup for radiated spurious emissions tests
setup_a02	EUT A + AE1 + AE3 + AE4	setup for conducted testing



2.5 Operating Modes

This chapter describes the operating modes of the EUT's used for testing.

Op. Mode	Description of Operating Modes	Remarks
PCS data call		
op-mode 1	Call established on Traffic Channel (TCH) 128, Carrier Frequency 824.2 MHz	128 is the lowest channel PCS data call
op-mode 2	Call established on Traffic Channel (TCH) 190, Carrier Frequency 836.6 MHz	190 is a mid channel PCS data call
op-mode 3	Call established on Traffic Channel (TCH) 251, Carrier Frequency 848.8 MHz	251 is the highest channel PCS data call



3 Test Results

3.1 RF Power Output

Standard FCC Part 22, 10-1-07
Subpart H

The test was performed according to: FCC §2.1046, 10-1-07

3.1.1 Test Description

- 1) The EUT was coupled to the R&S Spectrum Analyser and the R&S CMU200 Digital Communication Tester through a Power Divider. Refer to chapter "Setup Drawings".
- 2) The total insertion losses for RF Path 1 and RF Path 2 were measured. The values were used to correct the readings from the R&S Spectrum Analyser and the R&S CMU200 Digital Communication Tester.
- 3) A call was established on a Traffic Channel (TCH) between the EUT and the base station simulator (R&S CMU200 Digital Communication Tester).

Important Settings:

- Discontinuous Transmission: OFF
- Modulation Signal: PSR16-1 (Pseudo Random Sequence)
- Output Power: Varied during measurements
- Channel (Frequency): Varied during measurements

- 4) The transmitted power of the EUT was measured by using a spectrum analyser.

3.1.2 Test Requirements / Limits

§2.1046 Measurements Required: RF Power Output

(a) For transmitters other than single sideband, independent sideband and controlled carrier radiotelephone, power output shall be measured at the RF output terminals when the transmitter is adjusted in accordance with the tune-up procedure to give the values of current and voltage on the circuit elements specified in § 2.1033(c)(8). The electrical characteristics of the output terminals when this test is made shall be stated.

§22.913 Effective radiated power limits

(a) Maximum ERP. ... The ERP of mobile transmitters and auxiliary test transmitters must not exceed 7 Watts.



3.1.3 Test Protocol

Temperature: 23 °C
 Air Pressure: 1003 hPa
 Humidity: 35 %

Op. Mode	Setup	Port
op-mode 1	setup_a02	antenna connector

Output power Nominal (dBm)	Output power Measured (dBm)
33.0	32.7

Remark: The measured output power does not include antenna gain.

Op. Mode	Setup	Port
op-mode 2	setup_a02	antenna connector

Output power Nominal (dBm)	Output power Measured (dBm)
33.0	32.7

Remark: The measured output power does not include antenna gain.

Op. Mode	Setup	Port
op-mode 3	setup_a02	antenna connector

Output power Nominal (dBm)	Output power Measured (dBm)
33.0	32.7

Remark: The measured output power does not include antenna gain.

3.1.4 Test result: RF Power Output

FCC Part 22, Subpart H	Op. Mode	Result
	op-mode 1	passed
	op-mode 2	passed
	op-mode 3	passed



3.2 Frequency stability

Standard FCC Part 22, 10-1-07
Subpart H

The test was performed according to FCC §2.1055, 10-1-07

3.2.1 Test Description

- 1) The EUT was placed inside the climatic chamber.
- 2) The EUT was coupled to the R&S CMU200 Digital Communication Tester. Refer to chapter "Setup Drawings".
- 3) The climatic chamber was cycled down/up to a certain temperature, starting with -30°C .
- 4) After the temperature was stabilized (at least one hour) the EUT was switched on and a call was established on a Traffic Channel (TCH) between the EUT and the base station simulator (R&S CMU200 Digital Communication Tester).
Important Settings:
 - Discontinuous Transmission: OFF
 - Modulation Signal: PSR16-1 (Pseudo Random Sequence)
 - Output Power: Maximum
 - Channel : 190 [836.6 MHz]
- 5) The frequency error of the EUT were recorded by using an internal measurement function of the CMU200 immediately after the call was established, five minutes after the call was established and ten minutes after the call was established.
- 6) This measurement procedure was performed for all combinations of voltage (low, nominal, high) and temperature (from -30°C to $+50^{\circ}\text{C}$ in increments of 10°C).

3.2.2 Test Requirements / Limits

§2.1055 Measurements required: Frequency stability

(a) The frequency stability shall be measured with variation of ambient temperature as follows:

(1) From -30° to $+50^{\circ}$ centigrade for all equipment except that specified in paragraphs (a) (2) and (3) of this section.

(b) Frequency measurements shall be made at the extremes of the specified temperature range and at intervals of not more than 10° centigrade through the range. A period of time sufficient to stabilize all of the components of the oscillator circuit at each temperature level shall be allowed prior to frequency measurement. The short term transient effects on the frequency of the transmitter due to keying (except for broadcast transmitters) and any heating element cycling normally occurring at each ambient temperature level also shall be shown. Only the portion or portions of the transmitter containing the frequency determining and stabilizing circuitry need be subjected to the temperature variation test.



(d) The frequency stability shall be measured with variation of primary supply voltage as follows:

- (1) Vary primary supply voltage from 85 to 115 percent of the nominal value for other than hand carried battery equipment.
- (2) For hand carried, battery powered equipment, reduce primary supply voltage to the battery operating end point which shall be specified by the manufacturer.
- (3) The supply voltage shall be measured at the input to the cable normally provided with the equipment, or at the power supply terminals if cables are not normally provided. Effects on frequency of transmitter keying (except for broadcast transmitters) and any heating element cycling at the nominal supply voltage and at each extreme also shall be shown.

§22.355 Frequency tolerance

...the carrier frequency of each transmitter in the Public Mobile Service must be maintained within the tolerances given in table C-1 of this section.

Table C-1.- Frequency Tolerance for Transmitters in the Public Mobile Services

Frequency range (ppm)	Base, fixed (ppm)	Mobile up to 3 watts (ppm)	Mobile above 3 watts (ppm)
25 to 50	20.0	20.0	50.0
50 to 450	5.0	5.0	50.0
450 to 512	2.5	5.0	5.0
821 to 896	1.5	2.5	2.5
928 to 929	5.0	n/a	n/a
929 to 960	1.5	n/a	n/a
2110 to 2220	10.0	n/a	n/a

For the mid channel (836.6 MHz) the frequency tolerance is 2.5 ppm (2091.5 Hz).



3.2.3 Test Protocol

Temperature: 24 – 25 °C
 Air Pressure: 999 – 1005 hPa
 Humidity: 26 – 32 %

Op. Mode	Setup	Port
op-mode 2	setup_a02	antenna connector

Temp. °C	Duration min	Normal Voltage / V	
		Freq. error Average (Hz)	Freq. error Max. (Hz)
-30	0	-22	-576
-30	5	-6	377
-30	10	6	-410
-20	0	-11	-563
-20	5	-2	422
-20	10	-9	-361
-10	0	-3	-391
-10	5	-8	-569
-10	10	-4	-448
0	0	-4	-805
0	5	0	470
0	10	-3	-682
10	0	9	1906
10	5	2	1687
10	10	-52	-1693
30	0	-14	-743
30	5	-13	-461
30	10	9	842
40	0	21	-1491
40	5	8	1260
40	10	-3	1759
50	0	-17	-1236
50	5	-27	-1152
50	10	-12	-1857

Remark: none.

Temp. °C	Duration min	Minimum Voltage / V		Normal Voltage / V		Maximum Voltage / V	
		Freq. error Average (Hz)	Freq. error Max. (Hz)	Freq. error Average (Hz)	Freq. error Max. (Hz)	Freq. error Average (Hz)	Freq. error Max. (Hz)
+20	0	2	-1654	-16	-1589	-	-
+20	5	1	-1436	-19	-926	-	-
+20	10	3	-774	-1	-1088	-	-

Remark: The manufacturer declared normal = maximum voltage.

3.2.4 Test result: Frequency stability

FCC Part 22, Subpart H	Op. Mode	Result
	op-mode 2	passed

3.3 Spurious emissions at antenna terminals

Standard FCC Part 22, 10-1-07
Subpart H

The test was performed according to FCC §2.1051, 10-1-07

3.3.1 Test Description

- 1) The EUT was coupled to the R&S Spectrum Analyser and the R&S CMU200 Digital Communication Tester through a Power Divider. Refer to chapter "Setup Drawings".
- 2) The total insertion losses for RF Path 1 and RF Path 2 were measured. The values were used to correct the readings from the R&S Spectrum Analyser and the R&S CMU200 Digital Communication Tester.
- 3) A call was established on a Traffic Channel (TCH) between the EUT and the base station simulator (R&S CMU200 Digital Communication Tester).
Important Settings:
 - Discontinuous Transmission: OFF
 - Modulation Signal: PSR16-1 (Pseudo Random Sequence)
 - Output Power: Maximum
 - Channel: Varied during measurements
(lowest channel: 128, mid channel: 190 and highest channel: 251)
- 4) Important Analyser Settings
 - [Resolution Bandwidth / Video Bandwidth]:
 - a) [3 kHz / 3 kHz] in the Span of 1 MHz directly below and above the GSM-Band,
 - b) [10 kHz / 30 kHz] in case the curve of the analyser IF-Filter leads to an exceeding of the limit, in this case a worst case correction factor of 20 dB (1 MHz -> 10 kHz) was used
 - c) [1 MHz / 3 MHz] otherwise
 - Sweep Time: Calculated by using a formula given in the Product Standard "GSM 11.10-1 edition 4" for spurious emissions measurements (depending on the transmitting signal, the span and the resolution bandwidth)
- 5) The spurious emissions (peak) were measured in the frequency range from 9 kHz to 10 GHz (up to the 10th harmonic) during the call is established on the lowest channel (128), mid channel (190) and on the highest channel (251).

3.3.2 Test Requirements / Limits

§ 2.1051 Spurious emissions at antenna terminals

The radio frequency voltage or power generated within the equipment and appearing on a spurious frequency shall be checked at the equipment output terminals when properly loaded with a suitable artificial antenna. Curves or equivalent data shall show the magnitude of each harmonic and other spurious emission that can be detected when the equipment is operated under the conditions specified in Sec. 2.1049 as appropriate. The magnitude of spurious emissions which are attenuated more than 20 dB below the permissible value need not be specified.



§ 2.1057 Frequency spectrum to be investigated.

(a) In all of the measurements set forth in Secs. 2.1051 and 2.1053, the spectrum shall be investigated from the lowest radio frequency signal generated in the equipment, without going below 9 kHz, up to at least the frequency shown below:

(1) If the equipment operates below 10 GHz: to the tenth harmonic of the highest fundamental frequency or to 40 GHz, whichever is lower.

(b) Particular attention should be paid to harmonics and subharmonics of the carrier frequency as well as to those frequencies removed from the carrier by multiples of the oscillator frequency. Radiation at the frequencies of multiplier stages should also be checked.

(c) The amplitude of spurious emissions which are attenuated more than 20 dB below the permissible value need not be reported.

(d) Unless otherwise specified, measurements above 40 GHz shall be performed using a minimum resolution bandwidth of 1 MHz.

§ 22.917 Emission limitations for cellular equipment

(a) The power of any emission outside of the authorized operating frequency ranges must be attenuated below the transmitting power (P) by a factor of at least $43 + 10 \log(P)$ dB.

Remark of the test laboratory: This is calculated to be -13 dBm.

(b) Compliance with these rules is based on the use of measurement instrumentation employing a resolution bandwidth of 100 kHz or greater. In the 1 MHz bands immediately outside and adjacent to the frequency block a resolution bandwidth of at least one percent of the emission bandwidth of the fundamental emission of the transmitter may be employed. A narrower resolution bandwidth is permitted in all cases to improve measurement accuracy provided the measured power is integrated over the full required measurement bandwidth (*i.e.* 100 kHz or 1 percent of emission bandwidth, as specified). The emission bandwidth is defined as the width of the signal between two points, one below the carrier center frequency and one above the carrier center frequency, outside of which all emissions are attenuated at least 26 dB below the transmitter power.

(c) Licensees in this service may establish an alternative out of band emission limit to be used at specified band edge(s) in specified geographical areas [...].

(d) If any emission from a transmitter operating in this service results in interference to users of another radio service, the FCC may require a greater attenuation of that emission than specified in this section.



3.3.3 Test Protocol

Temperature: 23 °C
 Air Pressure: 1003 hPa
 Humidity: 35 %

Op. Mode	Setup	Port
op-mode 1	setup_a02	antenna connector

Frequency MHz	Bandwidth kHz	Measured Level dBm	Limit dBm
824.0	3.0	-13.7	-13.0

Remark: No (further) spurious emissions were found in the range 20 dB below the limit.

Op. Mode	Setup	Port
op-mode 2	setup_a02	antenna connector

Frequency MHz	Bandwidth kHz	Measured Level dBm	Limit dBm
-	-	-	-13.0

Remark: No (further) spurious emissions were found in the range 20 dB below the limit.

Op. Mode	Setup	Port
op-mode 3	setup_a02	antenna connector

Frequency MHz	Bandwidth kHz	Measured Level dBm	Limit dBm
849.0	3.0	-13.5	-13.0

Remark: No (further) spurious emissions were found in the range 20 dB below the limit.

3.3.4 Test result: Spurious emissions at antenna terminals

FCC Part 22, Subpart H	Op. Mode	Result
	op-mode 1	passed
	op-mode 2	passed
	op-mode 3	passed



3.4 Field strength of spurious radiation

Standard FCC Part 22, 10-1-07
Subpart H

The test was performed according to: FCC §2.1053, 10-1-07

3.4.1 Test Description

1) The EUT was placed inside an anechoic chamber. Refer to chapter "Setup Drawings". The EUT was coupled to the R&S CMU200 Digital Communication Tester which was located outside the chamber via coaxial cable.

2) A call was established on a Traffic Channel (TCH) between the EUT and the base station simulator (R&S CMU200 Digital Communication Tester).

Important Settings:

- Discontinuous Transmission: OFF
- Modulation Signal: PSR16-1 (Pseudo Random Sequence)
- Output Power: Maximum
- Channel : Varied during measurements
(lowest channel: 128, mid channel: 190 and highest channel: 251)

3) A pre-calibration procedure is used so that the readings from the spectrum analyser are corrected and represent directly the equivalent radiated power (related to a $\lambda/2$ dipole).

4) All spurious radiation measurements were made with spectrum analyser and the appropriate calibrated antennas for the frequency range of 30 MHz to 10 GHz (up to the 10th harmonic of the transmit frequency).

5) Important Analyser Settings

- [Resolution Bandwidth / Video Bandwidth]:

a) [3 kHz / 3 kHz] in the Span of 1 MHz directly below and above the GSM-Band,

b) [10 kHz / 30 kHz] in case the curve of the analyser IF-Filter leads to an exceeding of the limit, in this case a worst case correction factor of 20 dB (1 MHz -> 10 kHz) was used

c) [1 MHz / 3 MHz] otherwise

- Sweep Time: Calculated by using a formula given in the Product Standard "GSM 11.10-1 edition 4" for spurious emissions measurements (depending on the transmitting signal, the span and the resolution bandwidth)

6) The spurious emissions (peak) were measured in both vertical and horizontal antenna polarisation during the call is established on the lowest channel (128), mid channel (190) and on the highest channel (251).

3.4.2 Test Requirements / Limits

§ 2.1053 Measurements required: Field strength of spurious radiation.

Measurements shall be made to detect spurious emissions that may be radiated directly from the cabinet, control circuits, power leads, or intermediate circuit elements under normal conditions of installation and operation. Curves or equivalent data shall be supplied showing the magnitude of each harmonic and other spurious emission. For this test, single sideband, independent sideband, and controlled carrier transmitters shall be modulated under the conditions specified in paragraph (c) of Sec. 2.1049, as appropriate.

For equipment operating on frequencies below 890 MHz, an open field test is normally required, with the measuring instrument antenna located in the far-field at all test frequencies. In the event it is either impractical or impossible to make open field measurements (e.g. a broadcast transmitter installed in a building) measurements will be accepted of the equipment as installed. Such measurements must be accompanied by a description of the site where the measurements were made showing the location of any possible source of reflections which might distort the field strength measurements. Information submitted shall include the relative radiated power of each spurious emission with reference to the rated power output of the transmitter, assuming all emissions are radiated from halfwave dipole antennas.

(b) The measurements specified in paragraph (a) of this section shall be made for the following equipment:

(2) All equipment operating on frequencies higher than 25 MHz.

§ 2.1057 Frequency spectrum to be investigated.

(a) In all of the measurements set forth in Secs. 2.1051 and 2.1053, the spectrum shall be investigated from the lowest radio frequency signal generated in the equipment, without going below 9 kHz, up to at least the frequency shown below:

(1) If the equipment operates below 10 GHz: to the tenth harmonic of the highest fundamental frequency or to 40 GHz, whichever is lower.

(b) Particular attention should be paid to harmonics and subharmonics of the carrier frequency as well as to those frequencies removed from the carrier by multiples of the oscillator frequency. Radiation at the frequencies of multiplier stages should also be checked.

(c) The amplitude of spurious emissions which are attenuated more than 20 dB below the permissible value need not be reported.

(d) Unless otherwise specified, measurements above 40 GHz shall be performed using a minimum resolution bandwidth of 1 MHz.

§ 22.917 Emission limitations for cellular equipment

(a) The power of any emission outside of the authorized operating frequency ranges must be attenuated below the transmitting power (P) by a factor of at least $43 + 10 \log(P)$ dB.

This is calculated to be -13 dBm (effective radiated power) which corresponds to 84.6 dB μ V/m (field strength) in a distance of 3 m.

(b) Compliance with these rules is based on the use of measurement instrumentation employing a resolution bandwidth of 100 kHz or greater. In the 1 MHz bands immediately outside and adjacent to the frequency block a resolution bandwidth of at least one percent of the emission bandwidth of the fundamental emission of the transmitter may be employed. A narrower resolution bandwidth is permitted in all cases to improve measurement accuracy provided the measured power is integrated over the full required measurement bandwidth (*i.e.* 100 kHz or 1 percent of emission bandwidth, as specified). The emission bandwidth is defined as the width of the signal between two points, one below the carrier center frequency and one above the carrier center frequency, outside of which all emissions are attenuated at least 26 dB below the transmitter power.

(c) Licensees in this service may establish an alternative out of band emission limit to be used at specified band edge(s) in specified geographical areas [...].

(d) If any emission from a transmitter operating in this service results in interference to users of another radio service, the FCC may require a greater attenuation of that emission than specified in this section.



3.4.3 Test Protocol

Temperature: 24 °C
 Air Pressure: 1021 hPa
 Humidity: 32 %

Op. Mode	Setup	Port
op-mode 1	setup_a01	enclosure

Frequency MHz	Antenna Polarisation	Bandwidth kHz	Measured Level dBm	Limit dBm
824.0	Horizontal	3.0	-14.4	-13.0

Remark: No (further) spurious emissions were found in the range 20 dB below the limit.

Op. Mode	Setup	Port
op-mode 2	setup_a01	enclosure

Frequency MHz	Antenna Polarisation	Bandwidth kHz	Measured Level dBm	Limit dBm
-	-	-	-	-13.0

Remark: No (further) spurious emissions were found in the range 20 dB below the limit.

Op. Mode	Setup	Port
op-mode 3	setup_a01	enclosure

Frequency MHz	Antenna Polarisation	Bandwidth kHz	Measured Level dBm	Limit dBm
849.0	Horizontal	3.0	-15.4	-13.0

Remark: No (further) spurious emissions were found in the range 20 dB below the limit.

3.4.4 Test result: Field strength of spurious radiation

FCC Part 22, Subpart H	Op. Mode	Result
	op-mode 1	passed
	op-mode 2	passed
	op-mode 3	passed



3.5 Emission and Occupied Bandwidth

Standard FCC Part 22, 10-1-07
Subpart H

The test was performed according to: FCC §2.1049, 10-1-07

3.5.1 Test Description

- 1) The EUT was coupled to the R&S Spectrum Analyser and the R&S CMU200 Digital Communication Tester through a Power Divider. Refer to chapter "Setup Drawings".
- 2) The total insertion losses for RF Path 1 and RF Path 2 were measured. The values were used to correct the readings from the R&S Spectrum Analyser and the R&S CMU200 Digital Communication Tester.
- 3) A call was established on a Traffic Channel (TCH) between the EUT and the base station simulator (R&S CMU200 Digital Communication Tester).
Important Settings:
 - Discontinuous Transmission: OFF
 - Modulation Signal: PSR16-1 (Pseudo Random Sequence)
 - Output Power: Maximum
 - Channel: Varied during measurements
(lowest channel: 128, mid channel: 190 and highest channel: 251)
- 4) Important Analyser Settings:
 - Resolution Bandwidth: 3 kHz (1% of the manufacturers stated occupied bandwidth)
 - Video Bandwidth: 10 kHz (three times the Resolution Bandwidth)
 - Sweep Span: 1 MHz (at least 250% of the emission bandwidth)
- 5) The maximum spectral level of the modulated signal was recorded as the reference.
- 6) The emission bandwidth is measured as follows:
the two furthest frequencies above and below the frequency of the maximum reference level where the spectrum is -26 dB down have to be found.
- 7) The occupied bandwidth (99% Bandwidth) is measured as follows:
the occupied bandwidth, that is the frequency bandwidth such that, below its lower and above its upper frequency limits, the mean powers radiated are each equal to 0.5 percent of the total mean power.



3.5.2 Test Requirements / Limits

§ 2.1049 Measurements required: Occupied bandwidth

The occupied bandwidth, that is the frequency bandwidth such that, below its lower and above its upper frequency limits, the mean powers radiated are each equal to 0.5 percent of the total mean power radiated by a given emission shall be measured under the following conditions (as applicable):

(h) Transmitters employing digital modulation techniques - when modulated by an input signal such that its amplitude and symbol rate represent the maximum rated conditions under which the equipment will be operated. The signal shall be applied through any filter networks, pseudo-random generators or other devices required in normal service. Additionally, the occupied bandwidth shall be shown for operation with any devices used for modifying the spectrum when such devices are optional at the discretion of the user.



3.5.3 Test Protocol

Temperature: 23 °C
 Air Pressure: 1003 hPa
 Humidity: 35 %

Op. Mode	Setup	Port
op-mode 1	setup_a02	antenna connector

Bandwidth kHz	Remarks
314	please see annex

Remark: The given value is the result of the 26dB bandwidth measurement.
 The 99% Bandwidth is 244 kHz.

Op. Mode	Setup	Port
op-mode 2	setup_a02	antenna connector

Bandwidth kHz	Remarks
318	please see annex

Remark: The given value is the result of the 26dB bandwidth measurement.
 The 99% Bandwidth is 248 kHz.

Op. Mode	Setup	Port
op-mode 3	setup_a02	antenna connector

Bandwidth kHz	Remarks
316	please see annex

Remark: The given value is the result of the 26dB bandwidth measurement.
 The 99% Bandwidth is 248 kHz.

3.5.4 Test result: Emission and Occupied Bandwidth

FCC Part 22, Subpart H	Op. Mode	Result
	op-mode 1	passed
	op-mode 2	passed
	op-mode 3	passed



3.6 Band edge compliance

Standard FCC Part 22, 10-1-07
Subpart H

The test was performed according to: FCC §22.913, 10-1-07

3.6.1 Test Description

- 1) The EUT was coupled to the R&S CMU200 Digital Communications Tester via a 10 dB attenuator and a 6 dB coupler.
- 2) For the measurement the EUT is connected to the Spectrum Analyser via 30 dB attenuator and 6 dB coupler.
- 3) The spectrum analyser is set to a RBW/VBW of 3 kHz / 3 kHz.

3.6.2 Test Requirements / Limits

§ 22.917 Emission limitations for cellular equipment



3.6.3 Test Protocol

Temperature: 24 °C
Air Pressure: 1021 hPa
Humidity: 32 %

Op. Mode	Setup	Port
op-mode 1	Setup_a01	antenna connector

Frequency MHz	Measured value dBm	Limit dBm
824	-13.6	-13

Remark: Please see annex for the measurement plot.

Op. Mode	Setup	Port
op-mode 3	Setup_a01	antenna connector

Frequency MHz	Measured value dBm	Limit dBm
849	-13.5	-13

Remark: Please see annex for the measurement plot.

3.6.4 Test result: Band edge compliance

FCC Part 22, Subpart H	Op. Mode	Result
	op-mode 1	passed
	op-mode 3	passed

4 Test Equipment

EUT Digital Signalling System

Equipment	Type	Serial No.	Manufacturer	Cal data	Next cal
Digital Radio Communication Tester	CMD 55	831050/020	Rohde & Schwarz	01.12.05	01.12.08
Signalling Unit for Bluetooth	PTW60	100004	Rohde & Schwarz	-	-
Universal Radio Communication Tester	CMU200	102366	Rohde & Schwarz	22.09.07	22.09.09
Universal Radio Communication Tester	CMU200	837983/052	Rohde & Schwarz	22.09.07	22.09.09
Signalling Unit for Bluetooth	CBT	100302	Rohde & Schwarz	22.09.06	N/A – only used for signalling

EMI Test System

Equipment	Type	Serial No.	Manufacturer	Cal data	Next cal
Comparison Noise Emitter	CNE III	99/016	York	-	-
EMI Analyzer	ESI 26	830482/004	Rohde & Schwarz	06.12.07	06.12.09
Signal Generator	SMR 20	846834/008	Rohde & Schwarz	05.12.07	05.12.09

EMI Radiated Auxiliary Equipment

Equipment	Type	Serial No.	Manufacturer	Cal data	Next cal
Antenna mast 4m	MA 240	240/492	HD GmbH H. Deisel	-	-
Biconical dipole	VUBA 9117	9117108	Schwarzbeck	02.07.03	02.07.08
Broadband Amplifier 18MHz-26GHz	JS4- 18002600 -32	849785	Miteq	06.02.08	06.08.08
Broadband Amplifier 30MHz-18GHz	JS4- 00101800 -35	896037	Miteq	06.02.08	06.08.08
Broadband Amplifier 45MHz-27GHz	JS4- 00102600 -42	619368	Miteq	06.02.08	06.08.08
Cable "ESI to EMI Antenna"	EcoFlex10	W18.01-2 W38.01-2	Kabel Kusch	06.02.08	06.08.08
Cable "ESI to Horn Antenna"	UFB311A UFB293C	W18.02-2 W38.02-2	Rosenberger- Microcoax	06.02.08	06.08.08
Double-ridged horn	HF 906	357357/002	Rohde & Schwarz	12.05.06	12.05.08
Double-ridged horn	HF 906	357357/001	Rohde & Schwarz	20.01.04	N/A – spare antenna
High Pass Filter	5HC3500/ 12750- 1.2-KK	200035008	Trilithic	06.02.08	06.08.08
High Pass Filter	5HC2700/ 12750- 1.5-KK	9942012	Trilithic	06.02.08	06.08.08
High Pass Filter	4HC1600/ 12750- 1.5-KK	9942011	Trilithic	06.02.08	06.08.08
Log.-per. Antenna	HL 562 Ultralog	830547/003	Rohde & Schwarz	17.05.06	17.05.09
Loop Antenna	HFH2-Z2	829324/006	Rohde & Schwarz	19.08.02	N/A – only used for pre-testing
Pyramidal Horn Antenna 26.5 GHz	Model 3160-09	9910-1184	EMCO	06.02.08	06.08.08

EMI Conducted Auxiliary Equipment

Equipment	Type	Serial No.	Manufacturer	Cal data	Next cal
Cable "LISN to ESI"	RG214	W18.03+W48.03	Huber+Suhner	06.02.08	06.08.08
Two-Line V-Network	ESH 3-Z5	828304/029	Rohde & Schwarz	01.11.05	01.11.08
Two-Line V-Network	ESH 3-Z5	829996/002	Rohde & Schwarz	-	-

Auxiliary Test Equipment

Equipment	Type	Serial No.	Manufacturer	Cal data	Next cal
Broadband Resist. Power Divider N	1506A / 93459	LM390	Weinschel	-	-
Broadband Resist. Power Divider SMA	1515 / 93459	LN673	Weinschel	-	-
Digital Multimeter 01	Voltcraft M-3860M	IJ096055	Conrad	-	-
Digital Multimeter 02	Voltcraft M-3860M	IJ095955	Conrad	-	-
Digital Oscilloscope	TDS 784C	B021311	Tektronix	-	-
Fibre optic link Satellite	FO RS232 Link	181-018	Pontis	-	-
Fibre optic link Transceiver	FO RS232 Link	182-018	Pontis	-	-
I/Q Modulation Generator	AMIQ-B1	832085/018	Rohde & Schwarz	-	-
Notch Filter ultra stable	WRCA800 /960-6E	24	Wainwright	-	-
Spectrum Analyzer 9 kHz to 3 GHz	FSP3	838164/004	Rohde & Schwarz	-	-
Temperature Chamber	VT 4002	58566002150010	Vötsch	-	-
Temperature Chamber	KWP 120/70	59226012190010	Weiss	-	-
ThermoHygro Datalogger 03	Opus10 THI (8152.00)	7482	Lufft Mess- und Regeltechnik GmbH	-	-

Anechoic Chamber

Equipment	Type	Serial No.	Manufacturer	Cal data	Next cal
Air Compressor (pneumatic)			Atlas Copco	-	-
Controller	CO 2000	CO2000/328/12470406/L	Innco innovative constructions GmbH	-	-
EMC Camera	CE-CAM/1		CE-SYS	-	-
EMC Camera for observation of EUT	CCD-400E	0005033	Mitsubishi	-	-
Filter ISDN	B84312-C110-E1		Siemens & Matsushita	-	-
Filter telephone systems / modem	B84312-C40-B1		Siemens & Matsushita	-	-
Filter Universal 1A	B84312-C30-H3		Siemens & Matsushita	-	-
Fully/Semi AE Chamber	10.58x6.3 8x6		Frankonia	-	-
Turntable	DS 420S	420/573/99	HD GmbH, H.Deisel	-	-
Valve Control Unit (pneum.)	VE 615P	615/348/99	HD GmbH, H.Deisel	-	-



7 layers Bluetooth™ Full RF Test Solution

Bluetooth RF Conformance Test System TS8960

Equipment	Type	Serial No.	Manufacturer	Cal data	Next cal
Power Meter 832025/059	NRVD	832025/059	Rohde & Schwarz	22.08.07	22.08.08
Power Sensor A 832279/013	NRV-Z1	832279/013	Rohde & Schwarz	23.08.07	23.08.08
Power Sensor B 832279/015	NRV-Z1	832279/015	Rohde & Schwarz	23.08.07	23.08.08
Power Supply	E3632A	MY40003776	Agilent	-	-
Power Supply	PS-2403D	-	Conrad	-	-
RF Step Attenuator 833695/001	RSP	833695/001	Rohde & Schwarz	09.08.06	09.08.08
Rubidium Frequency Normal	MFS	002	Efratom	24.08.07	24.08.08
Signal Analyzer FSIQ26 832695/007	FSIQ26	832695/007	Rohde & Schwarz	23.08.07	23.08.09
Signal Generator 833680/003	SMP 03	833680/003	Rohde & Schwarz	04.07.06	04.07.09
Signal Generator A 834344/002	SMIQ03B	834344/002	Rohde & Schwarz	04.07.06	04.07.09
Signal Generator B 832870/017	SMIQ03B	832870/017	Rohde & Schwarz	24.05.07	24.05.10
Signal Switching and Conditioning Unit	SSCU	338826/005	Rohde & Schwarz	-	-
Signalling Unit PTW60 838312/014	PTW60 for TS8960	838312/014	Rohde & Schwarz	-	-
System Controller 829323/008	PSM12	829323/008	Rohde & Schwarz	-	-

5 Photo Report

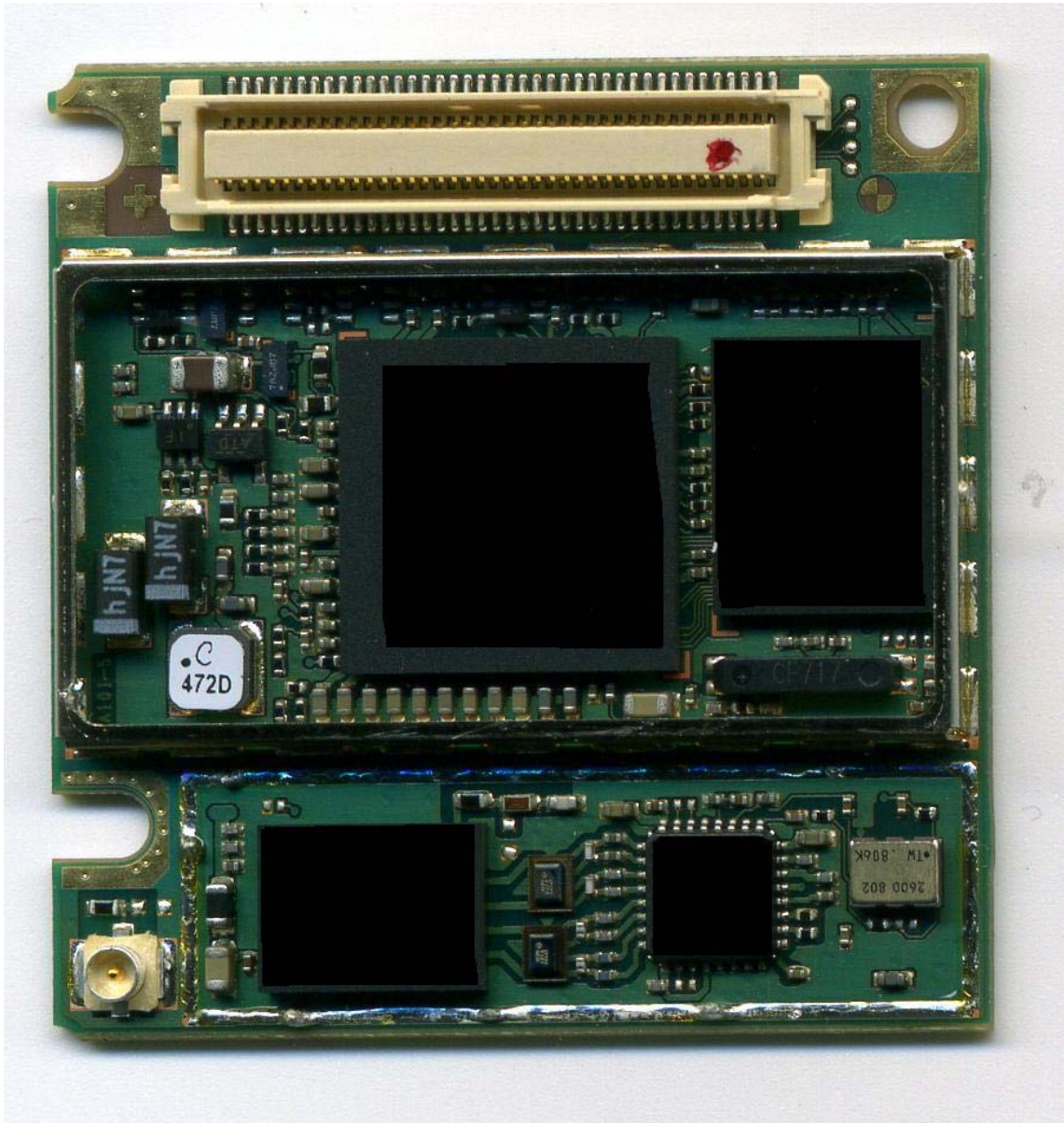

Photo 1: EUT (upper side)



Photo 2: EUT (lower side)

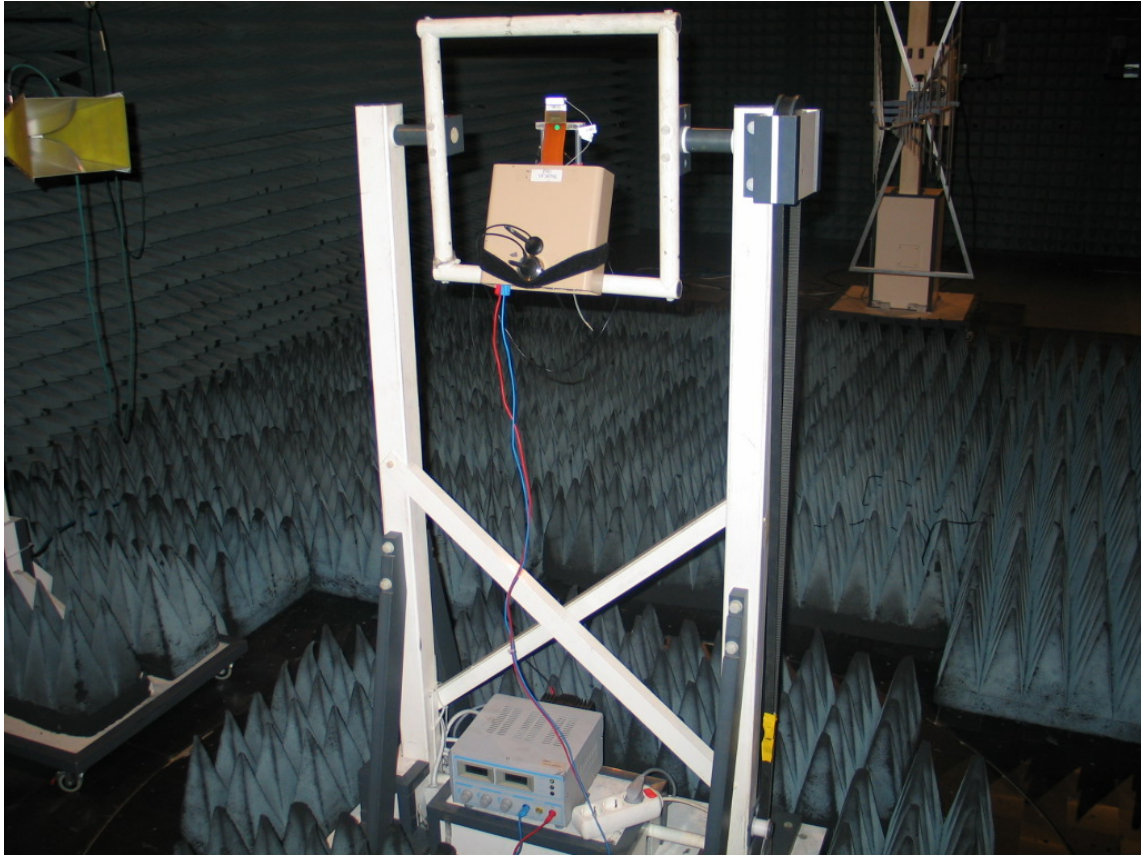

Photo 3: Setup for radiated tests

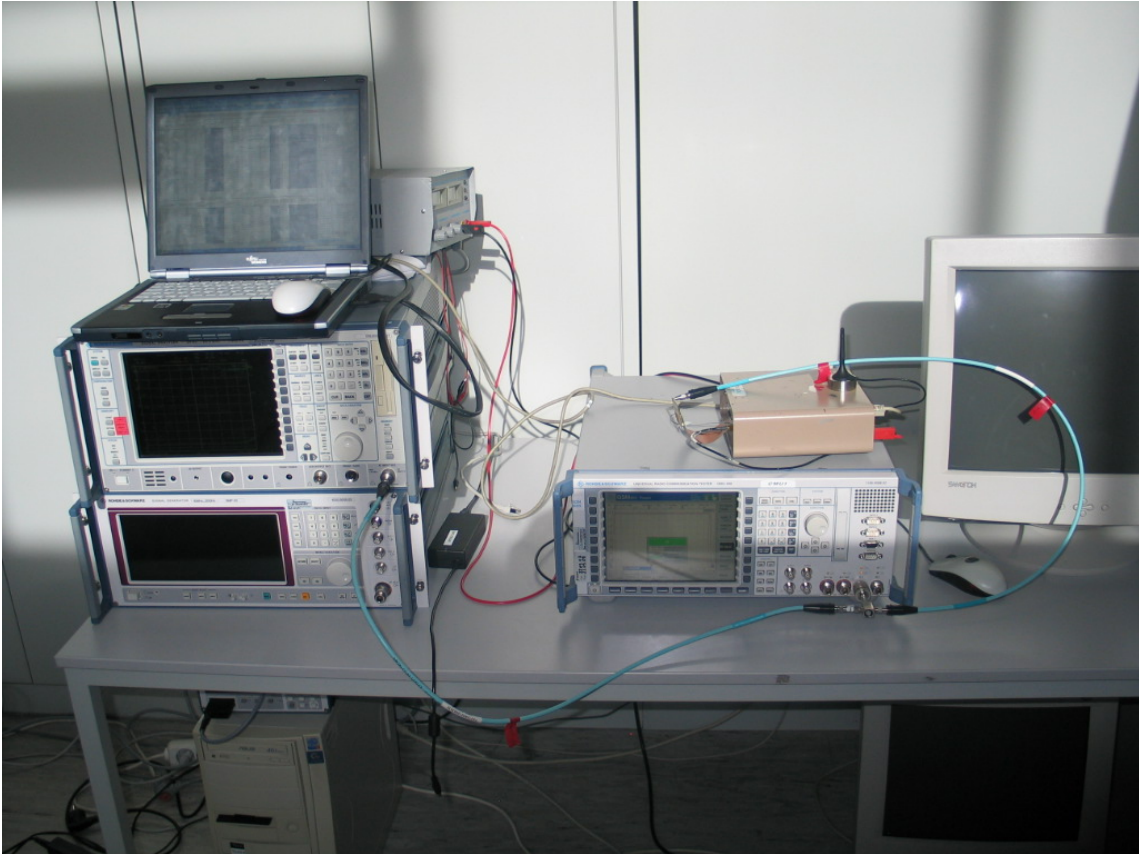
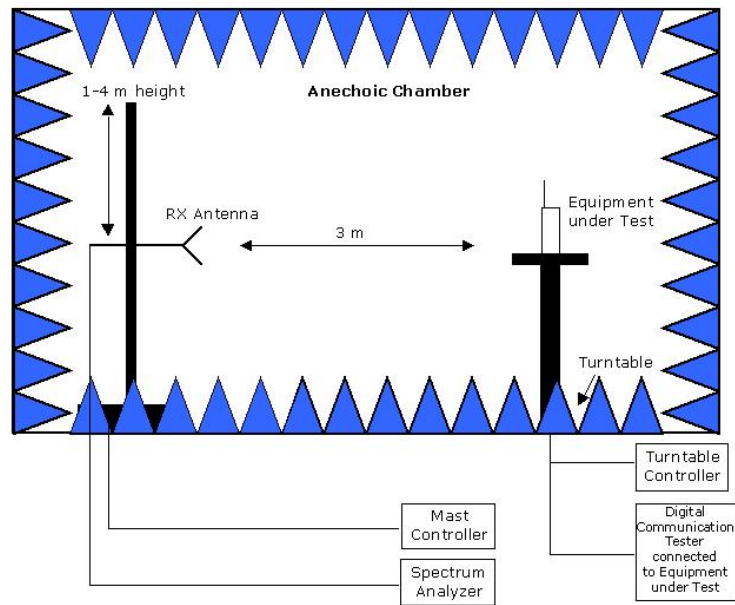

Photo 4: Setup for conducted tests

6 Setup Drawings



Remark: Depending on the frequency range suitable antenna types, attenuators or preamplifiers are used.

Drawing 1: Principle setup for radiated measurements.

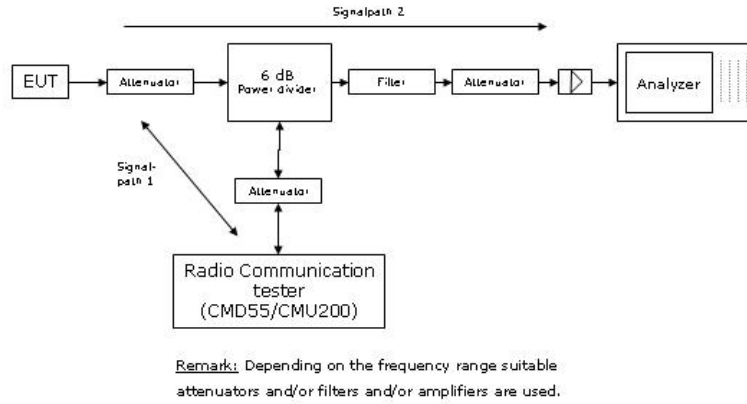

Drawing 2: Principle setup for conducted measurements under nominal conditions

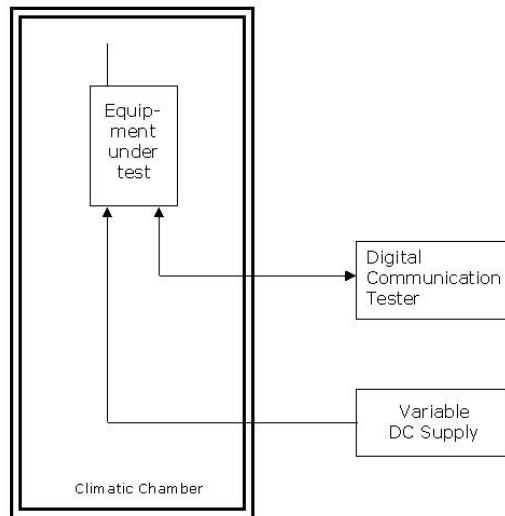

Drawing 3: Principle setup for tests under extreme test conditions



7 Annex

Measurement plots RF Power Output

Op. Mode

op-mode 1

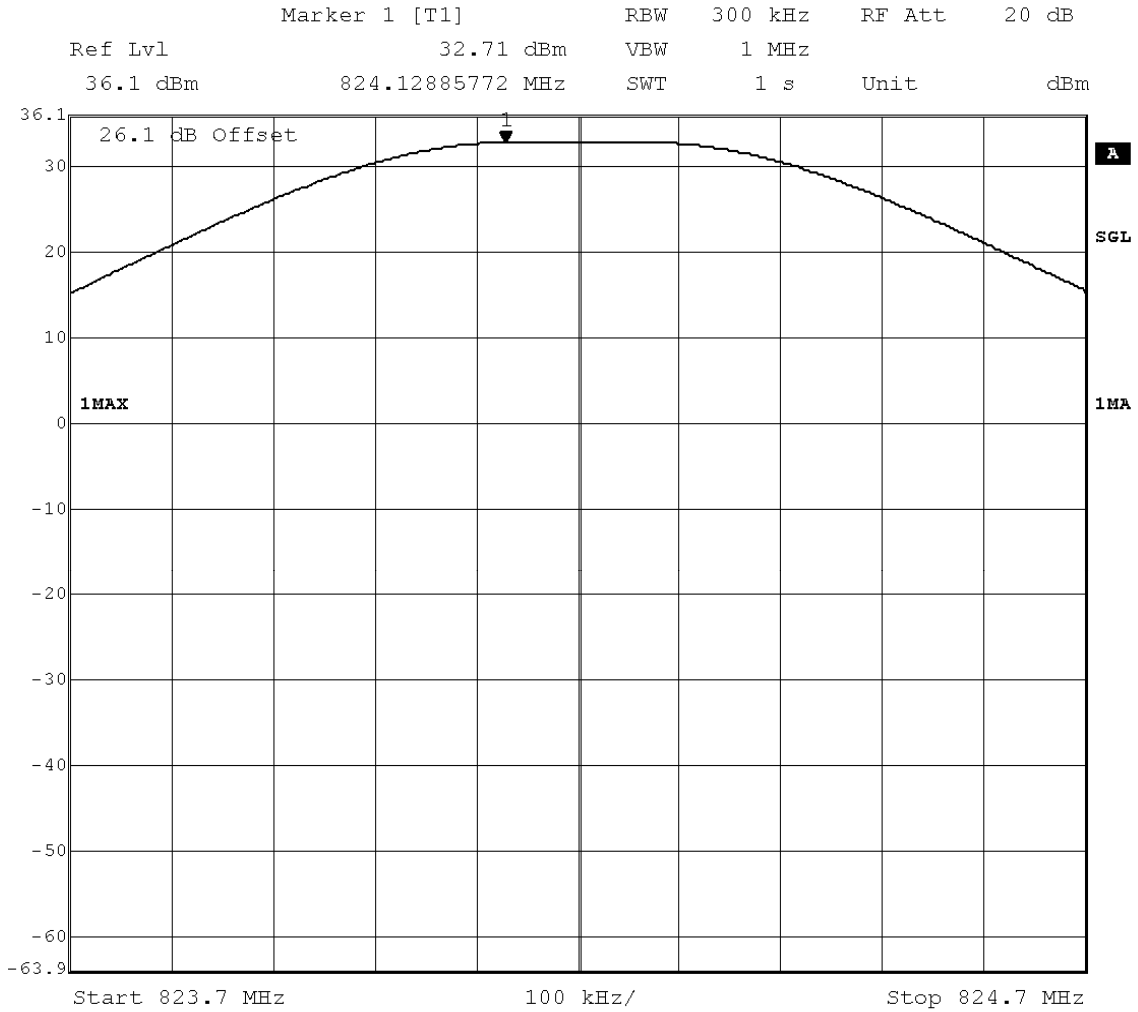

Title: DUT 01422c01

Comment A: PCS data call, output power, op-mode 1, channel 128
(824.2MHz)

Date: 29.APR.2008 17:52:38

Test: RF Output Power, Channel 128 (824.2 MHz)



Op. Mode

op-mode 2

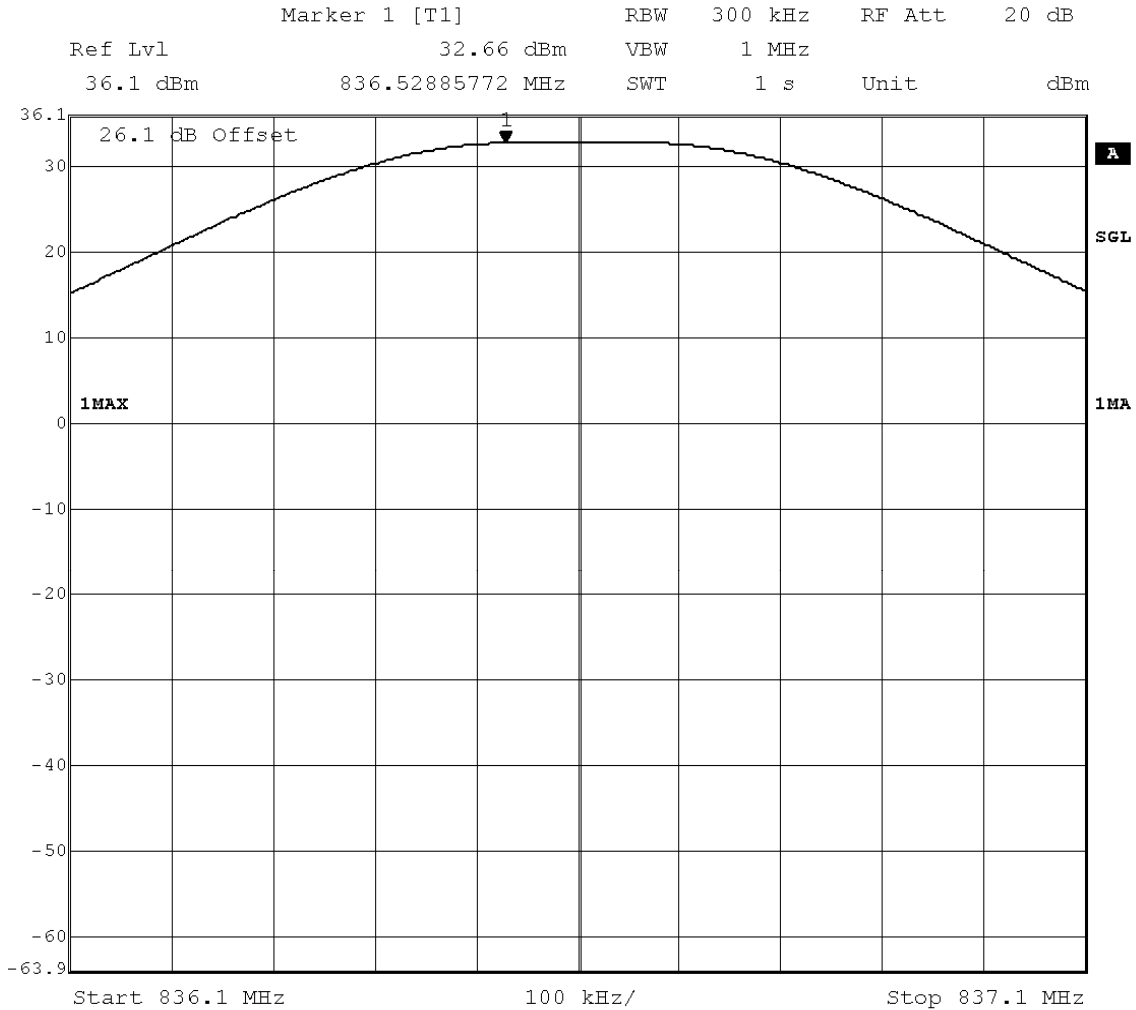

Title: DUT 01422c01
Comment A: PCS data call, output power, op-mode 2, channel 190 (836.6MHz)
Date: 29.APR.2008 18:10:38

Test: RF Output Power, Channel 190 (836.6 MHz)



Op. Mode

op-mode 3

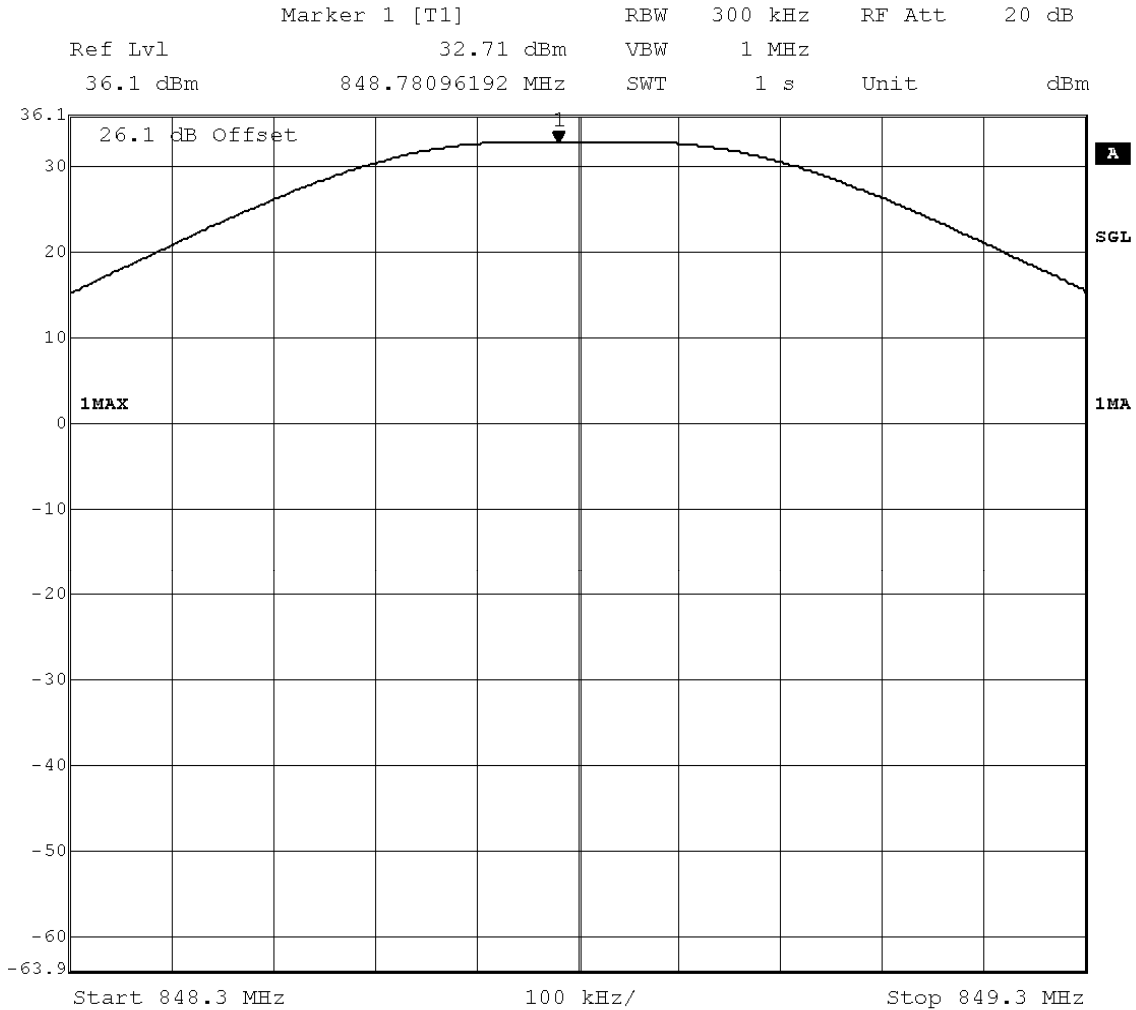

Title: DUT 01422c01
Comment A: PCS data call, output power, op-mode 3, channel 251 (848.8MHz)
Date: 29.APR.2008 18:21:46

Test: RF Output Power, Channel 251 (848.8 MHz)



Measurement plots Emission and Occupied Bandwidth

Op. Mode

op-mode 1

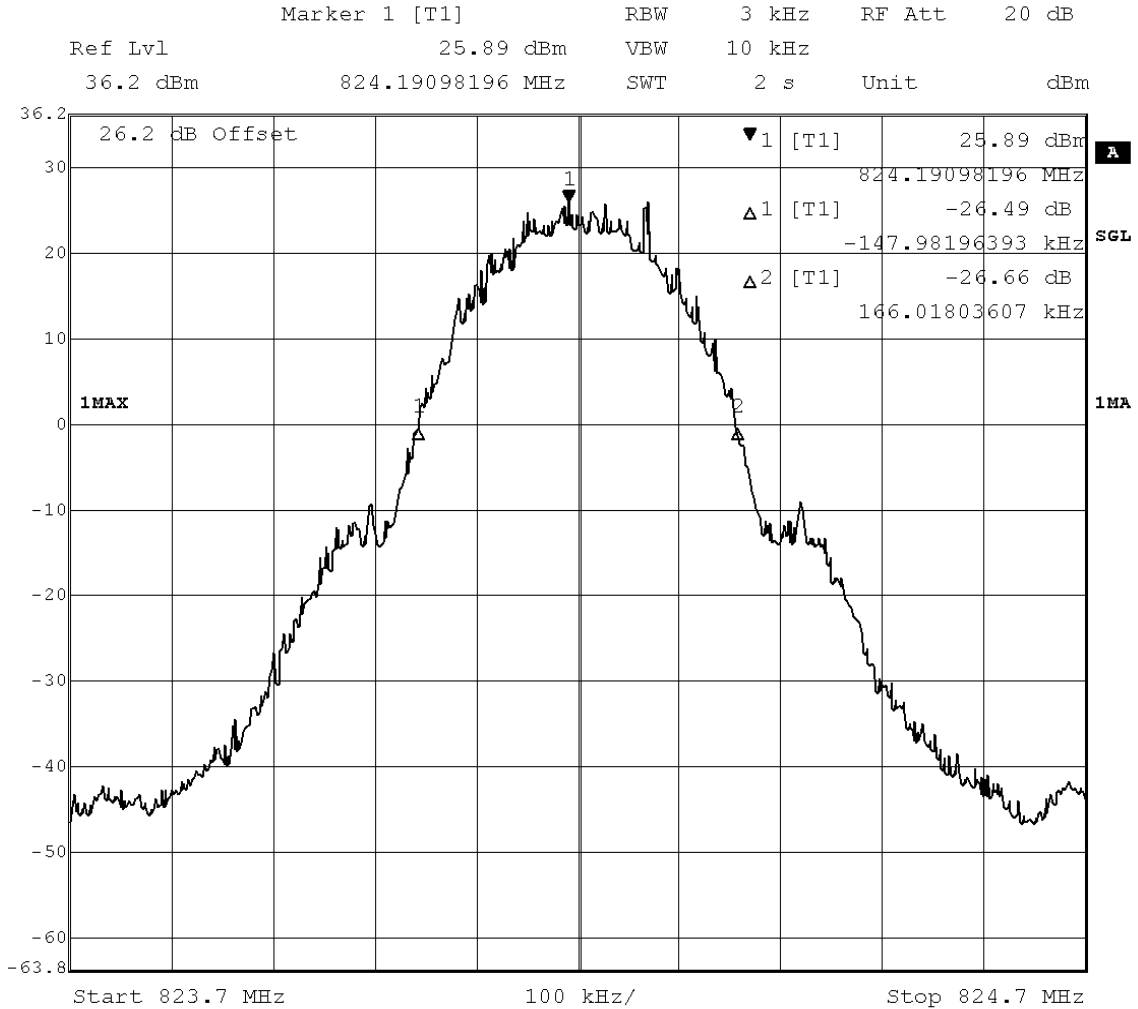

Title: DUT 01422c01

Comment A: PCS data call, 26dB bandwidth, op-mode 1, channel 128 (824.2MHz)

Date: 29.APR.2008 17:50:41

Test: Emissions bandwidth (26 dB bandwidth), Channel 128 (824.2 MHz)



Op. Mode

op-mode 1

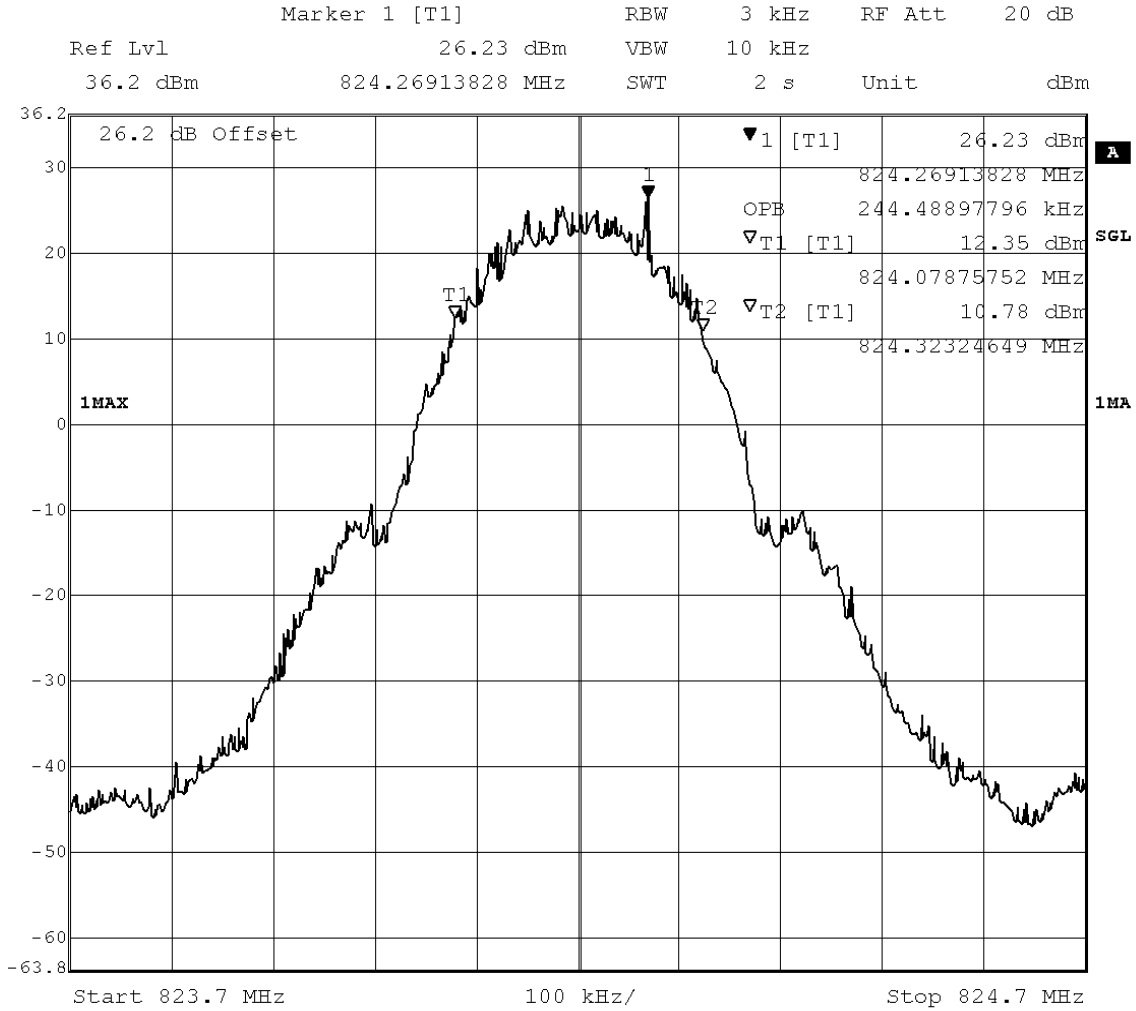

Title: DUT 01422c01
 Comment A: PCS data call, occupied bandwidth (99%), op-mode 1,
 channel 128 (824.2MHz)
 Date: 29.APR.2008 17:52:04

Test: Occupied bandwidth, Channel 128 (824.2 MHz)



Op. Mode

op-mode 2

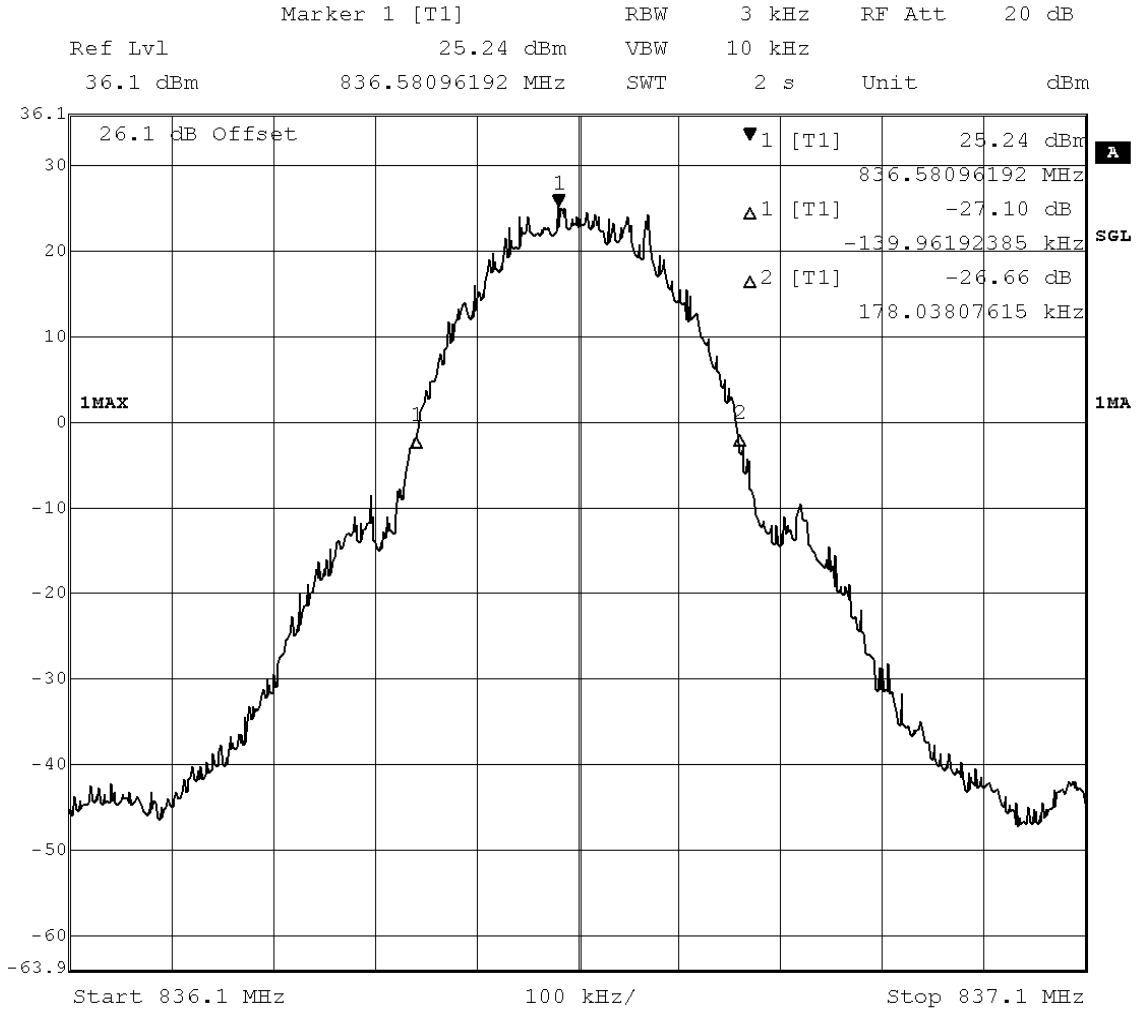

Title: DUT 01422c01
 Comment A: PCS data call, 26dB bandwidth, op-mode 2, channel 190 (836.6MHz)
 Date: 29.APR.2008 18:08:40

Test: Emissions bandwidth (26 dB bandwidth), Channel 190 (836.6 MHz)



Op. Mode

op-mode 2

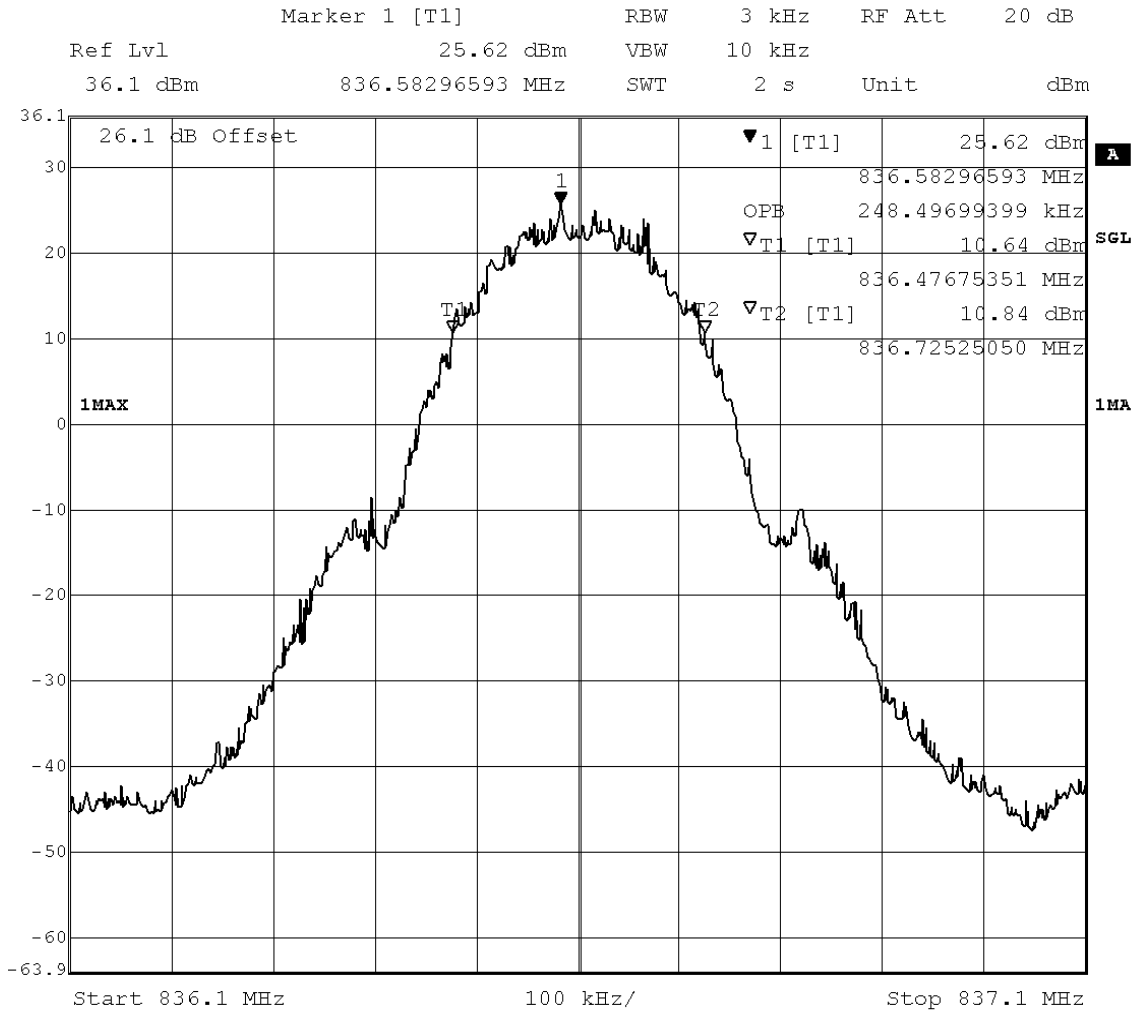

Title: DUT 01422c01
 Comment A: PCS data call, occupied bandwidth (99%), op-mode 2, channel 190 (836.6MHz)
 Date: 29.APR.2008 18:10:04

Test: Occupied bandwidth, Channel 190 (836.6 MHz)



Op. Mode

op-mode 3

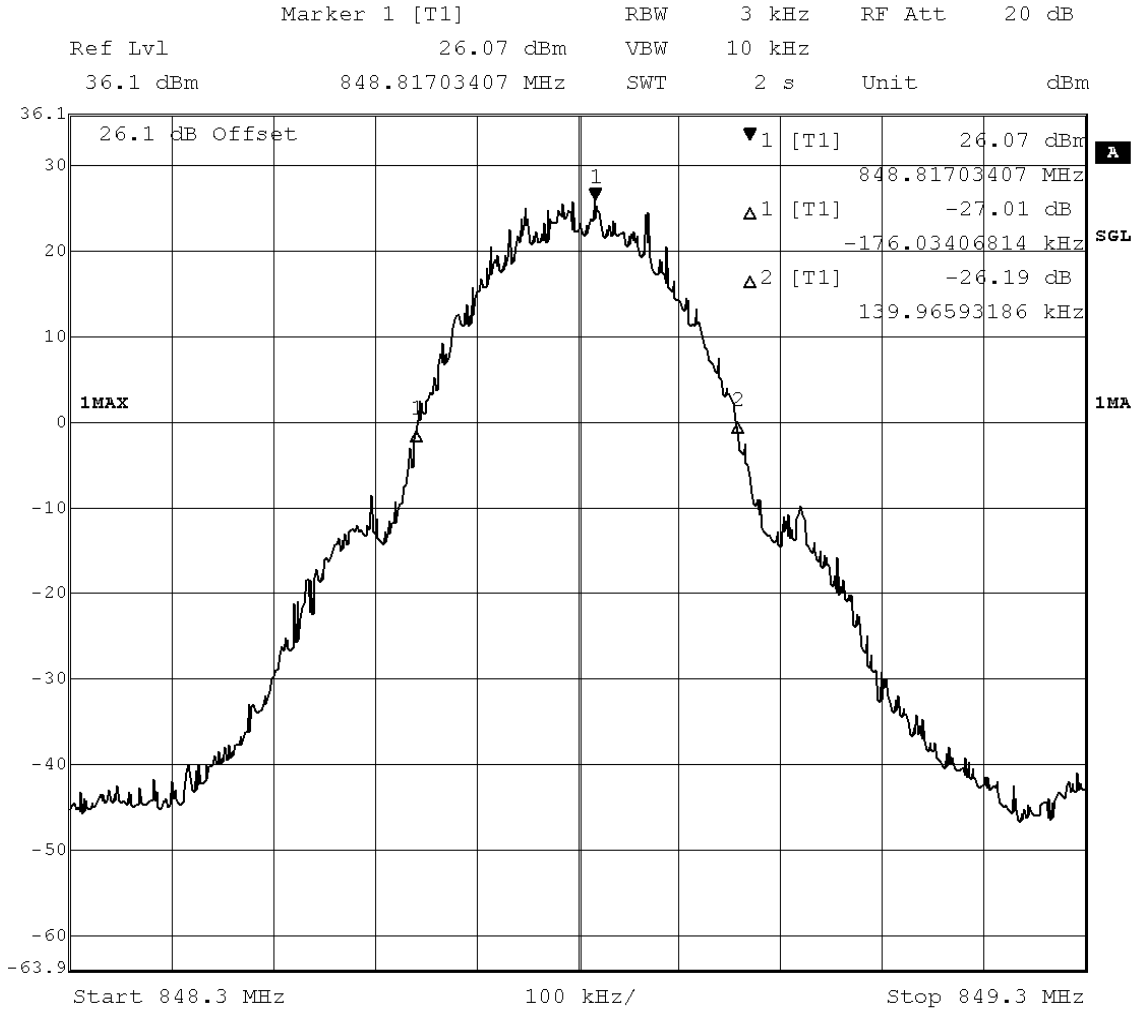

Title: DUT 01422c01
 Comment A: PCS data call, 26dB bandwidth, op-mode 3, channel 251 (848.8MHz)
 Date: 29.APR.2008 18:19:48

Test: Emissions bandwidth (26 dB bandwidth), Channel 251 (848.8 MHz)



Op. Mode

op-mode 3

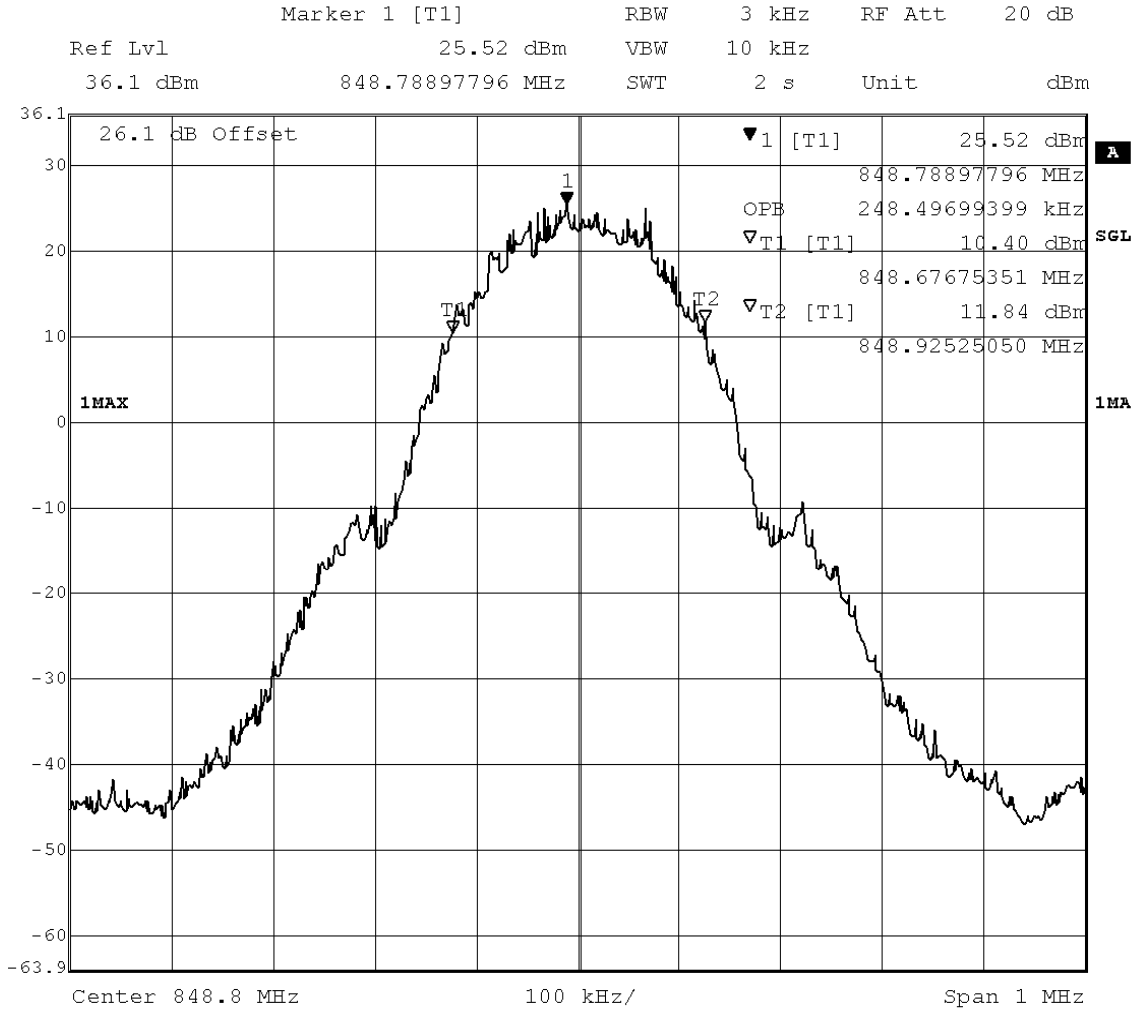

Title: DUT 01422c01
 Comment A: PCS data call, occupied bandwidth (99%), op-mode 3, channel 251 (848.8MHz)
 Date: 29.APR.2008 18:21:12

Test: Occupied bandwidth, Channel 251 (848.8 MHz)



Measurement plots Band edge compliance

Op. Mode

op-mode 1

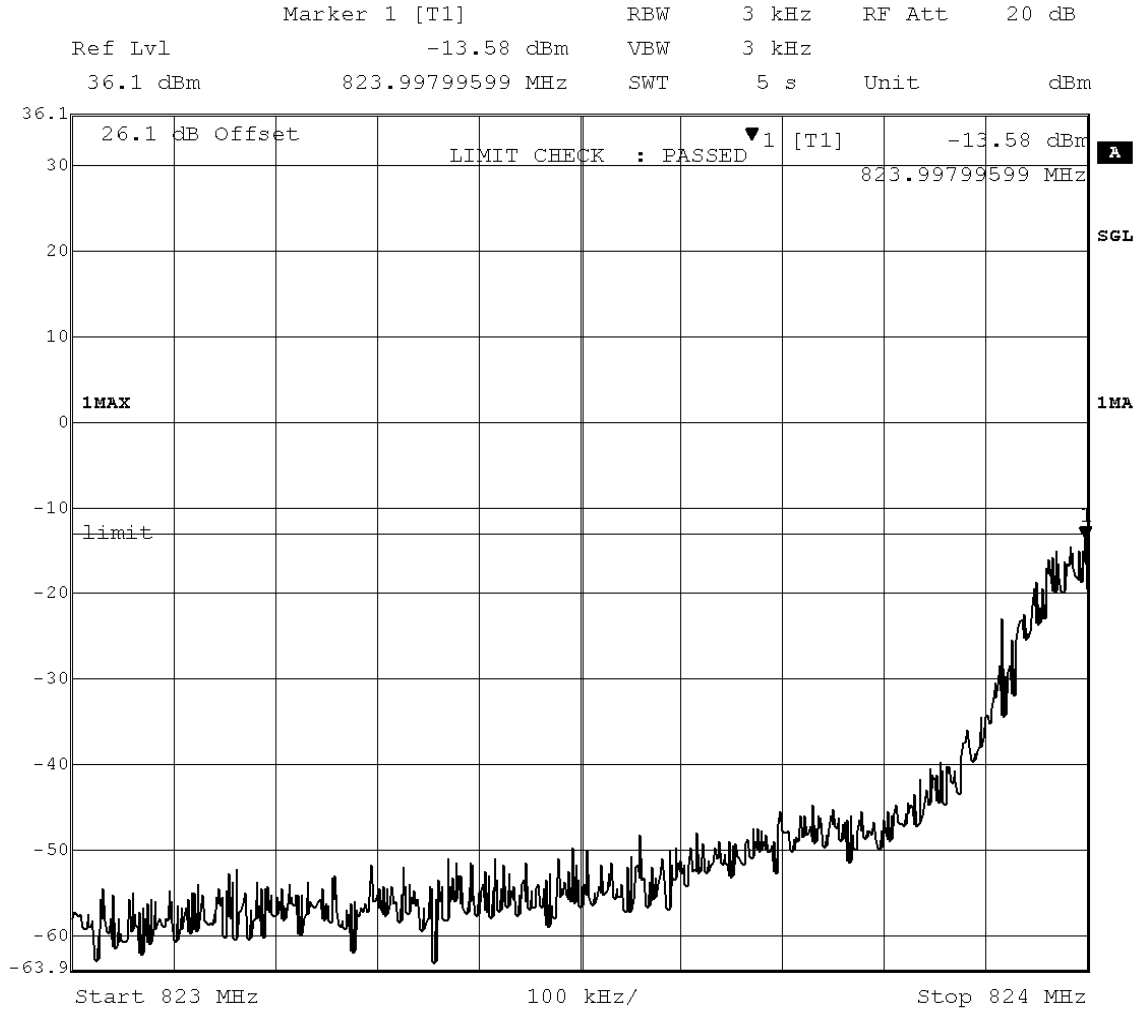

Title: DUT 01422c01
Comment A: PCS data call, band edge compliance, op-mode 1,
channel 128 (824.2MHz)
Date: 29.APR.2008 18:02:38

Test: band edge compliance , Channel 128, GSM



Op. Mode

op-mode 3

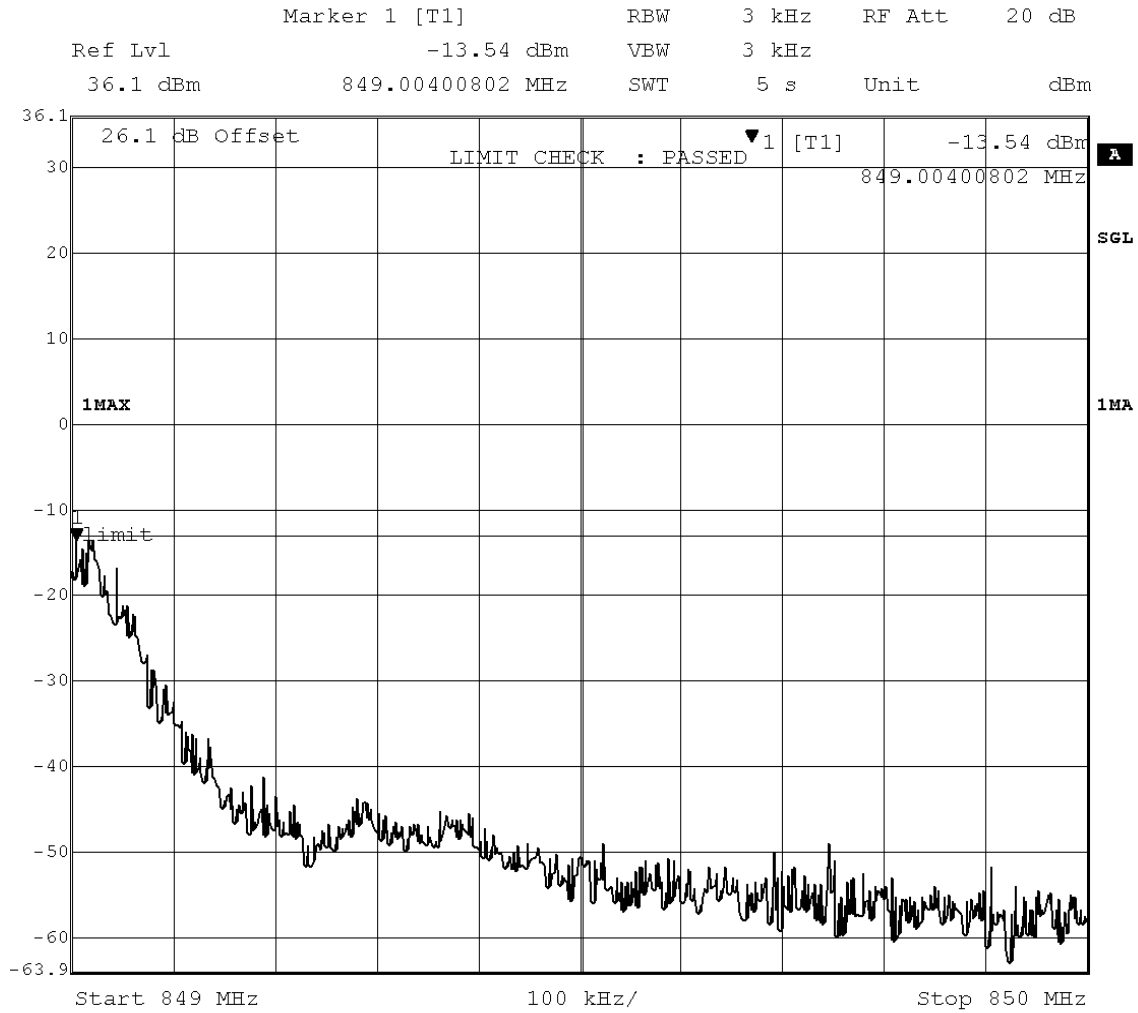

Title: DUT 01422c01
Comment A: PCS data call, band edge compliance, op-mode 3,
channel 251 (848.8MHz)
Date: 29.APR.2008 18:22:09

Test: band edge compliance , Channel 251, GSM