FCC Test Report

Report No.: AGC00924160601FE03

FCC ID : QIFE06-C
APPLICATION PURPOSE : Original Equipment
PRODUCT DESIGNATION : Bluetooth Headset
BRAND NAME : My Music
MODEL NAME : E06-C
CLIENT : My Music Group Limited
DATE OF ISSUE : Jun.08, 2016
STANDARD(S) : FCC Part 15 Rules
TEST PROCEDURE(S)
REPORT VERSION : V1.0

Attestation of Global Compliance (Shenzhen) Co., Ltd



CAUTION:

This report shall not be reproduced except in full without the written permission of the test laboratory and shall not be quoted out of context.



Report Revise Record

Report Version	Revise Time	Issued Date	Valid Version	Notes
V1.0	/	Jun.08, 2016	Valid	Original Report

TABLE OF CONTENTS

1. VERIFICATION OF CONFORMITY	4
2. GENERAL INFORMATION	5
2.1. PRODUCT DESCRIPTION.....	5
2.2. TABLE OF CARRIER FREQUENCYS.....	5
3. MEASUREMENT UNCERTAINTY.....	6
4. DESCRIPTION OF TEST MODES.....	6
5. SYSTEM TEST CONFIGURATION	7
5.1. CONFIGURATION OF EUT SYSTEM	7
5.2. EQUIPMENT USED IN EUT SYSTEM	7
5.3. SUMMARY OF TEST RESULTS	7
6. TEST FACILITY	8
TEST METHODOLOGY.....	8
7. ALL TEST EQUIPMENT LIST	8
8. RADIATED EMISSION	10
8.1TEST LIMIT.....	10
8.2. MEASUREMENT PROCEDURE	11
8.3. TEST SETUP.....	13
8.4. TEST RESULT	15
9. BAND EDGE EMISSION	30
9.1. MEASUREMENT PROCEDURE	30
9.2 TEST SETUP	30
9.3 RADIATED TEST RESULT	31
10. BANDWIDTH	35
10.1. MEASUREMENT PROCEDURE	35
10.2. TEST SET-UP	35
10.3. LIMITS AND MEASUREMENT RESULTS.....	35
11. FCC LINE CONDUCTED EMISSION TEST	42
11.1. LIMITS OF LINE CONDUCTED EMISSION TEST	42
11.2. BLOCK DIAGRAM OF LINE CONDUCTED EMISSION TEST.....	42
11.3. PRELIMINARY PROCEDURE OF LINE CONDUCTED EMISSION TEST	43
11.4. FINAL PROCEDURE OF LINE CONDUCTED EMISSION TEST.....	43
11.5. TEST RESULT OF LINE CONDUCTED EMISSION TEST.....	44
APPENDIX A: PHOTOGRAPHS OF TEST SETUP	46
APPENDIX B: PHOTOGRAPHS OF EUT	48

1. VERIFICATION OF CONFORMITY

Applicant	My Music Group Limited
Address	Room No.2026, Global Logistics Service Center, China South City, Pinghu Town, Longgang District, Shenzhen , China.
Manufacturer	Dongguan Fulun Electronic Co.,Limited
Address	4F,Building A,Huangjinye Industrial park,No.216Shaxin Road,KeyuanCity,Tangxia, Dongguan.China
Product Designation	Bluetooth Headset
Brand Name	My Music
Test Model	E06-C
Date of test	May 24, 2016 to May 25, 2016
Deviation	None
Condition of Test Sample	Normal
Report Template	AGCRT-US-BR/RF

We hereby certify that:

The above equipment was tested by Dongguan Precise Testing Service Co., Ltd. The test data, the energy emitted by the sample tested as described in this report is in compliance with the requirements of FCC Rules Part 15.249.

Tested By 
Time Huang(Huang Nanhui) Jun.08, 2016

Reviewed By 
Forrest Lei(Lei Yonggang) Jun.08, 2016

Approved By 
Solger Zhang(Zhang Hongyi)
Authorized Officer Jun.08, 2016

2. GENERAL INFORMATION

2.1. PRODUCT DESCRIPTION

A major technical description of EUT is described as following

Operation Frequency	2.402 GHz to 2.480GHz
RF Output Power	-1.73dBm(Max)
Bluetooth Version	V2.1+EDR
Modulation	GFSK, $\pi/4$ -DQPSK, 8DPSK
Number of channels	79 for BR/EDR
Hardware Version	V1.0
Software Version	V2_8104
Antenna Designation	PCB Antenna (Met 15.203 Antenna requirement)
Antenna Gain	3.3dBi
Power Supply	DC 3.7V

Note: The USB port only used for charging and can't be used to transfer data with PC.

2.2. TABLE OF CARRIER FREQUENCIES

BR/EDR channel List

Frequency Band	Channel Number	Frequency
2400~2483.5MHZ	0	2402MHZ
	1	2403MHZ
	:	:
	38	2440 MHZ
	39	2441 MHZ
	40	2442 MHZ
	:	:
	77	2479 MHZ
	78	2480 MHZ

3. MEASUREMENT UNCERTAINTY

The reported uncertainty of measurement $y \pm U$, where expanded uncertainty U is based on a standard uncertainty multiplied by a coverage factor of $k=2$, providing a level of confidence of approximately 95 %.

No.	Item	Uncertainty
1	Conducted Emission Test	$\pm 3.18\text{dB}$
2	All emissions, radiated	$\pm 3.91\text{dB}$
3	Temperature	$\pm 0.5^\circ\text{C}$
4	Humidity	$\pm 2\%$

4. DESCRIPTION OF TEST MODES

NO.	TEST MODE DESCRIPTION
1	Low channel GFSK
2	Middle channel GFSK
3	High channel GFSK
4	Low channel $\pi/4$ -DQPSK
5	Middle channel $\pi/4$ -DQPSK
6	High channel $\pi/4$ -DQPSK
7	Low channel 8DPSK
8	Middle channel 8DPSK
9	High channel 8DPSK
10	BT Link with charging
11	BT Link

Note:

1. All the test modes can be supply by battery, only the result of the worst case was recorded in the report, if no other cases.
2. For Radiated Emission, 3axis were chosen for testing for each applicable mode.
3. The EUT used fully-charged battery when tested.

5. SYSTEM TEST CONFIGURATION

5.1. CONFIGURATION OF EUT SYSTEM

Configure 1: (Normal hopping)

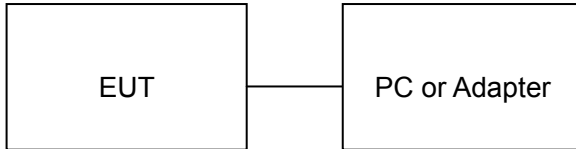

Configure 2: (Control continuous TX)

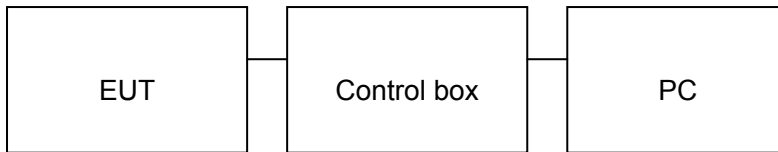

5.2. EQUIPMENT USED IN EUT SYSTEM

Item	Equipment	Mfr/Brand	Model/Type No.	Remark
1	Bluetooth Headset	My Music	E06-C	EUT
2	PC	SONY	E1412AYCW	A.E
3	Control box	JL	N/A	A.E
4	Adapter	N/A	MX12X8-0502000UUU	A.E

5.3. SUMMARY OF TEST RESULTS

FCC RULES	DESCRIPTION OF TEST	RESULT
§15.249	Radiated Emission	Compliant
§15.249	Band Edges	Compliant
§15.207	Conduction Emission	Compliant
§15.215	Bandwidth	Compliant

6. TEST FACILITY

Site	Dongguan Precise Testing Service Co., Ltd.
Location	Building D, Baoding Technology Park, Guangming Road2, Dongcheng District, Dongguan, Guangdong, China,
FCC Registration No.	371540
Description	The test site is constructed and calibrated to meet the FCC requirements in documents ANSI C63.10:2013.

TEST METHODOLOGY

All measurements contained in this report were conducted with ANSI C63.10-2013.

7. ALL TEST EQUIPMENT LIST

FOR RADIATED EMISSION TEST (BELOW 1GHZ)

Radiated Emission Test Site					
Name of Equipment	Manufacturer	Model Number	Serial Number	Last Calibration	Due Calibration
EMI Test Receiver	Rohde & Schwarz	ESCI	101417	July 4, 2015	July 3, 2016
Trilog Broadband Antenna (25M-1GHz)	SCHWARZBECK	VULB9160	9160-3355	July 4, 2015	July 3, 2016
Signal Amplifier	SCHWARZBECK	BBV 9475	9745-0013	July 4, 2015	July 3, 2016
RF Cable	SCHWARZBECK	AK9515E	96221	July 4, 2015	July 3, 2016
3m Anechoic Chamber	CHENGYU	966	PTS-001	June 6, 2016	June 5, 2017
MULTI-DEVICE Positioning Controller	Max-Full	MF-7802	MF780208339	N/A	N/A
Active loop antenna (9K-30MHz)	Schwarzbeck	FMZB1519	1519-038	June 6, 2016	June 5, 2017
Spectrum analyzer	Agilent	E4407B	MY46185649	June 6, 2016	June 5, 2017
Radiation Cable 1	MXT	RS1	R005	June 6, 2016	June 5, 2017
Radiation Cable 2	MXT	RS1	R006	June 6, 2016	June 5, 2017

FOR RADIATED EMISSION TEST (1GHZ ABOVE)

Radiated Emission Test Site					
Name of Equipment	Manufacturer	Model Number	Serial Number	Last Calibration	Due Calibration
EMI Test Receiver	Rohde & Schwarz	ESCI	101417	July 4, 2015	July 3, 2016
Horn Antenna (1G-18GHz)	SCHWARZBECK	BBHA9120D	9120D-1246	July 11, 2015	July 10, 2016
Spectrum Analyzer	Agilent	E4411B	MY4511453	July 4, 2015	July 3, 2016
Signal Amplifier	SCHWARZBECK	BBV 9718	9718-269	July 7, 2015	July 6, 2016
RF Cable	SCHWARZBECK	AK9515H	96220	July 8, 2015	July 7, 2016
3m Anechoic Chamber	CHENGYU	966	PTS-001	June 6, 2016	June 5, 2017
MULTI-DEVICE Positioning Controller	Max-Full	MF-7802	MF780208339	N/A	N/A
Horn Ant (18G-40GHz)	Schwarzbeck	BBHA 9170	9170-181	June 6, 2016	June 5, 2017
Radiation Cable 1	MXT	RS1	R005	June 6, 2016	June 5, 2017
Radiation Cable 2	MXT	RS1	R006	June 6, 2016	June 5, 2017

Conducted Emission Test Site					
Name of Equipment	Manufacturer	Model Number	Serial Number	Last Calibration	Due Calibration
EMI Test Receiver	Rohde & Schwarz	ESCI	101417	July 4, 2015	July 3, 2016
Artificial Mains Network	Narda	L2-16B	000WX31025	July 8, 2015	July 7, 2016
Artificial Mains Network (AUX)	Narda	L2-16B	000WX31026	July 8, 2015	July 7, 2016
RF Cable	SCHWARZBECK	AK9515E	96222	July 4, 2015	July 3, 2016
Shielded Room	CHENGYU	843	PTS-002	June 6, 2016	June 5, 2017
Conduction Cable	MXT	SE1	S003	June 6, 2016	June 5, 2017

8. RADIATED EMISSION

8.1 TEST LIMIT

Standard FCC15.249

Fundamental Frequency	Field Strength of Fundamental (millivolts/meter)	Field Strength of Harmonics (microvolts/meter)
900-928MHz	50	500
2400-2483.5MHz	50	500
5725-5875MHz	50	500
24.0-24.25GHz	250	2500

Standard FCC 15.209

Frequency (MHz)	Distance Meters	Field Strengths Limit	
		μ V/m	dB(μ V)/m
0.009 ~ 0.490	300	2400/F(kHz)	---
0.490 ~ 1.705	30	24000/F(kHz)	---
1.705 ~ 30	30	30	---
30 ~ 88	3	100	40.0
88 ~ 216	3	150	43.5
216 ~ 960	3	200	46.0
960 ~ 1000	3	500	54.0
Above 1000	3	Other:74.0 dB(μ V)/m (Peak) 54.0 dB(μ V)/m (Average)	

Remark: (1) Emission level dB μ V = 20 log Emission level μ V/m
(2) The smaller limit shall apply at the cross point between two frequency bands.
(3) Distance is the distance in meters between the measuring instrument, antenna and the closest point of any part of the device or system.

8.2. MEASUREMENT PROCEDURE

1. The measuring distance of 3m shall be used for measurements. The EUT was placed on the top of a rotating table 0.8 meter above the ground at a 3 meter semi-anechoic chamber. The table was rotated 360 degrees to determine the position of the highest radiation(below 1GHz)
2. The measuring distance of 3m shall used for measurements. The EUT was placed on the top of a rotating table 1.5 meter above the ground at a 3 meter semi-anechoic chamber. The table was rotated 360 degrees to determine the position of the highest radiation(above 1GHz)
3. The height of the test antenna shall vary between 1m to 4m.Both horizontal and vertical polarization Of the antenna are set to make the measurement.
4. The initial step in collecting radiated emission data is a receive peak detector mode. Pre-scanning the measurement frequency range. Significant peaks are then marked and then Quasi Peak detector mode re-measured.
5. All readings are peak unless otherwise stated QP in column of Note. Peak denoted that the Peak reading compliance with the QP limits and then QP Mode measurement didn't perform(Below 1GHz)
6. All readings are Peak mode value unless otherwise stated AVG in column of Note. If the Peak mode measured value compliance with the Peak limits and lower than AVG Limits, the EUT shall be deemed to meet Peak&AVG limits and then only Peak mode was measured, but AVG mode didn't perform.(above 1GHz)

The following table is the setting of spectrum analyzer and receiver.

Spectrum Parameter	Setting
Start ~Stop Frequency	9KHz~150KHz/RB 200Hz for QP
Start ~Stop Frequency	150KHz~30MHz/RB 9KHz for QP
Start ~Stop Frequency	30MHz~1000MHz/RB 120KHz for QP
Start ~Stop Frequency	1GHz~26.5GHz 1MHz/3MHz for Peak, 1MHz/10Hz for Average
Receiver Parameter	Setting
Start ~Stop Frequency	9KHz~150KHz/RB 200Hz for QP
Start ~Stop Frequency	150KHz~30MHz/RB 9KHz for QP
Start ~Stop Frequency	30MHz~1000MHz/RB 120KHz for QP

8.3. TEST SETUP

Radiated Emission Test-Setup Frequency Below 30MHz

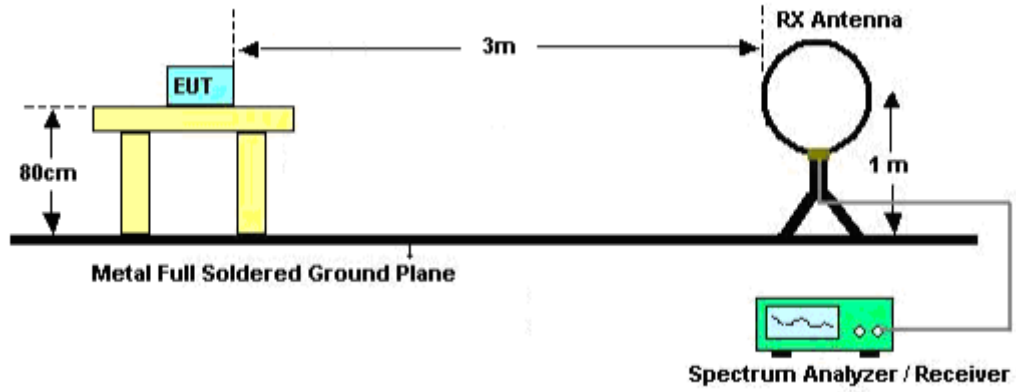

RADIATED EMISSION TEST SETUP 30MHz-1000MHz

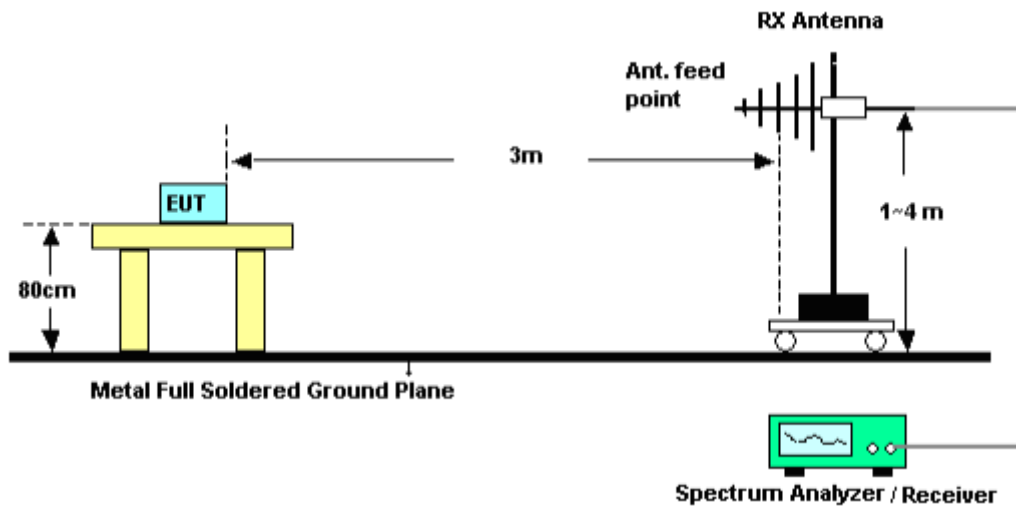

RADIATED EMISSION TEST SETUP ABOVE 1000MHz

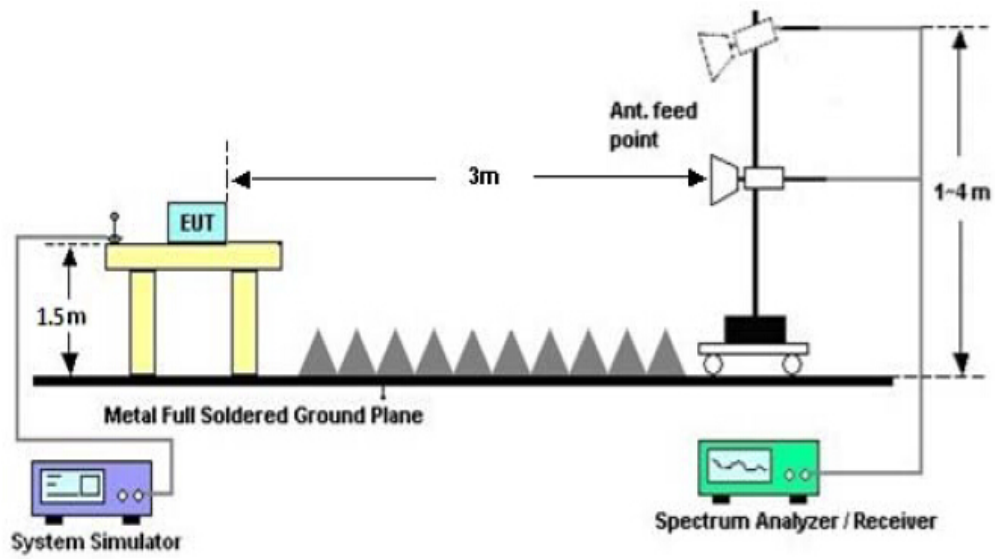

8.4. TEST RESULT

(Worst modulation:GFSK)

RADIATED EMISSION BELOW 30MHZ

No emission found between lowest internal used/generated frequencies to 30MHz.

RADIATED EMISSION BELOW 1GHZ

RADIATED EMISSION TEST- (30MHZ-1GHZ)-LOW CHANNEL-HORIZONTAL

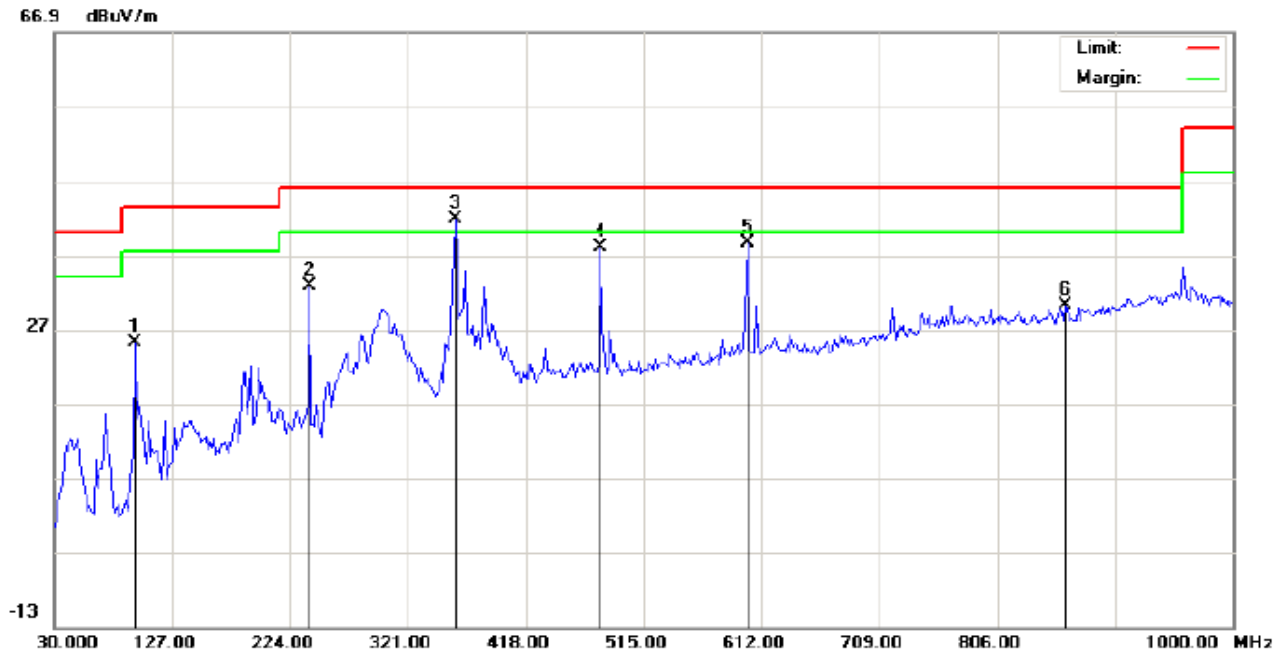

Site: site #1	Polarization: <i>Horizontal</i>	Temperature: 22.6
Limit: FCC Class B 3M Radiation	Power:	Humidity: 54.6 %
EUT: Bluetooth Headset	Distance:	
M/N: E06-C		
Mode: Low Channel TX		
Note:		

No.	Mk	Freq.	Reading	Factor	Measurement	Limit	Over	Detector	Antenna Height	Table Degree	Comment
		MHz	dBuV	dB/m	dBuV/m	dBuV/m	dB		cm	degree	
1		96.2833	18.48	6.77	25.25	43.50	-18.25	peak			
2		240.1667	24.91	7.90	32.81	46.00	-13.19	peak			
3	*	359.8000	22.99	18.80	41.79	46.00	-4.21	peak			
4		479.4333	17.13	20.91	38.04	46.00	-7.96	peak			
5		600.6833	14.88	23.73	38.61	46.00	-7.39	peak			
6		862.5833	2.53	27.64	30.17	46.00	-15.83	peak			

RESULT: PASS

RADIATED EMISSION TEST- (30MHZ-1GHZ)-LOW CHANNEL -VERTICAL

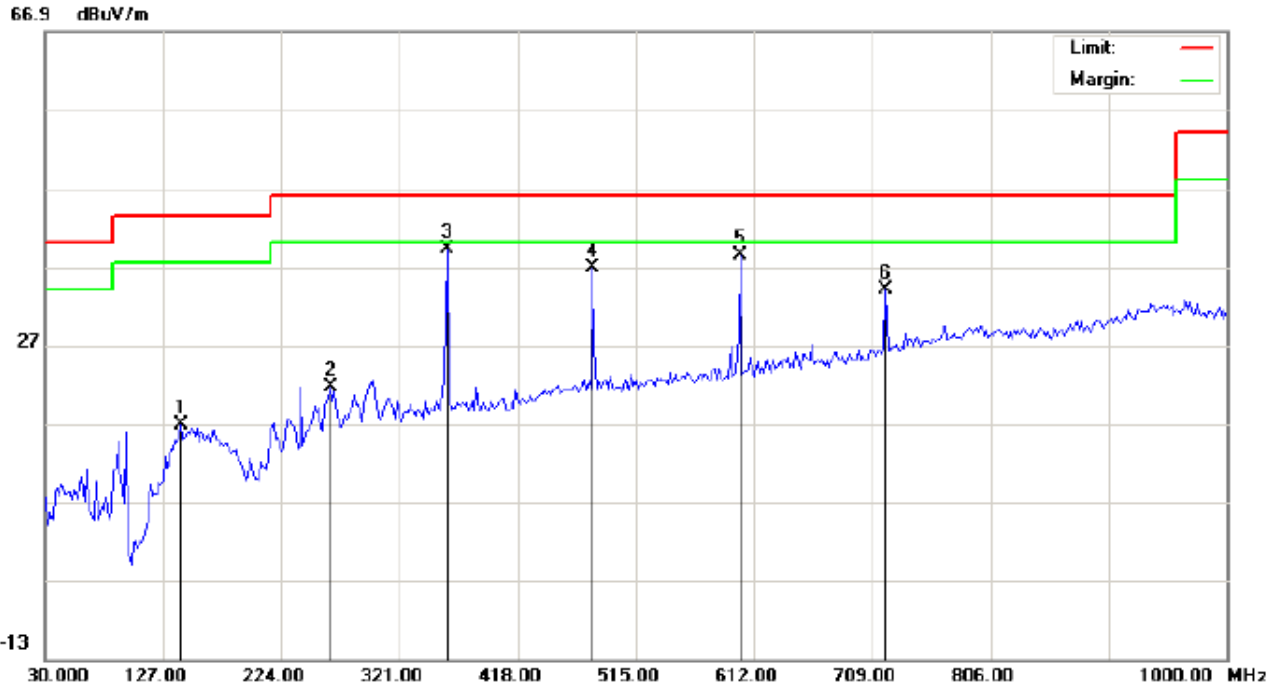

Site: site #1
Limit: FCC Class B 3M Radiation
EUT: Bluetooth Headset
M/N: E06-C
Mode: Low Channel TX
Note:

Polarization: **Vertical**
Power:
Distance:

Temperature: 22.6
Humidity: 54.6 %

No.	Mk	Freq.	Reading	Factor	Measurement	Limit	Over	Detector	Antenna Height	Table Degree	Comment
		MHz	dBuV	dB/m	dBuV/m	dBuV/m	dB		cm	degree	
1		141.5500	1.54	15.21	16.75	43.50	-26.75	peak			
2		264.4166	7.27	14.34	21.61	46.00	-24.39	peak			
3	*	359.8000	20.37	18.80	39.17	46.00	-6.83	peak			
4		479.4333	15.84	20.91	36.75	46.00	-9.25	peak			
5		600.6833	15.67	22.75	38.42	46.00	-7.58	peak			
6		720.3167	8.24	25.78	34.02	46.00	-11.98	peak			

RESULT: PASS

Note: 1. Factor=Antenna Factor + Cable loss, Margin=Measurement-Limit.

2. The "Factor" value can be calculated automatically by software of measurement system.

RADIATED EMISSION TEST- (30MHZ-1GHZ)-MIDDLE CHANNEL-HORIZONTAL

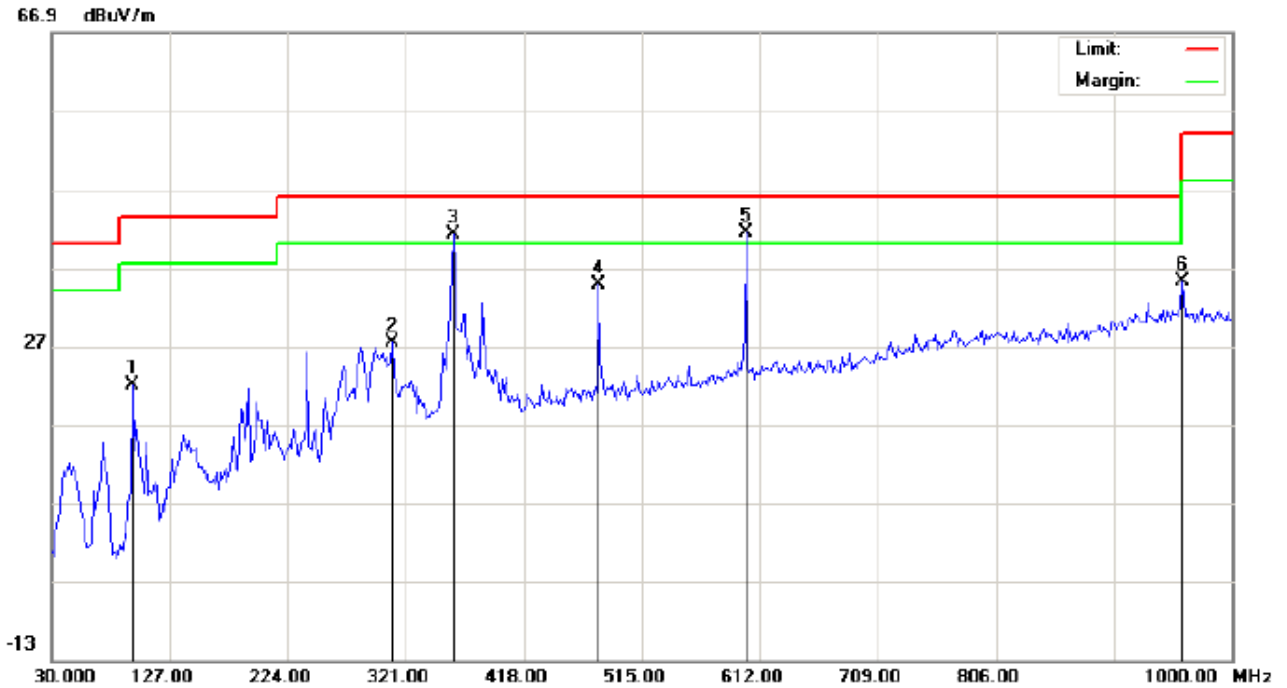

Site: site #1
Limit: FCC Class B 3M Radiation
EUT: Bluetooth Headset
M/N: E06-C
Mode: Middle Channel TX
Note:

Polarization: *Horizontal*
Power:
Distance:

Temperature: 22.6
Humidity: 54.6 %

No.	Mk	Freq.	Reading	Factor	Measurement	Limit	Over	Detector	Antenna Height	Table Degree	Comment
		MHz	dBuV	dB/m	dBuV/m	dBuV/m	dB		cm	degree	
1		96.2833	15.18	6.77	21.95	43.50	-21.55	peak			
2		309.6833	11.41	16.05	27.46	46.00	-18.54	peak			
3	!	359.8000	22.43	18.80	41.23	46.00	-4.77	peak			
4		479.4333	13.86	20.91	34.77	46.00	-11.23	peak			
5	*	600.6833	17.60	23.73	41.33	46.00	-4.67	peak			
6		959.5833	5.35	29.91	35.26	46.00	-10.74	peak			

RESULT: PASS

RADIATED EMISSION TEST- (30MHZ-1GHZ)- MIDDLE CHANNEL -VERTICAL

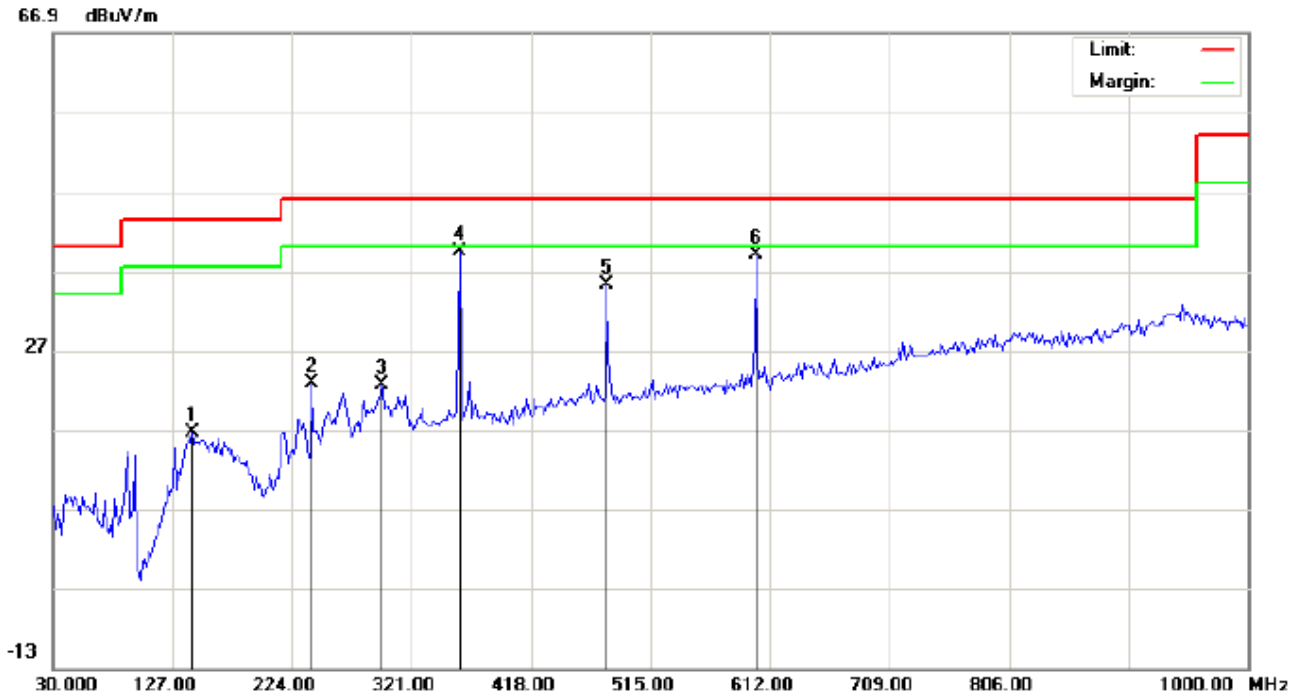

Site: site #1
Limit: FCC Class B 3M Radiation
EUT: Bluetooth Headset
M/N: E06-C
Mode: Middle Channel TX
Note:

Polarization: *Vertical*
Power:
Distance:

Temperature: 22.6
Humidity: 54.6 %

No.	Mk	Freq.	Reading	Factor	Measurement	Limit	Over	Detector	Antenna Height	Table Degree	Comment
		MHz	dBuV	dB/m	dBuV/m	dBuV/m	dB		cm	degree	
1		143.1667	1.44	15.22	16.66	43.50	-26.84	peak			
2		240.1667	9.79	12.94	22.73	46.00	-23.27	peak			
3		296.7500	7.39	15.31	22.70	46.00	-23.30	peak			
4	*	359.8000	20.62	18.80	39.42	46.00	-6.58	peak			
5		479.4333	14.21	20.91	35.12	46.00	-10.88	peak			
6		600.6833	16.27	22.75	39.02	46.00	-6.98	peak			

RESULT: PASS

Note: 1. Factor=Antenna Factor + Cable loss, Margin=Measurement-Limit.

2. The "Factor" value can be calculated automatically by software of measurement system.

RADIATED EMISSION TEST- (30MHZ-1GHZ)-HIGH CHANNEL-HORIZONTAL

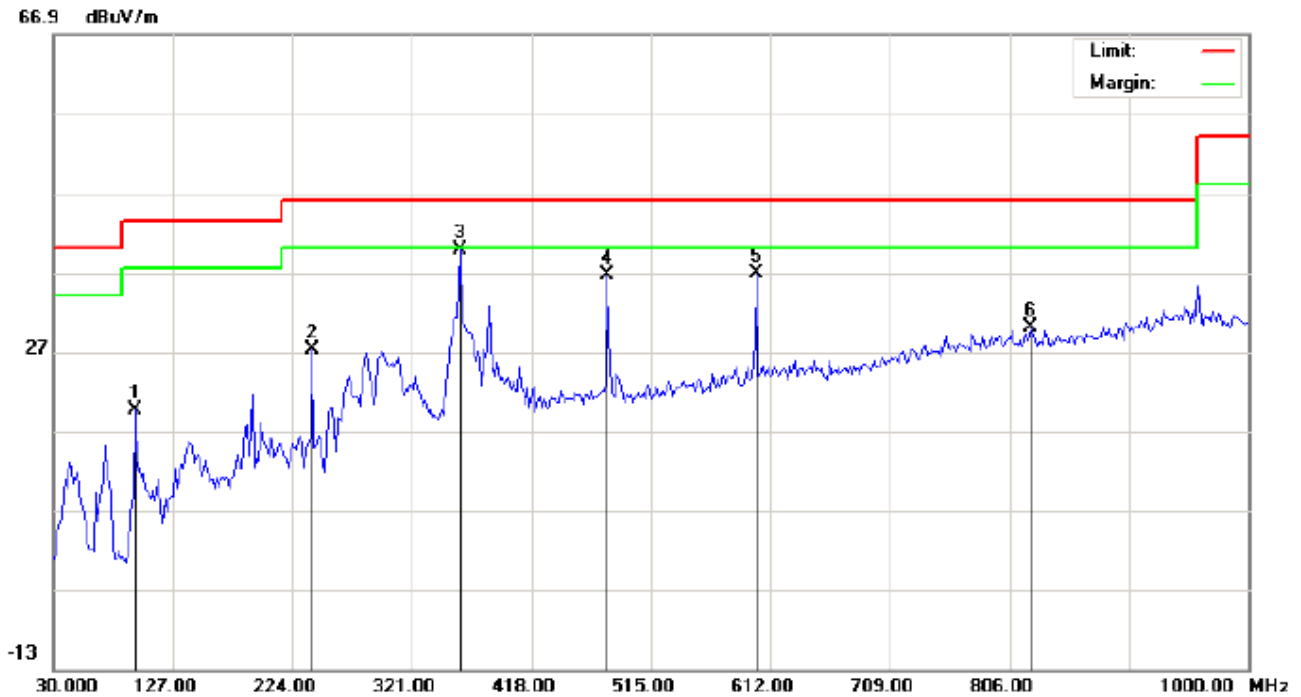

Site: site #1
 Limit: FCC Class B 3M Radiation
 EUT: Bluetooth Headset
 M/N: E06-C
 Mode: High Channel TX
 Note:

Polarization: *Horizontal*
 Power:
 Distance:

Temperature: 22.6
 Humidity: 54.6 %

No.	Mk	Freq.	Reading	Factor	Measurement	Limit	Over	Detector	Antenna Height	Table Degree	Comment
		MHz	dBuV	dB/m	dBuV/m	dBuV/m	dB		cm	degree	
1		96.2833	12.90	6.77	19.67	43.50	-23.83	peak			
2		240.1667	19.38	7.90	27.28	46.00	-18.72	peak			
3	*	359.8000	20.95	18.80	39.75	46.00	-6.25	peak			
4		479.4333	15.72	20.91	36.63	46.00	-9.37	peak			
5		600.6833	13.01	23.73	36.74	46.00	-9.26	peak			
6		823.7833	2.78	27.32	30.10	46.00	-15.90	peak			

RESULT: PASS

RADIATED EMISSION TEST- (30MHZ-1GHZ)-HIGH CHANNEL -VERTICAL

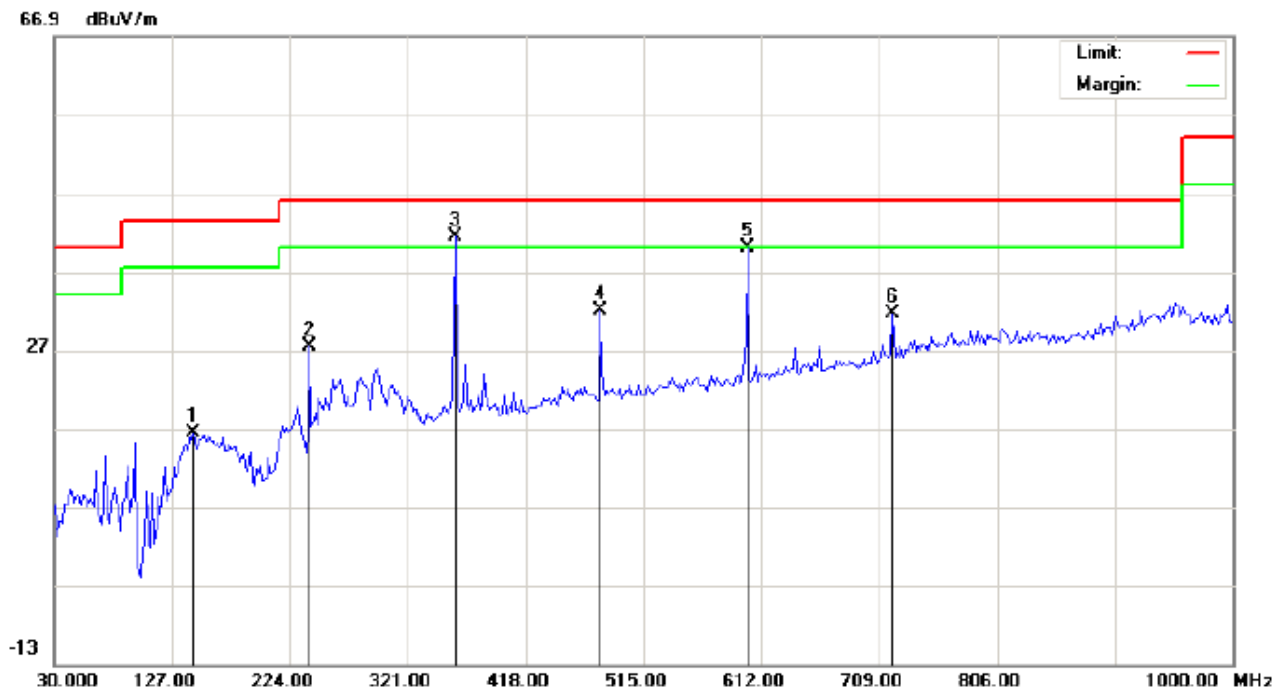

Site: site #1
Limit: FCC Class B 3M Radiation
EUT: Bluetooth Headset
M/N: E06-C
Mode: High Channel TX
Note:

Polarization: *Vertical*
Power:
Distance:

Temperature: 22.6
Humidity: 54.6 %

No.	Mk	Freq.	Reading	Factor	Measurement	Limit	Over	Detector	Antenna Height	Table Degree	Comment
		MHz	dBuV	dB/m	dBuV/m	dBuV/m	dB		cm	degree	
1		144.7833	1.23	15.23	16.46	43.50	-27.04	peak			
2		240.1667	14.51	12.94	27.45	46.00	-18.55	peak			
3	*	359.8000	22.67	18.80	41.47	46.00	-4.53	peak			
4		479.4333	11.12	20.91	32.03	46.00	-13.97	peak			
5		600.6833	17.25	22.75	40.00	46.00	-6.00	peak			
6		720.3167	5.85	25.78	31.63	46.00	-14.37	peak			

RESULT: PASS

Note: 1. Factor=Antenna Factor + Cable loss, Margin=Measurement-Limit.

2. The "Factor" value can be calculated automatically by software of measurement system.

RADIATED EMISSION ABOVE 1GHZ

(Worst modulation: GFSK)

RADIATED EMISSION TEST- (ABOVE 1GHZ)-LOW CHANNEL-HORIZONTAL

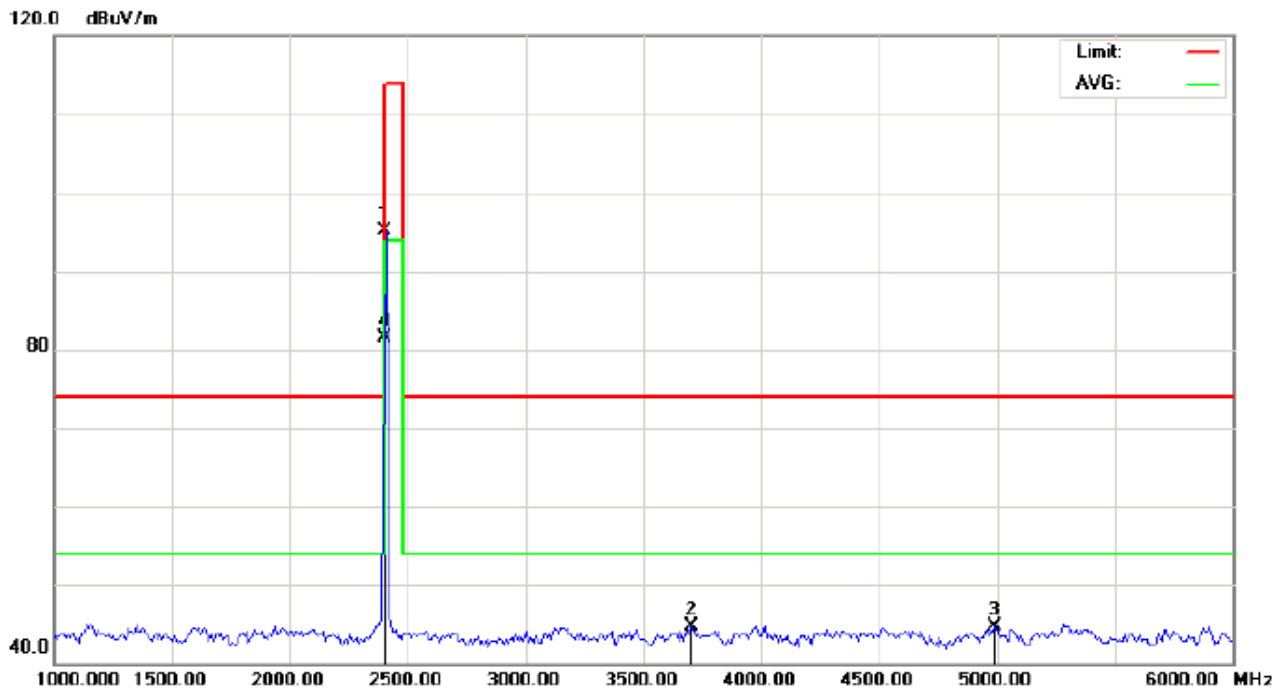

Site: site #1 Polarization: *Horizontal* Temperature: 26
Limit: FCC Class B 3M Radiation above 1GHZ(PK)- Power: Humidity: 60 %
EUT: Bluetooth Headset Distance: 3m
M/N: E06-C
Mode: Low Channel TX
Note:

No.	Mk	Freq.	Reading	Factor	Measurement	Limit	Over	Detector	Antenna Height	Table Degree	Comment
		MHz	dBuV	dB/m	dBuV/m	dBuV/m	dB		cm	degree	
1		2402.000	104.77	-9.68	95.09	114.00	-18.91	peak			
2		3700.000	51.44	-6.66	44.78	74.00	-29.22	peak			
3		4991.667	46.61	-1.82	44.79	74.00	-29.21	peak			
4	*	2402.000	91.12	-9.68	81.44	94.00	-12.56	AVG	100	181	

RESULT: PASS

RADIATED EMISSION TEST- (ABOVE 1GHZ)-LOW CHANNEL- VERTICAL

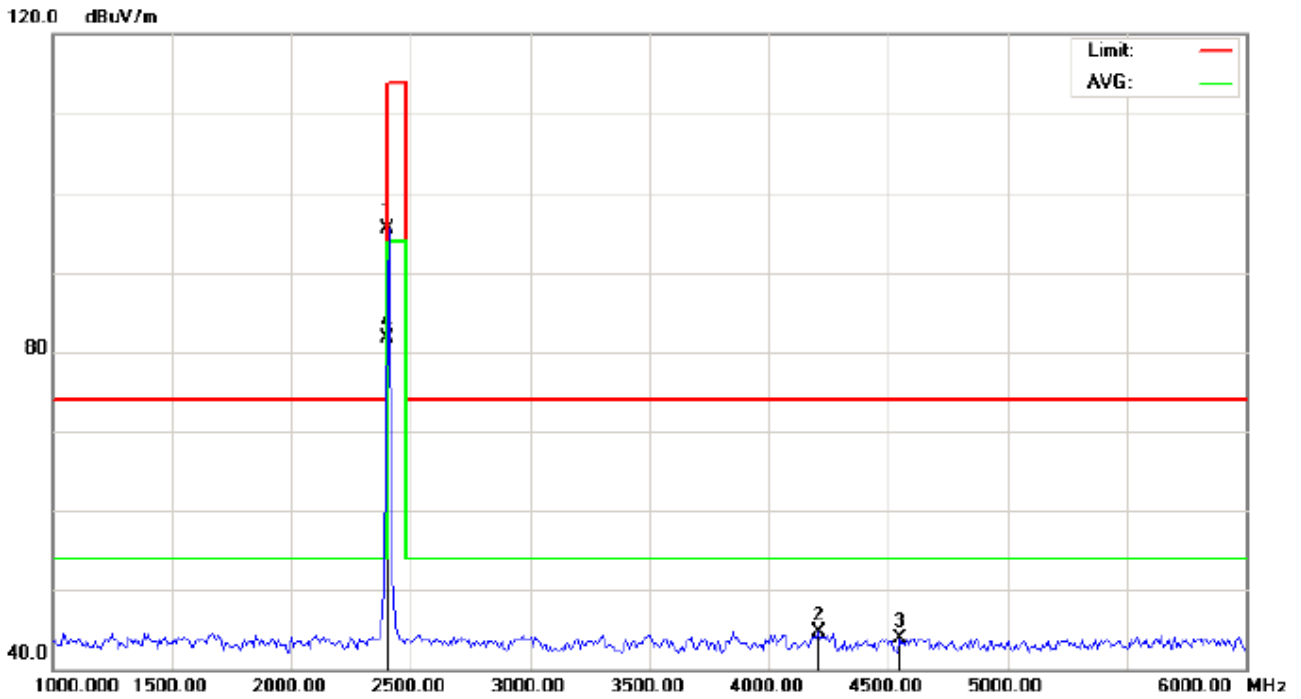

Site: site #1
 Limit: FCC Class B 3M Radiation above 1GHZ(PK)-
 EUT: Bluetooth Headset
 M/N: E06-C
 Mode: Low Channel TX
 Note:

Polarization: *Vertical*
 Power:
 Distance: 3m

Temperature: 26
 Humidity: 60 %

No.	Mk	Freq.	Reading	Factor	Measurement	Limit	Over	Detector	Antenna Height	Table Degree	Comment
		MHz	dBuV	dB/m	dBuV/m	dBuV/m	dB		cm	degree	
1		2402.000	105.21	-9.68	95.53	114.00	-18.47	peak			
2		4208.333	48.85	-4.10	44.75	74.00	-29.25	peak			
3		4550.000	46.94	-2.98	43.96	74.00	-30.04	peak			
4	*	2402.000	91.47	-9.68	81.79	94.00	-12.21	AVG	100	257	

RESULT: PASS

RADIATED EMISSION TEST- (ABOVE 1GHZ)-MIDDLE CHANNEL-HORIZONTAL

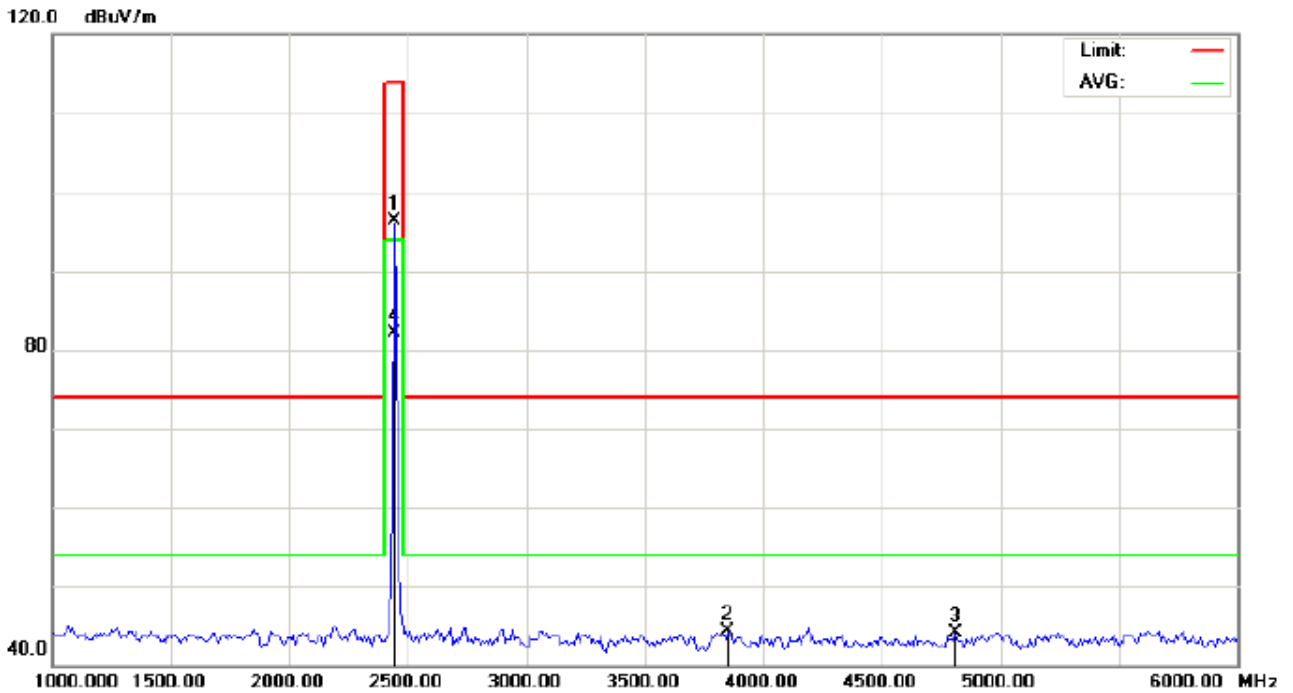

Site: site #1 Polarization: *Horizontal* Temperature: 26
Limit: FCC Class B 3M Radiation above 1GHZ(PK)- Power: Humidity: 60 %
EUT: Bluetooth Headset Distance: 3m
M/N: E06-C
Mode: Middle Channel TX
Note:

No.	Mk	Freq.	Reading	Factor	Measurement	Limit	Over	Detector	Antenna Height	Table Degree	Comment
		MHz	dBuV	dB/m	dBuV/m	dBuV/m	dB		cm	degree	
1		2441.000	105.85	-9.63	96.22	114.00	-17.78	peak			
2		3850.000	49.98	-5.73	44.25	74.00	-29.75	peak			
3		4808.333	46.36	-2.30	44.06	74.00	-29.94	peak			
4	*	2441.000	91.83	-9.63	82.20	94.00	-11.80	AVG	100	179	

RESULT: PASS

RADIATED EMISSION TEST- (ABOVE 1GHZ)-MIDDLE CHANNEL- VERTICAL

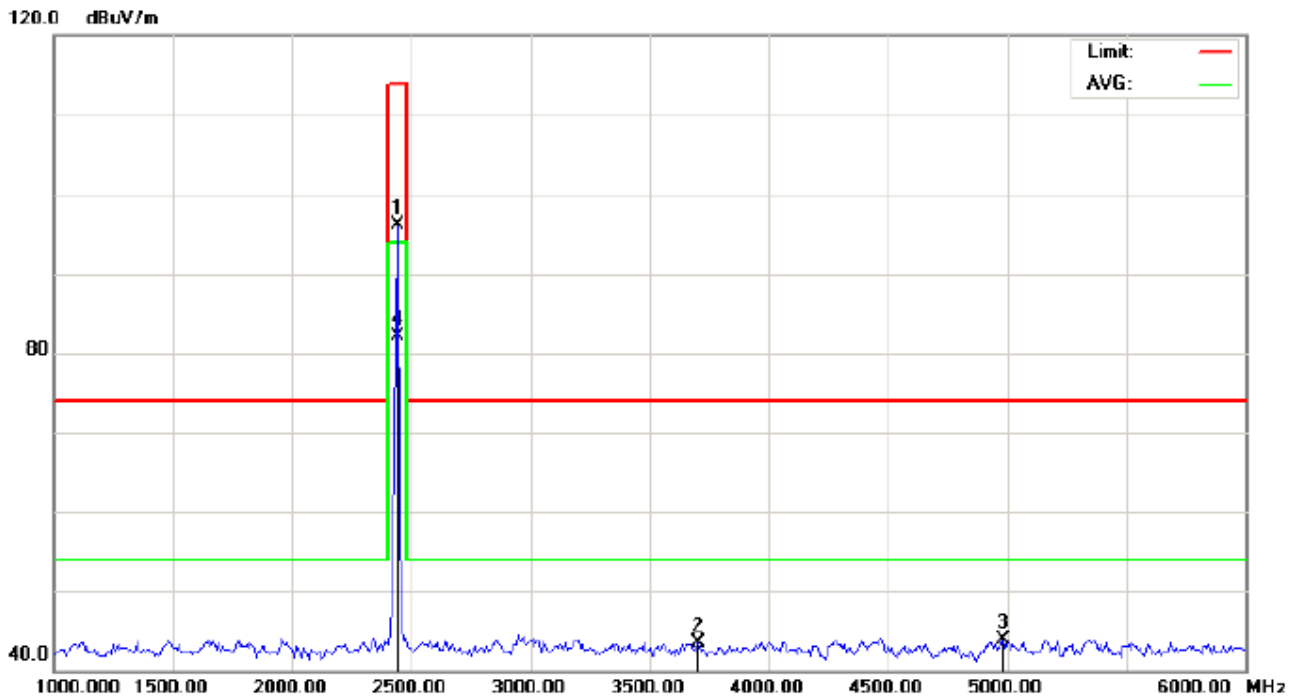

Site: site #1 Polarization: *Vertical* Temperature: 26
Limit: FCC Class B 3M Radiation above 1GHZ(PK)- Power: Humidity: 60 %
EUT: Bluetooth Headset Distance: 3m
M/N: E06-C
Mode: Middle Channel TX
Note:

No.	Mk	Freq.	Reading	Factor	Measurement	Limit	Over	Detector	Antenna Height	Table Degree	Comment
		MHz	dBuV	dB/m	dBuV/m	dBuV/m	dB		cm	degree	
1		2441.000	105.76	-9.63	96.13	114.00	-17.87	peak			
2		3700.000	50.07	-6.66	43.41	74.00	-30.59	peak			
3		4983.333	45.70	-1.84	43.86	74.00	-30.14	peak			
4	*	2441.000	91.77	-9.63	82.14	94.00	-11.86	AVG	100	260	

RESULT: PASS

RADIATED EMISSION TEST- (ABOVE 1GHZ)-HIGH CHANNEL-HORIZONTAL

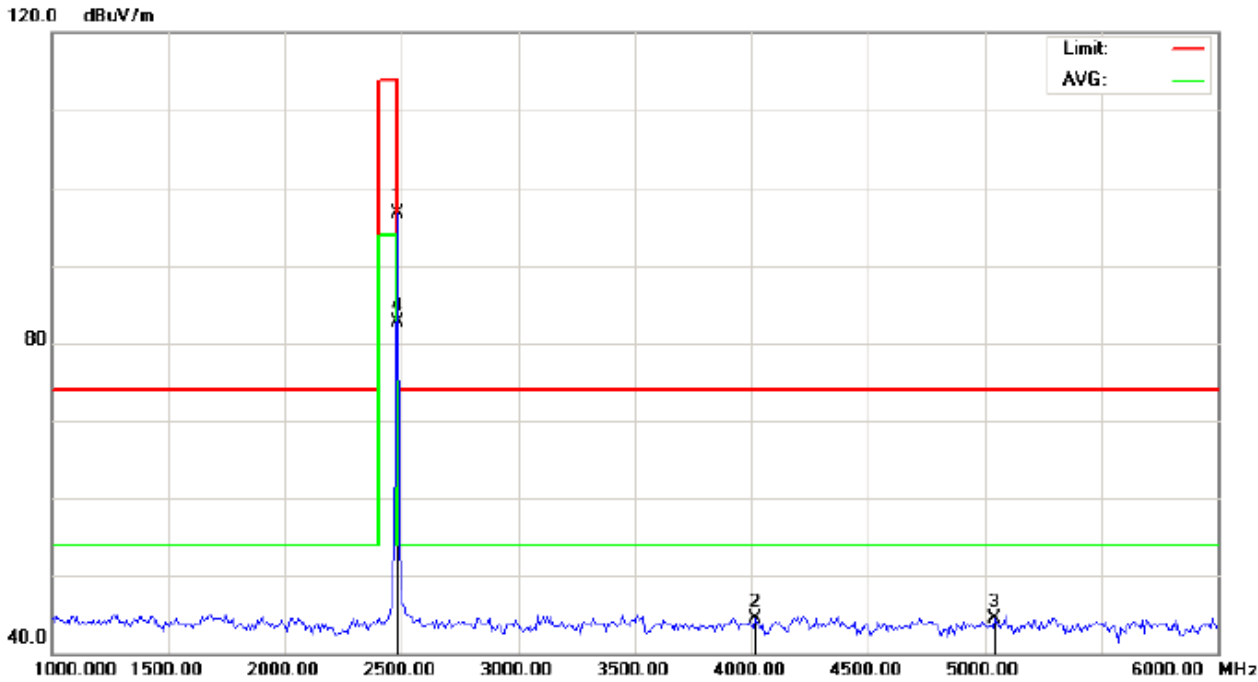

Site: site #1 Polarization: *Horizontal* Temperature: 26
 Limit: FCC Class B 3M Radiation above 1GHZ(PK)- Power: Humidity: 60 %
 EUT: Bluetooth Headset Distance: 3m
 M/N: E06-C
 Mode: High Channel TX
 Note:

No.	Mk	Freq.	Reading	Factor	Measurement	Limit	Over	Detector	Antenna Height	Table Degree	Comment
		MHz	dBuV	dB/m	dBuV/m	dBuV/m	dB		cm	degree	
1		2480.000	106.38	-9.59	96.79	114.00	-17.21	peak			
2		4016.667	49.26	-4.75	44.51	74.00	-29.49	peak			
3		5041.667	46.23	-1.80	44.43	74.00	-29.57	peak			
4	*	2480.000	92.20	-9.59	82.61	94.00	-11.39	AVG	100	183	

RESULT: PASS

RADIATED EMISSION TEST- (ABOVE 1GHZ)-HIGH CHANNEL- VERTICAL

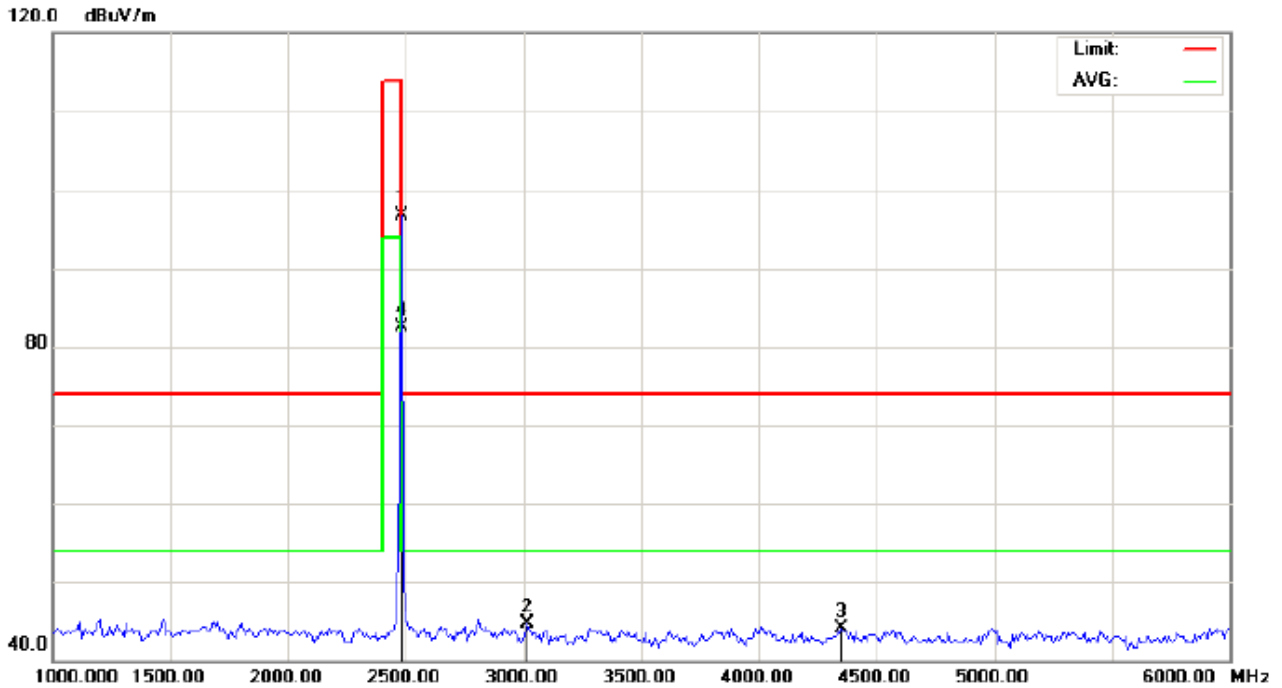

Site: site #1 Polarization: *Vertical* Temperature: 26
Limit: FCC Class B 3M Radiation above 1GHZ(PK)- Power: Humidity: 60 %
EUT: Bluetooth Headset Distance: 3m
M/N: E06-C
Mode: High Channel TX
Note:

No.	Mk	Freq.	Reading	Factor	Measurement	Limit	Over	Detector	Antenna	Table	Comment
		MHz	dBuV	dB/m	dBuV/m	dBuV/m	dB		Height	Degree	
			cm	degree							
1		2480.000	106.34	-9.59	96.75	114.00	-17.25	peak			
2		3016.667	52.95	-8.34	44.61	74.00	-29.39	peak			
3		4350.000	47.65	-3.62	44.03	74.00	-29.97	peak			
4	*	2480.000	92.16	-9.59	82.57	94.00	-11.43	AVG	100	255	

RESULT: PASS

Note: 6~25GHz at least have 20dB margin. No recording in the test report.

Factor=Antenna Factor + Cable loss - Amplifier gain, Margin=Measurement-Limit.

The "Factor" value can be calculated automatically by software of measurement system.

Field strength of the fundamental signal**1Mbps Result:****Peak value**

Frequency	Reading Level	Factor	Measurement	Limit	Over	Antenna
(MHz)	(dBuv)	(dB/m)	(dBuv/m)	(dBuv/m)	(dB)	Polarization
2402	104.77	-9.68	95.09	114.00	-18.91	Horizontal
2402	105.21	-9.68	95.53	114.00	-18.47	Vertical
2441	105.85	-9.63	96.22	114.00	-17.78	Horizontal
2441	105.76	-9.63	96.13	114.00	-17.87	Vertical
2480	106.38	-9.59	96.79	114.00	-17.21	Horizontal
2480	106.34	-9.59	96.75	114.00	-17.25	Vertical

Average value

Frequency	Reading Level	Factor	Measurement	Limit	Over	Antenna
(MHz)	(dBuv)	(dB/m)	(dBuv/m)	(dBuv/m)	(dB)	Polarization
2402	91.12	-9.68	81.44	94.00	-12.56	Horizontal
2402	91.47	-9.68	81.79	94.00	-12.21	Vertical
2441	91.83	-9.63	82.20	94.00	-11.80	Horizontal
2441	91.77	-9.63	82.14	94.00	-11.86	Vertical
2480	92.20	-9.59	82.61	94.00	-11.39	Horizontal
2480	92.16	-9.59	82.57	94.00	-11.43	Vertical

2Mbps Result:

Peak value

Frequency	Reading Level	Factor	Measurement	Limit	Over	Antenna
(MHz)	(dBuv)	(dB/m)	(dBuv/m)	(dBuv/m)	(dB)	Polarization
2402	104.79	-9.68	95.11	114.00	-18.89	Horizontal
2402	104.54	-9.68	94.86	114.00	-19.14	Vertical
2441	105.36	-9.68	95.68	114.00	-18.32	Horizontal
2441	104.81	-9.68	95.13	114.00	-18.87	Vertical
2480	106.06	-9.63	96.43	114.00	-17.57	Horizontal
2480	105.67	-9.63	96.04	114.00	-17.96	Vertical

Average value

Frequency	Reading Level	Factor	Measurement	Limit	Over	Antenna
(MHz)	(dBuv)	(dB/m)	(dBuv/m)	(dBuv/m)	(dB)	Polarization
2402	91.05	-9.63	81.42	94.00	-12.58	Horizontal
2402	90.78	-9.63	81.15	94.00	-12.85	Vertical
2441	91.32	-9.59	81.73	94.00	-12.27	Horizontal
2441	90.85	-9.59	81.26	94.00	-12.74	Vertical
2480	91.76	-9.59	82.17	94.00	-11.83	Horizontal
2480	91.32	-9.59	81.73	94.00	-12.27	Vertical

3Mbps Result:

Peak value

Frequency	Reading Level	Factor	Measurement	Limit	Over	Antenna
(MHz)	(dBuv)	(dB/m)	(dBuv/m)	(dBuv/m)	(dB)	Polarization
2402	104.62	-9.68	94.94	114.00	-19.06	Horizontal
2402	104.43	-9.68	94.75	114.00	-19.25	Vertical
2441	104.96	-9.68	95.28	114.00	-18.72	Horizontal
2441	104.7	-9.68	95.02	114.00	-18.98	Vertical
2480	105.78	-9.63	96.15	114.00	-17.85	Horizontal
2480	105.6	-9.63	95.97	114.00	-18.03	Vertical

Average value

Frequency	Reading Level	Factor	Measurement	Limit	Over	Antenna
(MHz)	(dBuv)	(dB/m)	(dBuv/m)	(dBuv/m)	(dB)	Polarization
2402	90.96	-9.63	81.33	94.00	-12.67	Horizontal
2402	90.69	-9.63	81.06	94.00	-12.94	Vertical
2441	-91.15	-9.59	81.56	94.00	-12.44	Horizontal
2441	-90.88	-9.59	81.29	94.00	-12.71	Vertical
2480	-91.48	-9.59	81.89	94.00	-12.11	Horizontal
2480	-91.33	-9.59	81.74	94.00	-12.26	Vertical

9. BAND EDGE EMISSION

9.1. MEASUREMENT PROCEDURE

- 1The EUT operates at hopping-off test mode. The lowest or highest channels are tested to verify the largest transmission and spurious emissions power at the continuous transmission mode.
- 2Max hold the trace of the setup 1, and the EUT operates at hopping-on test mode to verify the largest spurious emissions power.
- 3Set the spectrum analyzer in the following setting in order to capture the lower and upper band-edges of the emission

9.2 TEST SETUP

RADIATED EMISSION TEST SETUP

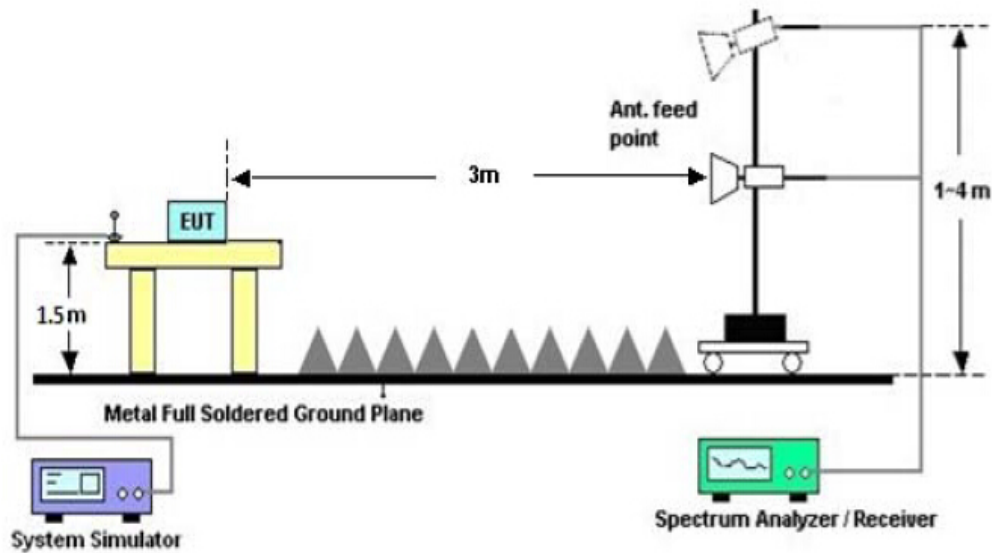

9.3 RADIATED TEST RESULT

(Worst modulation: GFSK)

FOR BR/EDR

TEST PLOT OF BAND EDGE FOR LOW CHANNEL-Horizontal

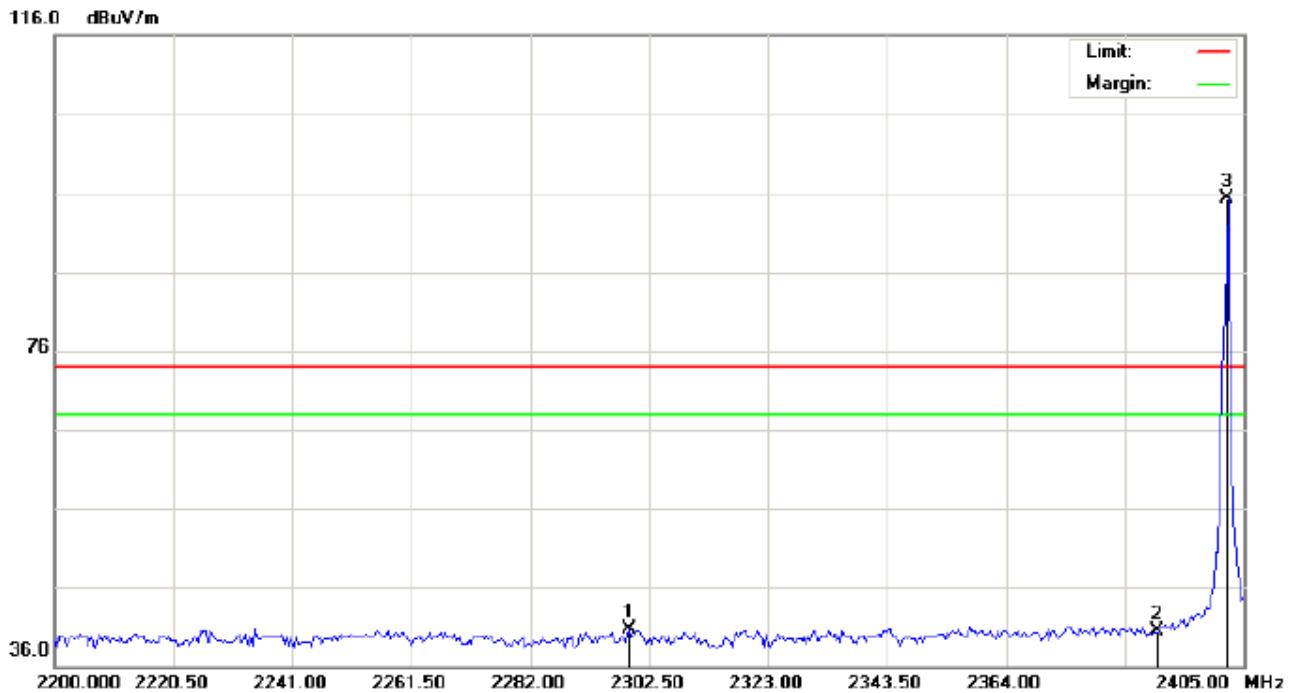

Site: site #1 Polarization: *Horizontal* Temperature: 26
Limit: FCC Class B 3M Radiation above 1GHZ(PK) Power: Humidity: 60 %
EUT: Bluetooth Headset Distance:
M/N: E06-C
Mode: Low Channel TX
Note:

No.	Mk	Freq.	Reading	Factor	Measurement	Limit	Over	Detector	Antenna	Table	Comment
		MHz	dBuV	dB/m	dBuV/m	dBuV/m	dB		Height	Degree	
									cm	degree	
1		2299.083	30.45	10.21	40.66	74.00	-33.34	peak			
2		2390.000	30.12	10.31	40.43	74.00	-33.57	peak			
3	*	2402.000	84.91	10.32	95.23	74.00	21.23	peak			

TEST PLOT OF BAND EDGE FOR LOW CHANNEL -Vertical

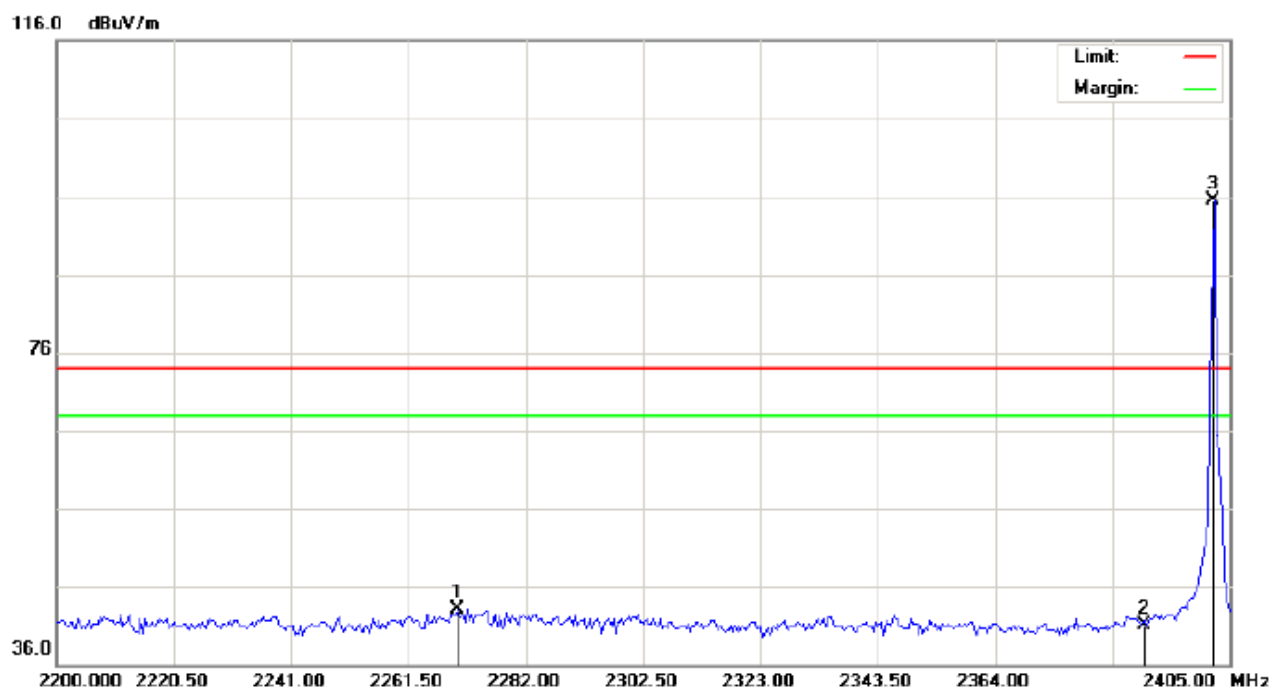

Site: site #1 Polarization: *Vertical* Temperature: 26
 Limit: FCC Class B 3M Radiation above 1GHZ(PK) Power: Humidity: 60 %
 EUT: Bluetooth Headset Distance:
 M/N: E06-C
 Mode: Low Channel TX
 Note:

No.	Mk	Freq.	Reading	Factor	Measurement	Limit	Over	Detector	Antenna Height	Table Degree	Comment
		MHz	dBuV	dB/m	dBuV/m	dBuV/m	dB		cm	degree	
1		2270.042	32.91	10.18	43.09	74.00	-30.91	peak			
2		2390.000	30.85	10.31	41.16	74.00	-32.84	peak			
3	*	2402.000	85.26	10.32	95.58	74.00	21.58	peak			

TEST PLOT OF BAND EDGE FOR HIGH CHANNEL -Horizontal

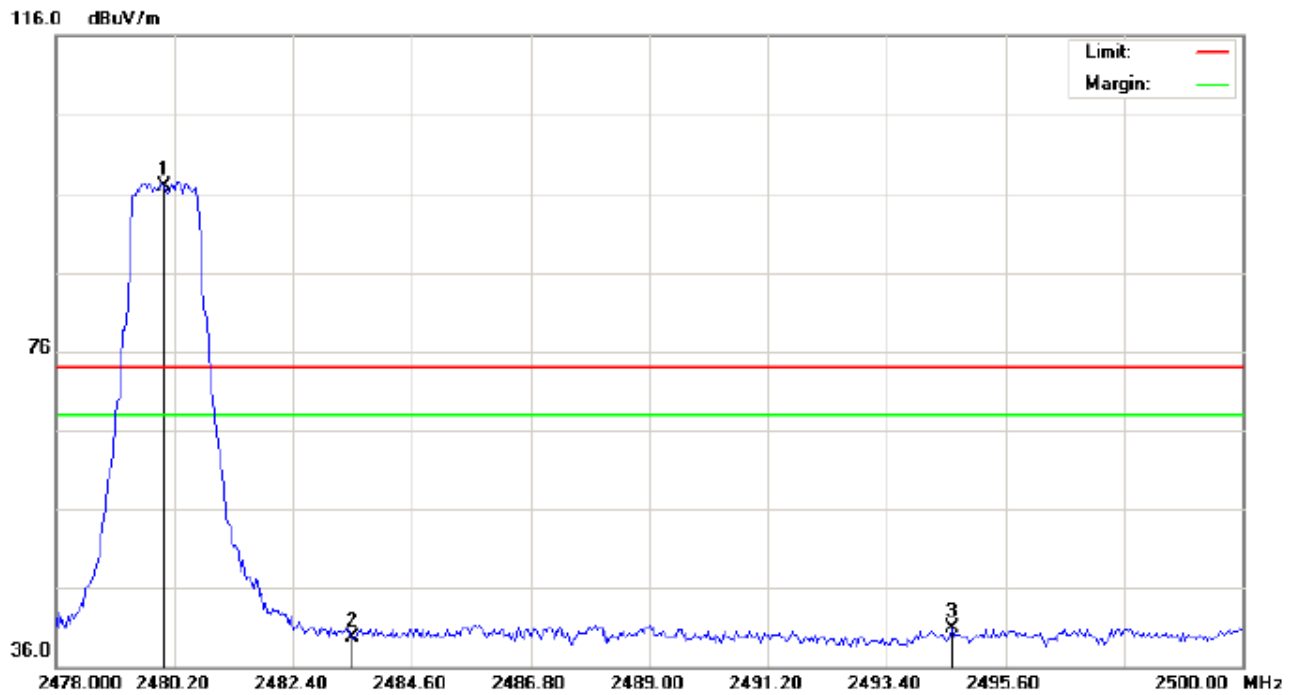

Site: site #1 Polarization: *Horizontal* Temperature: 26
Limit: FCC Class B 3M Radiation above 1GHZ(PK) Power: Humidity: 60 %
EUT: Bluetooth Keyboard Distance:
M/N: HB020
Mode: High Channel TX
Note:

No.	Mk	Freq.	Reading	Factor	Measurement	Limit	Over	Detector	Antenna	Table	Comment
		MHz	dBuV	dB/m	dBuV/m	dBuV/m	dB		Height	Degree	
									cm	degree	
1	*	2480.000	86.46	10.41	96.87	74.00	22.87	peak			
2		2483.500	29.25	10.41	39.66	74.00	-34.34	peak			
3		2494.610	30.57	10.42	40.99	74.00	-33.01	peak			

TEST PLOT OF BAND EDGE FOR HIGH CHANNEL-Vertical

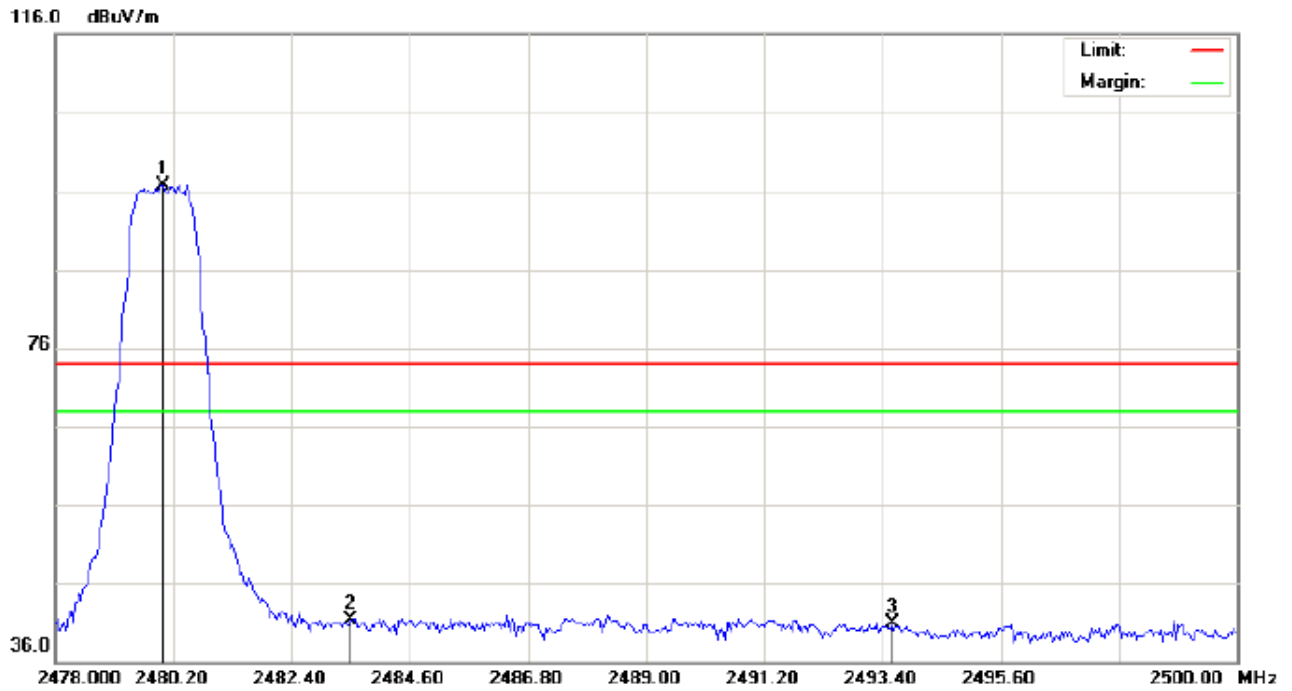

Site: site #1 Polarization: *Vertical* Temperature: 26
Limit: FCC Class B 3M Radiation above 1GHZ(PK) Power: Humidity: 60 %
EUT: Bluetooth Headset Distance:
M/N: E06-C
Mode: High Channel TX
Note:

No.	Mk	Freq.	Reading	Factor	Measurement	Limit	Over	Detector	Antenna	Table	Comment
		MHz	dBuV	dB/m	dBuV/m	dBuV/m	dB		Height	Degree	
									cm	degree	
1	*	2480.000	86.35	10.41	96.76	74.00	22.76	peak			
2		2483.500	30.87	10.41	41.28	74.00	-32.72	peak			
3		2493.583	30.48	10.42	40.90	74.00	-33.10	peak			

RESULT: PASS

Note: The other modes radiation emission have enough 20dB margin.

Factor=Antenna Factor + Cable loss - Amplifier gain, Over=Measure-Limit.

The “Factor” value can be calculated automatically by software of measurement system.

10. BANDWIDTH

10.1. MEASUREMENT PROCEDURE

1. Connect EUT RF output port to the Spectrum Analyzer through an RF attenuator
2. Set the EUT Work on the top, the middle and the bottom operation frequency individually.
3. Set Span = approximately 2 to 3 times the 20 dB bandwidth, centered on a hopping channel
RBW \geq 1% of the 20 dB bandwidth, VBW \geq RBW; Sweep = auto; Detector function = peak
4. Set SPA Trace 1 Max hold, then View.

10.2. TEST SET-UP

(BLOCK DIAGRAM OF CONFIGURATION)

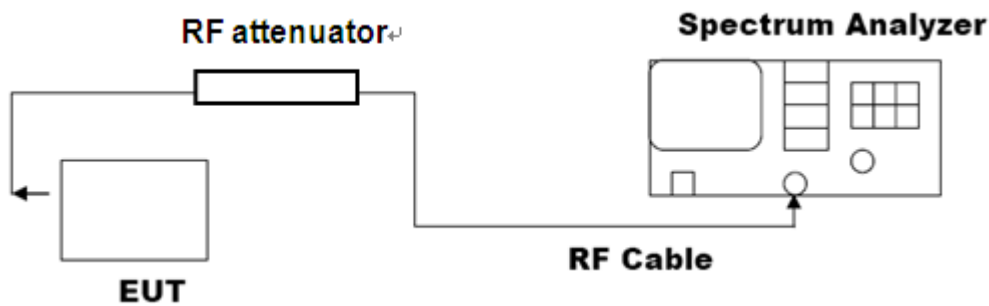

Note: The EUT has been used temporary antenna connector for testing.

10.3. LIMITS AND MEASUREMENT RESULTS

FOR BR/EDR

BLUETOOTH 1MBPS LIMITS AND MEASUREMENT RESULT				
Applicable Limits	Measurement Result			
	Test Data (MHz)			Result
		99%OBW (MHz)	-20dB BW(MHz)	
N/A	Low Channel	0.935	1.098	PASS
	Middle Channel	0.932	1.088	PASS
	High Channel	0.937	1.104	PASS

TEST PLOT OF BANDWIDTH FOR LOW CHANNEL

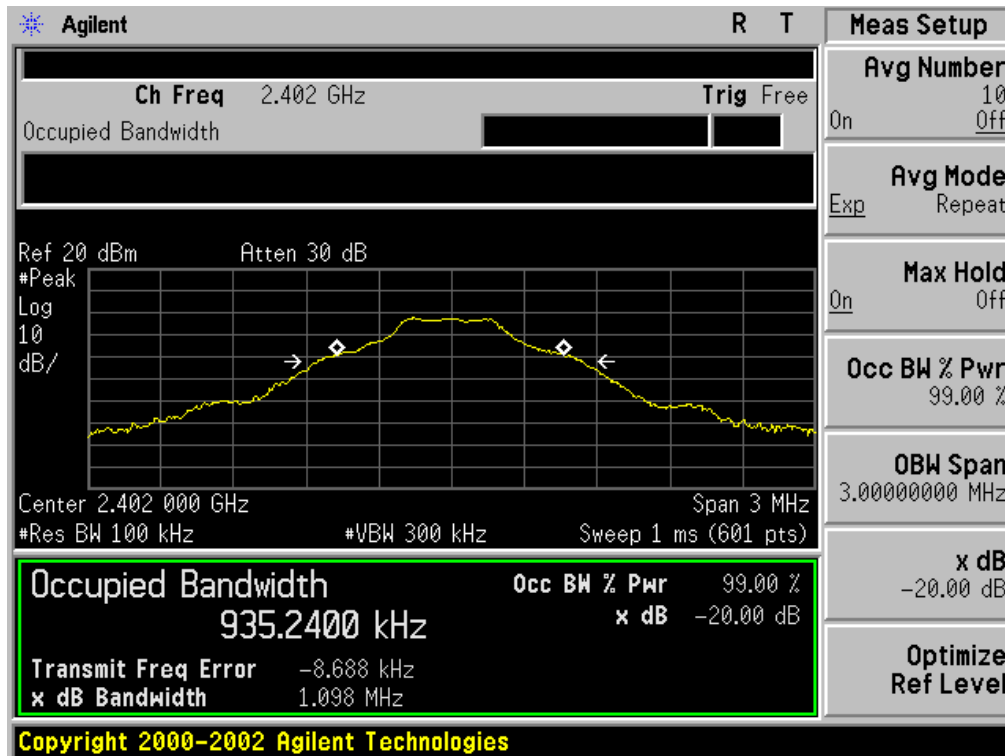

TEST PLOT OF BANDWIDTH FOR MIDDLE CHANNEL

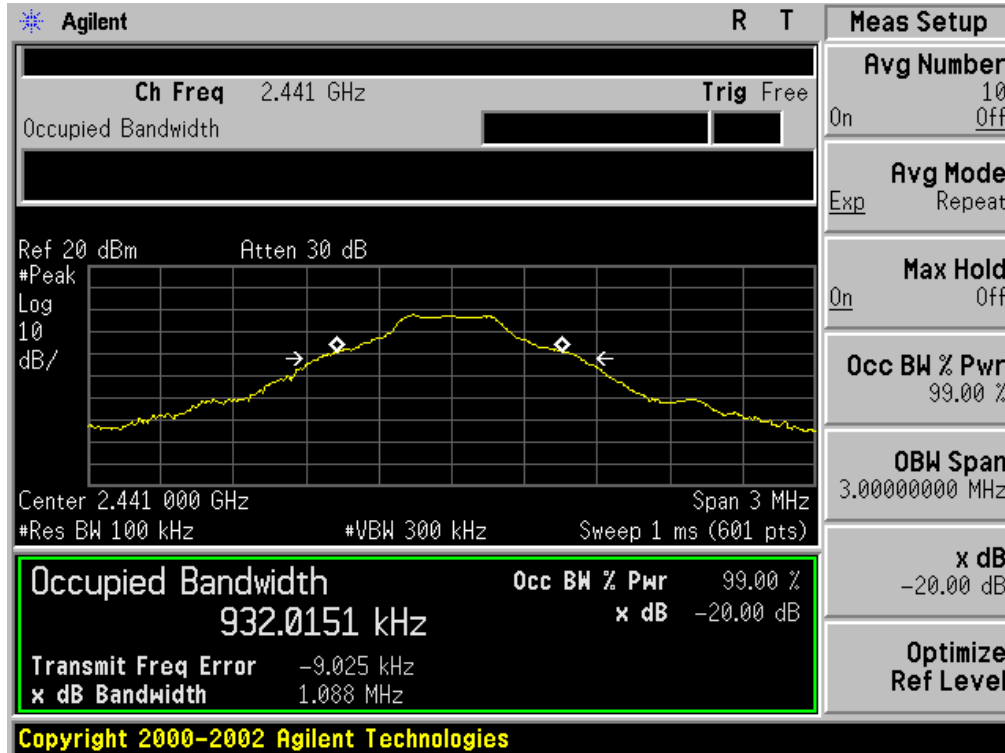

TEST PLOT OF BANDWIDTH FOR HIGH CHANNEL

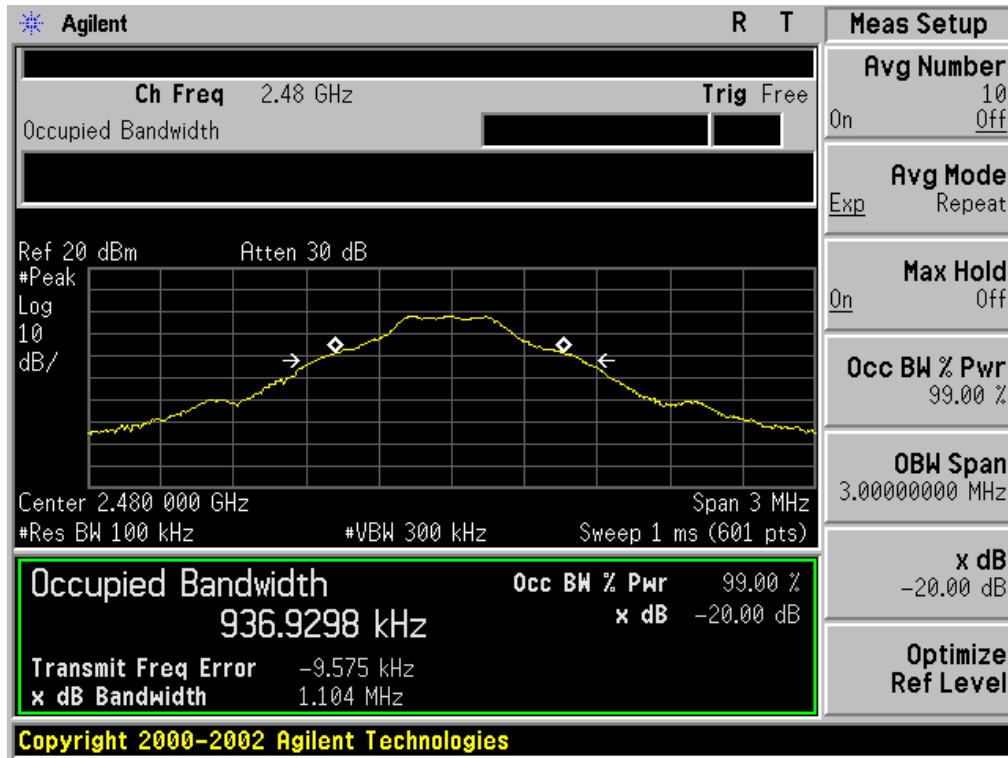

BLUETOOTH 2MBPS LIMITS AND MEASUREMENT RESULT				
Applicable Limits	Measurement Result			
	Test Data (MHz)			Result
		99%OBW (MHz)	-20dB BW(MHz)	
N/A	Low Channel	1.201	1.358	PASS
	Middle Channel	1.200	1.354	PASS
	High Channel	1.196	1.359	PASS

TEST PLOT OF BANDWIDTH FOR LOW CHANNEL

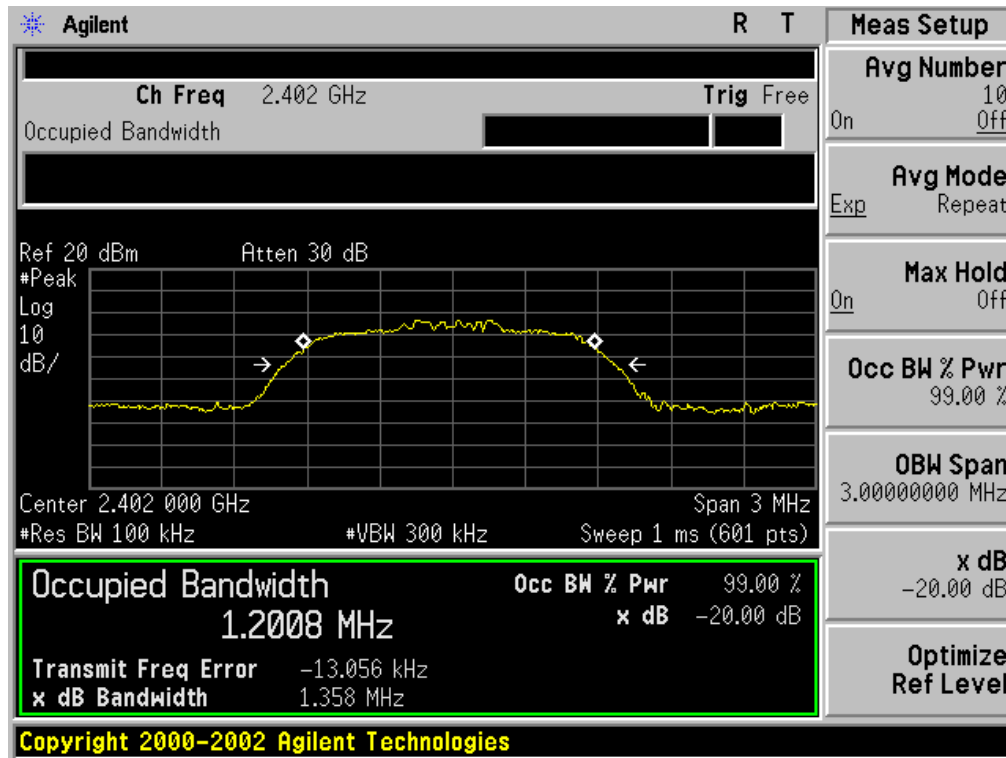

TEST PLOT OF BANDWIDTH FOR MIDDLE CHANNEL

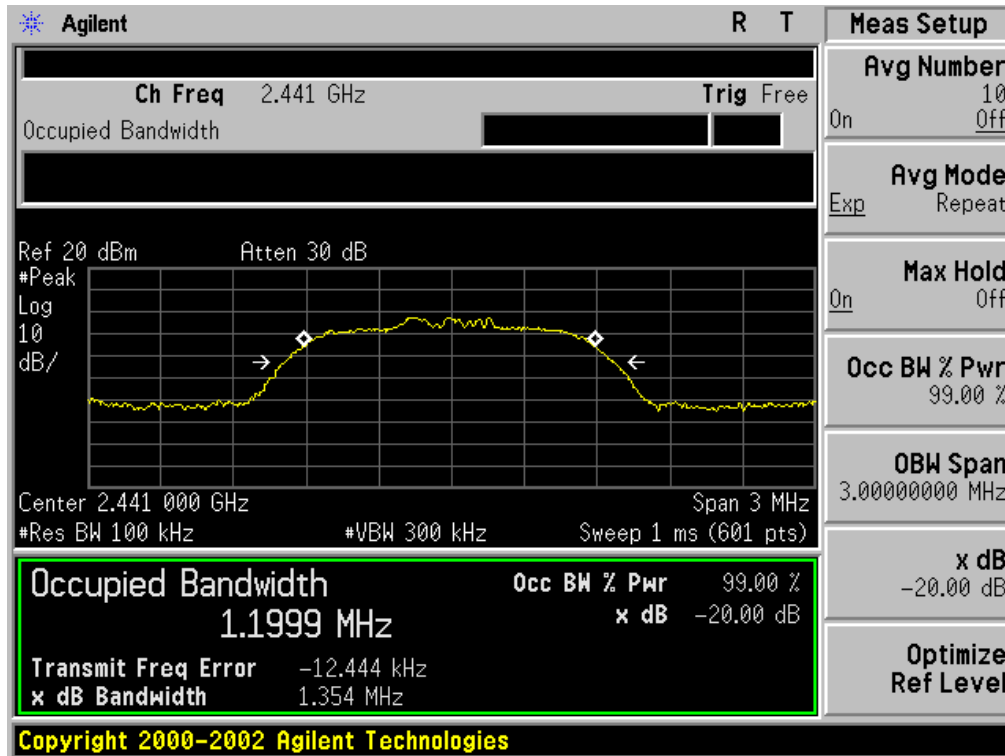

TEST PLOT OF BANDWIDTH FOR HIGH CHANNEL

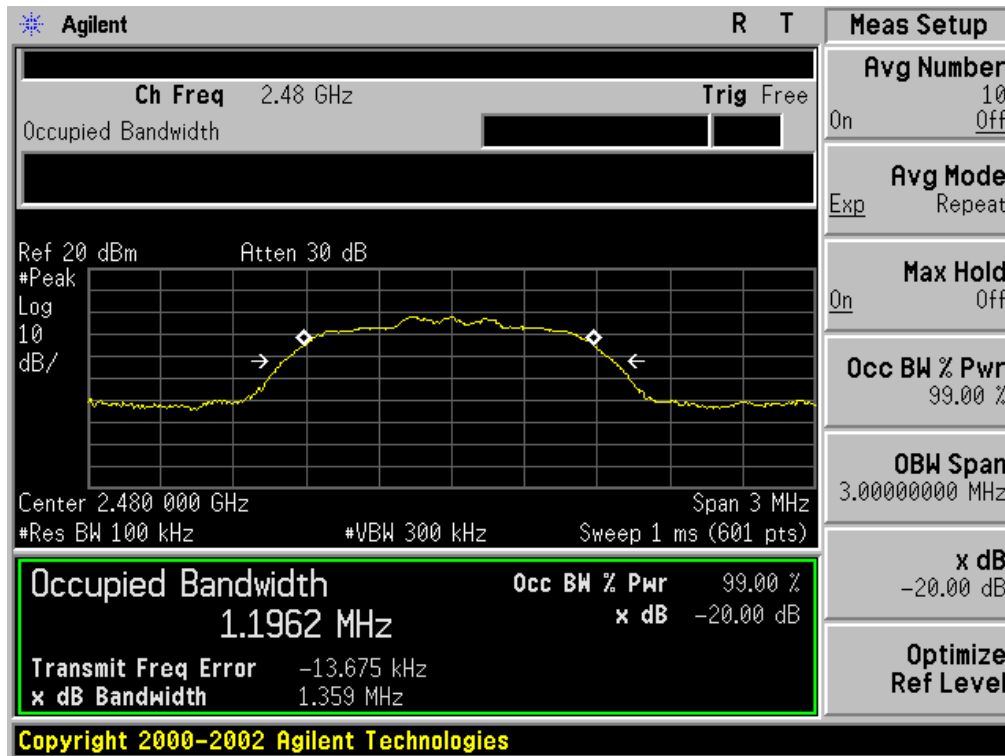

BLUETOOTH 3MBPS LIMITS AND MEASUREMENT RESULT				
Applicable Limits	Measurement Result			
	Test Data (MHz)			Result
		99%OBW (MHz)	-20dB BW(MHz)	
N/A	Low Channel	1.209	1.368	PASS
	Middle Channel	1.218	1.366	PASS
	High Channel	1.214	1.368	PASS

TEST PLOT OF BANDWIDTH FOR LOW CHANNEL

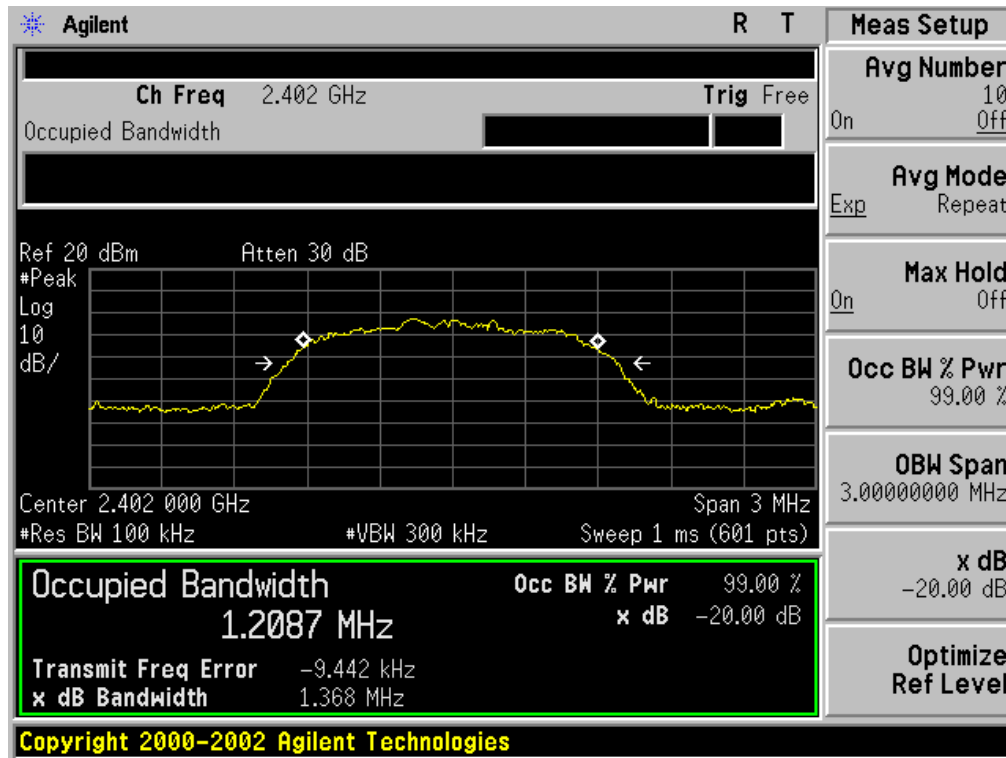

TEST PLOT OF BANDWIDTH FOR MIDDLE CHANNEL

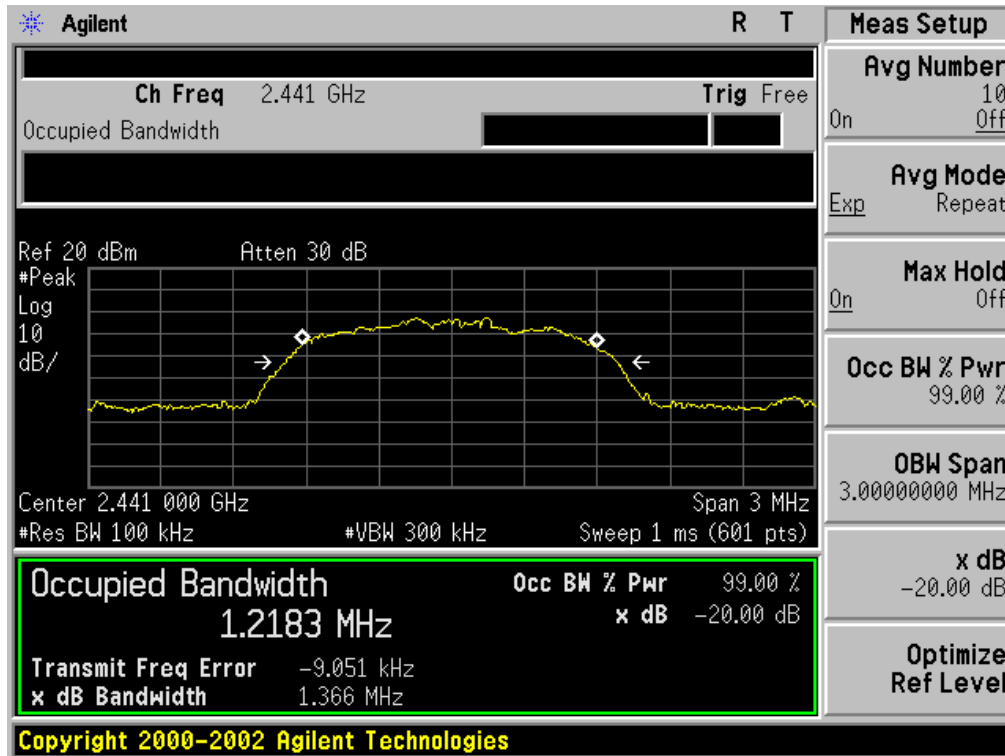

TEST PLOT OF BANDWIDTH FOR HIGH CHANNEL

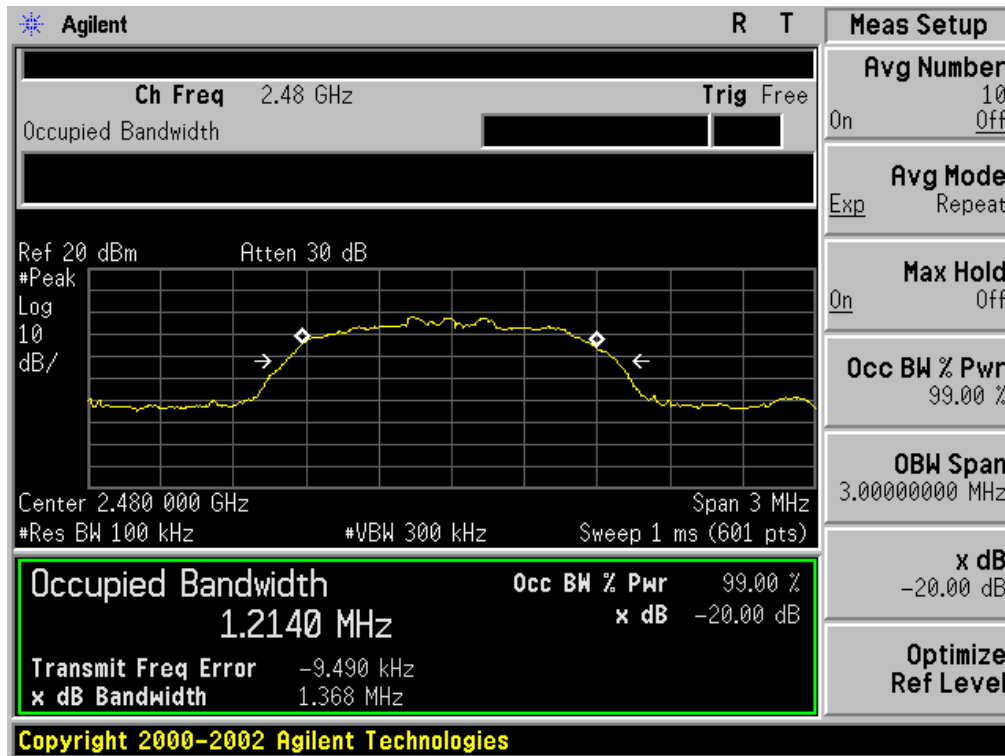

11. FCC LINE CONDUCTED EMISSION TEST

11.1. LIMITS OF LINE CONDUCTED EMISSION TEST

Frequency	Maximum RF Line Voltage	
	Q.P.(dBuV)	Average(dBuV)
150kHz~500kHz	66-56	56-46
500kHz~5MHz	56	46
5MHz~30MHz	60	50

Note:

1. The lower limit shall apply at the transition frequency.
2. The limit decreases linearly with the logarithm of the frequency in the range 0.15 MHz to 0.50 MHz.

11.2. BLOCK DIAGRAM OF LINE CONDUCTED EMISSION TEST

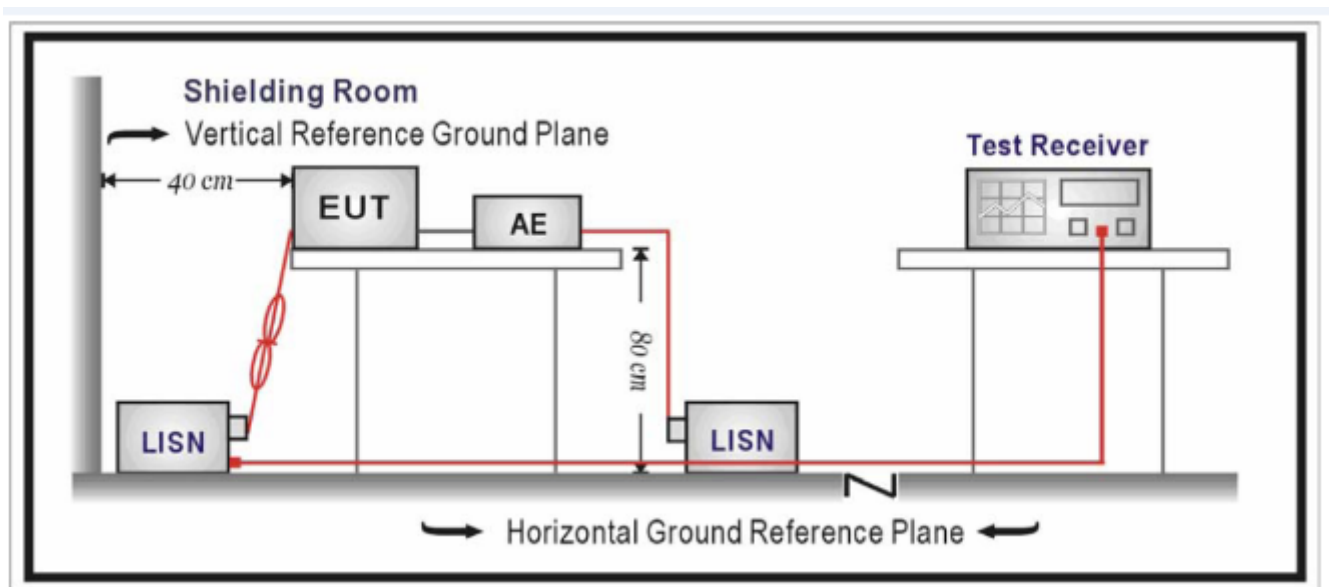

11.3. PRELIMINARY PROCEDURE OF LINE CONDUCTED EMISSION TEST

1. The equipment was set up as per the test configuration to simulate typical actual usage per the user's manual. When the EUT is a tabletop system, a wooden table with a height of 0.8 meters is used and is placed on the ground plane as per ANSI C63.10 (see Test Facility for the dimensions of the ground plane used). When the EUT is a floor-standing equipment, it is placed on the ground plane which has a 3-12 mm non-conductive covering to insulate the EUT from the ground plane.
2. Support equipment, if needed, was placed as per ANSI C63.10.
3. All I/O cables were positioned to simulate typical actual usage as per ANSI C63.10.
4. All support equipments received AC120V/60Hz power from a LISN, if any.
5. The EUT received DC charging voltage by adapter or PC which received 120V/60Hz power by a LISN.
6. The test program was started. Emissions were measured on each current carrying line of the EUT using a spectrum Analyzer / Receiver connected to the LISN powering the EUT. The LISN has two monitoring points: Line 1 (Hot Side) and Line 2 (Neutral Side). Two scans were taken: one with Line 1 connected to Analyzer / Receiver and Line 2 connected to a 50 ohm load; the second scan had Line 1 connected to a 50 ohm load and Line 2 connected to the Analyzer / Receiver.
7. Analyzer / Receiver scanned from 150 kHz to 30MHz for emissions in each of the test modes.
8. During the above scans, the emissions were maximized by cable manipulation.
9. The test mode(s) were scanned during the preliminary test.

Then, the EUT configuration and cable configuration of the above highest emission level were recorded for reference of final testing.

11.4. FINAL PROCEDURE OF LINE CONDUCTED EMISSION TEST

1. EUT and support equipment was set up on the test bench as per step 2 of the preliminary test.
2. A scan was taken on both power lines, Line 1 and Line 2, recording at least the six highest emissions. Emission frequency and amplitude were recorded into a computer in which correction factors were used to calculate the emission level and compare reading to the applicable limit. If EUT emission level was less -2dB to the A.V. limit in Peak mode, then the emission signal was re-checked using Q.P and Average detector.
3. The test data of the worst case condition(s) was reported on the Summary Data page.

11.5. TEST RESULT OF LINE CONDUCTED EMISSION TEST

By adapter(worst case)

Line Conducted Emission Test Line 1-L

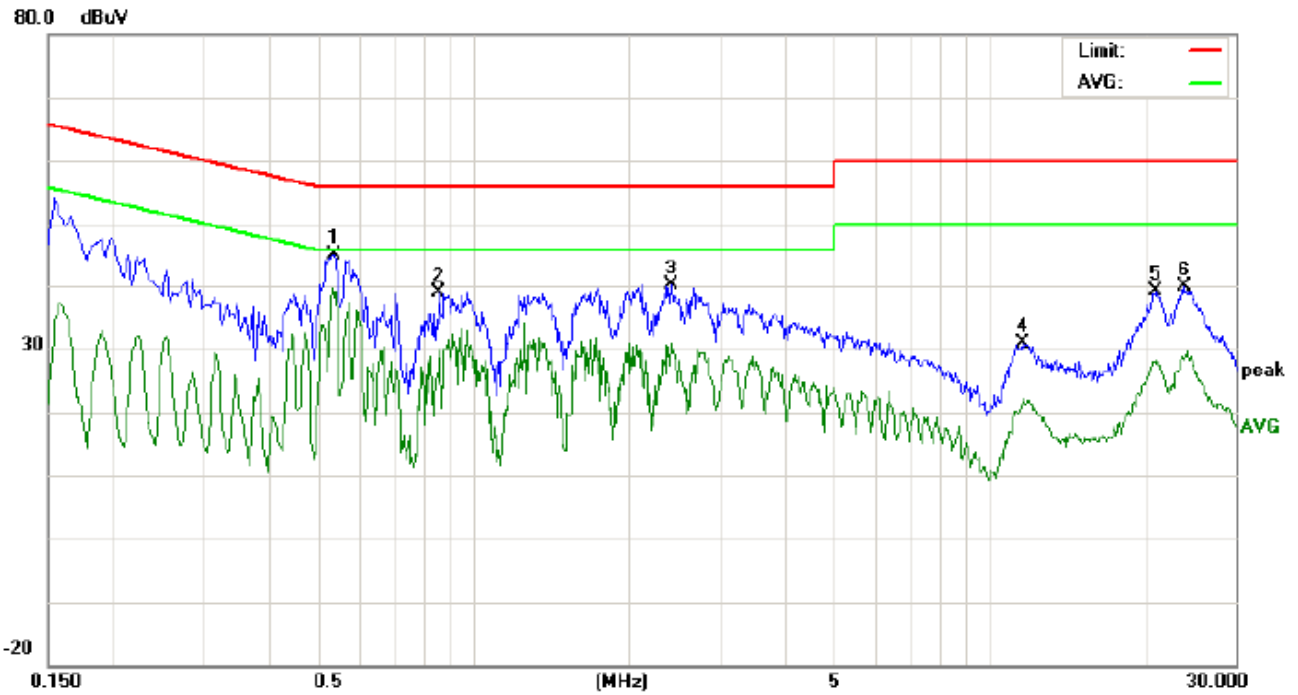

Site: Conduction Phase: *L1* Temperature: 24.1
 Limit: FCC Class B Conduction(QP) Power: Humidity: 53.5 %
 EUT: Bluetooth Headset
 M/N: E06-C
 Mode: BT Link with charging
 Note:

No.	Freq. (MHz)	Reading_Level (dBuV)			Correct Factor (dB)	Measurement (dBuV)			Limit (dBuV)		Margin (dB)		P/F	Comment
		Peak	QP	AVG		Peak	QP	AVG	QP	AVG	QP	AVG		
1	0.5380	34.68		27.78	10.37	45.05		38.15	56.00	46.00	-10.95	-7.85	P	
2	0.8580	28.60		19.45	10.36	38.96		29.81	56.00	46.00	-17.04	-16.19	P	
3	2.4180	29.73		20.45	10.40	40.13		30.85	56.00	46.00	-15.87	-15.15	P	
4	11.6100	20.82		11.78	10.12	30.94		21.90	60.00	50.00	-29.06	-28.10	P	
5	21.1340	29.10		18.11	10.13	39.23		28.24	60.00	50.00	-20.77	-21.76	P	
6	23.8300	29.87		18.54	10.11	39.98		28.65	60.00	50.00	-20.02	-21.35	P	

Line Conducted Emission Test Line 2-N

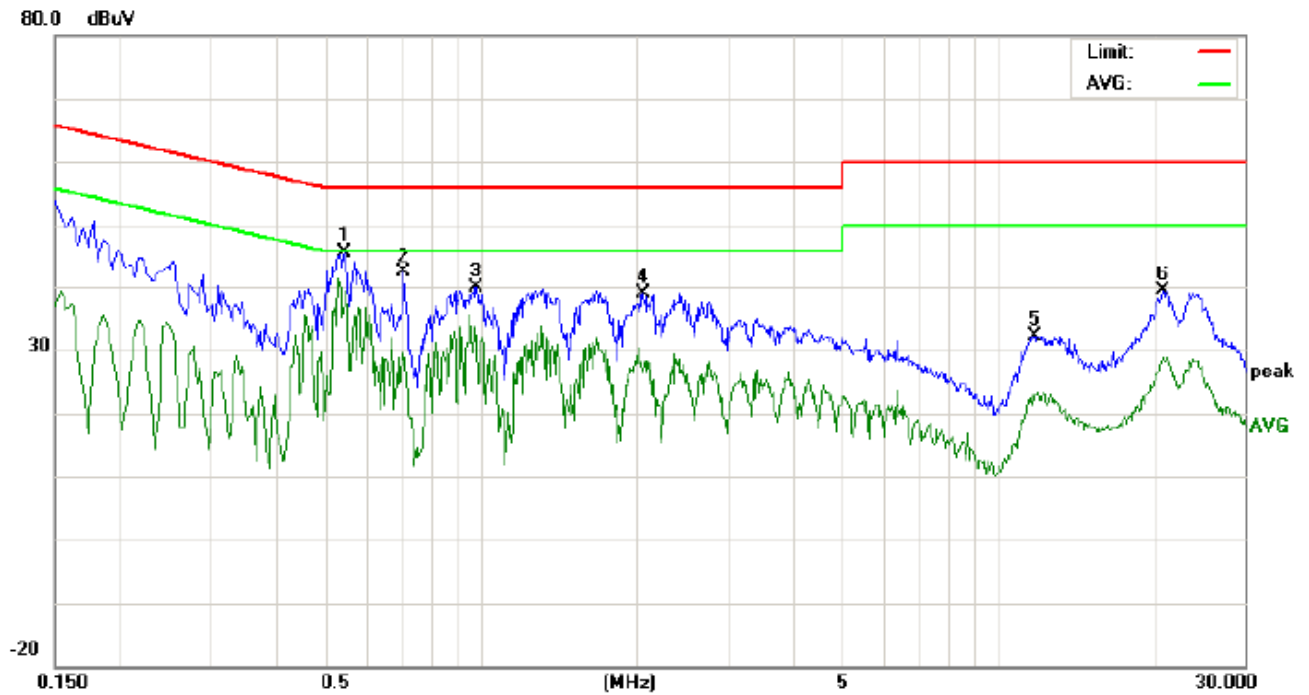

Site: Conduction Phase: **N** Temperature: 24.1
Limit: FCC Class B Conduction(QP) Power: Humidity: 53.5 %
EUT: Bluetooth Headset
M/N: E06-C
Mode: BT Link with charging
Note:

No.	Freq. (MHz)	Reading_Level (dBuV)			Correct Factor (dB)	Measurement (dBuV)			Limit (dBuV)		Margin (dB)		P/F	Comment
		Peak	QP	AVG		Peak	QP	AVG	QP	AVG	QP	AVG		
1	0.5460	35.33		26.72	10.36	45.69		37.08	56.00	46.00	-10.31	-8.92	P	
2	0.7100	32.00		19.34	10.34	42.34		29.68	56.00	46.00	-13.66	-16.32	P	
3	0.9820	29.45		21.24	10.38	39.83		31.62	56.00	46.00	-16.17	-14.38	P	
4	2.0620	28.73		16.30	10.25	38.98		26.55	56.00	46.00	-17.02	-19.45	P	
5	11.7980	22.10		12.41	10.13	32.23		22.54	60.00	50.00	-27.77	-27.46	P	
6	20.8980	29.16		18.64	10.13	39.29		28.77	60.00	50.00	-20.71	-21.23	P	

APPENDIX A: PHOTOGRAPHS OF TEST SETUP

FCC LINE CONDUCTED EMISSION TEST SETUP

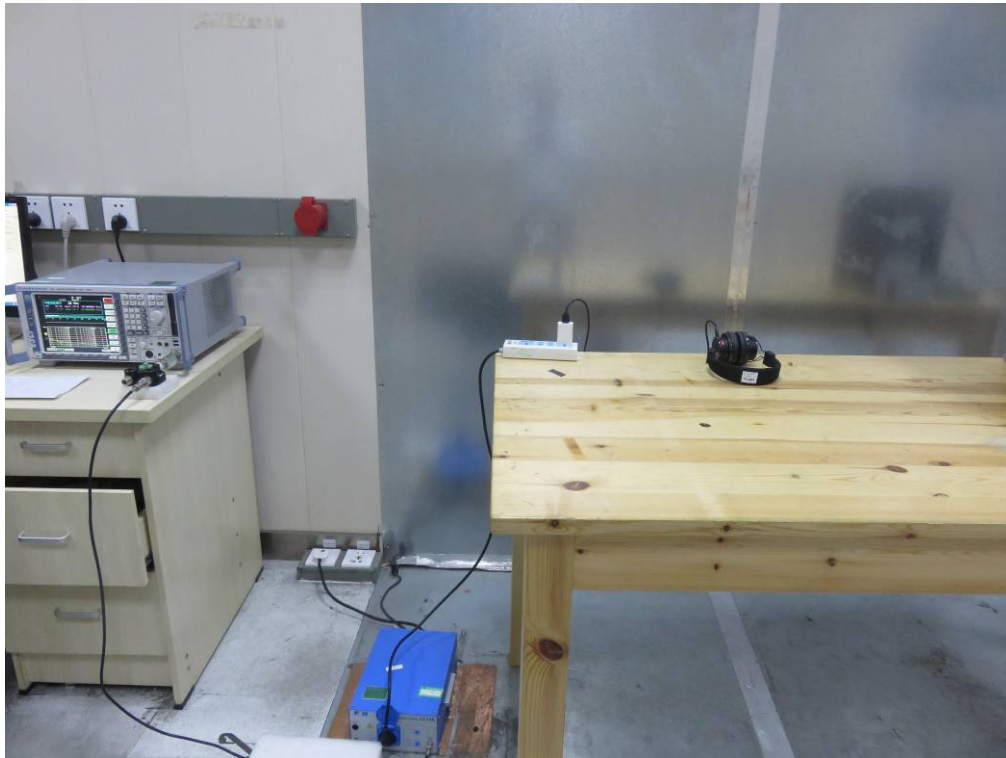

FCC RADIATED EMISSION TEST SETUP

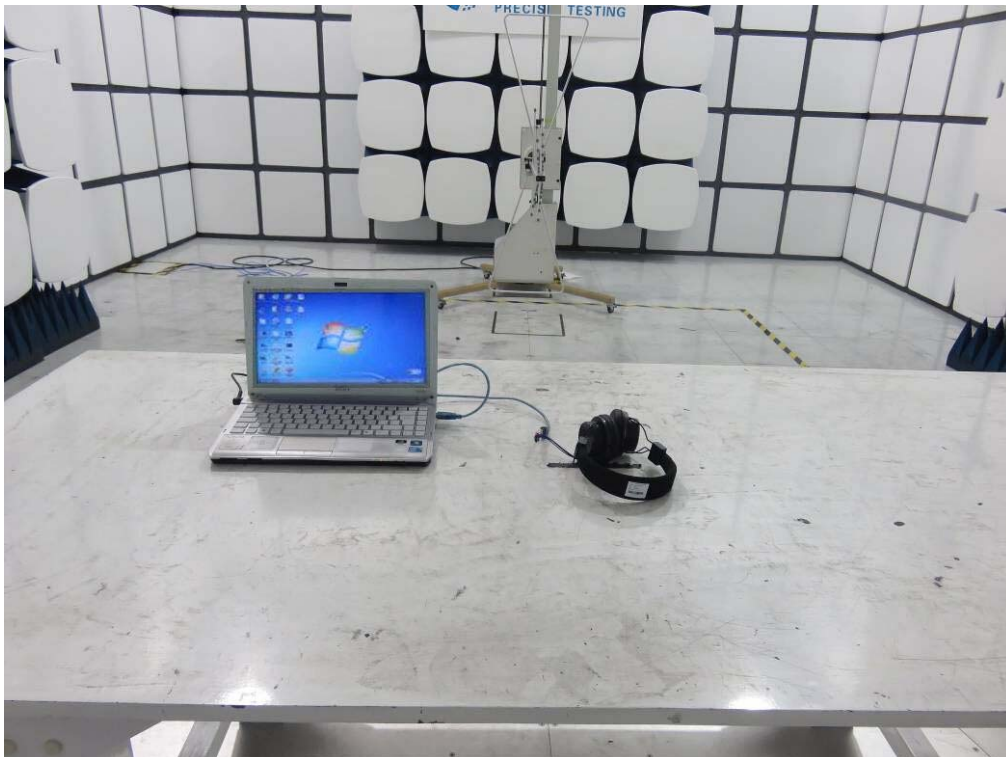

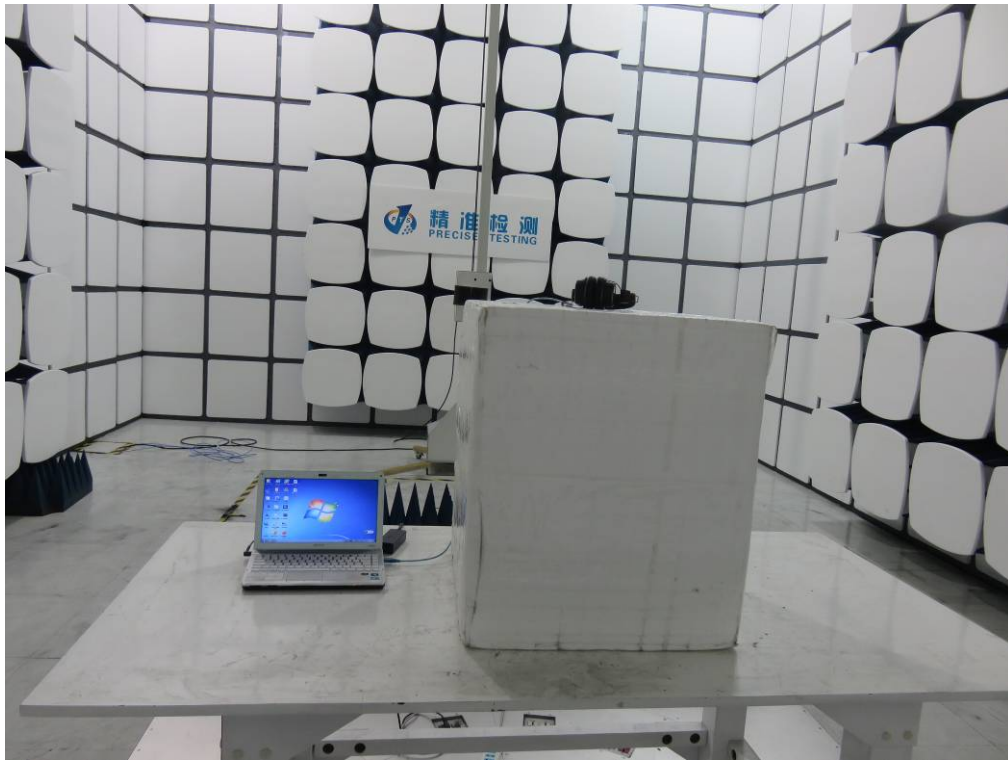

APPENDIX B: PHOTOGRAPHS OF EUT
TOP VIEW OF EUT



BOTTOM VIEW OF EUT



FRONT VIEW OF EUT



BACK VIEW OF EUT



LEFT VIEW OF EUT



RIGHT VIEW OF EUT



VIEW OF EUT (PORT)



OPEN VIEW OF EUT

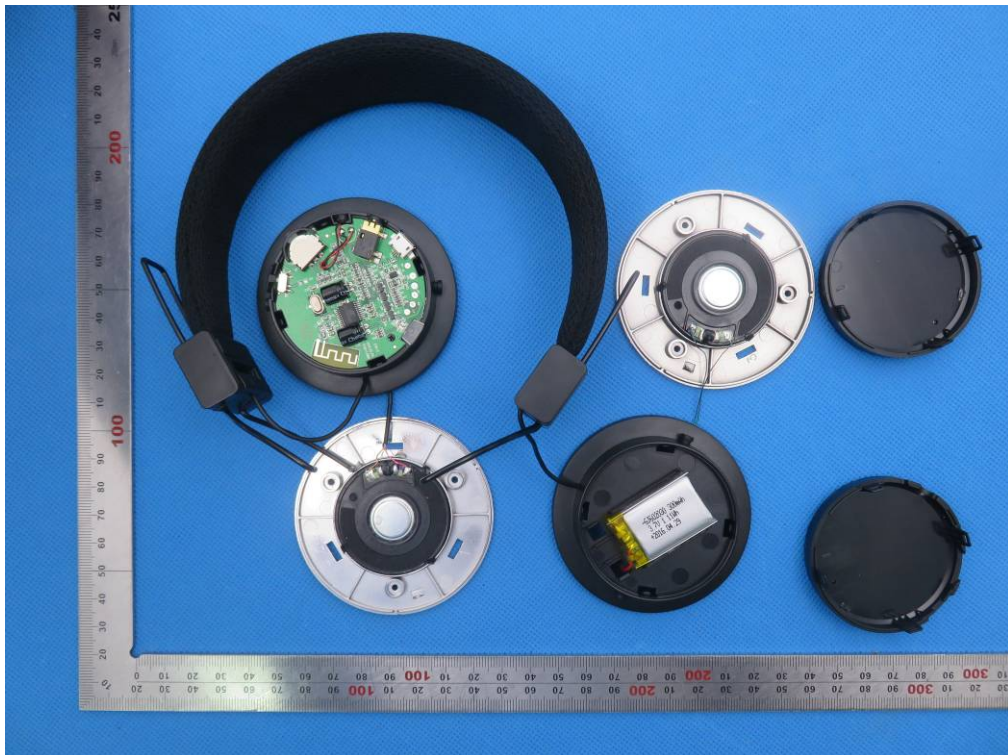

INTERNAL VIEW OF EUT-1

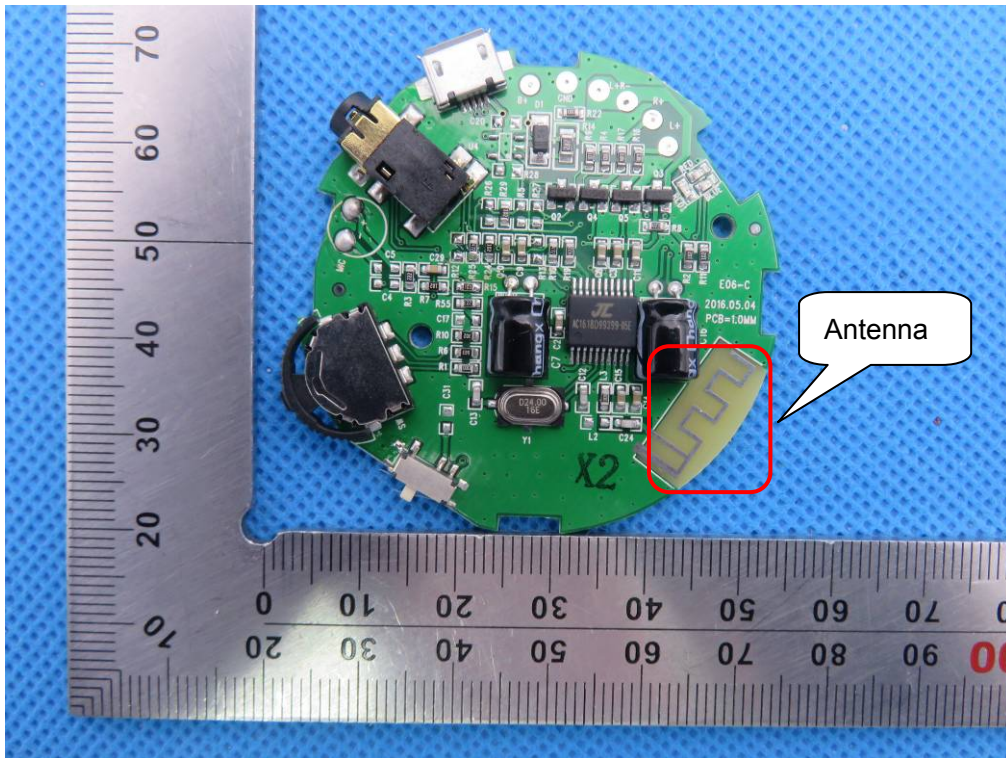

INTERNAL VIEW OF EUT-2

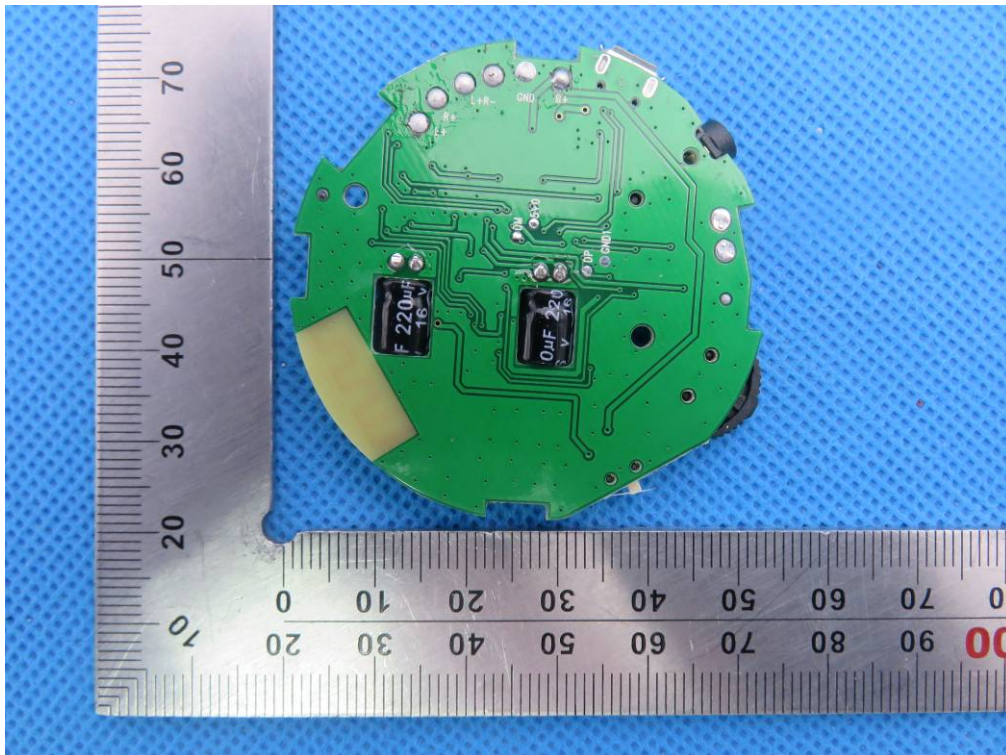

INTERNAL VIEW OF EUT-3

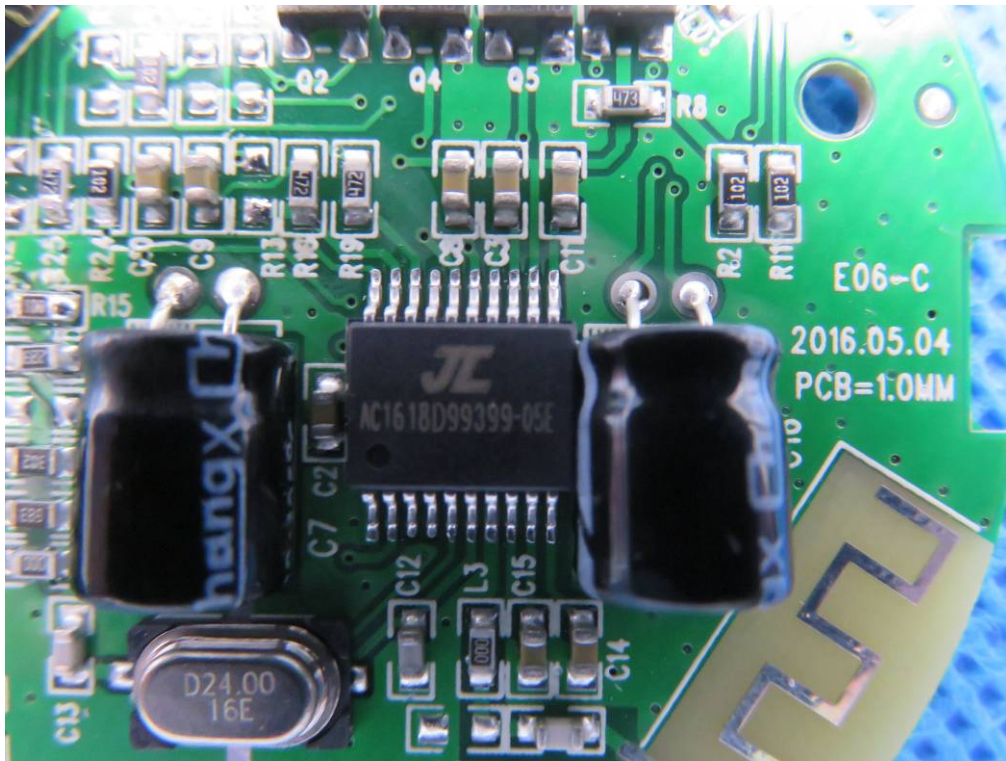

----END OF REPORT----