



RF TEST REPORT

Product Name: WorldPenScan WiFi

Model Name: MSE10

FCC ID: QIC-MSE10

Issued For : PenPower Technology Ltd.

7F., No.47, Lane 2, Sec. 2, Guangfu Rd., Hsinchu 300,
Taiwan, R.O.C

Issued By : Shenzhen LGT Test Service Co., Ltd.

Room 205, Building 13, Zone B, Chen Hsong Industrial Park,
No.177 Renmin West Road, Jinsha Community, Kengzi
Street, Pingshan New District, Shenzhen, China

Report Number: LGT22K038RF07

Sample Received Date: Nov. 14, 2022

Date of Test: Nov. 14, 2022 - Dec. 14, 2022

Date of Issue: Dec. 14, 2022

The test report is effective only with both signature and specialized stamp. This report shall not be reproduced except in full without the written approval of the Laboratory. The results in this report only apply to the tested sample.



TEST REPORT CERTIFICATION

Applicant PenPower Technology Ltd.
Address 7F., No.47, Lane 2, Sec. 2, Guangfu Rd., Hsinchu 300,
Taiwan, R.O.C

Manufacturer Shenzhen TwoMonkeys Technology Co., Ltd.
Address Room 1201, 12 / F, Dachong Building (Shangmei Keji),
Dachong Community, Yuehai Street, Nanshan District,
Shenzhen, China

Product Name WorldPenScan WiFi
Trademark PenPower
Model Name MSE10
Sample Status: Normal

APPLICABLE STANDARDS	
STANDARD	TEST RESULTS
FCC Part 15.247, Subpart C ANSI C63.10-2013	PASS

Prepared by:

Zane Shan

Zane Shan
Engineer

Approved by:

Vita Li

Vita Li
Technical Director





Table of Contents	Page
1. SUMMARY OF TEST RESULTS	6
1.1 TEST FACTORY	7
1.2 MEASUREMENT UNCERTAINTY	7
2. GENERAL INFORMATION	8
2.1 GENERAL DESCRIPTION OF THE EUT	8
2.2 DESCRIPTION OF THE TEST MODES	10
2.3 FREQUENCY HOPPING SYSTEM REQUIREMENTS	10
2.4 TABLE OF PARAMETERS OF TEST SOFTWARE SETTING	12
2.5 DESCRIPTION OF NECESSARY ACCESSORIES AND SUPPORT UNITS	12
2.6 EQUIPMENTS LIST	13
3. EMC EMISSION TEST	14
3.1 CONDUCTED EMISSION MEASUREMENT	14
3.2 RADIATED EMISSION MEASUREMENT	18
4. CONDUCTED SPURIOUS & BAND EDGE EMISSION	35
4.1 LIMIT	35
4.2 TEST PROCEDURE	35
4.3 TEST SETUP	36
4.4 EUT OPERATION CONDITIONS	36
4.5 TEST RESULTS	36
5. NUMBER OF HOPPING CHANNEL	37
5.1 LIMIT	37
5.2 TEST PROCEDURE	37
5.3 TEST SETUP	37
5.4 EUT OPERATION CONDITIONS	37
5.5 TEST RESULTS	37
6. AVERAGE TIME OF OCCUPANCY	38
6.1 LIMIT	38
6.2 TEST PROCEDURE	38
6.3 TEST SETUP	38
6.4 EUT OPERATION CONDITIONS	38
6.5 TEST RESULTS	38
7. HOPPING CHANNEL SEPARATION MEASUREMENT	39
7.1 LIMIT	39
7.2 TEST PROCEDURE	39



Table of Contents	Page
7.3 TEST SETUP	39
7.4 EUT OPERATION CONDITIONS	39
7.5 TEST RESULTS	39
8. BANDWIDTH TEST	40
8.1 LIMIT	40
8.2 TEST PROCEDURE	40
8.3 TEST SETUP	40
8.4 EUT OPERATION CONDITIONS	40
8.5 TEST RESULTS	40
9. OUTPUT POWER TEST	41
9.1 LIMIT	41
9.2 TEST PROCEDURE	41
9.3 TEST SETUP	41
9.4 EUT OPERATION CONDITIONS	41
9.5 TEST RESULTS	42
10. ANTENNA REQUIREMENT	43
10.1 STANDARD REQUIREMENT	43
10.2 EUT ANTENNA	43
APPENDIX I:TEST RESULTS	44
DUTY CYCLE	44
MAXIMUM PEAK CONDUCTED OUTPUT POWER	48
-20DB BANDWIDTH	49
OCCUPIED CHANNEL BANDWIDTH	53
CARRIER FREQUENCIES SEPARATION	57
BAND EDGE	61
BAND EDGE(HOPPING)	66
CONDUCTED RF SPURIOUS EMISSION	71
NUMBER OF HOPPING CHANNEL	78
DWELL TIME	81
APPENDIX II: PHOTOS OF TEST SETUP	84



Revision History

Rev.	Issue Date	Contents
00	Dec. 14, 2022	Initial Issue



1. SUMMARY OF TEST RESULTS

Test procedures according to the technical standards:
KDB 558074 D01 15.247 Meas Guidance v05r02.

FCC Part 15.247, Subpart C			
Standard Section	Test Item	Judgment	Remark
15.207	Conducted Emission	PASS	--
15.247(a)(1)	Hopping Channel Separation	PASS	--
15.247(a)(1)&(b)(1)	Output Power	PASS	--
15.209	Radiated Spurious Emission	PASS	--
15.247(d)	Conducted Spurious & Band Edge Emission	PASS	--
15.247(a)(1)(iii)	Number of Hopping Frequency	PASS	--
15.247(a)(1)(iii)	Dwell Time	PASS	--
15.247(a)(1)	Bandwidth	PASS	--
15.205	Restricted bands of operation	PASS	--
Part 15.247(d)/part 15.209(a)	Band Edge Emission	PASS	--
15.203	Antenna Requirement	PASS	--

NOTE:

(1) 'N/A' denotes test is not applicable in this Test Report.

(2) All tests are according to ANSI C63.10-2013.



1.1 TEST FACTORY

Company Name:	Shenzhen LGT Test Service Co., Ltd.
Address:	Room 205, Building 13, Zone B, Chen Hsong Industrial Park, No.177 Renmin West Road, Jinsha Community, Kengzi Street, Pingshan New District, Shenzhen, China
Accreditation Certificate	FCC Registration No.: 746540
	A2LA Certificate No.: 6727.01

1.2 MEASUREMENT UNCERTAINTY

The reported uncertainty of measurement $y \pm U$, where expanded uncertainty U is based on a standard uncertainty multiplied by a coverage factor of $k=2$, providing a level of confidence of approximately **95** %.

No.	Item	Uncertainty
1	RF output power, conducted	± 0.68 dB
2	Unwanted Emissions, conducted	± 2.988 dB
3	All emissions, radiated 9K-30MHz	± 2.84 dB
4	All emissions, radiated 30M-1GHz	± 4.39 dB
5	All emissions, radiated 1G-6GHz	± 5.10 dB
6	All emissions, radiated >6G	± 5.48 dB
7	Conducted Emission (9KHz-150KHz)	± 2.79 dB
8	Conducted Emission (150KHz-30MHz)	± 2.80 dB



2. GENERAL INFORMATION

2.1 GENERAL DESCRIPTION OF THE EUT

Product Name	WorldPenScan WiFi
Trademark	PenPower
Model Name	MSE10
Series Model	N/A
Model Difference	N/A
Channel List	Please refer to the Note 2.
Bluetooth	Frequency:2402 – 2480 MHz Modulation: GFSK, $\pi/4$ -DQPSK, 8DPSK
Antenna Type	Please refer to the Note 3.
Rating	Input: DC 5V,1A Output: DC 5V,330mA
Battery	Capacity: 1200mAh Rated Voltage:3.8V Charge Limit Voltage:4.3V
Hardware version number	V0.1
Software version number	a133_android10_c3_uart0_20221109.img
Connecting I/O Port(s)	Please refer to the Note 1.

Note:

1. For a more detailed features description, please refer to the manufacturer's specifications or the User Manual.



2.

Channel List					
Channel	Frequency (MHz)	Channel	Frequency (MHz)	Channel	Frequency (MHz)
00	2402	27	2429	54	2456
01	2403	28	2430	55	2457
02	2404	29	2431	56	2458
03	2405	30	2432	57	2459
04	2406	31	2433	58	2460
05	2407	32	2434	59	2461
06	2408	33	2435	60	2462
07	2409	34	2436	61	2463
08	2410	35	2437	62	2464
09	2411	36	2438	63	2465
10	2412	37	2439	64	2466
11	2413	38	2440	65	2467
12	2414	39	2441	66	2468
13	2415	40	2442	67	2469
14	2416	41	2443	68	2470
15	2417	42	2444	69	2471
16	2418	43	2445	70	2472
17	2419	44	2446	71	2473
18	2420	45	2447	72	2474
19	2421	46	2448	73	2475
20	2422	47	2449	74	2476
21	2423	48	2450	75	2477
22	2424	49	2451	76	2478
23	2425	50	2452	77	2479
24	2426	51	2453	78	2480
25	2427	52	2454		
26	2428	53	2455		

3. Table for Filed Antenna

Ant.	Brand	Model Name	Antenna Type	Connector	Gain (dBi)	NOTE
1	PenPower	MSE10	FPC	N/A	2.5dBi	BT ANT

Note: The antenna information refer the manufacturer provide report, applicable only to the tested sa-mple identified in the report.



2.2 DESCRIPTION OF THE TEST MODES

To investigate the maximum EMI emission characteristics generated from EUT, the test system was pre-scanning tested based on the consideration of following EUT operation mode or test configuration mode which possibly have effect on EMI emission level. Each of these EUT operation mode(s) or test configuration mode(s) mentioned above was evaluated respectively.

Worst Mode	Description	Data Rate/Modulation
Mode 1	TX CH00	1Mbps/GFSK
Mode 2	TX CH39	1Mbps/GFSK
Mode 3	TX CH78	1Mbps/GFSK
Mode 4	TX CH00	2 Mbps/ $\pi/4$ -DQPSK
Mode 5	TX CH39	2 Mbps/ $\pi/4$ -DQPSK
Mode 6	TX CH78	2 Mbps/ $\pi/4$ -DQPSK
Mode 7	TX CH00	3 Mbps/8DPSK
Mode 8	TX CH39	3 Mbps/8DPSK
Mode 9	TX CH78	3 Mbps/8DPSK
Mode 10	Hopping	GFSK
Mode 11	Hopping	$\pi/4$ -DQPSK
Mode 12	Hopping	8DPSK

Note:

- (1) The measurements are performed at all Bit Rate of Transmitter, the worst data was reported.
- (2) We tested for all available U.S. voltage and frequencies (For 120V, 50/60Hz and 240V, 50/60Hz) for which the device is capable of operation, and the worst case of 120V/ 60Hz is shown in the report.
- (3) The battery is fully-charged during the radiated and RF conducted test.

For AC Conducted Emission

Test Case	
AC Conducted Emission	Mode 13: Keeping BT TX

2.3 FREQUENCY HOPPING SYSTEM REQUIREMENTS

(1) Standard and Limit

According to FCC Part 15.247(a)(1), The system shall hop to channel frequencies that are selected at the system hopping rate from a pseudo randomly ordered list of hopping frequencies. Each frequency must be used equally on the average by each transmitter. The system receivers shall have input bandwidths that match the hopping channel bandwidths of their corresponding transmitters and shall shift frequencies in synchronization with the transmitted signals.

Frequency hopping spread spectrum systems are not required to employ all available hopping channels during each transmission. However, the system, consisting of both the transmitter and the receiver, must be designed to comply with all of the regulations in this section should the transmitter be presented with a continuous data (or information) stream. In addition, a system employing short transmission bursts must comply with the definition of a frequency hopping system and must distribute its transmissions over the minimum number of hopping channels specified in this section.



The incorporation of intelligence within a frequency hopping spread spectrum system that permits the system to recognize other users within the spectrum band so that it individually and independently chooses and adapts its hop sets to avoid hopping on occupied channels is permitted. The coordination of frequency hopping systems in any other manner for the express purpose of avoiding the simultaneous occupancy of individual hopping frequencies by multiple transmitters is not permitted.

(2) The Pseudorandom sequence may be generated in a nine-stage shift register whose 5th and 9th stage outputs are added in a modulo-two addition stage. And the result is fed back to the input of the first stage. The sequence begins with the first one of 9 consecutive ones: i.e. the shift register is initialized with nine ones.

Number of shift register stages: 9

Length of pseudo-random sequence: $2^9 - 1 = 511$ bits

Longest sequence of zeros: 8 (non-inverted signal)

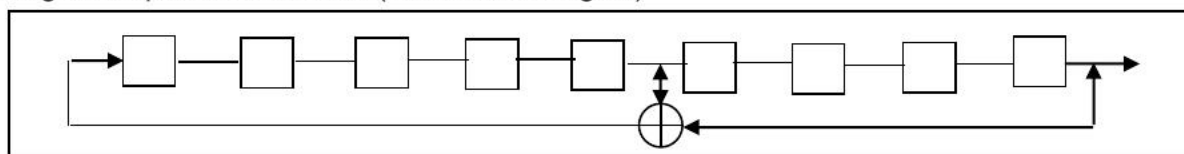

Linear Feedback Shift Register for Generator of the PRBS sequence

An example of Pseudorandom Frequency Hopping Sequence as follow:

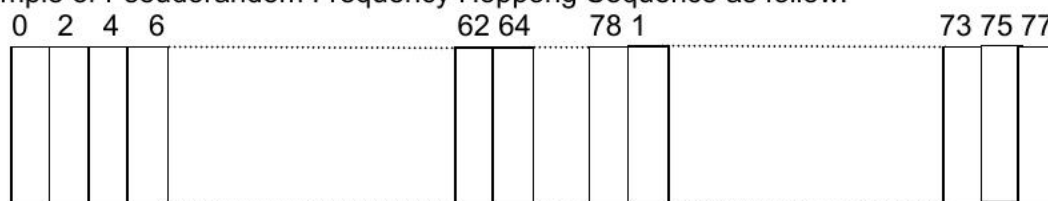

Each frequency used equally on the average by each transmitter.

The system receivers have input bandwidths that match the hopping channel bandwidths of their corresponding transmitters and shift frequencies into synchronization with the transmitted signals.

(3) Frequency Hopping System

This transmitter device is frequency hopping device and complies with FCC part 15.247 rule.

This device uses Bluetooth radio which operates in 2400-2483.5 MHz band. Bluetooth uses a radio technology called frequency-hopping spread spectrum, which chops up the data being sent and transmits chunks of it on up to 79 bands (1 MHz each; centred from 2402 to 2480 MHz) in the range 2,400-2,483.5MHz. The transmitter switches hop frequencies 1,600 times per second to assure a high degree of data security. All Bluetooth devices participating in a given piconet are synchronized to the frequency-hopping channel for the piconet. The frequency hopping sequence is determined by the master's device address and the phase of the hopping sequence (the frequency to hop at a specific time) is determined by the master's internal clock. Therefore, all slaves in a piconet must know the master's device address and must synchronize their clocks with the master's clock.

Adaptive Frequency Hopping (AFH) was introduced in the Bluetooth specification to provide an effective way for a Bluetooth radio to counteract normal interference. AFH identifies "bad" channels, where either other wireless devices are interfering with the Bluetooth signal or the Bluetooth signal is interfering with another device. The AFH-enabled Bluetooth device will then communicate with other devices within its piconet to share details of any identified bad channels. The devices will then switch to alternative available "good" channels, away from the areas of interference, thus having no impact on the bandwidth used.

This device was tested with a bluetooth system receiver to check that the device maintained hopping synchronization, and the device complied with these requirements FCC Part 15.247 rule.



2.4 TABLE OF PARAMETERS OF TEST SOFTWARE SETTING

During testing channel & power controlling software provided by the customer was used to control the operating channel as well as the output power level. The RF output power selection is for the setting of RF output power expected by the customer and is going to be fixed on the firmware of the final end product power parameters of FHSS.

Test software Version	Test program: Bluetooth	
CMD	1M	6
	2M	6
	3M	6

2.5 DESCRIPTION OF NECESSARY ACCESSORIES AND SUPPORT UNITS

The EUT has been tested as an independent unit together with other necessary accessories or support units. The following support units or accessories were used to form a representative test configuration during the tests.

Accessories Equipment

Description	Manufacturer	Model	S/N	Rating

Auxiliary Equipment

Description	Manufacturer	Model	S/N	Rating
Adapter	TEN PAO INDUSTRIAL CO LTD	S005CAU0500100	N/A	Input: 100-240V ~ 50/60Hz 0.2A Output: 5V, 2A
USB A to USB C	Pinsheng Electronics Co., Ltd	Micro USB	N/A	1m, shielded, without ferrite core
Laptop	HUAWEI	HKF-16	N/A	N/A

Note:

- (1) For detachable type I/O cable should be specified the length in cm in 『Length』 column.
- (2) “YES” is means “with core”; “NO” is means “without core”.



2.6 EQUIPMENTS LIST

Conducted Emission

Equipment	Manufacturer	Model No.	Serial No.	Cal. Date	Cal. Until
EMI Test Receiver	R&S	ESU	100372	2022.04.12	2023.04.11
LISN	COM-POWER	LI-115	02032	2022.04.13	2023.04.12
LISN	SCHWARZBECK	NNLK 8121	00847	2022.08.19	2023.08.18
CE Cable	N.A	C01	N.A	2022.05.05	2023.05.04
Transient Limiter	CYBERTEK	EM5010A	E2250100049	2022.06.02	2023.06.01
Temperature & Humidity	KTJ	TA218B	N.A	2022.05.05	2023.05.04
Testing Software	EMC-I_V1.4.0.3_SKET				

Radiation Test equipment

Kind of Equipment	Manufacturer	Type No.	Serial No.	Last calibration	Calibrated until
EMI Test Receiver	R&S	ESU	100372	2022.04.12	2023.04.11
Spectrum Analyzer	Kesight	N9010B	MY60242508	2022.04.29	2023.04.28
Bilog Antenna	SCHAFFNER	CBL6112B	270S	2022.06.05	2025.06.04
Horn Antenna	SCHWARZBECK	3115	10SL0060	2022.06.02	2025.06.01
Pre-amplifier(0.1M-3GHz)	HP	8447D	2727A05655	2022.04.11	2023.04.10
Pre-amplifier(1-26.5G)	Agilent	8449B	3008A4722	2022.04.12	2023.04.11
RE Cable (9K-1G)	N.A	R01	N.A	2022.05.05	2023.05.04
RE Cable (1-26G)	N.A	R02	N.A	2022.05.05	2023.05.04
Temperature & Humidity	KTJ	TA218B	N.A	2022.05.05	2023.05.04
Testing Software	EMC-I_V1.4.0.3_SKET				

RF Connected Test equipment

Kind of Equipment	Manufacturer	Type No.	Serial No.	Last calibration	Calibrated until
Signal Generator	Keysight	N5182B	MY59100717	2022.04.30	2023.04.29
Signal Analyzer	Keysight	N9010B	MY60242508	2022.04.29	2023.04.28
Temperature & Humidity	KTJ	TA218B	N/A	2022.05.05	2023.05.04
Temperature & Humidity test chamber	AISRY	LX-1000L	171200018	2022.05.10	2023.05.09
Attenuator	eastsheep	90db	N/A	2022.04.29	2023.04.28
Testing Software	MTS 8310_2.0.0.0_MWRF-TEST				



3. EMC EMISSION TEST

3.1 CONDUCTED EMISSION MEASUREMENT

3.1.1 POWER LINE CONDUCTED EMISSION LIMITS

The radio frequency voltage that is conducted back onto the AC power line on any frequency or frequencies, within the band 150 kHz to 30 MHz, shall not exceed the limits in the following table.

FREQUENCY (MHz)	Conducted Emission limit (dBuV)	
	Quasi-peak	Average
0.15 -0.5	66 - 56 *	56 - 46 *
0.50 -5.0	56.00	46.00
5.0 -30.0	60.00	50.00

Note:

- (1) The tighter limit applies at the band edges.
- (2) The limit of “ * ” marked band means the limitation decreases linearly with the logarithm of the frequency in the range.

The following table is the setting of the receiver

Receiver Parameters	Setting
Attenuation	10 dB
Start Frequency	0.15 MHz
Stop Frequency	30 MHz
IF Bandwidth	9 kHz



3.1.2 TEST PROCEDURE

- a. The EUT is 0.8 m from the horizontal ground plane and 0.4 m from the vertical ground plane with EUT being connected to the power mains through a line impedance stabilization network (LISN). All other support equipments are powered from additional LISN(s). The LISN provides 50 Ohm/ 50uH of coupling impedance for the measuring instrument.
- b. Interconnecting cables that hang closer than 40 cm to the ground plane shall be folded back and forth in the center forming a bundle 30 to 40 cm long.
- c. I/O cables that are not connected to a peripheral shall be bundled in the center. The end of the cable may be terminated, if required, using the correct terminating impedance. The overall length shall not exceed 1 m.
- d. LISN is at least 80 cm from the nearest part of EUT chassis.
- e. For the actual test configuration, please refer to the related Item –EUT Test Photos.

3.1.3 TEST SETUP

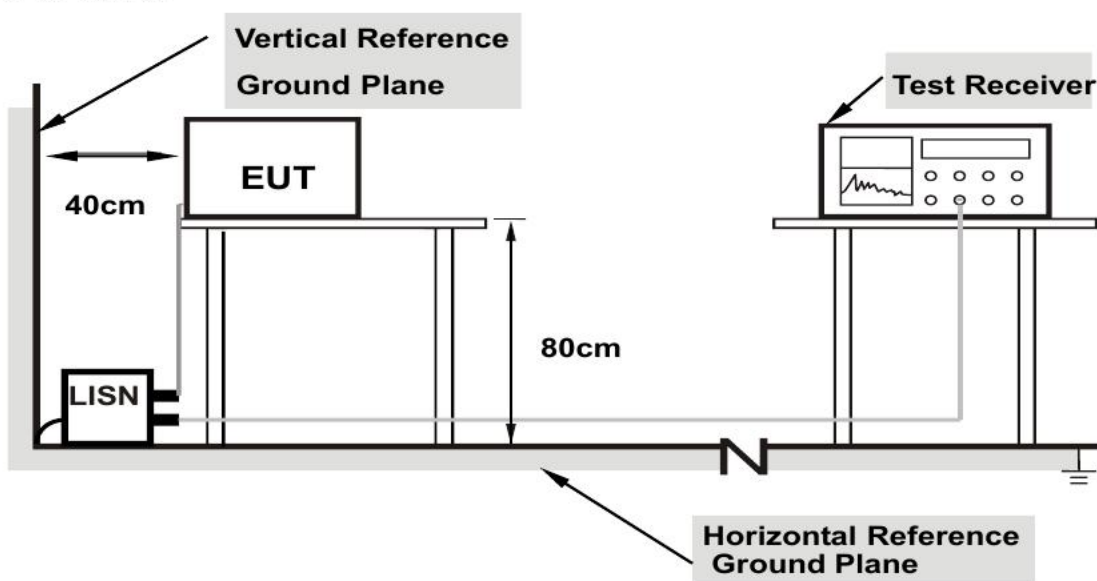

Note: 1. Support units were connected to second LISN.

2. Both of LISNs (AMN) are 80 cm from EUT and at least 80 cm from other units and other metal planes support units.

3.1.4 EUT OPERATING CONDITIONS

The EUT was configured for testing in a typical fashion (as a customer would normally use it). The EUT has been programmed to continuously transmit during test. This operating condition was tested and used to collect the included data.



3.1.5 TEST RESULT

Project: LGT22K038	Test Engineer: Dylan.shi
EUT: WorldPenScan WiFi	Temperature: 26.4°C
M/N: MSE10	Humidity: 55%RH
Test Voltage: AC 120V/60Hz	Test Data: 2022-11-18
Test Mode: TX BT	
Note:	

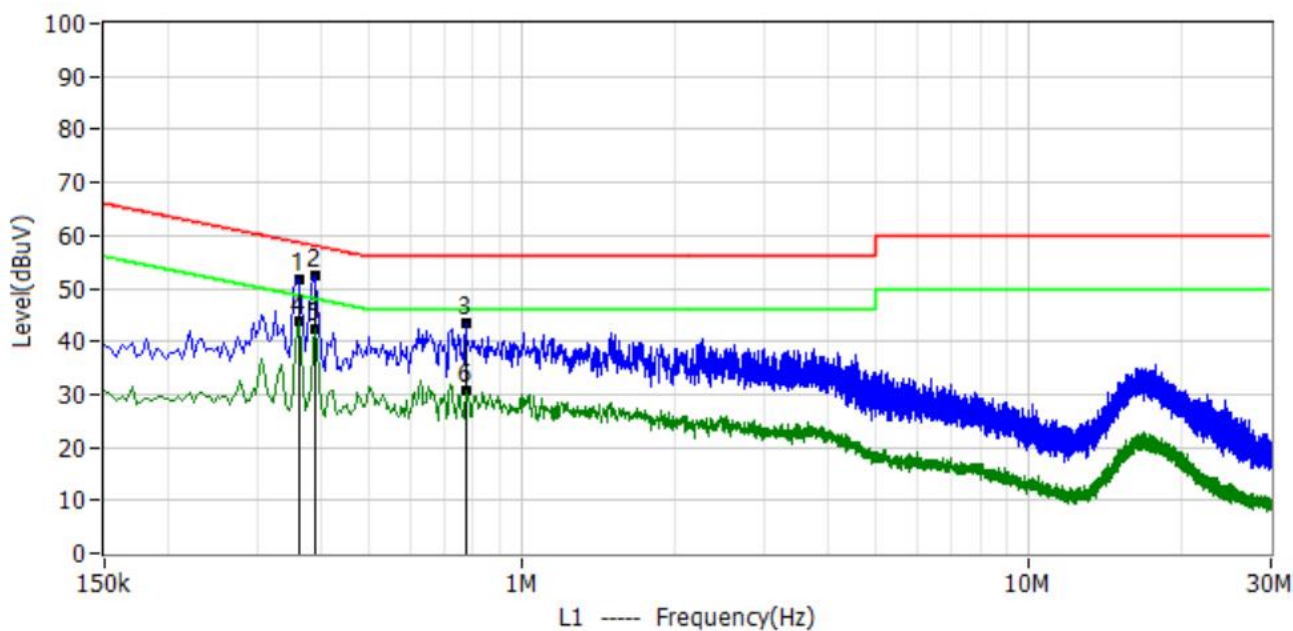

No.	Frequency	Reading dBuV	Factor dB	Level dBuV	Limit dBuV	Margin dB	Detector	Polar
1*	362.000kHz	41.26	10.50	51.76	58.68	-6.92	PK	L1
2*	390.000kHz	41.94	10.50	52.44	58.06	-5.63	PK	L1
3*	774.000kHz	32.88	10.52	43.40	56.00	-12.60	PK	L1
4*	362.000kHz	33.14	10.50	43.64	48.68	-5.04	AV	L1
5*	390.000kHz	31.96	10.50	42.46	48.06	-5.60	AV	L1
6*	778.000kHz	20.12	10.52	30.64	46.00	-15.36	AV	L1



Project: LGT22K038	Test Engineer: Dylan.shi
EUT: WorldPenScan WiFi	Temperature: 26.4°C
M/N: MSE10	Humidity: 55%RH
Test Voltage: AC 120V/60Hz	Test Data: 2022-11-18
Test Mode: TX BT	
Note:	

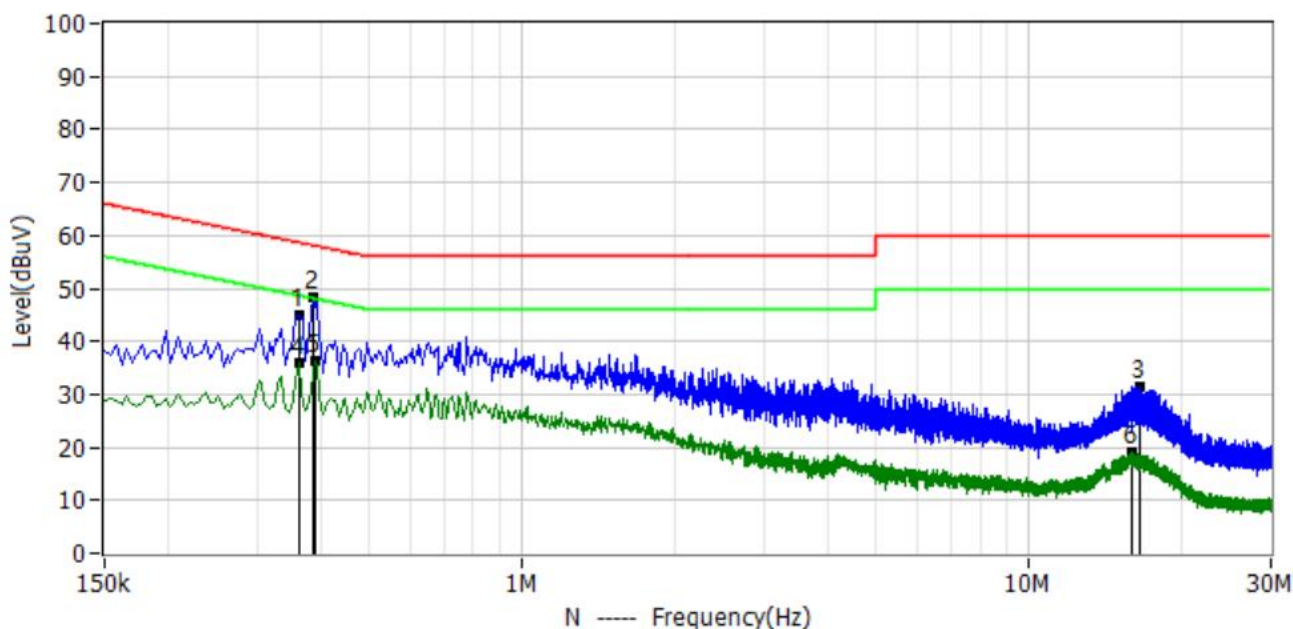

No.	Frequency	Reading dBuV	Factor dB	Level dBuV	Limit dBuV	Margin dB	Detector	Polar
1*	362.000kHz	34.51	10.50	45.01	58.68	-13.67	PK	N
2*	386.000kHz	37.87	10.50	48.37	58.15	-9.78	PK	N
3*	16.490MHz	20.56	11.08	31.64	60.00	-28.36	PK	N
4*	362.000kHz	25.54	10.50	36.04	48.68	-12.65	AV	N
5*	390.000kHz	25.76	10.50	36.26	48.06	-11.81	AV	N
6*	15.982MHz	7.96	11.07	19.03	50.00	-30.97	AV	N



3.2 RADIATED EMISSION MEASUREMENT

3.2.1 RADIATED EMISSION LIMITS

In any 100 kHz bandwidth outside the operating frequency band. In case the emission fall within the Restricted band specified on Part15.205 (a)&209(a) limit in the table and according to ANSI C63.10-2013 below has to be followed.

LIMITS OF RADIATED EMISSION MEASUREMENT (0.009MHz - 1000MHz)

Frequencies (MHz)	Field Strength (micorvolts/meter)	Measurement Distance (meters)
0.009~0.490	2400/F(KHz)	300
0.490~1.705	24000/F(KHz)	30
1.705~30.0	30	30
30~88	100	3
88~216	150	3
216~960	200	3
Above 960	500	3

LIMITS OF RADIATED EMISSION MEASUREMENT (1GHz-25 GHz)

FREQUENCY (MHz)	(dBuV/m) (at 3M)	
	PEAK	AVERAGE
Above 1000	74	54

Notes:

- (1) The limit for radiated test was performed according to FCC PART 15C.
- (2) The tighter limit applies at the band edges.
- (3) Emission level (dBuV/m)=20log Emission level (uV/m).

LIMITS OF RESTRICTED FREQUENCY BANDS

FREQUENCY (MHz)	FREQUENCY (MHz)	FREQUENCY (MHz)	FREQUENCY (GHz)
0.090-0.110	16.42-16.423	399.9-410	4.5-5.15
0.495-0.505	16.69475-16.69525	608-614	5.35-5.46
2.1735-2.1905	16.80425-16.80475	960-1240	7.25-7.75
4.125-4.128	25.5-25.67	1300-1427	8.025-8.5
4.17725-4.17775	37.5-38.25	1435-1626.5	9.0-9.2
4.20725-4.20775	73-74.6	1645.5-1646.5	9.3-9.5
6.215-6.218	74.8-75.2	1660-1710	10.6-12.7
6.26775-6.26825	108-121.94	1718.8-1722.2	13.25-13.4
6.31175-6.31225	123-138	2200-2300	14.47-14.5
8.291-8.294	149.9-150.05	2310-2390	15.35-16.2
8.362-8.366	156.52475-156.52525	2483.5-2500	17.7-21.4
8.37625-8.38675	156.7-156.9	2690-2900	22.01-23.12
8.41425-8.41475	162.0125-167.17	3260-3267	23.6-24.0
12.29-12.293	167.72-173.2	3332-3339	31.2-31.8
12.51975-12.52025	240-285	3345.8-3358	36.43-36.5
12.57675-12.57725	322-335.4	3600-4400	Above 38.6
13.36-13.41			

For Radiated Emission



Spectrum Parameter	Setting
Attenuation	Auto
Detector	Peak/QP/AV
Start Frequency	9 KHz/150KHz(Peak/QP/AV)
Stop Frequency	150KHz/30MHz(Peak/QP/AV)
RB / VB (emission in restricted band)	200Hz (From 9kHz to 0.15MHz)/ 9KHz (From 0.15MHz to 30MHz); 200Hz (From 9kHz to 0.15MHz)/ 9KHz (From 0.15MHz to 30MHz)

Spectrum Parameter	Setting
Attenuation	Auto
Detector	Peak/QP
Start Frequency	30 MHz(Peak/QP)
Stop Frequency	1000 MHz (Peak/QP)
RB / VB (emission in restricted band)	120 KHz / 300 KHz

Spectrum Parameter	Setting
Attenuation	Auto
Detector	Peak
Start Frequency	1000 MHz(Peak/AV)
Stop Frequency	10th carrier hamonic(Peak/AV)
RB / VB (emission in restricted band)	1 MHz / 3 MHz(Peak) 1 MHz/1/T MHz(AVG)

For Restricted band

Spectrum Parameter	Setting
Detector	Peak
Start/Stop Frequency	Lower Band Edge: 2310 to 2410 MHz Upper Band Edge: 2476 to 2500 MHz
RB / VB	1 MHz / 3 MHz(Peak) 1 MHz/1/T MHz(AVG)



Receiver Parameter	Setting
Attenuation	Auto
Start ~ Stop Frequency	9kHz~90kHz / RB 200Hz for PK & AV
Start ~ Stop Frequency	90kHz~110kHz / RB 200Hz for QP
Start ~ Stop Frequency	110kHz~490kHz / RB 200Hz for PK & AV
Start ~ Stop Frequency	490kHz~30MHz / RB 9kHz for QP
Start ~ Stop Frequency	30MHz~1000MHz / RB 120kHz for QP

3.2.2 TEST PROCEDURE

- a. The measuring distance at 3 m shall be used for measurements at frequency 0.009MHz up to 1GHz, and above 1GHz.
- b. The EUT was placed on the top of a rotating table 0.8 m (above 1GHz is 1.5 m) above the ground at a 3 m anechoic chamber test site. The table was rotated 360 degree to determine the position of the highest radiation.
- c. The height of the equipment shall be 0.8 m (above 1GHz is 1.5 m); the height of the test antenna shall vary between 1 m to 4 m. Horizontal and vertical polarization of the antenna are set to make the measurement.
- d. The initial step in collecting conducted emission data is a spectrum analyzer peak detector mode pre-scanning the measurement frequency range. Significant peaks are then marked and QuasiPeak detector mode will be re-measured.
- e. If the Peak Mode measured value is compliance with and lower than Quasi Peak Mode Limit, the EUT shall be deemed to meet QP Limits and no additional QP Mode measurement was performed.
- f. For the actual test configuration, please refer to the related Item –EUT Test Photos.

Note:

Both horizontal and vertical antenna polarities were tested and performed pretest to three orthogonal axis. The worst case emissions were reported.

3.2.3 DEVIATION FROM TEST STANDARD

No deviation.

3.2.4 TESTSETUP

(A) Radiated Emission Test-Up Frequency Below 30MHz

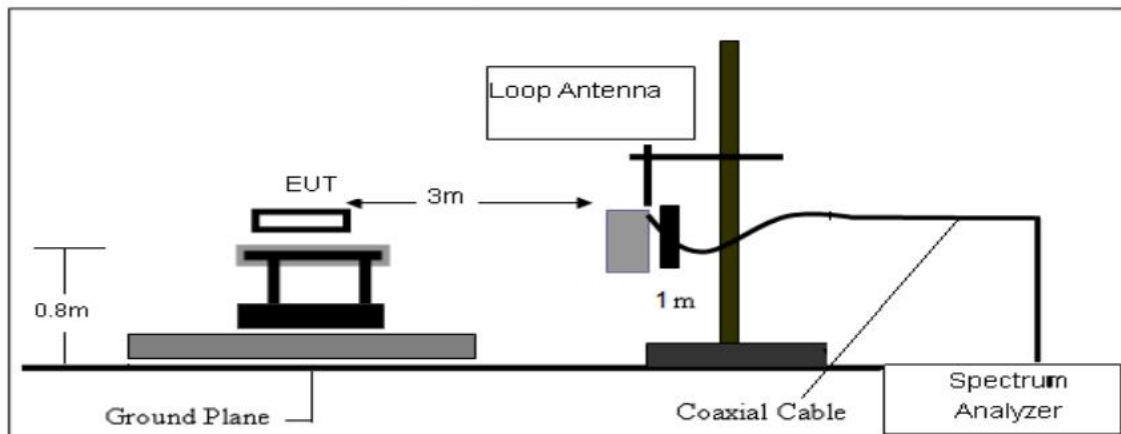

(B) Radiated Emission Test-Up Frequency 30MHz~1GHz

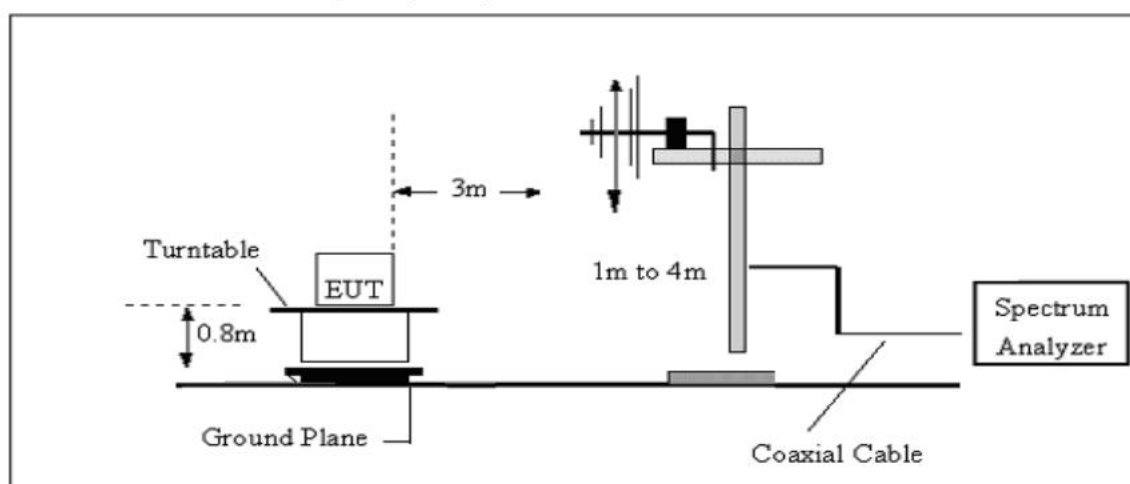

(C) Radiated Emission Test-Up Frequency Above 1GHz

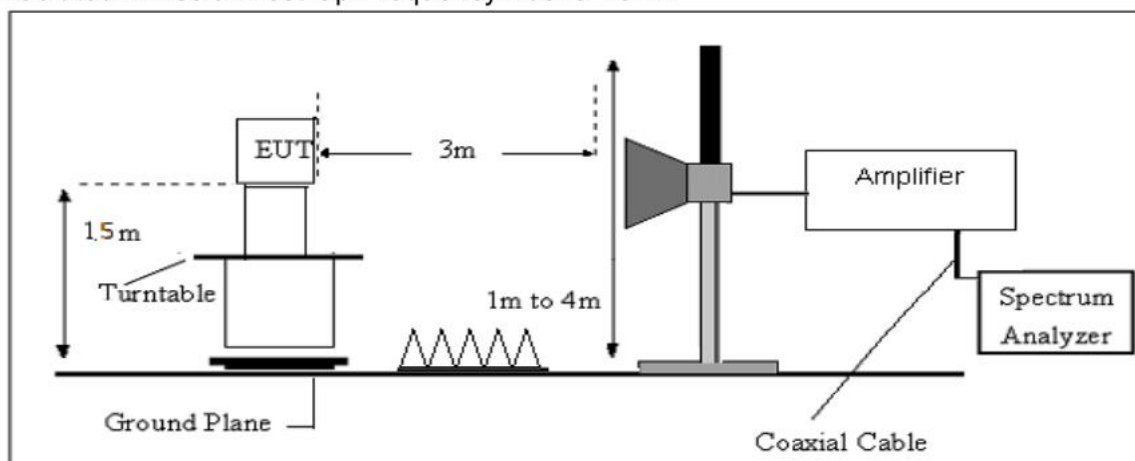

3.2.5 EUT OPERATING CONDITIONS

Please refer to section 3.1.4 of this report.



3.2.6 FIELD STRENGTH CALCULATION

The field strength is calculated by adding the Antenna Factor and Cable Factor and subtracting the Amplifier Gain and Duty Cycle Correction Factor (if any) from the measured reading. The basic equation with a sample calculation is as follows:

$$FS = RA + AF + CL - AG$$

Where

FS = Field Strength

CL = Cable Attenuation Factor (Cable Loss)

RA = Reading Amplitude

AG = Amplifier Gain

AF = Antenna Factor

For example

Frequency (MHz)	FS (dB μ V/m)	RA (dB μ V/m)	AF (dB)	CL (dB)	AG (dB)	Factor (dB)
300	40	58.1	12.2	1.6	31.9	-18.1

$$\text{Factor} = \text{AF} + \text{CL} - \text{AG}$$



3.2.7 TEST RESULTS

Project: LGT22K038	Test Engineer: Dylan.shi
EUT: WorldPenScan WiFi	Temperature: 24.8°C
M/N: MSE10	Humidity: 48%RH
Test Voltage: Battery 3.8V	Test Data: 2022-11-21
Test Mode: TX BT	
Note:	

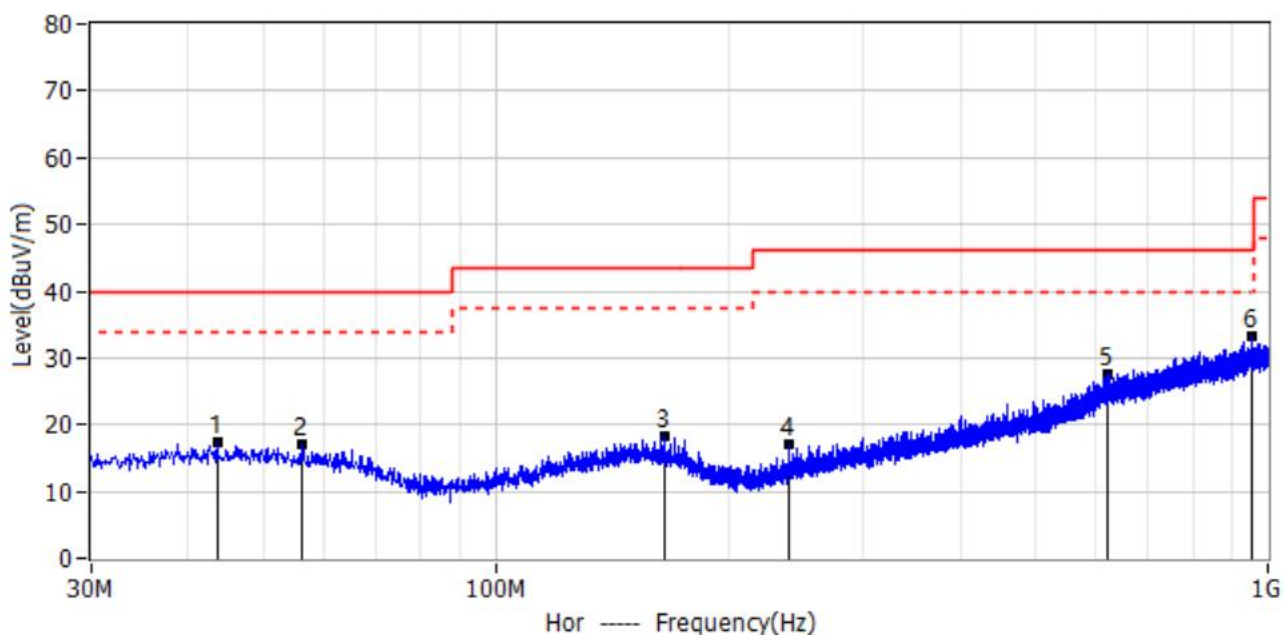

No.	Frequency	Reading dBuV	Factor dB/m	Level dBuV/m	Limit dBuV/m	Margin dB	Detector	Polar
1*	43.580MHz	3.48	13.75	17.23	40.00	-22.77	PK	Hor
2*	56.190MHz	3.69	13.30	16.99	40.00	-23.01	PK	Hor
3*	165.679MHz	4.22	14.05	18.27	43.50	-25.23	PK	Hor
4*	239.641MHz	4.76	12.21	16.97	46.00	-29.03	PK	Hor
5*	619.760MHz	5.00	22.58	27.58	46.00	-18.42	PK	Hor
6*	955.380MHz	5.39	27.76	33.15	46.00	-12.85	PK	Hor



Project: LGT22K038	Test Engineer: Dylan.shi
EUT: WorldPenScan WiFi	Temperature: 24.8°C
M/N: MSE10	Humidity: 48%RH
Test Voltage: Battery 3.8V	Test Data: 2022-11-21
Test Mode: TX BT	
Note:	

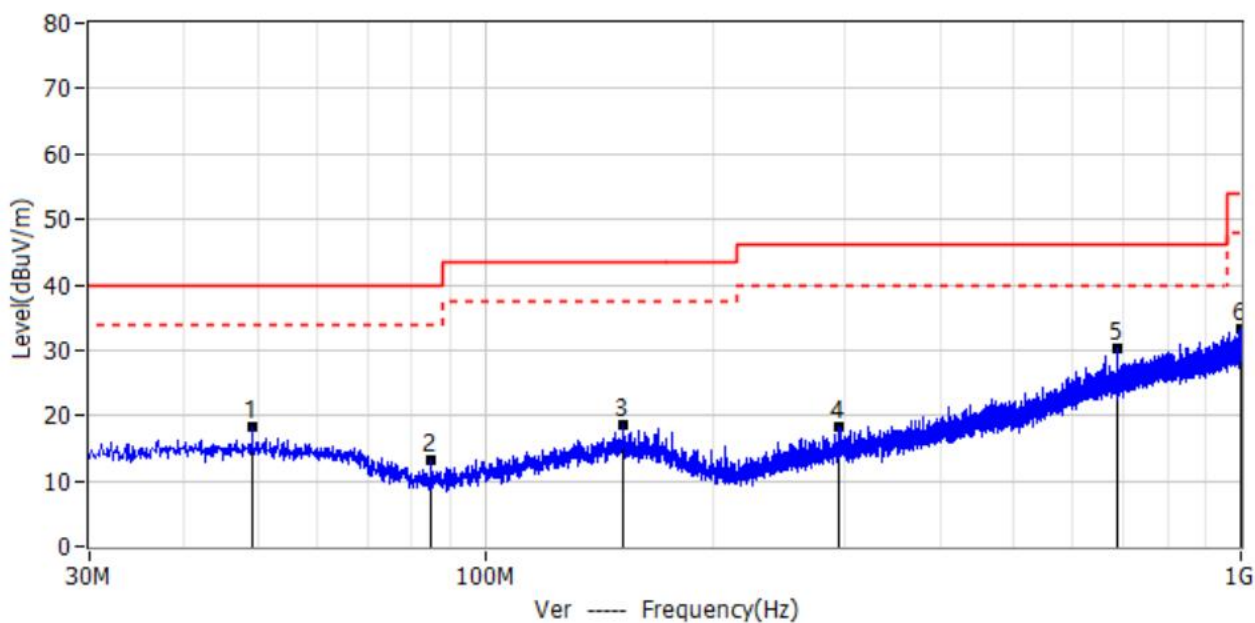

No.	Frequency	Reading dBuV	Factor dB/m	Level dBuV/m	Limit dBuV/m	Margin dB	Detector	Polar
1*	49.279MHz	4.37	13.78	18.15	40.00	-21.85	PK	Ver
2*	85.048MHz	3.55	9.51	13.06	40.00	-26.94	PK	Ver
3*	152.705MHz	4.50	14.20	18.70	43.50	-24.80	PK	Ver
4*	293.476MHz	4.03	14.20	18.23	46.00	-27.77	PK	Ver
5*	687.539MHz	6.81	23.39	30.20	46.00	-15.80	PK	Ver
6*	998.181MHz	5.44	27.87	33.31	54.00	-20.69	PK	Ver



Project: LGT22K038	Test Engineer: Dylan.shi
EUT: WorldPenScan WiFi	Temperature: 27.3°C
M/N: MSE10	Humidity: 56%RH
Test Voltage: Battery 3.8V	Test Data: 2022-11-30
Test Mode: DH5 2402	
Note:	

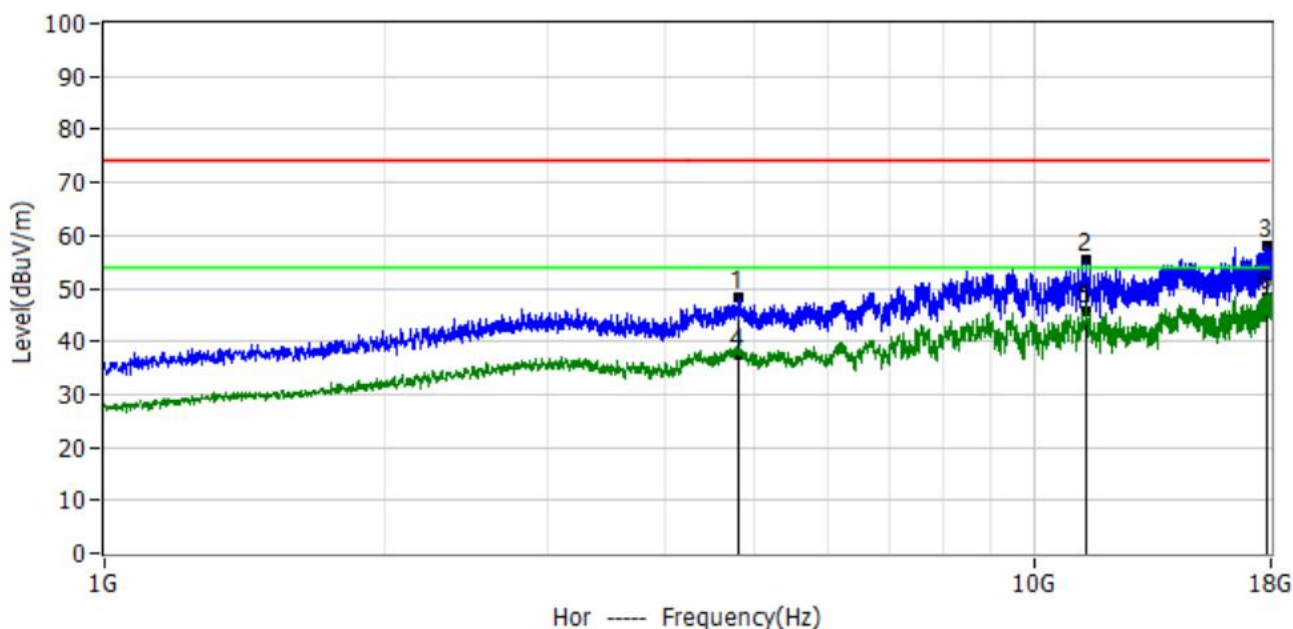

No.	Frequency	Reading dBuV	Factor dB/m	Level dBuV/m	Limit dBuV/m	Margin dB	Detector	Polar
1*	4.821GHz	54.40	-6.00	48.40	74.00	-25.60	PK	Hor
2*	11.391GHz	53.48	1.86	55.34	74.00	-18.66	PK	Hor
3*	17.822GHz	49.47	8.40	57.87	74.00	-16.13	PK	Hor
4*	4.821GHz	43.40	-6.00	37.40	54.00	-16.60	AV	Hor
5*	11.391GHz	43.94	1.86	45.80	54.00	-8.20	AV	Hor
6*	17.822GHz	40.00	8.40	48.40	54.00	-5.60	AV	Hor



Project: LGT22K038	Test Engineer: Dylan.shi
EUT: WorldPenScan WiFi	Temperature: 27.3°C
M/N: MSE10	Humidity: 56%RH
Test Voltage: Battery 3.8V	Test Data: 2022-11-30
Test Mode: DH5 2402	
Note:	

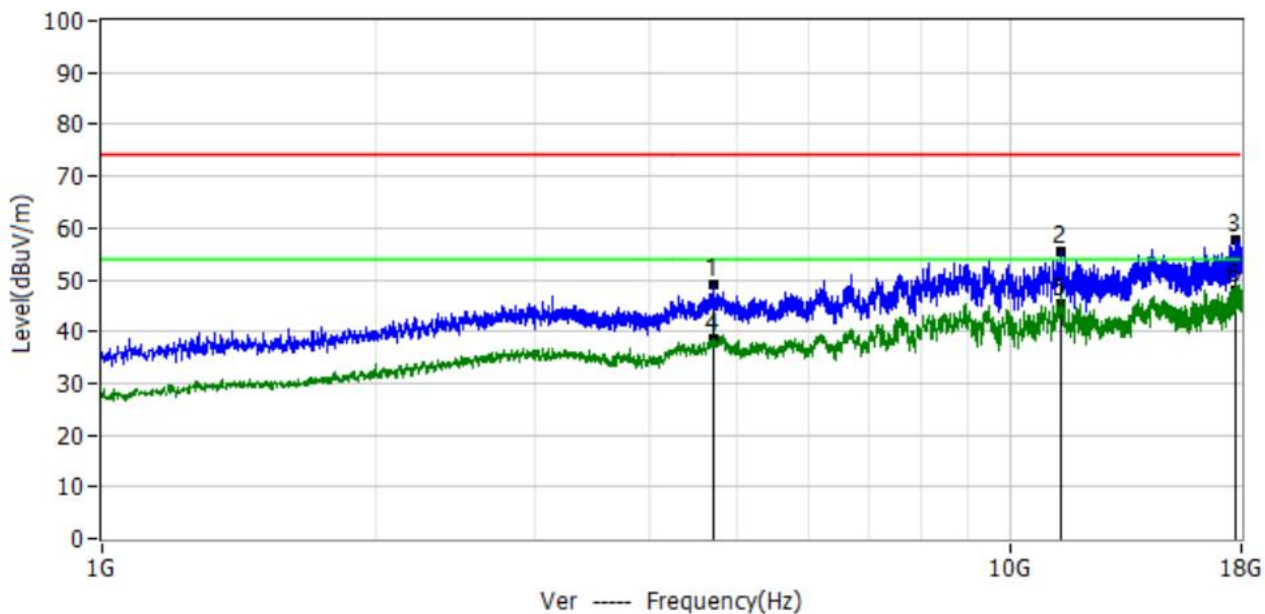

No.	Frequency	Reading dBuV	Factor dB/m	Level dBuV/m	Limit dBuV/m	Margin dB	Detector	Polar
1*	4.712GHz	54.88	-5.92	48.96	74.00	-25.04	PK	Ver
2*	11.391GHz	53.63	1.86	55.49	74.00	-18.51	PK	Ver
3*	17.717GHz	49.32	8.32	57.64	74.00	-16.36	PK	Ver
4*	4.712GHz	44.32	-5.92	38.40	54.00	-15.60	AV	Ver
5*	11.391GHz	43.64	1.86	45.50	54.00	-8.50	AV	Ver
6*	17.717GHz	39.78	8.32	48.10	54.00	-5.90	AV	Ver



Project: LGT22K038	Test Engineer: Dylan.shi
EUT: WorldPenScan WiFi	Temperature: 27.3°C
M/N: MSE10	Humidity: 56%RH
Test Voltage: Battery 3.8V	Test Data: 2022-11-30
Test Mode: DH5 2441	
Note:	

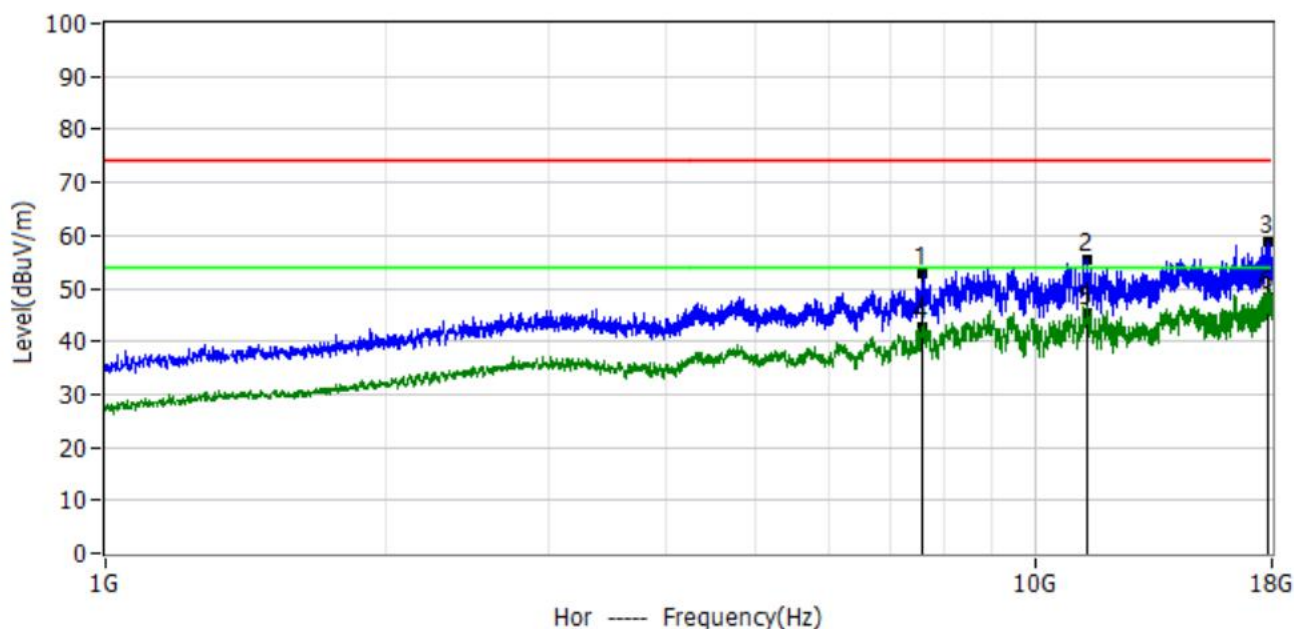

No.	Frequency	Reading dBuV	Factor dB/m	Level dBuV/m	Limit dBuV/m	Margin dB	Detector	Polar
1*	7.585GHz	56.94	-4.24	52.70	74.00	-21.30	PK	Hor
2*	11.383GHz	53.61	1.86	55.47	74.00	-18.53	PK	Hor
3*	17.828GHz	50.52	8.40	58.92	74.00	-15.08	PK	Hor
4*	7.585GHz	46.84	-4.24	42.60	54.00	-11.40	AV	Hor
5*	11.383GHz	43.34	1.86	45.20	54.00	-8.80	AV	Hor
6*	17.828GHz	40.10	8.40	48.50	54.00	-5.50	AV	Hor



Project: LGT22K038	Test Engineer: Dylan.shi
EUT: WorldPenScan WiFi	Temperature: 27.3°C
M/N: MSE10	Humidity: 56%RH
Test Voltage: Battery 3.8V	Test Data: 2022-11-30
Test Mode: DH5 2441	
Note:	

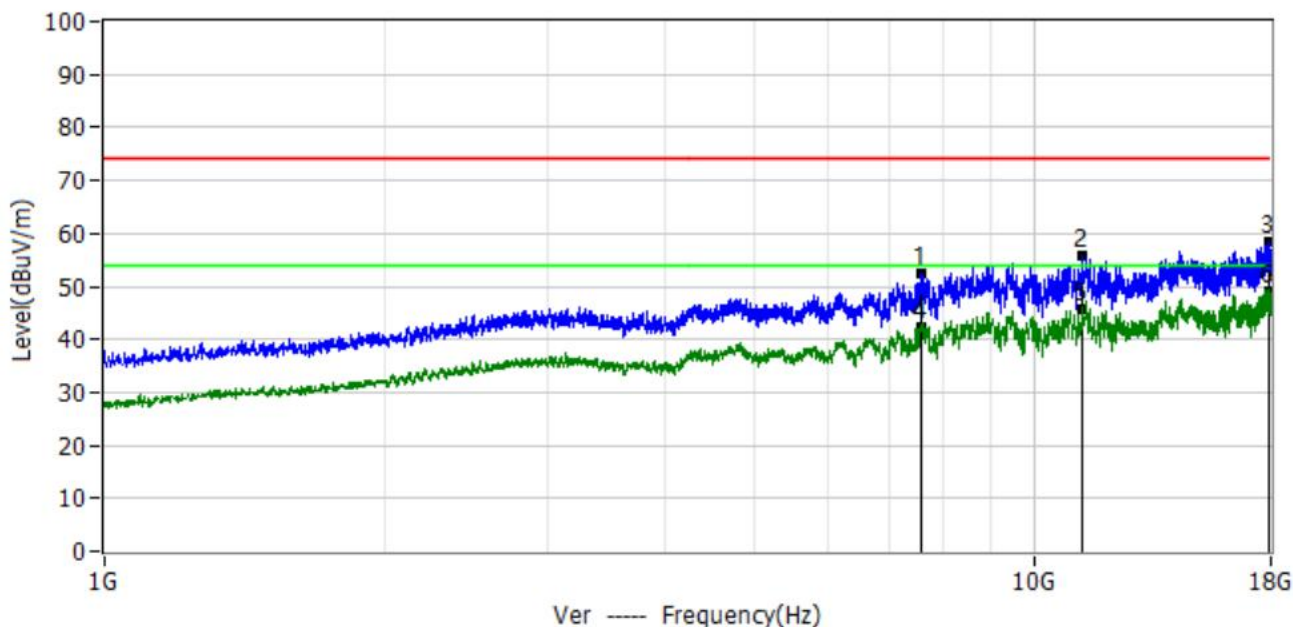

No.	Frequency	Reading dBuV	Factor dB/m	Level dBuV/m	Limit dBuV/m	Margin dB	Detector	Polar
1*	7.577GHz	56.79	-4.25	52.54	74.00	-21.46	PK	Ver
2*	11.270GHz	54.09	1.79	55.88	74.00	-18.12	PK	Ver
3*	17.945GHz	49.78	8.48	58.26	74.00	-15.74	PK	Ver
4*	7.577GHz	46.75	-4.25	42.50	54.00	-11.50	AV	Ver
5*	11.270GHz	44.01	1.79	45.80	54.00	-8.20	AV	Ver
6*	17.945GHz	40.62	8.48	49.10	54.00	-4.90	AV	Ver



Project: LGT22K038	Test Engineer: Dylan.shi
EUT: WorldPenScan WiFi	Temperature: 27.3°C
M/N: MSE10	Humidity: 56%RH
Test Voltage: Battery 3.8V	Test Data: 2022-11-30
Test Mode: DH5 2480	
Note:	

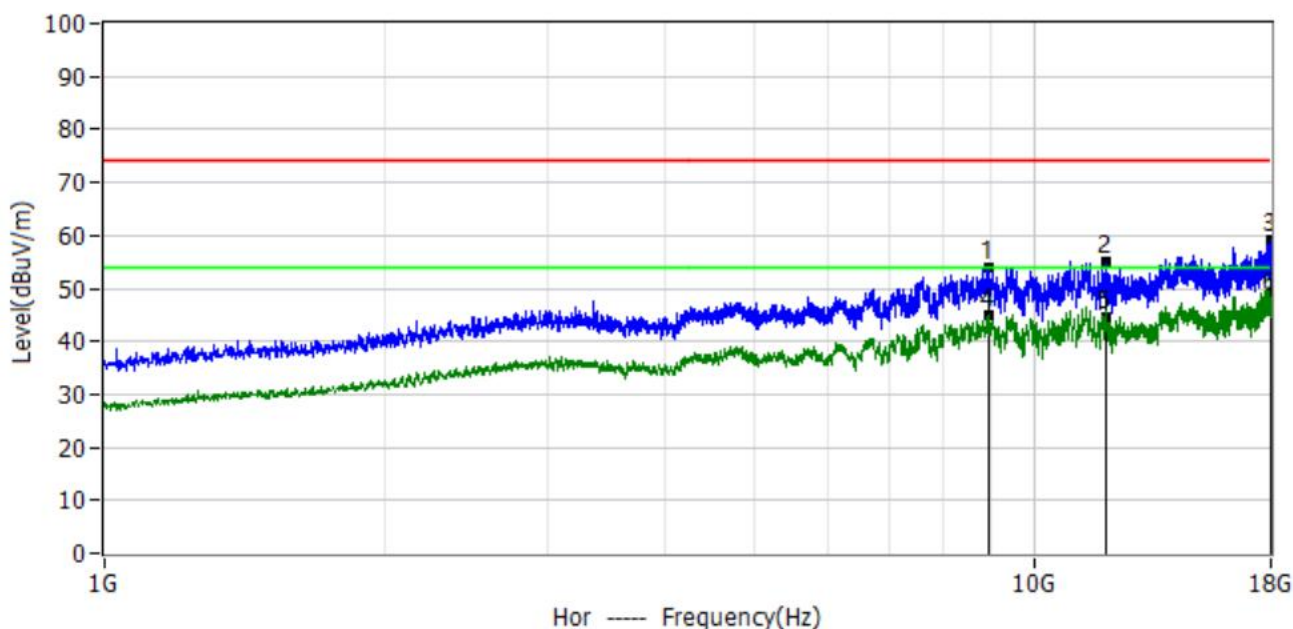

No.	Frequency	Reading dBuV	Factor dB/m	Level dBuV/m	Limit dBuV/m	Margin dB	Detector	Polar
1*	8.928GHz	55.29	-1.37	53.92	74.00	-20.08	PK	Hor
2*	11.952GHz	52.90	2.19	55.09	74.00	-18.91	PK	Hor
3*	17.962GHz	50.68	8.49	59.17	74.00	-14.83	PK	Hor
4*	8.928GHz	46.37	-1.37	45.00	54.00	-9.00	AV	Hor
5*	11.952GHz	42.51	2.19	44.70	54.00	-9.30	AV	Hor
6*	17.962GHz	39.31	8.49	47.80	54.00	-6.20	AV	Hor



Project: LGT22K038	Test Engineer: Dylan.shi
EUT: WorldPenScan WiFi	Temperature: 27.3°C
M/N: MSE10	Humidity: 56%RH
Test Voltage: Battery 3.8V	Test Data: 2022-11-30
Test Mode: DH5 2480	
Note:	

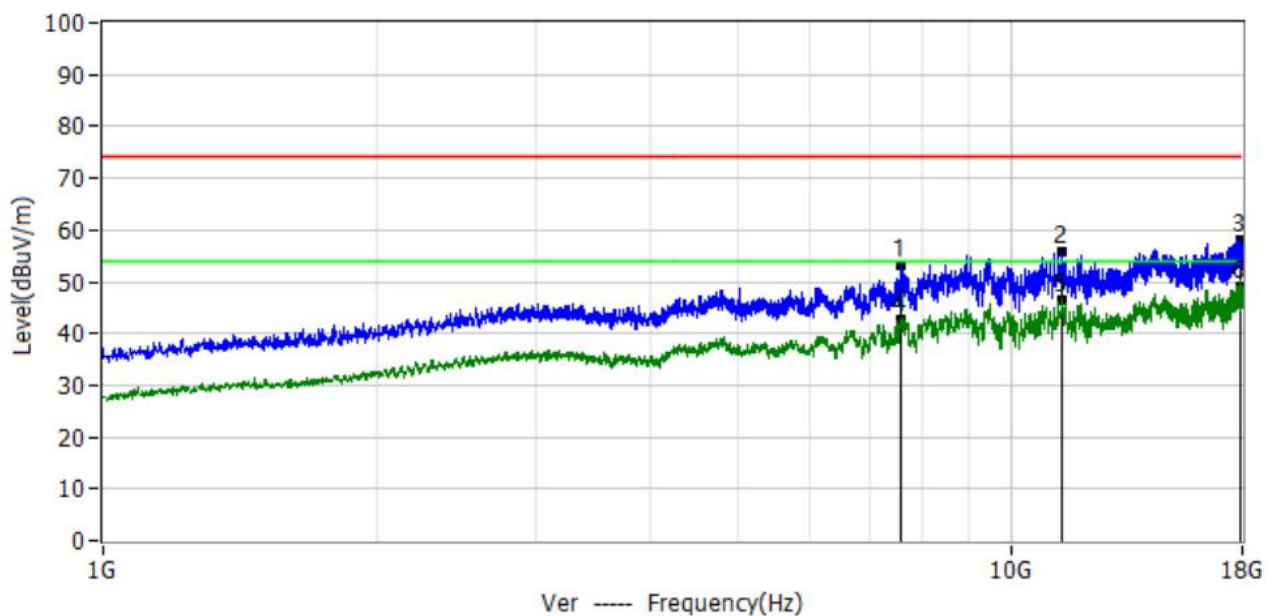

No.	Frequency	Reading dBuV	Factor dB/m	Level dBuV/m	Limit dBuV/m	Margin dB	Detector	Polar
1*	7.581GHz	57.25	-4.25	53.00	74.00	-21.00	PK	Ver
2*	11.389GHz	53.90	1.86	55.76	74.00	-18.24	PK	Ver
3*	17.951GHz	49.57	8.49	58.06	74.00	-15.94	PK	Ver
4*	7.581GHz	46.95	-4.25	42.70	54.00	-11.30	AV	Ver
5*	11.389GHz	44.44	1.86	46.30	54.00	-7.70	AV	Ver
6*	17.951GHz	40.51	8.49	49.00	54.00	-5.00	AV	Ver