



# FCC TEST REPORT

According to

## FCC Rules and Regulations

### Part 15 Subpart C

Applicant	: Billion Electric Co., Ltd.
Address	: 8F., No. 192, Sec. 2, Chung Hsing Road, Hsin Tien City, Taipei Hsien, Taiwan
Equipment	: WLAN-M Edimax IN-7858Mn V1.0 802.11b/g/n 2T3R Mini-PCI+MII HSF
Model No.	: AAZWMNIIN7858MNX00
FCC ID.	: QI3BIL-RT2880MD
Trade Name	: BILLION

Laboratory Accreditation



Testing Laboratory

1332

- The test result refers exclusively to the test presented test model / sample.,
- Without written approval of **CerpPASS Technology Corp.**, the test report shall not be reproduced except in full.
- The EUT is also considered as a kind of computer peripheral, because the connection to computer is necessary for typical use. It has been verified to comply with the requirements of FCC Part 15, Subpart B, Class B (DoC). The test report has been issued separately.



## Contents

<b>1. Report of Measurements and Examinations</b>	<b>5</b>
1.1 List of Measurements and Examinations	5
<b>2. Test Configuration of Equipment under Test</b>	<b>6</b>
2.1 Feature of Equipment under Test	6
2.2 Carrier Frequency of Channels	7
2.3 Test Mode and Test Software	7
2.4 Description of Test System	7
2.5 Connection Diagram of Test System	7
2.6 General Information of Test	8
2.7 Measurement Uncertainty	8
2.8 History of this test report	9
<b>3. Antenna Requirements</b>	<b>10</b>
3.1 Standard Applicable	10
3.2 Antenna Construction and Directional Gain	10
<b>4. Test of Conducted Emission</b>	<b>11</b>
4.1 Test Limit	11
4.2 Test Procedures	11
4.3 Typical Test Setup	12
4.4 Measurement Equipment	12
4.5 Test Result and Data	13
4.6 Test Photographs	19
<b>5. Test of Radiated Emission</b>	<b>20</b>
5.1 Test Limit	20
5.2 Test Procedures	20
5.3 Typical Test Setup	21
5.4 Measurement Equipment	21
5.5 Test Result and Data	22
5.6 Test Photographs	58
<b>6. 6dB Bandwidth Measurement Data</b>	<b>59</b>
6.1 Test Limit	59
6.2 Test Procedures	59
6.3 Test Setup Layout	59
6.4 Measurement Equipment	59
6.5 Test Result and Data	59
<b>7. Maximum Peak Output Power</b>	<b>72</b>
7.1 Test Limit	72
7.2 Test Procedures	72
7.3 Test Setup Layout	72
7.4 Measurement Equipment	72
7.5 Test Result and Data	73
<b>8. Power Spectral Density</b>	<b>86</b>
8.1 Test Limit	86
8.2 Test Procedures	86
8.3 Test Setup Layout	86



8.4 Measurement Equipment..... 86

8.5 Test Result and Data..... 86

**9. Band Edges Measurement..... 99**

9.1 Test Limit ..... 99

9.2 Test Procedure ..... 99

9.3 Test Setup Layout ..... 99

9.4 Measurement Equipment..... 99

9.5 Test Result and Data..... 99

9.6 Restrict Band Emission Measurement Data ..... 116

**10. Restricted Bands of Operation..... 118**

10.1 Labeling Requirement..... 118

**Appendix A. Photographs of EUT.....A1 ~ A3**



# CERTIFICATE OF COMPLIANCE

According to

## FCC Rules and Regulations

### Part 15 Subpart C

Applicant : Billion Electric Co., Ltd.  
Address : 8F., No. 192, Sec. 2, Chung Hsing Road,  
Hsin Tien City, Taipei Hsien, Taiwan  
Equipment : WLAN-M Edimax IN-7858Mn V1.0  
802.11b/g/n 2T3R Mini-PCI+MII HSF  
Model No. : AAZWMNIIN7858MNX00  
FCC ID. : QI3BIL-RT2880MD

I **HEREBY** CERTIFY THAT :

The measurements shown in this test report were made in accordance with the procedures given in **ANSI C63.4** The equipment was **passed** the test performed according to **FCC Rules and Regulations Part 15 Subpart C (2009)**.

The test was carried out on Apr. 21, 2010 at CerpPASS Technology Corp.

Signature

Anson Chou

EMC/RF B.U. Vice General Manager



# 1. Report of Measurements and Examinations

## 1.1 List of Measurements and Examinations

FCC Rule	Description of Test	Result
15.203	. Antenna Requirement	Pass
15.207	. Conducted Emission	Pass
15.209 15.247(d)	. Radiated Emission	Pass
15.247(a)(2)	. 6dB Bandwidth	Pass
15.247(b)	. Maximum Peak Output Power	Pass
15.247(d)	. 100kHz Bandwidth of Frequency Band Edges	Pass
15.247(e)	. Power Spectral Density	Pass
1.1307 1.1310 2.1091 2.1093	. RF Exposure Compliance	Pass



## 2. Test Configuration of Equipment under Test

### 2.1 Feature of Equipment under Test

Standard	IEEE 802.11 b/g and IEEE 802.11n Draft 2.0
Interface Type	Mini-PCI/RGMII/MII
Frequency Band	2.4000~2.4835GHz (Industrial Scientific Medical Band)
Modulation	OFDM with BPSK, QPSK, 16QAM, 64QAM (11n) OFDM with BPSK, QPSK, 16QAM, 64QAM (11g) BPSK, QPSK, CCK (11b)
Data Rate	11n (20MHz): MCS0-15, 32 with Half Guard Interval Support (up to 144Mbps) 11n (40MHz): MCS0-15, 32 with Half Guard Interval Support (up to 300Mbps) 11g: 54/48/36/24/18/12/9/6 Mbps 11b: 11/5.5/2/1Mbps auto fallback
Number of Channels	802.11b/g/n HT20: CH 1 ~ 11 (11channels) 802.11n HT40: CH 3 ~ 9 (7channels)
Antenna	I-PEX Connector x 3 Dipole antenna / antenna gain: 2dBi
OS	Linux Kernel 2.4/2.6
Transmit Power	2.4GHz 802.11b: 18.39 dBm; 802.11g: 16.51 dBm; 802.11n: 17.24 dBm
Receive Sensitivity	2.4GHz -300Mbps OFDM, 10% PER, -65dBm -54Mbps OFDM, 10% PER, -74.5dBm -11Mbps CCK, 8% PER, -89dBm
Dimension	59.75(W) x 54.73(D) x 1.0(H) mm
Temperature	32~122°F (0~50°C)
Humidity	Max.95% (NonCondensing)



### 2.2 Carrier Frequency of Channels

802.11b, 802.11g, 802.11n HT 20

Channel	Frequency(MHz)	Channel	Frequency(MHz)
01	2412	07	2442
02	2417	08	2447
03	2422	09	2452
04	2427	10	2457
05	2432	11	2462
06	2437	---	---

802.11n HT40

Channel	Frequency(MHz)	Channel	Frequency(MHz)
---	---	07	2442
---	---	08	2447
03	2422	09	2452
04	2427	---	---
05	2432	---	---
06	2437	---	---

### 2.3 Test Mode and Test Software

- a. During testing, the interface cables and equipment positions were varied according to ANSI C63.4.
- b. The complete test system included Notebook and EUT for RF test.
- c. An executive program, RT2880\_iNIC\_ATE.exe under WIN XP, which transmits and receives data through Wireless (270Mbps).
- d. The following test modes were performed for test:
  - 802.11b/g/n HT20: CH01: 2412MHz, CH06: 2437MHz, CH11: 2462MHz
  - 802.11n HT40: CH03: 2422MHz, CH06: 2437MHz, CH09: 2452MHz

### 2.4 Description of Test System

Device	Manufacturer	Model No.	Description
Notebook	TOSHIBA	PSA50T-05M00C	Power Cable, Unshielding 1.8 m

### 2.5 Connection Diagram of Test System

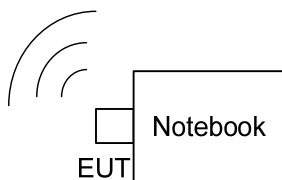

1. The EUT is connected to the Notebook
- \* The EUT keeps to transmit and receive data by Wireless.



## 2.6 General Information of Test

Test Site :	CerpPASS Technology Corp. 2F-11, No. 3, Yuan Qu St., (Nankang Software Park), Taipei, Taiwan 115, R.O.C.
Test Site Location (OATS1-SD):	No. 7-2, Moshihkeng, Fongtian Village, Shihding Township, Taipei County, Taiwan, R.O.C.
FCC Registration Number :	TW1049, TW1056, 982971, 488071
IC Registration Number :	4934C-1, 4934D-1
VCCI Registration Number :	T-543 for Telecommunication Test C-3328 for Conducted emission test R-3013 for Radiated emission test G-97 for Radiated emission test above 1GHz
Test Voltage:	AC 120V / 60Hz
Test in Compliance with:	ANSI C63.4-2003 FCC Part 15 Subpart C
Frequency Range Investigated:	Conducted: from 150kHz to 30MHz Radiation: from 30MHz to 25,000MHz
Test Distance:	The test distance of radiated emission from antenna to EUT is 3 M.

## 2.7 Measurement Uncertainty

Measurement Item	Measurement Frequency	Polarization	Uncertainty
Conducted Emission	9 kHz ~ 30 MHz	LINE/NEUTRAL	2.71 dB
Radiated Emission	30 MHz ~ 25GHz	Vertical	4.11 dB
		Horizontal	4.10 dB
6 dB Bandwidth	---	---	7500 Hz
Maximum Peak Output Power	---	---	1.4 dB
100kHz Bandwidth of Frequency Band Edges	---	---	2.2 dB
Power Spectral Density	---	---	2.2 dB





2.8 History of this test report

■ ORIGINAL.

□ Additional attachment as following record:

Attachment No.	Issue Date	Description



### 3. Antenna Requirements

#### 3.1 Standard Applicable

For intentional device, according to FCC 47 CFR Section 15.203, an intentional radiator shall be designed to ensure that no antenna other than that furnished by the responsible party shall be used with the device.

And according to FCC 47 CFR Section 15.247 (b), if transmitting antennas of directional gain greater than 6dBi are used, the power shall be reduced by the amount in dB that the directional gain of the antenna exceeds 6dBi.

#### 3.2 Antenna Construction and Directional Gain

Ant1, 2

Antenna Type: Dipole antenna

Antenna Gain: 2 dBi

Connector: RP-SMA plug (Reverse Polarity meets FCC part 15. 203 Requirement)



## 4. Test of Conducted Emission

### 4.1 Test Limit

Conducted Emissions were measured from 150 kHz to 30 MHz with a bandwidth of 9 KHz on the 120 VAC power and return leads of the EUT according to the methods defined in ANSI C63.4-2003 Section 3.1. The EUT was placed on a nonmetallic stand in a shielded room 0.8 meters above the ground plane as shown in section 2.2. The interface cables and equipment positioning were varied within limits of reasonable applications to determine the position produced maximum conducted emissions.

Frequency (MHz)	Quasi Peak (dB $\mu$ V)	Average (dB $\mu$ V)
0.15 – 0.5	66-56*	56-46*
0.5 – 5.0	56	46
5.0 – 30.0	60	50

\*Decreases with the logarithm of the frequency.

### 4.2 Test Procedures

- a. The EUT was placed 0.4 meter from the conducting wall of the shielding room was kept at least 80 centimeters from any other grounded conducting surface.
- b. Connect EUT to the power mains through a line impedance stabilization network (LISN).
- c. All the support units are connecting to the other LISN.
- d. The LISN provides 50 ohm coupling impedance for the measuring instrument.
- e. The FCC states that a 50 ohm, 50 micro-Henry LISN should be used.
- f. Both sides of AC line were checked for maximum conducted interference.
- g. The frequency range from 150 kHz to 30 MHz was searched.
- h. Set the test-receiver system to Peak Detect Function and Specified Bandwidth with Maximum Hold Mode.



### 4.3 Typical Test Setup

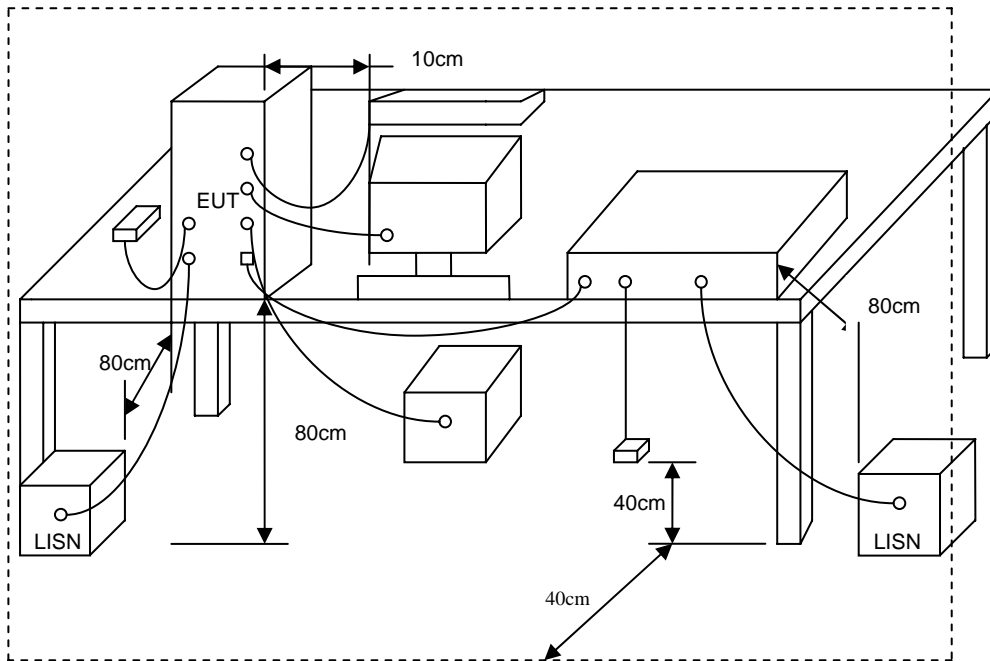

### 4.4 Measurement Equipment

Instrument/ Ancillary	Model No.	Manufacturer	Serial No.	Calibration Date	Valid Date
EMI Receiver	R&S	ESCI	100821	2010/01/21	2011/01/20
LISN	NSLK 8127	Schwarzbeck	8127-516	2009/05/15	2010/05/14
LISN	ROLF HEINE	NNB-2/16Z	02/10191	2009/06/18	2010/06/17



### 4.5 Test Result and Data

Power	: AC 120V	Pol/Phase	: LINE
Test Mode 1	: 802.11g, CH1	Temperature	: 25 °C
Memo	:	Humidity	: 65 %

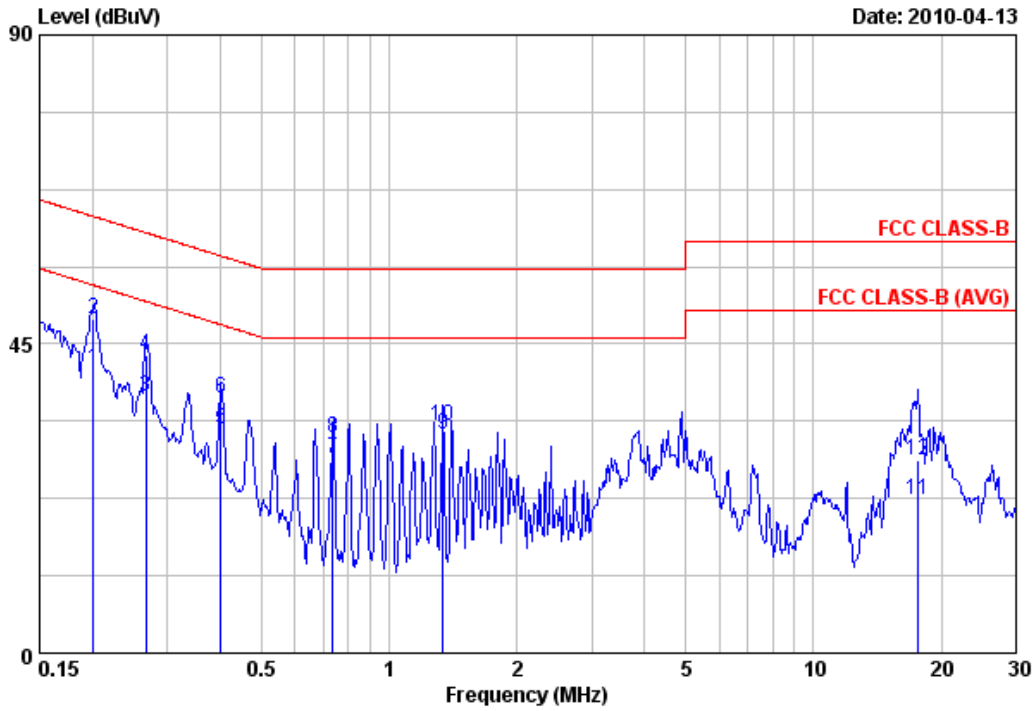

Item	Freq	Read Value	Factor	Result	Limit	Margin	Remark
	MHz	dBuV	dB/m	dBuV/m	dBuV/m	dB	
1	0.20	41.17	0.07	41.24	66.00	-24.76	Average
2	0.20	48.66	0.07	48.73	63.58	-14.85	QP
3	0.27	37.20	0.07	37.27	66.00	-28.73	Average
4	0.27	43.35	0.07	43.42	61.20	-17.78	QP
5	0.40	32.61	0.08	32.69	66.00	-33.31	Average
6	0.40	37.12	0.08	37.20	57.81	-20.61	QP
7	0.74	28.19	0.09	28.28	60.00	-31.72	Average
8	0.74	31.29	0.09	31.38	56.00	-24.62	QP
9	1.34	31.84	0.12	31.96	60.00	-28.04	Average
10	1.34	32.97	0.12	33.09	56.00	-22.91	QP
11	17.66	21.90	0.51	22.41	60.00	-37.59	Average
12	17.66	27.54	0.51	28.05	60.00	-31.95	QP

Notes:

1. Result = Read Value + Factor
2. Factor = LISN Factor + Cable Loss
3. All emission below 1GHz at 802.11g/n mode are all the same,so the 802.11g/n mode chosen as representative in final test.
4. According to technical experiences,all spurious emission of 802.11g/n mode at channel 1,6,11 or 3,6,9(for HT40) are almost the same below 1GHz,so that the channel 1 or 3(for HT40)was chosen as representative in final test.
5. The data is worse case.



Power	: AC 120V	Pol/Phase	: NEUTRAL
Test Mode 1	: 802.11g, CH1	Temperature	: 25 °C
Memo	:	Humidity	: 65 %

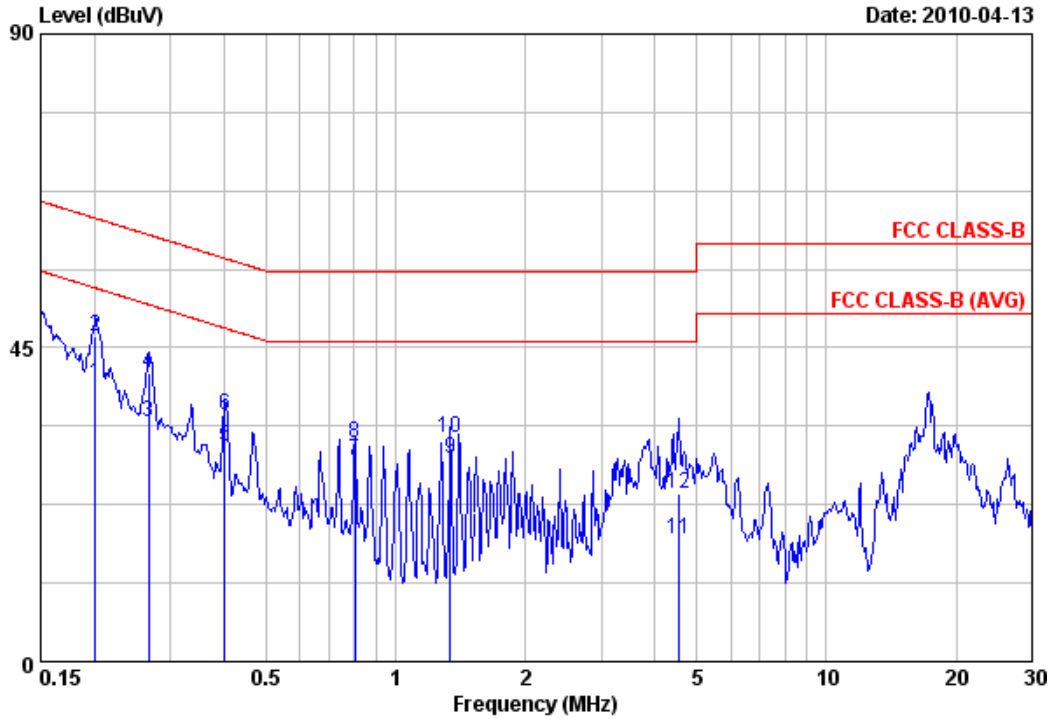

Item	Freq	Read Value	Factor	Result	Limit	Margin	Remark
	MHz	dBuV	dB/m	dBuV/m	dBuV/m	dB	
1	0.20	39.77	0.07	39.84	53.58	-13.74	Average
2	0.20	46.51	0.07	46.58	63.58	-17.00	QP
3	0.27	34.23	0.07	34.30	51.20	-16.90	Average
4	0.27	41.39	0.07	41.46	61.20	-19.74	QP
5	0.40	30.74	0.08	30.82	47.81	-16.99	Average
6	0.40	35.33	0.08	35.41	57.81	-22.40	QP
7	0.80	28.74	0.10	28.84	46.00	-17.16	Average
8	0.80	31.20	0.10	31.30	56.00	-24.70	QP
9	1.34	29.00	0.11	29.11	46.00	-16.89	Average
10	1.34	31.95	0.11	32.06	56.00	-23.94	QP
11	4.53	17.45	0.21	17.66	46.00	-28.34	Average
12	4.53	23.87	0.21	24.08	56.00	-31.92	QP

Notes:

1. Result = Read Value + Factor
2. Factor = LISN Factor + Cable Loss
3. All emission below 1GHz at 802.11g/n mode are all the same,so the 802.11g/n mode chosen as representative in final test.
4. According to technical experiences,all spurious emission of 802.11g/n mode at channel 1,6,11 or 3,6,9(for HT40) are almost the same below 1GHz,so that the channel 1 or 3(for HT40)was chosen as representative in final test.
5. The data is worse case.



Power	: AC 120V	Pol/Phase	: LINE
Test Mode 2	: 802.11n HT20, CH1	Temperature	: 25 °C
Memo	:	Humidity	: 65 %

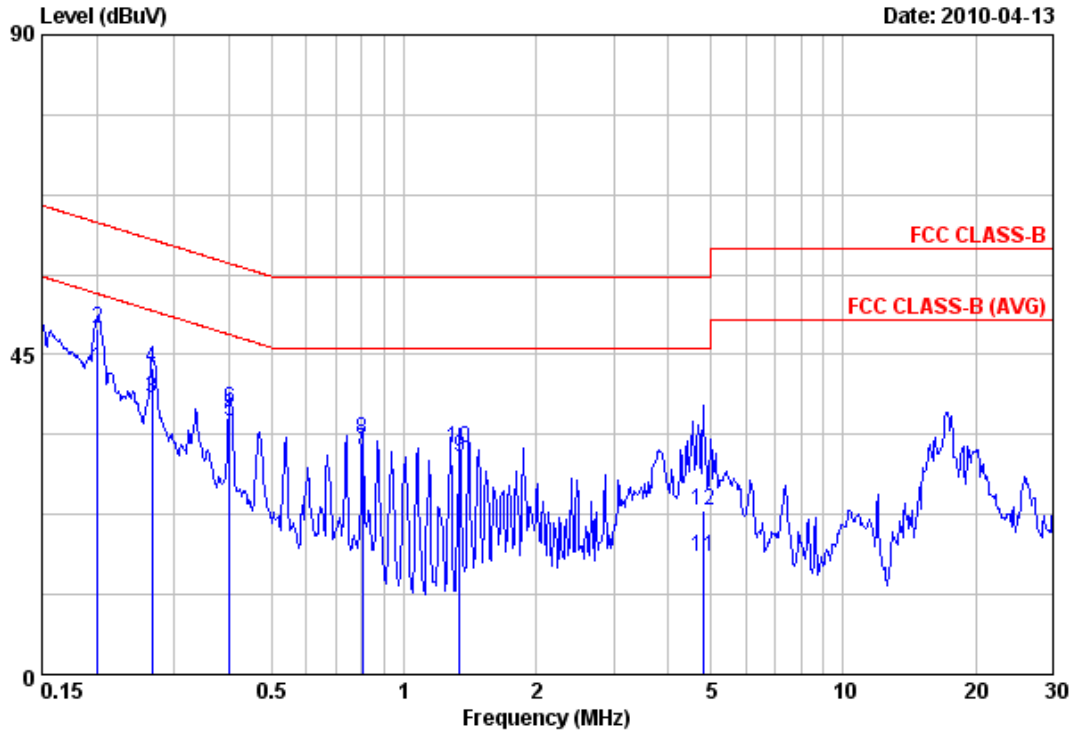

Item	Freq	Read Value	Factor	Result	Limit	Margin	Remark
	MHz	dBuV	dB/m	dBuV/m	dBuV/m	dB	
1	0.20	43.02	0.07	43.09	53.58	-10.49	Average
2	0.20	48.48	0.07	48.55	63.58	-15.03	QP
3	0.27	38.91	0.07	38.98	51.20	-12.22	Average
4	0.27	43.17	0.07	43.24	61.20	-17.96	QP
5	0.40	35.63	0.08	35.71	47.81	-12.10	Average
6	0.40	37.30	0.08	37.38	57.81	-20.43	QP
7	0.80	31.50	0.10	31.60	46.00	-14.40	Average
8	0.80	33.04	0.10	33.14	56.00	-22.86	QP
9	1.34	30.56	0.12	30.68	46.00	-15.32	Average
10	1.34	31.82	0.12	31.94	56.00	-24.06	QP
11	4.80	16.37	0.27	16.64	46.00	-29.36	Average
12	4.80	22.70	0.27	22.97	56.00	-33.03	QP

Notes:

1. Result = Read Value + Factor
2. Factor = LISN Factor + Cable Loss
3. All emission below 1GHz at 802.11b/g/n mode are all the same,so the 802.11g/n mode chosen as representative in final test.
4. According to technical experiences,all spurious emission of 802.11g/n mode at channel 1,6,11 or 3,6,9(for HT40) are almost the same below 1GHz,so that the channel 1 or 3(for HT40)was chosen as representative in final test.
5. The data is worse case.



Power	: AC 120V	Pol/Phase	: NEUTRAL
Test Mode 2	: 802.11n HT20, CH1	Temperature	: 25 °C
Memo	:	Humidity	: 65 %

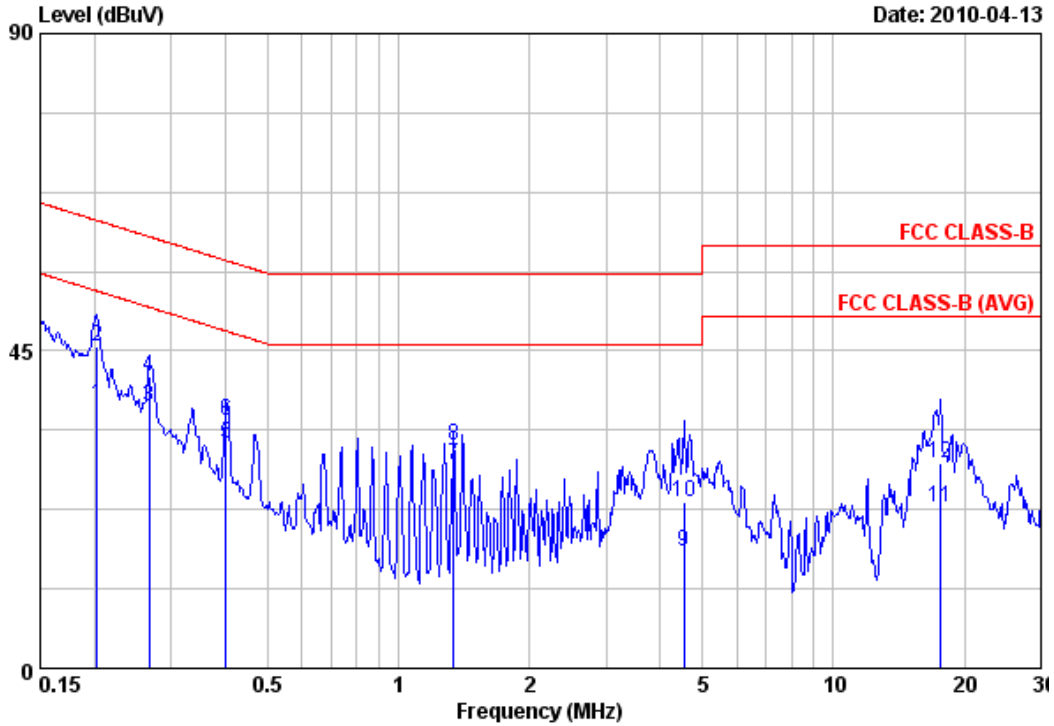

Item	Freq	Read Value	Factor	Result	Limit	Margin	Remark
	MHz	dBuV	dB/m	dBuV/m	dBuV/m	dB	
1	0.20	37.16	0.07	37.23	53.49	-16.26	Average
2	0.20	45.61	0.07	45.68	63.49	-17.81	QP
3	0.27	37.14	0.07	37.21	51.20	-13.99	Average
4	0.27	41.36	0.07	41.43	61.20	-19.77	QP
5	0.40	31.86	0.08	31.94	47.81	-15.87	Average
6	0.40	35.00	0.08	35.08	57.81	-22.73	QP
7	1.34	28.71	0.11	28.82	46.00	-17.18	Average
8	1.34	31.59	0.11	31.70	56.00	-24.30	QP
9	4.53	16.33	0.21	16.54	46.00	-29.46	Average
10	4.53	23.38	0.21	23.59	56.00	-32.41	QP
11	17.59	22.44	0.49	22.93	50.00	-27.07	Average
12	17.59	28.65	0.49	29.14	60.00	-30.86	QP

Notes:

1. Result = Read Value + Factor
2. Factor = LISN Factor + Cable Loss
3. All emission below 1GHz at 802.11b/g/n mode are all the same,so the 802.11g/n mode chosen as representative in final test.
4. According to technical experiences,all spurious emission of 802.11g/n mode at channel 1,6,11 or 3,6,9(for HT40) are almost the same below 1GHz,so that the channel 1 or 3(for HT40)was chosen as representative in final test.
5. The data is worse case.





Power	: AC 120V	Pol/Phase	: LINE
Test Mode 3	: 802.11n HT40, CH3	Temperature	: 25 °C
Memo	:	Humidity	: 65 %

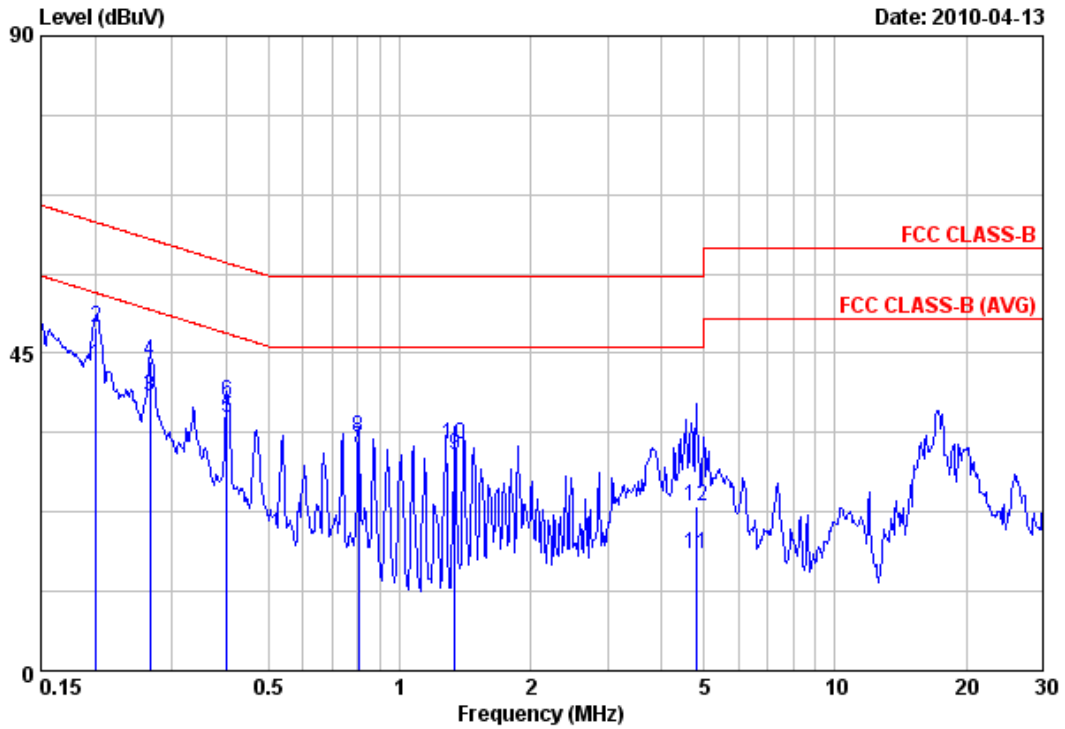

Item	Freq	Read Value	Factor	Result	Limit	Margin	Remark
	MHz	dBuV	dB/m	dBuV/m	dBuV/m	dB	
1	0.20	43.19	0.07	43.26	53.58	-10.32	Average
2	0.20	48.50	0.07	48.57	63.58	-15.01	QP
3	0.27	38.84	0.07	38.91	51.20	-12.29	Average
4	0.27	43.68	0.07	43.75	61.20	-17.45	QP
5	0.40	35.69	0.08	35.77	47.81	-12.04	Average
6	0.40	37.96	0.08	38.04	57.81	-19.77	QP
7	0.80	31.51	0.10	31.61	46.00	-14.39	Average
8	0.80	33.05	0.10	33.15	56.00	-22.85	QP
9	1.34	30.59	0.12	30.71	46.00	-15.29	Average
10	1.34	31.87	0.12	31.99	56.00	-24.01	QP
11	4.80	16.34	0.27	16.61	46.00	-29.39	Average
12	4.80	23.00	0.27	23.27	56.00	-32.73	QP

Notes:

1. Result = Read Value + Factor
2. Factor = LISN Factor + Cable Loss
3. All emission below 1GHz at 802.11b/g/n mode are all the same, so the 802.11g/n mode chosen as representative in final test.
4. According to technical experiences, all spurious emission of 802.11g/n mode at channel 1,6,11 or 3,6,9(for HT40) are almost the same below 1GHz, so that the channel 1 or 3(for HT40) was chosen as representative in final test.
5. The data is worse case.



Power	: AC 120V	Pol/Phase	: NEUTRAL
Test Mode 3	: 802.11n HT40, CH3	Temperature	: 25 °C
Memo	:	Humidity	: 65 %

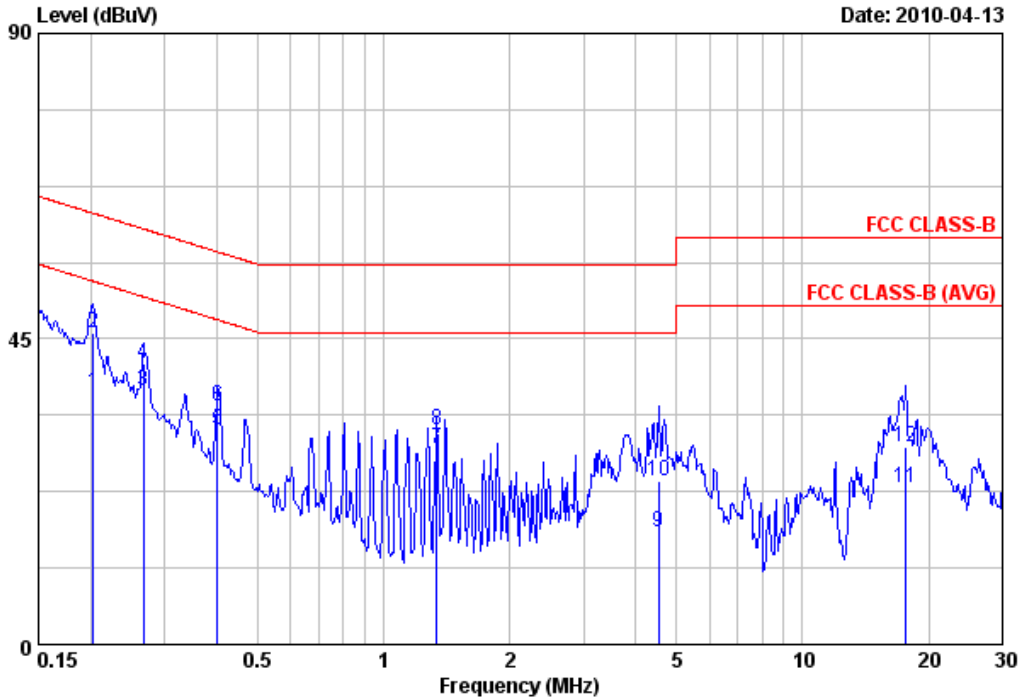

Item	Freq	Read Value	Factor	Result	Limit	Margin	Remark
	MHz	dBuV	dB/m	dBuV/m	dBuV/m	dB	
1	0.20	37.13	0.07	37.20	53.49	-16.29	Average
2	0.20	45.69	0.07	45.76	63.49	-17.73	QP
3	0.27	37.39	0.07	37.46	51.20	-13.74	Average
4	0.27	41.39	0.07	41.46	61.20	-19.74	QP
5	0.40	31.62	0.08	31.70	47.81	-16.11	Average
6	0.40	34.98	0.08	35.06	57.81	-22.75	QP
7	1.34	28.61	0.11	28.72	46.00	-17.28	Average
8	1.34	31.53	0.11	31.64	56.00	-24.36	QP
9	4.53	16.33	0.21	16.54	46.00	-29.46	Average
10	4.53	23.77	0.21	23.98	56.00	-32.02	QP
11	17.59	22.48	0.49	22.97	50.00	-27.03	Average
12	17.59	28.66	0.49	29.15	60.00	-30.85	QP

Notes:

1. Result = Read Value + Factor
2. Factor = LISN Factor + Cable Loss
3. All emission below 1GHz at 802.11b/g/n mode are all the same,so the 802.11g/n mode chosen as representative in final test.
4. According to technical experiences,all spurious emission of 802.11g/n mode at channel 1,6,11 or 3,6,9(for HT40) are almost the same below 1GHz,so that the channel 1 or 3(for HT40)was chosen as representative in final test.
5. The data is worse case.

Test engineer: Ben



#### 4.6 Test Photographs

Front View



Rear View





## 5. Test of Radiated Emission

### 5.1 Test Limit

Radiated emissions from 30 MHz to 25 GHz were measured according to the methods defines in ANSI C63.4-2003. The EUT was placed, 0.8 meter above the ground plane, as shown in section 5.6.3. The interface cables and equipment positions were varied within limits of reasonable applications to determine the positions producing maximum radiated emissions for unintentional device, according to § 15.109(a), except for Class A digital devices, the field strength of radiated emissions from unintentional radiators at a distance of 3 meters shall not exceed the following values:

Frequency (MHz)	Distance Meters	Radiated ( $\mu$ V / M)	Radiated (dB $\mu$ V / M)
30-88	3	100	40.0
88-216	3	150	43.5
216-960	3	200	46.0
Above 960	3	500	54.0

For unintentional device, according to CISPR PUB.22, for Class B digital devices, the general requirement of field strength of radiated emissions from intentional radiators at a distance of 10 meters shall not exceed the below table.

Frequency (MHz)	Distance Meters	Radiated (dB $\mu$ V / M)
30-230	10	30
230-1000	10	37

### 5.2 Test Procedures

- The EUT was placed on a rotatable table top 0.8 meter above ground.
- The EUT was set 3 meters from the interference receiving antenna which was mounted on the top of a variable height antenna tower.
- The table was rotated 360 degrees to determine the position of the highest radiation.
- The antenna is a broadband antenna and its height is varied between one meter and four meters above ground to find the maximum value of the field strength both horizontal polarization and vertical polarization of the antenna are set to make the measurement.
- For each suspected emission the EUT was arranged to its worst case and then tune the antenna tower (from 1 M to 4 M) and turn table (from 0 degree to 360 degrees) to find the maximum reading.
- Set the test-receiver system to Peak or CISPR quasi-peak Detect Function and specified bandwidth with Maximum Hold Mode.
- If the emission level of the EUT in peak mode was 3 dB lower than the limit specified, then testing will be stopped and peak values of EUT will be reported, otherwise, the emissions which do not have 3 dB margin will be repeated one by one using the quasi-peak method and reported.
- For testing above 1GHz, the emission level of the EUT in peak mode was 20dB lower than average limit (that means the emission level in peak mode also complies with the limit in average mode), then testing will be stopped and peak values of EUT will be reported, otherwise, the emissions will be measured in average mode again and reported.
- "Cone of radiation" has been considered to be 3dB bandwidth of the measurement antenna.



### 5.3 Typical Test Setup

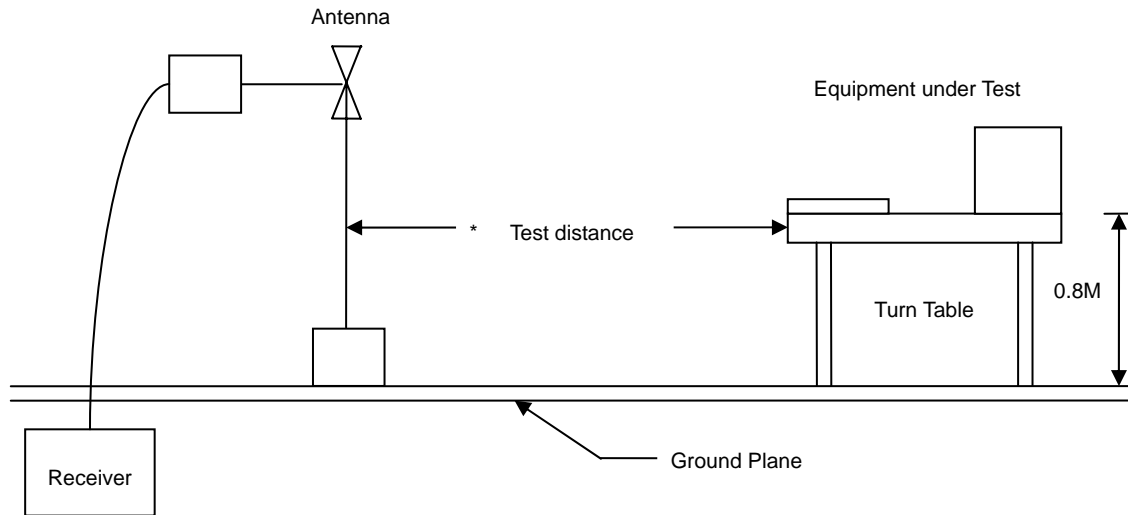

### 5.4 Measurement Equipment

Instrument/Ancillary	Manufacturer	Model No.	Serial No.	Calibration Date	Valid Date
Bilog Antenna	Schaffner	CBL6112B	2840	2009/05/14	2010/05/13
EMI Receiver	R&S	ESCI	100821	2010/01/21	2011/01/20
Amplifier	Agilent	8447D	2944A10593	2009/05/21	2010/05/20
AC Power Converter	APC	AFC-11005	F103120008	N/A	N/A
Spectrum Analyzer	R&S	FSP40	100219	2009/11/20	2010/11/19
Horn Antenna	EMCO	3115	31589	2009/05/04	2010/05/03
Preamplifier	AGILENT	8449B	3008A01954	2010/02/26	2011/02/25



### 5.5 Test Result and Data

Power	: AC 120V	Pol/Phase	: VERTICAL
Test Mode 1	: 802.11g, CH1	Temperature	: 26 °C
Memo	:	Humidity	: 61 %

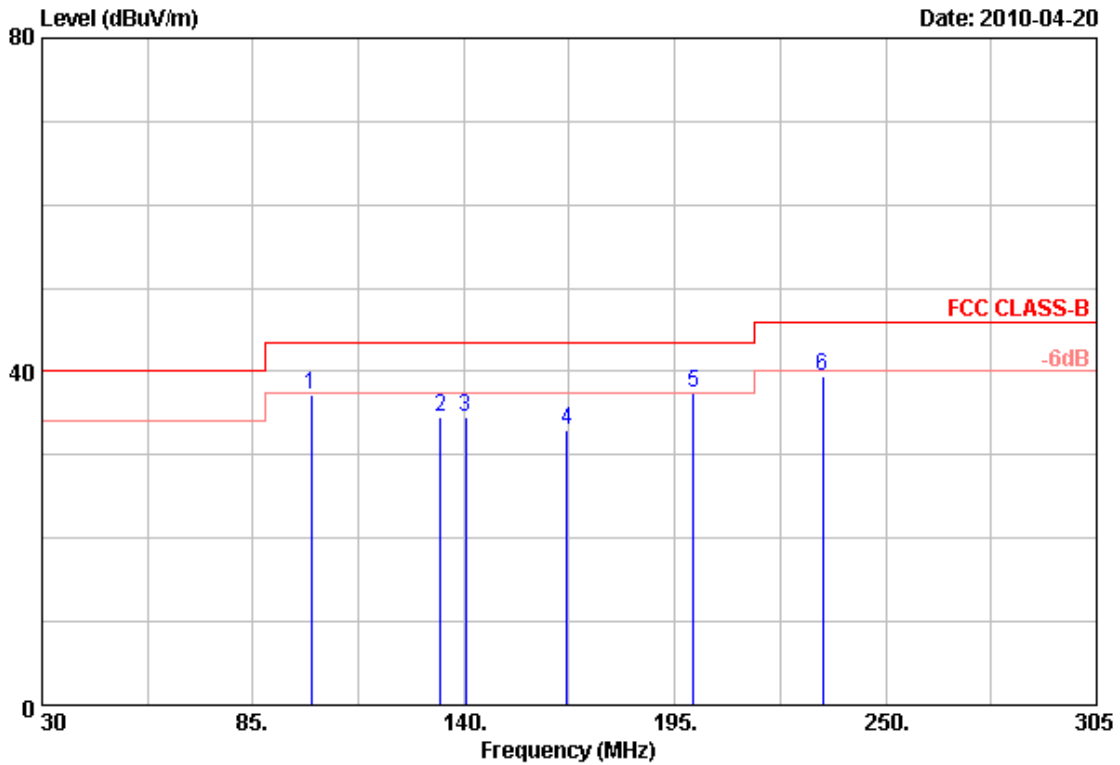

Item	Freq	Read Value	Factor	Result	Limit	Margin	Remark	Ant Pos	Tab Pos
	MHz	dBuV	dB/m	dBuV/m	dBuV/m	dB		cm	Deg
1	100.13	58.91	-21.62	37.29	43.50	-6.21	Peak	100	360
2	133.95	54.17	-19.67	34.50	43.50	-9.00	Peak	100	360
3	140.55	55.67	-21.18	34.49	43.50	-9.01	Peak	100	360
4	166.95	55.17	-22.12	33.05	43.50	-10.45	Peak	100	360
5	199.95	56.85	-19.51	37.34	43.50	-6.16	Peak	100	360
6	233.50	61.17	-21.69	39.48	46.00	-6.52	Peak	100	360

Notes:

1. Result = Read Value + Factor
2. Factor = Antenna Factor + Cable Loss - Amplifier
3. The resolution bandwidth of test receiver/spectrum analyzer is 120KHz and video bandwidth is 300kHz for Peak detection and Quasi-peak detection at frequency below 1GHz.
4. All emission below 1GHz at 802.11b/g/n mode are all the same,so the 802.11g/n mode chosen as representative in final test.
5. According to technical experiences,all spurious emission of 802.11g/n mode at channel 1,6,11 or 3,6,9(for HT40) are almost the same below 1GHz,so that the channel 1 or 3(for HT40)was chosen as representative in final test.
6. The data is worse case.



Power	: AC 120V	Pol/Phase	: VERTICAL
Test Mode 1	: 802.11g, CH1	Temperature	: 26 °C
Memo	:	Humidity	: 61 %

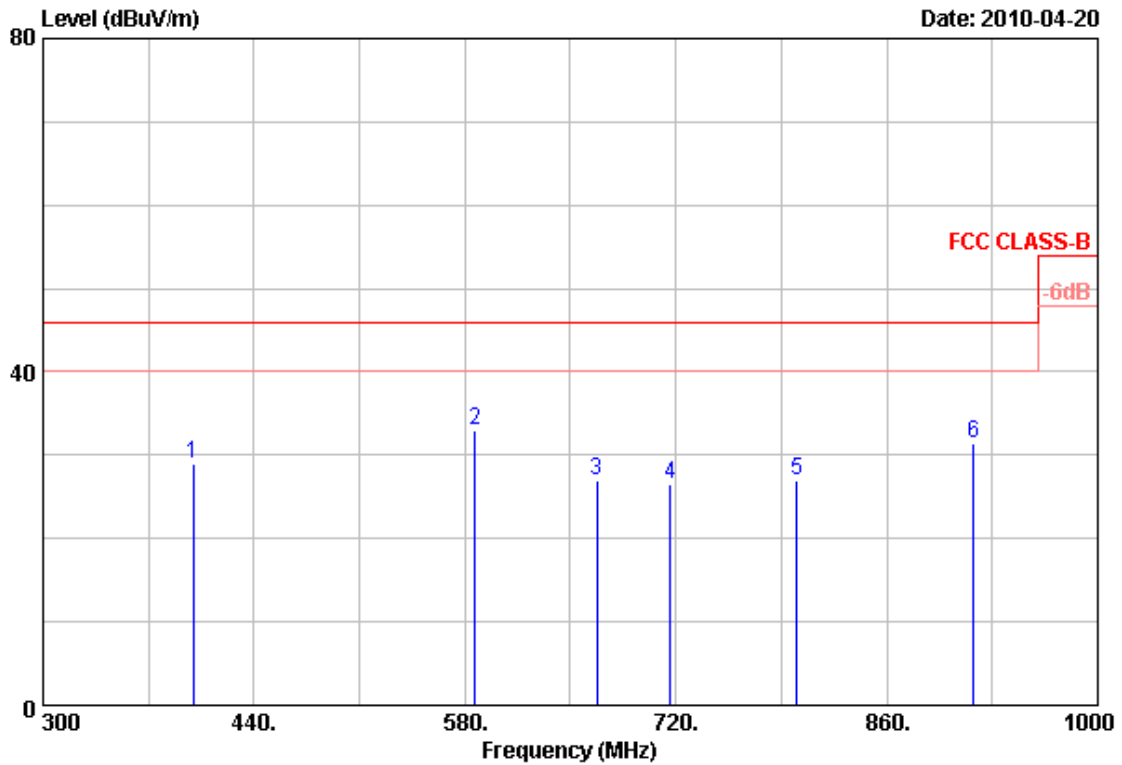

Item	Freq	Read Value	Factor	Result	Limit	Margin	Remark	Ant Pos	Tab Pos
	MHz	dBuV	dB/m	dBuV/m	dBuV/m	dB		cm	Deg
1	399.40	45.90	-16.97	28.93	46.00	-17.07	Peak	100	0
2	587.00	47.82	-14.86	32.96	46.00	-13.04	Peak	100	0
3	667.50	40.98	-13.94	27.04	46.00	-18.96	Peak	100	0
4	716.50	39.20	-12.59	26.61	46.00	-19.39	Peak	100	0
5	800.50	38.08	-11.09	26.99	46.00	-19.01	Peak	100	0
6	917.40	37.19	-5.88	31.31	46.00	-14.69	Peak	100	0

Notes:

1. Result = Read Value + Factor
2. Factor = Antenna Factor + Cable Loss - Amplifier
3. The resolution bandwidth of test receiver/spectrum analyzer is 120KHz and video bandwidth is 300kHz for Peak detection and Quasi-peak detection at frequency below 1GHz.
4. All emission below 1GHz at 802.11g/n mode are all the same,so the 802.11g/n mode chosen as representative in final test.
5. According to technical experiences,all spurious emission of 802.11g/n mode at channel 1,6,11 or 3,6,9(for HT40) are almost the same below 1GHz,so that the channel 1 or 3(for HT40)was chosen as representative in final test.
6. The data is worse case.





Power	: AC 120V	Pol/Phase	: HORIZONTAL
Test Mode 1	: 802.11g, CH1	Temperature	: 26 °C
Memo	:	Humidity	: 61 %

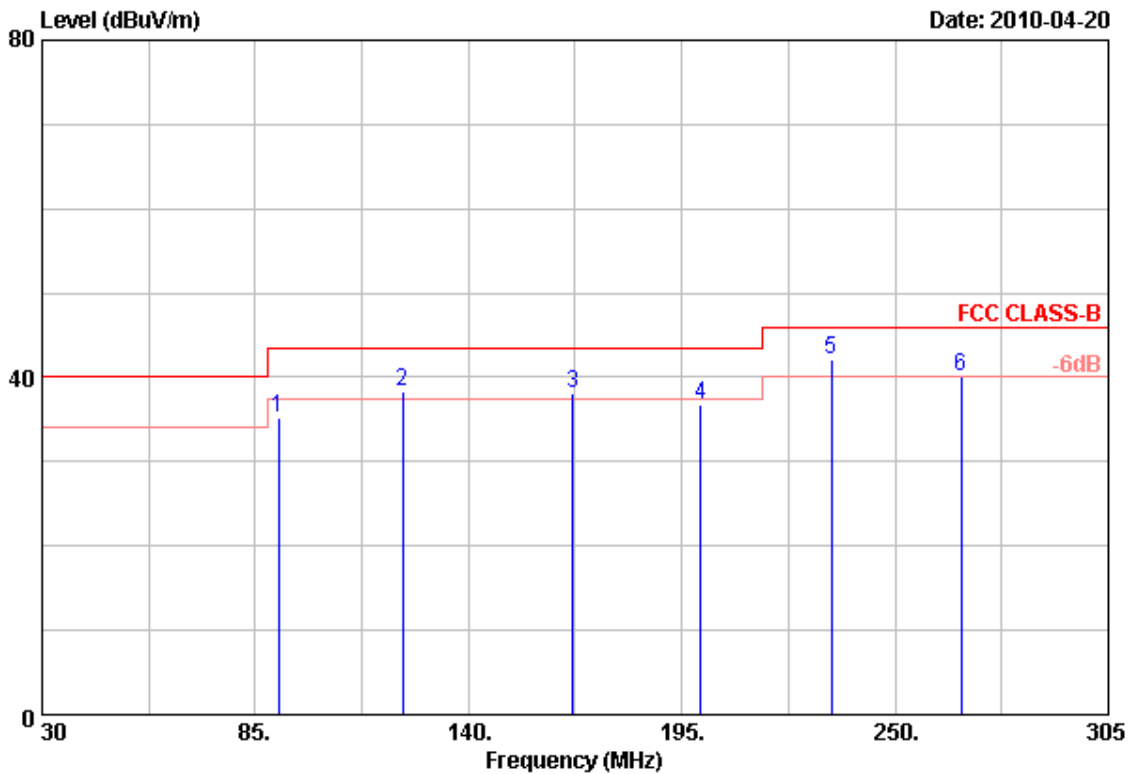

Item	Freq	Read Value	Factor	Result	Limit	Margin	Remark	Ant Pos	Tab Pos
	MHz	dBuV	dB/m	dBuV/m	dBuV/m	dB		cm	Deg
1	91.05	64.92	-29.78	35.14	43.50	-8.36	Peak	100	360
2	122.95	65.29	-26.85	38.44	43.50	-5.06	QP	100	360
3	166.95	65.39	-27.25	38.14	43.50	-5.36	QP	100	360
4	199.95	64.12	-27.25	36.87	43.50	-6.63	Peak	100	360
5	233.50	68.25	-26.10	42.15	46.00	-3.85	QP	100	360
6	267.05	63.56	-23.53	40.03	46.00	-5.97	QP	100	360

Notes:

1. Result = Read Value + Factor
2. Factor = Antenna Factor + Cable Loss - Amplifier
3. The resolution bandwidth of test receiver/spectrum analyzer is 120KHz and video bandwidth is 300kHz for Peak detection and Quasi-peak detection at frequency below 1GHz.
4. All emission below 1GHz at 802.11b/g/n mode are all the same,so the 802.11g/n mode chosen as representative in final test.
5. According to technical experiences,all spurious emission of 802.11g/n mode at channel 1,6,11 or 3,6,9(for HT40) are almost the same below 1GHz,so that the channel 1 or 3(for HT40)was chosen as representative in final test.
6. The data is worse case.





Power	: AC 120V	Pol/Phase	: HORIZONTAL
Test Mode 1	: 802.11g, CH1	Temperature	: 26 °C
Memo	:	Humidity	: 61 %

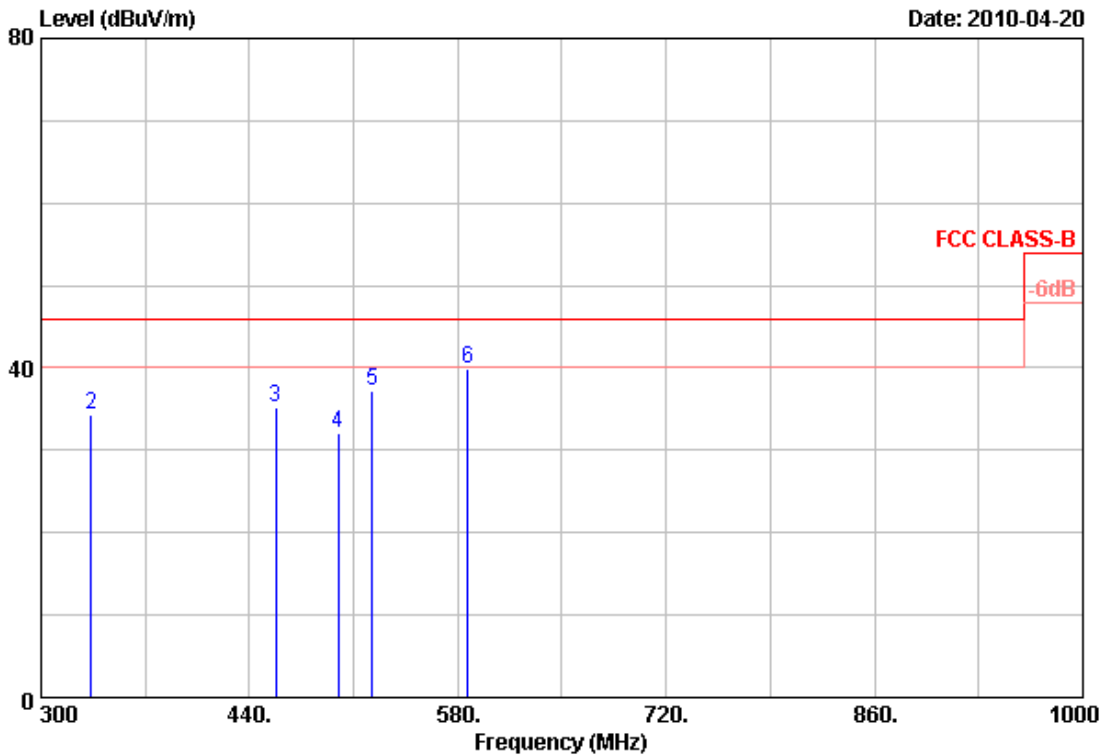

Item	Freq	Read Value	Factor	Result	Limit	Margin	Remark	Ant Pos	Tab Pos
	MHz	dBuV	dB/m	dBuV/m	dBuV/m	dB		cm	Deg
1	300.00	59.67	-23.01	36.66	46.00	-9.34	Peak	100	0
2	333.60	55.89	-21.56	34.33	46.00	-11.67	Peak	100	0
3	457.50	50.46	-15.28	35.18	46.00	-10.82	Peak	100	0
4	499.50	47.50	-15.42	32.08	46.00	-13.92	Peak	100	0
5	522.60	53.33	-16.07	37.26	46.00	-8.74	Peak	100	0
6	587.00	51.84	-12.05	39.79	46.00	-6.21	Peak	100	0

Notes:

1. Result = Read Value + Factor
2. Factor = Antenna Factor + Cable Loss - Amplifier
3. The resolution bandwidth of test receiver/spectrum analyzer is 120KHz and video bandwidth is 300kHz for Peak detection and Quasi-peak detection at frequency below 1GHz.
4. All emission below 1GHz at 802.11g/n mode are all the same,so the 802.11g/n mode chosen as representative in final test.
5. According to technical experiences,all spurious emission of 802.11g/n mode at channel 1,6,11 or 3,6,9(for HT40) are almost the same below 1GHz,so that the channel 1 or 3(for HT40)was chosen as representative in final test.
6. The data is worse case.



Power	: AC 120V	Pol/Phase	: VERTICAL
Test Mode 1	: 802.11b, CH1	Temperature	: 26 °C
Memo	:	Humidity	: 61 %

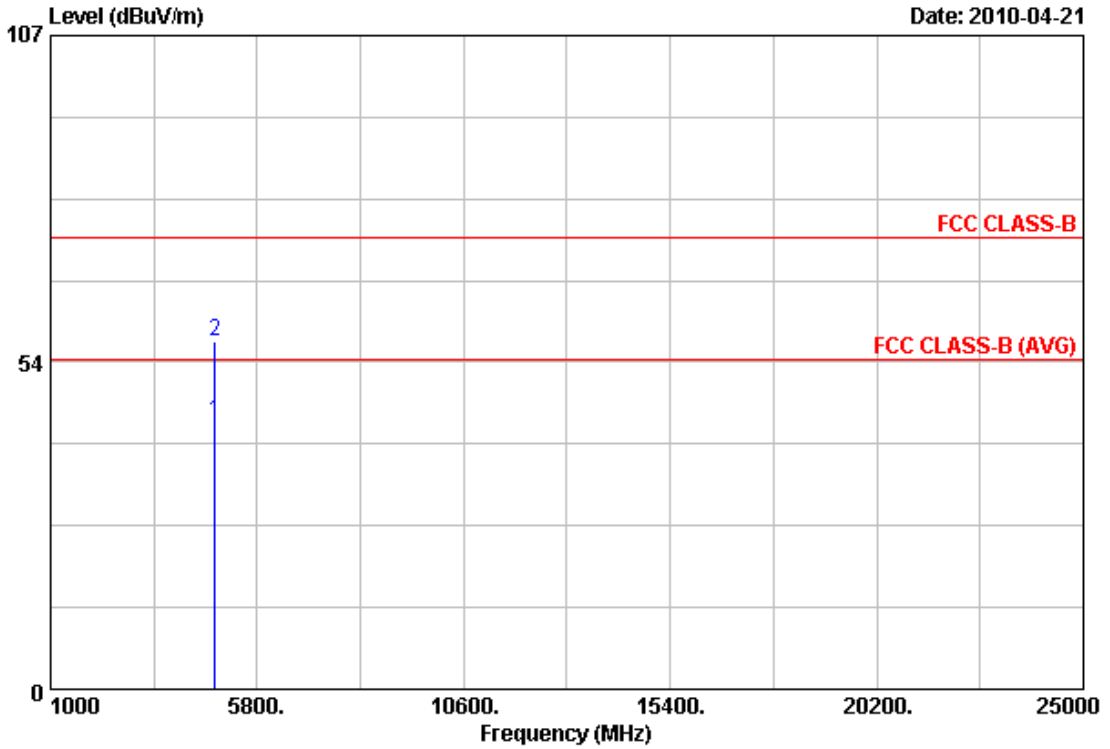

Item	Freq	Read Value	Factor	Result	Limit	Margin	Remark	Ant Pos	Tab Pos
	MHz	dBuV	dB/m	dBuV/m	dBuV/m	dB		cm	Deg
1	4823.95	36.27	7.69	43.96	54.00	-10.04	Average	100	360
2	4828.80	49.17	7.72	56.89	74.00	-17.11	Peak	100	360

Notes:

1. Result = Read Value + Factor
2. Factor = Antenna Factor + Cable Loss - Amplifier
3. The resolution bandwidth of test receiver/spectrum analyzer is 120KHz and video bandwidth is 300kHz for Peak detection and Quasi-peak detection at frequency below 1GHz.
4. The resolution bandwidth of test receiver/spectrum analyzer is 1MHz and video bandwidth is 3MHz for Peak detection at frequency above 1GHz.
5. The resolution bandwidth of test receiver/spectrum analyzer is 1MHz and video bandwidth is 10Hz for Average detection at frequency above 1GHz.
6. The other emissions is too low to be measured.
7. The data is worse case.



Power	: AC 120V	Pol/Phase	: HORIZONTAL
Test Mode 1	: 802.11b, CH1	Temperature	: 26 °C
Memo	:	Humidity	: 61 %

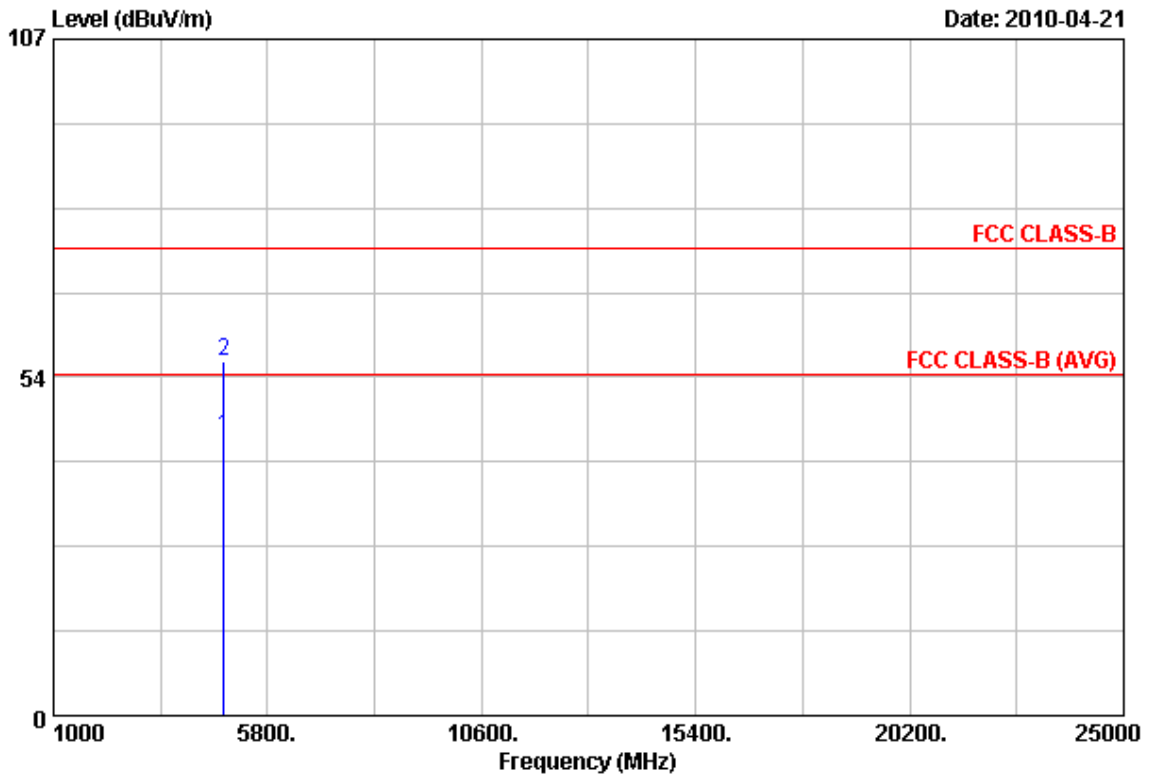

Item	Freq	Read Value	Factor	Result	Limit	Margin	Remark	Ant Pos	Tab Pos
	MHz	dBuV	dB/m	dBuV/m	dBuV/m	dB		cm	Deg
1	4822.20	36.28	7.69	43.97	54.00	-10.03	Average	100	0
2	4825.80	48.38	7.72	56.10	74.00	-17.90	Peak	100	0

Notes:

1. Result = Read Value + Factor
2. Factor = Antenna Factor + Cable Loss - Amplifier
3. The resolution bandwidth of test receiver/spectrum analyzer is 120kHz and video bandwidth is 300kHz for Peak detection and Quasi-peak detection at frequency below 1GHz.
4. The resolution bandwidth of test receiver/spectrum analyzer is 1MHz and video bandwidth is 3MHz for Peak detection at frequency above 1GHz.
5. The resolution bandwidth of test receiver/spectrum analyzer is 1MHz and video bandwidth is 10Hz for Average detection at frequency above 1GHz.
6. The other emissions is too low to be measured.
7. The data is worse case.



Power	: AC 120V	Pol/Phase	: VERTICAL
Test Mode 1	: 802.11b, CH6	Temperature	: 26 °C
Memo	:	Humidity	: 61 %

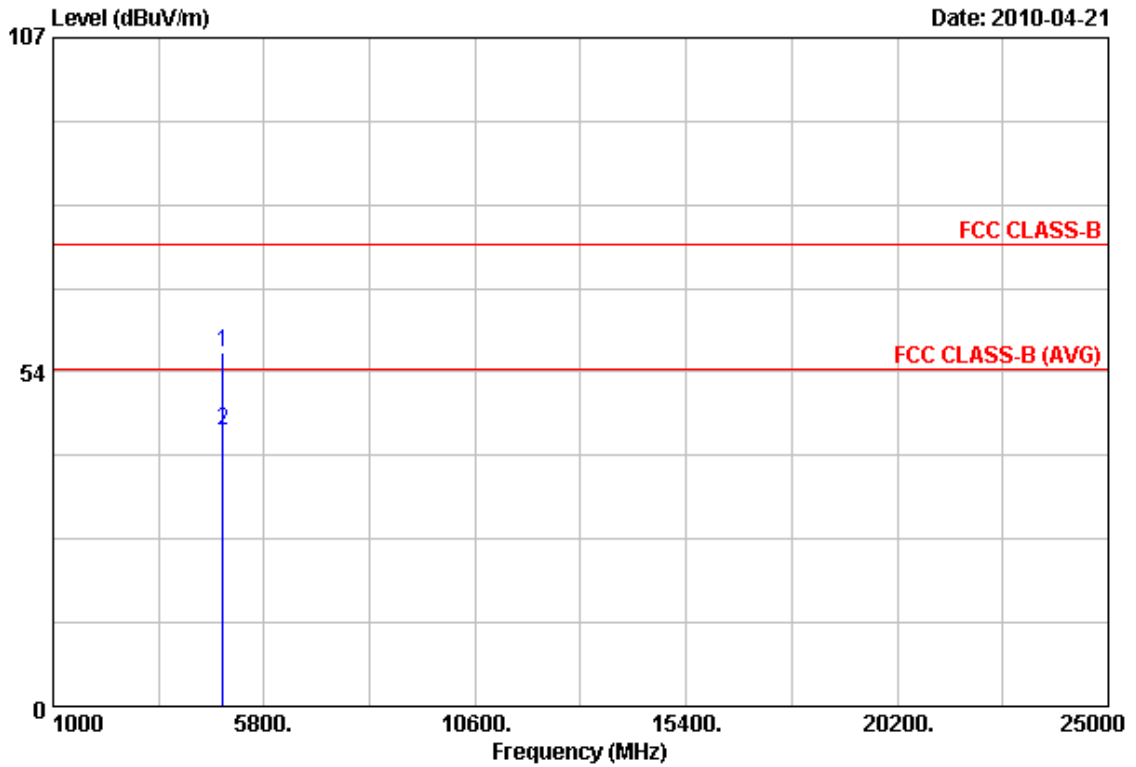

Item	Freq	Read Value	Factor	Result	Limit	Margin	Remark	Ant Pos	Tab Pos
	MHz	dBuV	dB/m	dBuV/m	dBuV/m	dB		cm	Deg
1	4869.28	48.84	7.85	56.69	74.00	-17.31	Peak	100	360
2	4871.23	36.23	7.86	44.09	54.00	-9.91	Average	100	360

Notes:

1. Result = Read Value + Factor
2. Factor = Antenna Factor + Cable Loss - Amplifier
3. The resolution bandwidth of test receiver/spectrum analyzer is 120KHz and video bandwidth is 300kHz for Peak detection and Quasi-peak detection at frequency below 1GHz.
4. The resolution bandwidth of test receiver/spectrum analyzer is 1MHz and video bandwidth is 3MHz for Peak detection at frequency above 1GHz.
5. The resolution bandwidth of test receiver/spectrum analyzer is 1MHz and video bandwidth is 10Hz for Average detection at frequency above 1GHz.
6. The other emissions is too low to be measured.
7. The data is worse case.



Power	: AC 120V	Pol/Phase	: HORIZONTAL
Test Mode 1	: 802.11b, CH6	Temperature	: 26 °C
Memo	:	Humidity	: 61 %

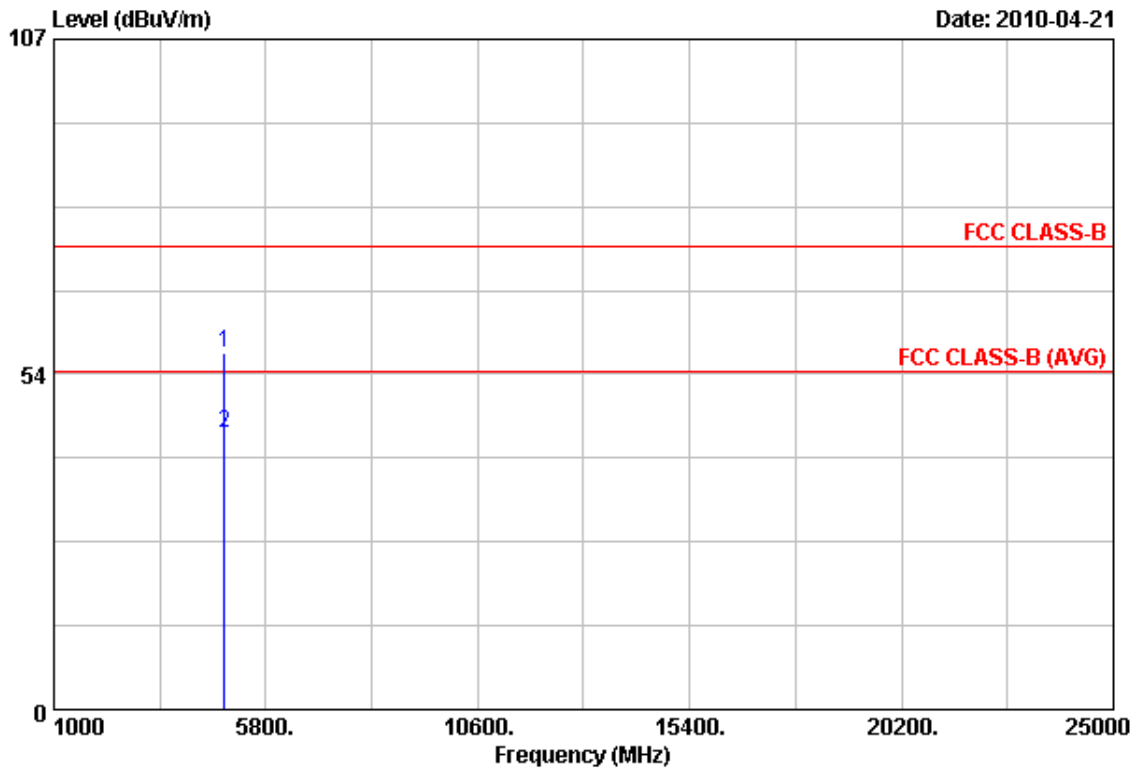

Item	Freq	Read Value	Factor	Result	Limit	Margin	Remark	Ant Pos	Tab Pos
	MHz	dBuV	dB/m	dBuV/m	dBuV/m	dB		cm	Deg
1	4870.23	48.94	7.86	56.80	74.00	-17.20	Peak	100	0
2	4870.90	36.22	7.86	44.08	54.00	-9.92	Average	100	0

Notes:

1. Result = Read Value + Factor
2. Factor = Antenna Factor + Cable Loss - Amplifier
3. The resolution bandwidth of test receiver/spectrum analyzer is 120KHz and video bandwidth is 300kHz for Peak detection and Quasi-peak detection at frequency below 1GHz.
4. The resolution bandwidth of test receiver/spectrum analyzer is 1MHz and video bandwidth is 3MHz for Peak detection at frequency above 1GHz.
5. The resolution bandwidth of test receiver/spectrum analyzer is 1MHz and video bandwidth is 10Hz for Average detection at frequency above 1GHz.
6. The other emissions is too low to be measured.
7. The data is worse case.



Power	: AC 120V	Pol/Phase	: VERTICAL
Test Mode 1	: 802.11b, CH11	Temperature	: 26 °C
Memo	:	Humidity	: 61 %

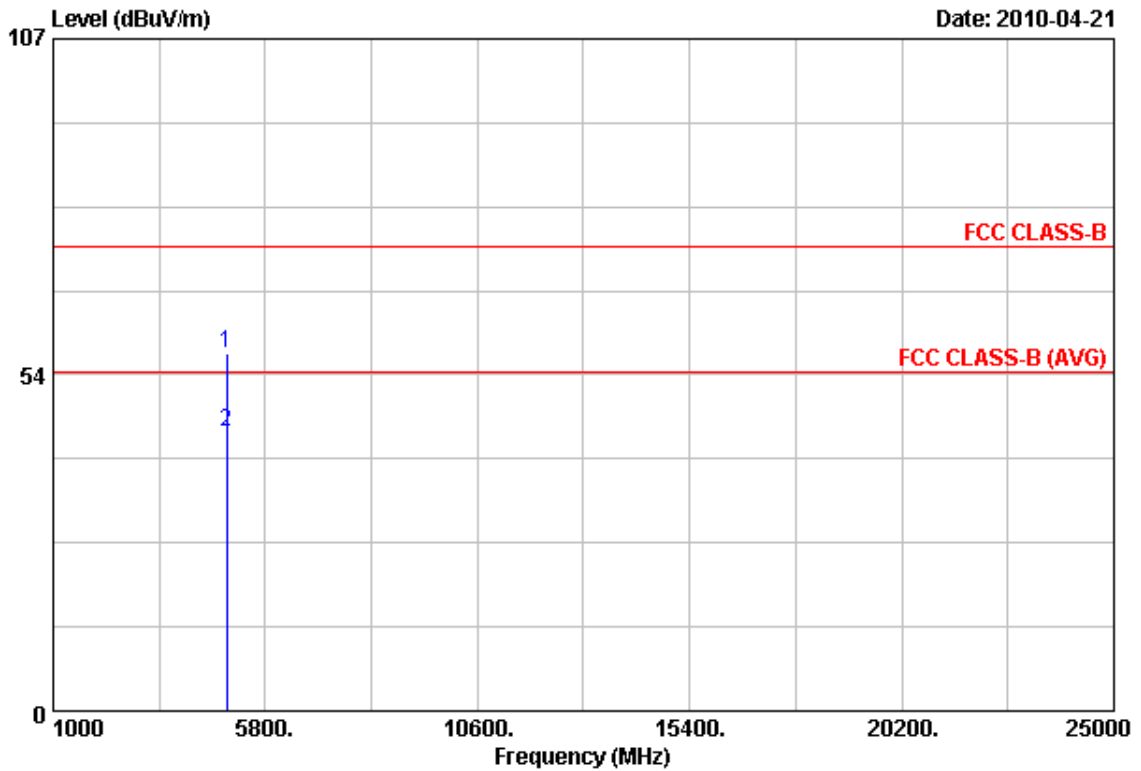

Item	Freq	Read Value	Factor	Result	Limit	Margin	Remark	Ant Pos	Tab Pos
	MHz	dBuV	dB/m	dBuV/m	dBuV/m	dB		cm	Deg
1	4921.78	48.77	8.03	56.80	74.00	-17.20	Peak	100	360
2	4922.55	36.27	8.03	44.30	54.00	-9.70	Average	100	360

Notes:

1. Result = Read Value + Factor
2. Factor = Antenna Factor + Cable Loss - Amplifier
3. The resolution bandwidth of test receiver/spectrum analyzer is 120KHz and video bandwidth is 300kHz for Peak detection and Quasi-peak detection at frequency below 1GHz.
4. The resolution bandwidth of test receiver/spectrum analyzer is 1MHz and video bandwidth is 3MHz for Peak detection at frequency above 1GHz.
5. The resolution bandwidth of test receiver/spectrum analyzer is 1MHz and video bandwidth is 10Hz for Average detection at frequency above 1GHz.
6. The other emissions is too low to be measured.
7. The data is worse case.



Power	: AC 120V	Pol/Phase	: HORIZONTAL
Test Mode 1	: 802.11b, CH11	Temperature	: 26 °C
Memo	:	Humidity	: 61 %

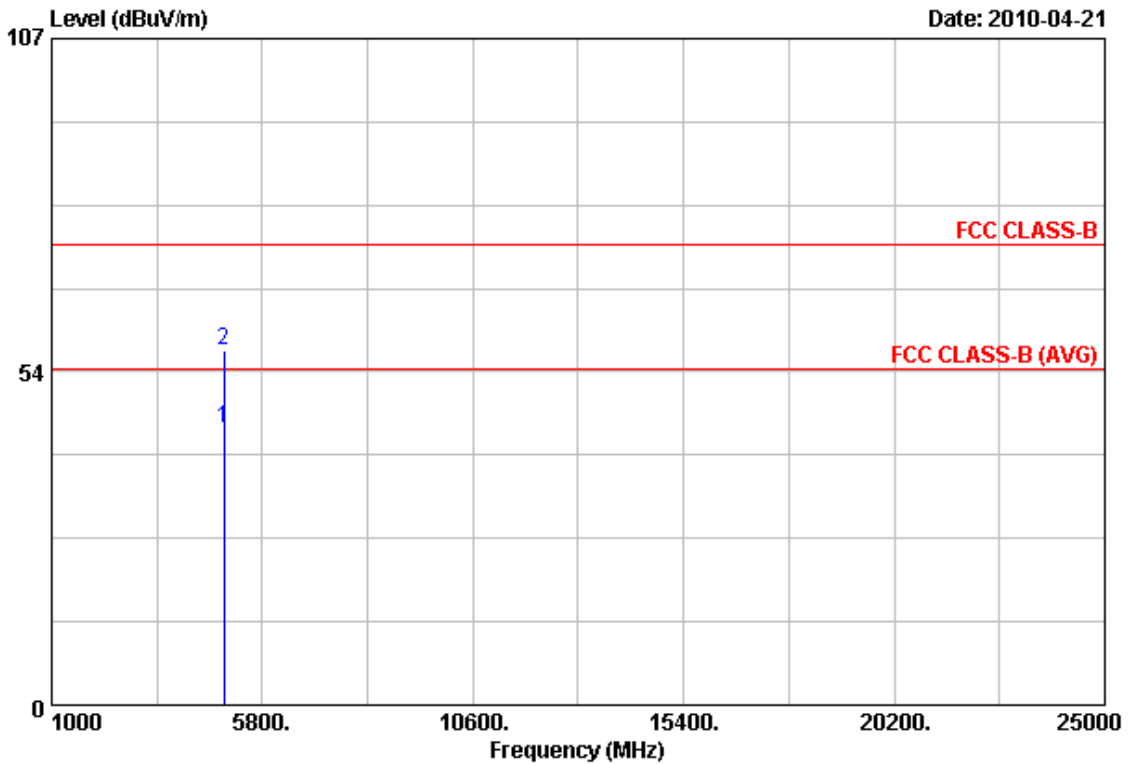

Item	Freq	Read Value	Factor	Result	Limit	Margin	Remark	Ant Pos	Tab Pos
	MHz	dBuV	dB/m	dBuV/m	dBuV/m	dB		cm	Deg
1	4920.83	36.31	8.03	44.34	54.00	-9.66	Average	100	0
2	4922.13	48.97	8.03	57.00	74.00	-17.00	Peak	100	0

Notes:

1. Result = Read Value + Factor
2. Factor = Antenna Factor + Cable Loss - Amplifier
3. The resolution bandwidth of test receiver/spectrum analyzer is 120KHz and video bandwidth is 300kHz for Peak detection and Quasi-peak detection at frequency below 1GHz.
4. The resolution bandwidth of test receiver/spectrum analyzer is 1MHz and video bandwidth is 3MHz for Peak detection at frequency above 1GHz.
5. The resolution bandwidth of test receiver/spectrum analyzer is 1MHz and video bandwidth is 10Hz for Average detection at frequency above 1GHz.
6. The other emissions is too low to be measured.
7. The data is worse case.



Power	: AC 120V	Pol/Phase	: VERTICAL
Test Mode 1	: 802.11g, CH1	Temperature	: 26 °C
Memo	:	Humidity	: 61 %

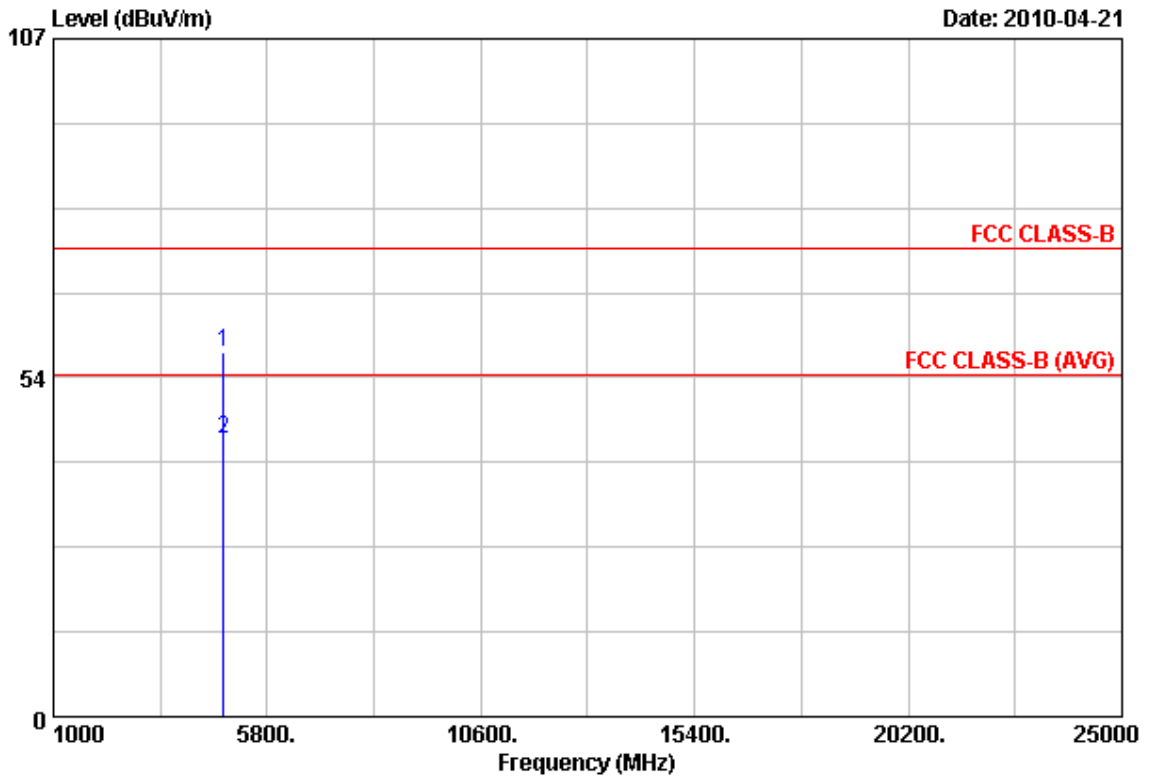

Item	Freq	Read Value	Factor	Result	Limit	Margin	Remark	Ant Pos	Tab Pos
	MHz	dBuV	dB/m	dBuV/m	dBuV/m	dB		cm	Deg
1	4822.13	49.83	7.69	57.52	74.00	-16.48	Peak	100	360
2	4822.75	36.21	7.69	43.90	54.00	-10.10	Average	100	360

Notes:

1. Result = Read Value + Factor
2. Factor = Antenna Factor + Cable Loss - Amplifier
3. The resolution bandwidth of test receiver/spectrum analyzer is 120KHz and video bandwidth is 300kHz for Peak detection and Quasi-peak detection at frequency below 1GHz.
4. The resolution bandwidth of test receiver/spectrum analyzer is 1MHz and video bandwidth is 3MHz for Peak detection at frequency above 1GHz.
5. The resolution bandwidth of test receiver/spectrum analyzer is 1MHz and video bandwidth is 10Hz for Average detection at frequency above 1GHz.
6. The other emissions is too low to be measured.
7. The data is worse case.





Power	: AC 120V	Pol/Phase	: HORIZONTAL
Test Mode 1	: 802.11g, CH1	Temperature	: 26 °C
Memo	:	Humidity	: 61 %

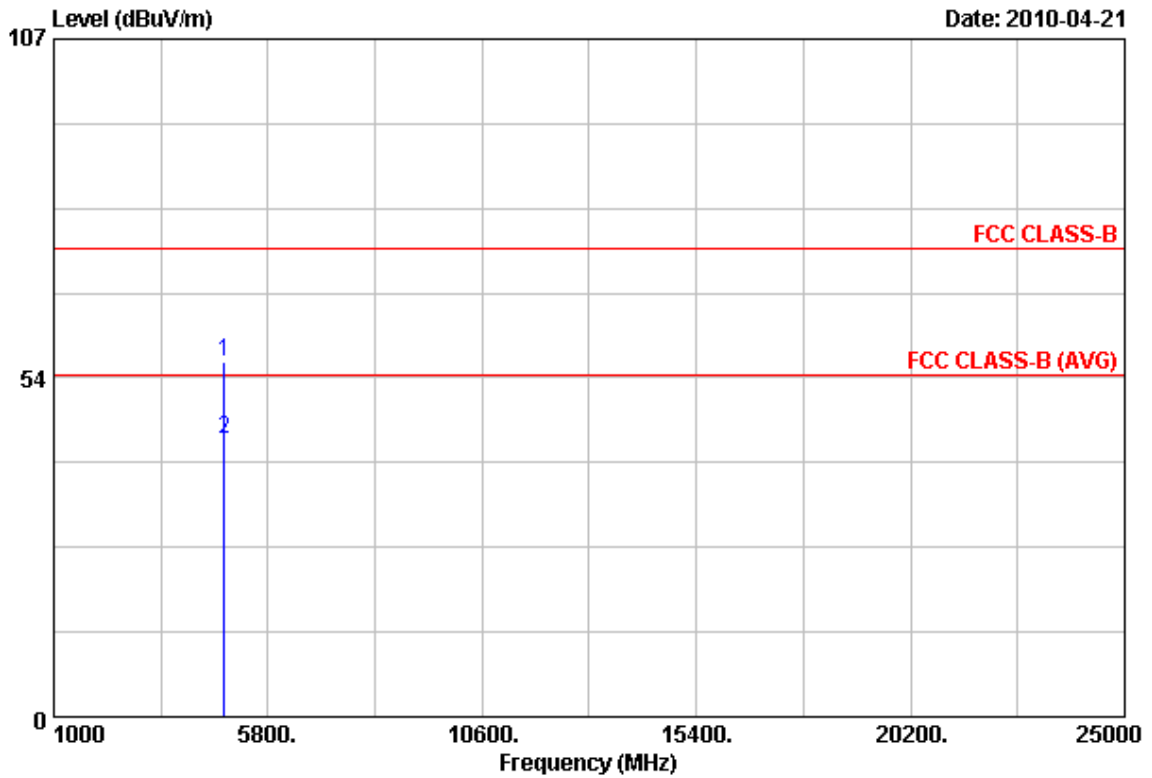

Item	Freq	Read Value	Factor	Result	Limit	Margin	Remark	Ant Pos	Tab Pos
	MHz	dBuV	dB/m	dBuV/m	dBuV/m	dB		cm	Deg
1	4821.45	48.48	7.69	56.17	74.00	-17.83	Peak	100	0
2	4823.40	36.27	7.69	43.96	54.00	-10.04	Average	100	0

Notes:

1. Result = Read Value + Factor
2. Factor = Antenna Factor + Cable Loss - Amplifier
3. The resolution bandwidth of test receiver/spectrum analyzer is 120KHz and video bandwidth is 300kHz for Peak detection and Quasi-peak detection at frequency below 1GHz.
4. The resolution bandwidth of test receiver/spectrum analyzer is 1MHz and video bandwidth is 3MHz for Peak detection at frequency above 1GHz.
5. The resolution bandwidth of test receiver/spectrum analyzer is 1MHz and video bandwidth is 10Hz for Average detection at frequency above 1GHz.
6. The other emissions is too low to be measured.
7. The data is worse case.



Power	: AC 120V	Pol/Phase	: VERTICAL
Test Mode 1	: 802.11g, CH6	Temperature	: 26 °C
Memo	:	Humidity	: 61 %

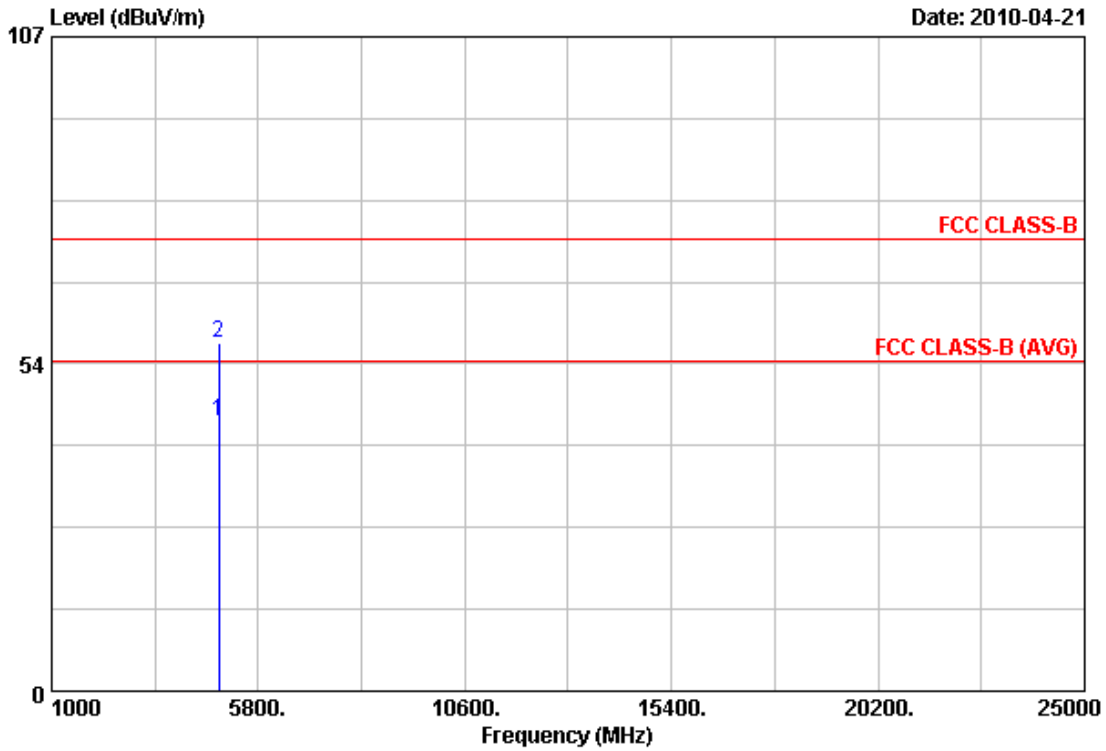

Item	Freq	Read Value	Factor	Result	Limit	Margin	Remark	Ant Pos	Tab Pos
	MHz	dBuV	dB/m	dBuV/m	dBuV/m	dB		cm	Deg
1	4874.23	36.30	7.86	44.16	54.00	-9.84	Average	100	360
2	4876.98	48.92	7.89	56.81	74.00	-17.19	Peak	100	360

Notes:

1. Result = Read Value + Factor
2. Factor = Antenna Factor + Cable Loss - Amplifier
3. The resolution bandwidth of test receiver/spectrum analyzer is 120KHz and video bandwidth is 300kHz for Peak detection and Quasi-peak detection at frequency below 1GHz.
4. The resolution bandwidth of test receiver/spectrum analyzer is 1MHz and video bandwidth is 3MHz for Peak detection at frequency above 1GHz.
5. The resolution bandwidth of test receiver/spectrum analyzer is 1MHz and video bandwidth is 10Hz for Average detection at frequency above 1GHz.
6. The other emissions is too low to be measured.
7. The data is worse case.



Power	: AC 120V	Pol/Phase	: HORIZONTAL
Test Mode 1	: 802.11g, CH6	Temperature	: 26 °C
Memo	:	Humidity	: 61 %

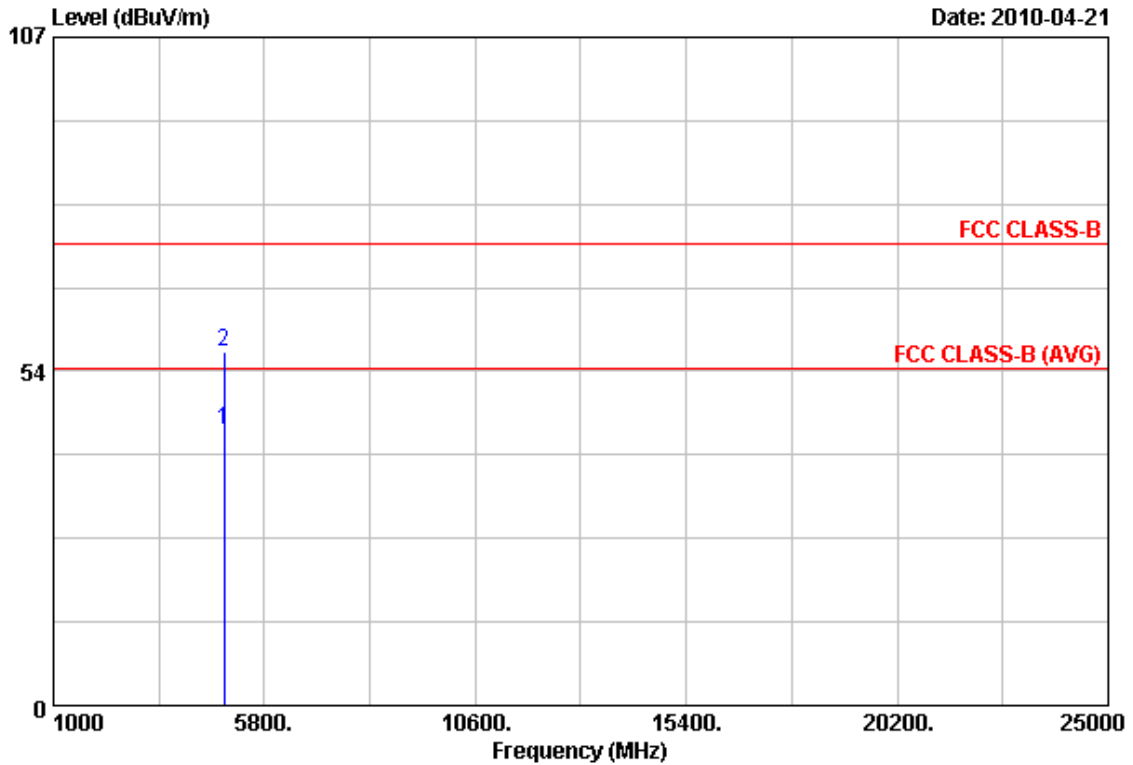

Item	Freq	Read Value	Factor	Result	Limit	Margin	Remark	Ant Pos	Tab Pos
	MHz	dBuV	dB/m	dBuV/m	dBuV/m	dB		cm	Deg
1	4874.60	36.26	7.86	44.12	54.00	-9.88	Average	100	0
2	4878.48	48.74	7.89	56.63	74.00	-17.37	Peak	100	0

Notes:

1. Result = Read Value + Factor
2. Factor = Antenna Factor + Cable Loss - Amplifier
3. The resolution bandwidth of test receiver/spectrum analyzer is 120KHz and video bandwidth is 300kHz for Peak detection and Quasi-peak detection at frequency below 1GHz.
4. The resolution bandwidth of test receiver/spectrum analyzer is 1MHz and video bandwidth is 3MHz for Peak detection at frequency above 1GHz.
5. The resolution bandwidth of test receiver/spectrum analyzer is 1MHz and video bandwidth is 10Hz for Average detection at frequency above 1GHz.
6. The other emissions is too low to be measured.
7. The data is worse case.



Power	: AC 120V	Pol/Phase	: VERTICAL
Test Mode 1	: 802.11g, CH11	Temperature	: 26 °C
Memo	:	Humidity	: 61 %

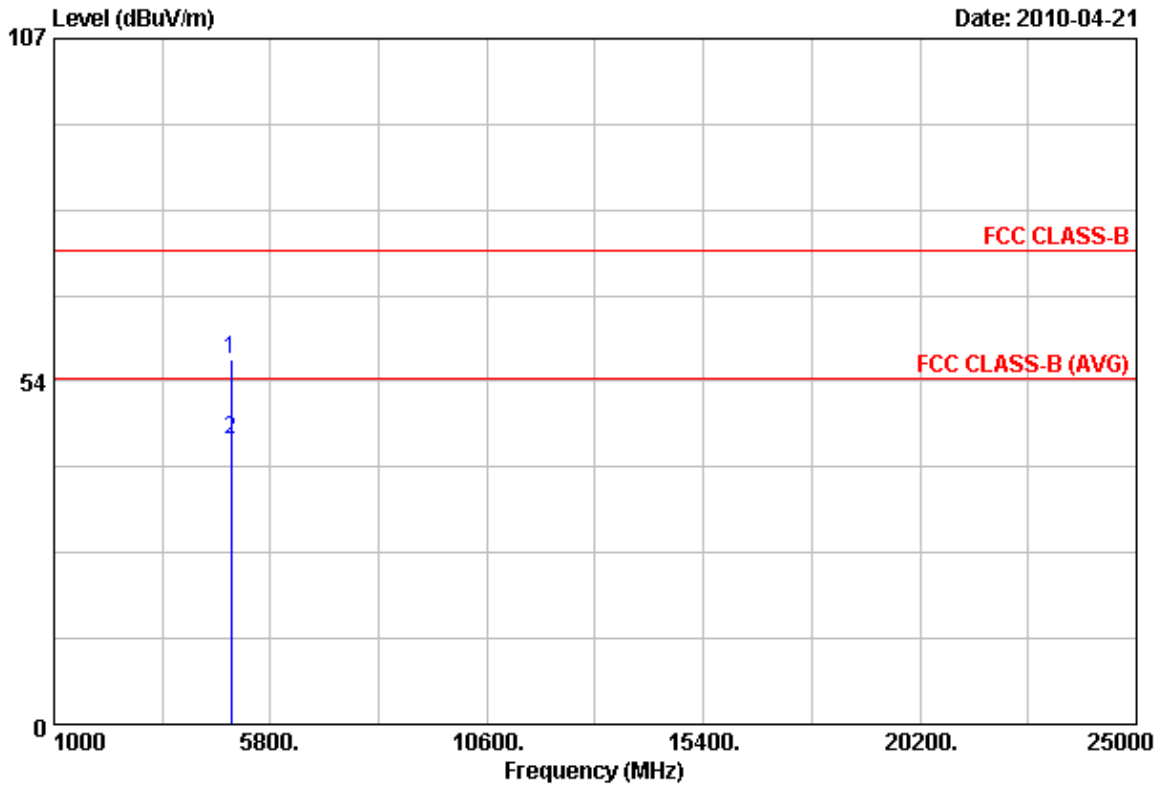

Item	Freq	Read Value	Factor	Result	Limit	Margin	Remark	Ant Pos	Tab Pos
	MHz	dBuV	dB/m	dBuV/m	dBuV/m	dB		cm	Deg
1	4919.98	48.80	8.03	56.83	74.00	-17.17	Peak	100	360
2	4923.20	36.32	8.03	44.35	54.00	-9.65	Average	100	360

Notes:

1. Result = Read Value + Factor
2. Factor = Antenna Factor + Cable Loss - Amplifier
3. The resolution bandwidth of test receiver/spectrum analyzer is 120KHz and video bandwidth is 300KHz for Peak detection and Quasi-peak detection at frequency below 1GHz.
4. The resolution bandwidth of test receiver/spectrum analyzer is 1MHz and video bandwidth is 3MHz for Peak detection at frequency above 1GHz.
5. The resolution bandwidth of test receiver/spectrum analyzer is 1MHz and video bandwidth is 10Hz for Average detection at frequency above 1GHz.
6. The other emissions is too low to be measured.
7. The data is worse case.



Power	: AC 120V	Pol/Phase	: HORIZONTAL
Test Mode 1	: 802.11g, CH11	Temperature	: 26 °C
Memo	:	Humidity	: 61 %

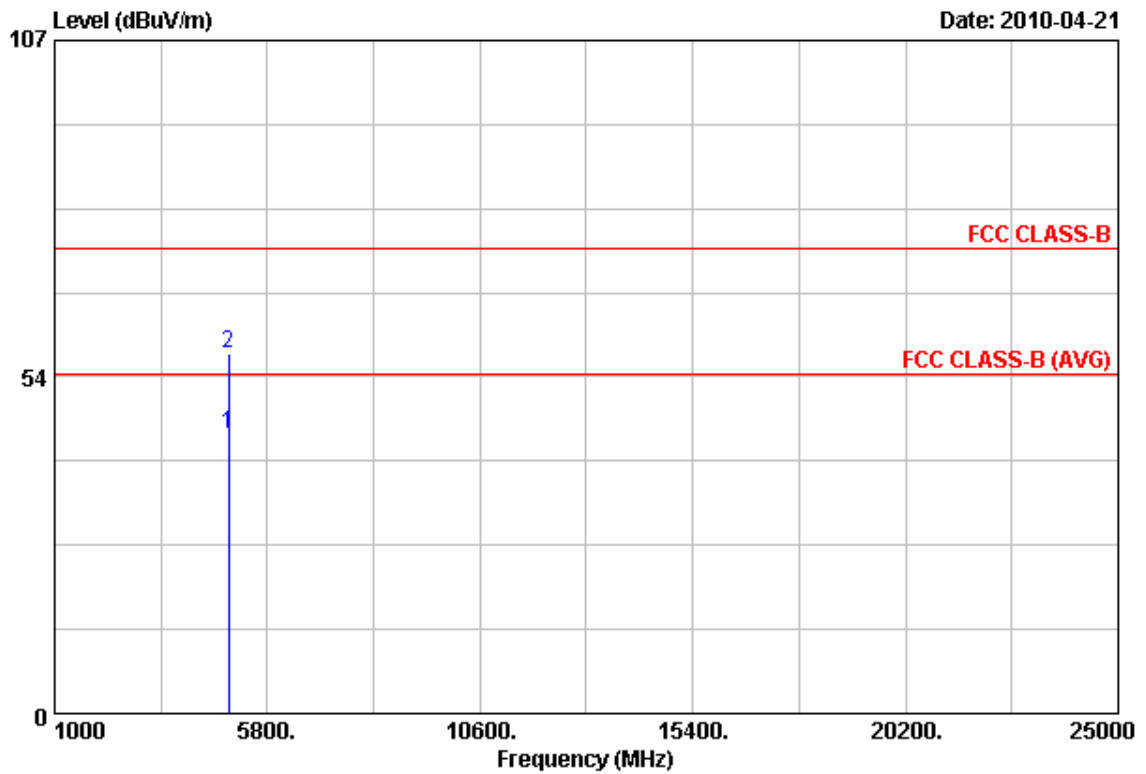

Item	Freq	Read Value	Factor	Result	Limit	Margin	Remark	Ant Pos	Tab Pos
	MHz	dBuV	dB/m	dBuV/m	dBuV/m	dB		cm	Deg
1	4924.13	36.32	8.03	44.35	54.00	-9.65	Average	100	360
2	4925.25	49.05	8.06	57.11	74.00	-16.89	Peak	100	360

Notes:

1. Result = Read Value + Factor
2. Factor = Antenna Factor + Cable Loss - Amplifier
3. The resolution bandwidth of test receiver/spectrum analyzer is 120KHz and video bandwidth is 300KHz for Peak detection and Quasi-peak detection at frequency below 1GHz.
4. The resolution bandwidth of test receiver/spectrum analyzer is 1MHz and video bandwidth is 3MHz for Peak detection at frequency above 1GHz.
5. The resolution bandwidth of test receiver/spectrum analyzer is 1MHz and video bandwidth is 10Hz for Average detection at frequency above 1GHz.
6. The other emissions is too low to be measured.
7. The data is worse case.



Power	: AC 120V	Pol/Phase	: VERTICAL
Test Mode 2	: 802.11n HT20, CH1	Temperature	: 26 °C
Memo	:	Humidity	: 61 %

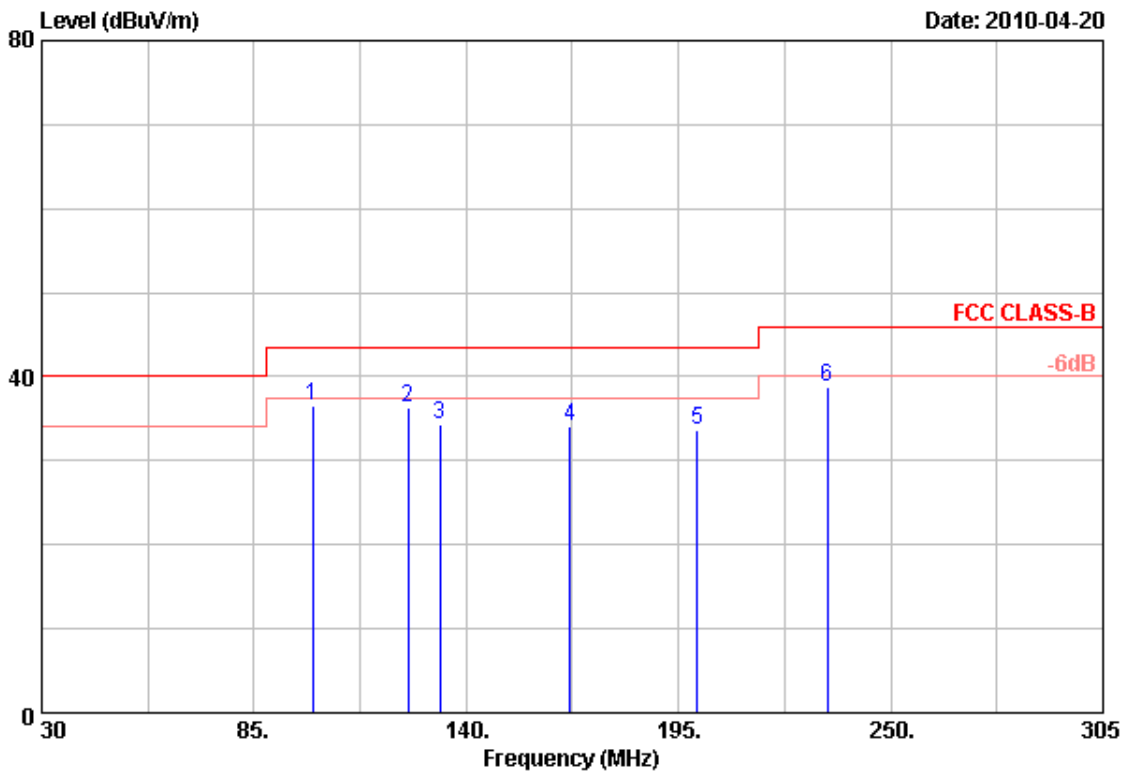

Item	Freq	Read Value	Factor	Result	Limit	Margin	Remark	Ant Pos	Tab Pos
	MHz	dBuV	dB/m	dBuV/m	dBuV/m	dB		cm	Deg
1	100.13	58.21	-21.62	36.59	43.50	-6.91	Peak	100	360
2	124.88	55.68	-19.43	36.25	43.50	-7.25	Peak	100	360
3	133.13	53.72	-19.47	34.25	43.50	-9.25	Peak	100	360
4	166.95	56.25	-22.12	34.13	43.50	-9.37	Peak	100	360
5	199.95	53.13	-19.51	33.62	43.50	-9.88	Peak	100	360
6	233.50	60.53	-21.69	38.84	46.00	-7.16	Peak	100	360

Notes:

1. Result = Read Value + Factor
2. Factor = Antenna Factor + Cable Loss - Amplifier
3. The resolution bandwidth of test receiver/spectrum analyzer is 120KHz and video bandwidth is 300kHz for Peak detection and Quasi-peak detection at frequency below 1GHz.
4. All emission below 1GHz at 802.11b/g/n mode are all the same, so the 802.11g/n mode chosen as representative in final test.
5. According to technical experiences, all spurious emission of 802.11g/n mode at channel 1, 6, 11 or 3, 6, 9 (for HT40) are almost the same below 1GHz, so that the channel 1 or 3 (for HT40) was chosen as representative in final test.
6. The data is worse case.



Power	: AC 120V	Pol/Phase	: VERTICAL
Test Mode 2	: 802.11n HT20, CH1	Temperature	: 26 °C
Memo	:	Humidity	: 61 %

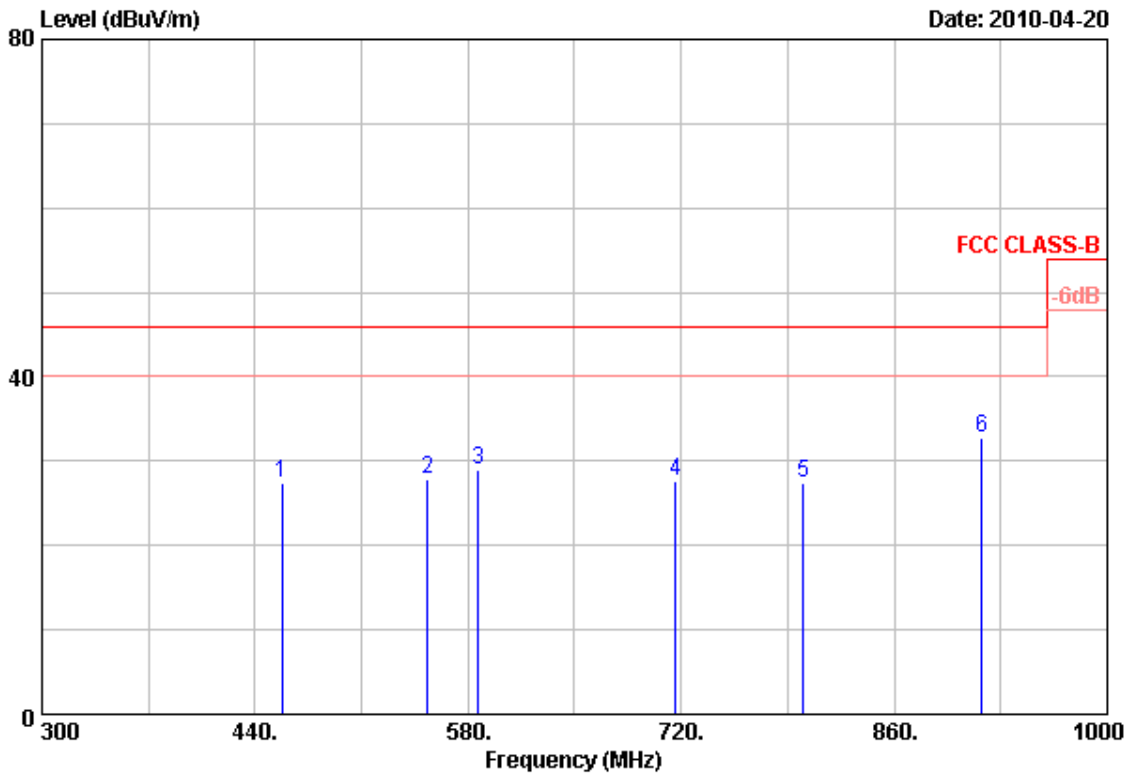

Item	Freq	Read Value	Factor	Result	Limit	Margin	Remark	Ant Pos	Tab Pos
	MHz	dBuV	dB/m	dBuV/m	dBuV/m	dB		cm	Deg
1	457.50	45.39	-18.05	27.34	46.00	-18.66	Peak	100	0
2	553.40	41.32	-13.38	27.94	46.00	-18.06	Peak	100	0
3	587.00	43.86	-14.86	29.00	46.00	-17.00	Peak	100	0
4	716.50	40.31	-12.59	27.72	46.00	-18.28	Peak	100	0
5	800.50	38.60	-11.09	27.51	46.00	-18.49	Peak	100	0
6	917.40	38.74	-5.88	32.86	46.00	-13.14	Peak	100	0

Notes:

1. Result = Read Value + Factor
2. Factor = Antenna Factor + Cable Loss - Amplifier
3. The resolution bandwidth of test receiver/spectrum analyzer is 120KHz and video bandwidth is 300KHz for Peak detection and Quasi-peak detection at frequency below 1GHz.
4. All emission below 1GHz at 802.11b/g/n mode are all the same,so the 802.11g/n mode chosen as representative in final test.
5. According to technical experiences,all spurious emission of 802.11g/n mode at channel 1,6,11 or 3,6,9(for HT40) are almost the same below 1GHz,so that the channel 1 or 3(for HT40)was chosen as representative in final test.
6. The data is worse case.



Power	: AC 120V	Pol/Phase	: HORIZONTAL
Test Mode 2	: 802.11n HT20, CH1	Temperature	: 26 °C
Memo	:	Humidity	: 61 %

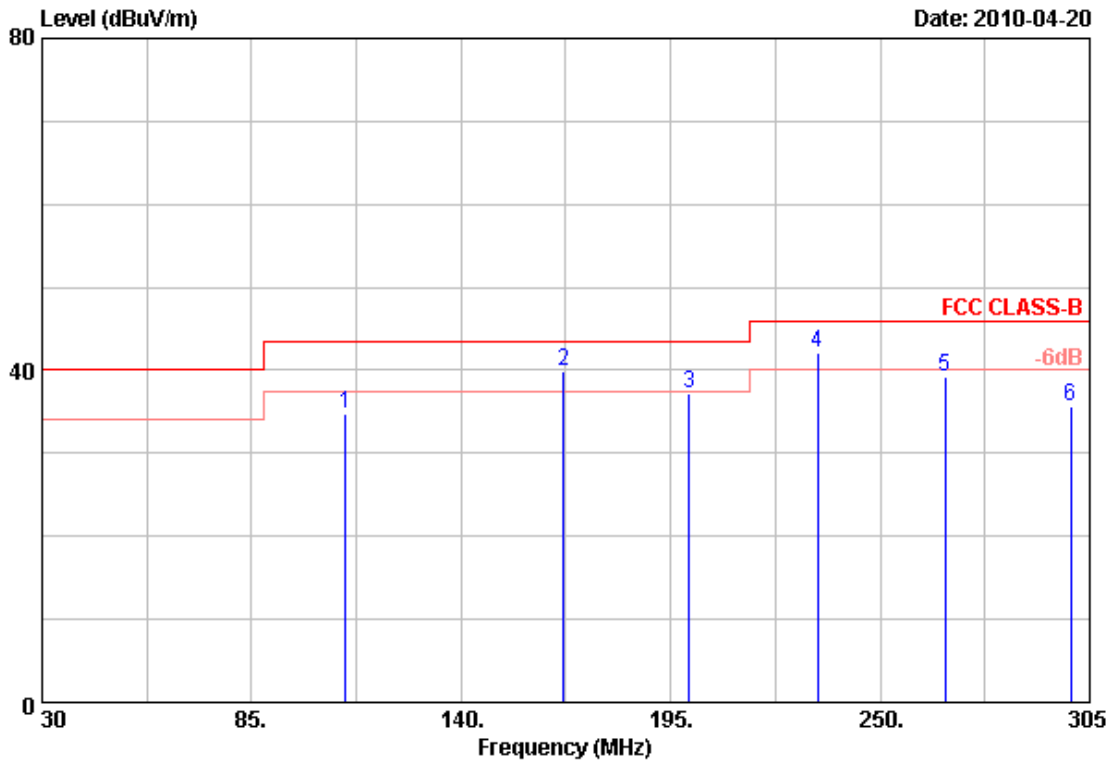

Item	Freq	Read Value	Factor	Result	Limit	Margin	Remark	Ant Pos	Tab Pos
	MHz	dBuV	dB/m	dBuV/m	dBuV/m	dB		cm	Deg
1	109.75	62.72	-27.90	34.82	43.50	-8.68	Peak	100	360
2	166.95	67.08	-27.25	39.83	43.50	-3.67	QP	100	360
3	199.95	64.47	-27.25	37.22	43.50	-6.28	Peak	100	360
4	233.50	68.15	-26.10	42.05	46.00	-3.95	QP	100	360
5	267.05	62.74	-23.53	39.21	46.00	-6.79	Peak	100	360
6	300.05	58.61	-23.01	35.60	46.00	-10.40	Peak	100	360

Notes:

1. Result = Read Value + Factor
2. Factor = Antenna Factor + Cable Loss - Amplifier
3. The resolution bandwidth of test receiver/spectrum analyzer is 120KHz and video bandwidth is 300KHz for Peak detection and Quasi-peak detection at frequency below 1GHz.
4. All emission below 1GHz at 802.11b/g/n mode are all the same,so the 802.11g/n mode chosen as representative in final test.
5. According to technical experiences,all spurious emission of 802.11g/n mode at channel 1,6,11 or 3,6,9(for HT40) are almost the same below 1GHz,so that the channel 1 or 3(for HT40)was chosen as representative in final test.
6. The data is worse case.





Power	: AC 120V	Pol/Phase	: HORIZONTAL
Test Mode 2	: 802.11n HT20, CH1	Temperature	: 26 °C
Memo	:	Humidity	: 61 %

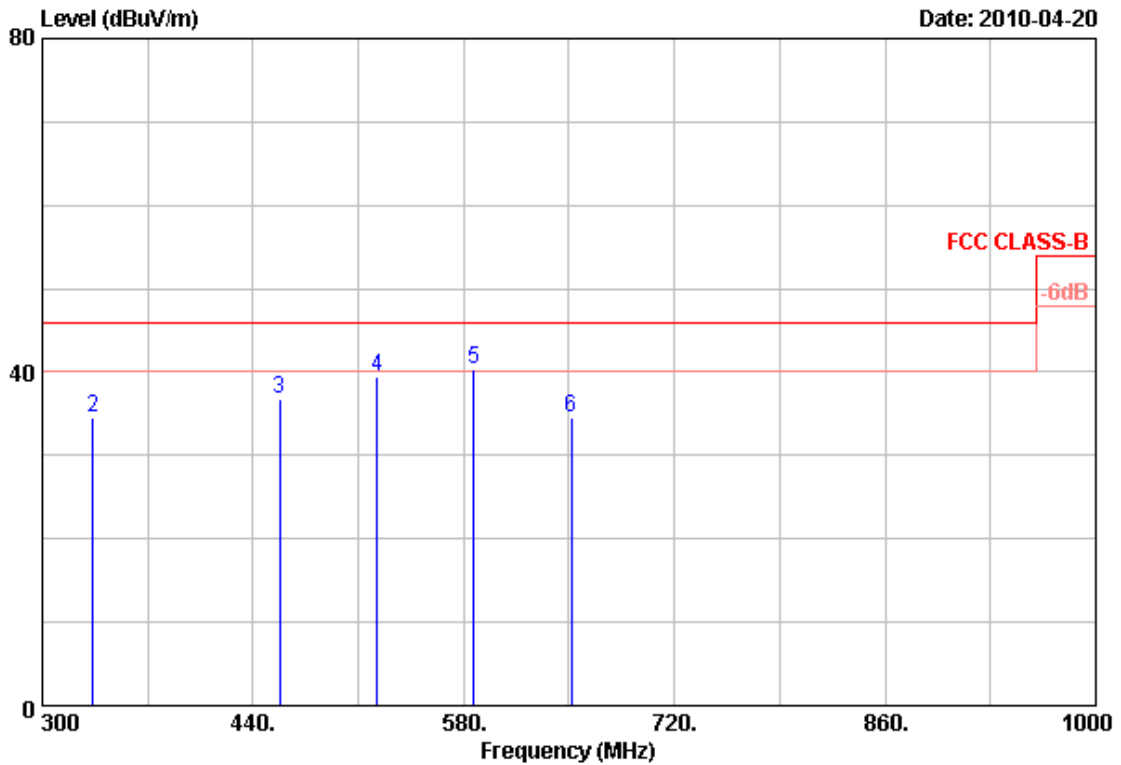

Item	Freq	Read Value	Factor	Result	Limit	Margin	Remark	Ant Pos	Tab Pos
	MHz	dBuV	dB/m	dBuV/m	dBuV/m	dB		cm	Deg
1	300.00	59.07	-23.01	36.06	46.00	-9.94	Peak	100	0
2	333.60	56.02	-21.56	34.46	46.00	-11.54	Peak	100	0
3	457.50	52.13	-15.28	36.85	46.00	-9.15	Peak	100	0
4	522.60	55.41	-16.07	39.34	46.00	-6.66	Peak	100	0
5	587.00	52.28	-12.05	40.23	46.00	-5.77	QP	100	0
6	651.40	46.99	-12.36	34.63	46.00	-11.37	Peak	100	0

Notes:

1. Result = Read Value + Factor
2. Factor = Antenna Factor + Cable Loss - Amplifier
3. The resolution bandwidth of test receiver/spectrum analyzer is 120KHz and video bandwidth is 300kHz for Peak detection and Quasi-peak detection at frequency below 1GHz.
4. All emission below 1GHz at 802.11b/g/n mode are all the same, so the 802.11g/n mode chosen as representative in final test.
5. According to technical experiences, all spurious emission of 802.11g/n mode at channel 1, 6, 11 or 3, 6, 9 (for HT40) are almost the same below 1GHz, so that the channel 1 or 3 (for HT40) was chosen as representative in final test.
6. The data is worse case.



Power	: AC 120V	Pol/Phase	: VERTICAL
Test Mode 2	: 802.11n HT20, CH1	Temperature	: 26 °C
Memo	:	Humidity	: 61 %

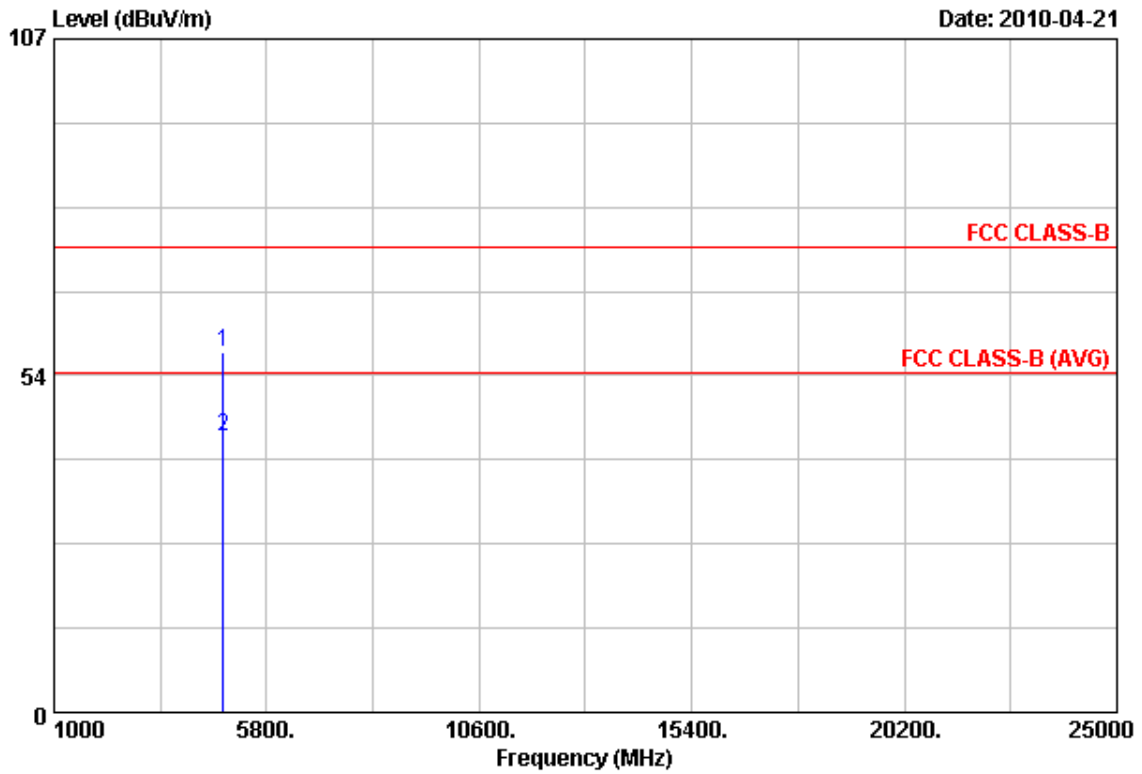

Item	Freq	Read Value	Factor	Result	Limit	Margin	Remark	Ant Pos	Tab Pos
	MHz	dBuV	dB/m	dBuV/m	dBuV/m	dB		cm	Deg
1	4820.20	49.51	7.69	57.20	74.00	-16.80	Peak	100	360
2	4823.15	36.23	7.69	43.92	54.00	-10.08	Average	100	360

Notes:

1. Result = Read Value + Factor
2. Factor = Antenna Factor + Cable Loss - Amplifier
3. The resolution bandwidth of test receiver/spectrum analyzer is 120KHz and video bandwidth is 300kHz for Peak detection and Quasi-peak detection at frequency below 1GHz.
4. The resolution bandwidth of test receiver/spectrum analyzer is 1MHz and video bandwidth is 3MHz for Peak detection at frequency above 1GHz.
5. The resolution bandwidth of test receiver/spectrum analyzer is 1MHz and video bandwidth is 10Hz for Average detection at frequency above 1GHz.
6. The other emissions is too low to be measured.
7. The data is worse case.



Power	: AC 120V	Pol/Phase	: HORIZONTAL
Test Mode 2	: 802.11n HT20, CH1	Temperature	: 26 °C
Memo	:	Humidity	: 61 %

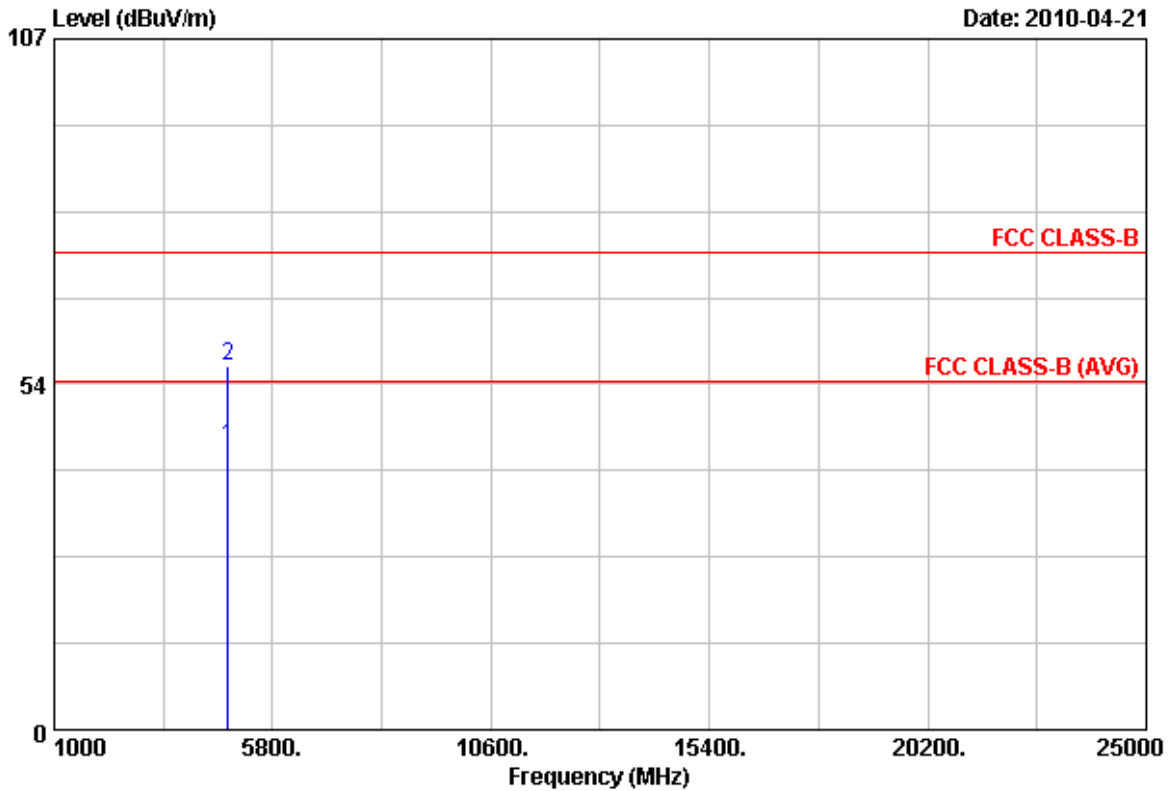

Item	Freq	Read Value	Factor	Result	Limit	Margin	Remark	Ant Pos	Tab Pos
	MHz	dBuV	dB/m	dBuV/m	dBuV/m	dB		cm	Deg
1	4823.00	36.22	7.69	43.91	54.00	-10.09	Average	100	0
2	4828.00	48.47	7.72	56.19	74.00	-17.81	Peak	100	0

Notes:

1. Result = Read Value + Factor
2. Factor = Antenna Factor + Cable Loss - Amplifier
3. The resolution bandwidth of test receiver/spectrum analyzer is 120KHz and video bandwidth is 300kHz for Peak detection and Quasi-peak detection at frequency below 1GHz.
4. The resolution bandwidth of test receiver/spectrum analyzer is 1MHz and video bandwidth is 3MHz for Peak detection at frequency above 1GHz.
5. The resolution bandwidth of test receiver/spectrum analyzer is 1MHz and video bandwidth is 10Hz for Average detection at frequency above 1GHz.
6. The other emissions is too low to be measured.
7. The data is worse case.



Power	: AC 120V	Pol/Phase	: VERTICAL
Test Mode 2	: 802.11n HT20, CH6	Temperature	: 26 °C
Memo	:	Humidity	: 61 %

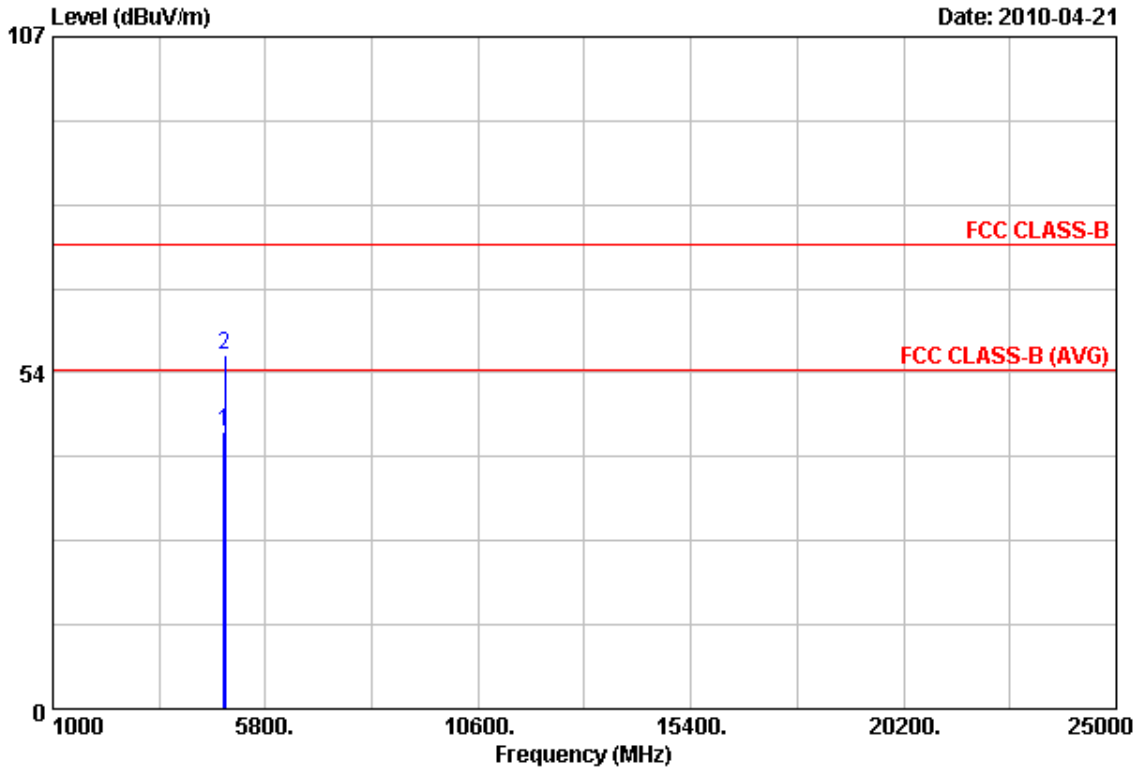

Item	Freq	Read Value	Factor	Result	Limit	Margin	Remark	Ant Pos	Tab Pos
	MHz	dBuV	dB/m	dBuV/m	dBuV/m	dB		cm	Deg
1	4872.70	36.30	7.86	44.16	54.00	-9.84	Average	100	360
2	4877.48	48.53	7.89	56.42	74.00	-17.58	Peak	100	360

Notes:

1. Result = Read Value + Factor
2. Factor = Antenna Factor + Cable Loss - Amplifier
3. The resolution bandwidth of test receiver/spectrum analyzer is 120KHz and video bandwidth is 300kHz for Peak detection and Quasi-peak detection at frequency below 1GHz.
4. The resolution bandwidth of test receiver/spectrum analyzer is 1MHz and video bandwidth is 3MHz for Peak detection at frequency above 1GHz.
5. The resolution bandwidth of test receiver/spectrum analyzer is 1MHz and video bandwidth is 10Hz for Average detection at frequency above 1GHz.
6. The other emissions is too low to be measured.
7. The data is worse case.



Power	: AC 120V	Pol/Phase	: HORIZONTAL
Test Mode 2	: 802.11n HT20, CH6	Temperature	: 26 °C
Memo	:	Humidity	: 61 %

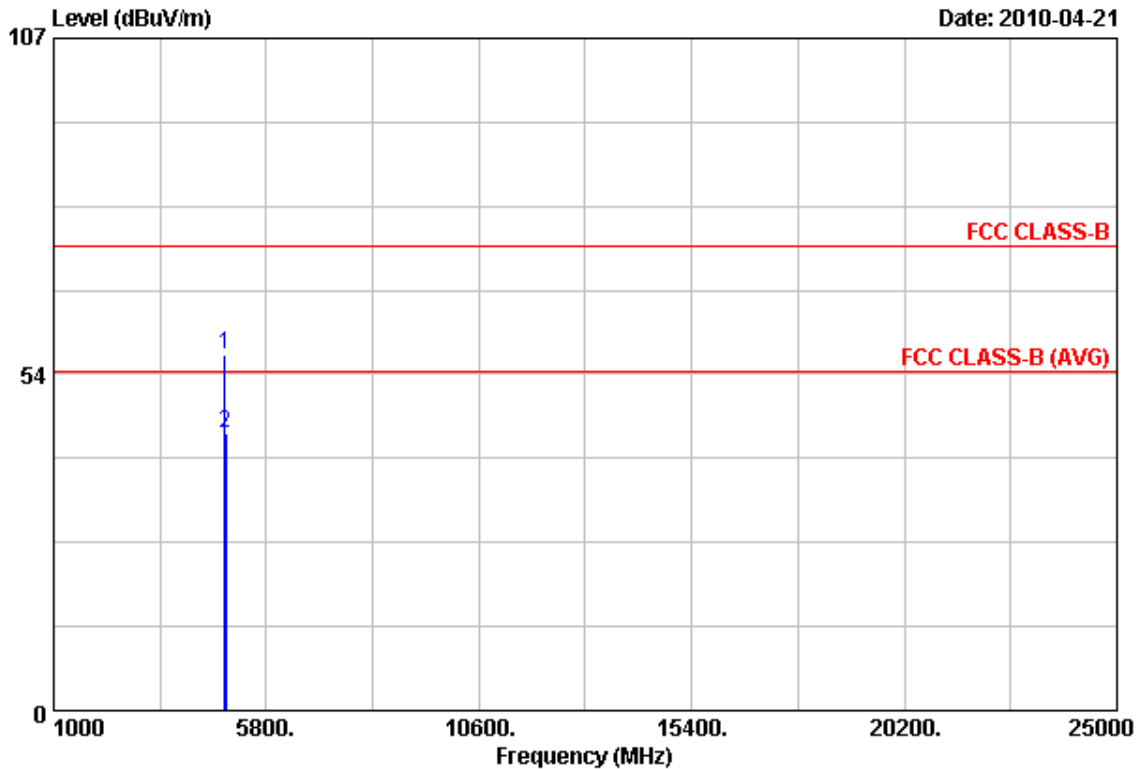

Item	Freq	Read Value	Factor	Result	Limit	Margin	Remark	Ant Pos	Tab Pos
	MHz	dBuV	dB/m	dBuV/m	dBuV/m	dB		cm	Deg
1	4872.93	48.85	7.86	56.71	74.00	-17.29	Peak	100	0
2	4874.13	36.31	7.86	44.17	54.00	-9.83	Average	100	0

Notes:

1. Result = Read Value + Factor
2. Factor = Antenna Factor + Cable Loss - Amplifier
3. The resolution bandwidth of test receiver/spectrum analyzer is 120KHz and video bandwidth is 300kHz for Peak detection and Quasi-peak detection at frequency below 1GHz.
4. The resolution bandwidth of test receiver/spectrum analyzer is 1MHz and video bandwidth is 3MHz for Peak detection at frequency above 1GHz.
5. The resolution bandwidth of test receiver/spectrum analyzer is 1MHz and video bandwidth is 10Hz for Average detection at frequency above 1GHz.
6. The other emissions is too low to be measured.
7. The data is worse case.



Power	: AC 120V	Pol/Phase	: VERTICAL
Test Mode 2	: 802.11n HT20, CH11	Temperature	: 26 °C
Memo	:	Humidity	: 61 %

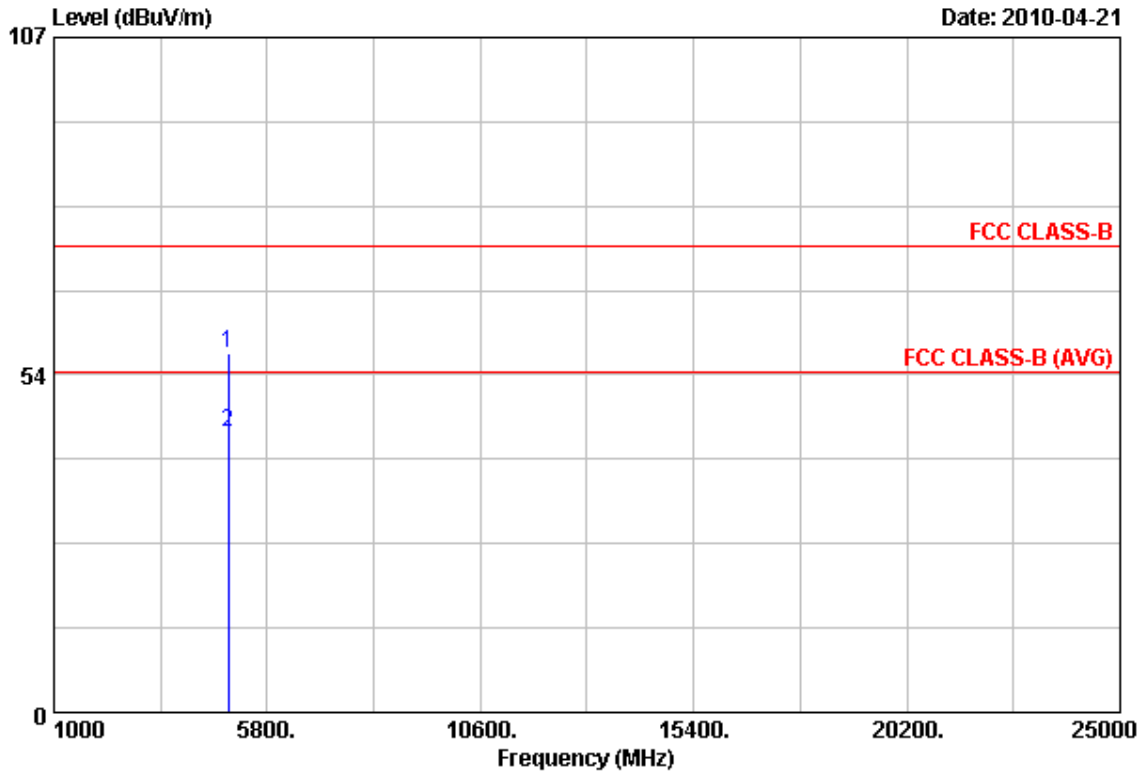

Item	Freq	Read Value	Factor	Result	Limit	Margin	Remark	Ant Pos	Tab Pos
	MHz	dBuV	dB/m	dBuV/m	dBuV/m	dB		cm	Deg
1	4923.78	49.02	8.03	57.05	74.00	-16.95	Peak	100	360
2	4924.10	36.34	8.03	44.37	54.00	-9.63	Average	100	360

Notes:

1. Result = Read Value + Factor
2. Factor = Antenna Factor + Cable Loss - Amplifier
3. The resolution bandwidth of test receiver/spectrum analyzer is 120KHz and video bandwidth is 300KHz for Peak detection and Quasi-peak detection at frequency below 1GHz.
4. The resolution bandwidth of test receiver/spectrum analyzer is 1MHz and video bandwidth is 3MHz for Peak detection at frequency above 1GHz.
5. The resolution bandwidth of test receiver/spectrum analyzer is 1MHz and video bandwidth is 10Hz for Average detection at frequency above 1GHz.
6. The other emissions is too low to be measured.
7. The data is worse case.



Power	: AC 120V	Pol/Phase	: HORIZONTAL
Test Mode 2	: 802.11n HT20, CH11	Temperature	: 26 °C
Memo	:	Humidity	: 61 %

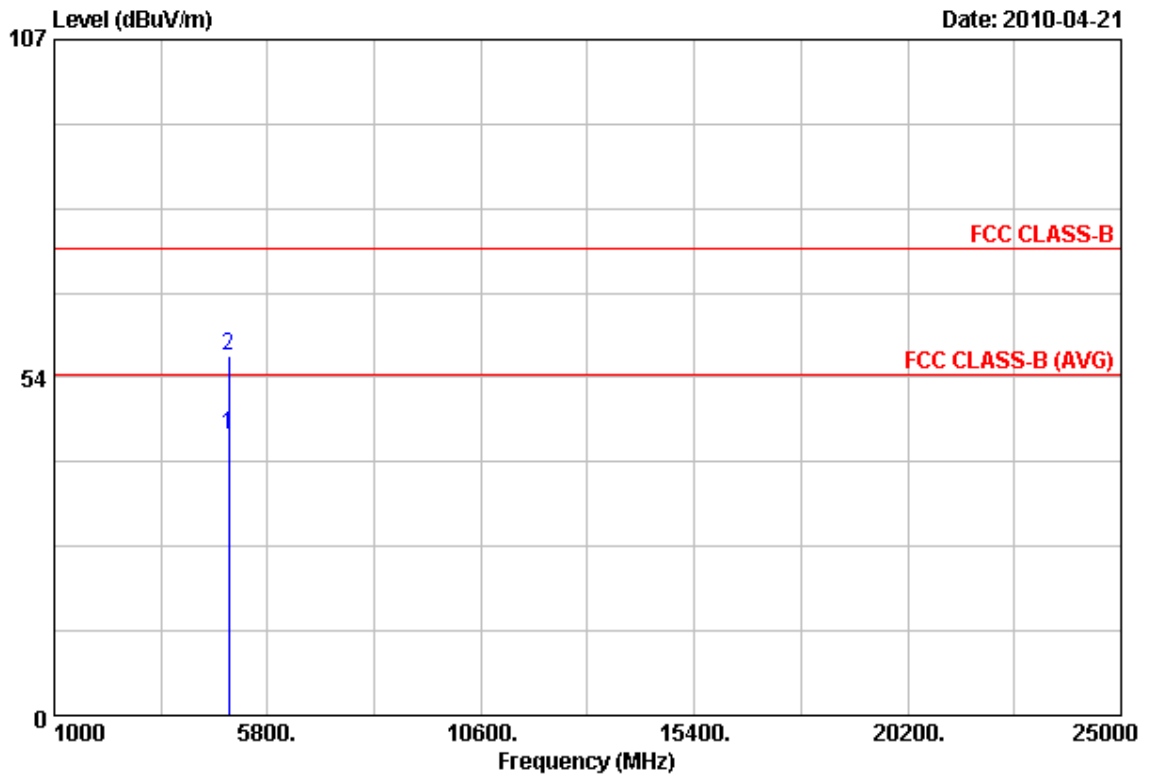

Item	Freq	Read Value	Factor	Result	Limit	Margin	Remark	Ant Pos	Tab Pos
	MHz	dBuV	dB/m	dBuV/m	dBuV/m	dB		cm	Deg
1	4923.85	36.33	8.03	44.36	54.00	-9.64	Average	100	0
2	4925.45	48.90	8.06	56.96	74.00	-17.04	Peak	100	0

Notes:

1. Result = Read Value + Factor
2. Factor = Antenna Factor + Cable Loss - Amplifier
3. The resolution bandwidth of test receiver/spectrum analyzer is 120KHz and video bandwidth is 300kHz for Peak detection and Quasi-peak detection at frequency below 1GHz.
4. The resolution bandwidth of test receiver/spectrum analyzer is 1MHz and video bandwidth is 3MHz for Peak detection at frequency above 1GHz.
5. The resolution bandwidth of test receiver/spectrum analyzer is 1MHz and video bandwidth is 10Hz for Average detection at frequency above 1GHz.
6. The other emissions is too low to be measured.
7. The data is worse case.



Power	: AC 120V	Pol/Phase	: VERTICAL
Test Mode 3	: 802.11n HT40, CH3	Temperature	: 26 °C
Memo	:	Humidity	: 61 %

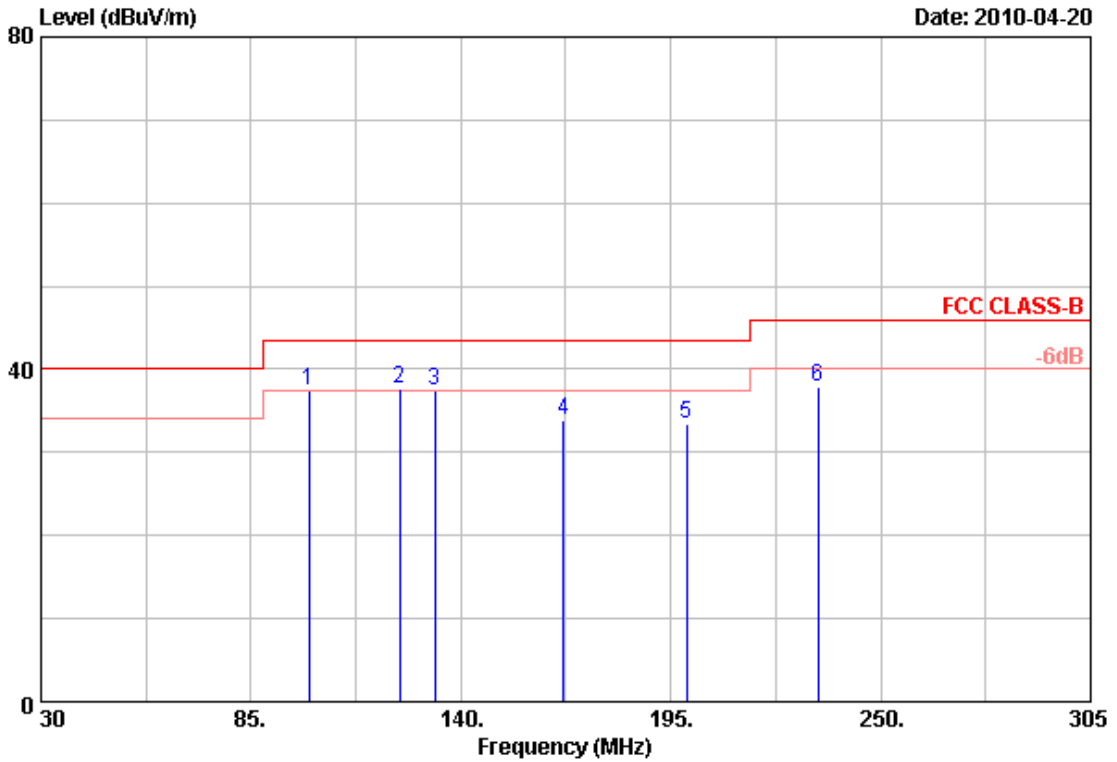

Item	Freq	Read Value	Factor	Result	Limit	Margin	Remark	Ant Pos	Tab Pos
	MHz	dBuV	dB/m	dBuV/m	dBuV/m	dB		cm	Deg
1	100.13	59.08	-21.62	37.46	43.50	-6.04	Peak	100	360
2	124.05	57.32	-19.56	37.76	43.50	-5.74	QP	100	360
3	133.13	56.83	-19.47	37.36	43.50	-6.14	Peak	100	360
4	166.95	55.97	-22.12	33.85	43.50	-9.65	Peak	100	360
5	199.13	53.03	-19.65	33.38	43.50	-10.12	Peak	100	360
6	233.50	59.65	-21.69	37.96	46.00	-8.04	Peak	100	360

Notes:

1. Result = Read Value + Factor
2. Factor = Antenna Factor + Cable Loss - Amplifier
3. The resolution bandwidth of test receiver/spectrum analyzer is 120KHz and video bandwidth is 300kHz for Peak detection and Quasi-peak detection at frequency below 1GHz.
4. All emission below 1GHz at 802.11b/g/n mode are all the same,so the 802.11g/n mode chosen as representative in final test.
5. According to technical experiences,all spurious emission of 802.11g/n mode at channel 1,6,11 or 3,6,9(for HT40) are almost the same below 1GHz,so that the channel 1 or 3(for HT40)was chosen as representative in final test.
6. The data is worse case.





Power	: AC 120V	Pol/Phase	: VERTICAL
Test Mode 3	: 802.11n HT40, CH3	Temperature	: 26 °C
Memo	:	Humidity	: 61 %

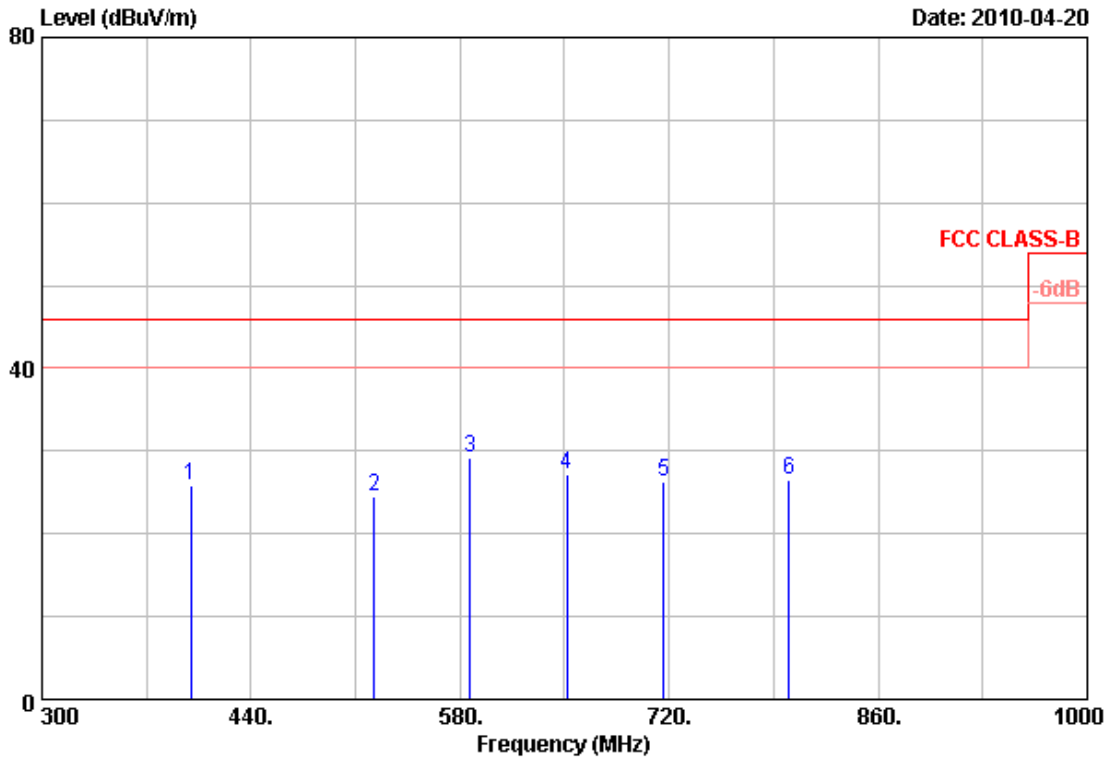

Item	Freq	Read Value	Factor	Result	Limit	Margin	Remark	Ant Pos	Tab Pos
	MHz	dBuV	dB/m	dBuV/m	dBuV/m	dB		cm	Deg
1	399.40	42.74	-16.97	25.77	46.00	-20.23	Peak	100	0
2	522.60	42.84	-18.33	24.51	46.00	-21.49	Peak	100	0
3	587.00	44.11	-14.86	29.25	46.00	-16.75	Peak	100	0
4	651.40	42.48	-15.31	27.17	46.00	-18.83	Peak	100	0
5	716.50	38.85	-12.59	26.26	46.00	-19.74	Peak	100	0
6	800.50	37.69	-11.09	26.60	46.00	-19.40	Peak	100	0

Notes:

1. Result = Read Value + Factor
2. Factor = Antenna Factor + Cable Loss - Amplifier
3. The resolution bandwidth of test receiver/spectrum analyzer is 120KHz and video bandwidth is 300kHz for Peak detection and Quasi-peak detection at frequency below 1GHz.
4. All emission below 1GHz at 802.11b/g/n mode are all the same,so the 802.11g/n mode chosen as representative in final test.
5. According to technical experiences,all spurious emission of 802.11g/n mode at channel 1,6,11 or 3,6,9(for HT40) are almost the same below 1GHz,so that the channel 1 or 3(for HT40)was chosen as representative in final test.
6. The data is worse case.



Power	: AC 120V	Pol/Phase	: HORIZONTAL
Test Mode 3	: 802.11n HT40, CH3	Temperature	: 26 °C
Memo	:	Humidity	: 61 %

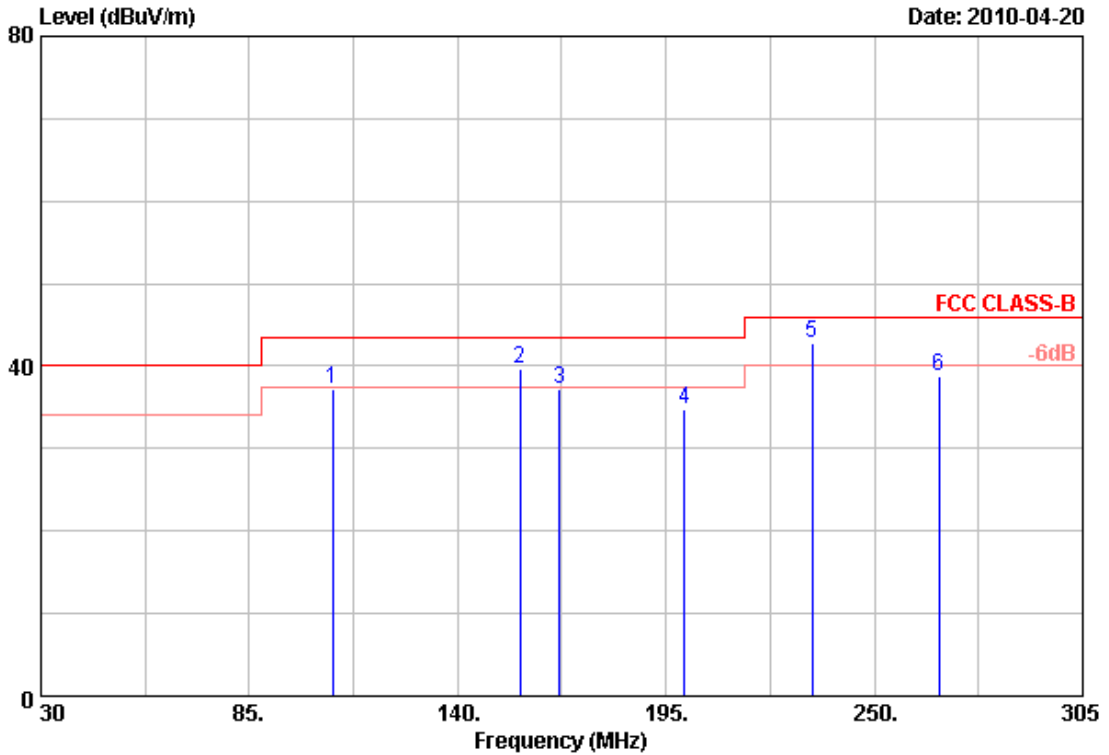

Item	Freq	Read Value	Factor	Result	Limit	Margin	Remark	Ant Pos	Tab Pos
	MHz	dBuV	dB/m	dBuV/m	dBuV/m	dB		cm	Deg
1	107.00	65.44	-28.14	37.30	43.50	-6.20	Peak	100	360
2	156.50	66.13	-26.43	39.70	43.50	-3.80	QP	100	360
3	166.95	64.40	-27.25	37.15	43.50	-6.35	Peak	100	360
4	199.95	62.08	-27.25	34.83	43.50	-8.67	Peak	100	360
5	233.50	68.87	-26.10	42.77	46.00	-3.23	QP	100	360
6	267.05	62.29	-23.53	38.76	46.00	-7.24	Peak	100	360

Notes:

1. Result = Read Value + Factor
2. Factor = Antenna Factor + Cable Loss - Amplifier
3. The resolution bandwidth of test receiver/spectrum analyzer is 120KHz and video bandwidth is 300kHz for Peak detection and Quasi-peak detection at frequency below 1GHz.
4. All emission below 1GHz at 802.11b/g/n mode are all the same,so the 802.11g/n mode chosen as representative in final test.
5. According to technical experiences,all spurious emission of 802.11g/n mode at channel 1,6,11 or 3,6,9(for HT40) are almost the same below 1GHz,so that the channel 1 or 3(for HT40)was chosen as representative in final test.
6. The data is worse case.



Power	: AC 120V	Pol/Phase	: HORIZONTAL
Test Mode 3	: 802.11n HT40, CH3	Temperature	: 26 °C
Memo	:	Humidity	: 61 %

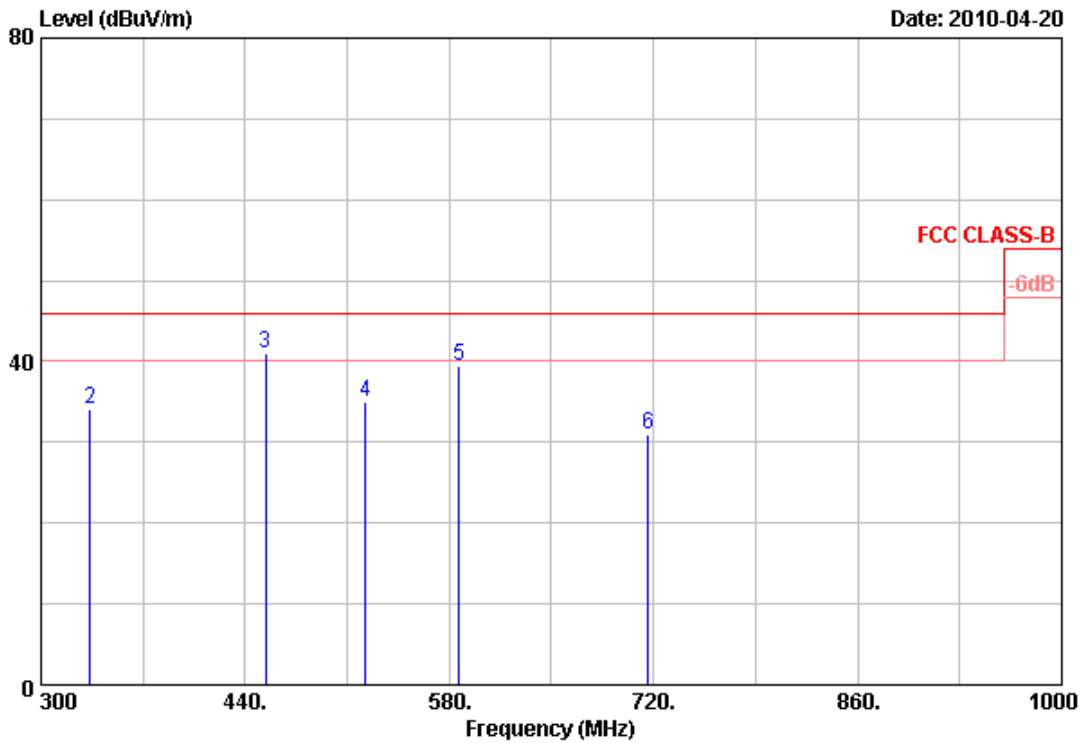

Item	Freq	Read Value	Factor	Result	Limit	Margin	Remark	Ant Pos	Tab Pos
	MHz	dBuV	dB/m	dBuV/m	dBuV/m	dB		cm	Deg
1	300.00	58.65	-23.01	35.64	46.00	-10.36	Peak	100	0
2	333.60	55.70	-21.56	34.14	46.00	-11.86	Peak	100	0
3	454.00	56.22	-15.28	40.94	46.00	-5.06	QP	100	0
4	522.60	51.05	-16.07	34.98	46.00	-11.02	Peak	100	0
5	587.00	51.45	-12.05	39.40	46.00	-6.60	Peak	100	0
6	716.50	44.09	-13.18	30.91	46.00	-15.09	Peak	100	0

Notes:

1. Result = Read Value + Factor
2. Factor = Antenna Factor + Cable Loss - Amplifier
3. The resolution bandwidth of test receiver/spectrum analyzer is 120KHz and video bandwidth is 300kHz for Peak detection and Quasi-peak detection at frequency below 1GHz.
4. All emission below 1GHz at 802.11b/g/n mode are all the same,so the 802.11g/n mode chosen as representative in final test.
5. According to technical experiences,all spurious emission of 802.11g/n mode at channel 1,6,11 or 3,6,9(for HT40) are almost the same below 1GHz,so that the channel 1 or 3(for HT40)was chosen as representative in final test.
6. The data is worse case.



Power	: AC 120V	Pol/Phase	: VERTICAL
Test Mode 3	: 802.11n HT40, CH3	Temperature	: 26 °C
Memo	:	Humidity	: 61 %

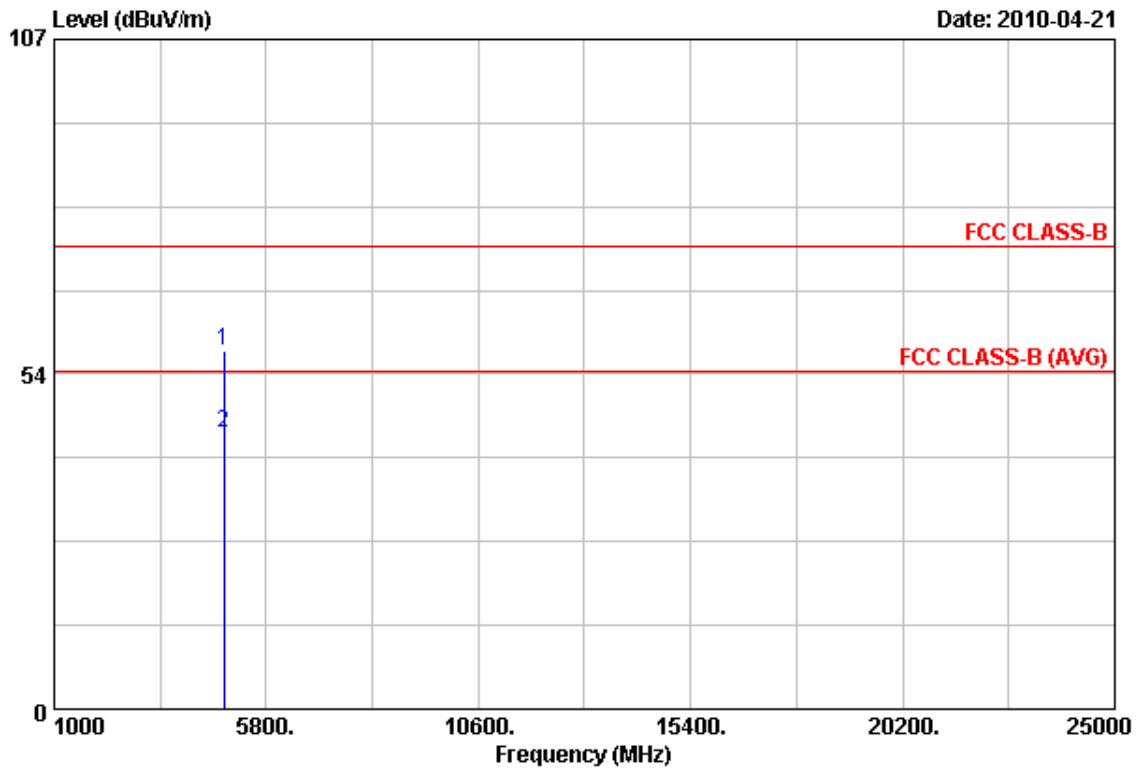

Item	Freq	Read Value	Factor	Result	Limit	Margin	Remark	Ant Pos	Tab Pos
	MHz	dBuV	dB/m	dBuV/m	dBuV/m	dB		cm	Deg
1	4842.10	49.36	7.77	57.13	74.00	-16.87	Peak	100	360
2	4843.60	36.27	7.77	44.04	54.00	-9.96	Average	100	360

Notes:

1. Result = Read Value + Factor
2. Factor = Antenna Factor + Cable Loss - Amplifier
3. The resolution bandwidth of test receiver/spectrum analyzer is 120KHz and video bandwidth is 300kHz for Peak detection and Quasi-peak detection at frequency below 1GHz.
4. The resolution bandwidth of test receiver/spectrum analyzer is 1MHz and video bandwidth is 3MHz for Peak detection at frequency above 1GHz.
5. The resolution bandwidth of test receiver/spectrum analyzer is 1MHz and video bandwidth is 10Hz for Average detection at frequency above 1GHz.
6. The other emissions is too low to be measured.
7. The data is worse case.



Power	: AC 120V	Pol/Phase	: HORIZONTAL
Test Mode 3	: 802.11n HT40, CH3	Temperature	: 26 °C
Memo	:	Humidity	: 61 %

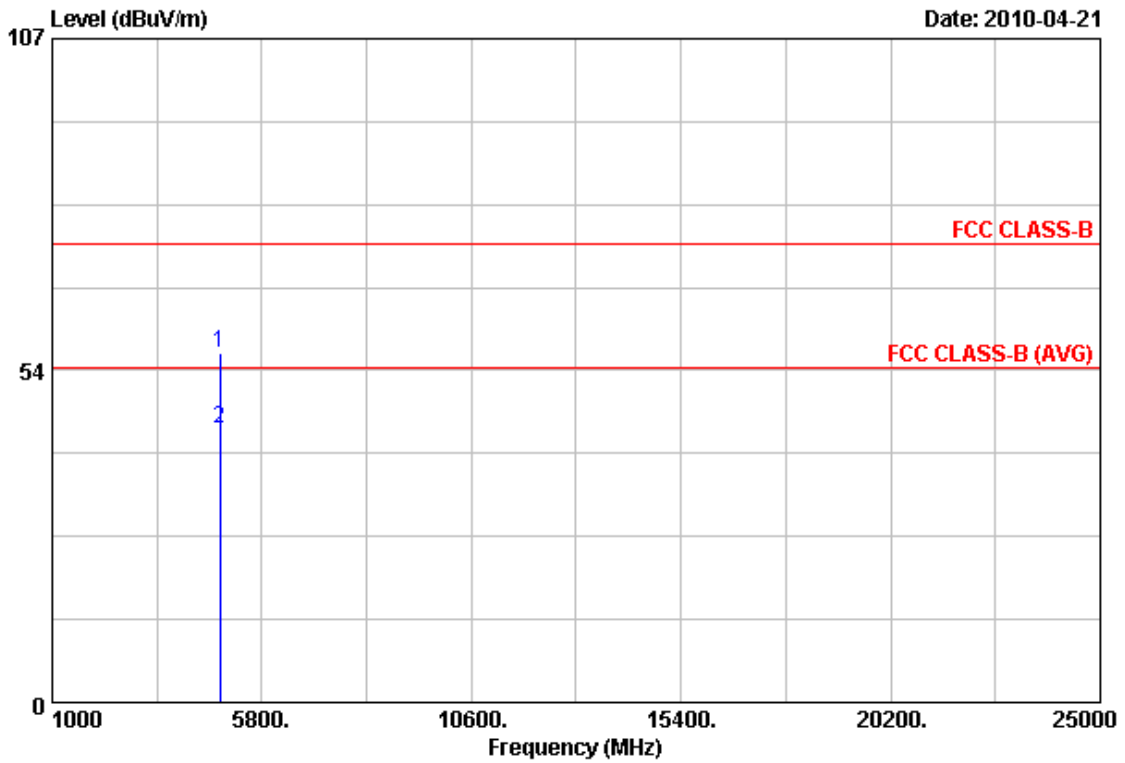

Item	Freq	Read Value	Factor	Result	Limit	Margin	Remark	Ant Pos	Tab Pos
	MHz	dBuV	dB/m	dBuV/m	dBuV/m	dB		cm	Deg
1	4841.18	48.54	7.76	56.30	74.00	-17.70	Peak	100	0
2	4842.78	36.22	7.77	43.99	54.00	-10.01	Average	100	0

Notes:

1. Result = Read Value + Factor
2. Factor = Antenna Factor + Cable Loss - Amplifier
3. The resolution bandwidth of test receiver/spectrum analyzer is 120KHz and video bandwidth is 300kHz for Peak detection and Quasi-peak detection at frequency below 1GHz.
4. The resolution bandwidth of test receiver/spectrum analyzer is 1MHz and video bandwidth is 3MHz for Peak detection at frequency above 1GHz.
5. The resolution bandwidth of test receiver/spectrum analyzer is 1MHz and video bandwidth is 10Hz for Average detection at frequency above 1GHz.
6. The other emissions is too low to be measured.
7. The data is worse case.



Power	: AC 120V	Pol/Phase	: VERTICAL
Test Mode 3	: 802.11n HT40, CH6	Temperature	: 26 °C
Memo	:	Humidity	: 61 %

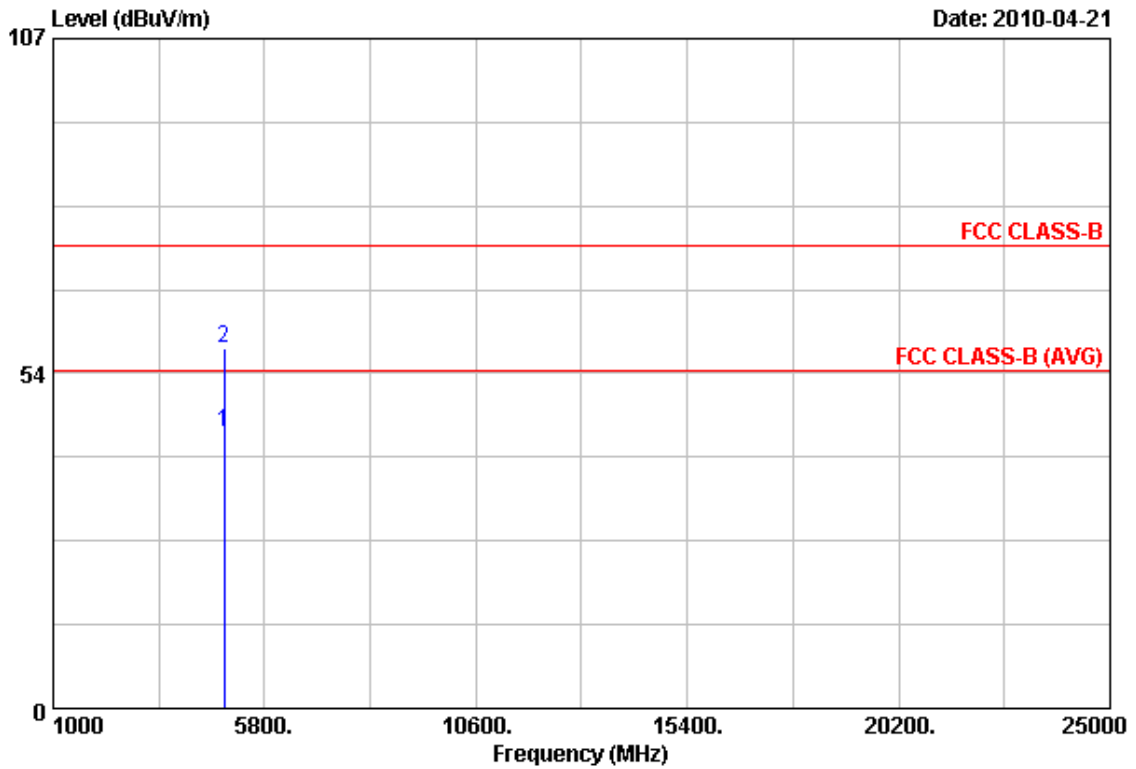

Item	Freq	Read Value	Factor	Result	Limit	Margin	Remark	Ant Pos	Tab Pos
	MHz	dBuV	dB/m	dBuV/m	dBuV/m	dB		cm	Deg
1	4873.95	36.36	7.86	44.22	54.00	-9.78	Average	100	360
2	4875.05	49.55	7.89	57.44	74.00	-16.56	Peak	100	360

Notes:

1. Result = Read Value + Factor
2. Factor = Antenna Factor + Cable Loss - Amplifier
3. The resolution bandwidth of test receiver/spectrum analyzer is 120KHz and video bandwidth is 300kHz for Peak detection and Quasi-peak detection at frequency below 1GHz.
4. The resolution bandwidth of test receiver/spectrum analyzer is 1MHz and video bandwidth is 3MHz for Peak detection at frequency above 1GHz.
5. The resolution bandwidth of test receiver/spectrum analyzer is 1MHz and video bandwidth is 10Hz for Average detection at frequency above 1GHz.
6. The other emissions is too low to be measured.
7. The data is worse case.



Power	: AC 120V	Pol/Phase	: HORIZONTAL
Test Mode 3	: 802.11n HT40, CH6	Temperature	: 26 °C
Memo	:	Humidity	: 61 %

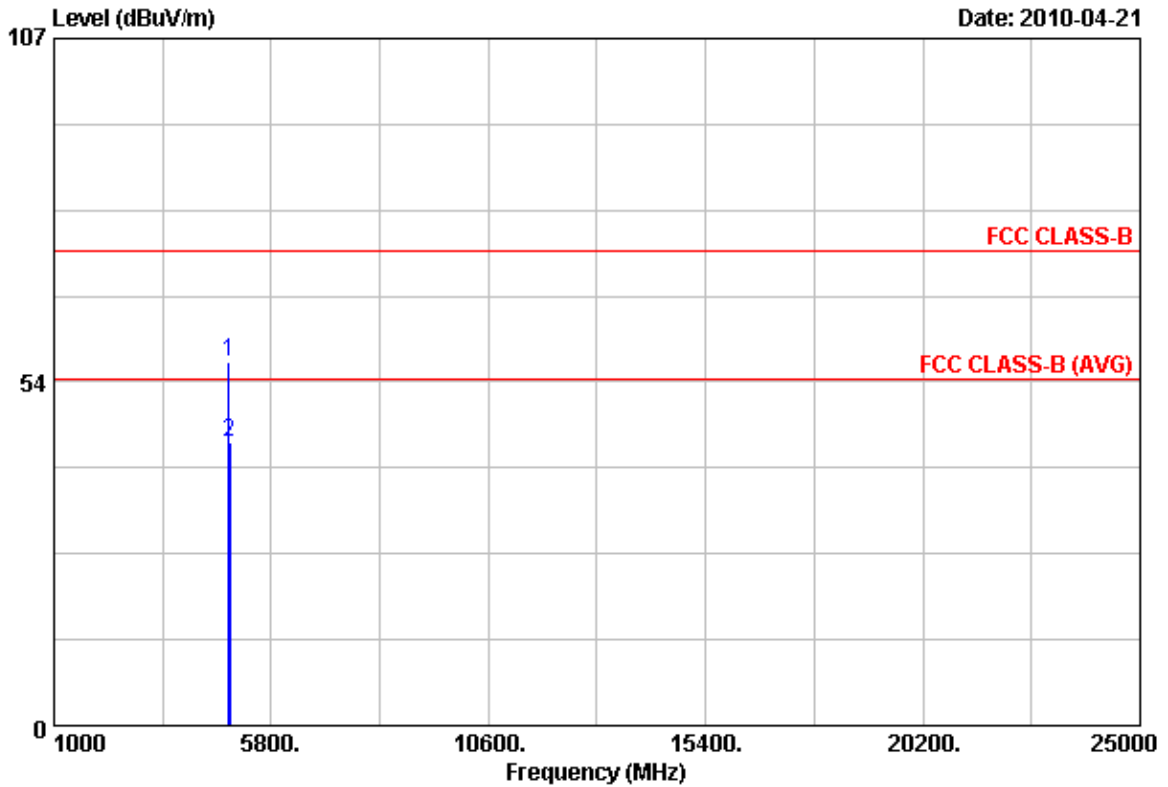

Item	Freq	Read Value	Factor	Result	Limit	Margin	Remark	Ant Pos	Tab Pos
	MHz	dBuV	dB/m	dBuV/m	dBuV/m	dB		cm	Deg
1	4869.90	48.77	7.86	56.63	74.00	-17.37	Peak	100	0
2	4873.25	36.32	7.86	44.18	54.00	-9.82	Average	100	0

Notes:

1. Result = Read Value + Factor
2. Factor = Antenna Factor + Cable Loss - Amplifier
3. The resolution bandwidth of test receiver/spectrum analyzer is 120KHz and video bandwidth is 300kHz for Peak detection and Quasi-peak detection at frequency below 1GHz.
4. The resolution bandwidth of test receiver/spectrum analyzer is 1MHz and video bandwidth is 3MHz for Peak detection at frequency above 1GHz.
5. The resolution bandwidth of test receiver/spectrum analyzer is 1MHz and video bandwidth is 10Hz for Average detection at frequency above 1GHz.
6. The other emissions is too low to be measured.
7. The data is worse case.



Power	: AC 120V	Pol/Phase	: VERTICAL
Test Mode 3	: 802.11n HT40, CH9	Temperature	: 26 °C
Memo	:	Humidity	: 61 %

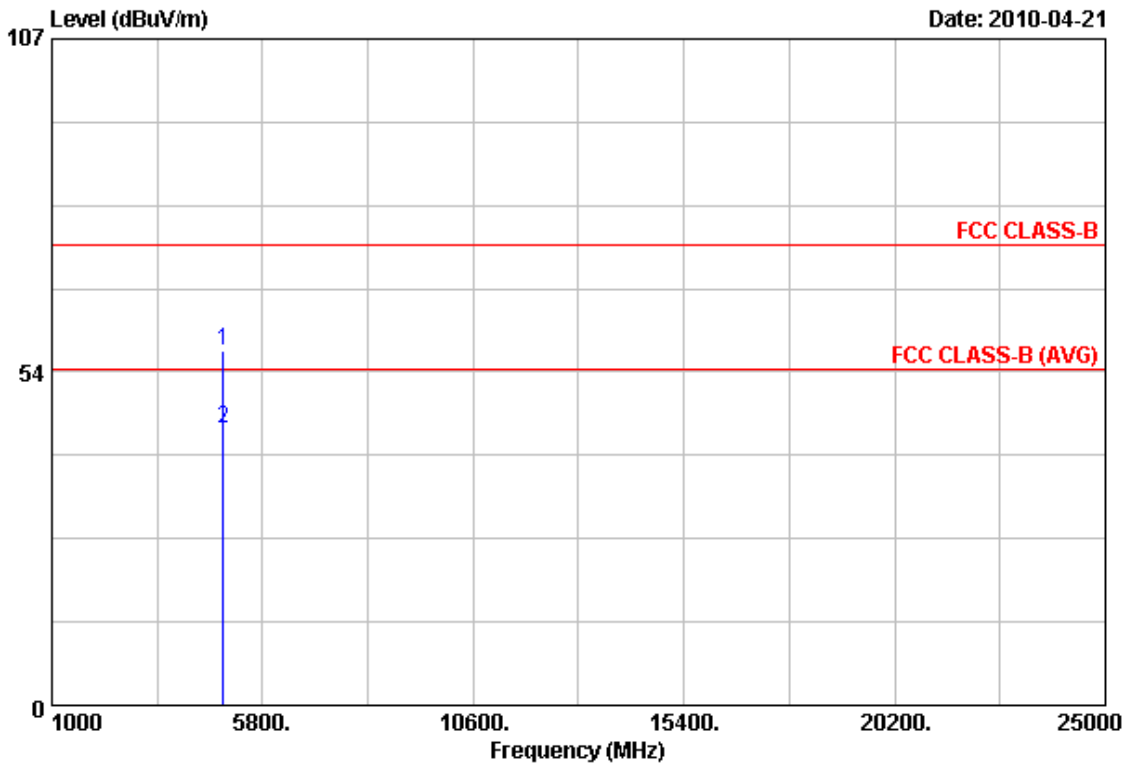

Item	Freq	Read Value	Factor	Result	Limit	Margin	Remark	Ant Pos	Tab Pos
	MHz	dBuV	dB/m	dBuV/m	dBuV/m	dB		cm	Deg
1	4901.50	48.84	7.96	56.80	74.00	-17.20	Peak	100	360
2	4904.53	36.32	7.98	44.30	54.00	-9.70	Average	100	360

Notes:

1. Result = Read Value + Factor
2. Factor = Antenna Factor + Cable Loss - Amplifier
3. The resolution bandwidth of test receiver/spectrum analyzer is 120kHz and video bandwidth is 300kHz for Peak detection and Quasi-peak detection at frequency below 1GHz.
4. The resolution bandwidth of test receiver/spectrum analyzer is 1MHz and video bandwidth is 3MHz for Peak detection at frequency above 1GHz.
5. The resolution bandwidth of test receiver/spectrum analyzer is 1MHz and video bandwidth is 10Hz for Average detection at frequency above 1GHz.
6. The other emissions is too low to be measured.
7. The data is worse case.





Power	: AC 120V	Pol/Phase	: HORIZONTAL
Test Mode 3	: 802.11n HT40, CH9	Temperature	: 26 °C
Memo	:	Humidity	: 61 %

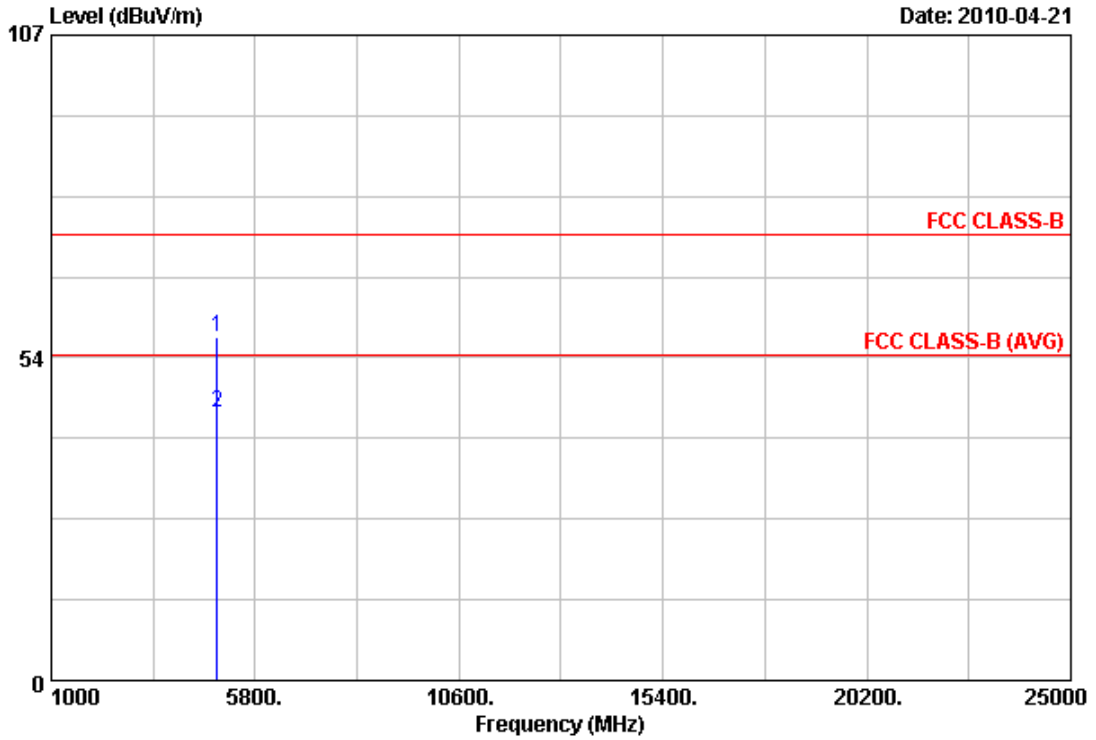

Item	Freq	Read Value	Factor	Result	Limit	Margin	Remark	Ant Pos	Tab Pos
	MHz	dBuV	dB/m	dBuV/m	dBuV/m	dB		cm	Deg
1	4901.23	48.85	7.96	56.81	74.00	-17.19	Peak	100	0
2	4905.10	36.32	7.98	44.30	54.00	-9.70	Average	100	0

Notes:

1. Result = Read Value + Factor
2. Factor = Antenna Factor + Cable Loss - Amplifier
3. The resolution bandwidth of test receiver/spectrum analyzer is 120KHz and video bandwidth is 300kHz for Peak detection and Quasi-peak detection at frequency below 1GHz.
4. The resolution bandwidth of test receiver/spectrum analyzer is 1MHz and video bandwidth is 3MHz for Peak detection at frequency above 1GHz.
5. The resolution bandwidth of test receiver/spectrum analyzer is 1MHz and video bandwidth is 10Hz for Average detection at frequency above 1GHz.
6. The other emissions is too low to be measured.
7. The data is worse case.

Test engineer: Ben



### 5.6 Test Photographs

Front View



Rear View





## 6. 6dB Bandwidth Measurement Data

### 6.1 Test Limit

The minimum of 6dB Bandwidth Measurement is 0.5 MHz.

### 6.2 Test Procedures

- a. The transmitter output was connected to the spectrum analyzer.
- b. Set RBW of spectrum analyzer to 100 KHz and VBW to 100 KHz.
- c. The 6 dB bandwidth is defined as the total spectrum the power of which is higher than peak power minus 6 dB.

### 6.3 Test Setup Layout

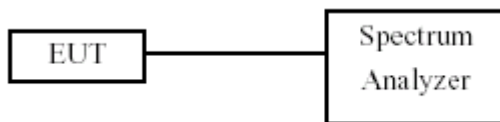

### 6.4 Measurement Equipment

Instrument/Ancillary	Manufacturer	Model No.	Serial No.	Calibration Date	Valid Date
Spectrum Analyzer	R&S	FSP40	100219	2009/11/20	2010/11/19

### 6.5 Test Result and Data

Test Date: Apr. 15, 2010

Temperature: 25°C

Atmospheric pressure: 1022 hPa

Humidity: 65%

Modulation Standard	Channel	Frequency (MHz)	6dB Bandwidth (MHz)	
			Ant1	Ant2
802.11b (11Mbps)	01	2412	12.3	12.6
	06	2437	12.3	12.1
	11	2462	12.2	12.0
802.11g (54Mbps)	01	2412	16.6	16.6
	06	2437	16.6	16.6
	11	2462	16.6	16.6
802.11n HT20 (130Mbps)	01	2412	17.7	17.7
	06	2437	17.9	17.8
	11	2462	17.7	17.7
802.11n HT40 (270Mbps)	03	2422	36.2	36.2
	06	2437	36.4	36.4
	09	2452	36.2	36.4



Modulation Standard: 802.11b (11Mbps), Ant1  
Channel: 01

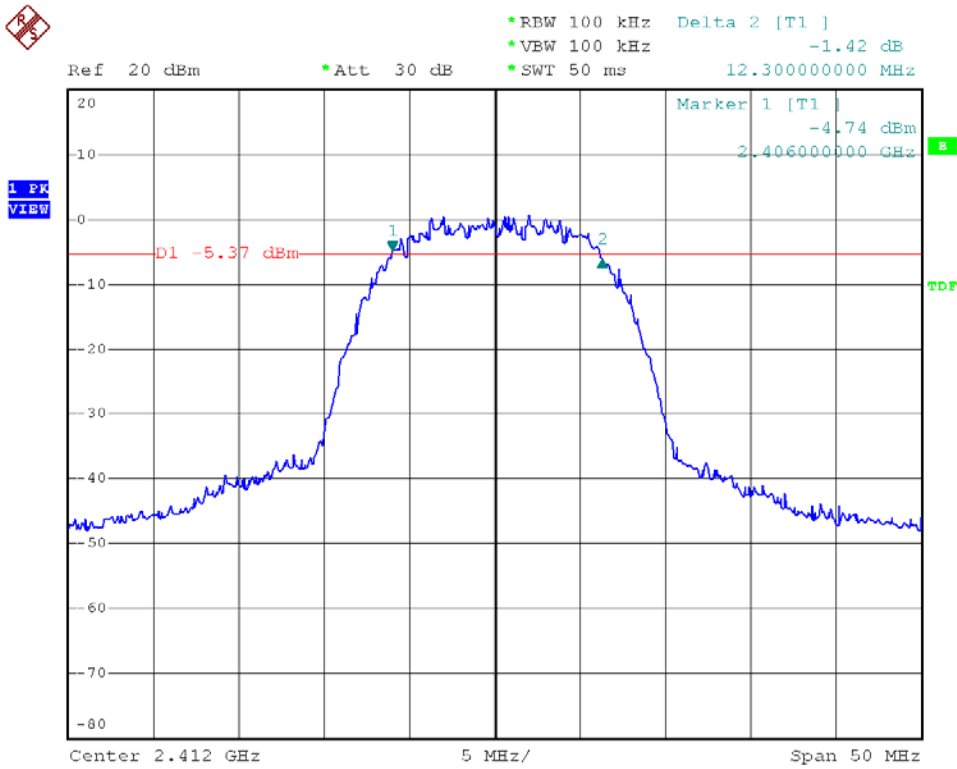

Modulation Standard: 802.11b (11Mbps), Ant1  
Channel: 06

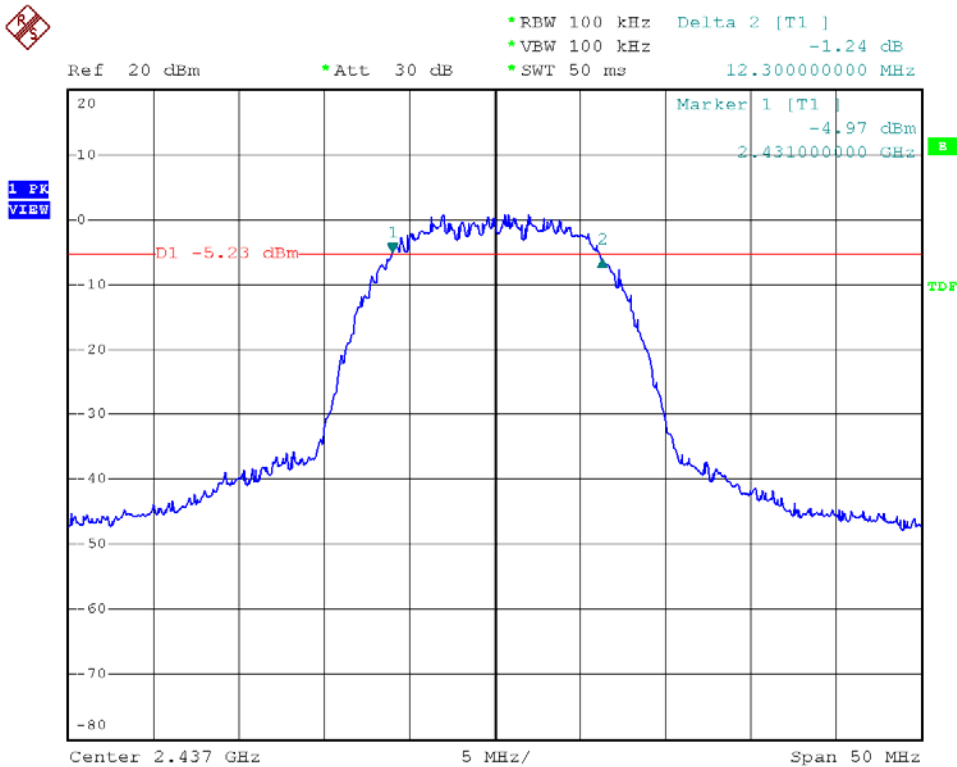



Modulation Standard: 802.11b (11Mbps), Ant1  
Channel: 11

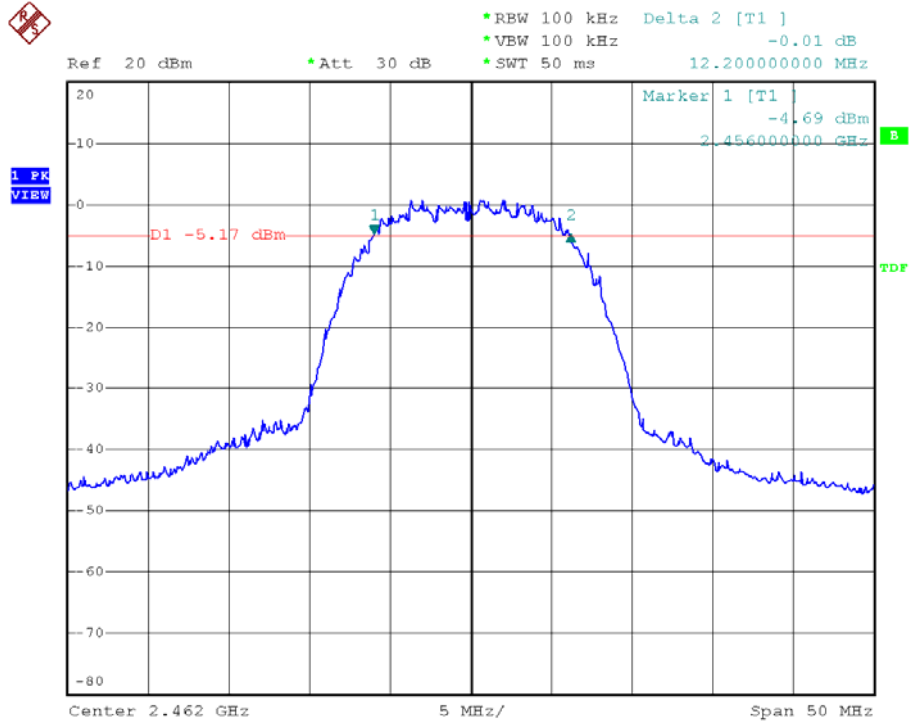

Modulation Standard: 802.11b (11Mbps), Ant2  
Channel: 01

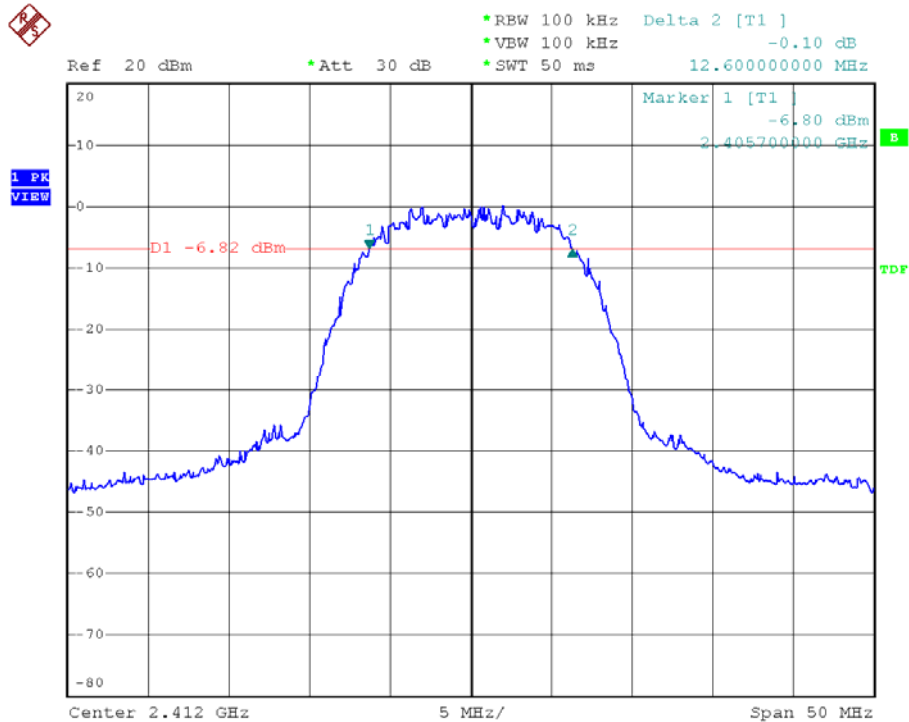



Modulation Standard: 802.11b (11Mbps), Ant2  
Channel: 06

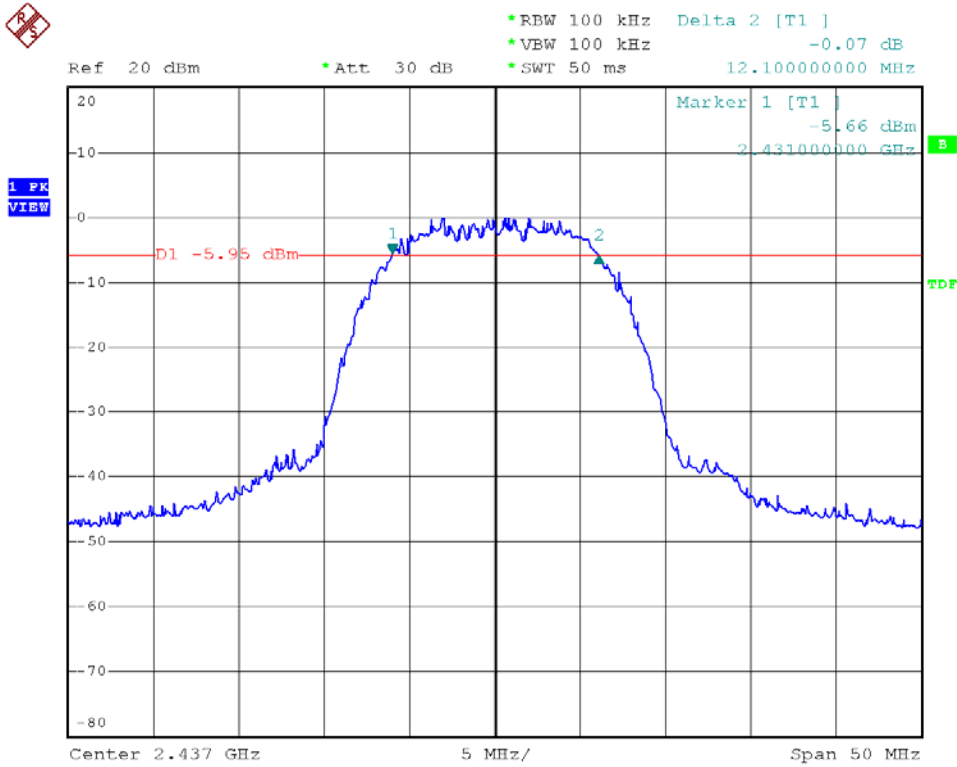

Modulation Standard: 802.11b (11Mbps), Ant2  
Channel: 11

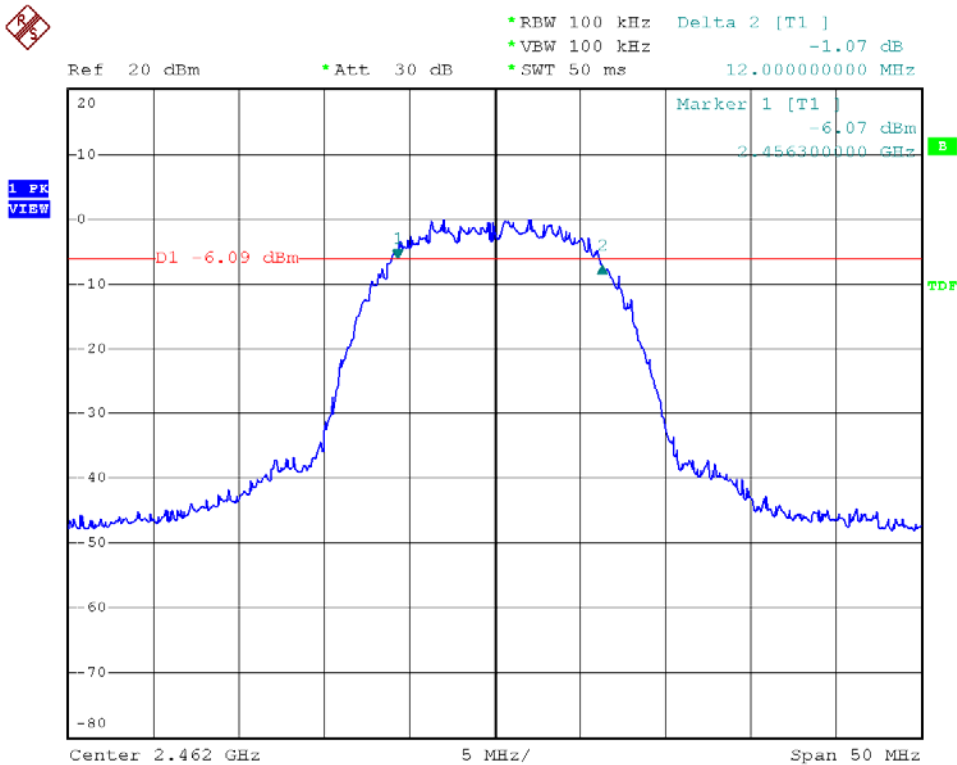



Modulation Standard: 802.11g (54Mbps), Ant1  
Channel: 01

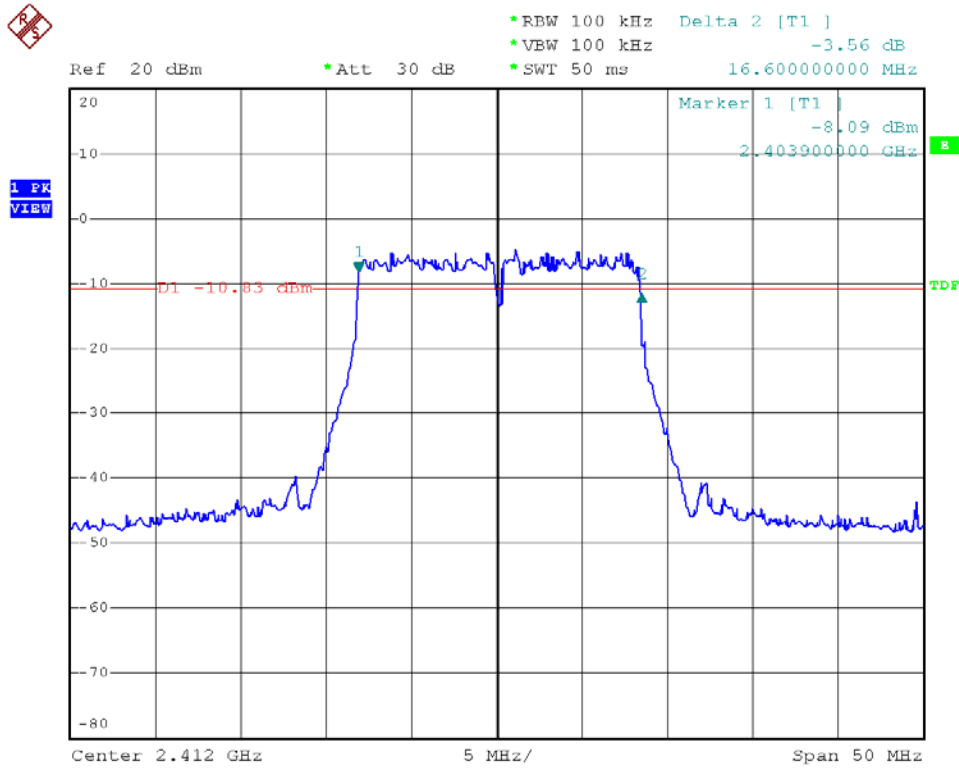

Modulation Standard: 802.11g (54Mbps), Ant1  
Channel: 06

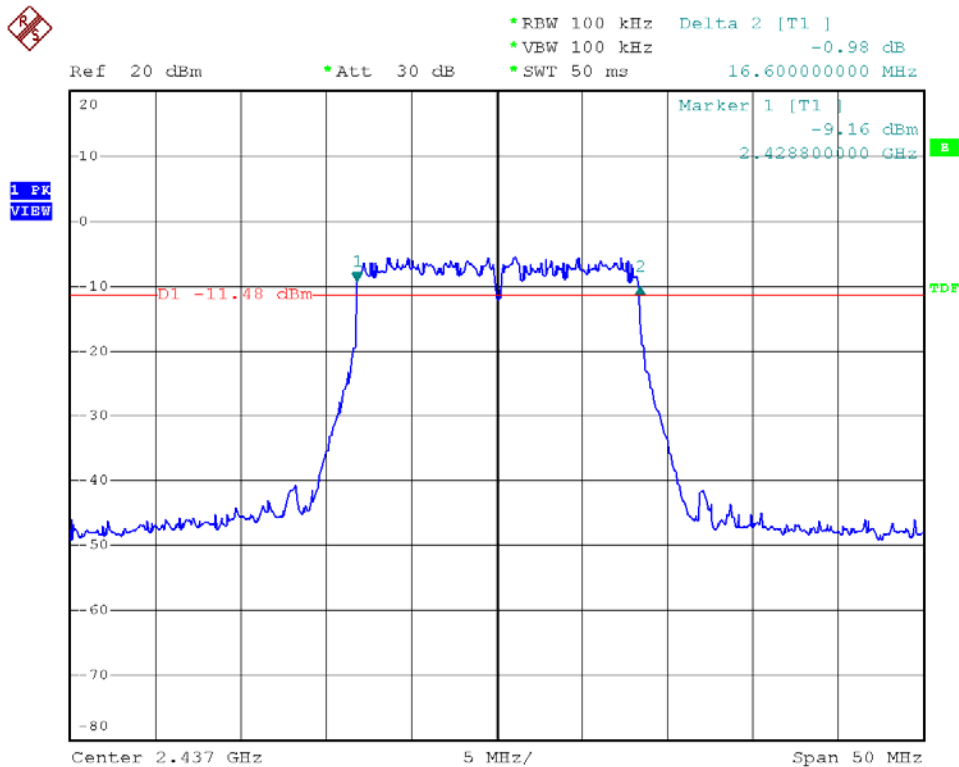



Modulation Standard: 802.11g (54Mbps), Ant1  
Channel: 11

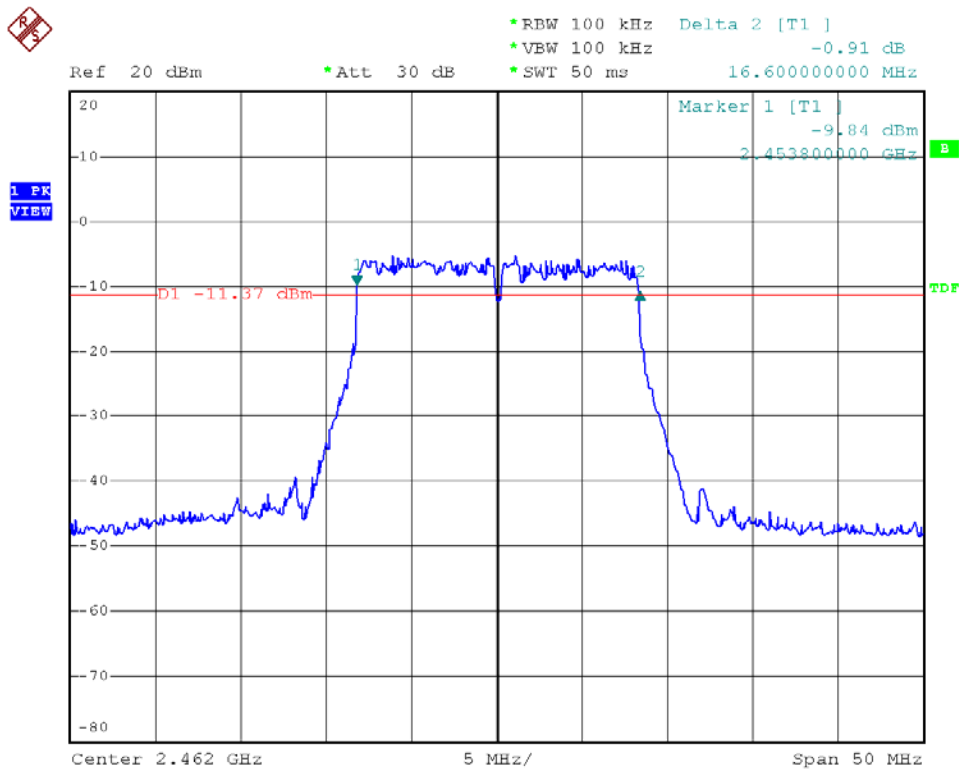

Modulation Standard: 802.11g (54Mbps), Ant2  
Channel: 01

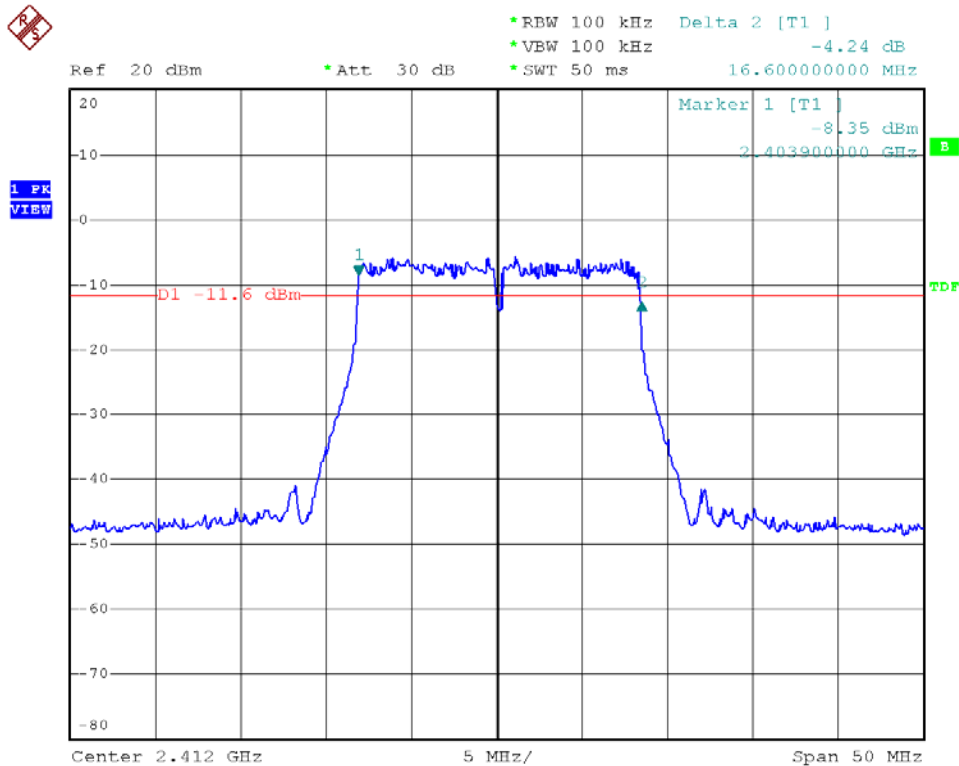





Modulation Standard: 802.11g (54Mbps), Ant2  
Channel: 06

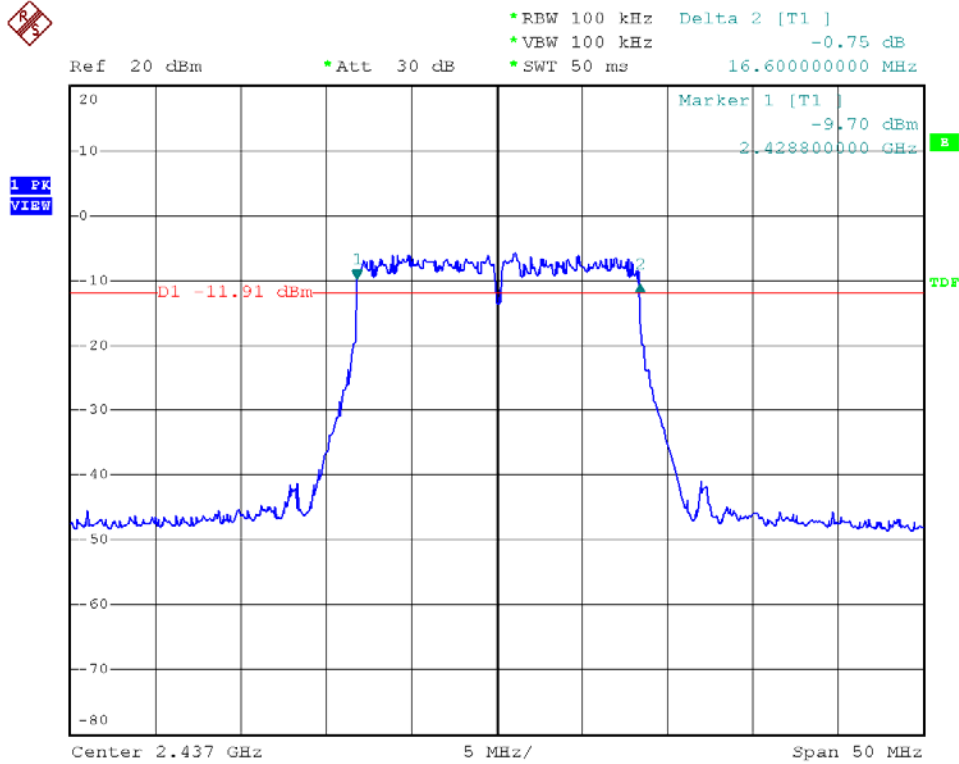

Modulation Standard: 802.11g (54Mbps), Ant2  
Channel: 11

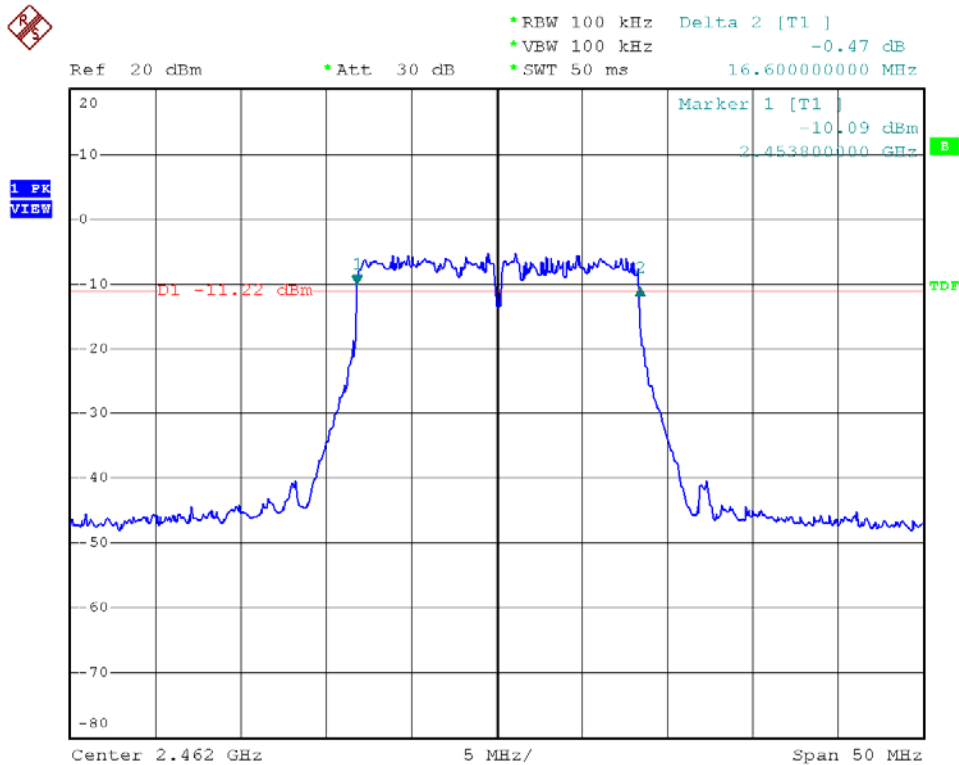



Modulation Standard: 802.11n HT20 (130Mbps), Ant1  
Channel: 01

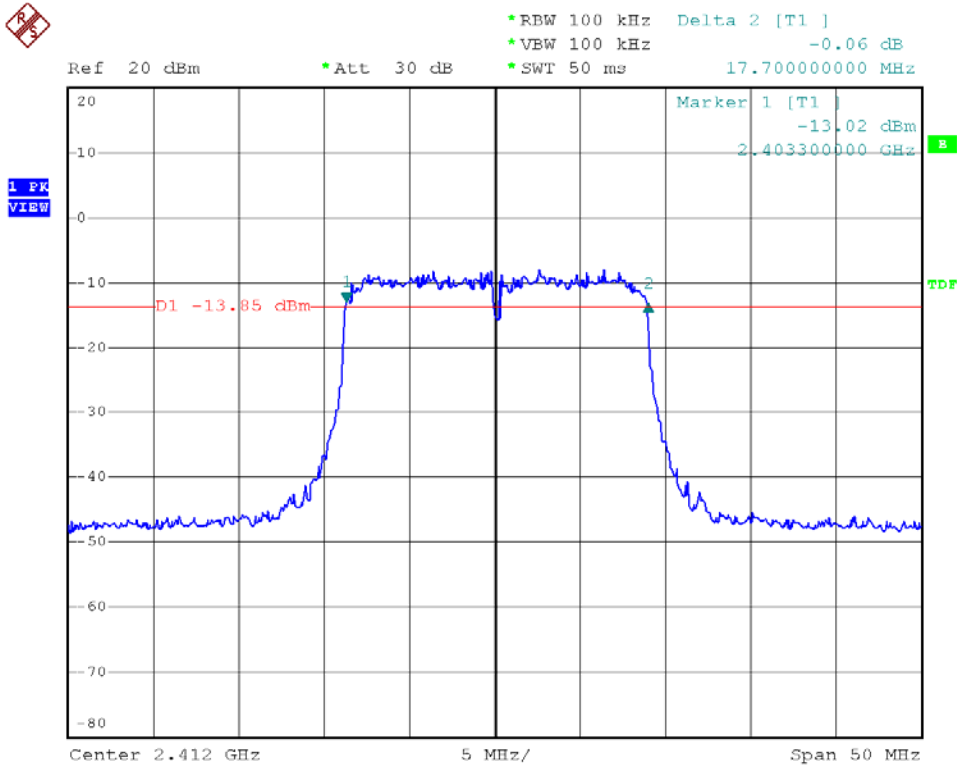

Modulation Standard: 802.11n HT20 (130Mbps), Ant1  
Channel: 06

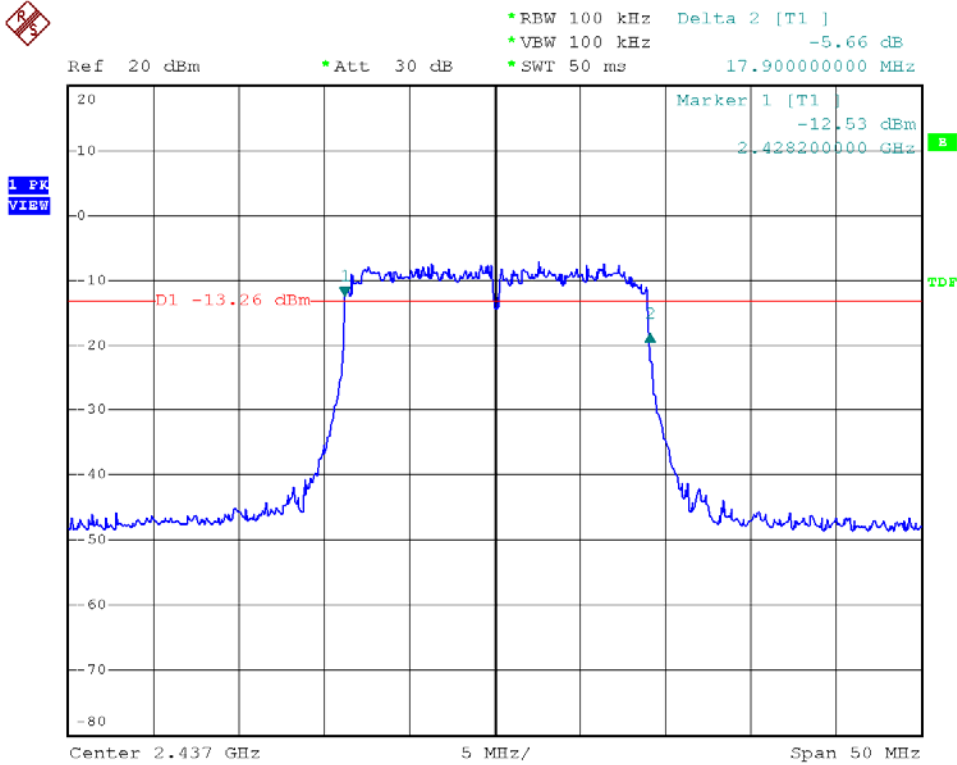



Modulation Standard: 802.11n HT20 (130Mbps), Ant1  
Channel: 11

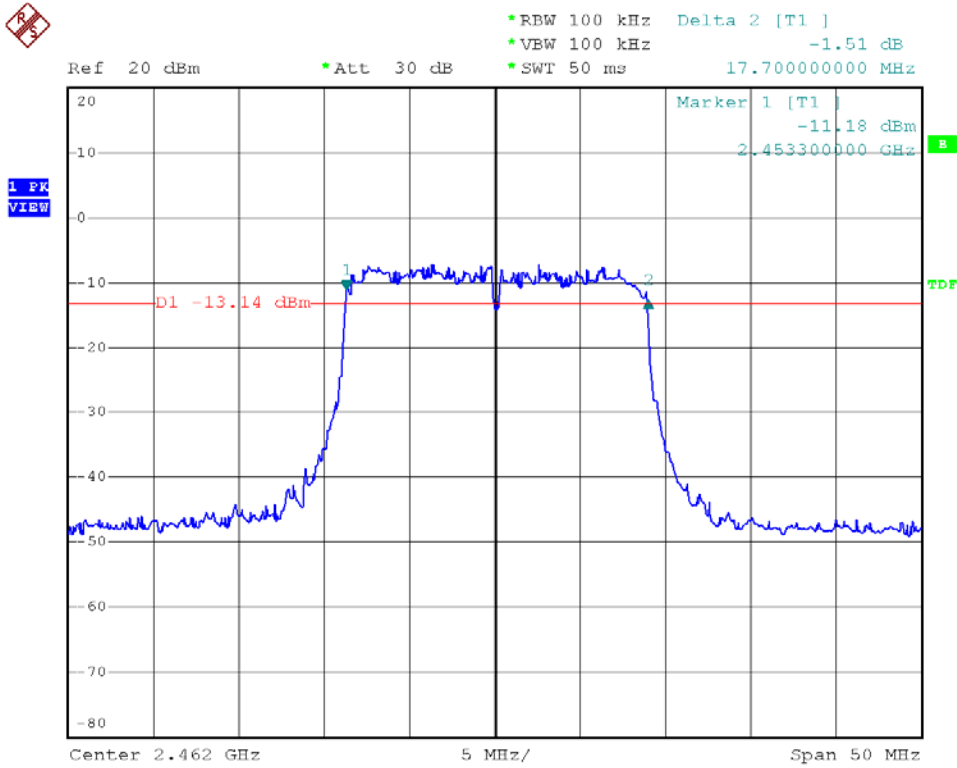

Modulation Standard: 802.11n HT20 (130Mbps), Ant2  
Channel: 01

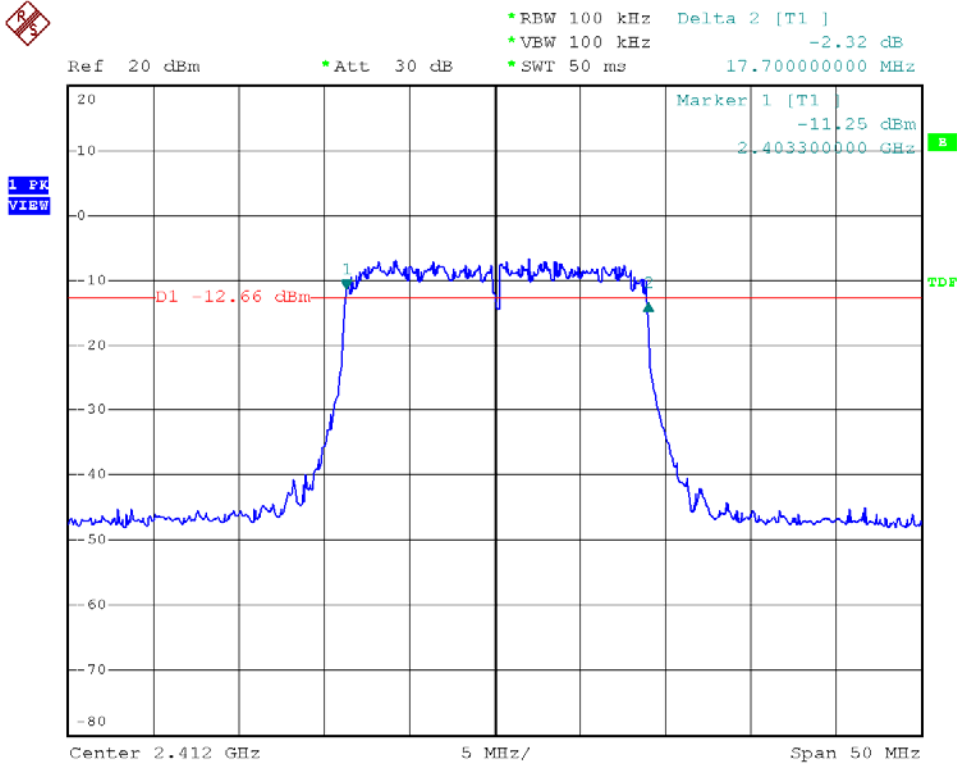



Modulation Standard: 802.11n HT20 (130Mbps), Ant2  
Channel: 06

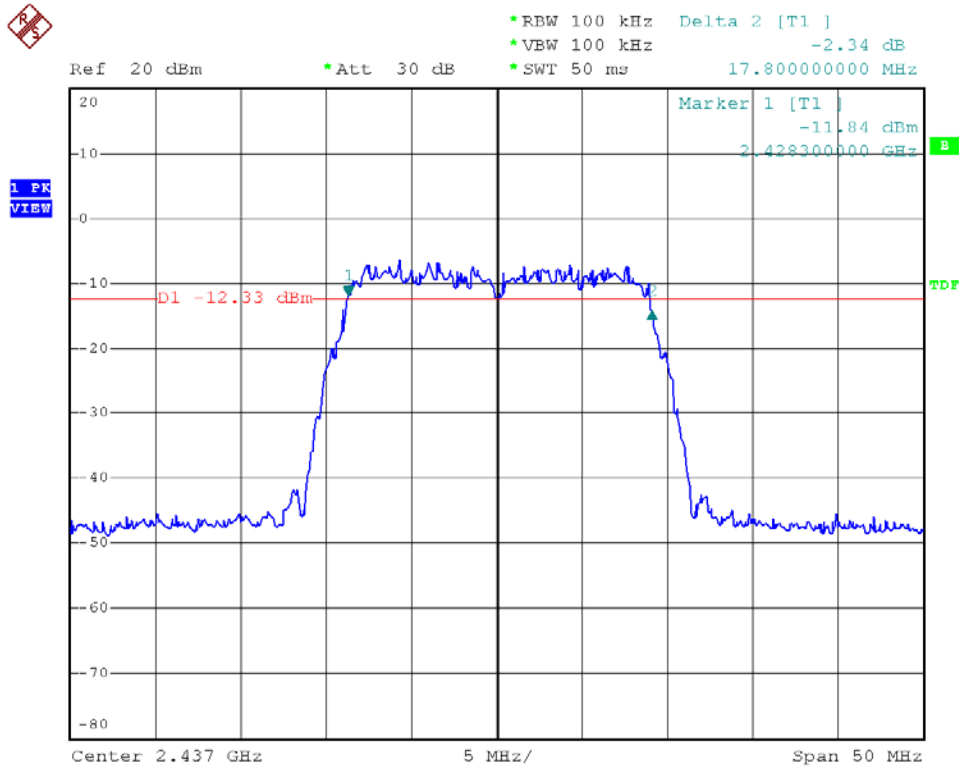

Modulation Standard: 802.11n HT20 (130Mbps), Ant2  
Channel: 11

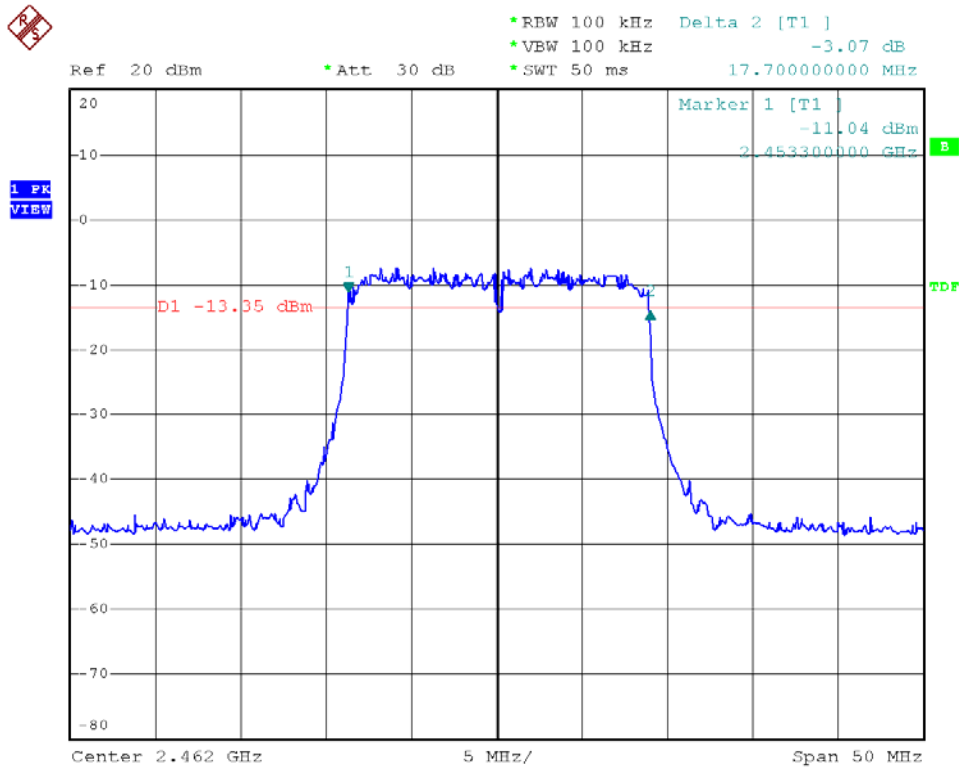



Modulation Standard: 802.11n HT40 (270Mbps), Ant1  
Channel: 03

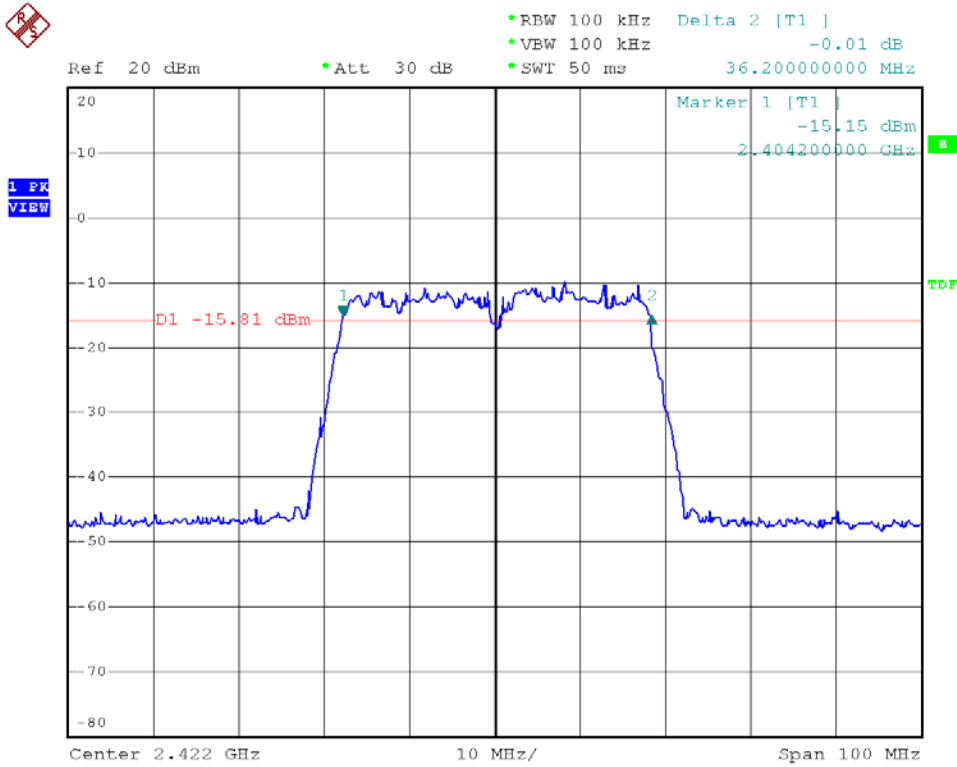

Modulation Standard: 802.11n HT40 (270Mbps), Ant1  
Channel: 06

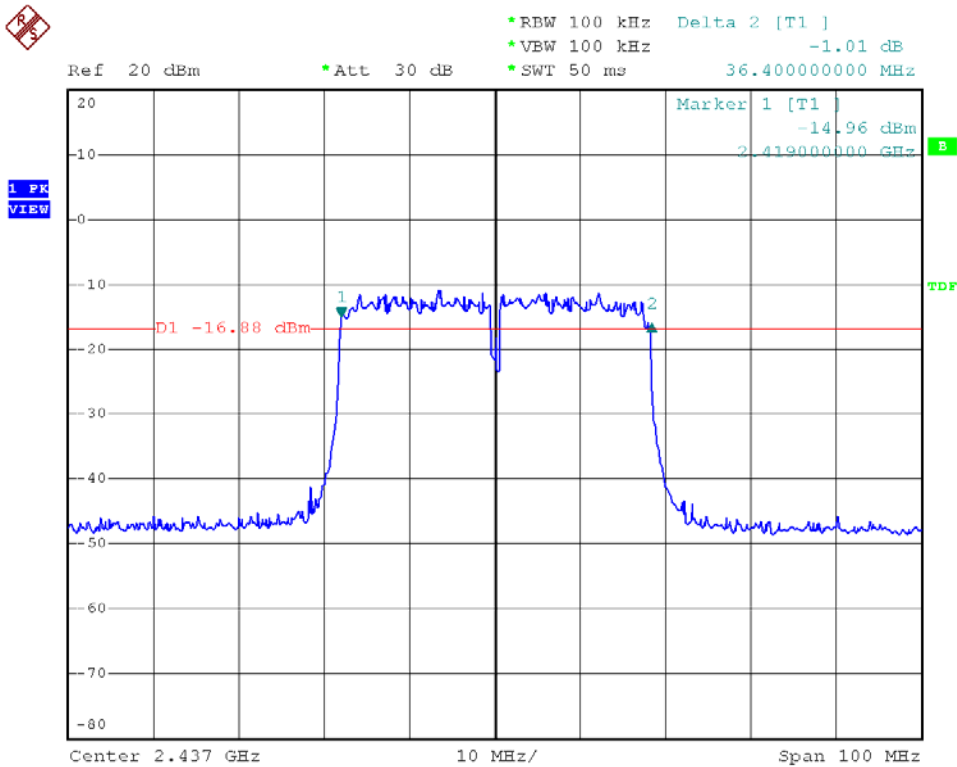



Modulation Standard: 802.11n HT40 (270Mbps), Ant1  
Channel: 09

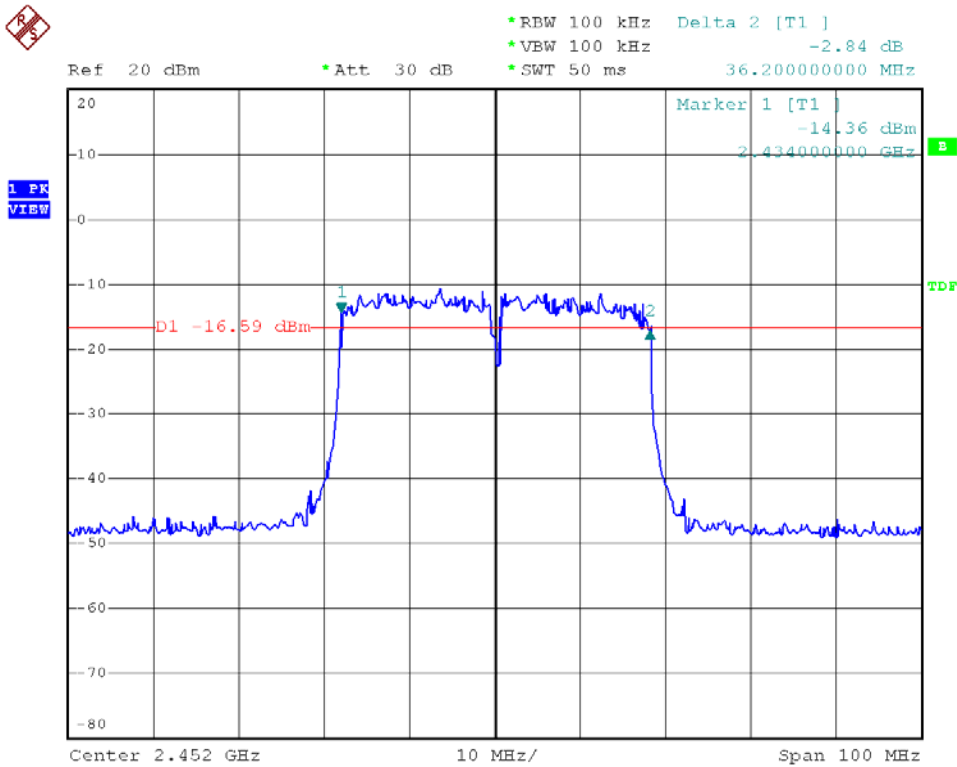

Modulation Standard: 802.11n HT40 (270Mbps), Ant2  
Channel: 03

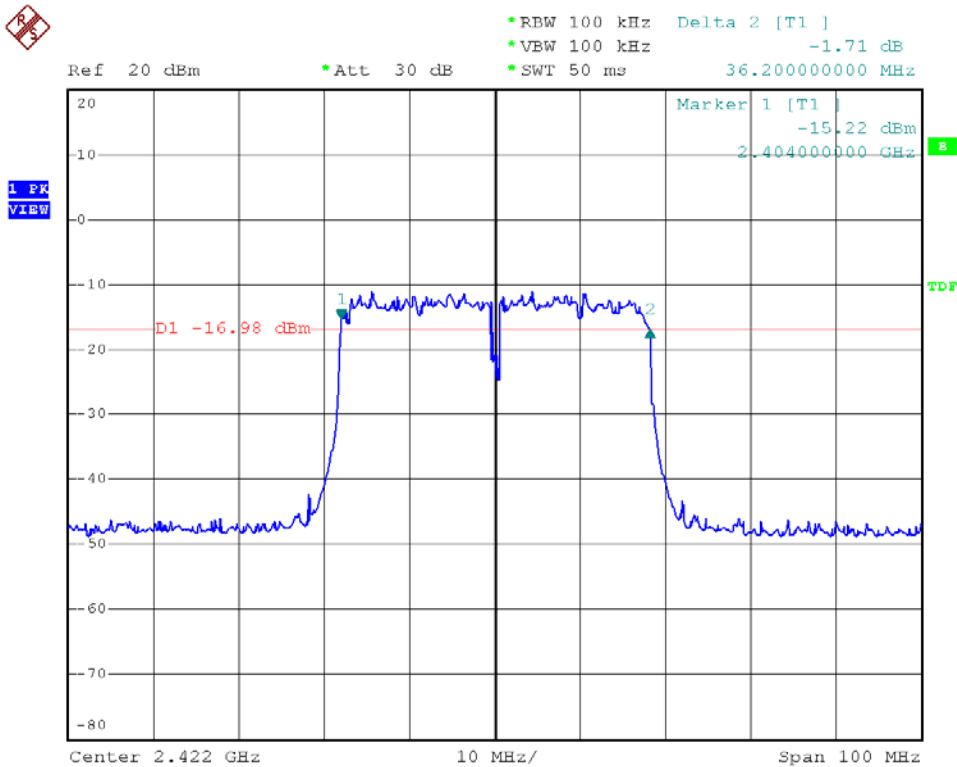



Modulation Standard: 802.11n HT40 (270Mbps), Ant2  
Channel: 06

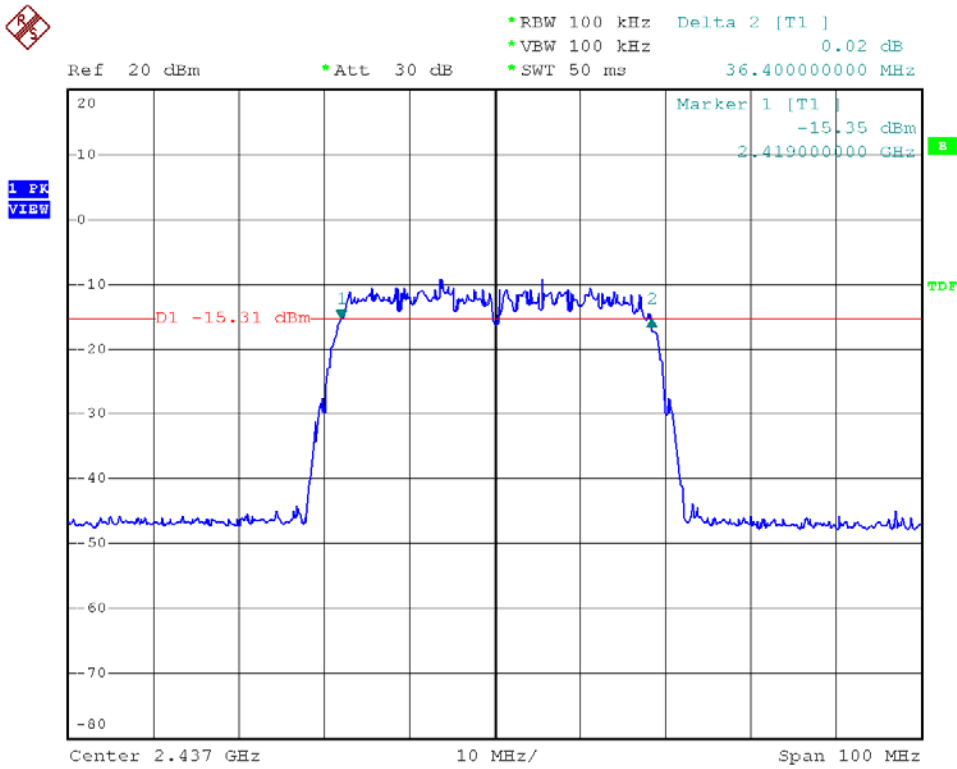

Modulation Standard: 802.11n HT40 (270Mbps), Ant2  
Channel: 09

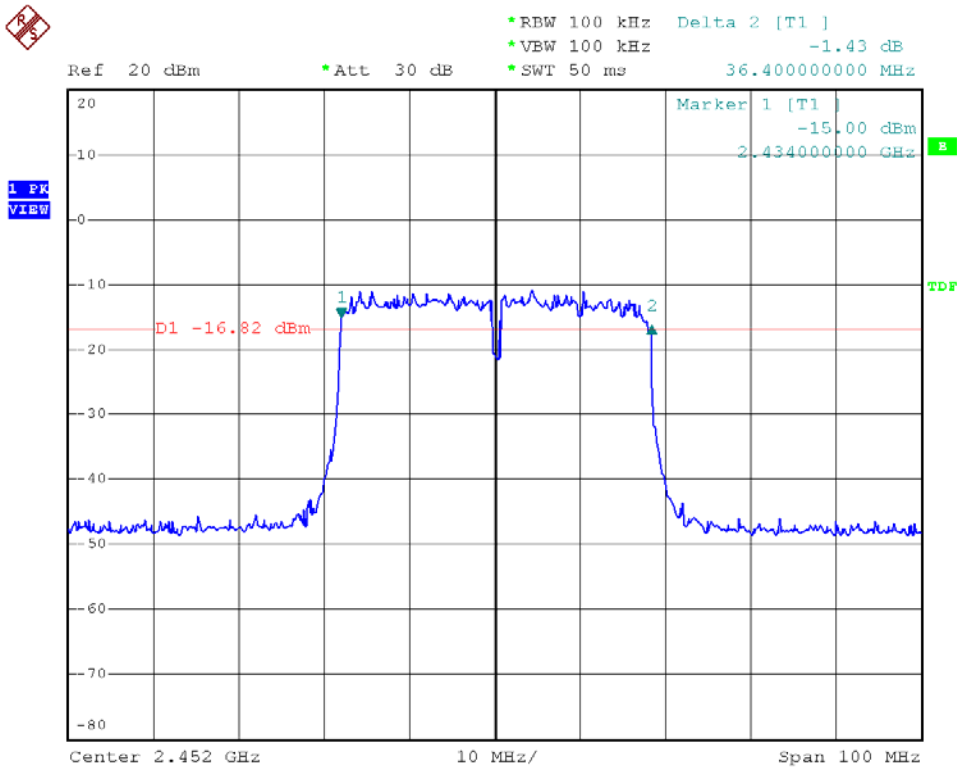



## 7. Maximum Peak Output Power

### 7.1 Test Limit

The Maximum Peak Output Power Measurement is 30dBm.

### 7.2 Test Procedures

The antenna port (RF output) of the EUT was connected to the input (RF input) of a power meter. Power was read directly from the meter and cable loss connection was added to the reading to obtain power at the EUT antenna terminal. The EUT Output Power was set to maximum to produce the worse case test result.

### 7.3 Test Setup Layout

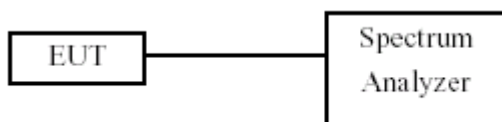

### 7.4 Measurement Equipment

Instrument/Ancillary	Manufacturer	Model No.	Serial No.	Calibration Date	Valid Date
Spectrum Analyzer	R&S	FSP40	100219	2009/11/20	2010/11/19





### 7.5 Test Result and Data

Test Date: Apr. 14, 2010

Temperature: 25°C

Atmospheric pressure: 1022 hPa

Humidity: 65%

Modulation Standard	Channel	Frequency (MHz)	Peak Power Output (dBm)		Peak Power Output (mW)	
			Ant1	Ant2	Ant1	Ant2
802.11b (11Mbps)	01	2412	18.06	18.15	64.0	65.3
	06	2437	18.10	18.14	64.6	65.2
	11	2462	18.39	18.11	69.0	64.7
802.11g (54Mbps)	01	2412	16.35	16.51	43.2	44.8
	06	2437	16.32	16.21	42.9	41.8
	11	2462	16.43	16.07	44.0	40.5

Modulation Standard	Channel	Frequency (MHz)	Peak Power Output (dBm)			Peak Power Output (mW)
			Ant1	Ant2	Ant1+2	Ant1+2
802.11n HT20 (130Mbps)	01	2412	13.79	14.44	17.14	51.73
	06	2437	13.99	14.08	17.05	50.65
	11	2462	13.84	14.59	17.24	52.98
802.11n HT40 (270Mbps)	03	2422	13.47	12.67	16.10	40.73
	06	2437	13.18	12.76	15.99	39.68
	09	2452	13.25	12.72	16.00	39.84



Modulation Standard: 802.11b (11Mbps), Ant1  
Channel: 01

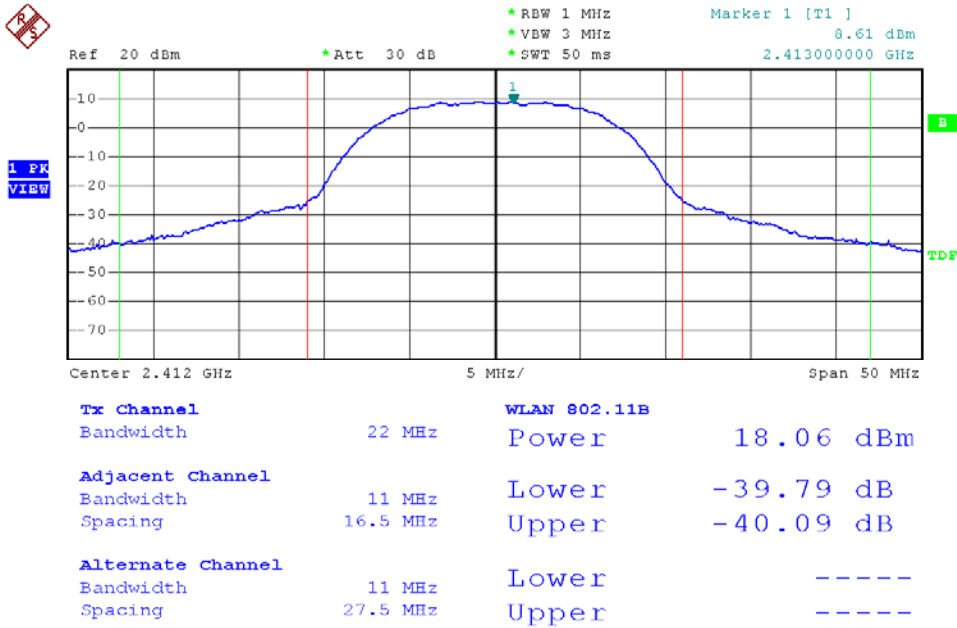

Modulation Standard: 802.11b (11Mbps), Ant1  
Channel: 06

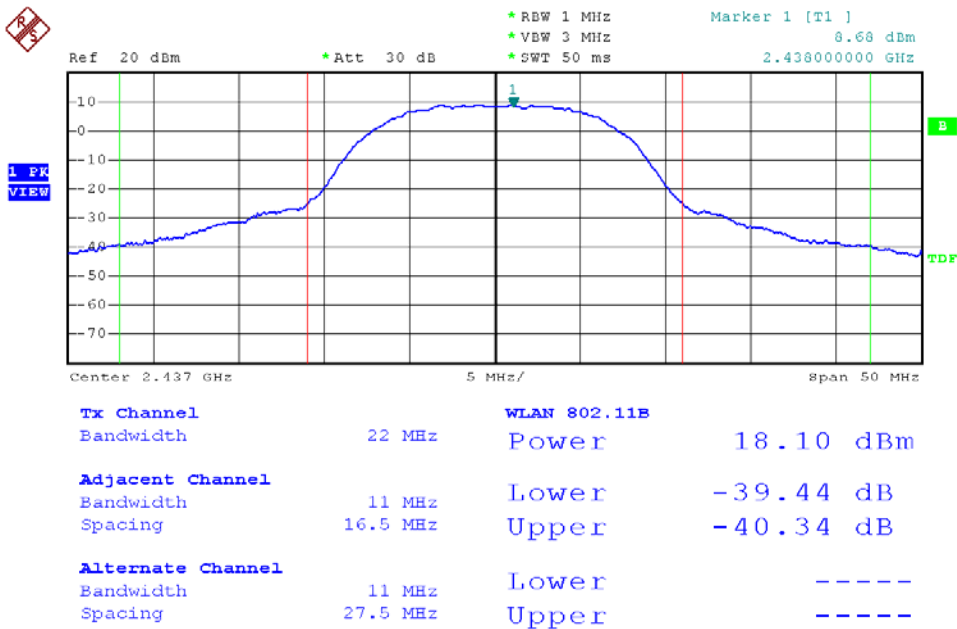



Modulation Standard: 802.11b (11Mbps), Ant1  
Channel: 11

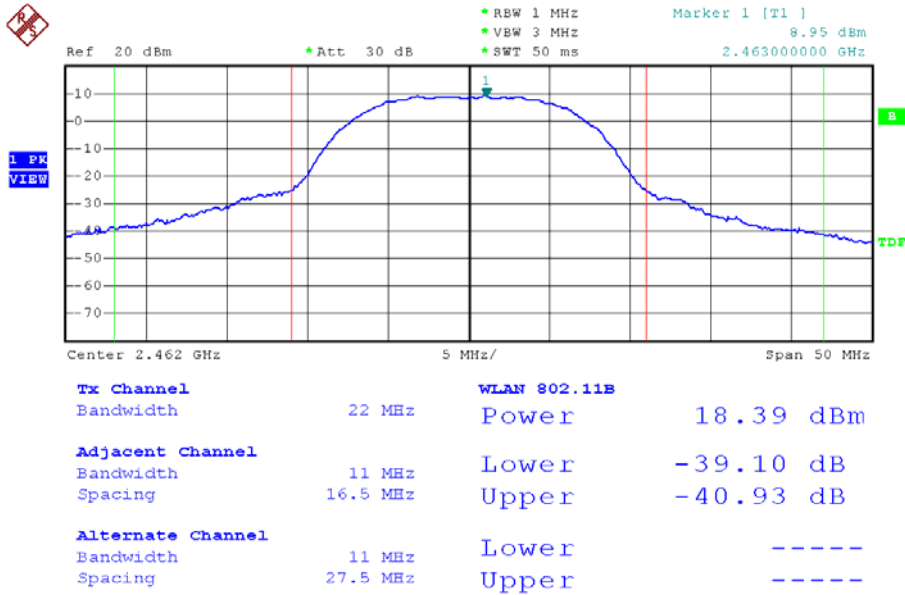

Modulation Standard: 802.11b (11Mbps), Ant2  
Channel: 01

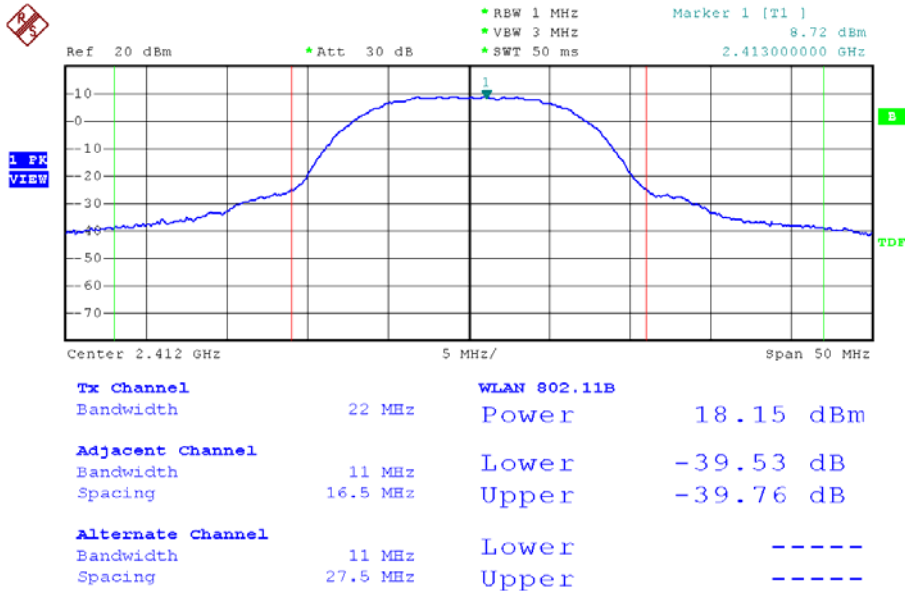



Modulation Standard: 802.11b (11Mbps), Ant2  
Channel: 06

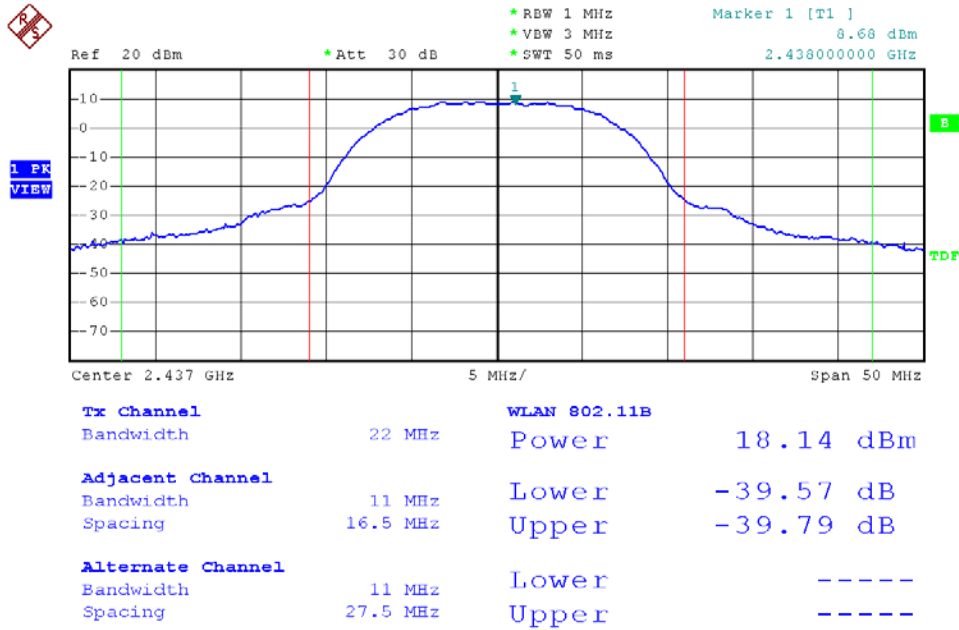

Modulation Standard: 802.11b (11Mbps), Ant2  
Channel: 11

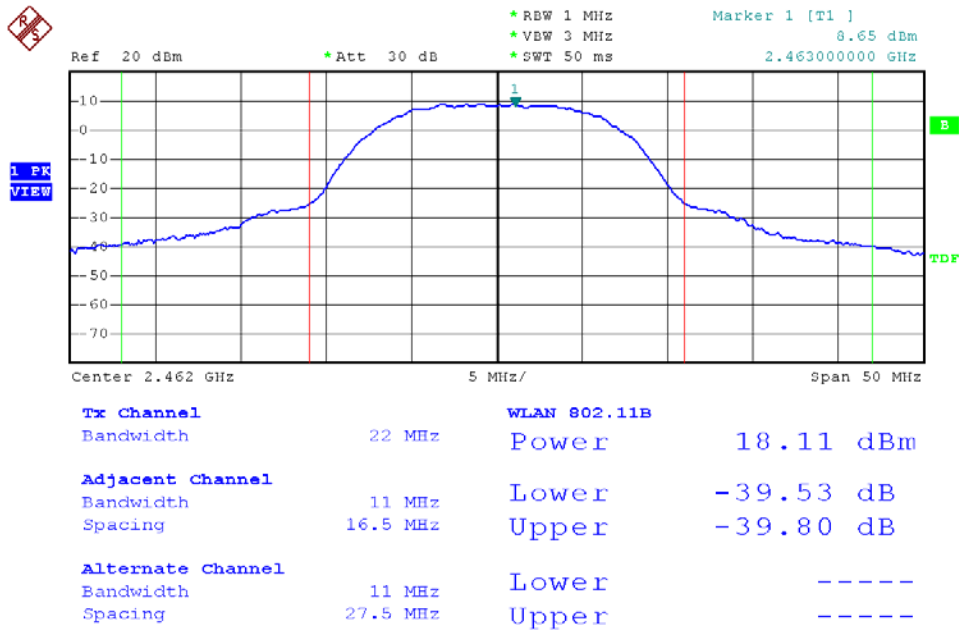



Modulation Standard: 802.11g (54Mbps), Ant1  
Channel: 01

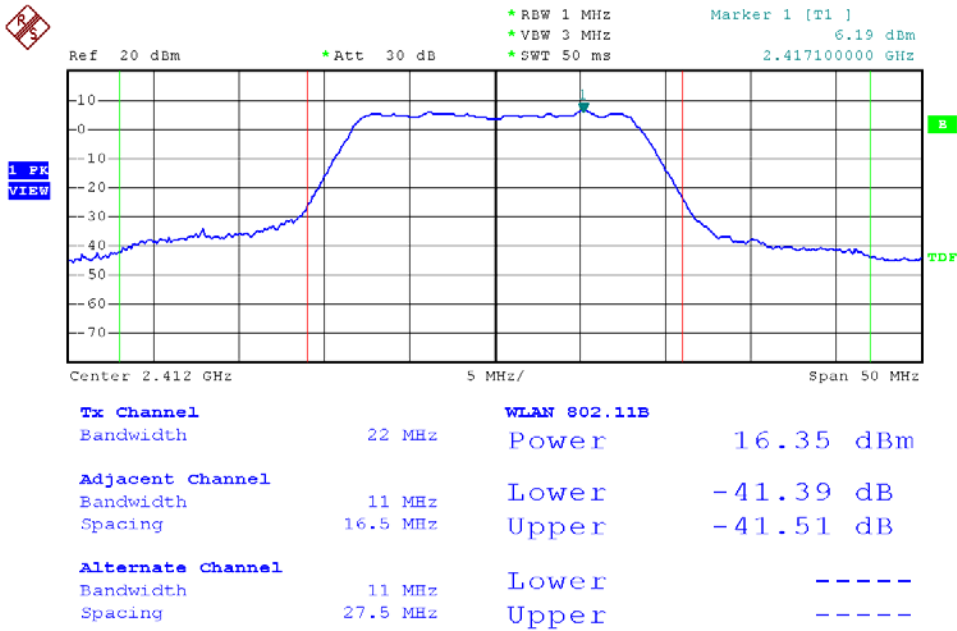

Modulation Standard: 802.11g (54Mbps), Ant1  
Channel: 06

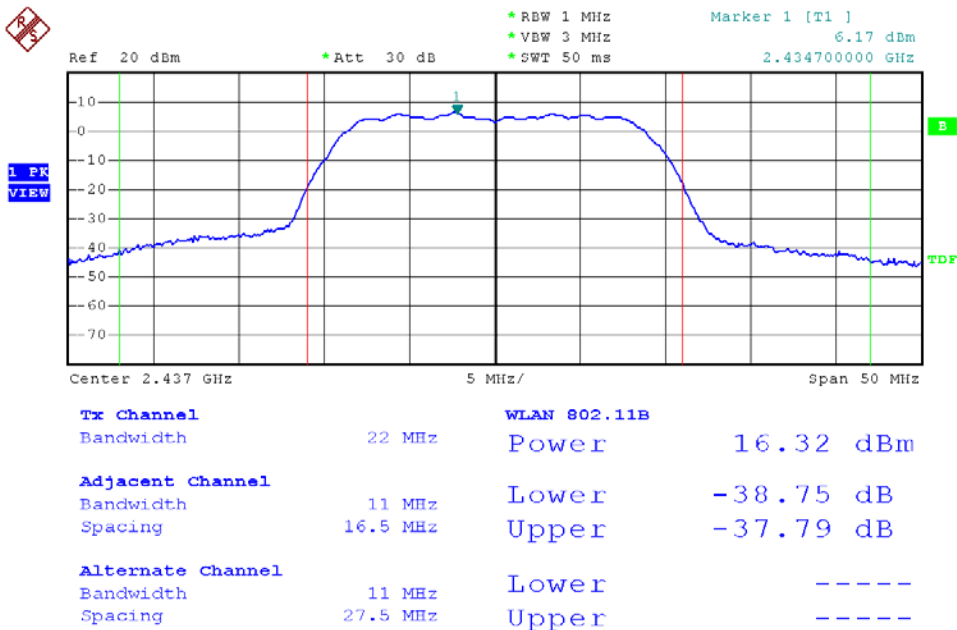



Modulation Standard: 802.11g (54Mbps), Ant1  
Channel: 11

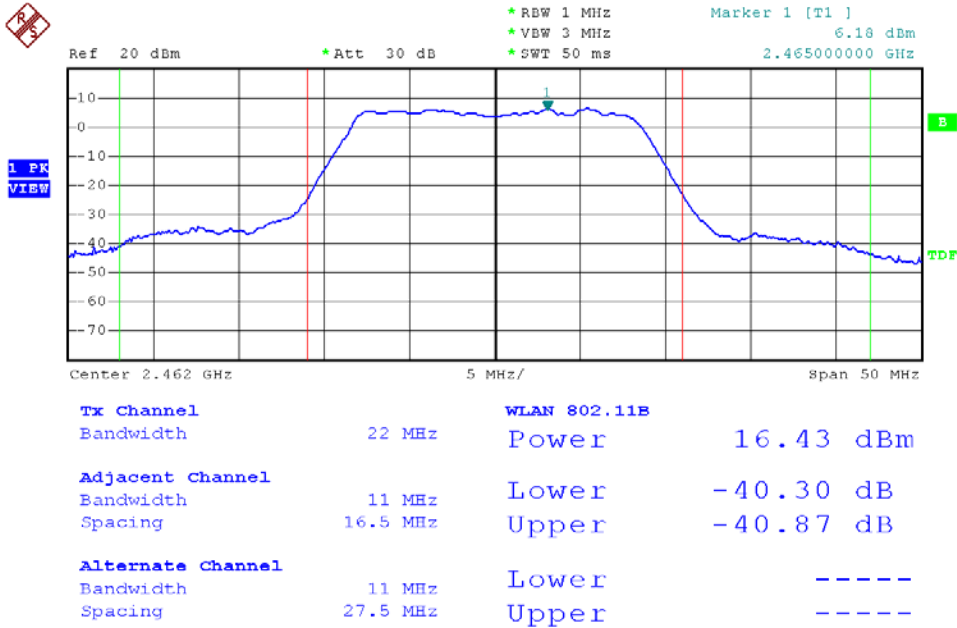

Modulation Standard: 802.11g (54Mbps), Ant2  
Channel: 01

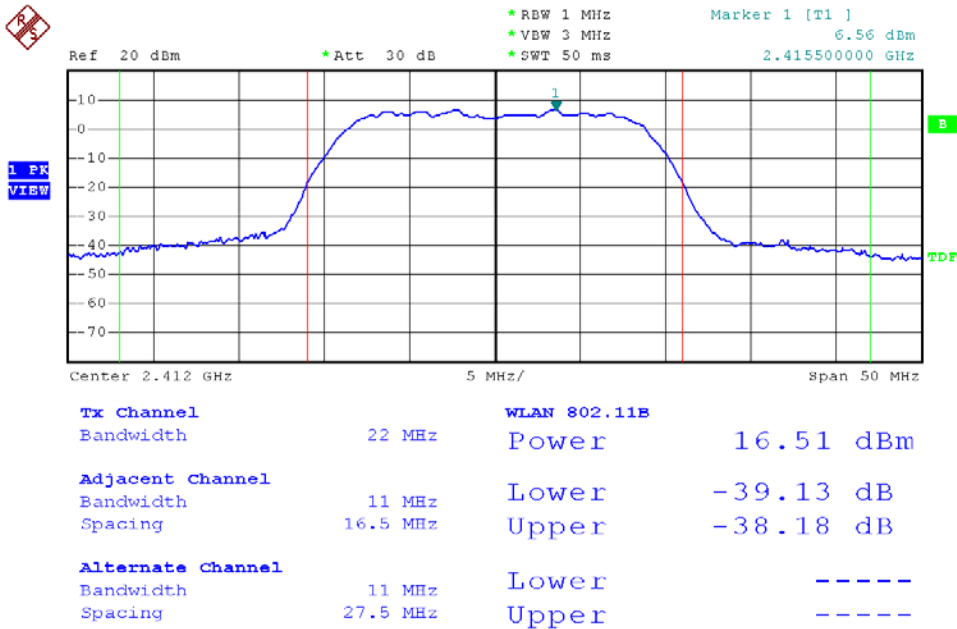



Modulation Standard: 802.11g (54Mbps), Ant2  
Channel: 06

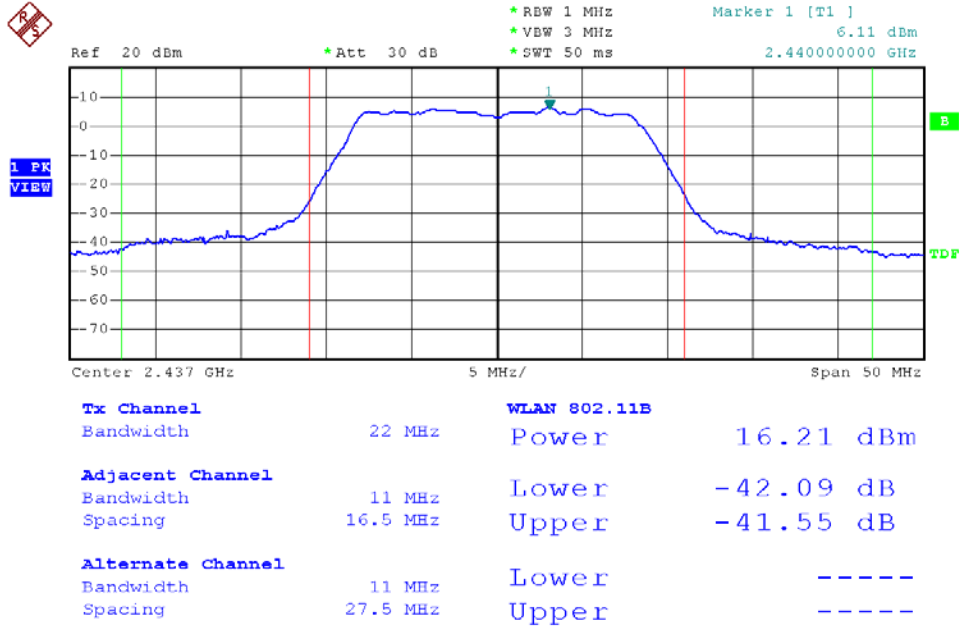

Modulation Standard: 802.11g (54Mbps), Ant2  
Channel: 11

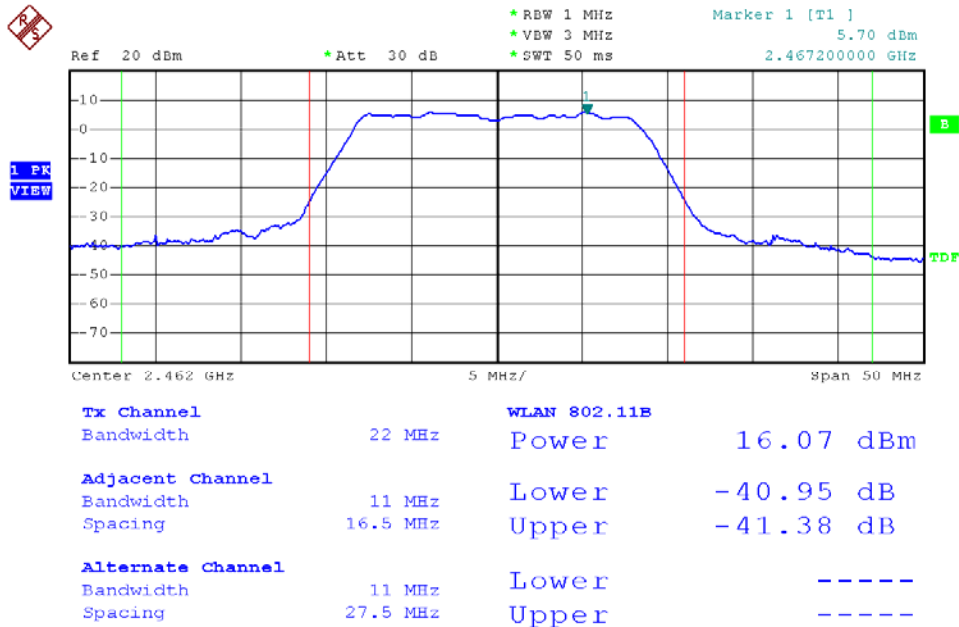



Modulation Standard: 802.11n HT20 (130Mbps), Ant1  
Channel: 01

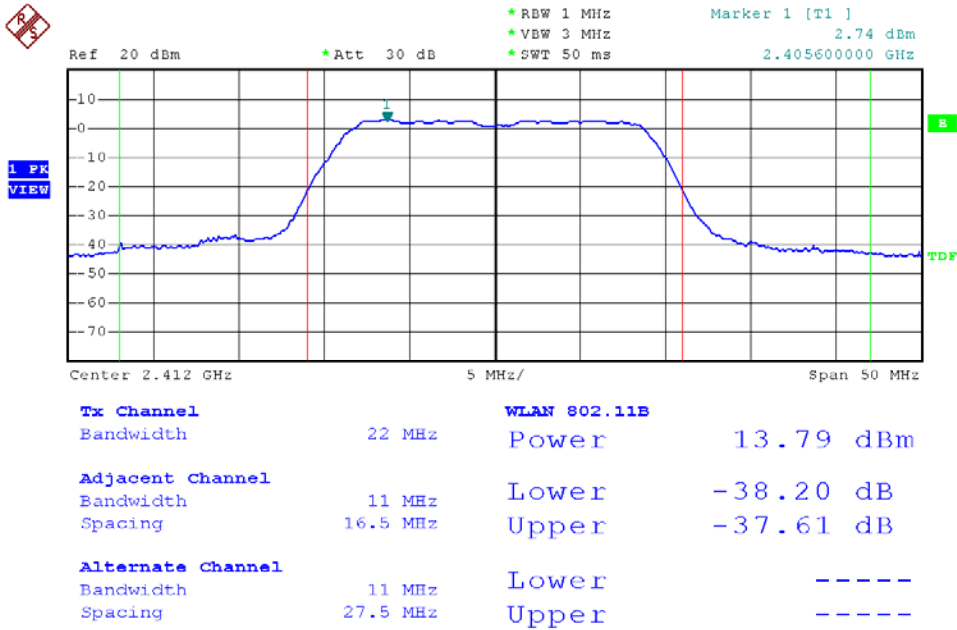

Modulation Standard: 802.11n HT20 (130Mbps), Ant1  
Channel: 06

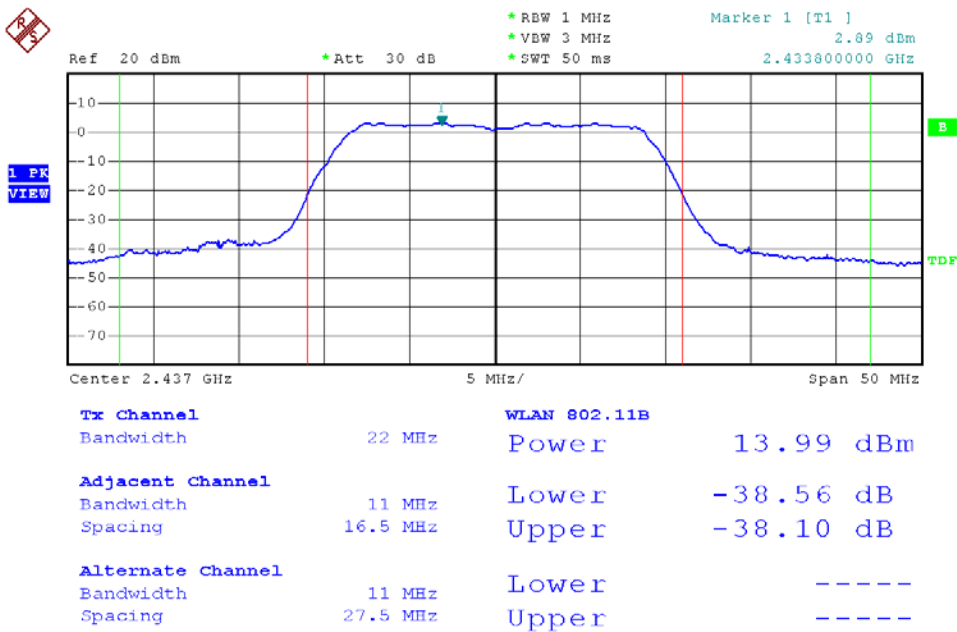





Modulation Standard: 802.11n HT20 (130Mbps), Ant1  
Channel: 11

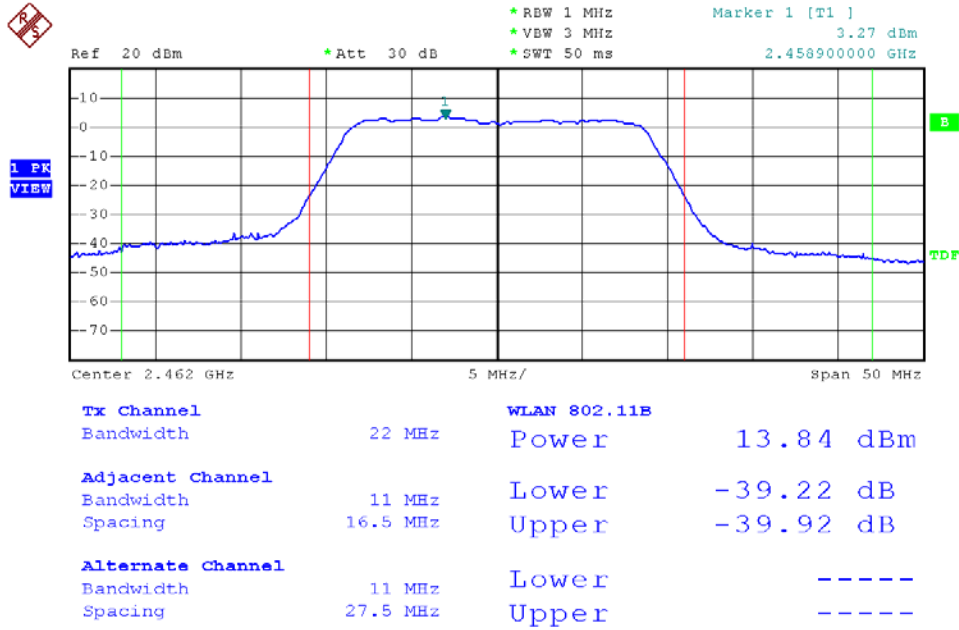

Modulation Standard: 802.11n HT20 (130Mbps), Ant2  
Channel: 01

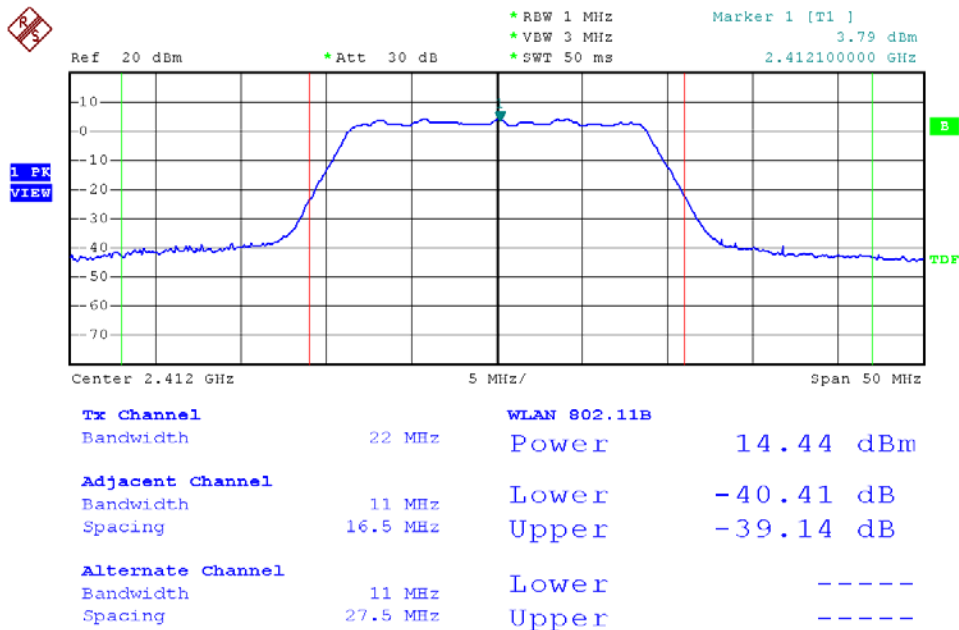



Modulation Standard: 802.11n HT20 (130Mbps), Ant2  
Channel: 06

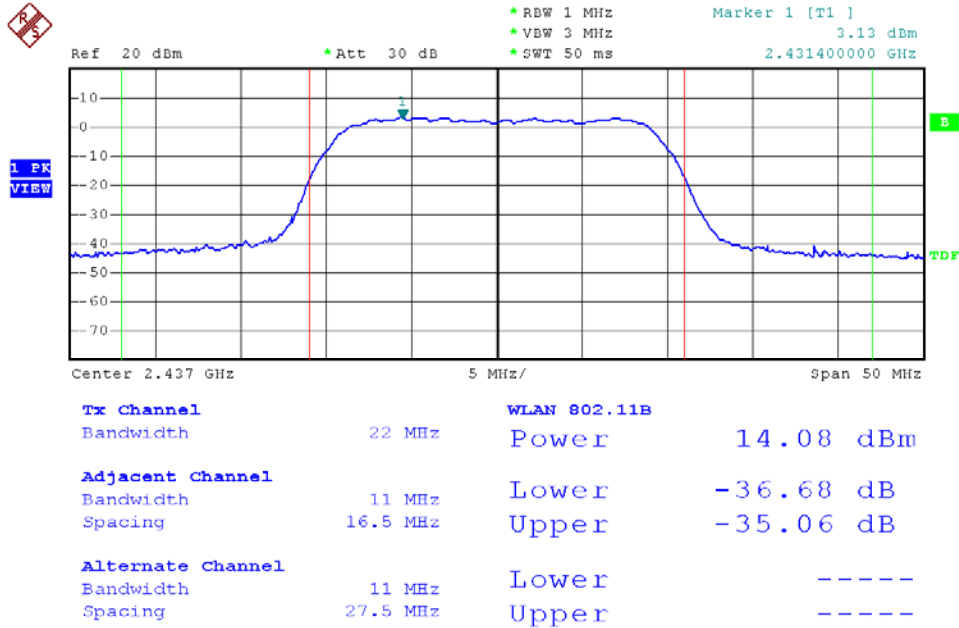

Modulation Standard: 802.11n HT20 (130Mbps), Ant2  
Channel: 11

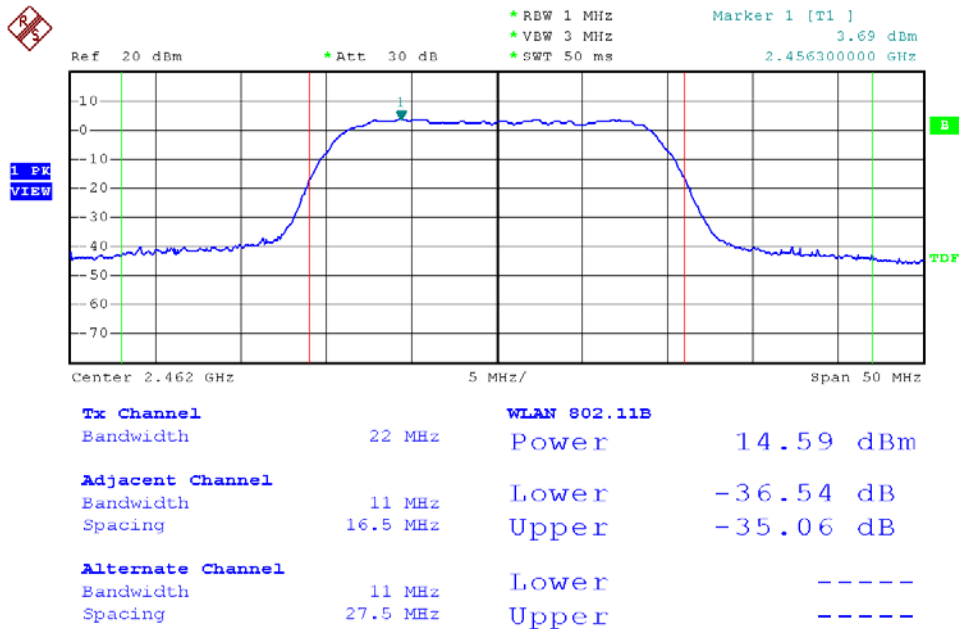



Modulation Standard: 802.11n HT40 (270Mbps), Ant1  
Channel: 03

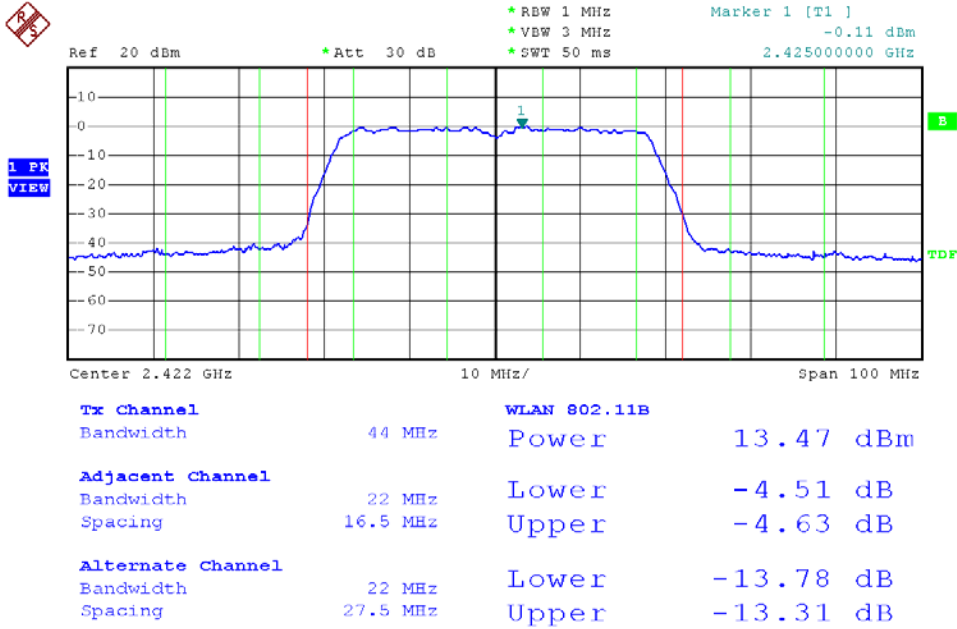

Modulation Standard: 802.11n HT40 (270Mbps), Ant1  
Channel: 06

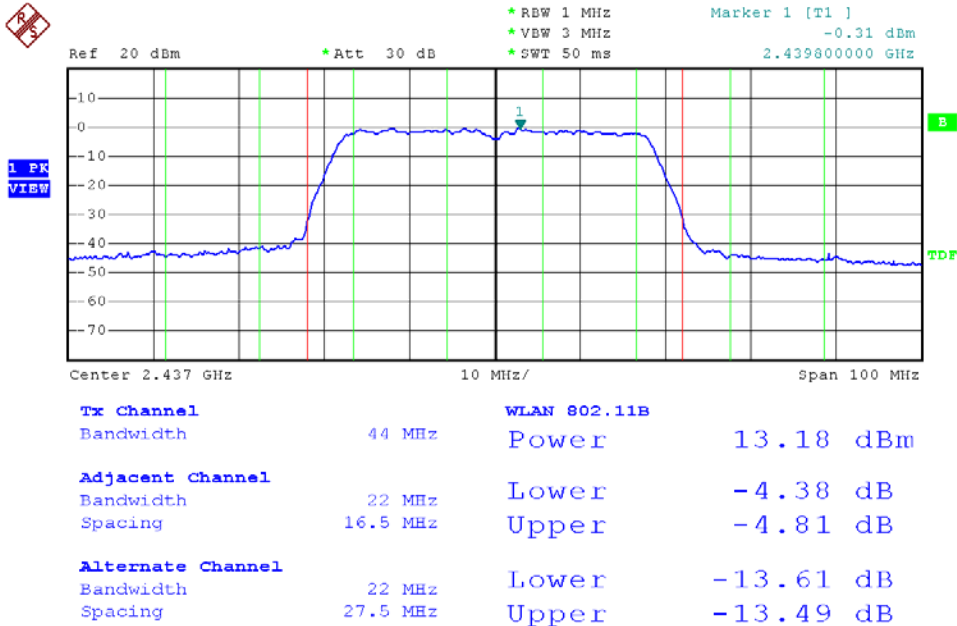



Modulation Standard: 802.11n HT40 (270Mbps), Ant1  
Channel: 09

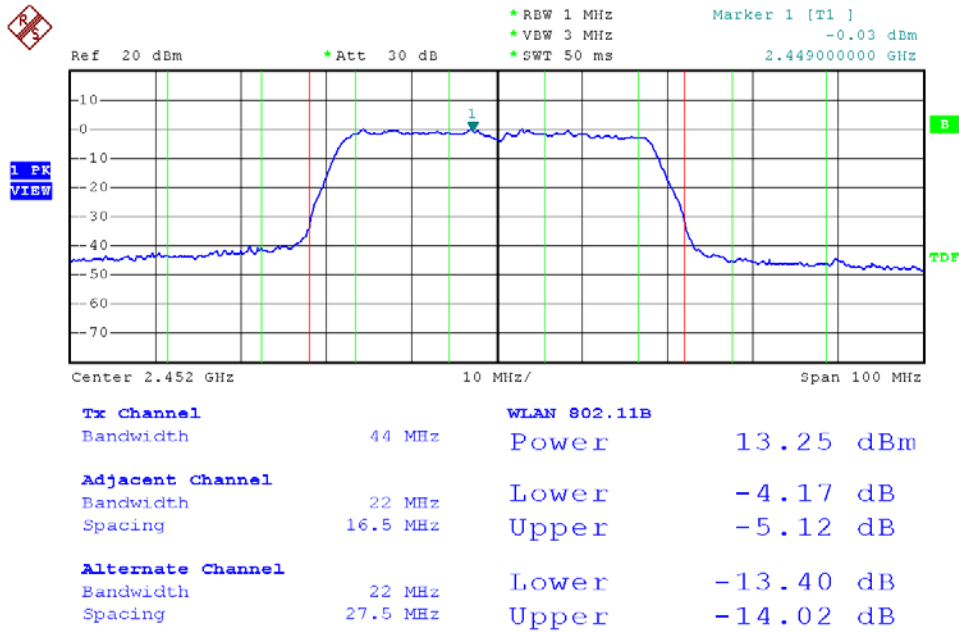

Modulation Standard: 802.11n HT40 (270Mbps), Ant2  
Channel: 03

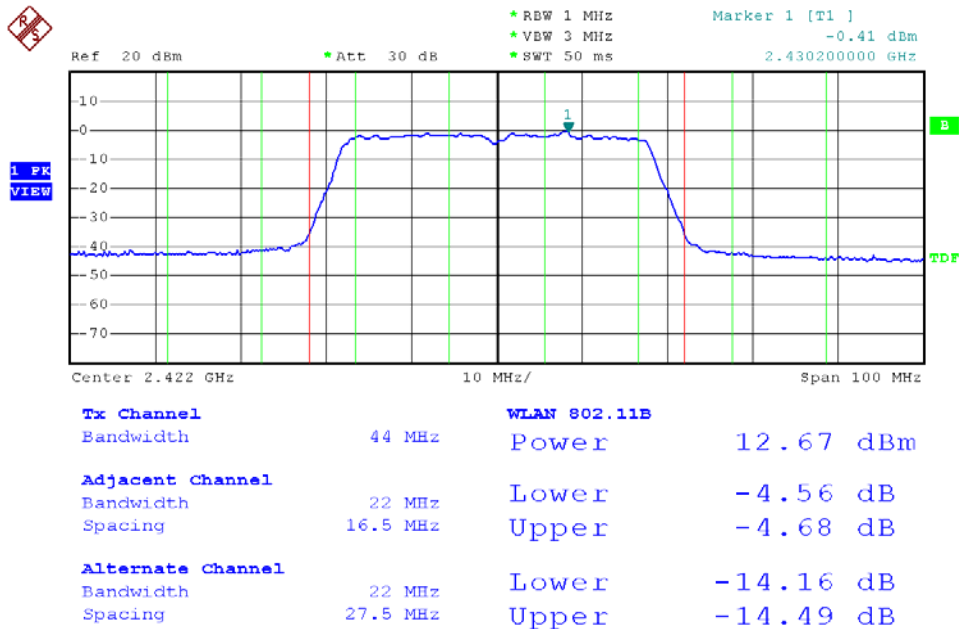



Modulation Standard: 802.11n HT40 (270Mbps), Ant2  
 Channel: 06

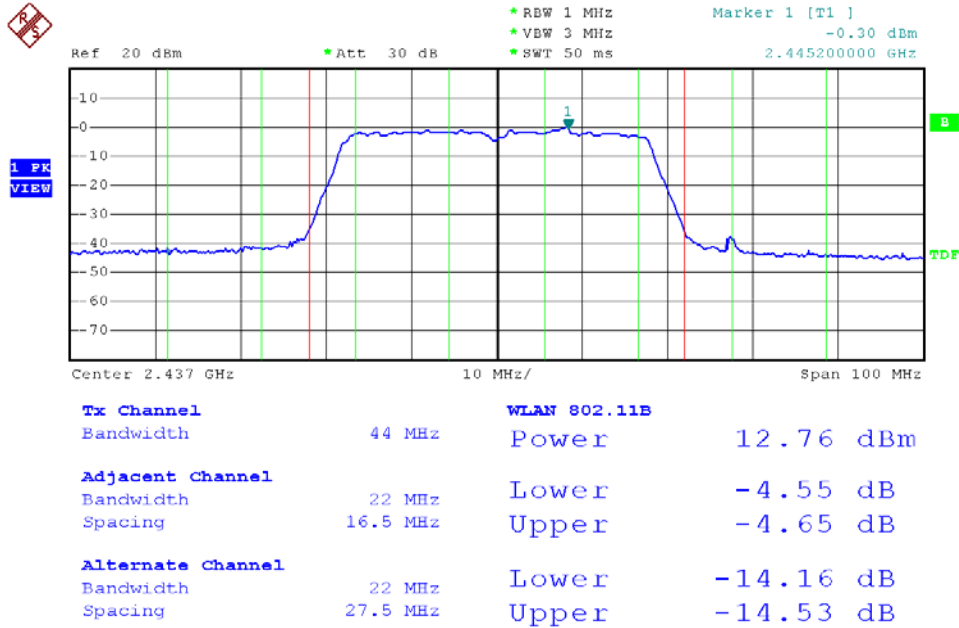

Modulation Standard: 802.11n HT40 (270Mbps), Ant2  
 Channel: 09

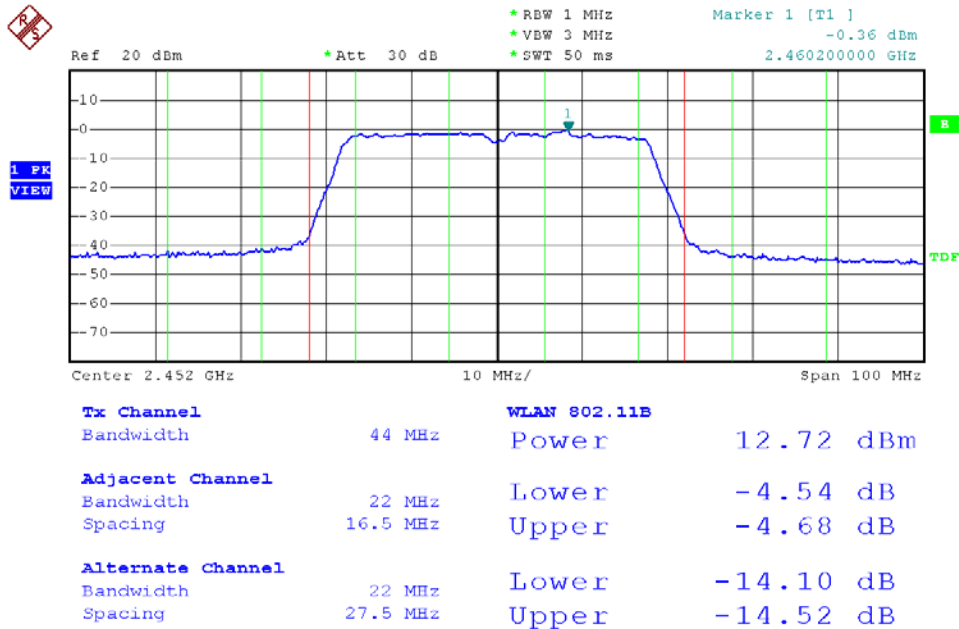



## 8. Power Spectral Density

### 8.1 Test Limit

The Maximum of Power Spectral Density Measurement is 8dBm.

### 8.2 Test Procedures

- The transmitter output was connected to spectrum analyzer.
- The spectrum analyzer's resolution bandwidth were set at 3KHz RBW and 30KHz VBW as that of the fundamental frequency. Set the sweep time=span/3KHz.
- The power spectral density was measured and recorded.
- The Sweep time is allowed to be longer than span/3KHz for a full response of the mixer in the spectrum analyzer.

### 8.3 Test Setup Layout

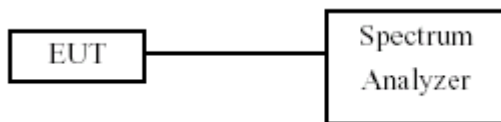

### 8.4 Measurement Equipment

Instrument/Ancillary	Manufacturer	Model No.	Serial No.	Calibration Date	Valid Date
Spectrum Analyzer	R&S	FSP40	100219	2009/11/20	2010/11/19

### 8.5 Test Result and Data

Test Date: Apr. 16, 2010

Temperature: 25°C

Atmospheric pressure: 1022 hPa

Humidity: 65%

Modulation Standard	Channel	Frequency (MHz)	Maximum Power Density of 3 kHz Bandwidth (dBm)	
			Ant1	Ant2
802.11b (11Mbps)	01	2412	-13.24	-14.43
	06	2437	-13.04	-14.04
	11	2462	-12.86	-13.92
802.11g (54Mbps)	01	2412	-18.49	-19.56
	06	2437	-19.17	-19.62
	11	2462	-18.59	-19.36

Modulation Standard	Channel	Frequency (MHz)	Maximum Power Density of 3 kHz Bandwidth (dBm)		
			Ant1	Ant2	Ant1+2
802.11n HT20 (130Mbps)	01	2412	-20.21	-21.30	-17.71
	06	2437	-19.51	-21.89	-17.53
	11	2462	-19.35	-21.36	-17.23
802.11n HT40 (270Mbps)	03	2422	-21.53	-25.54	-20.08
	06	2437	-21.55	-24.19	-19.66
	09	2452	-21.52	-25.25	-19.99



Modulation Standard: 802.11b (11Mbps), Ant1  
Channel: 01

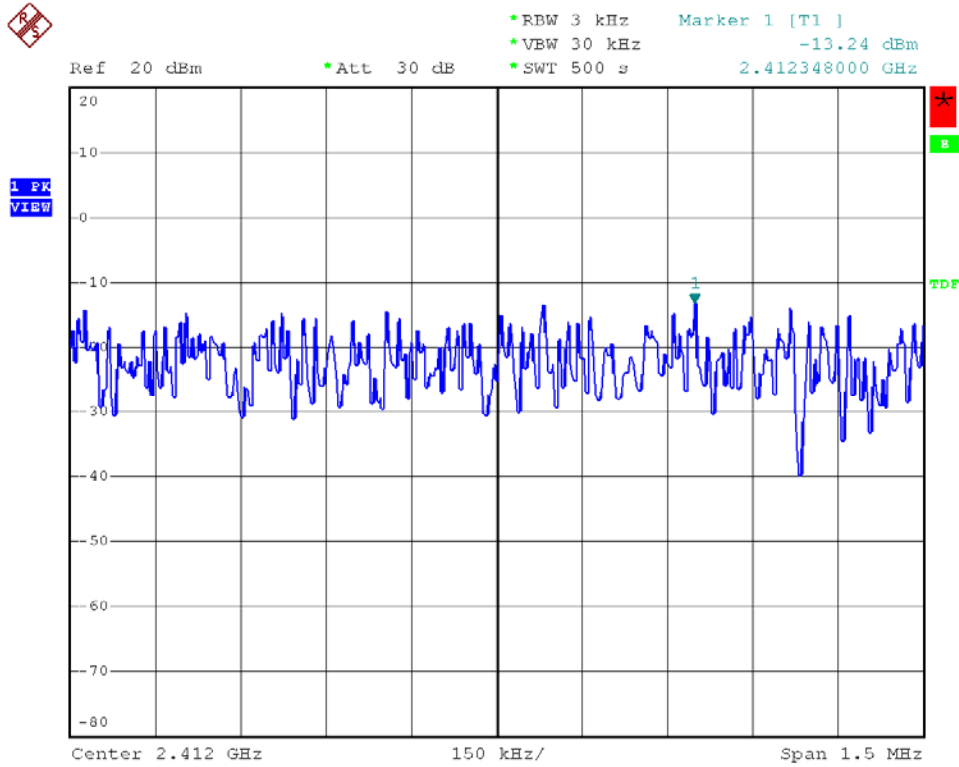

Modulation Standard: 802.11b (11Mbps), Ant1  
Channel: 06

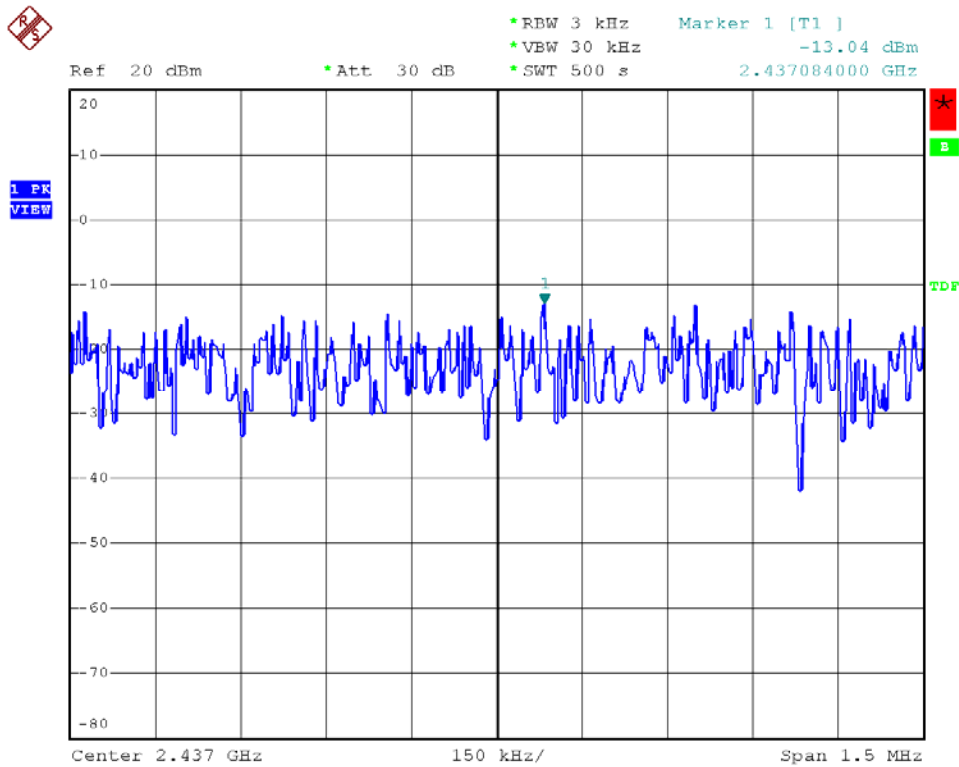



Modulation Standard: 802.11b (11Mbps), Ant1  
Channel: 11

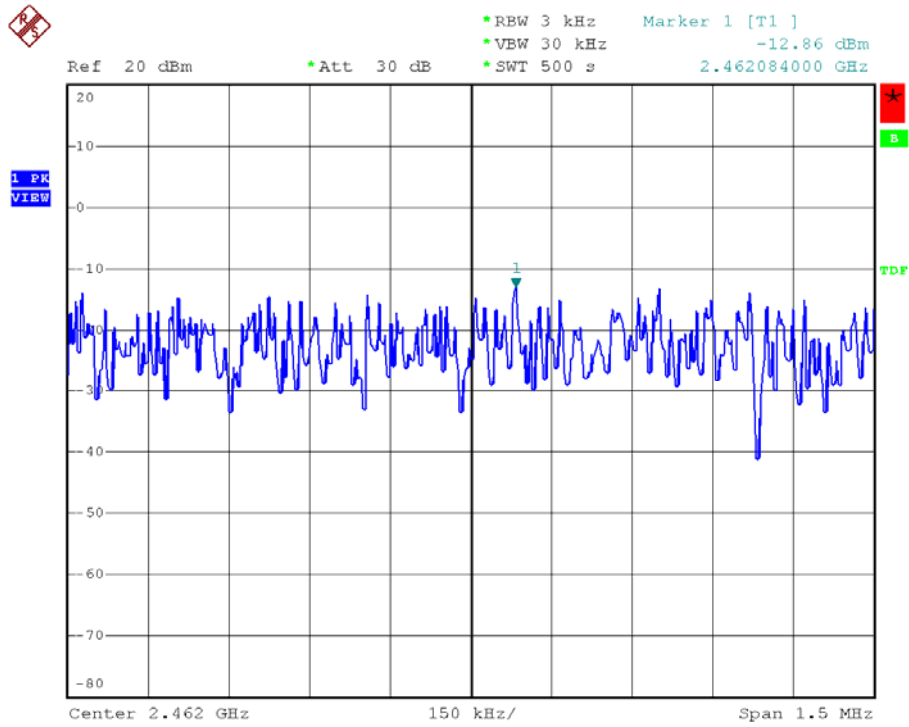

Modulation Standard: 802.11b (11Mbps), Ant2  
Channel: 01

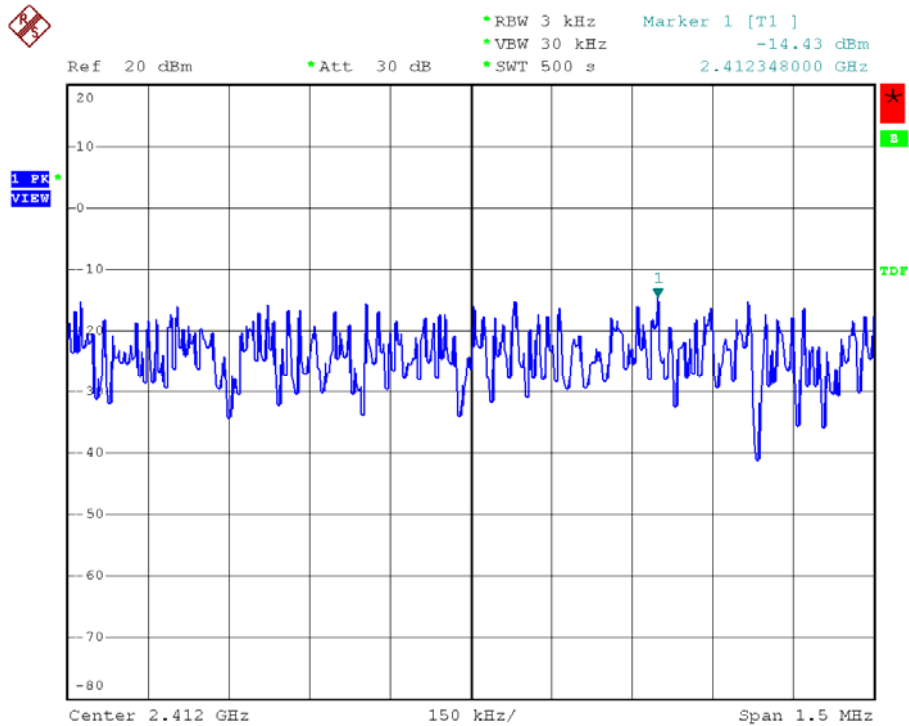





Modulation Standard: 802.11b (11Mbps), Ant2  
Channel: 06

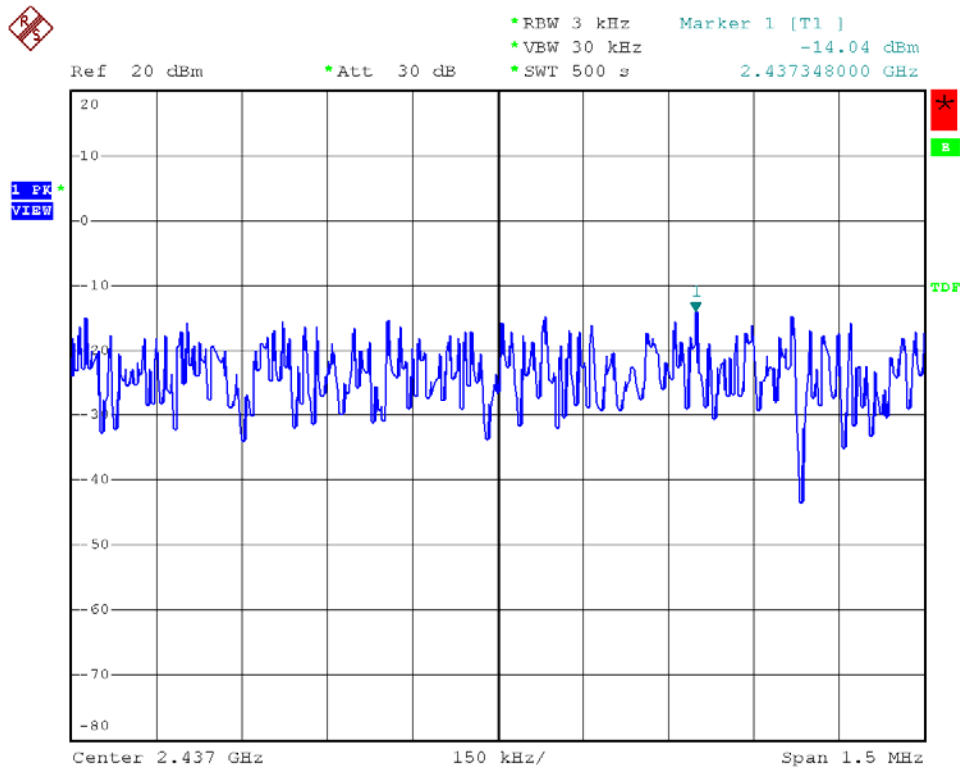

Modulation Standard: 802.11b (11Mbps), Ant2  
Channel: 11

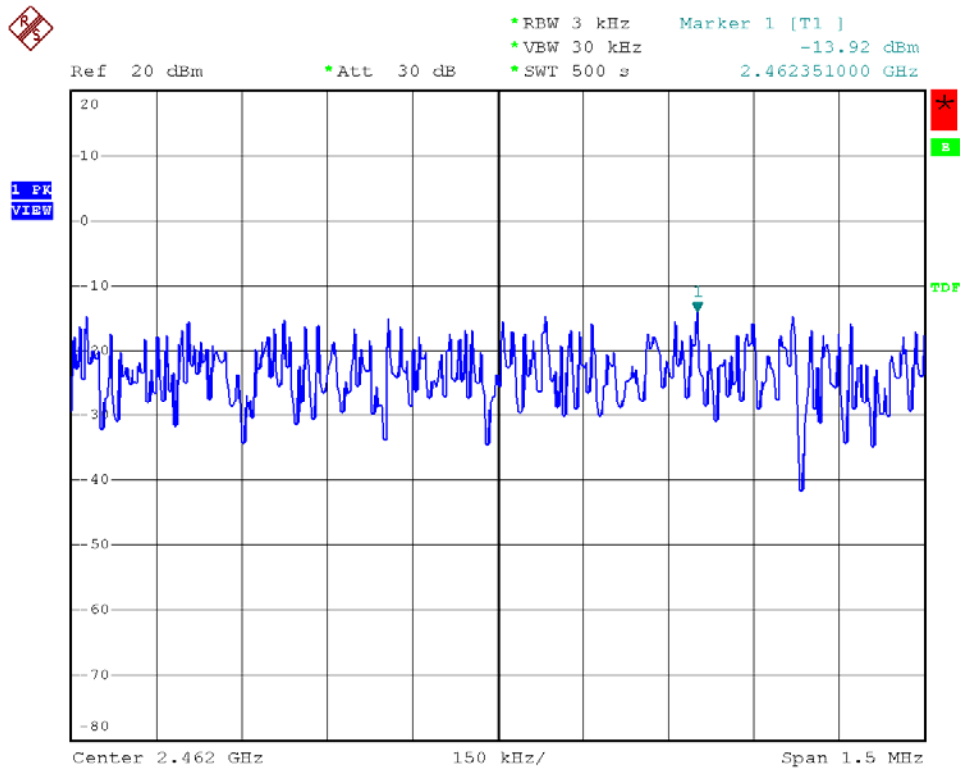



Modulation Standard: 802.11g (54Mbps), Ant1  
Channel: 01

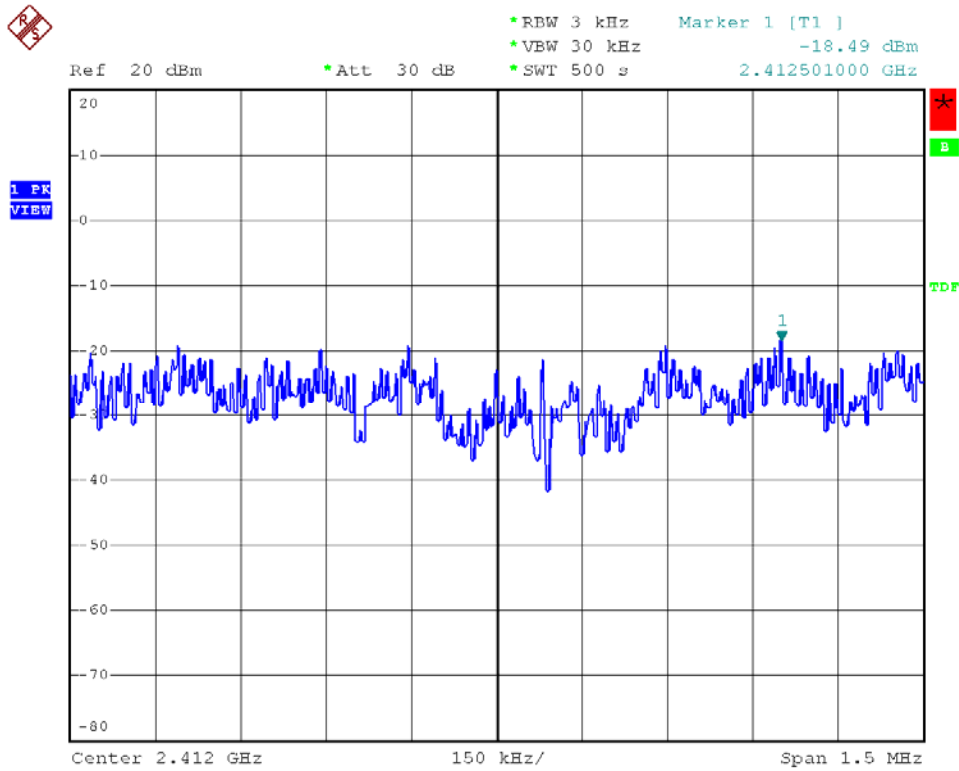

Modulation Standard: 802.11g (54Mbps), Ant1  
Channel: 06

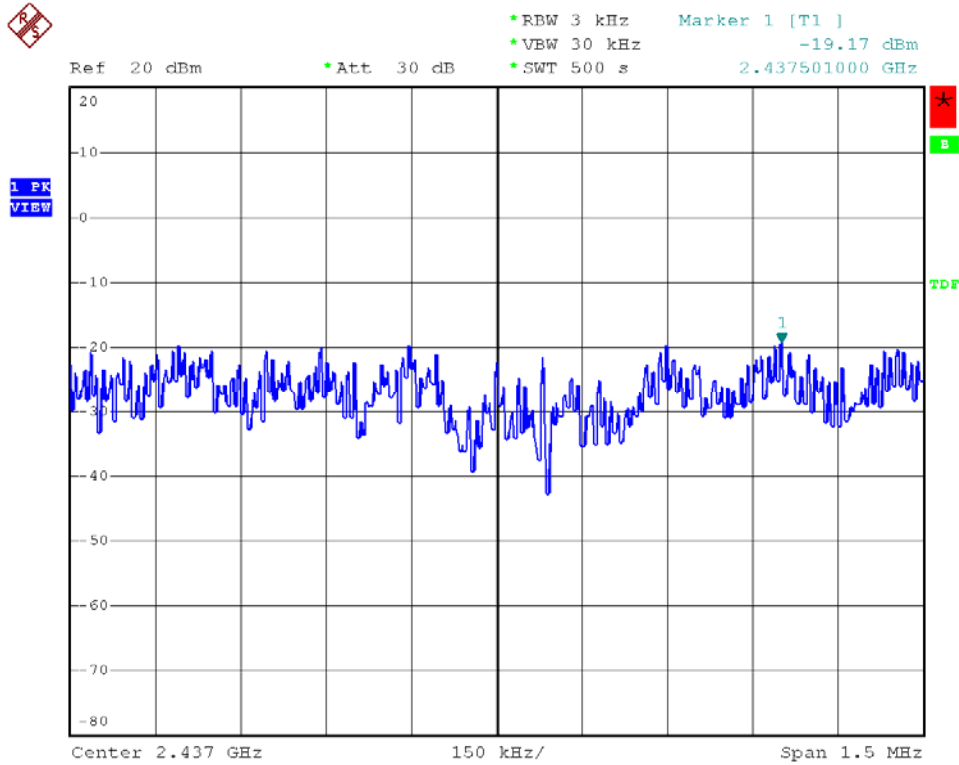



Modulation Standard: 802.11g (54Mbps), Ant1  
Channel: 11

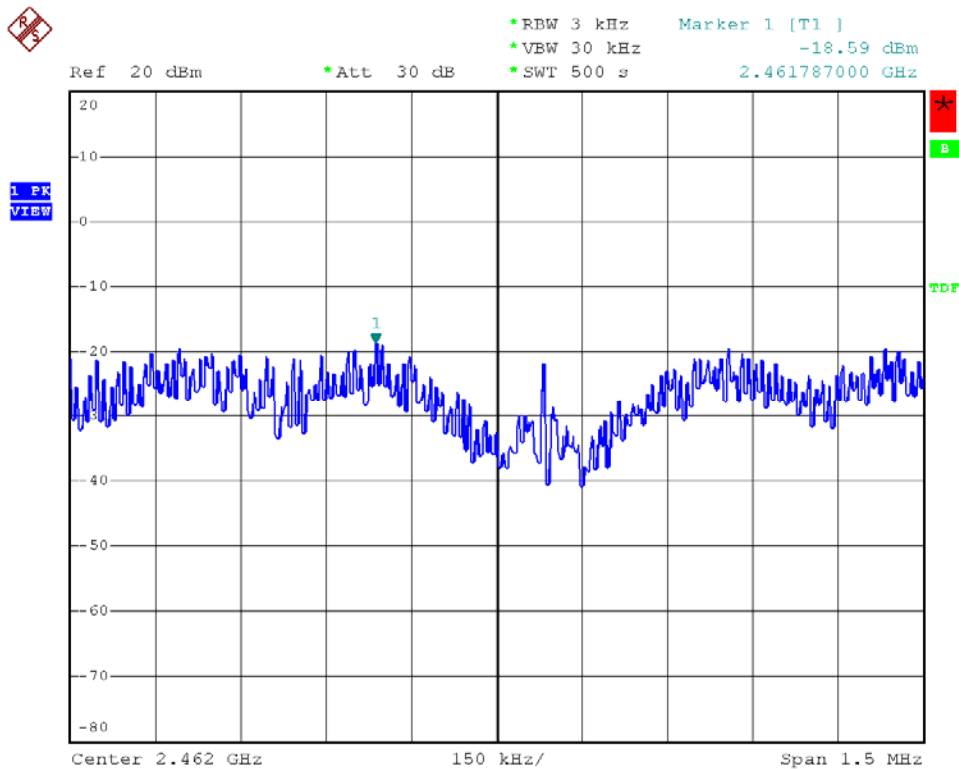

Modulation Standard: 802.11g (54Mbps), Ant2  
Channel: 01

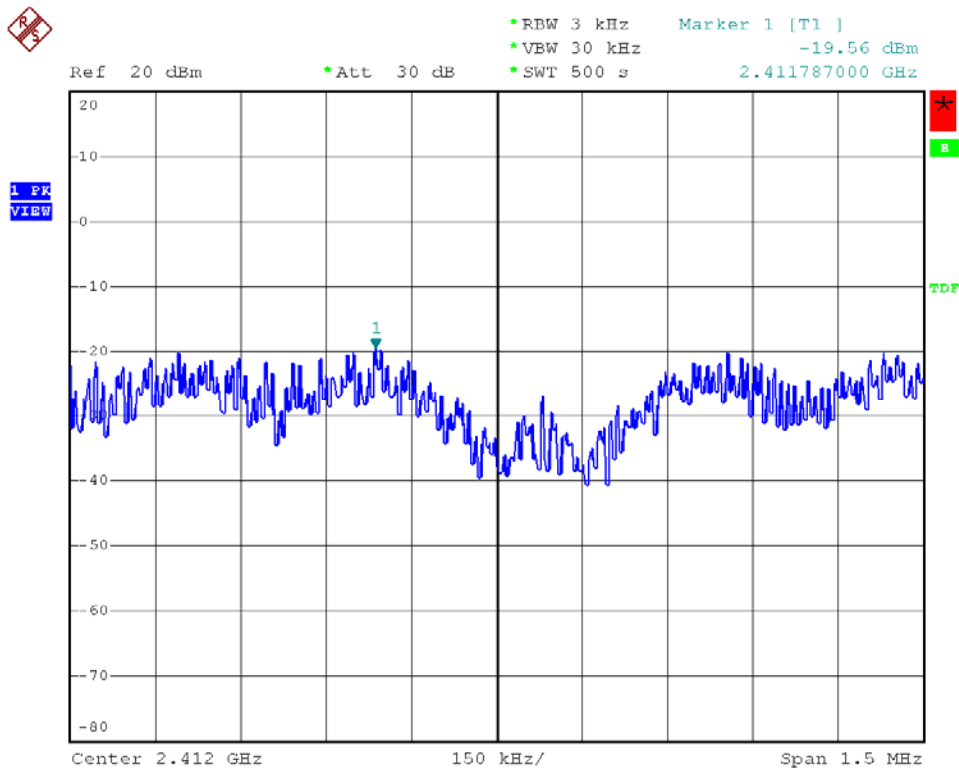



Modulation Standard: 802.11g (54Mbps), Ant2  
Channel: 06

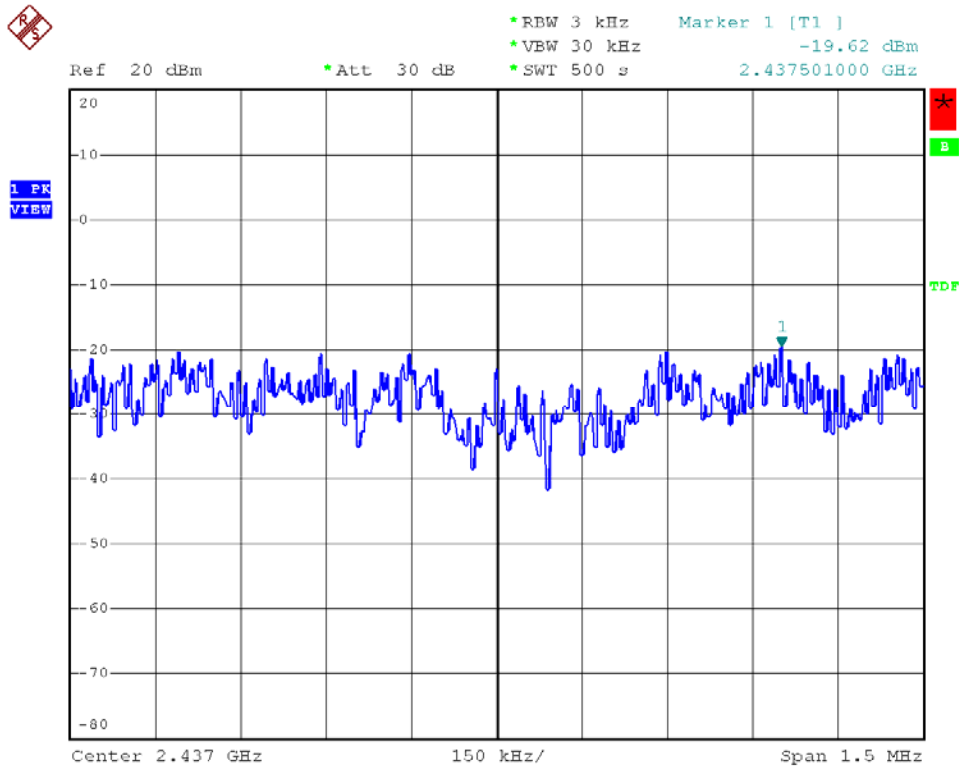

Modulation Standard: 802.11g (54Mbps), Ant2  
Channel: 11

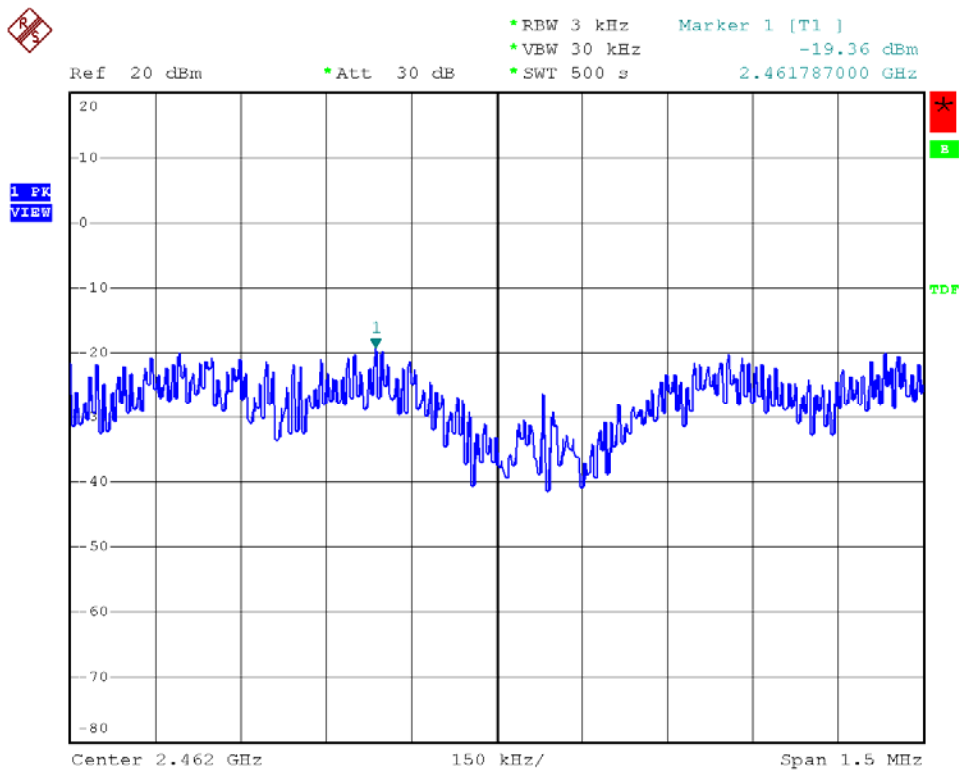



Modulation Standard: 802.11n HT20 (130Mbps), Ant1  
Channel: 01

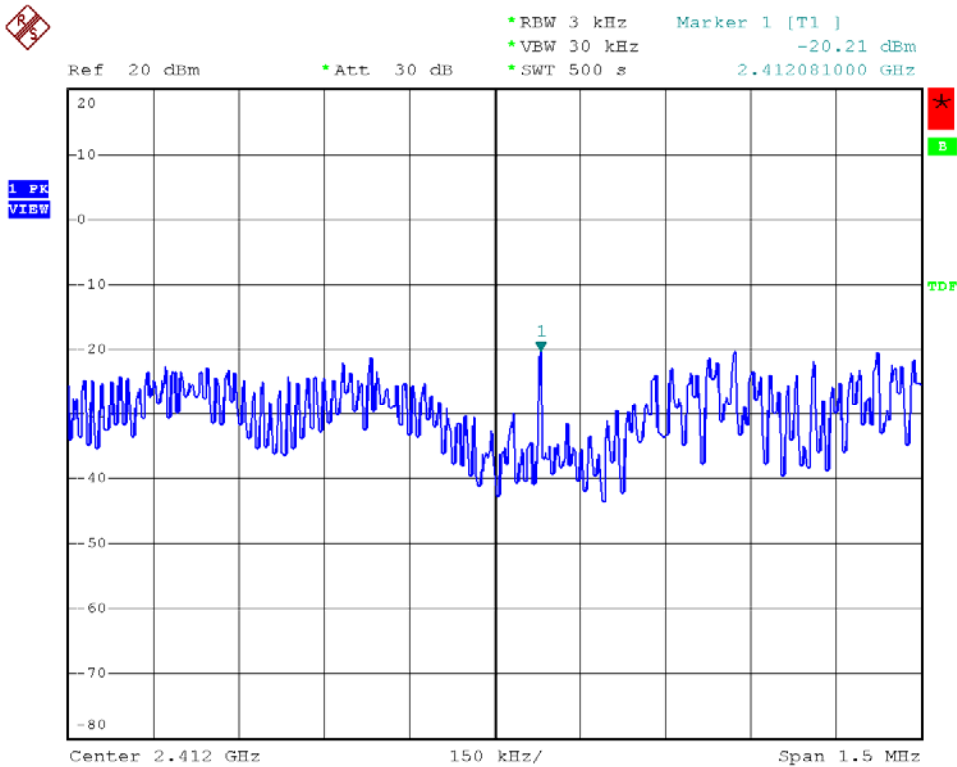

Modulation Standard: 802.11n HT20 (130Mbps), Ant1  
Channel: 06

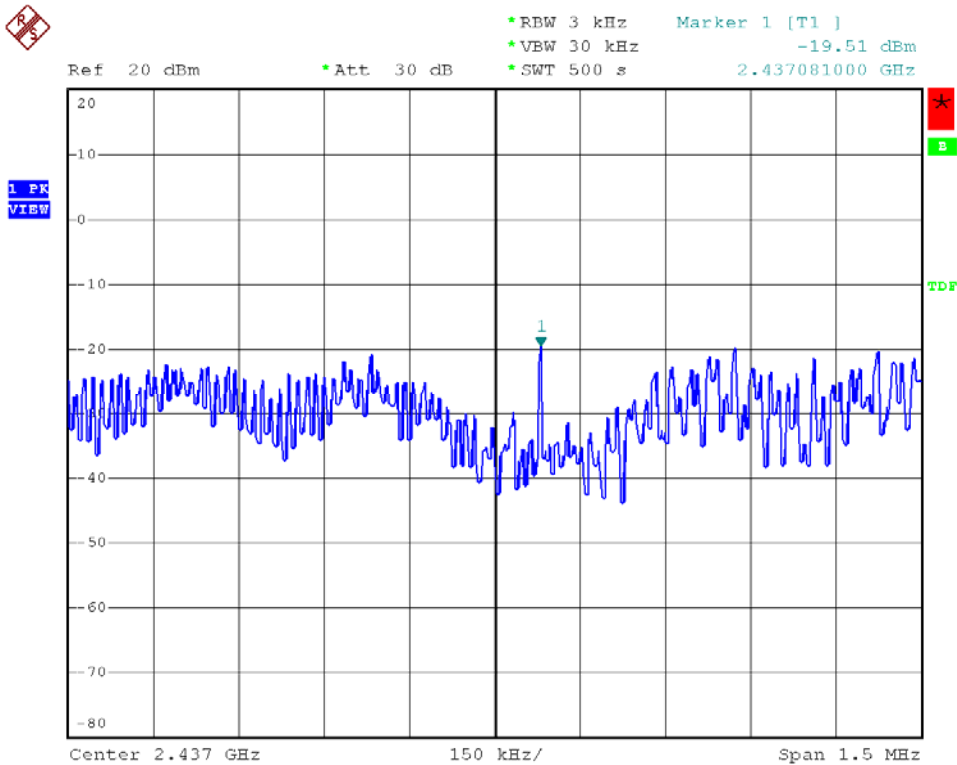



Modulation Standard: 802.11n HT20 (130Mbps), Ant1  
Channel: 11

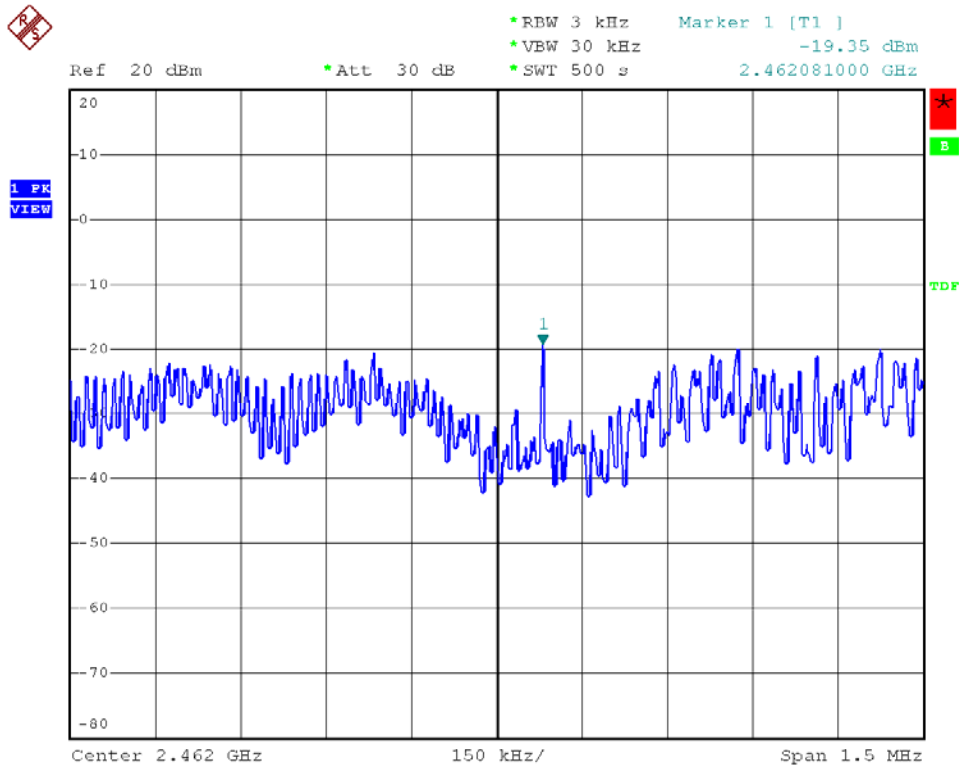

Modulation Standard: 802.11n HT20 (130Mbps), Ant2  
Channel: 01

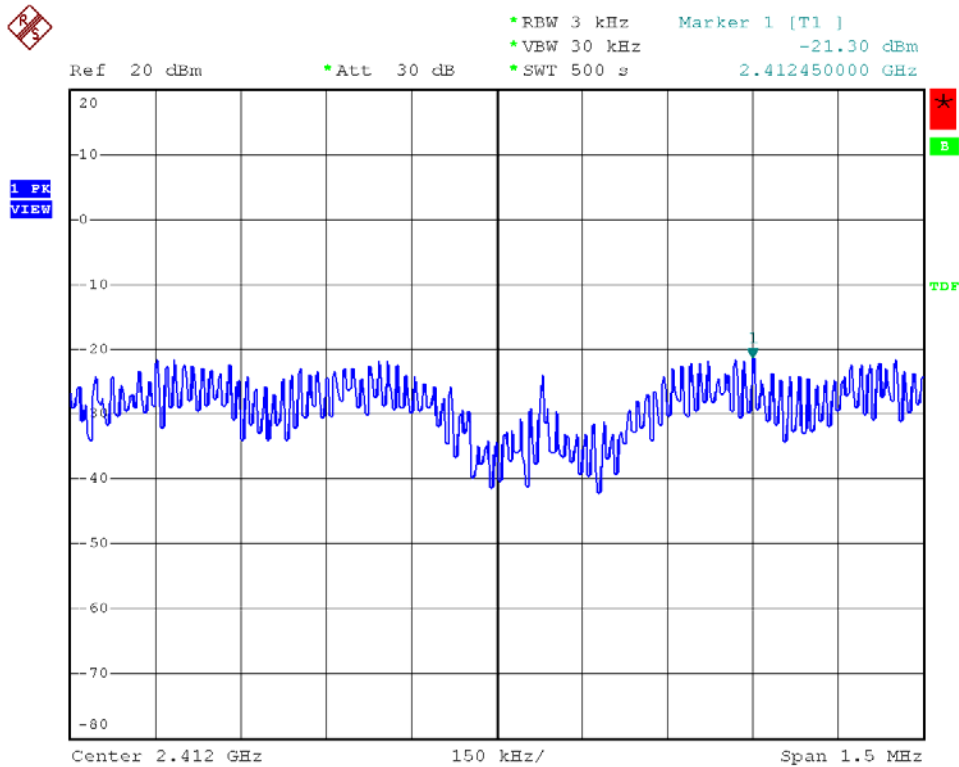



Modulation Standard: 802.11n HT20 (130Mbps), Ant2  
Channel: 06

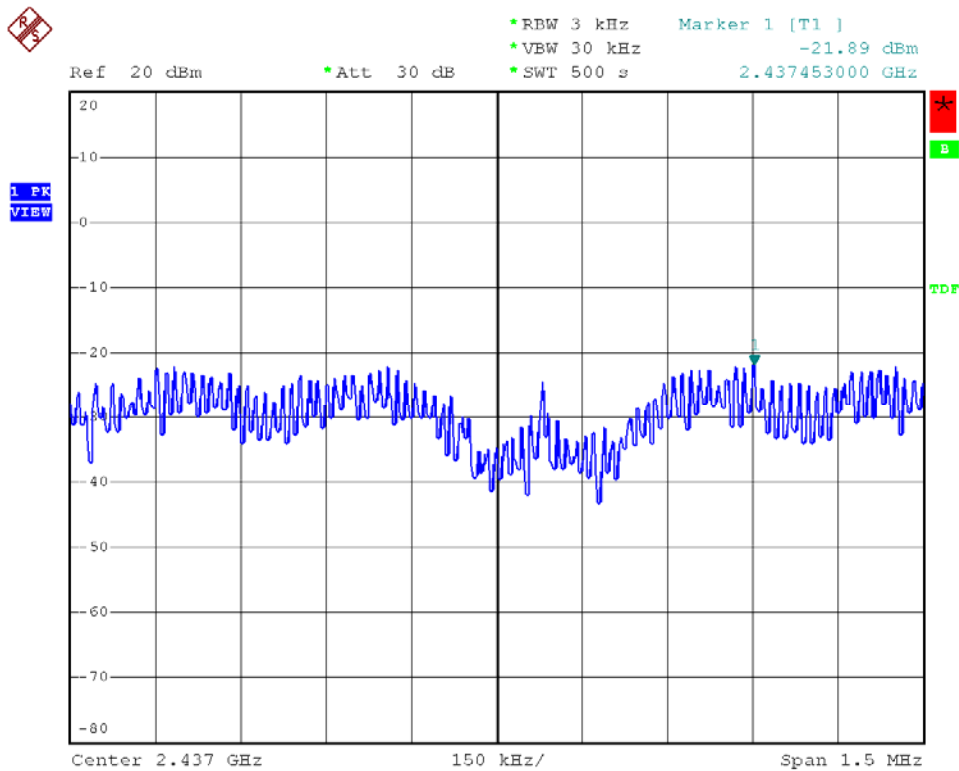

Modulation Standard: 802.11n HT20 (130Mbps), Ant2  
Channel: 11

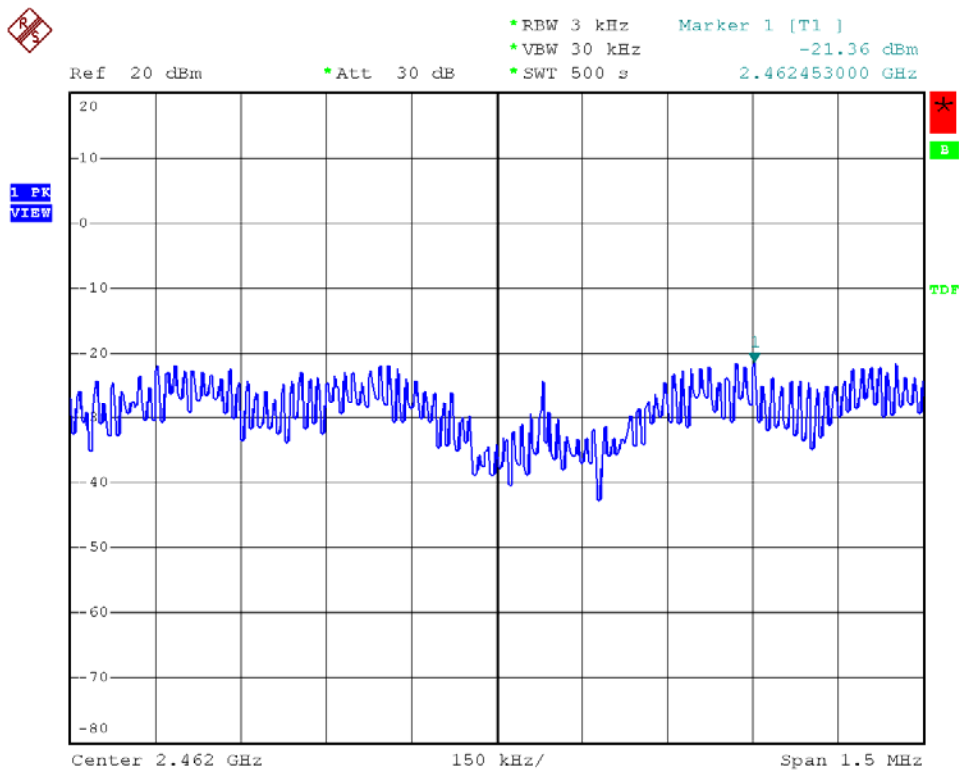



Modulation Standard: 802.11n HT40 (270Mbps), Ant1  
Channel: 03

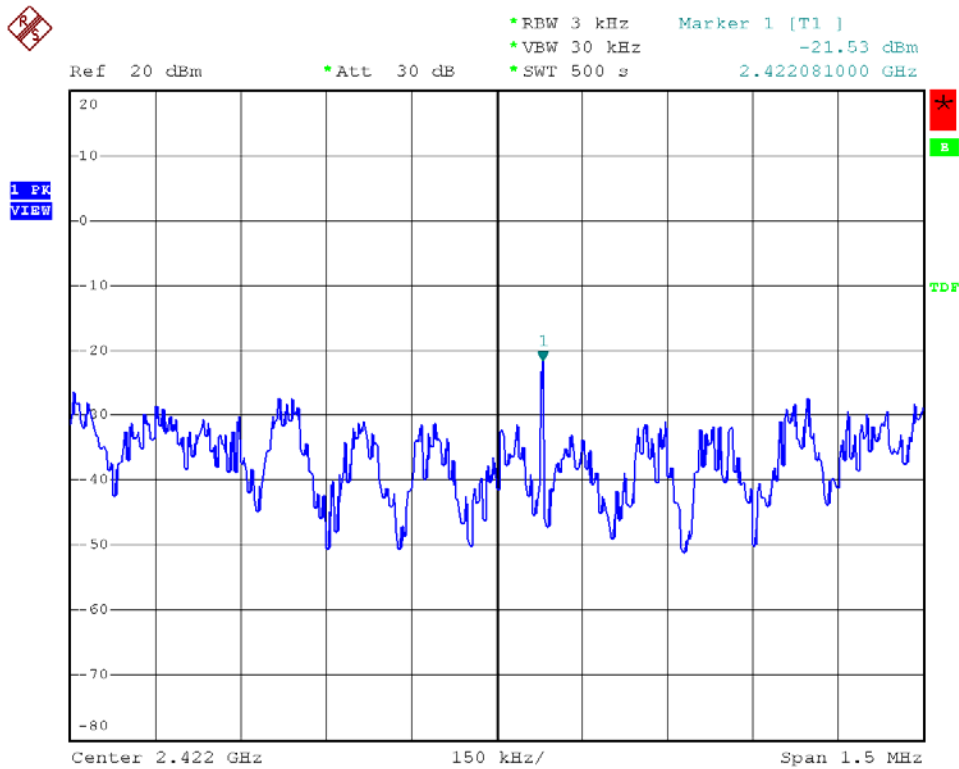

Modulation Standard: 802.11n HT40 (270Mbps), Ant1  
Channel: 06

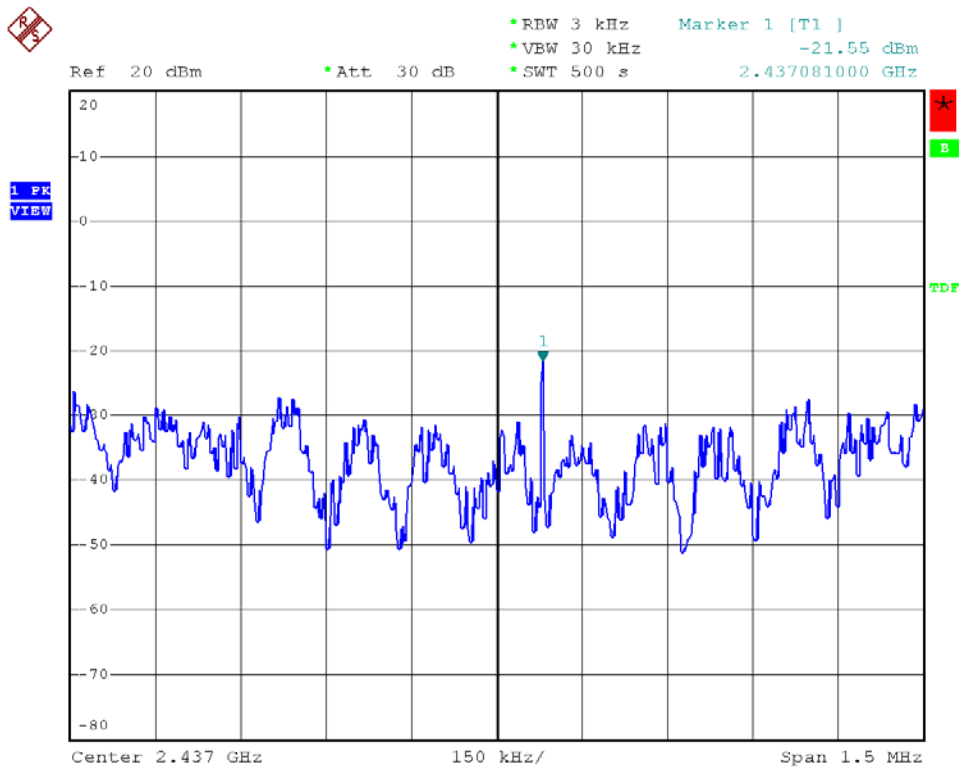





Modulation Standard: 802.11n HT40 (270Mbps), Ant1  
Channel: 09

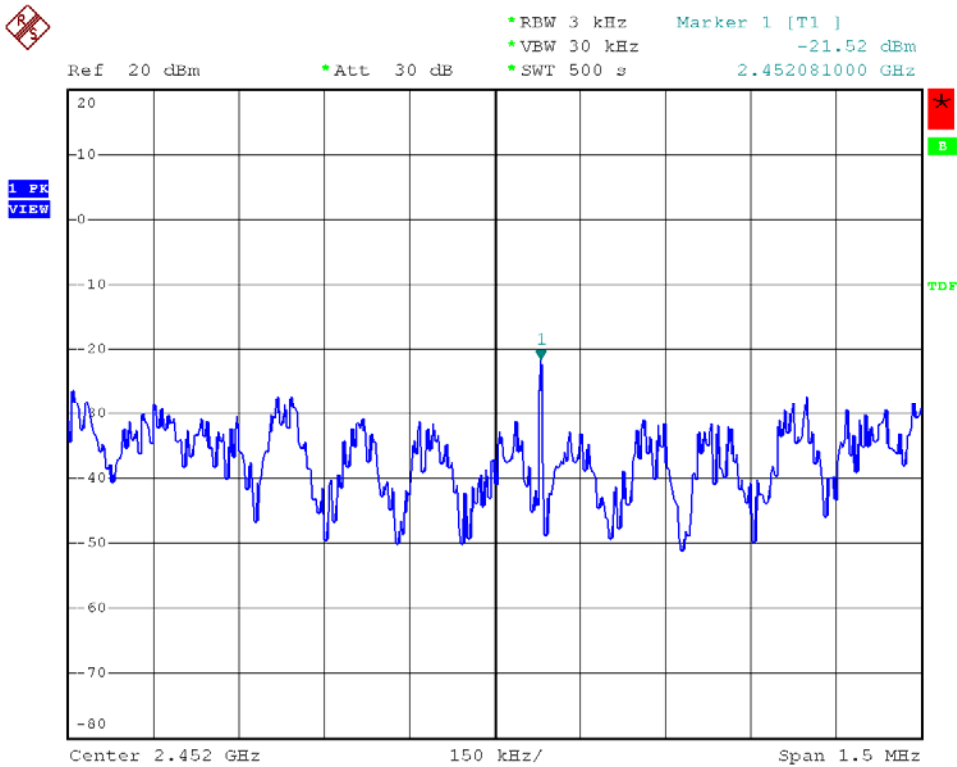

Modulation Standard: 802.11n HT40 (270Mbps), Ant2  
Channel: 03

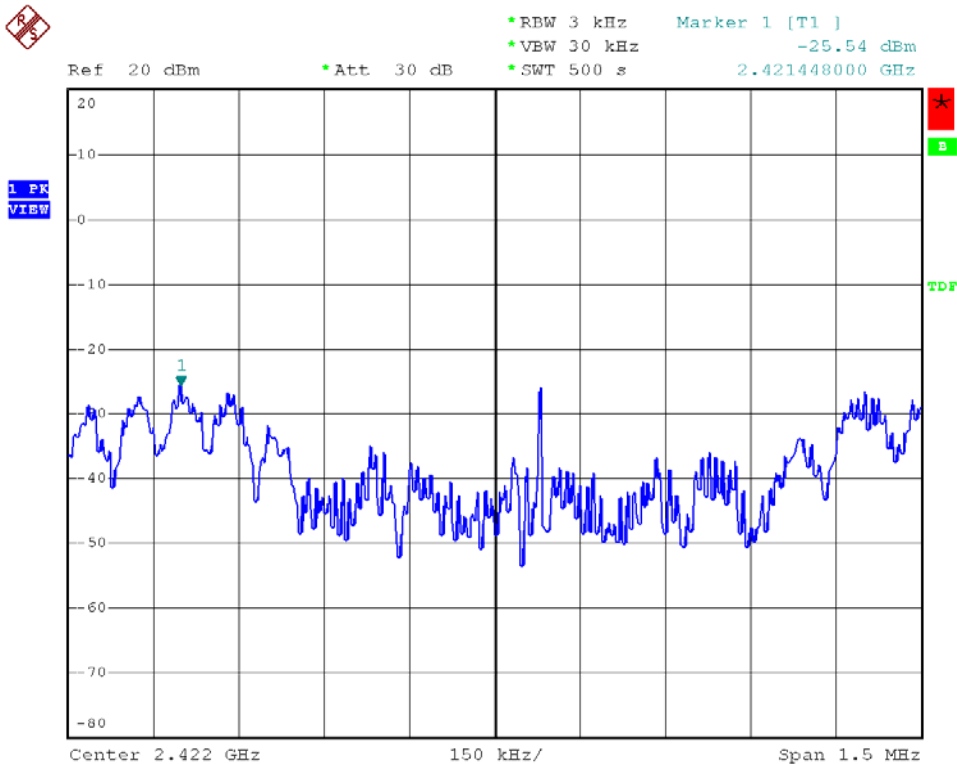



Modulation Standard: 802.11n HT40 (270Mbps), Ant2  
Channel: 06

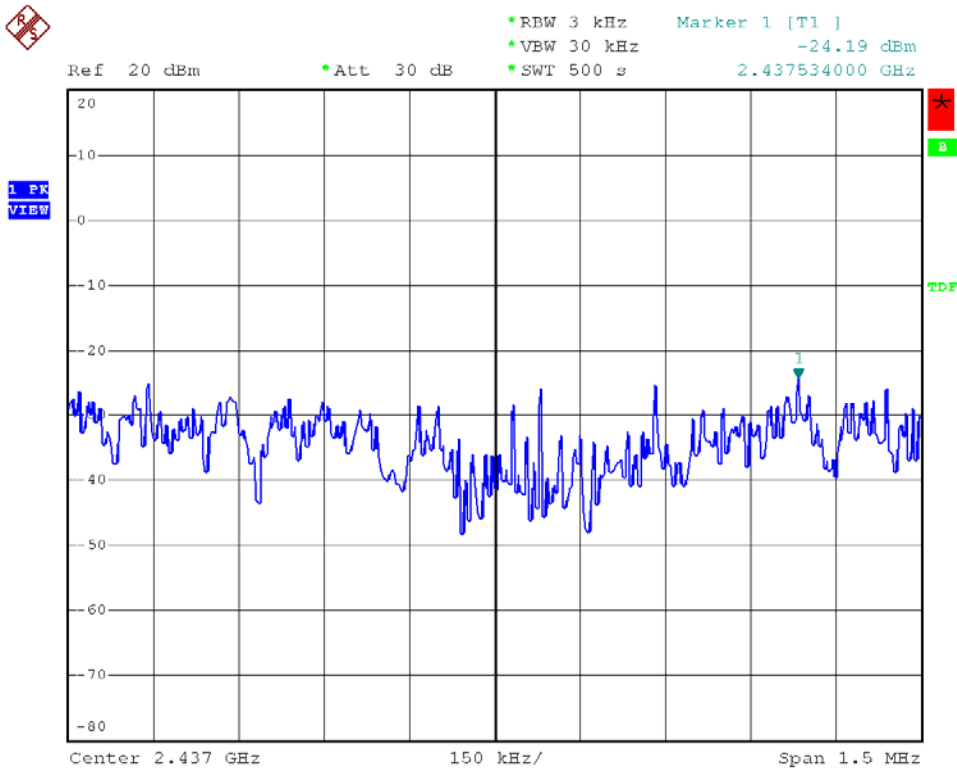

Modulation Standard: 802.11n HT40 (270Mbps), Ant2  
Channel: 09

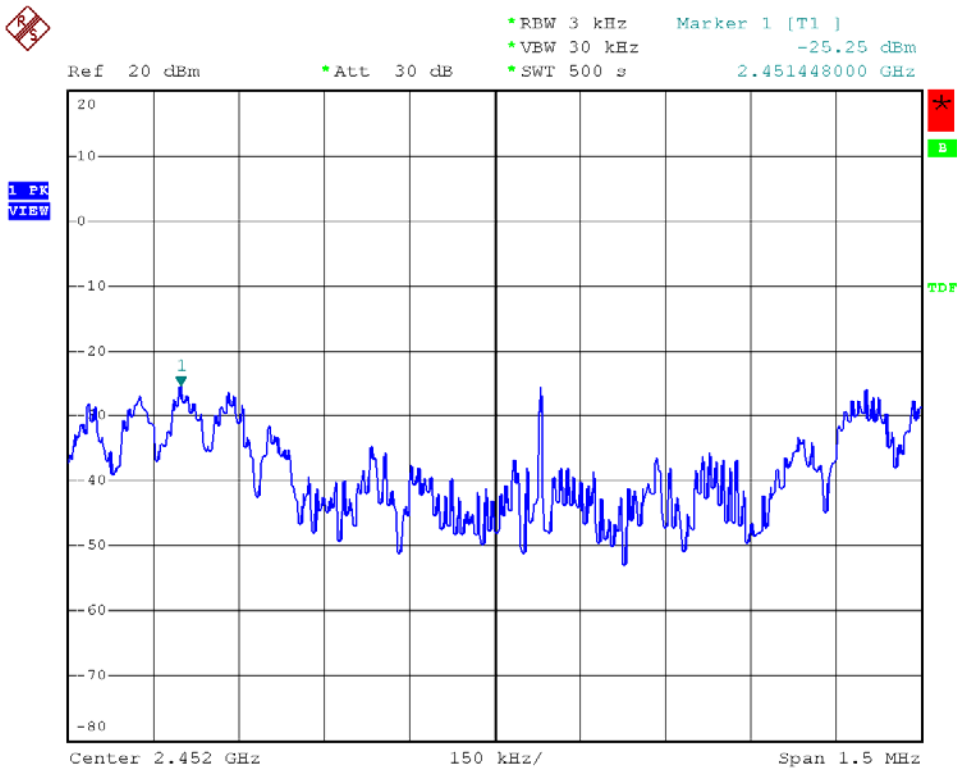



## 9. Band Edges Measurement

### 9.1 Test Limit

Below -20dB of the highest emission level of operating band (In 100 kHz Resolution Bandwidth)

### 9.2 Test Procedure

- a. The transmitter output was connected to the spectrum analyzer via a low lose cable.
- b. Set both RBW and VBW of spectrum analyzer to 100 KHz with convenient frequency span including 100 KHz bandwidth from band edge.
- c. The band edges was measured and recorded.

### 9.3 Test Setup Layout

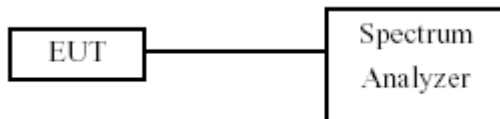

### 9.4 Measurement Equipment

Instrument/Ancillary	Manufacturer	Model No.	Serial No.	Calibration Date	Valid Date
Spectrum Analyzer	R&S	FSP40	100219	2009/11/20	2010/11/19

### 9.5 Test Result and Data

Test Date: Apr. 16, 2010

Temperature: 25°C

Atmospheric pressure: 1022 hPa

Humidity: 65%

Modulation Standard	Channel	Frequency (MHz)	maximum value in frequency (MHz)		maximum value (dBm)	
			Ant1	Ant2	Ant1	Ant2
802.11b (11Mbps)	01	2412	2399.2	2399.8	-39.09	-38.68
	11	2462	2484.6	2483.5	-50.88	-49.93
802.11g (54Mbps)	01	2412	2400.0	2400.0	-44.29	-44.09
	11	2462	2483.5	2483.5	-53.95	-53.75
802.11n HT20 (130Mbps)	01	2412	2399.9	2399.9	-44.64	-45.23
	11	2462	2496.2	2484.1	-54.09	-52.96
802.11n HT40 (270Mbps)	03	2422	2398.8	2399.0	-48.33	-49.51
	09	2452	2492.1	2487.7	-52.28	-53.77



Modulation Standard: 802.11b (11Mbps), Ant1  
Channel: 01

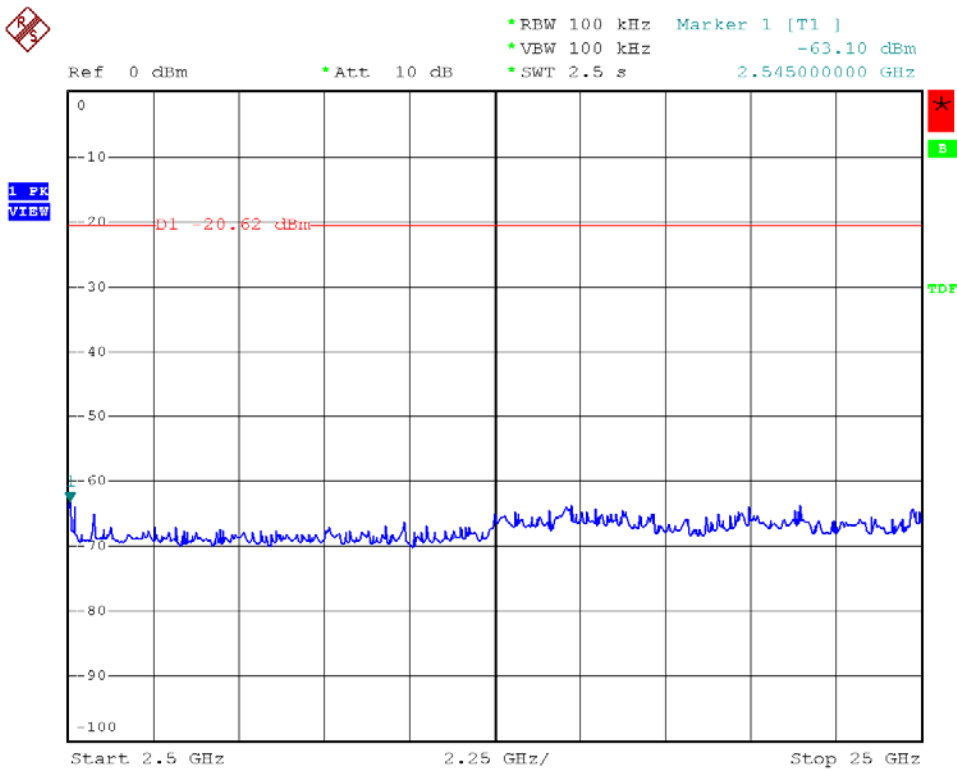
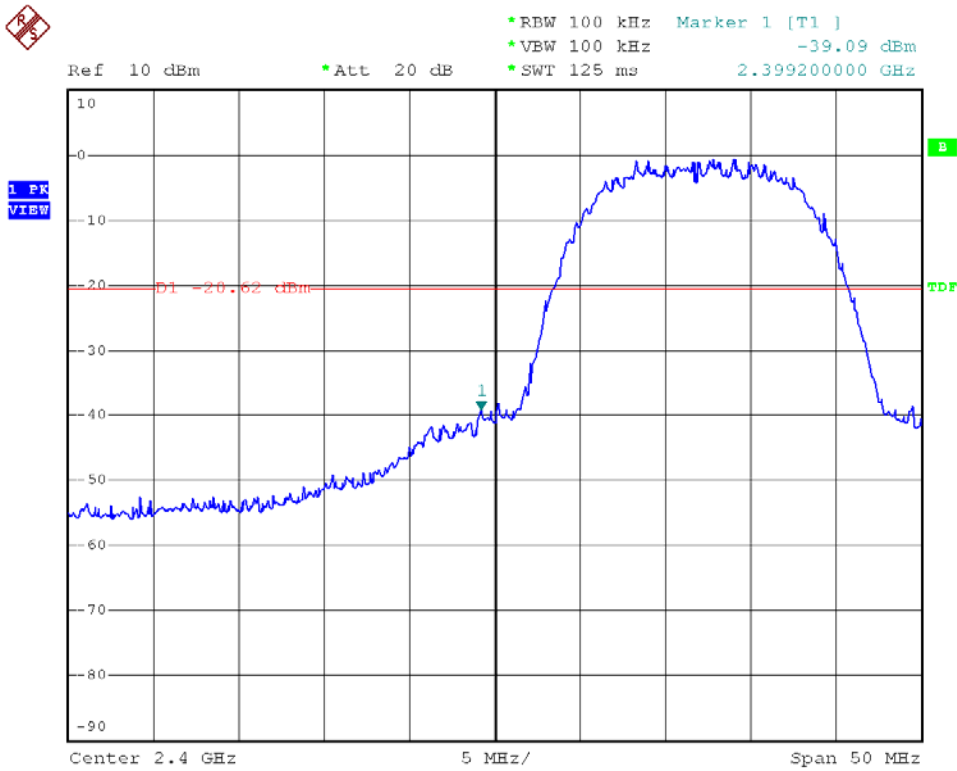



Modulation Standard: 802.11b (11Mbps), Ant1  
Channel: 11

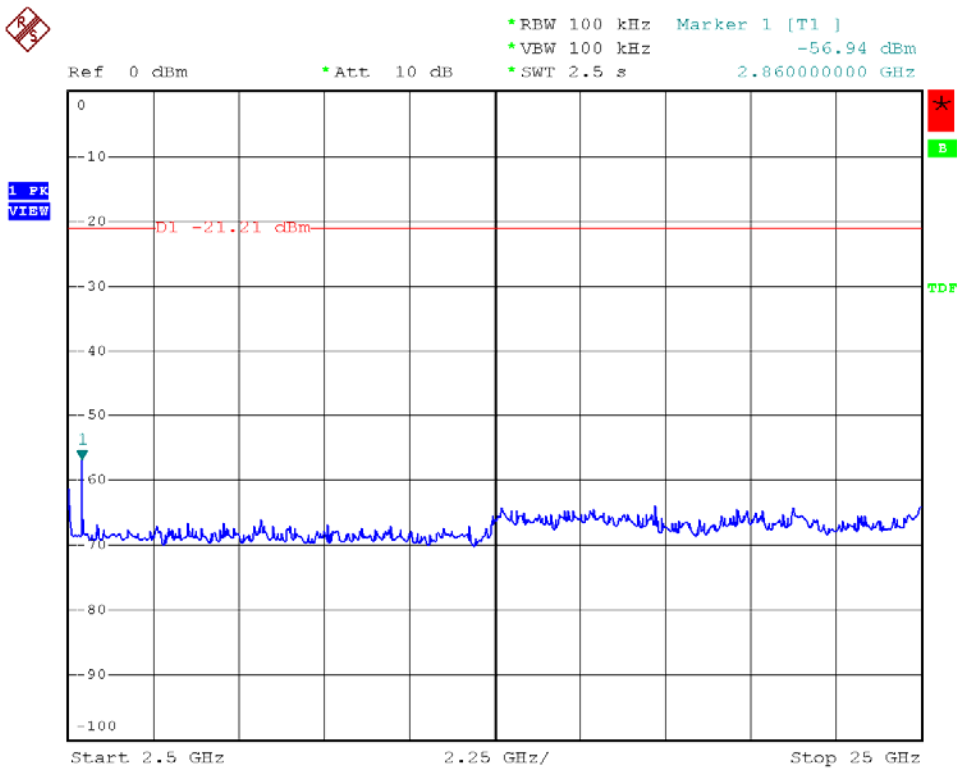
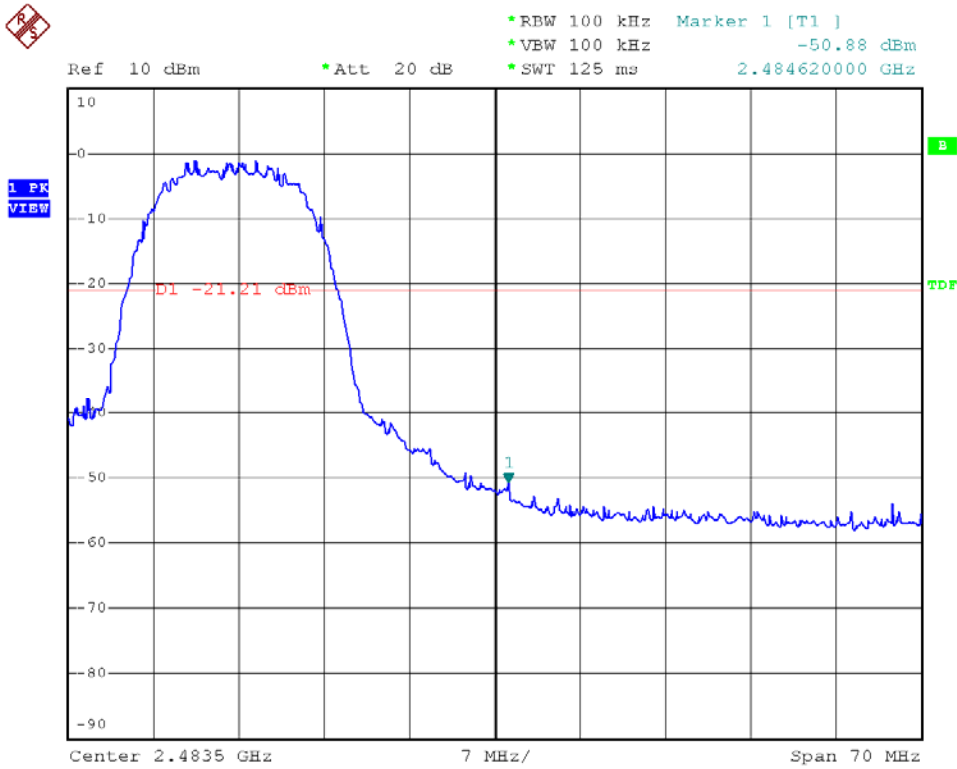



Modulation Standard: 802.11b (11Mbps), Ant2  
Channel: 01

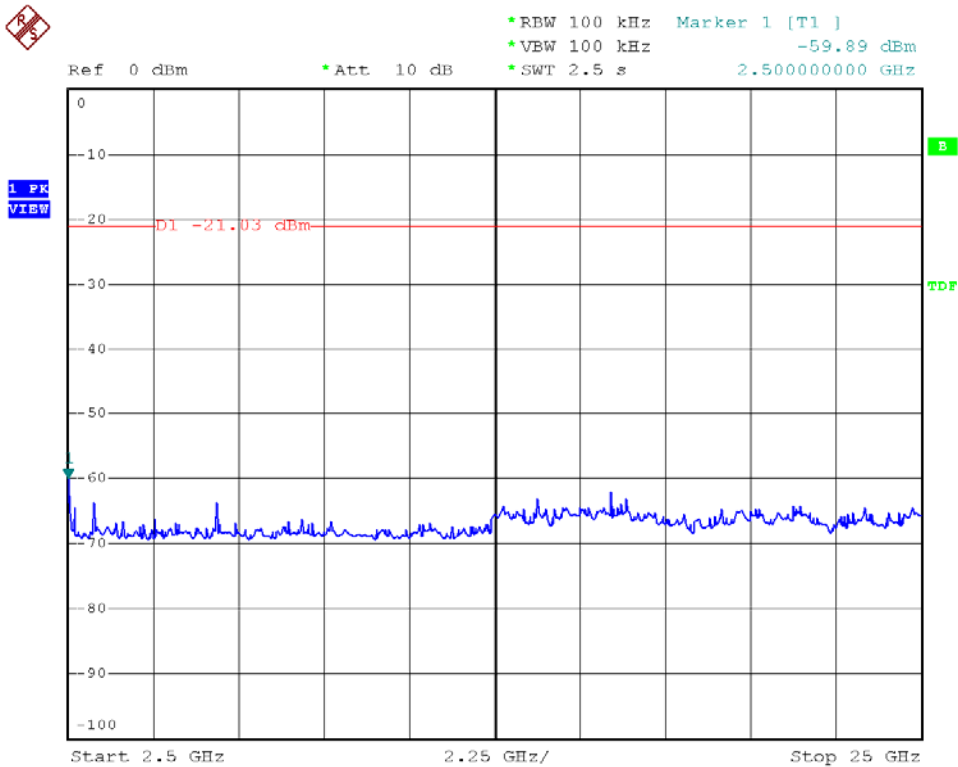
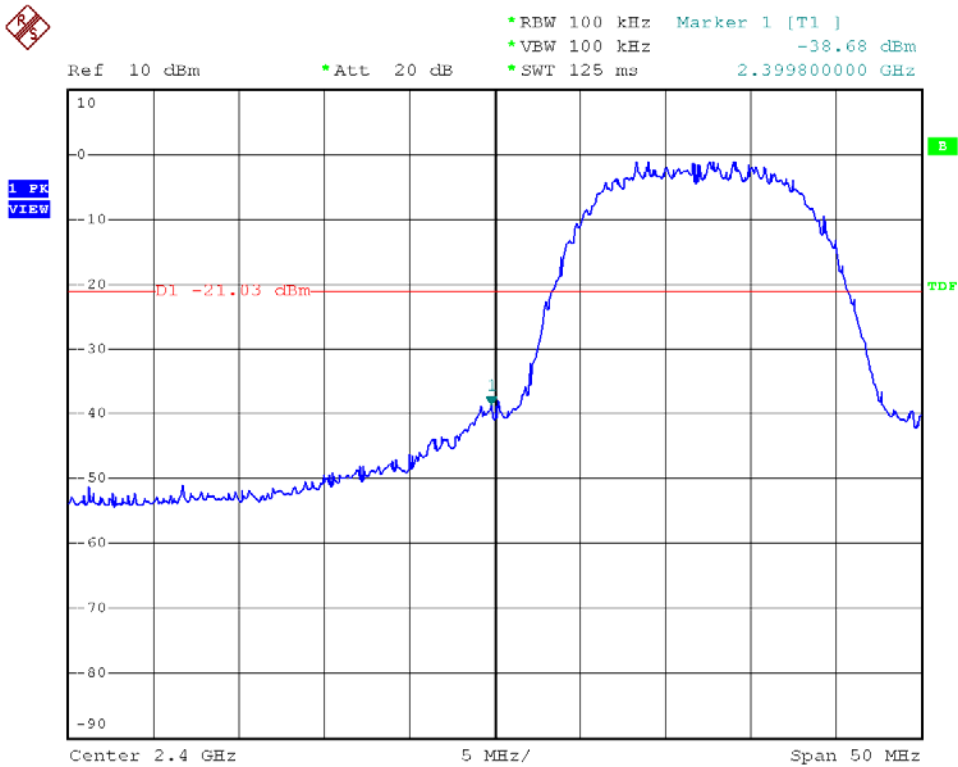



Modulation Standard: 802.11b (11Mbps), Ant2  
Channel: 11

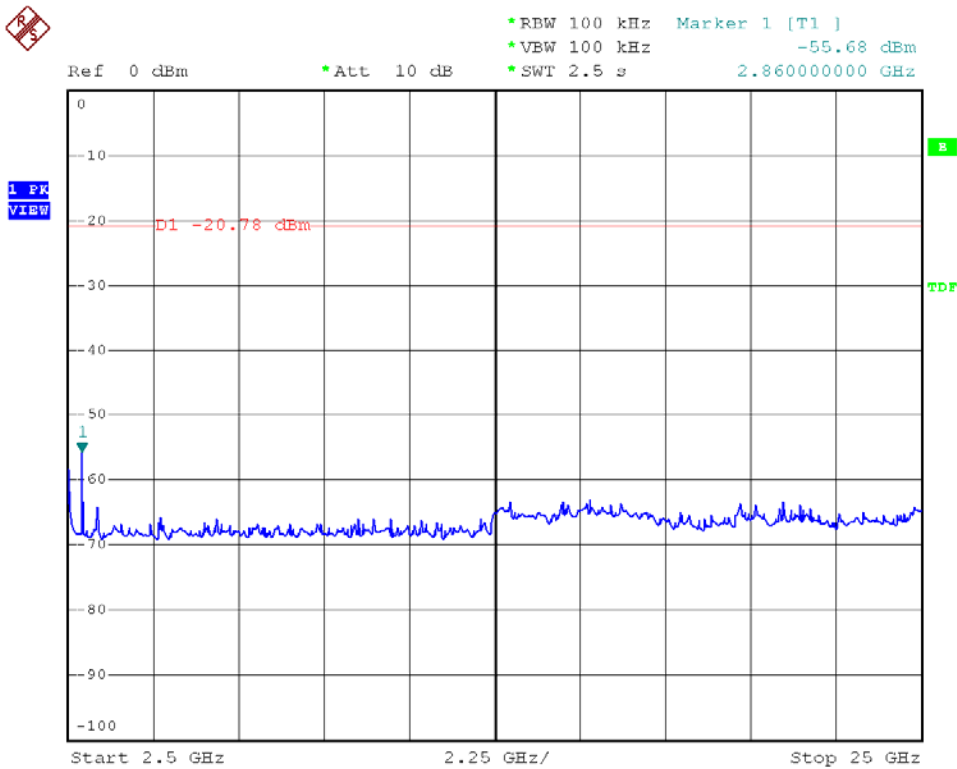
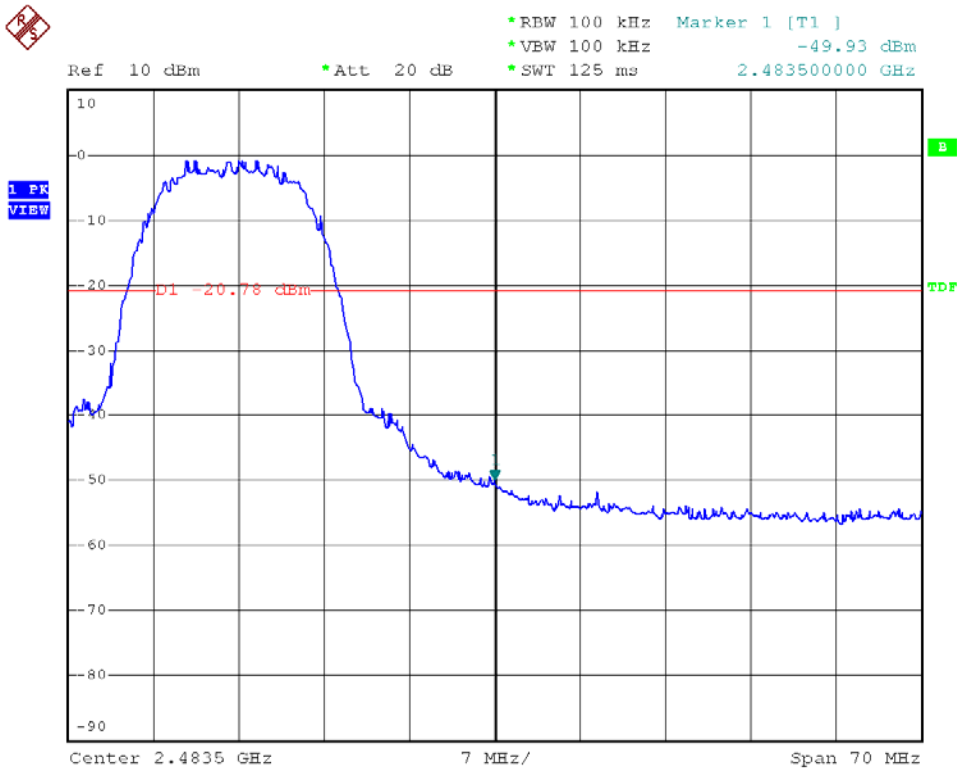



Modulation Standard: 802.11g (54Mbps), Ant1  
Channel: 01

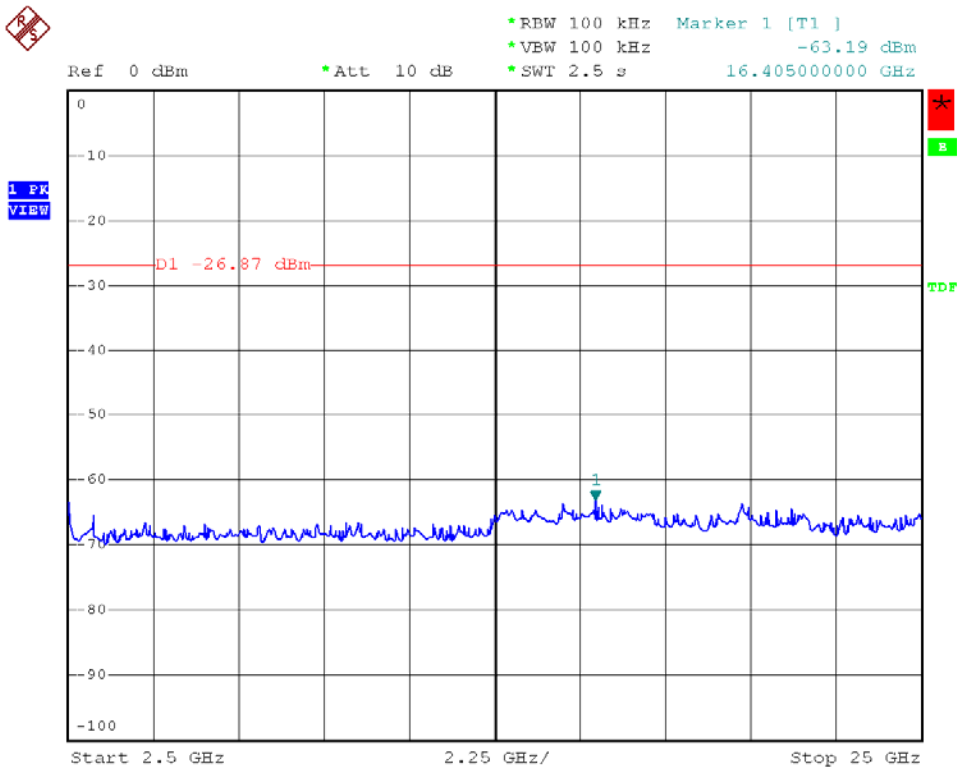
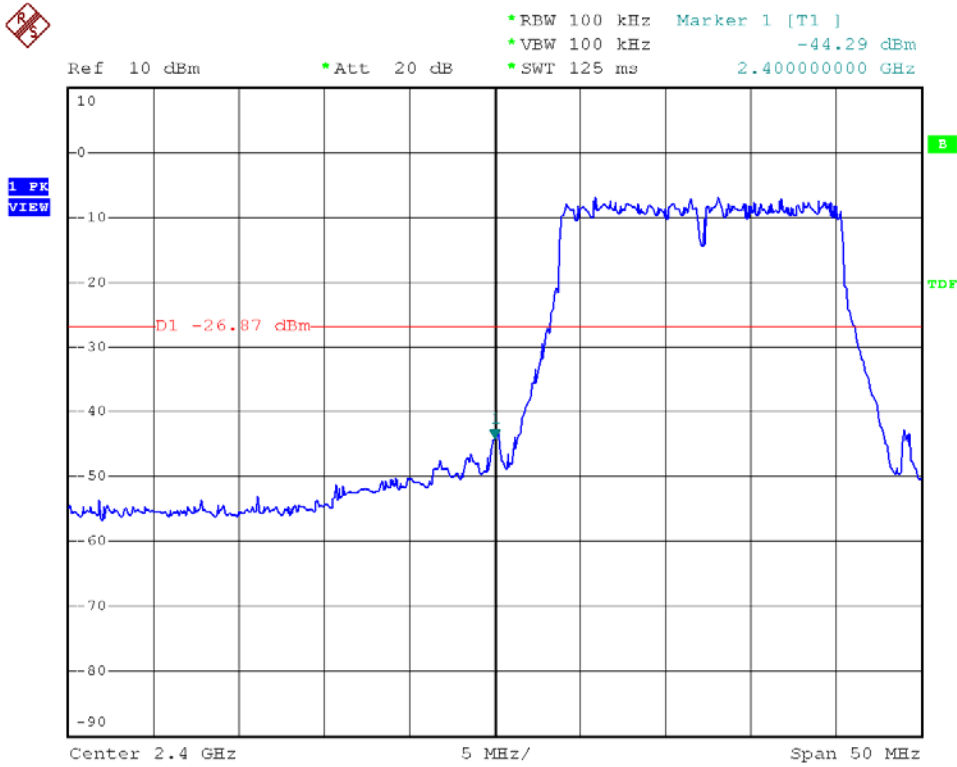





Modulation Standard: 802.11g (54Mbps), Ant1  
Channel: 11

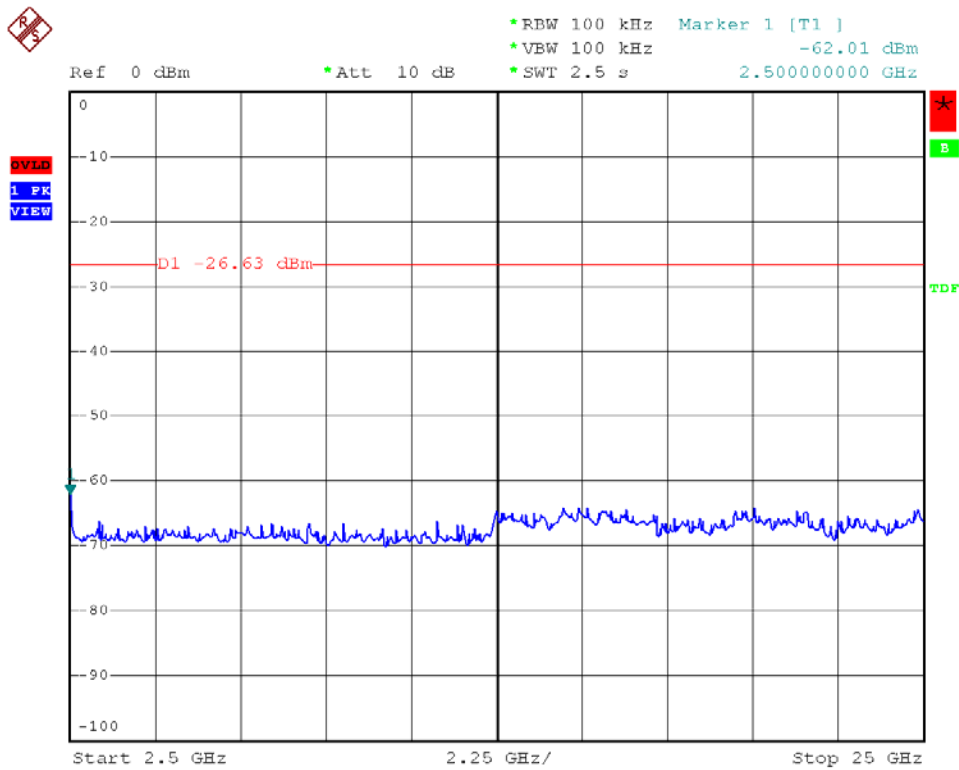
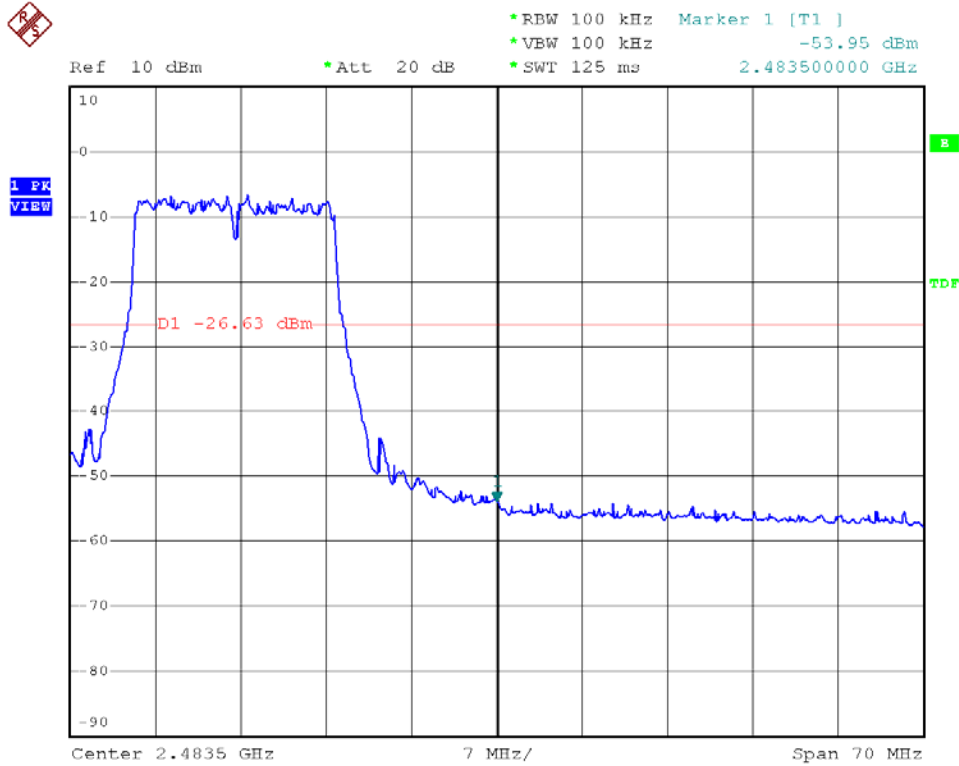



Modulation Standard: 802.11g (54Mbps), Ant2  
Channel: 01

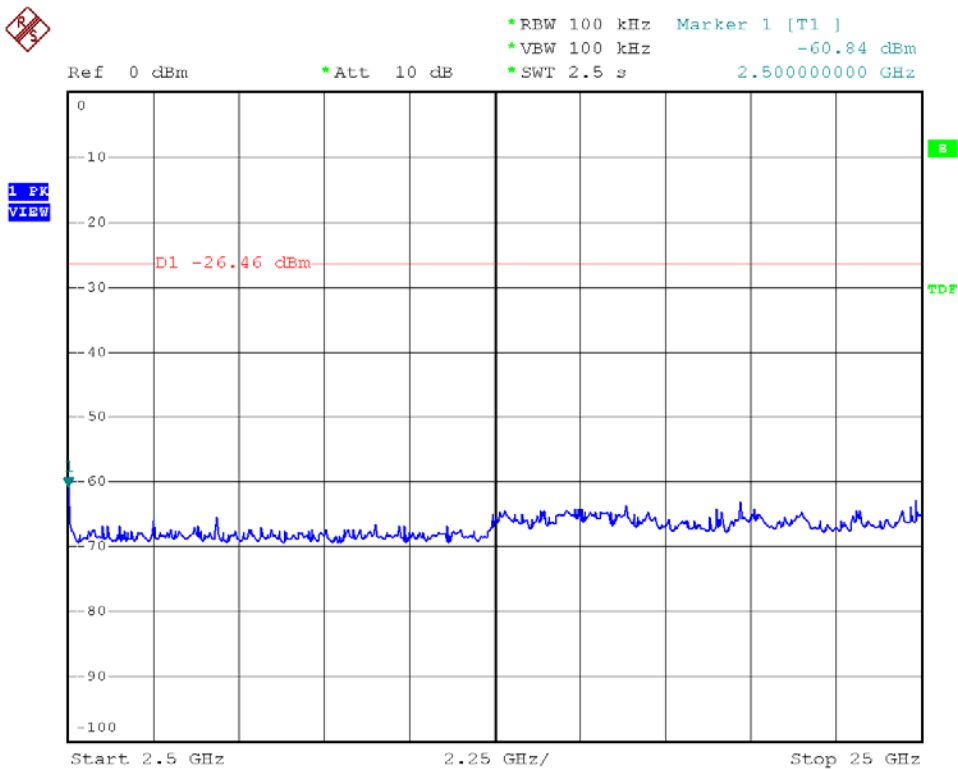
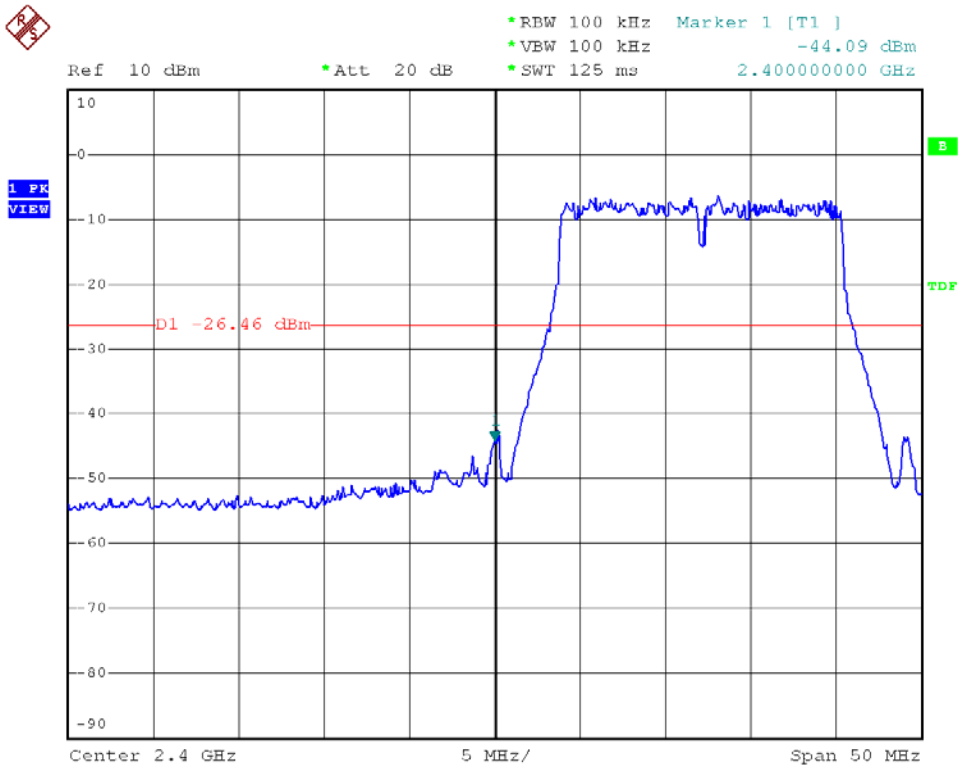



Modulation Standard: 802.11g (54Mbps), Ant2  
Channel: 11

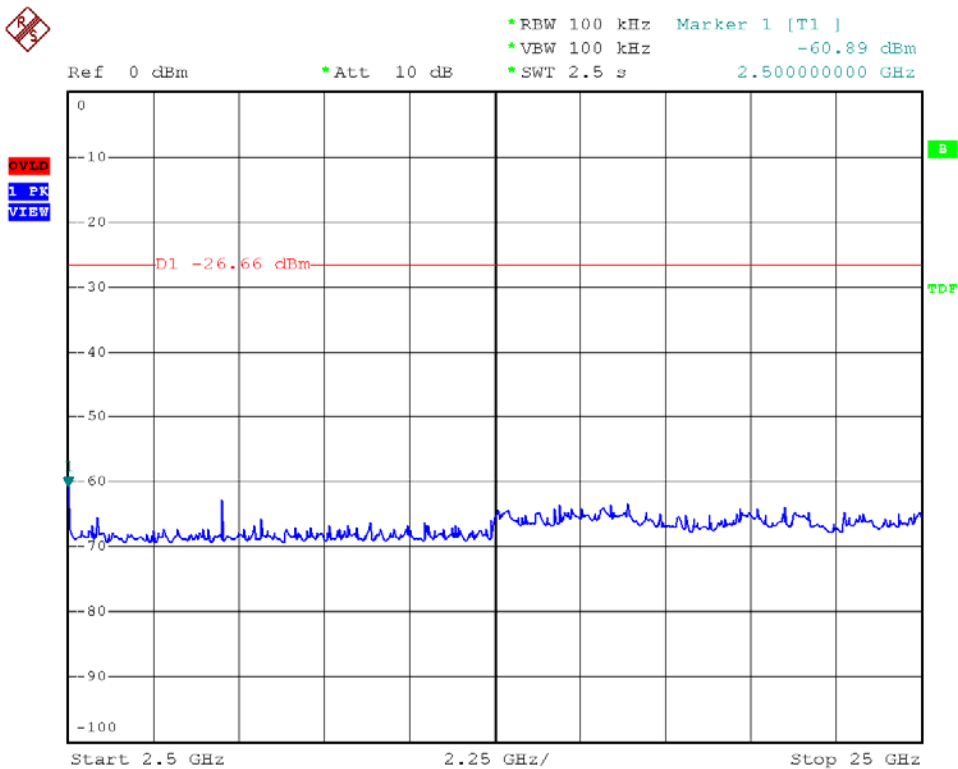
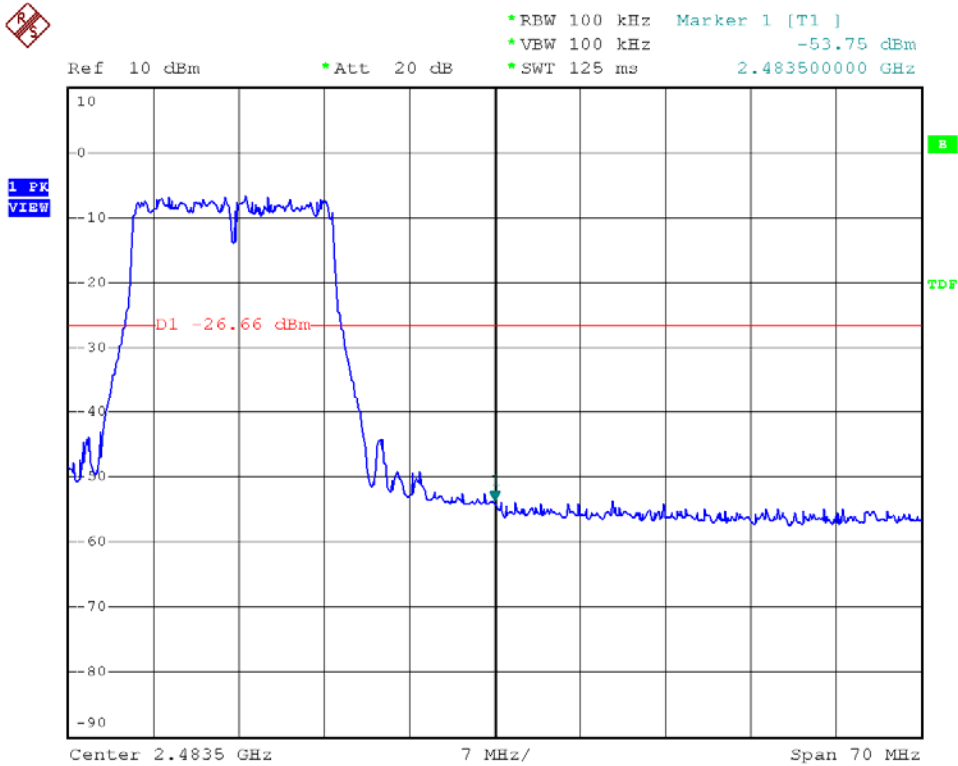



Modulation Standard: 802.11n HT20 (130Mbps), Ant1  
Channel: 01

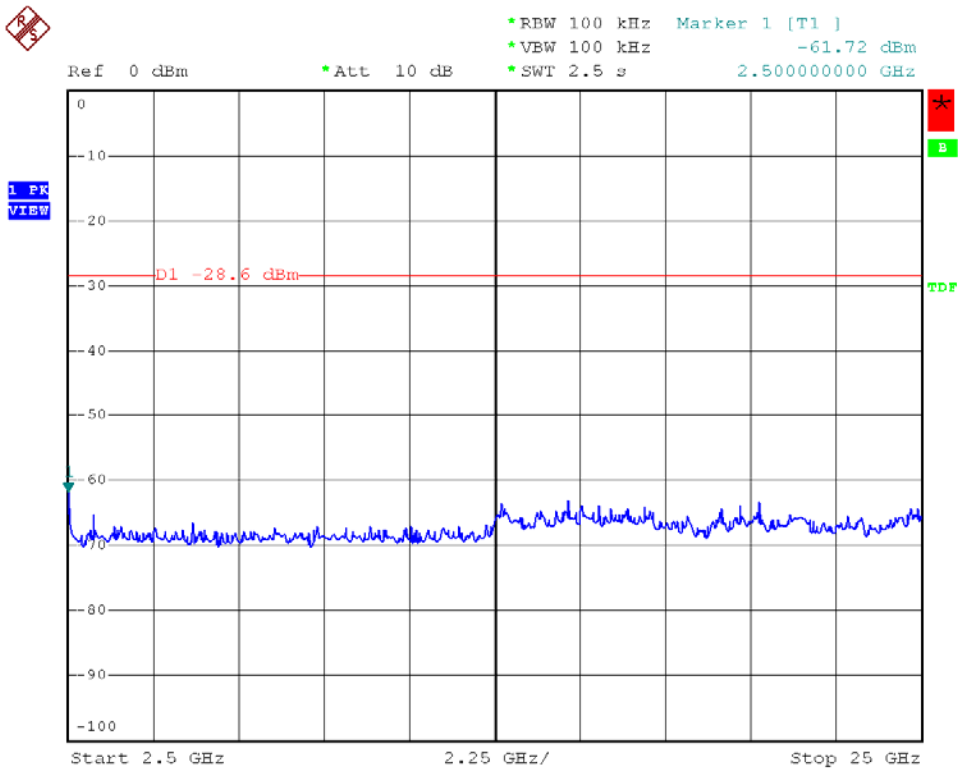
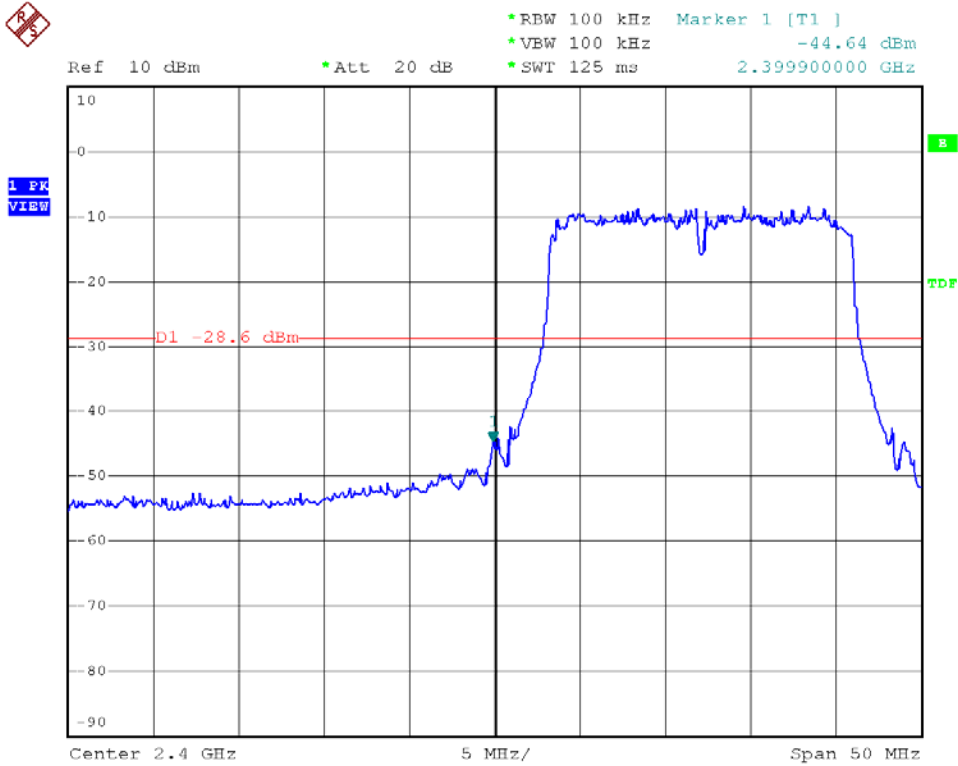



Modulation Standard: 802.11n HT20 (130Mbps), Ant1  
Channel: 11

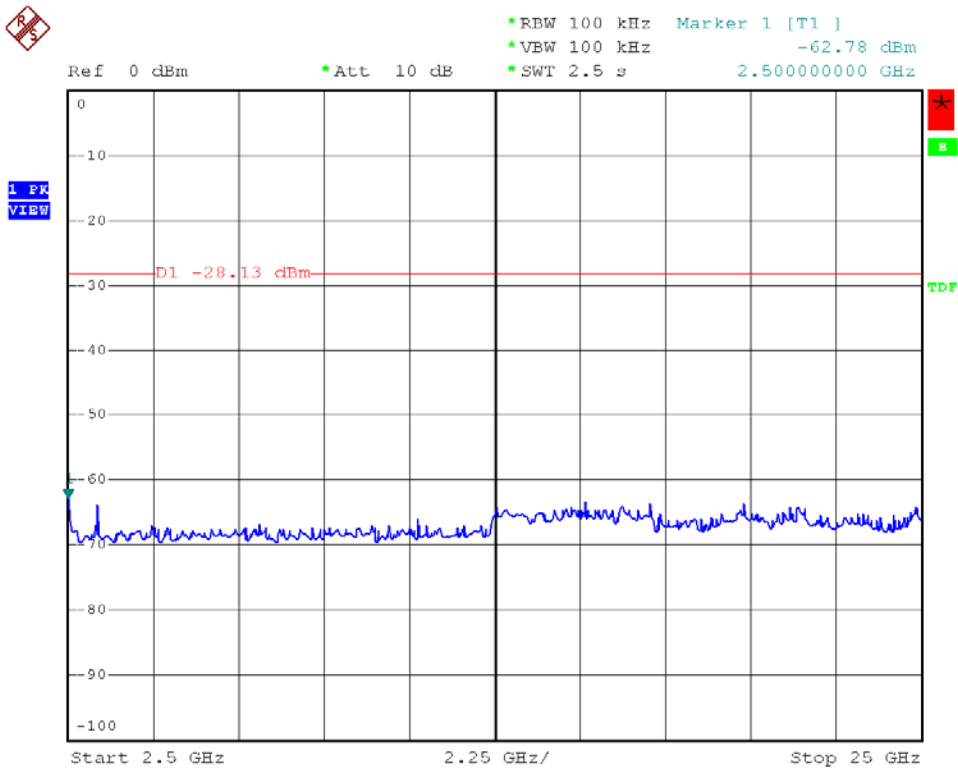
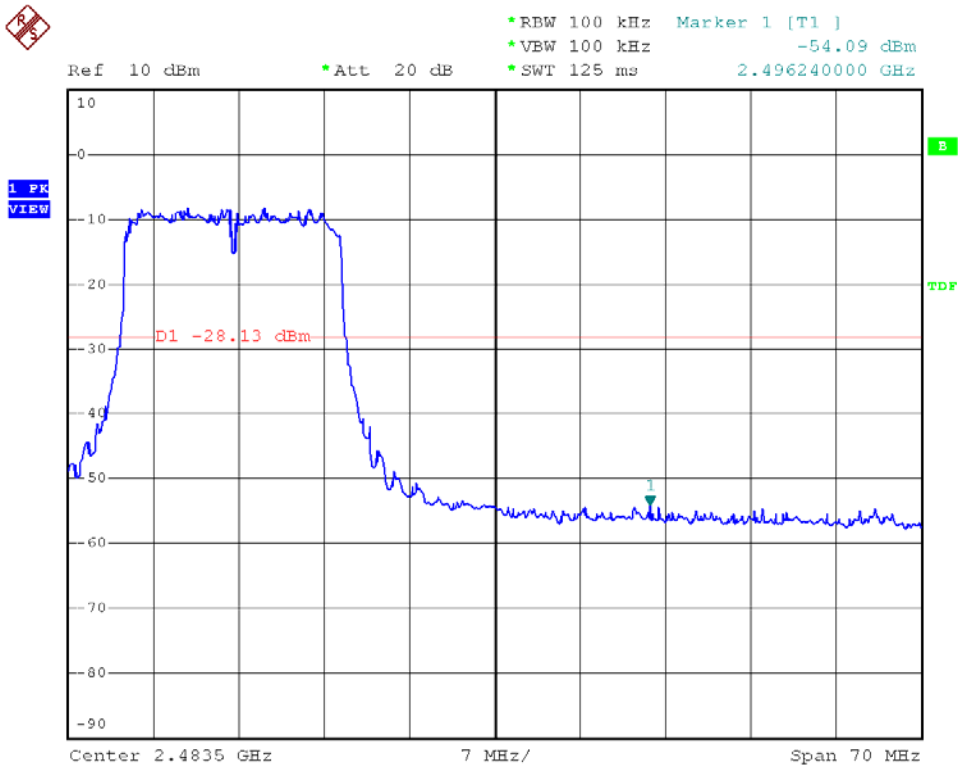



Modulation Standard: 802.11n HT20 (130Mbps), Ant2  
Channel: 01

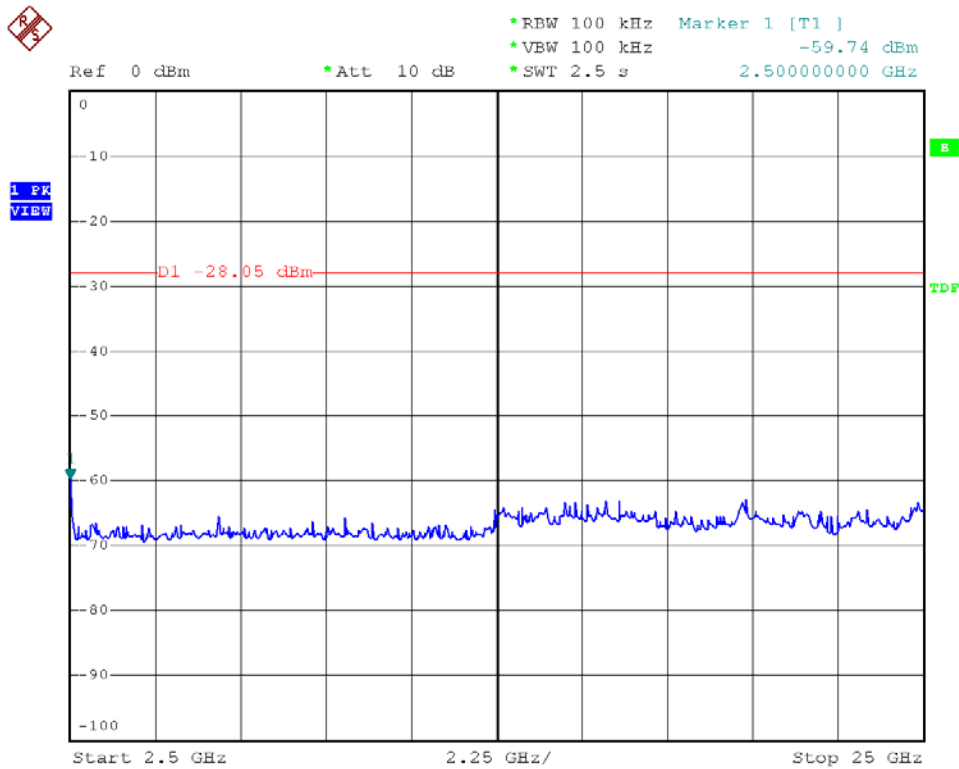
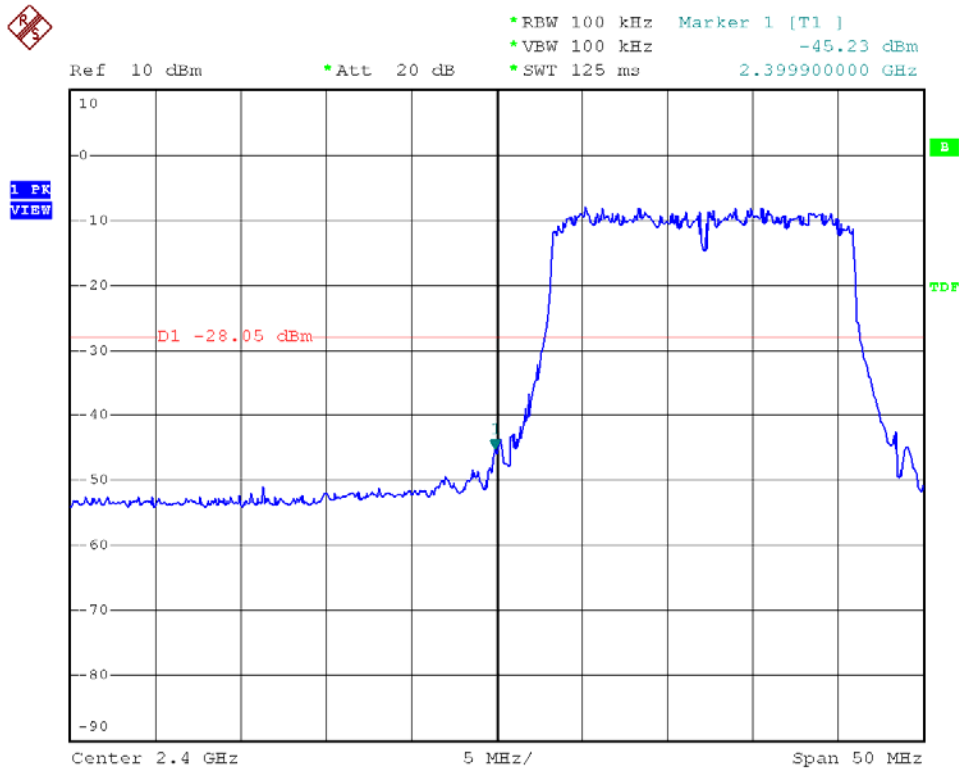



Modulation Standard: 802.11n HT20 (130Mbps), Ant2  
Channel: 11

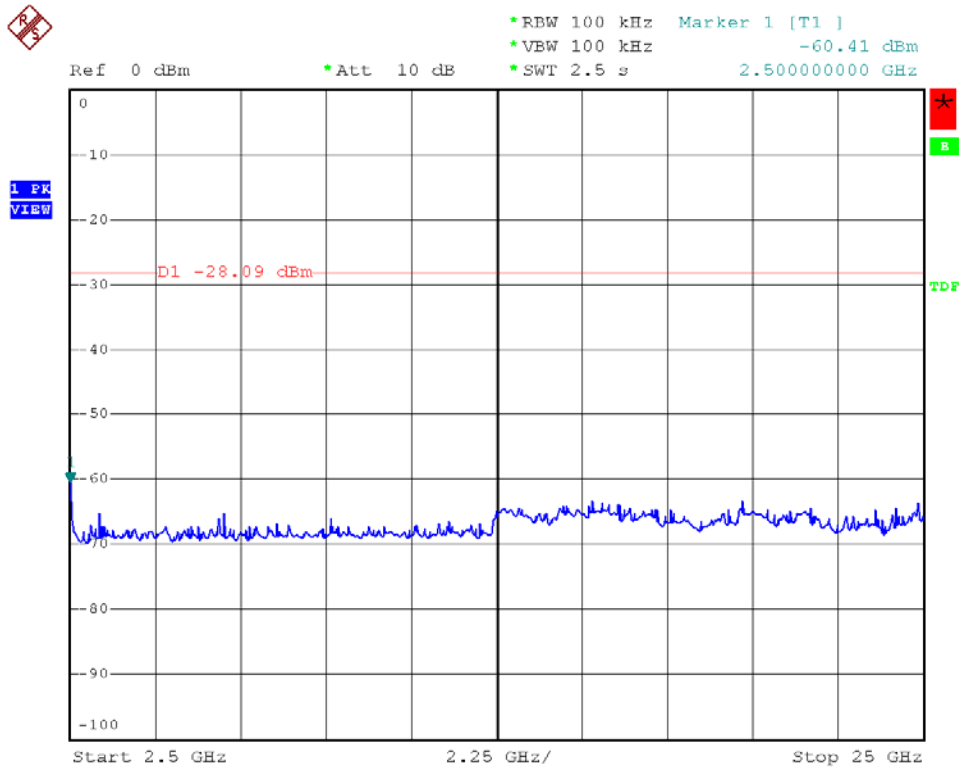
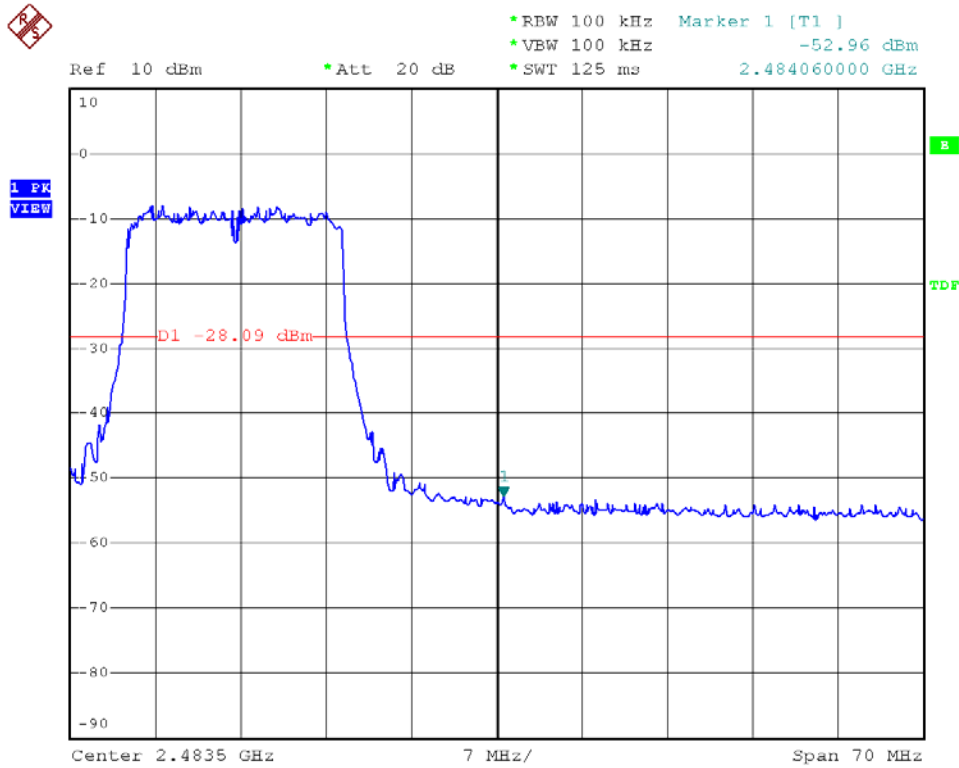



Modulation Standard: 802.11n HT40 (270Mbps), Ant1  
Channel: 03

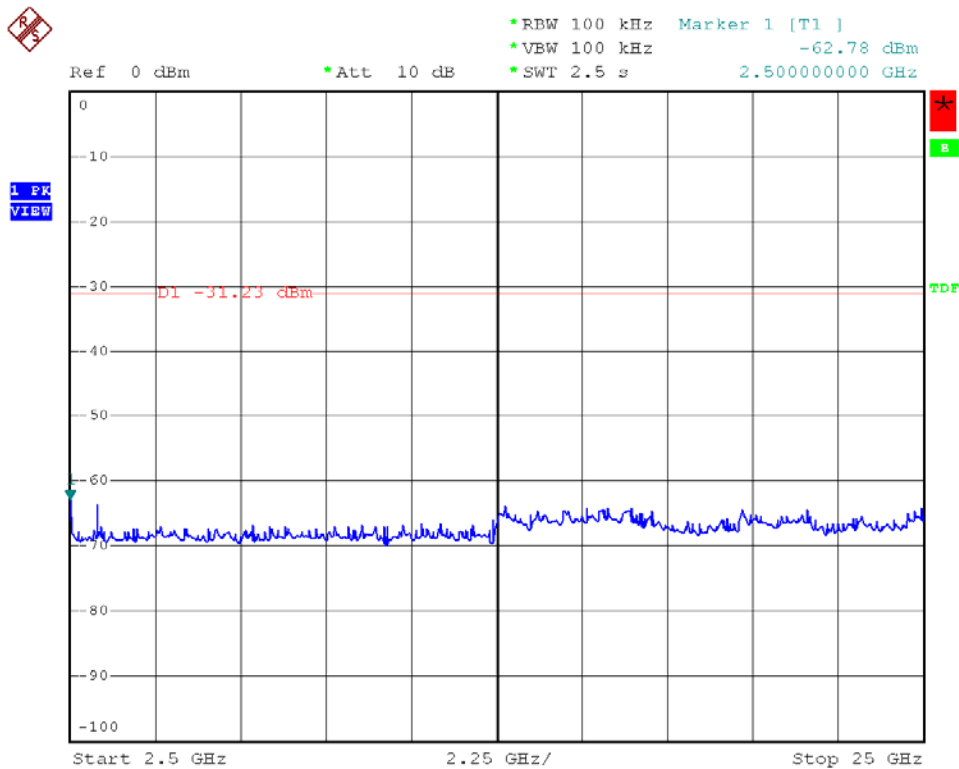
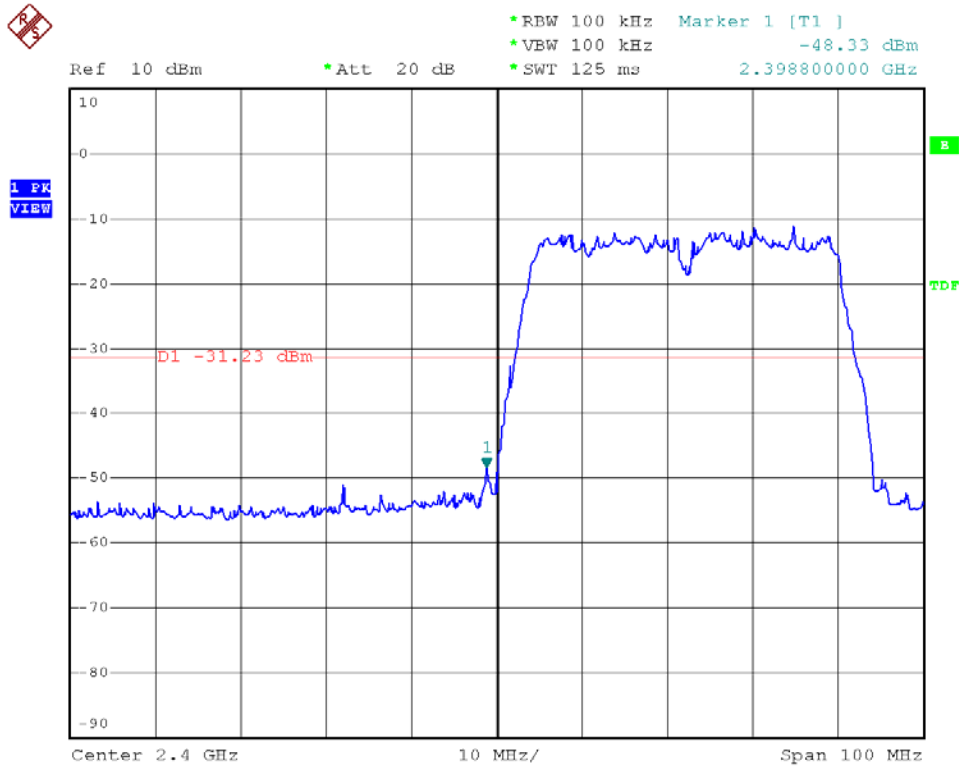





Modulation Standard: 802.11n HT40 (270Mbps), Ant1  
Channel: 09

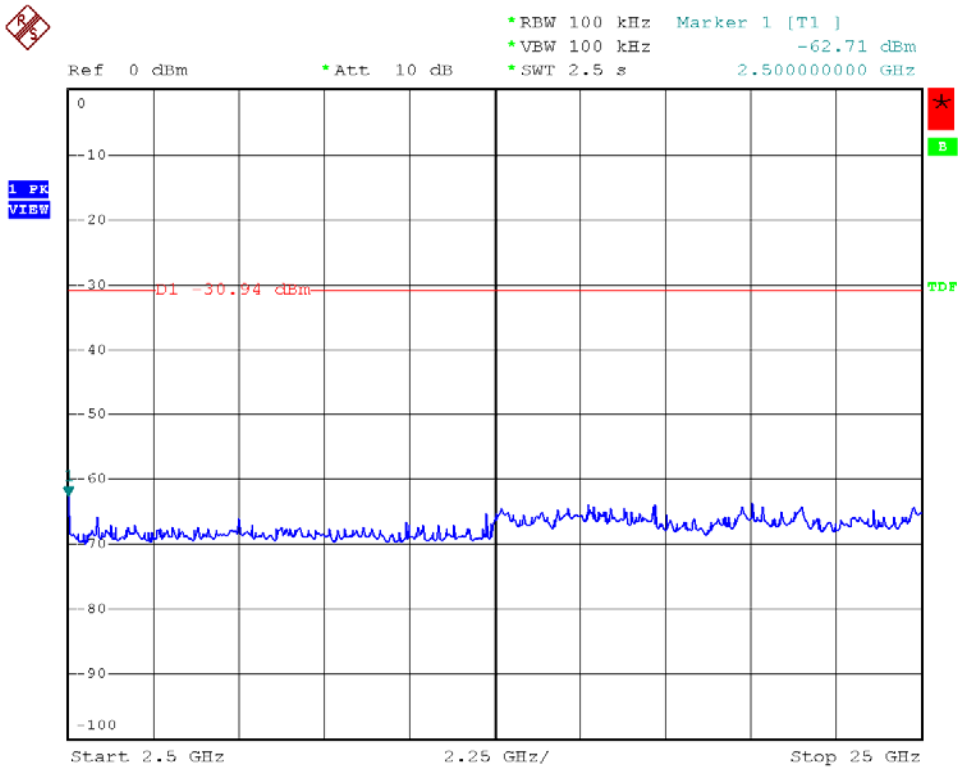
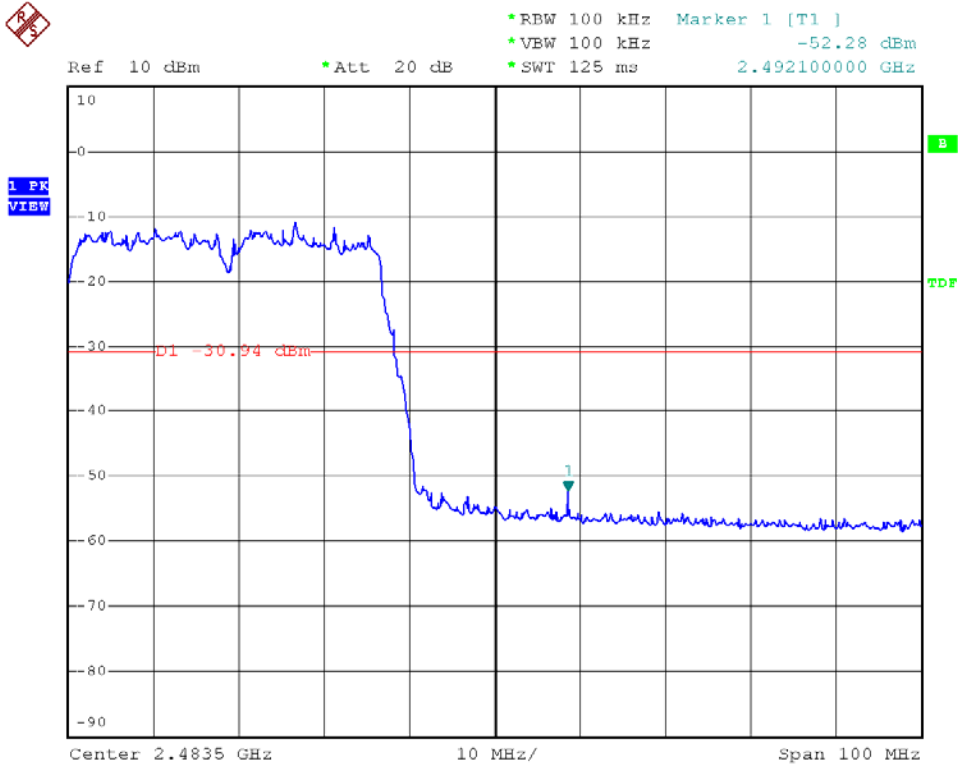



Modulation Standard: 802.11n HT40 (270Mbps), Ant2  
Channel: 03

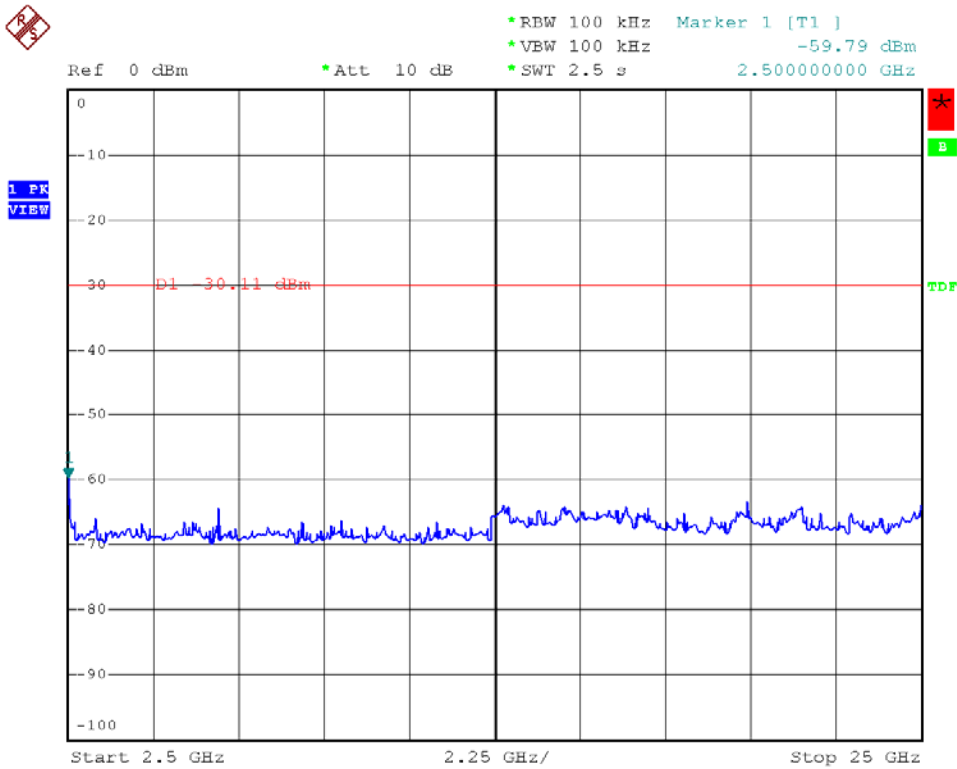
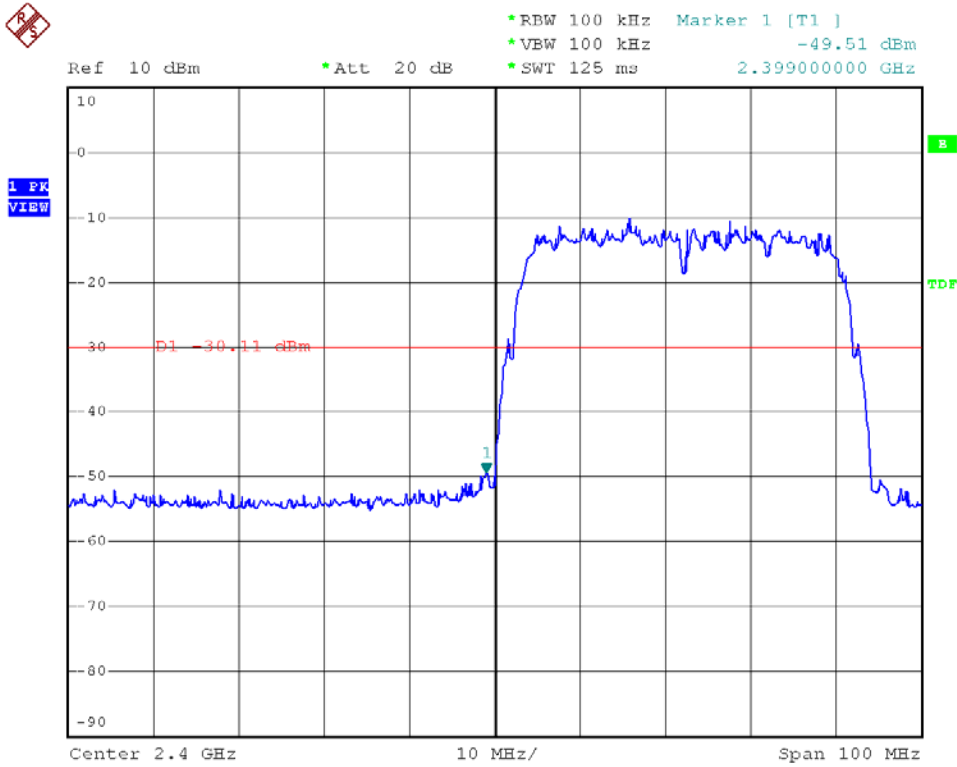



Modulation Standard: 802.11n HT40 (270Mbps), Ant2  
Channel: 09

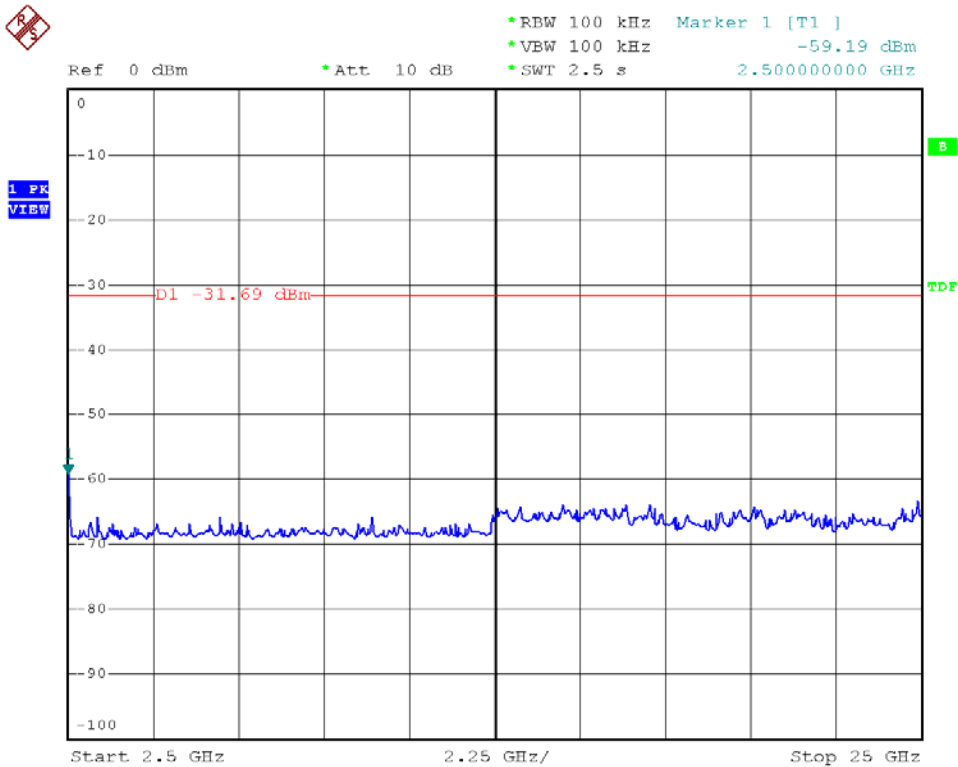
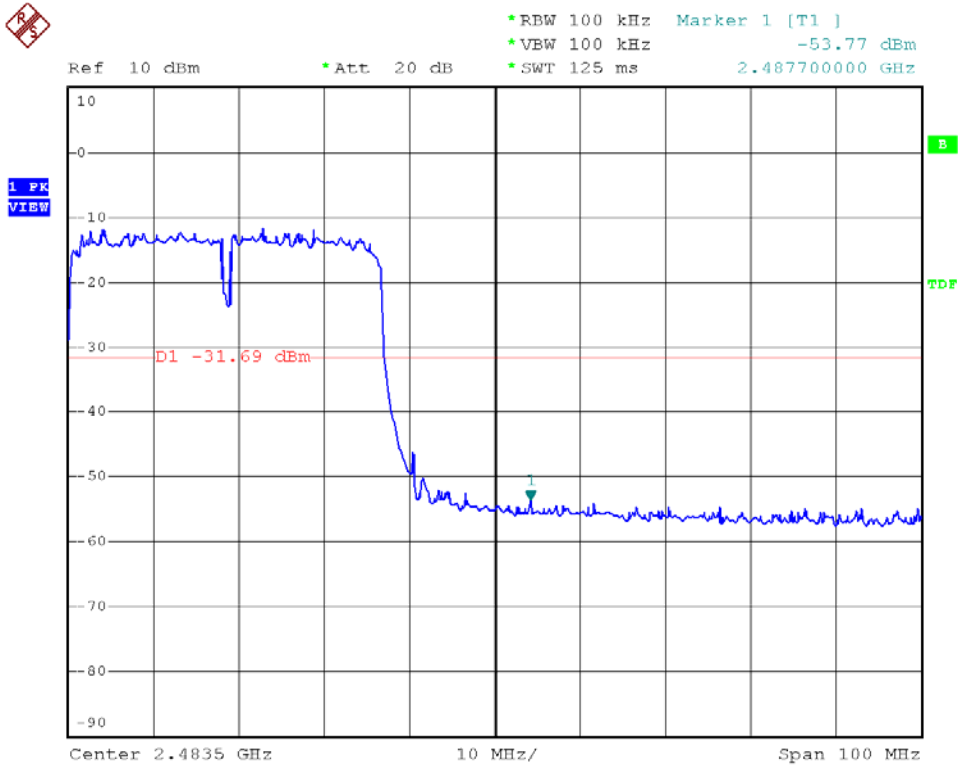



### 9.6 Restrict Band Emission Measurement Data

Test Date: Apr. 20, 2010

Temperature: 26°C

Atmospheric pressure: 1022 hPa

Humidity: 58%

Modulation Standard: IEEE 802.11b (11Mbps)

Channel 1						Fundamental Frequency: 2412 MHz				
Frequency (MHz)	Ant-Pol H/V	Meter Reading (dBuV)	Corrected Factor (dB)	Result (dBuV/m)	Remark	Limit (dBuV/m)		Margin (dB)	Table Deg.	Ant High (m)
						Peak	Ave			
2333.97	H	49.58	-0.990	48.68	Peak	74	54	-25.32	248	100
2390.00	H	37.42	-0.67	36.75	Ave	74	54	-17.25	248	100
2349.78	V	61.43	-0.83	60.60	Peak	74	54	-13.40	182	100
2390.00	V	45.29	-0.67	44.62	Ave	74	54	-9.38	182	100
Channel 11						Fundamental Frequency: 2462 MHz				
Frequency (MHz)	Ant-Pol H/V	Meter Reading (dBuV)	Corrected Factor (dB)	Result (dBuV/m)	Remark	Limit (dBuV/m)		Margin (dB)	Table Deg.	Ant High (m)
						Peak	Ave			
2488.98	H	52.65	-0.25	52.40	Peak	74	54	-21.60	146	100
2483.50	H	41.13	-0.27	40.86	Ave	74	54	-13.14	146	100
2483.58	V	57.69	-0.27	57.42	Peak	74	54	-16.58	228	100
2483.50	V	44.22	-0.27	43.95	Ave	74	54	-10.05	228	100

Modulation Standard: IEEE 802.11g (54Mbps)

Channel 1						Fundamental Frequency: 2412 MHz				
Frequency (MHz)	Ant-Pol H/V	Meter Reading (dBuV)	Corrected Factor (dB)	Result (dBuV/m)	Remark	Limit (dBuV/m)		Margin (dB)	Table Deg.	Ant High (m)
						Peak	Ave			
2347.23	H	52.68	-0.84	51.84	Peak	74	54	-22.16	142	100
2390.00	H	40.89	-0.67	40.22	Ave	74	54	-13.78	142	100
2348.25	V	56.66	-0.83	55.83	Peak	74	54	-18.17	229	100
2390.00	V	42.67	-0.67	42.00	Ave	74	54	-12.00	229	100
Channel 11						Fundamental Frequency: 2462 MHz				
Frequency (MHz)	Ant-Pol H/V	Meter Reading (dBuV)	Corrected Factor (dB)	Result (dBuV/m)	Remark	Limit (dBuV/m)		Margin (dB)	Table Deg.	Ant High (m)
						Peak	Ave			
2489.74	H	52.72	-0.25	52.47	Peak	74	54	-21.53	141	100
2483.50	H	41.01	-0.27	40.74	Ave	74	54	-13.26	141	100
2498.86	V	54.64	-0.20	54.44	Peak	74	54	-19.56	229	100
2483.50	V	43.24	-0.27	42.97	Ave	74	54	-11.03	229	100



Modulation Standard: IEEE 802.11n HT20 (130Mbps)

Channel 1						Fundamental Frequency: 2412 MHz				
Frequency (MHz)	Ant-Pol H/V	Meter Reading (dBuV)	Corrected Factor (dB)	Result (dBuV/m)	Remark	Limit (dBuV/m)		Margin (dB)	Table Deg.	Ant High (m)
						Peak	Ave			
2377.12	H	52.90	-0.72	52.18	Peak	74	54	-21.82	169	100
2390.00	H	40.83	-0.67	40.16	Ave	74	54	-13.84	169	100
2351.82	V	55.89	-0.83	55.06	Peak	74	54	-18.94	184	100
2390.00	V	43.77	-0.67	43.10	Ave	74	54	-10.90	184	100
Channel 11						Fundamental Frequency: 2462 MHz				
Frequency (MHz)	Ant-Pol H/V	Meter Reading (dBuV)	Corrected Factor (dB)	Result (dBuV/m)	Remark	Limit (dBuV/m)		Margin (dB)	Table Deg.	Ant High (m)
						Peak	Ave			
2488.60	H	53.21	-0.25	52.96	Peak	74	54	-21.04	226	100
2483.50	H	40.93	-0.27	40.66	Ave	74	54	-13.34	226	100
2483.58	V	55.41	-0.27	55.14	Peak	74	54	-18.86	206	100
2483.50	V	43.16	-0.27	42.89	Ave	74	54	-11.11	206	100

Modulation Standard: IEEE 802.11n HT40 (270Mbps)

Channel 3						Fundamental Frequency: 2422 MHz				
Frequency (MHz)	Ant-Pol H/V	Meter Reading (dBuV)	Corrected Factor (dB)	Result (dBuV/m)	Remark	Limit (dBuV/m)		Margin (dB)	Table Deg.	Ant High (m)
						Peak	Ave			
2381.20	H	53.24	-0.70	52.54	Peak	74	54	-21.46	202	100
2390.00	H	40.85	-0.67	40.18	Ave	74	54	-13.82	202	100
2366.10	V	55.89	-0.76	55.13	Peak	74	54	-18.87	193	100
2390.00	V	43.77	-0.67	43.10	Ave	74	54	-10.90	193	100
Channel 9						Fundamental Frequency: 2452 MHz				
Frequency (MHz)	Ant-Pol H/V	Meter Reading (dBuV)	Corrected Factor (dB)	Result (dBuV/m)	Remark	Limit (dBuV/m)		Margin (dB)	Table Deg.	Ant High (m)
						Peak	Ave			
2483.96	H	53.33	-0.27	53.06	Peak	74	54	-20.94	141	100
2483.50	H	41.01	-0.27	40.74	Ave	74	54	-13.26	141	100
2483.58	V	55.26	-0.27	54.99	Peak	74	54	-19.01	197	100
2483.50	V	42.46	-0.27	42.19	Ave	74	54	-11.81	197	100

Notes:

1. Result = Meter Reading + Factor
2. Factor = Antenna Factor + Cable Loss – Amplifier
3. The resolution bandwidth of test receiver/spectrum analyzer is 1MHz and video bandwidth is 3 MHz for Peak detection at frequency above 1GHz.
4. The resolution bandwidth of test receiver/spectrum analyzer is 1MHz and video bandwidth is 10 MHz for Average detection at frequency above 1GHz.



### 10. Restricted Bands of Operation

Only spurious emissions are permitted in any of the frequency bands listed below:

MHz	MHz	MHz	GHz
0.09000 – 0.11000	16.42000 – 16.42300	399.9 – 410.0	4.500 – 5.250
0.49500 – 0.505**	16.69475 – 16.69525	608.0 – 614.0	5.350 – 5.460
2.17350 – 2.19050	16.80425 – 16.80475	960.0 – 1240.0	7.250 – 7.750
4.12500 – 4.12800	25.50000 – 25.67000	1300.0 – 1427.0	8.025 – 8.500
4.17725 – 4.17775	37.50000 – 38.25000	1435.0 – 1626.5	9.000 – 9.200
4.20725 – 4.20775	73.00000 – 74.60000	1645.5 – 1646.5	9.300 – 9.500
6.21500 – 6.21800	74.80000 – 75.20000	1660.0 – 1710.0	10.600 – 12.700
6.26775 – 6.26825	108.00000 – 121.94000	1718.8 – 1722.2	13.250 – 13.400
6.31175 – 6.31225	123.00000 – 138.00000	2200.0 – 2300.0	14.470 – 14.500
8.29100 – 8.29400	149.90000 – 150.05000	2310.0 – 2390.0	15.350 – 16.200
8.36200 – 8.36600	156.52475 – 156.52525	2483.5 – 2500.0	17.700 – 21.400
8.37625 – 8.38675	156.70000 – 156.90000	2655.0 – 2900.0	22.010 – 23.120
8.41425 – 8.41475	162.01250 – 167.17000	3260.0 – 3267.0	23.600 – 24.000
12.29000 – 12.29300	167.72000 – 173.20000	3332.0 – 3339.0	31.200 – 31.800
12.51975 – 12.52025	240.00000 – 285.00000	3345.8 – 3358.0	36.430 – 36.500
12.57675 – 12.57725	322.00000 – 335.40000	3600.0 – 4400.0	Above 38.6
13.36000 – 13.41000			

\*\* : Until February 1, 1999, this restricted band shall be 0.490-0.510 MHz

#### 10.1 Labeling Requirement

The device shall bear the following statement in a conspicuous location on the device:

This device complies with part 15 of the FCC Rules. Operation is subject to the following two conditions: (1) This device may not cause harmful interference, and (2) this device must accept any interference received, including interference that may cause undesired operation.





Appendix A. Photographs of EUT

