

User Manual

BEC MX-230 M1 4G/LTE Industrial M2M Router



Copyright Notice

Copyright © 2018 BEC Technologies Inc. All rights reserved.

BEC Technologies reserves the right to change and make improvement to this manual at any time without prior notice.

No part of this document may be reproduced, copied, transmitted in any form or by any means without prior written permission from BEC Technologies, Inc.

Antenna List

No.	Manufacturer	Part No.	Antenna Type	Peak Gain
1	Cortec	AN0727-64DP5BSM	Dipole Antenna	0.28 dBi

Support Contact Information

Contact Support: <http://bectechnologies.net/support/>.

Telephone: +1 972 422 0877

TABLE OF CONTENTS

COPYRIGHT NOTICE	1
ANTENNA LIST	1
SUPPORT CONTACT INFORMATION	1
CHAPTER 1: INTRODUCTION	1
INTRODUCTION TO YOUR ROUTER	1
FEATURES & SPECIFICATIONS	2
HARDWARE SPECIFICATIONS	4
APPLICATION DIAGRAMS	4
CHAPTER 2: PRODUCT OVERVIEW	5
IMPORTANT NOTE FOR USING THIS ROUTER	5
PACKAGE CONTENTS	5
DEVICE DESCRIPTION	6
SYSTEM RECOVERY PROCEDURES	9
CABLING	9
CHAPTER 3: BASIC INSTALLATION	10
NETWORK CONFIGURATION – IPV4	11
Configuring PC in Windows 10 (IPv4)	11
Configuring PC in Windows 7/8 (IPv4)	13
Configuring PC in Windows Vista (IPv4)	15
NETWORK CONFIGURATION – IPV6	17
Configuring PC in Windows 10 (IPv6)	17
Configuring PC in Windows 7/8 (IPv6)	19
Configuring PC in Windows Vista (IPv6)	21
DEFAULT SETTINGS	23

CHAPTER 4: DEVICE CONFIGURATION24

LOGIN TO YOUR DEVICE	24
STATUS.....	26
Device Info	26
System Status	28
System Log	28
4G/LTE Status	29
GPS Status	30
Statistics	31
DHCP Table.....	34
ARP Table	34
VRRP Status.....	34
QUICK START	35
DEVICE CONFIGURATION	38
Interface Setup.....	38
<i>Internet</i>	38
<i>LAN</i>	45
<i>Loopback</i>	49
Dual WAN.....	50
<i>General Setting</i>	50
<i>Outbound Load Balance</i>	54
<i>Protocol Binding</i>	55
Advanced Setup	57
<i>Firewall</i>	57
<i>Routing</i>	58
<i>NAT</i>	59
<i>VRRP</i>	64
<i>Static DNS</i>	65
<i>QoS</i>	66
<i>Time Schedule</i>	68
<i>Mail Alert</i>	69
<i>Serial (RS-232 Console Port)</i>	70
Access Management	74
<i>Device Management</i>	74
<i>SNMP</i>	75
<i>Syslog</i>	77
<i>Universal Plug & Play</i>	78

<i>Dynamic DNS (DDNS)</i>	79
<i>Access Control</i>	81
<i>Packet Filter</i>	83
<i>CWMP (TR-069)</i>	87
<i>Parental Control</i>	89
<i>BECentral Management</i>	90
Maintenance	91
<i>User Management</i>	91
<i>Certificate Management</i>	93
<i>Time Zone</i>	95
<i>Firmware & Configuration</i>	96
<i>System Restart</i>	97
<i>Auto Reboot</i>	98
<i>Diagnostics Tool</i>	99

CHAPTER 5: TROUBLESHOOTING 102

Problems with the Router	102
Problem with LAN Interface	102
Recovery Procedures.....	103

APPENDIX: PRODUCT SUPPORT & CONTACT 104

CHAPTER 1: INTRODUCTION

Introduction to your Router

The BEC MX-230 M1 Industrial M2M Router is a low-power wide area network (LPWAN) enabled device supporting Cat.M1 (LTE-M) technologies optimizing range and service coverage for low-cost, low-bandwidth and low-power IoT/M2M communication. The MX-230 is feature-packed NB-IoT/LTE-M router in compact and rugged designed to be deployed in any harsh environment and hard-to-reach areas.

Versatile WAN Options

The MX-230 M1 is an LTE-M/NB-IoT enabled router with dual WAN links, mobile carrier network and the wireline, for internet redundancy. One of the LAN ports is an interchangeable Gigabit Ethernet LAN/WAN added for much of bandwidth when needed.

Ultra-Compact and Lightweight Design

Designed for continuous operation in harsh environments, the MX-230 M1 supports an extended operating temperature range from -4 to 140° F (-20 to 60° C) and a flexible input voltage range of 9-56V DC making it suitable for diverse environments and applications. To enable simple, reliable and efficient integration the ultra-compact, lightweight and low-profile design incorporates highly flexible mounting options to ensure that the device and can be easily mounted discretely anywhere.

IPv6 Supported

Internet Protocol version 6 (IPv6) is a version of the Internet Protocol that is designed to succeed IPv4. IPv6 has a vastly larger address space than IPv4. The router is already supporting IPv6, you can use it in IPv6 environment no need to change device. The dual-stack protocol implementation in an operating system is a fundamental IPv4-to-IPv6 transition technology. It implements IPv4 and IPv6 protocol stacks either independently or in a hybrid form. The hybrid form is commonly implemented in modern operating systems supporting IPv6.

Quick Start Wizard

Support a WEB GUI page to install this device quickly. With this wizard, simple steps will get you connected to the Internet immediately.

Firmware Upgradeable

Device can be upgraded to the latest firmware through the WEB based GUI.

Features & Specifications

- 4G/LTE and/or Ethernet IP broadband connectivity
- Gigabit Ethernet WAN (GbE WAN) for Cable/Fiber/xDSL high WAN throughput
- Gigabit Ethernet LAN
- IPv6 ready (IPv4/IPv6 dual stack)
- Firewall Security with DoS Preventing and Packet Filtering
- Quality of Service Control for traffic prioritization management
- Universal Plug and Play (UPnP) Compliance
- Ease of Use with Quick Installation Wizard
- Small form factor with multiple mounting options, easily installed by a single person
- Hardened enclosure with Industrial-graded components

Availability and Resilience

- Dual-WAN Interfaces
- High performance external antennas

Network Protocols and Features

- IPv4, IPv6, IPv4 / IPv6 dual stack
- IP Tunnel IPv6 in IPv4 (6RD)
- IP Tunnel IPv4 in IPv6 (DS-Lite)
- NAT, static routing and RIP-1/2
- Universal Plug and Play (UPnP) compliant
- Dynamic Domain Name System (DDNS)
- Virtual server and DMZ
- SNTP, DNS relay
- IGMP proxy and IGMP snooping
- MLD proxy and MLD snooping
- Supports port-based Virtual LAN (VLAN)

Firewall

- Built-in NAT Firewall
- Stateful Packet Inspection (SPI)
- DoS attack prevention including Land Attack, Ping of Death, etc.

- Access control
- IP&MAC filter, URL Content Filter
- Password protection for system management
- VPN pass-through

Quality of Service Control

- Traffic prioritization management based-on Protocol, Port Number and IP Address (IPv4/ IPv6)

Management

- Quick Installation wizard
- Web-based GUI for remote and local management (IPv4/IPv6)
- Firmware upgrades and configuration data upload and download via web-based GUI
- Supports DHCP server / client / relay
- Supports SNMP
- TR-069 supports remote management
- BECentral Cloud Management

Hardware Specifications

Physical interface

- 4G/LTE: One (1) SMA Female Connector
- GPS: One (1) SMA Female Connector
- WAN: Cellular 4G/LTE and/or ETH WAN
- RS-232 (DCE, DB-9): One (1) Port
- Ethernet LAN: 2-port 10/100/1000Mbps, auto-crossover (MDI/ MDI-X) switch
- SIM Card: One (1) Slot
- Reset Button
- Power Connector: 4-pin Connectors
- LED Indicators: Power / Internet / LTE / Ethernet

Physical Specifications

- Dimensions (W*H*D): 4.29" x 1.17" x 3.43" (109mm x 29.7mm x 87mm)

Application Diagrams

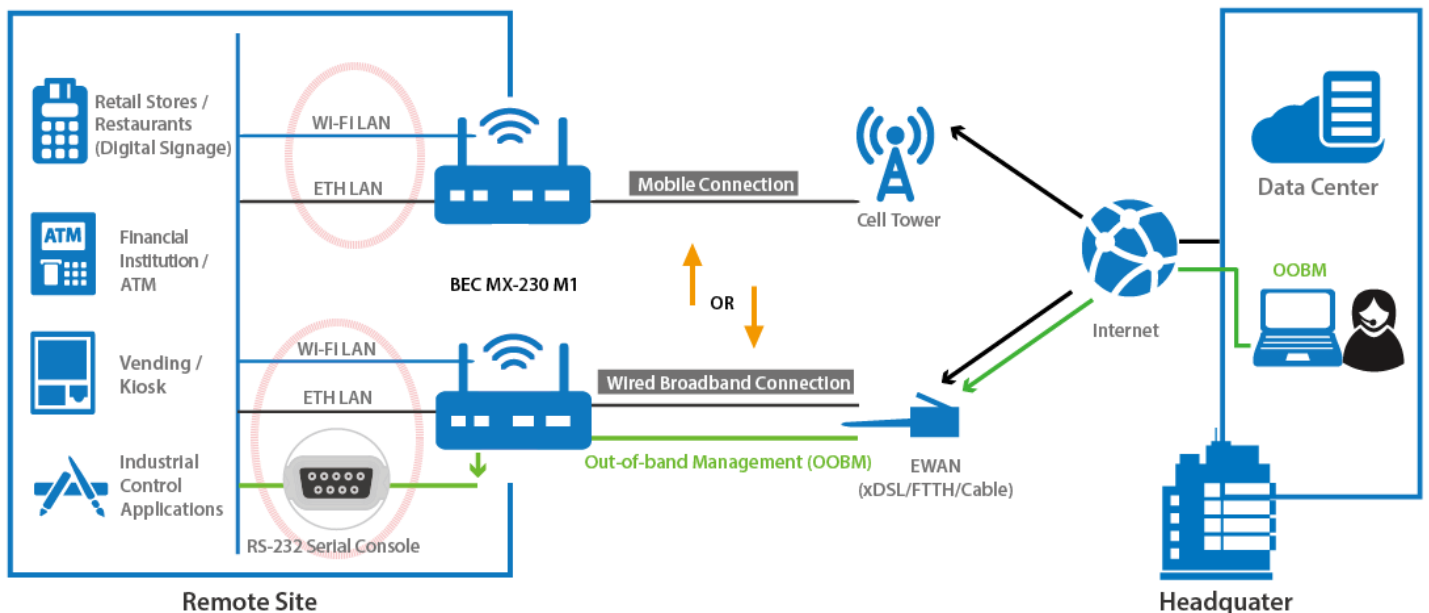

CHAPTER 2: PRODUCT OVERVIEW

Important Note for Using This Router



Warning

- ✓ Do not use the router in high humidity or high temperature.
- ✓ Do not use the same power source for the MX-230 M1 on other equipment.
- ✓ Do not open or repair the case yourself. If the device becomes too hot, turn off the power immediately and have it repaired at a qualified service center.
- ✓ Avoid using this product and all accessories outdoors.



Attention

- ✓ Place the router on a stable surface.
- ✓ Only use the power adapter that comes with the package. Using a different voltage rating power adaptor may damage the router.

Package Contents

- | | |
|---|--------------------------|
| ✓ BEC MX-230 M1* 1 | (Optional Accessories) |
| ✓ Quick Installation Guide * 1 | ✓ 3G/4G Antennas |
| ✓ DIN Rail Mounting Kit * 1 | ✓ Active GPS Antenna |
| ✓ Power Terminal Block 2-pin 3.5mm * 1 | ✓ Ethernet (RJ-45) Cable |
| ✓ Power Converter with 2-pin Terminal Block * 1 | |
| ✓ DC Power Adapter, 12V 1.2A* 1 | |

Device Description

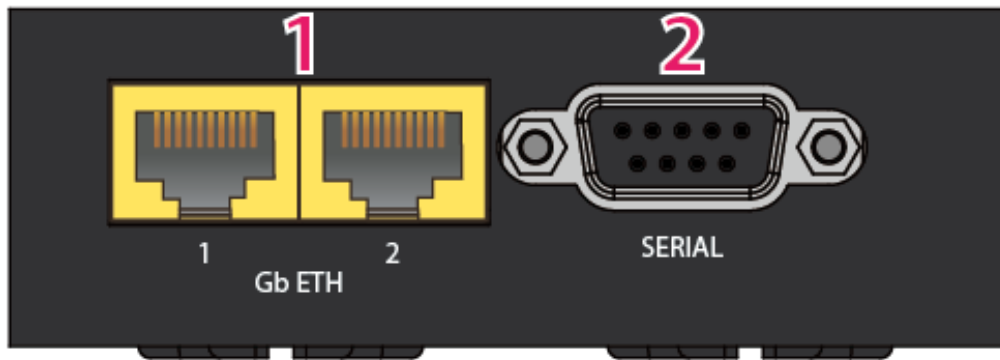

INTERFACE		MEANING
1	Gigabit Ethernet (LAN 1 / EWAN)	<p>ETH1 is a LAN / WAN configurable port for broadband connectivity</p> <p>Connect PCs, Laptops or any other office/home LAN devices with the supplied RJ-45 Ethernet cable (Cat-5 or Cat-5e) to any of those two LAN ports.</p>
	Gigabit Ethernet (LAN 2)	<p>Connect PCs, Laptops or any other office/home LAN devices with the supplied RJ-45 Ethernet cable (Cat-5 or Cat-5e) to any of those two LAN ports. .</p>
2	SERIAL	<p>RS-232 serial port for machine connection and data collection</p> <p>Connect the male end of RS-232 serial data cable to the MX-230 M1 and the other end to a machine or PC.</p>

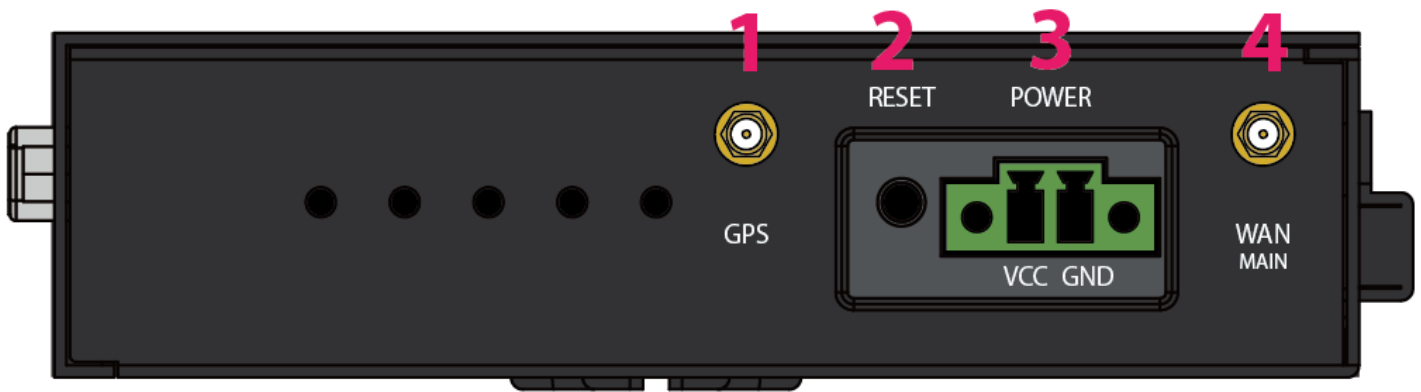

INTERFACE		MEANING
1	GPS Antenna Connector	SMA female connectors. Manually screw the GPS antenna tight to the connector
2	RESET	After the device is powered on, press it 6 seconds or above : to restore to factory default settings (this is used when you cannot login to the router, e.g. forgot your password)
3	POWER	Attach the power terminal block, 2-pin 3.5mm, or the power converter with 2-pin terminal block here. VCC (Left Connector): Power - Red Wire to connect to the Positive (+) terminal of the power supply. GND (Right Connector): Ground – Black Wire to connect to the ground of the power supply
1	WAN (MAIN/AUX) 4G/LTE Antenna Connectors	SMA female connectors. Manually screw the 3G/4G antennas tight to the female connectors for the Cellular Module

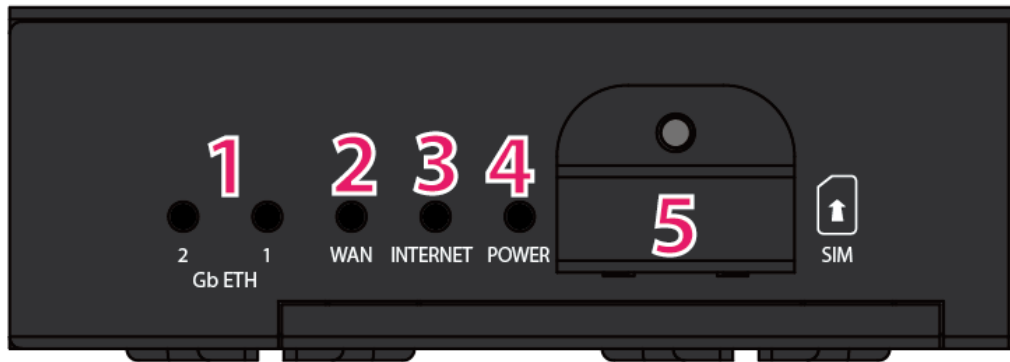

LEDS / INTERFACE		MEANING	
1	Gb ETH (1 & 2) (Gigabit Ethernet)	ETH #1 Can be configured to be WAN port for broadband connectivity	
		Green	Ethernet LAN: Connected to a Gigabit (1000Mbps) Ethernet device Ethernet WAN (ETH1 Only): Successfully connected with a broadband connection device
		Red	Transmission speed is at 10/100Mbps
		Blinking	Data being transmitted/received
		Off	No device is connected to the Ethernet port
2	LTE (Received Signal Strength Indicator)	Green	RSSI greater than -69 dBm. Excellent signal condition
		Green / Fast Flashing	RSSI from -81 to -69 dBm. Good signal condition
		Red / Fast Flashing	RSSI from -99 to -81 dBm. Fair signal condition
		Red / Slow Flashing	RSSI less than -99 dBm. Poor signal condition
		Red	No signal and the 4G LTE module is in service
		Off	No LTE module or LTE module fails
3	Internet	Green	IP connected, and traffic is passing through the device
		Red	IP request failed
		Off	Either in bridged mode or WAN connection is not present
4	Power	Green	System ready
		Red	Boot failure
5	SIM Card Slot	N/A 	Insert mini SIM card (2FF) with the gold contact facing down. Push mini SIM card (2FF) inwards to eject it * Power off the MX-230 M1 before inserting or removing the SIM card

System Recovery Procedures

The purpose is to allow users to restore the MX-230 M1 to its initial stage when the device is outage, upgraded to a wrong / broken firmware, cannot access to the GUI with wrong username and/or password, etc.

Step 1 – Configure your PC Network IP Address

Before performing the system recovery, assign this IP address and Netmask to your PC, **192.168.1.100** and **255.255.255.0** respectively.

Step 2 – Reset your MX-230 M1 Device

- 2.1 Power off your MX-230 M1
- 2.2 Power on the MX-230 M1 while pushing the RESET button with a small pointed object (such as paper clip, needle, toothpick, and etc.).
- 2.3 When the POWER LED turns RED, keep holding and pushing the RESET button until the INTERNET LED flashes in GREEN

Step 3 – Restore your MX-230 M1 Device

With INTERNET light flashes green, MX-230 M1 is in recovery mode and ready for a new Firmware.

- 3.1 Open a web browser and type the IP address, **192.168.1.1**, to access to the recovery page.

NOTE: In the recovery mode, MX-230 M1 will not respond to any PING or other requests.

- 3.2 Browse to the new Firmware image file then click Upload to start the upgrade process.

- 3.3 INTERNET LED turns red means the Firmware upgrade is in process.

DO NOT power off or reboot the device, it would permanently damage your MX-230 M1.

- 3.4 INTERNET LED turns green after the Firmware upgrade completed

- 3.5 Power cycle on & off to regain access to the MX-230 M1.

Cabling

One of the most common causes of problems is bad cabling. Make sure that all connected devices are turned on. On the front panel of the product is a bank of LEDs. Verify that the LAN Link and LEDs are lit. If they are not, verify that you are using the proper cables.

CHAPTER 3: BASIC INSTALLATION

The router can be configured with your web browser. A web browser is included as a standard application in the following operating systems: Windows Vista / 7 / 8, Linux, Mac OS, etc. The product provides an easy and user-friendly interface for configuration.

PCs must have an Ethernet interface installed properly and be connected to the router either directly or through an external repeater hub and have TCP/IP installed or configured to obtain an IP address through a DHCP server or a fixed IP address that must be in the same subnet as the router. The default IP address of the router is **192.168.1.254** and the subnet mask is **255.255.255.0** (i.e. any attached PC must be in the same subnet and have an IP address in the range of 192.168.1.1 to 192.168.1.253). The best and easiest way is to configure the PC to get an IP address automatically from the router using DHCP. If you encounter any problems accessing the router's web interface it may also be advisable to **uninstall** any kind of software firewall on your PCs, as they can cause problems accessing the 192.168.1.254 IP address of the router. Users should make their own decisions on how to best protect their network.

Please follow the steps below for your PC's network environment installation. First of all, please check your PC's network components. The TCP/IP protocol stack and Ethernet network adapter must be installed. If not, please refer to your Windows-related or other operating system manuals.





Attention

Any TCP/IP capable workstation can be used to communicate with or through the MX-230 M1. To configure other types of workstations, please consult the manufacturer's documentation.

Network Configuration – IPv4

Configuring PC in Windows 10 (IPv4)

1. Click .
2. Click  Settings
3. Then click on **Network and Internet**.

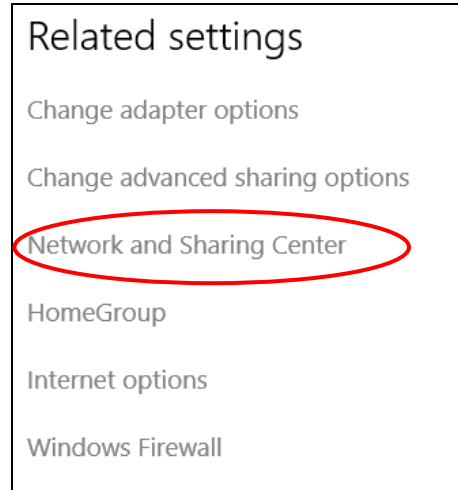
4. Under **Related settings**, select **Network and Sharing Center**

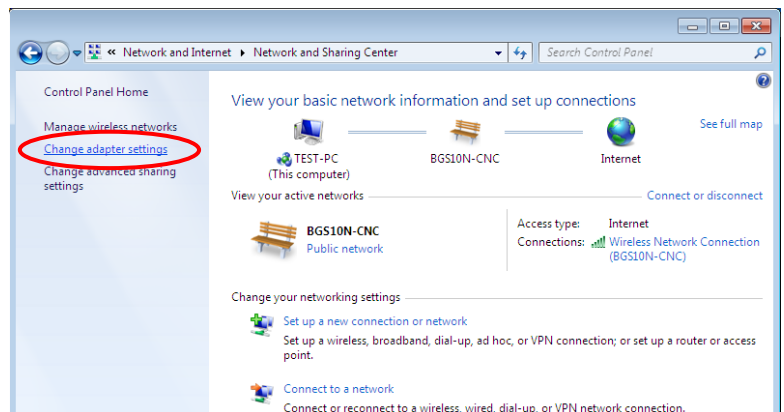

5. When the **Network and Sharing Center** window pops up, select and click on **Change adapter settings** on the left window panel.

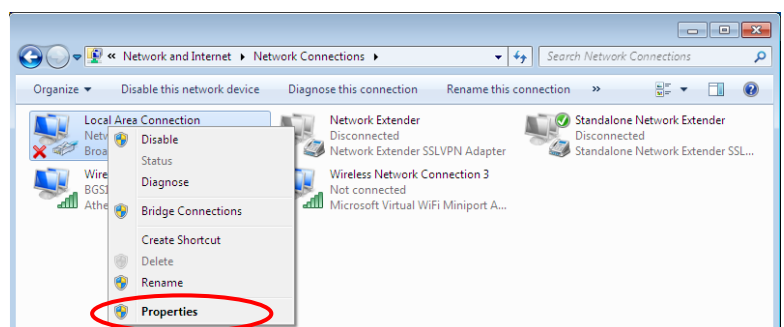

6. Select the **Local Area Connection**, and right click the icon to select **Properties**.



- 7. Select **Internet Protocol Version 4 (TCP/IPv4)** then click **Properties**.

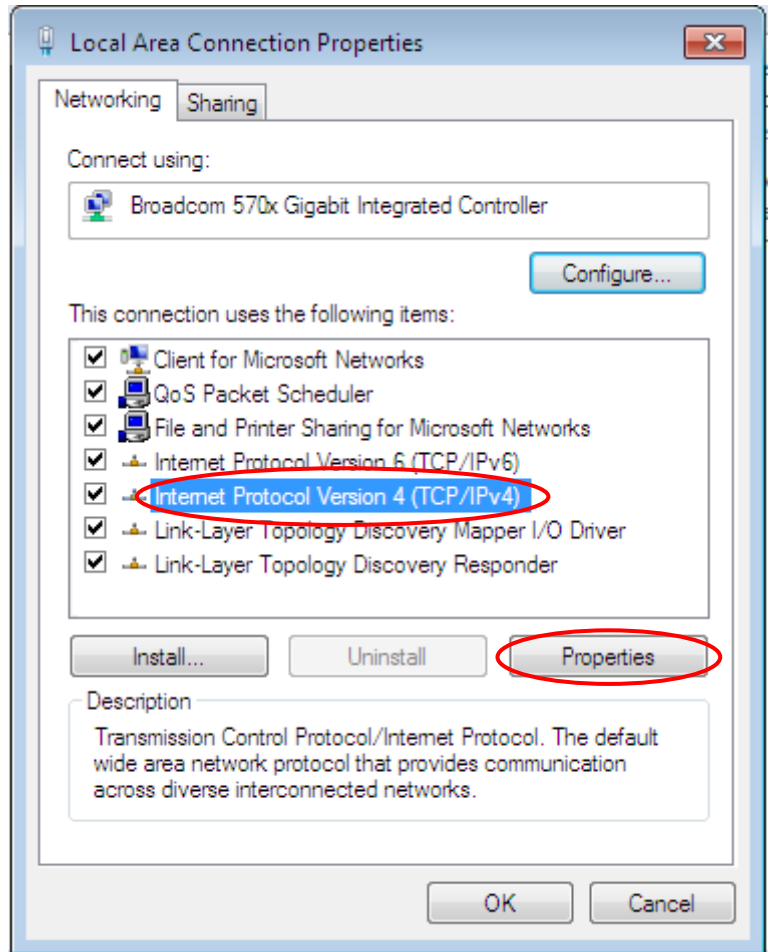

- 8. In the **TCP/IPv4 properties** window, select the **Obtain an IP address automatically** and **Obtain DNS Server address automatically** radio buttons. Then click **OK** to exit the setting.

- 9. Click **OK** again in the **Local Area Connection Properties** window to apply the new configuration.

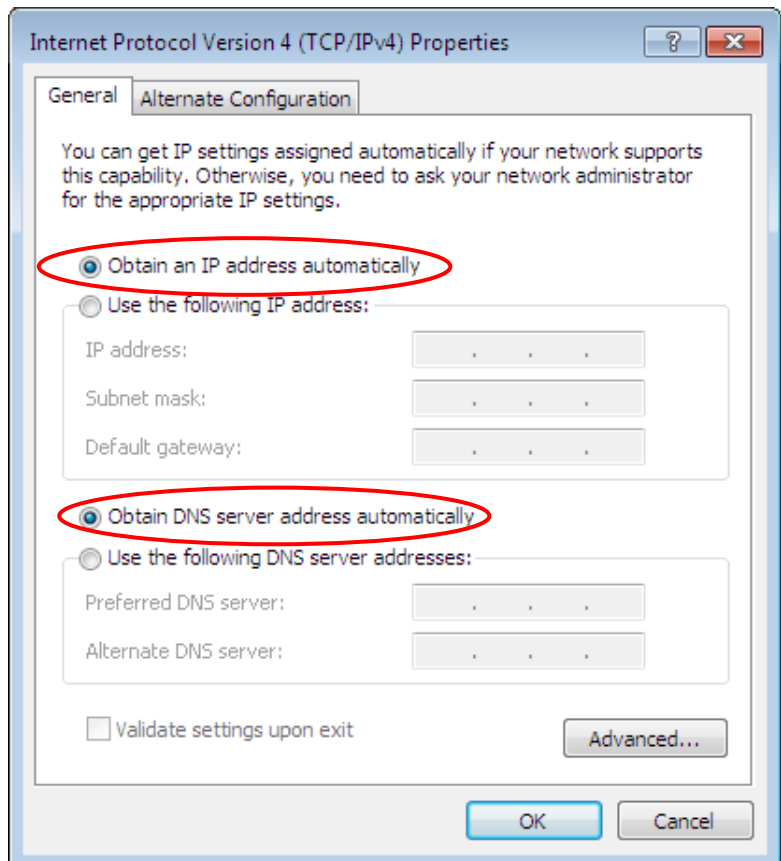

Configuring PC in Windows 7/8 (IPv4)

1. Go to **Start**. Click on **Control Panel**.
2. Then click on **Network and Internet**.

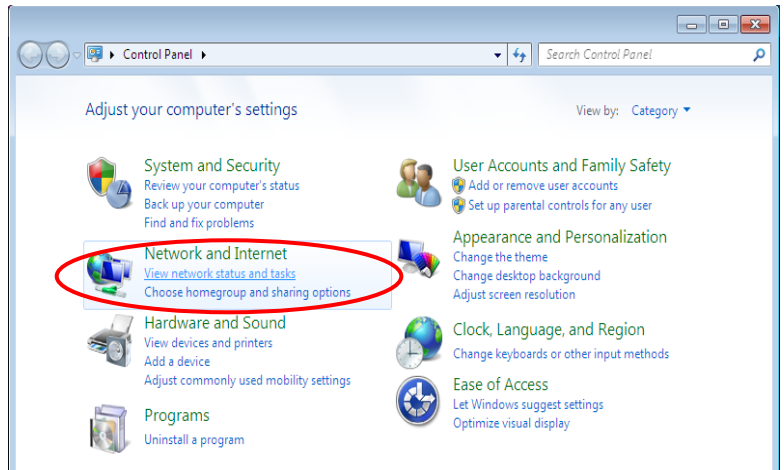

3. When the **Network and Sharing Center** window pops up, select and click on **Change adapter settings** on the left window panel.

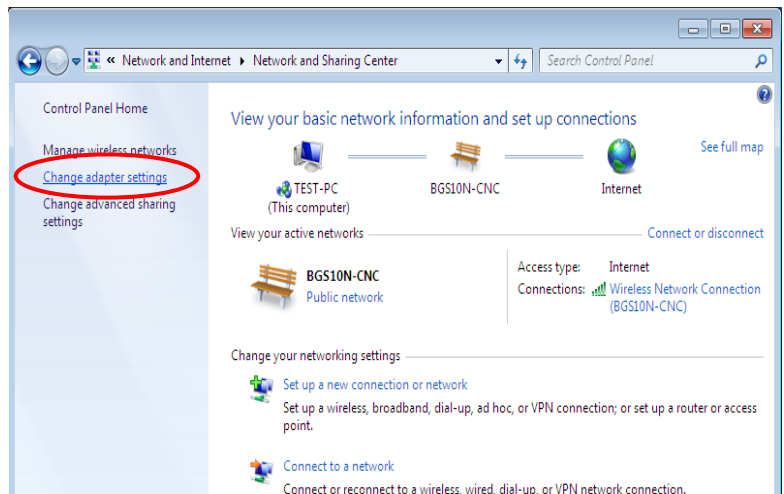

4. Select the **Local Area Connection**, and right click the icon to select **Properties**.

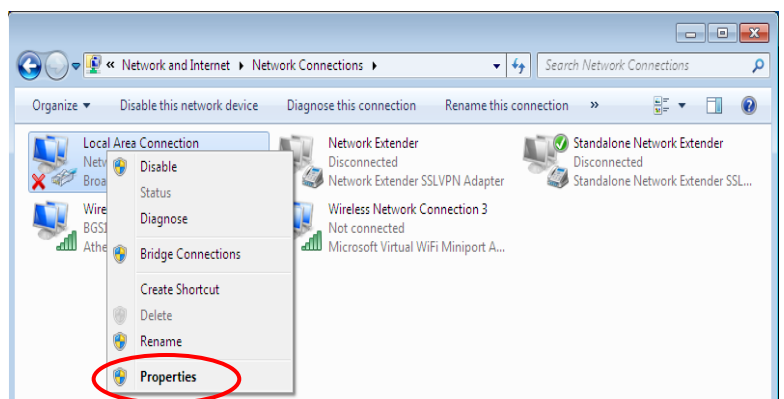

5. Select **Internet Protocol Version 4 (TCP/IPv4)** then click **Properties**.

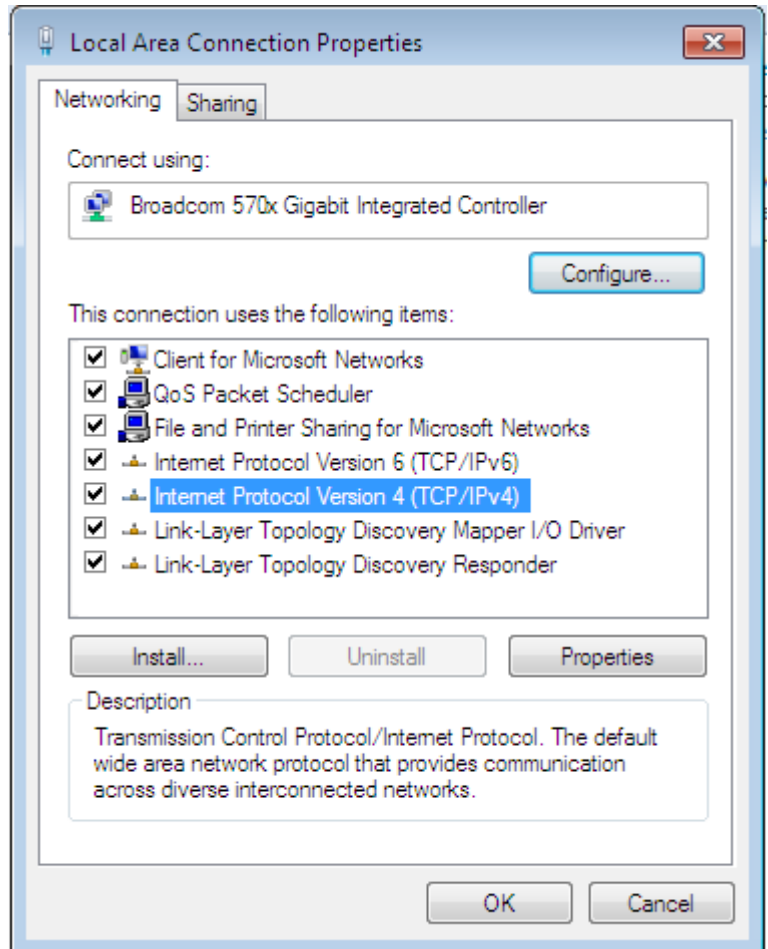

6. In the **TCP/IPv4 properties** window, select the **Obtain an IP address automatically** and **Obtain DNS Server address automatically** radio buttons. Then click **OK** to exit the setting.
7. Click **OK** again in the **Local Area Connection Properties** window to apply the new configuration.

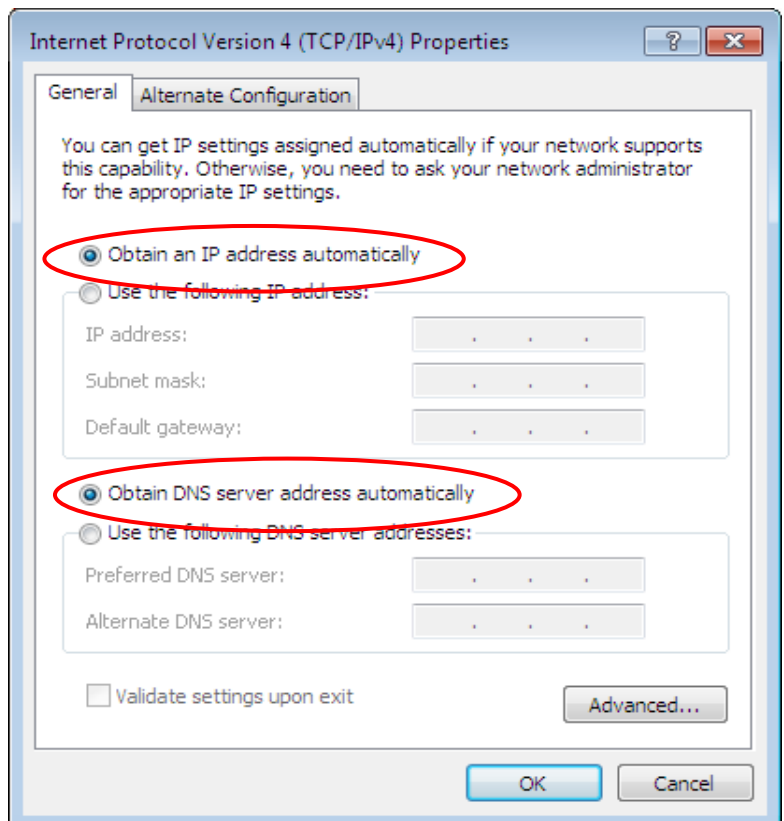

Configuring PC in Windows Vista (IPv4)

1. Go to **Start**. Click on **Network**.
2. Then click on **Network and Sharing Center** at the top bar.

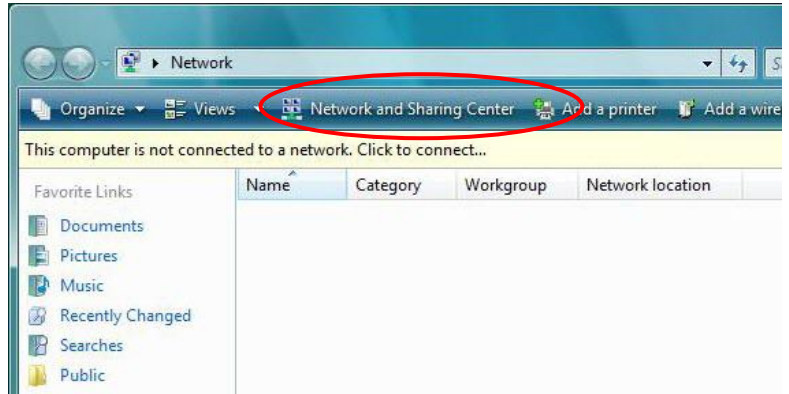

3. When the **Network and Sharing Center** window pops up, select and click on **Manage network connections** on the left window pane.



4. Select the **Local Area Connection**, and right click the icon to select **Properties**.

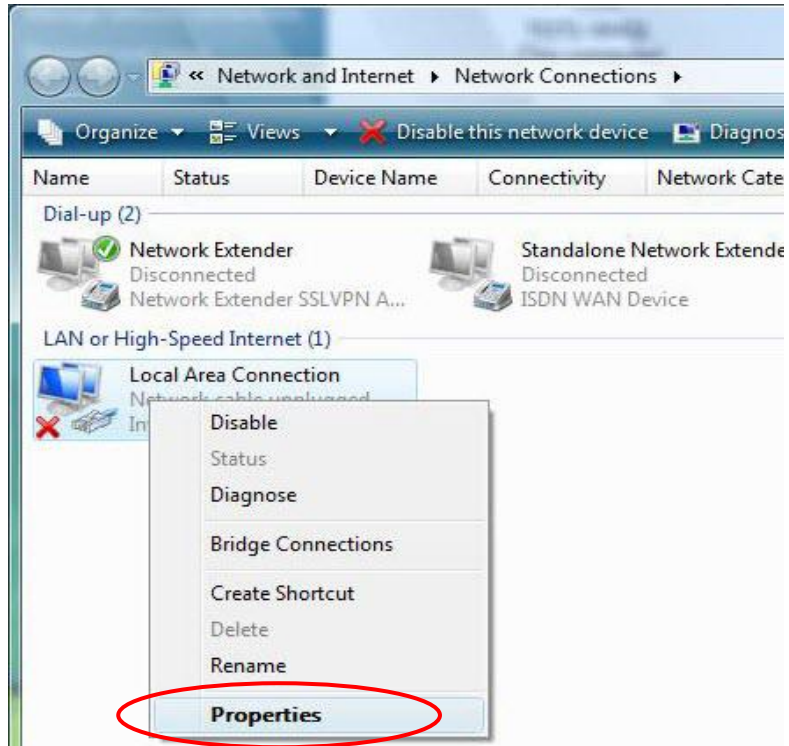

5. Select **Internet Protocol Version 4 (TCP/IPv4)** then click **Properties**.

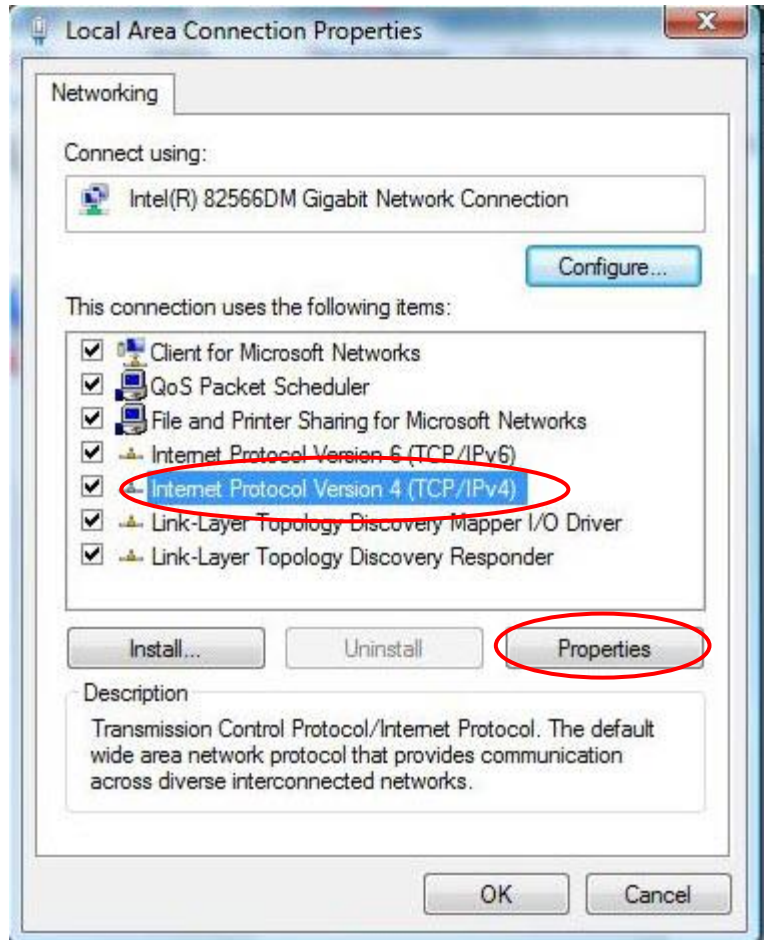

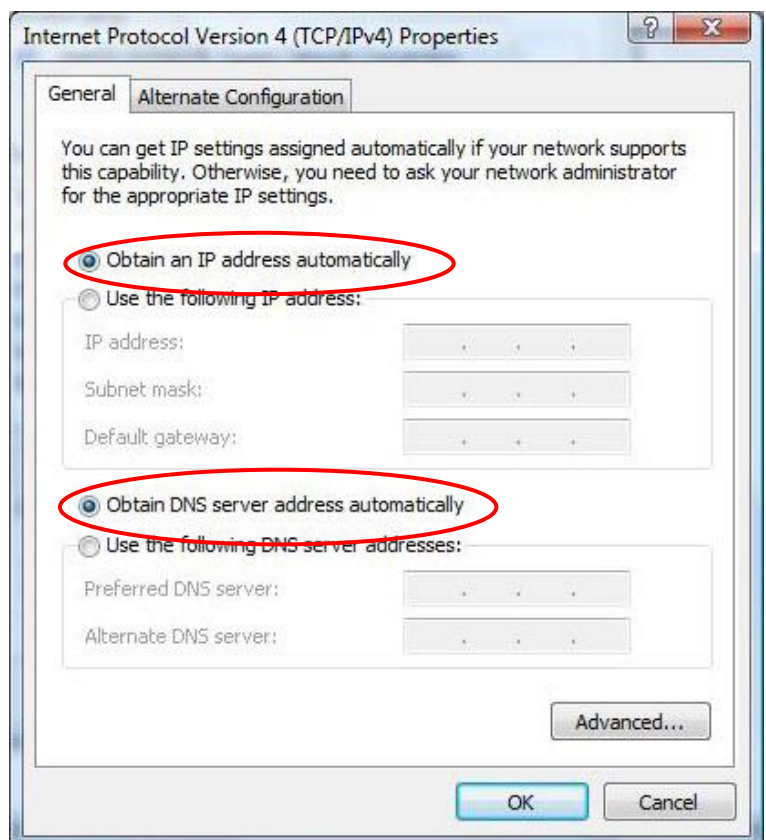

6. In the **TCP/IPv4 properties** window, select the **Obtain an IP address automatically** and **Obtain DNS Server address automatically** radio buttons. Then click **OK** to exit the setting.
7. Click **OK** again in the **Local Area Connection Properties** window to apply the new configuration.



Network Configuration – IPv6

Configuring PC in Windows 10 (IPv6)

1. Click .
2. Click .
3. Then click on **Network and Internet**. 
4. Under **Related settings**, select **Network and Sharing Center**

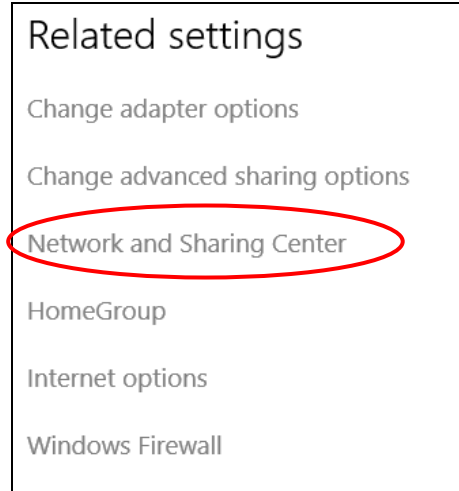

5. When the **Network and Sharing Center** window pops up, select and click on **Change adapter settings** on the left window panel.

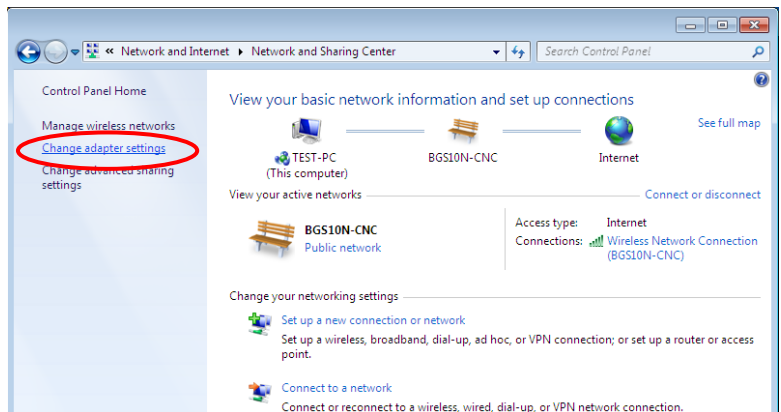

6. Select the **Local Area Connection**, and right click the icon to select **Properties**.

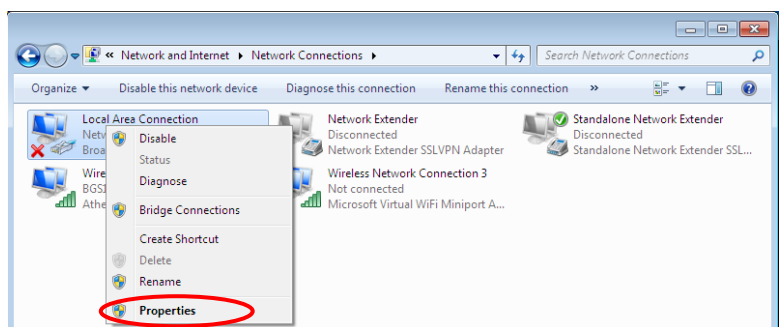

7. Select **Internet Protocol Version 6 (TCP/IPv6)** then click **Properties**.

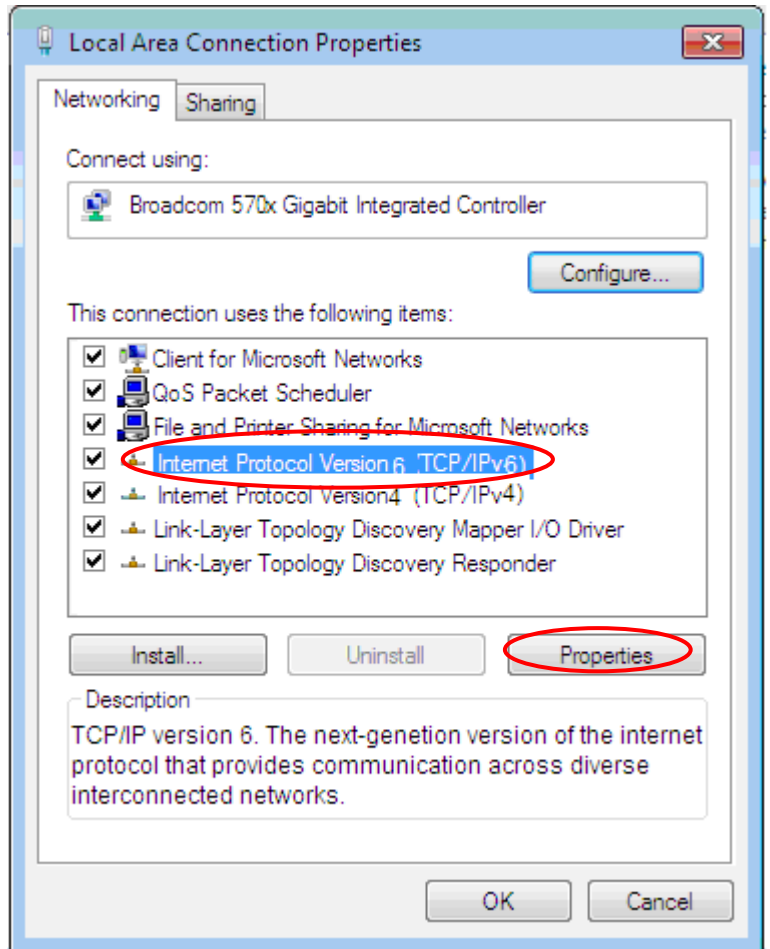

8. In the **TCP/IPv6 properties** window, select the **Obtain an IPv6 address automatically** and **Obtain DNS Server address automatically** radio buttons. Then click **OK** to exit the setting.

9. Click **OK** again in the **Local Area Connection Properties** window to apply the new configuration.

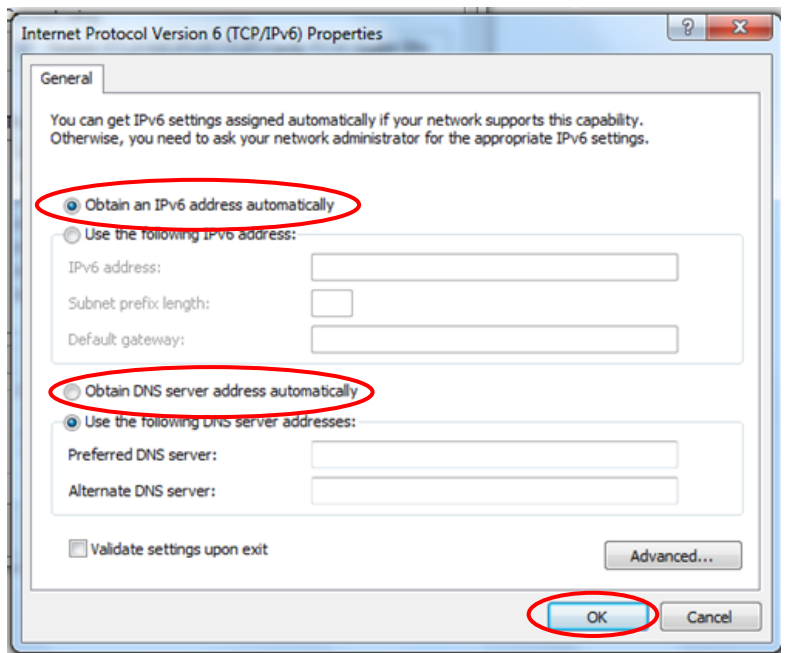

Configuring PC in Windows 7/8 (IPv6)

1. Go to **Start**. Click on **Control Panel**.
2. Then click on **Network and Internet**.

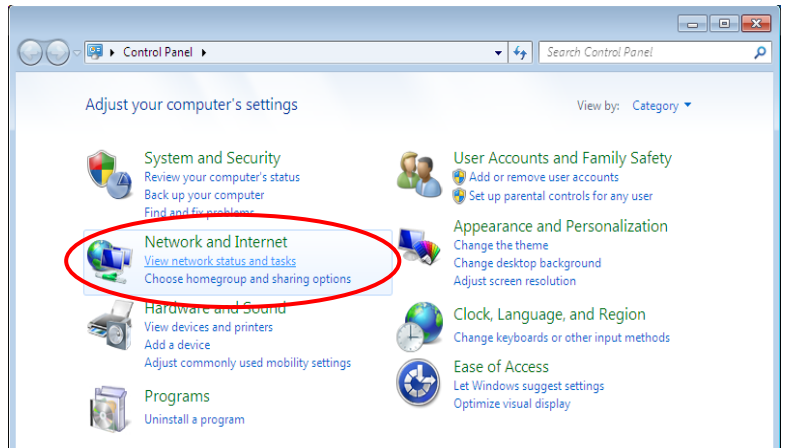

3. When the **Network and Sharing Center** window pops up, select and click on **Change adapter settings** on the left window panel.

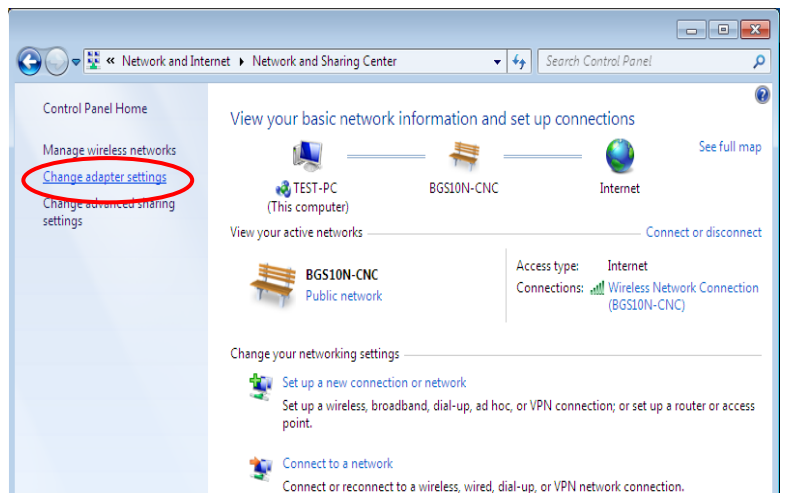

4. Select the **Local Area Connection**, and right click the icon to select **Properties**.

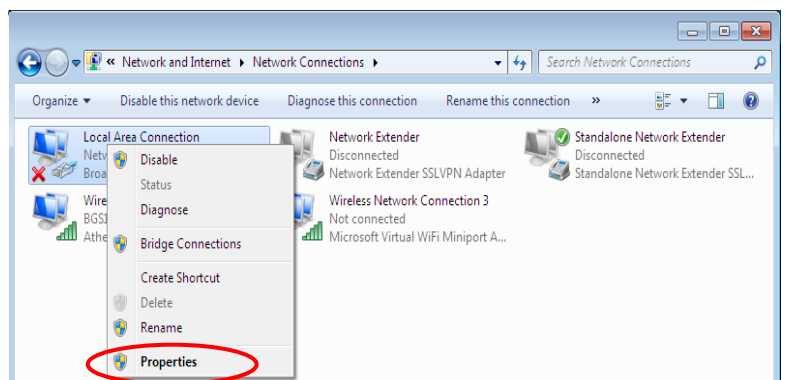

5. Select **Internet Protocol Version 6 (TCP/IPv6)** then click **Properties**.

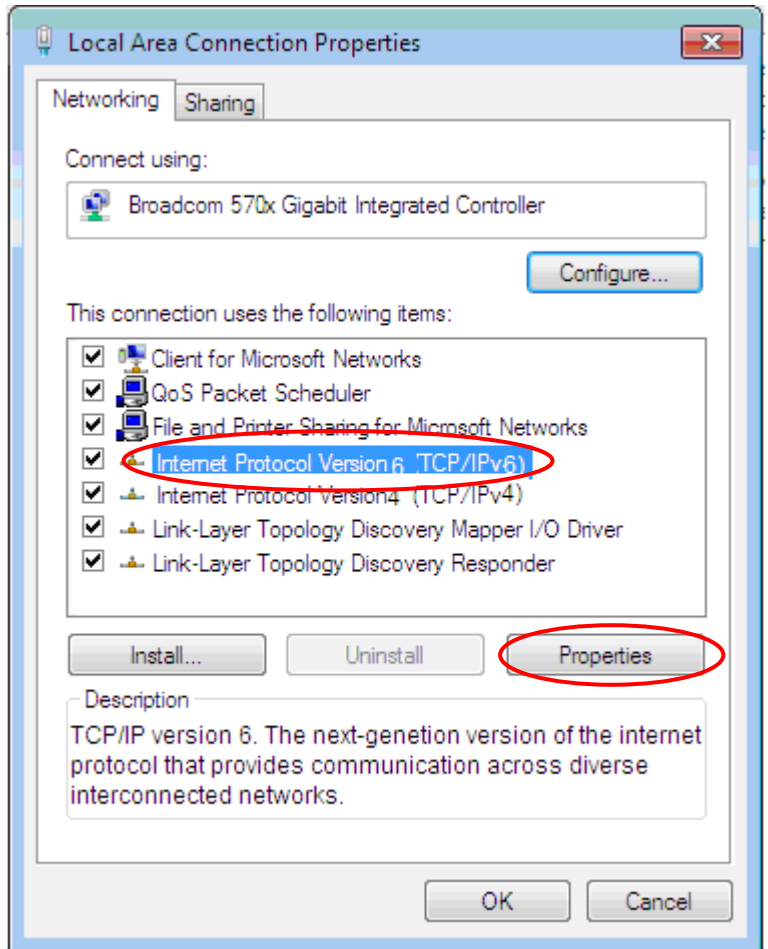

6. In the **TCP/IPv6 properties** window, select the **Obtain an IPv6 address automatically** and **Obtain DNS Server address automatically** radio buttons. Then click **OK** to exit the setting.

7. Click **OK** again in the **Local Area Connection Properties** window to apply the new configuration.

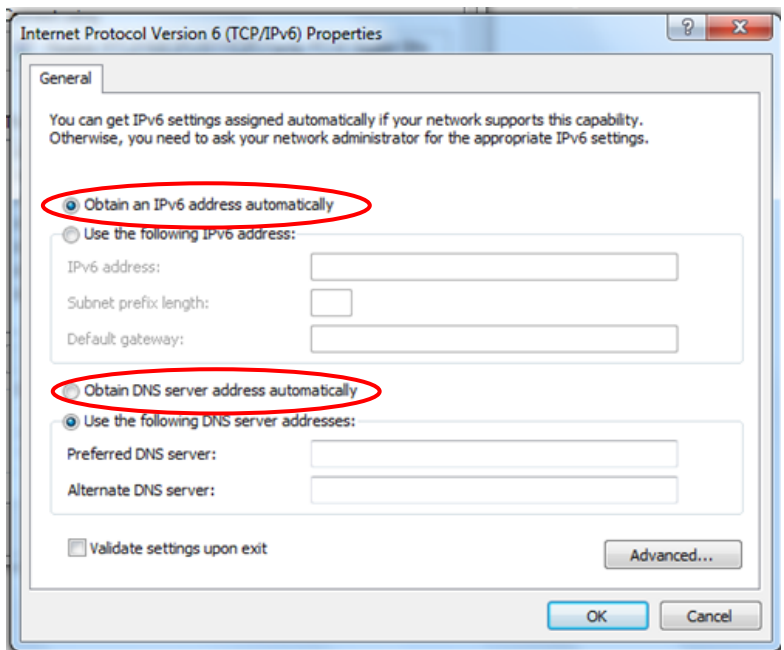

Configuring PC in Windows Vista (IPv6)

1. Go to **Start**. Click on **Network**.
2. Then click on **Network and Sharing Center** at the top bar.

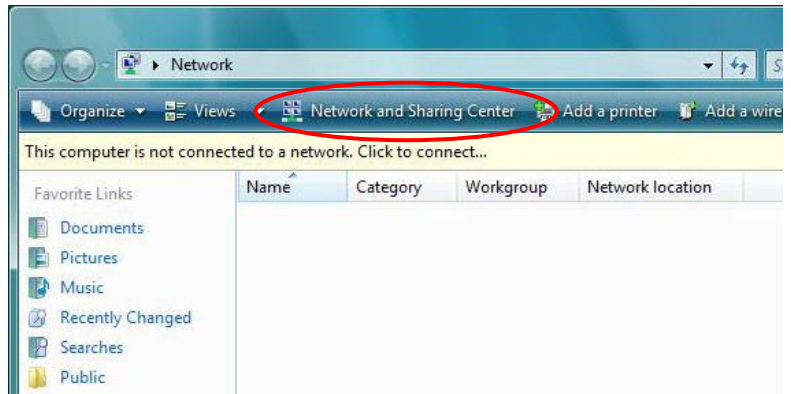

3. When the **Network and Sharing Center** window pops up, select and click on **Manage network connections** on the left window pane.



4. Select the **Local Area Connection**, and right click the icon to select **Properties**.

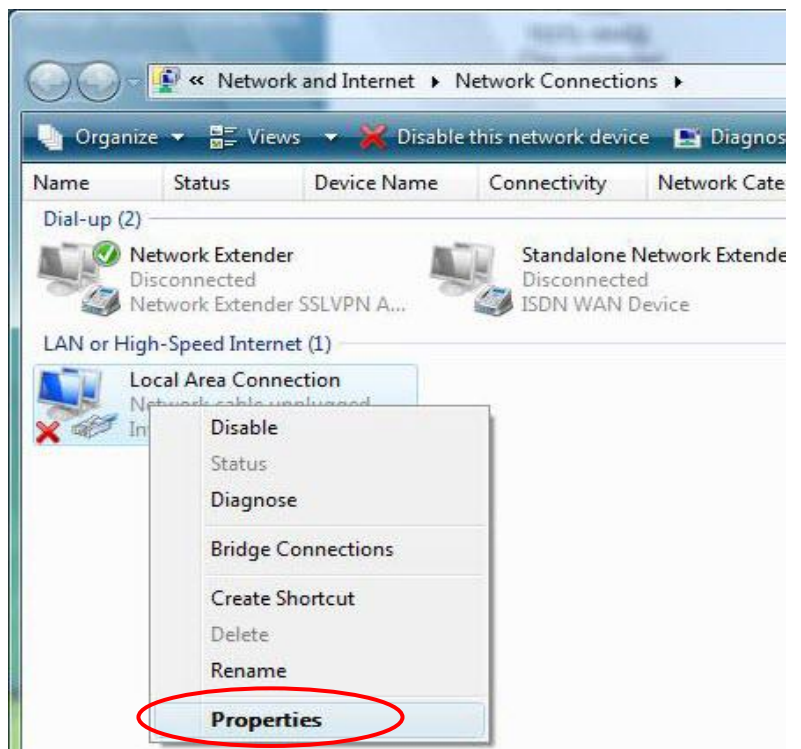

5. Select **Internet Protocol Version 6 (TCP/IPv6)** then click **Properties**.

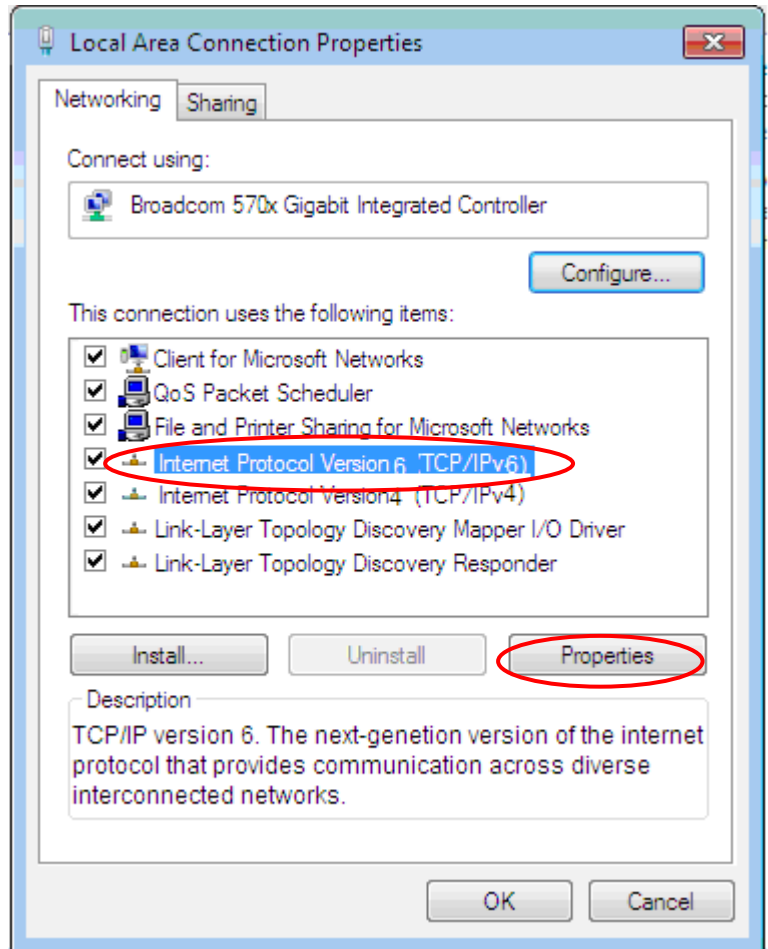

6. In the **TCP/IPv6 properties** window, select the **Obtain an IP address automatically** and **Obtain DNS Server address automatically** radio buttons. Then click **OK** to exit the setting.

7. Click **OK** again in the **Local Area Connection Properties** window to apply the new configuration.

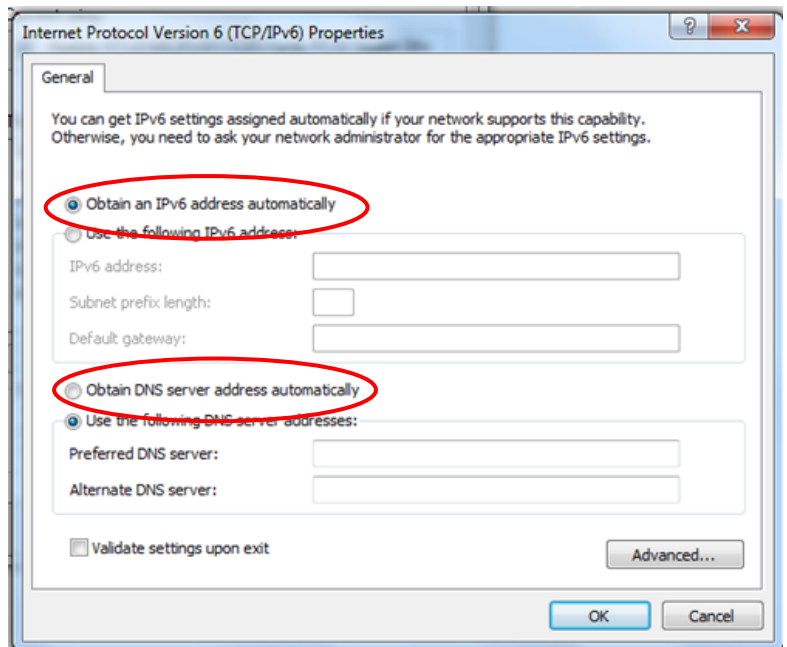

Default Settings

Before configuring the router, you need to know the following default settings.

Web Interface: (Username and Password)

Administrator

- ✓ Username: admin
- ✓ Password: admin or a unique 12-digit password can be found on the device label.

User

- ✓ Username: user
- ✓ Password: user



If you ever forget the username/password to login to the router, you may press the RESET button up to 6 seconds then release it to restore the factory default settings.

Caution: After pressing the RESET button for more than 6 seconds then release it, to be sure you power cycle the device again.

Device LAN IP Settings

- ✓ IP Address: 192.168.1.254
- ✓ Subnet Mask: 255.255.255.0

DHCP Server:

- ✓ DHCP server is enabled.
- ✓ Start IP Address: 192.168.1.100
- ✓ IP pool counts: 100

CHAPTER 4: DEVICE CONFIGURATION

Login to your Device

Open your web browser, enter the IP address of your router, which by default is **192.168.1.254**, and click **Go**, a user name and password window prompt appears.

The default username and password is **“admin”** and **“admin”** respectively for the **Administrator**. For the **User** account, default username and password is **“user”** and **“user”**.

NOTE: This username / password may vary by different Internet Service Providers.

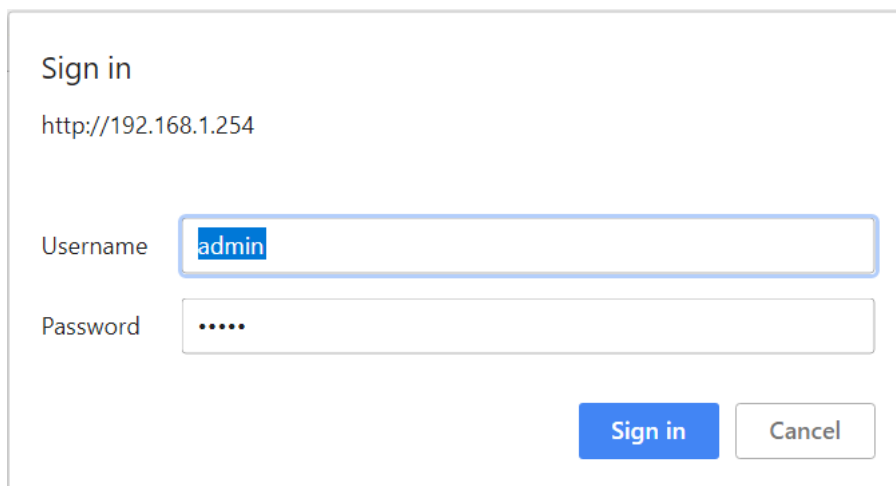

The screenshot shows a web browser's login prompt. At the top, it says "Sign in" followed by the URL "http://192.168.1.254". Below this, there are two input fields: "Username" with the text "admin" entered, and "Password" with five dots representing a masked password. At the bottom right, there are two buttons: a blue "Sign in" button and a white "Cancel" button.

Congratulations! You have successfully logged on to your MX-230 M1

Once you have logged on to your MX-230 M1 via your web browser, you can begin to set it up according to your requirements. On the configuration homepage, the left navigation pane links you directly to the setup pages, which includes:

Section	Status	Quick Start (Wizard Setup)	Configuration
Sub-Items	Device Info		Interface Setup <ul style="list-style-type: none"> - Internet - LAN - Loopback
	System Status		Dual WAN <ul style="list-style-type: none"> - General Setting - Outbound Load Balance - Protocol Binding
	System Log		
	4G/LTE Status		Advanced Setup <ul style="list-style-type: none"> - Firewall - Routing - NAT - VRRP - Static DNS - QoS - Time Schedule - Mail Alert - Serial Port
	GPS Status		
	Statistics		
	DHCP Table		
	ARP Table		Access Management <ul style="list-style-type: none"> - Device Management - SNMP - Syslog - Universal Plug & Play - Dynamic DNS - Access Control - Packet Filter - CWMP (TR-069) - Parental Control - BECentral Management
	VRRP Status		Maintenance <ul style="list-style-type: none"> - User Management - Certified Management - Time Zone - Firmware & Configuration - System Restart - Auto Reboot - Diagnostic Tool

Please see the relevant sections of this manual for detailed instructions on how to configure your **MX-230 M1** device.

Status

Device Info

It provides brief status summary of the device.

Device Information		Physical Port Status	
Model Name	MX-230 M1	4G/LTE	✗
Firmware Version	1.04.1.275	EWAN(LAN1)	✗
MAC Address	00:04:ed:98:76:54	Ethernet	✓
Date-Time	Mon Apr 10 03:25:05 2017		
System Up Time	3 hours 25 mins		

WAN				
Interface	Protocol	Connection	IP Address	Default Gateway
4G/LTE	Dynamic IP	Not Connected	/	

LAN		
IP Address	Subnet Mask/Prefix Length	DHCP Server
192.168.1.254	255.255.255.0	Enable / 192.168.1.100~192.168.1.199 Enable / Stateless

Device Information

Model Name: Name of the router for identification purpose.

Firmware Version: Software version currently loaded in the router

MAC Address: A unique number that identifies the router

Data Time: Setup correct time on the **MX-230 M1** with your PC. Check on [Time Zone](#) section for more configuration information.

System Uptime: Display how long the **MX-230 M1** has been powered on.

Physical Port Status

Physical Port Status : Display available connection interfaces, WAN (3G/4G-LTE, EWAN) and LAN (Ethernet) are supported in the MX-230 M1.

WAN

Interface: List current available WAN connections.

Protocol: Display selected WAN connection protocol

Connection: The current connection status.

IP Address: WAN port IP address.

Default Gateway: The IP address of the default gateway.

LAN

IP Address: LAN port IPv4 address.

Subnet Mask/Prefix Length: Display LAN port IP subnet mask of IPv4 and/or Prefix length of IPv6.

DHCP Server: Display LAN DHCP status of IPv4 and IPv6.

- ▶ **Enable / 192.168.1.100~199:** DHCPv4 server status on or off / DHCP IP range
- ▶ **Enable / Stateless:** DHCPv6 server status on or off / DHCPv6 server Type

System Status

Display device CPU and memory usage information

System Status	
CPU	
Usage	1%
Memory	
Total	60520 kB
Free	32196 kB
Cached	9948 kB
<input type="button" value="Refresh"/>	

CPU

Usage: Display the amount of CPU's processing capacity is being used in percentage (%). Higher the % rate may result in slow Internet loading, experiencing video lags, etc. To reduce high CPU consumption by resetting the device, power off and on, an easiest way to regain the service.

Memory

Total / Free / Cached (in Kbyte): Display the memory consumptions in kilobytes (kB).

Refresh: Click to update the information

System Log

In system log, you can check the operations status and any glitches to the router.

System Log	
<pre> Jan 1 00:00:31 syslogd started: BusyBox v1.00 (2015.12.28-02:11+0000) Jan 1 00:00:33 pptpd[1492]: MGR: Manager process started Jan 1 00:00:33 pptpd[1492]: MGR: Maximum of 100 connections available Jan 1 00:00:39 PPOELOGIN: bind service port Jan 1 00:00:39 PPOELOGIN: begin service loop Jan 1 00:00:39 syslog: [Hardware monitor]: START Jan 1 00:03:54 WEB: WEB user <admin> login </pre>	
<input type="button" value="Refresh"/> <input type="button" value="Backup"/>	

Refresh: Press this button to refresh the statistics.

Backup: Press to save the System log, log.cfg, to your computer / notebook.

4G/LTE Status

It contains 4G/LTE connection information.

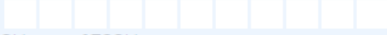
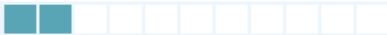
4G/LTE Status	
Status	Up
Signal Strength	 -62.00dbm
Signal Information	RSRP:-92.50 , RSRQ:-13.80 , SINR:11.90
Network Name	"Chunghwa Telecom"
Cell ID	81023501
Card IMEI	
Card IMSI	
Network Mode	LTE
Network Band	B3
Usage Allowance	
Amount used	 0Hours of 720Hours
Billing period	 Day:6
<input type="button" value="Clean"/> <input type="button" value="Save"/>	
<input type="button" value="Refresh"/>	

Status: The current status of the 3G/4G-LTE connection.

Signal Strength: The signal strength bar and dBm value indicates the current 3G/4G-LTE signal strength. The front panel 3G/4G-LTE Signal Strength LED indicates the signal strength as well.

Network Name: The name of the LTE network that the router is connecting to.



Cell ID: The ID of base station that the device is connected to.

Card IMEI: The unique identification number that is used to identify the 3G/4G-LTE module.

Card IMSI: The international mobile subscriber identity used to uniquely identify the 3G/4G-LTE module.

Network Mode / Band: Show the using network mode and LTE band.

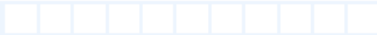
Usage Allowance

Usage Allowance	
Amount used	 0Hours of 720Hours
Billing period	 Day:15
<input type="button" value="Clean"/> <input type="button" value="Save"/>	

Amount Used: Display the amount of mobile data used and remaining in current billing cycle.

Billing Cycle: Display the start date and number of days remaining in current billing cycle

Clean: Reset current saved mobile usage

Save: Click to save current mobile status to ROM

Refresh: Click to refresh the page.

GPS Status

In GPS status, you can check the UTC time, position of the router.



Statistics

❖ 4G/LTE

Take 4G/LTE as an example to describe the following connection transmission information.

▼ Statistics			
Traffic Statistics			
Interface	<input checked="" type="radio"/> 3G/4G-LTE Status <input type="radio"/> EWAN(LAN1) <input type="radio"/> Ethernet		
Transmit Statistics		Receive Statistics	
Transmit Frames of Current Connection	0	Receive Frames of Current Connection	0
Transmit Bytes of Current Connection	0	Receive Bytes of Current Connection	0
Transmit Total Frames	0	Receive Total Frames	0
Transmit Total Bytes	0	Receive Total Bytes	0
Transmit Speed	0.00KBps	Receive Speed	0.00KBps
Refresh		Auto Refresh <input type="text" value="None"/> ▼	

Traffic Statistics

Interface: List all available network interfaces in the router. You are currently checking on the physical status of **4G/LTE** interface.

Transmit Statistics

Transmit Frames of Current Connection: Display the total number of 3G/4G/LTE frames transmitted until the latest second for the current connection.

Transmit Bytes of Current Connection: Display the total bytes transmitted till the latest second for the current connection for the current connection.

Transmit Total Frames: Display the total number of frames transmitted till the latest second since system is up.

Transmit Total Bytes: Display the total number of bytes transmitted until the latest second since system is up.

Receive Statistics

Receive Frames of Current Connection: Display the number of frames received until the latest second for the current connection.

Receive Bytes of Current Connection: Display the total bytes received till the latest second for the current connection.

Receive Total Frames: Display the total number of frames received until the latest second since system is up.

Receive Total Bytes: Display the total frames received till the latest second since system is up.

Receive Speed: Display the data rate receives from the mobile Internet.

Refresh: Click to manually refresh the data.

Auto Refresh: Select a time interval to refresh the data automatically or none to disable the feature.

❖ EWAN (LAN1)

Statistics			
Traffic Statistics			
Interface	<input type="radio"/> 3G/4G-LTE Status <input checked="" type="radio"/> EWAN(LAN1) <input type="radio"/> Ethernet		
Transmit Statistics		Receive Statistics	
Transmit Frames	0	Receive Frames	0
Transmit Multicast Frames	0	Receive Multicast Frame	0
Transmit Total Bytes	0	Receive Total Bytes	0
Transmit Collision	0	Receive CRC Errors	0
Transmit Error Frames	0	Receive Under-size Frames	0
Traffic Speed			
Transmit Speed	0.00KBps	Receive Speed	0.00KBps
Refresh		Auto Refresh <input type="text" value="None"/>	

Traffic Statistics

Interface: List all available network interfaces in the router. You are currently checking on the physical status of the **EWAN (Ethernet LAN #1)** port.

Transmit Statistics

Transmit Frames: Display the number of frames transmitted until the latest second.

Transmit Multicast Frames: Display the number of multicast frames transmitted until the latest second.

Transmit Total Bytes: Display the number of bytes transmitted until the latest second.

Transmit Collision: Numbers of collisions have occurred on this port.

Transmit Error Frames: Display the number of error packets on this port.

Receive Statistics

Receive Frames: Display the number of frames received until the latest second.

Receive Multicast Frames: Display the number of multicast frames received until the latest second.

Receive Total Bytes: Display the number of bytes received until the latest second.

Receive CRC Errors: Display the number of error packets on this port.

Receive Under-size Frames: Display the number of under-size frames received until the latest second.

Traffic Speed

Transmit Speed: Display the data rate can be transferred to the server, the Broadband Internet Service Provider.

Receive Speed: Display the data rate receives from the Broadband Internet Service Provider.

Refresh: Click to manually refresh the data.

Auto Refresh: Select a time interval to refresh the data automatically or none to disable the feature.

❖ Ethernet

Statistics			
Traffic Statistics			
Interface	<input type="radio"/> 3G/4G-LTE Status <input type="radio"/> EWAN(LAN1) <input checked="" type="radio"/> Ethernet		
Transmit Statistics		Receive Statistics	
Transmit Frames	13329	Receive Frames	5648
Transmit Multicast Frames	11026	Receive Multicast Frame	3683
Transmit Total Bytes	1651442	Receive Total Bytes	2143243
Transmit Collision	0	Receive CRC Errors	0
Transmit Error Frames	0	Receive Under-size Frames	0
Traffic Speed			
Transmit Speed	0.02KBps	Receive Speed	0.17KBps
Refresh		Auto Refresh <input type="text" value="None"/>	

Traffic Statistics

Interface: List all available network interfaces in the router. You are currently checking on the physical status of the **Ethernet** port.

Transmit Statistics

Transmit Frames: Display the number of frames transmitted until the latest second.

Transmit Multicast Frames: Display the number of multicast frames transmitted until the latest second.

Transmit Total Bytes: Display the number of bytes transmitted until the latest second.

Transmit Collision: Numbers of collisions have occurred on this port.

Transmit Error Frames: Display the number of error packets on this port.

Receive Statistics

Receive Frames: Display the number of frames received until the latest second.

Receive Multicast Frames: Display the number of multicast frames received until the latest second.

Receive Total Bytes: Display the number of bytes received until the latest second.

Receive CRC Errors: Display the number of error packets on this port.

Receive Under-size Frames: Display the number of under-size frames received until the latest second.

Traffic Speed

Transmit Speed: Display the data rate can be transferred to the server, the LAN network.

Receive Speed: Display the data rate receives from the LAN network.

Refresh: Click to manually refresh the data.

Auto Refresh: Select a time interval to refresh the data automatically or none to disable the feature.

DHCP Table

DHCP table displays the devices connected to the router with clear information.

▼ DHCP Table				
Index	Host Name	IP Address	MAC Address	Expire Time
1	Billion-HC-ee	192.168.1.101	00:C0:9F:D1:E1:CA	0days 23:36:1

Index #: The numeric indicator for devices using dynamic IP addresses.

Host Name: Display the hostname of the PC.

IP Address: The IP allocated to the device.

MAC Address: The MAC of the connected device.

Expire Time: The total remaining interval since the IP assignment to the PC.

ARP Table

ARP (Address Resolution Protocol) table displays a mapping IP address with a PC's MAC address.

▼ ARP Table		
#	IP	MAC Address
1	192.168.1.11	f0:de:f1:31:68:77

#: The numeric table list indicator.

IP Address: It is the internal/local IP address to access to the network.

MAC Address: The MAC address of a device, e.g. PC, notebook, printer, etc., that is corresponded with the IP address.

VRRP Status

▼ VRRP Status	
Current Status	N/A
Current Master	N/A

Current Status: Display current VRRP status, Master or Backup.

Current Master: Display the IP address of the Master

Quick Start

This is a useful and easy utility to help you to setup the router quickly and to connect to your ISP (Internet Service Provider) with only a few steps. It will guide you step by step to setup password, time zone, and WAN settings of your device. The Quick Start Wizard is a helpful guide for the first-time users to the device.

▼ Quick Start

The 'Quick Start' wizard will guide you to configure the device to connect to your ISP(Internet Service Provider). Please follow the 'Quick Start' wizard step by step to configure the device. It will allow you to have Internet access within minutes.

Run Wizard

For detailed instructions on configuring WAN settings, see refer to the **Interface Setup** section.

▼ Quick Start

The Wizard will guide you through these five quick steps. Begin by clicking on **NEXT**.

Step 1. Set your new password

Step 2. Choose your time zone

Step 3. Set your internet connection

Step 4. Confirm the configuration and save it

Next

Click **NEXT** to move on to Step 1.

Step 1 – Password

Set new password of the “admin” account to access for router management. The default is “admin”. Once changed, please use this new password next time when accessing to the router. Click **NEXT** to continue.

▼ Quick Start - Password

You may change the admin account password by entering in a new password. Click **NEXT** to continue.

New Password

Confirm Password

Back Next

Step 2 – Time Zone

Choose your time zone. Click **NEXT** to continue.

▼ Quick Start - Time Zone

Select the appropriate time zone for your location and click **NEXT** to continue.

Time Zone

Back Next

Step 3 – ISP Connection Type

Set up your Internet connection.

3.1 Select an appropriate WAN connection protocol then click **NEXT** to continue.

3.2(1) If selected **4G/LTE**

Input all relevant 3G/4G/LTE parameters from your cellular provider.

Click **Next** to continue.

3.2(2) If selected **EWAN(LAN1) / Static IP or PPPoE**, static IP address or PPPoE account information provided by your ISP.

Click **NEXT** to continue.

Step 4 – Quick Start Completed

The Setup Wizard has completed. Click on **BACK** to make changes or correct mistakes. Click **NEXT** to save the current settings and complete the Quick Start setups.

▼ Quick Start - Quick Start Completed

Quick Start Completed !!

The Setup Wizard has completed. Click on **BACK** to modify changes or mistakes. Click **NEXT** to exit the Setup Wizard.

Back Next

▼ Quick Start - Quick Start Completed !!

Quick Start Completed !!

Saved Changes.

Go back to the **Status > Device Info** to view the status.

Device Configuration

Interface Setup

Here are the features under **Interface Setup**: Internet, LAN and Loopback

Internet

❖ 4G/LTE

Internet	
WAN Interface	4G/LTE ▾
Status	<input checked="" type="radio"/> Activated <input type="radio"/> Deactivated
Usage Allowance ▶	<input type="checkbox"/> Enable
IP Pass-Through Mode	<input type="checkbox"/> Enable
LTE Antenna Diversity ▶	Enabled
Network Mode	Automatic ▾
PLMN Selection	Operator Numeric <input type="text"/> RAT <input type="text"/> <input type="button" value="Scan"/>
TEL No.	*99***1#
Dual APN	Single APN ▾
APN	internet
PDN Type	<input checked="" type="radio"/> IPv4 <input type="radio"/> IPv4/IPv6 <input type="radio"/> IPv6
Authentication Protocol	Disable ▾
Username	<input type="text"/>
Password	<input type="text"/>
PIN	<input type="text"/>
Connection	<input checked="" type="radio"/> Always On (Recommended)
Keep Alive	<input type="radio"/> Yes <input checked="" type="radio"/> No
Keep Alive IP	<input type="text"/>
Default Route	<input checked="" type="radio"/> Yes <input type="radio"/> No
NAT	Enable ▾
MTU	1428 (0 means use default:1500)
<input type="button" value="Save"/>	

WAN Interface: List all available WAN interfaces. (In this section, you have selected to use 4G/LTE)

Status: Choose Activated to enable the 4G/LTE connection.

Usage Allowance: Enable and click “Usage Allowance” for further setting configuration of your 4G/LTE data usage.

Usage Allowance

Usage Allowance (Cont.)

Usage Allowance

Parameters

Mode

Volume-based
Only Download [0] MB data volume per month included

Time-based
720 hours per month included
The billing period always begins on day 1 of a month.

Over usage allowance action: None

Save the statistics to ROM: Disable

Save Back

Mode: Include **Volume-based** and **Time-based** control.

- ▶ **Volume-based** include “only Download”, “only Upload”, and “Download and Upload” to limit the flow.
- ▶ **Time-based** control the flow by providing specific hours per month.

The billing period begins on: the beginning day of billing each month.

Over usage allowance action: Here are actions to perform when mobile data usage, defined in **Mode**, reached to its maximum.

- ▶ **None:** No action taken
- ▶ **Disconnect:** Disconnect mobile connection
- ▶ **Email Alert:** Send an e-mail alert and keep the mobile connection alive.
- ▶ **Email Alert and Disconnect:** Disconnect mobile connection after an alert e-mail is being sent.

Save the statistics to ROM:

- ▶ **Every one hour:** Activate the 3G/4G-LTE statistics on data usage and this info will get updated and saved to the internal memory (ROM) in every hour.

Once the feature is turned on, you can see the amount of data used and how many days left before next billing cycle starts. Go to **Status >> 3G/4G-LTE Status** page for details.

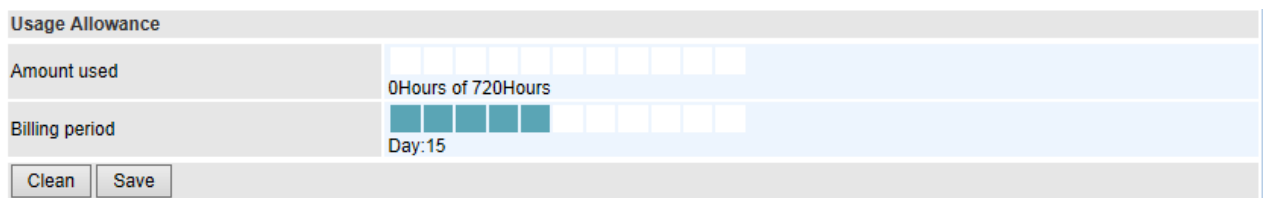

NOTE: This statistic information will get deleted after a factory reset.

- ▶ **Disable:** No action taken

IP Pass-through Mode: When **enabled**, MX-230 M1 is in bridge mode that it does not obtain a WAN IP address; features such as routing capabilities, NAT, firewall, etc., are being disabled. The client router that is behind the MX-230 M1 now obtains a WAN IP address. When **disabled**, MX-230 M1 is in router mode that it handles a WAN IP address and all features become available.

Network Mode: There are 8 options of service standards: “Automatic”, “UMTS 3G only”, “GSM 2G Only”, “UMTS 3G Preferred”, “GSM 2G Preferred”, “GSM and UMTS Only”, “LTE Only”, and “GSM, UMTS, LTE”. If you are not sure which mode to use, you may select **Automatic** to auto detect the best

mode for you.

PLMN Selection: Public Land Mobile Network (PLMN). Either manually enter the information or click **Scan** button to scanning all closest base stations in the area.

TEL No.: The dial string to make a GPRS/3G/4G-LTE user internetworking call. It may provide by your mobile service provider.

Dual APN *: Unit can support up to two (2) APNs. Select **Single / Dual** or a **different LTE/3G APN**.

- ▶ **APN (3G):** If select **LTE/3G with different APN**, enter the APN here.

* **Feature is available with specific cellular module**

APN: An APN is similar to a URL on the WWW, it is what the unit makes a GPRS / UMTS call. The service provider is able to attach anything to an APN to create a data connection, requirements for APNs varies between different service providers. Most service providers have an internet portal which they use to connect to a DHCP Server, thus giving you access to the internet i.e. some 3G operators use the APN 'internet' for their portal. The default value is "internet".

PDN Type: The IP type for PDN connections. Available types are **IPv4, IPv6, and IPv4v6**.

Authentication Protocol: Manually specify CHAP (Challenge Handshake Authentication Protocol) or PAP (Password Authentication Protocol). When using PAP, the password is sent unencrypted, while CHAP encrypts the password before sending, and also allows for challenges at different periods to ensure that an intruder has not replaced the client.

Username/Password: Enter the username and password provided by your service provider. The username and password are case sensitive.

PIN: PIN stands for Personal Identification Number. A PIN code is a numeric value used in certain systems as a password to gain access, and authenticate. In mobile phones a PIN code locks the SIM card until you enter the correct code. If you enter the PIN code incorrectly into the phone 3 times in a row, then the SIM card will be blocked and you will require a PUK code from your network/service provider.

Connection: Default set to Always on to keep an always-on 3G/4G-LTE connection.

Keep Alive: Select **Yes** to keep the 4G-LTE connection always on

- ▶ **Keep Alive IP:** Manually enter the Keep Alive IP Address to be used for ping operation to check if the connection is still on.
- ▶ **Check Interval 5 x ___ Seconds:** Default is set to 1 (5 seconds). Setup a timer to ping the keep alive IP.

Default Route: Select **Yes** to use this interface as default route interface.

NAT: Select this option to Disabled/Enable the NAT (Network Address Translation) function. Enable NAT to grant multiples devices in LAN to access to the Internet through a single WAN IP.

When router's Internet configuration is finished successfully, you can go to the Status to check connection information.

MTU: maximum Transmission Unit. The size of the largest datagram (excluding media-specific headers) an IP attempts to send through the interface. **0** means to use default MTU size, 1500byte.

Click **Save** to apply settings.

❖ EWAN (LAN 1)

Internet	
WAN Interface	EWAN(LAN1) ▾
Status	<input type="radio"/> Activated <input checked="" type="radio"/> Deactivated
IPv4/IPv6	
IP Version	<input type="radio"/> IPv4 <input checked="" type="radio"/> IPv4/IPv6 <input type="radio"/> IPv6
ISP Connection Type	
ISP	<input type="radio"/> Dynamic IP Address <input type="radio"/> Static IP Address <input checked="" type="radio"/> PPPoE
802.1q Options	
802.1q	<input type="radio"/> Activated <input checked="" type="radio"/> Deactivated
VLAN ID	0 (range: 0~4095)
PPPoE	
Username	<input type="text"/>
Password	<input type="text"/>
Bridge Interface for PPPoE	<input type="radio"/> Activated <input checked="" type="radio"/> Deactivated
Connection Setting	
Connection	<input checked="" type="radio"/> Always On (Recommended) <input type="radio"/> Connect Manually
TCP MSS Option	TCP MSS <input type="text" value="0"/> bytes(0 means use default)
IP Options	
IP Common Options	
Default Route	<input checked="" type="radio"/> Yes <input type="radio"/> No
TCP MTU Option	TCP MTU <input type="text" value="0"/> bytes(0 means use default:1492)
IPv4 Options	
Get IP Address	<input type="radio"/> Static <input checked="" type="radio"/> Dynamic
Static IP Address	<input type="text" value="0.0.0.0"/>
IP Subnet Mask	<input type="text" value="0.0.0.0"/>
Gateway	<input type="text" value="0.0.0.0"/>
NAT	Enable ▾
Dynamic Route	RIP1 ▾ Direction None ▾
IGMP Proxy	<input type="radio"/> Enable <input checked="" type="radio"/> Disable
IPv6 Options	
IPv6 Address	<input type="text"/> / <input type="text"/>
Obtain IPv6 DNS	<input checked="" type="radio"/> Enable <input type="radio"/> Disable
Primary DNS	<input type="text"/>
Secondary DNS	<input type="text"/>
MLD Proxy	<input type="radio"/> Enable <input checked="" type="radio"/> Disable
<input type="button" value="Save"/>	

Status: Select to enable/activate or disable/deactivated the service.

IPv4/IPv6

IP Version: Choose **IPv4**, **IPv4/IPv6**, **IPv6** based on your environment. If you don't know which one to choose from, please choose IPv4/IPv6 instead.

ISP Connection Type:

ISP: Select the encapsulation type your ISP uses.

- ▶ **Dynamic IP:** Select this option if your ISP provides you an IP address automatically.
- ▶ **Static IP:** Select this option to set static IP information. You will need to enter in the Connection type, IP address, subnet mask, and gateway address, provided to you by your ISP. Each IP address entered in the fields must be in the appropriate IP form. IP address from by four IP octets separated by a dot (xx.xx.xx.xx). The Router will not accept the IP address if it is not in this format.
- ▶ **PPPoE:** Select this option if your ISP requires you to use a PPPoE connection.
- ▶ **Bridge:** Select this mode if you want to use this device as an OSI Layer 2 device like a switch.

802.1q Options

802.1q: When activated, please enter a VLAN ID.

VLAN ID: It is a parameter to specify the VLAN which the frame belongs. Enter the VLAN ID identification, tagged: 0-4095.

PPPoE (If selected PPPoE as WAN Connection Type; otherwise, skip this part)

Username: Enter the user name provided by your ISP.

Password: Enter the password provided by your ISP.

Bridge Interface for PPPoE: When “Activated”, the device will gain WAN IP from your ISP with the PPPoE account. But if your PC is connected to the router working as a DHCP client, in this mode, the device acts as a NAT router; while if you dial up with the account within your PC, the device will then work as a bridge forwarding the PPPoE information to the PPPoE server and send the response to your PC, thus your PC gets a WAN IP working in the internet.

Connection Setting

Connection:

- ▶ **Always On:** Click on **Always On** to establish a PPPoE session during start up and to automatically re-establish the PPPoE session when disconnected by the ISP.
- ▶ **Connect Manually:** Select **Connect Manually** when you don't want the connection up all the time.

TCP MSS Option: Enter the maximum size of the data that TCP can send in a segment. Maximum Segment Size (MSS).

IP Options

IP Options	
IP Common Options	
Default Route	<input checked="" type="radio"/> Yes <input type="radio"/> No
TCP MTU Option	TCP MTU <input type="text" value="0"/> bytes(0 means use default:1492)
IPv4 Options	
Get IP Address	<input type="radio"/> Static <input checked="" type="radio"/> Dynamic
Static IP Address	<input type="text" value="0.0.0.0"/>
IP Subnet Mask	<input type="text" value="0.0.0.0"/>
Gateway	<input type="text" value="0.0.0.0"/>
NAT	Enable ▾
Dynamic Route	RIP1 ▾ Direction None ▾
IGMP Proxy	<input type="radio"/> Enable <input checked="" type="radio"/> Disable
IPv6 Options	
IPv6 Address	<input type="text"/> / <input type="text"/>
Obtain IPv6 DNS	<input checked="" type="radio"/> Enable <input type="radio"/> Disable
Primary DNS	<input type="text"/>
Secondary DNS	<input type="text"/>
MLD Proxy	<input type="radio"/> Enable <input checked="" type="radio"/> Disable

[IP Common Options](#)

Default Route: Select **Yes** to use this interface as default route interface.

TCP MTU Option: Enter the maximum packet that can be transmitted. Default MTU **0** means it is set to 1492 bytes.

[IPv4 Options](#)

Get IP Address: Choose Static or Dynamic

Static IP Address: If **Static** is selected in the above field, please enter the specific IP address you get from ISP and the following IP subnet mask and gateway address.

IP Subnet Mask: The default is 0.0.0.0. User can change it to other such as 255.255.255.0. Type the subnet mask assigned to you by your ISP (if given).

Gateway: Enter the specific gateway IP address you get from ISP.

NAT: Enable to allow MX-230 M1 to assign private network IPs to all devices in the network for get Internet access.

Dynamic Route:

- ▶ **RIP Version:** (Routing Information protocol) Select this option to specify the RIP version, including RIP-1, RIP-2.
- ▶ **RIP Direction:** Select this option to specify the RIP direction.
 - **None** is for disabling the RIP function.
 - **Both** means the router will periodically send routing information and accept routing information then incorporate into routing table.
 - **IN only** means the router will only accept but will not send RIP packet.
 - **OUT only** means the router will only send but will not accept RIP packet.

IGMP Proxy: IGMP (Internet Group Multicast Protocol) is a network-layer protocol used to establish membership in a Multicast group. Choose whether enable IGMP proxy.

[IPv6 options](#) (only when choose IPv4/IPv6 or just IPv6 in IP version field above):

IPv6 Address: Type the WAN IPv6 address from your ISP.

Obtain IPv6 DNS: Choose if you want to obtain DNS automatically.

Primary/Secondary: if you choose Disable in the Obtain IPv6 DNS field, please type the exactly primary and secondary DNS.

MLD Proxy: MLD (Multicast Listener Discovery Protocol) is to IPv6 just as IGMP to IPv4. It is a Multicast Management protocol for IPv6 multicast packets.

When router's Internet configuration is finished successfully, you can go to status to get the connection information.

Click **Save** to apply settings.

LAN

A Local Area Network (LAN) is a shared communication system to which many computers are attached and is limited to the immediate area, usually the same building or floor of a building.

LAN

IPv4 Parameters

IP Address:

IP Subnet Mask:

Alias IP Address: (0.0.0.0 means to close the alias ip)

Alias IP Subnet Mask:

Snooping: Activated Deactivated

Dynamic Route: RIP1 Direction: None

DHCPv4 Server

DHCPv4 Server: Disabled Enabled Relay

Start IP:

IP Pool Count:

Lease Time: seconds (0 sets to default value of 259200)

Physical Ports: LAN1 LAN2

DNS Relay: Automatically Manually

Primary DNS:

Secondary DNS:

Option 66:

Option 160:

Fixed Host

IP Address:

MAC Address:

IPv6 Parameters

Interface Address/Prefix Length: /

DHCPv6 Server

DHCPv6 Server: Disable Enable

DHCPv6 Server Type: Stateless Stateful

Start Interface ID:

End Interface ID:

Lease Time: seconds (0 sets to default value of 4800)

Router Advertisements: Disable Enable

Fixed Host List

Index	IP	MAC	Drop
-------	----	-----	------

IPv4 Parameters

IP Address: Enter the IP address of Router in dotted decimal notation, for example, 192.168.1.254 (factory default).

IP Subnet Mask: The default is 255.255.255.0. User can change it to other such as 255.255.255.128.

Alias IP Address: This is for local networks virtual IP interface. Specify an IP address on this virtual interface.

Alias IP Subnet Mask: Specify a subnet mask on this virtual interface.

IGMP Snooping: Select **Activated** to enable IGMP Snooping function. Without the IGMP snooping, multicast traffic is treated in the same manner as broadcast traffic to be forwarded to all ports. With

IGMP snooping, multicast traffic of a group is only forwarded to ports that have members of that group.

Dynamic Route: Select the RIP version from RIP1 or RIP2.

DHCPv4 Server

DHCP (Dynamic Host Configuration Protocol) allows individual clients to obtain TCP/IP configuration at start-up from a server.

DHCPv4 Server	<input type="radio"/> Disabled <input checked="" type="radio"/> Enabled <input type="radio"/> Relay
Start IP	<input type="text" value="192.168.1.100"/>
IP Pool Count	<input type="text" value="100"/>
Lease Time	<input type="text" value="86400"/> seconds (0 sets to default value of 259200)
Physical Ports	<input checked="" type="checkbox"/> LAN1 <input checked="" type="checkbox"/> LAN2
DNS Relay	<input checked="" type="radio"/> Automatically <input type="radio"/> Manually
Primary DNS	<input type="text"/>
Secondary DNS	<input type="text"/>
Option 66	<input type="text"/>
Option 160	<input type="text"/>

DHCPv4 Server: If set to **Enabled**, your MX-230 M1 can assign IP addresses, default gateway and DNS servers to the DHCP client.

- ▶ If set to **Disabled**, the DHCP server will be disabled.
- ▶ If set to **Relay**, the MX-230 M1 acts as a surrogate DHCP server and relays DHCP requests and responses between the remote server and the clients. Enter the IP address of the actual, remote DHCP server in the Remote DHCP Server field in this case.
- ▶ When DHCP is used, the following items need to be set.

Start IP: This field specifies the first of the contiguous addresses in the IP address pool.

IP Pool Count: This field specifies the count of the IP address pool.

Lease Time: The current lease time of client.

Physical Ports: Select to determine if the DHCPv4 server is applicable to the specific port or ports. By default, all ports can obtain local IP from the DHCPv4 server.

DNS Relay:

- ▶ Select **Automatic** detection or
- ▶ **Manually** specific Primary and Secondary DNS IP addresses

Primary / Secondary DNS Server: Enter the IP addresses of the DNS servers. The DNS servers are passed to the DHCP clients along with the IP address and the subnet mask.

Option 66: Set the IP or hostname of the TFTP server for devices, like IPTV Set Box, to get configuration settings from the TFTP server.

Option 160: Set the IP or hostname of the TFTP server for devices, like IPTV Set Box, to get configuration settings from the TFTP server. (The option 160 is an extended feature in DHCP option, similar to option 66, but using http or https protocols.)

Fixed Host

In this field, users can map the specific IP (must in the DHCP IP pool) for some specific MAC, and this information can be listed in the following table.

Fixed Host	
IP Address	<input type="text"/>
MAC Address	<input type="text"/>

IP Address: Enter the specific IP. For example: 192.168.1.110.

MAC Address: Enter the responding MAC. For example: 00:0A:F7:45:6D:ED

When added, you can see the ones listed as showed below:

Fixed Host Listing			
Index	IP Address	MAC Address	Delete
1	192.168.1.110	00:04:ED:01:01:10	

IPv6 Parameters

The IPv6 address composes of two parts, thus, the prefix and the interface ID.

Interface Address/Prefix Length /

Interface Address / Prefix Length: Enter a static LAN IPv6 address. If you are not sure what to do with this field, please leave it empty as if contains false information it could result in LAN devices not being able to access other IPv6 device. Router will take the same WAN's prefix to LAN side if the field is empty.

DHCPv6 Server

DHCPv6 Server	<input type="radio"/> Disable <input checked="" type="radio"/> Enable
DHCPv6 Server Type	<input checked="" type="radio"/> Stateless <input type="radio"/> Stateful
Start Interface ID	<input type="text"/>
End Interface ID	<input type="text"/>
Lease Time	<input type="text"/> seconds(0 sets to default value of 4800)
Router Advertisements	<input type="radio"/> Disable <input checked="" type="radio"/> Enable

There are two methods to dynamically configure IPv6 address on hosts, **Stateless** and **Stateful**.

Stateless auto-configuration requires no manual configuration of hosts, minimal (if any) configuration of routers, and no additional servers. The stateless mechanism allows a host to generate its own addresses using a combination of locally available information (MAC address) and information (prefix) advertised by routers. Routers advertise prefixes that identify the subnet(s) associated with a link, while hosts generate an "interface identifier" that uniquely identifies an interface on a subnet. An address is formed by combining the two. When using stateless configuration, you needn't configure anything on the client.

Stateful configuration, for example using DHCPv6 (which resembles its counterpart DHCP in IPv4.) In the stateful auto configuration model, hosts obtain interface addresses and/or configuration information and parameters from a DHCPv6 server. The Server maintains a database that keeps track of which addresses have been assigned to which hosts.

DHCPv6 Server: Check whether to enable DHCPv6 server.

DHCPv6 Server Type: Select Stateless or Stateful. When DHCPv6 is enabled, this parameter is

available.

- ▶ **Stateless:** If selected, the PCs in LAN are configured through RA mode, thus, the PCs in LAN are configured through RA mode, to obtain the prefix message and generate an address using a combination of locally available information (MAC address) and information (prefix) advertised by routers, but they can obtain such information like DNS from DHCPv6 Server.
- ▶ **Stateful:** If selected, the PCs in LAN will be configured like in IPv4 mode, thus obtain addresses and DNS information from DHCPv6 server.

Start interface ID: enter the start interface ID. The IPv6 address composed of two parts, thus, the prefix and the interface ID. Interface is like the Host ID compared to IPv4.

End interface ID: enter the end interface ID.

Leased Time (seconds): the leased time, similar to leased time in DHCPv4, is a time limit assigned to clients, when expires, the assigned ID will be recycled and reassigned.

Router Advertisement: Check to Enable or Disable the Issue Router Advertisement feature. This feature is to send Router Advertisement messages periodically which would multicast the IPv6 Prefix information (similar to v4 network number 192.168.1.0) to all LAN devices if the field is enabled. We suggest enabling this field.

Click **Save** to apply settings.

Loopback

Loopback interface is a widely known virtual interface, not the physical interface, on router and is highly robust and always up. The loopback interface has its own IP and subnet mask, often used for router management as Telnet management IP and involved in BGP as BGP Update-Source and OSPF as Router ID.

▼ Loopback	
Loopback interface	<input type="radio"/> Activated <input checked="" type="radio"/> Deactivated
IP Address	<input type="text" value="127.0.0.1"/>
IP Subnet Mask	<input type="text" value="255.0.0.0"/>
<input type="button" value="Save"/>	

IP Address: Enter a dedicated IP address for the loopback interface.

IP Subnet Mask: Enter the subnet mask for the loopback interface.

Click **Save** to apply settings.

Dual WAN

Dual WAN, is a feature to have two independent Internet connection connected concurrently, offers a reliable Internet connectivity and maximize bandwidth utilization for critical applications delivery.

General Setting

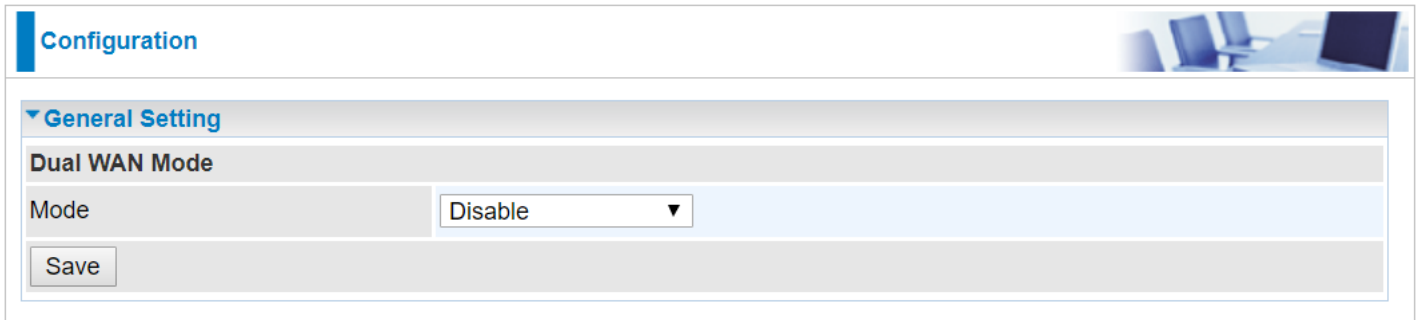

The screenshot displays a web-based configuration interface. At the top left, there is a blue header with the word "Configuration". Below this, a section titled "General Setting" is expanded. Underneath, the "Dual WAN Mode" section is visible. It contains a "Mode" label followed by a dropdown menu currently showing "Disable". A "Save" button is located at the bottom left of this section. The background of the configuration area features a faint image of office chairs and a desk.

Mode: Select a mode then click **Save** to proceed.

Dual WAN – General Setting (Failover & Failback)

❖ Failover & Failback

Auto failover/failback ensures always-online network connectivity. When primary WAN link (WAN1) fails, all traffic will switch over to the backup WAN (WAN2) seamlessly.

Again, when the primary link is restored, traffic will be handled over from WAN2 to WAN1.

General Setting	
Dual WAN Mode	
Mode	Failover & Failback
WAN Port Service Detection Policy	
WAN1	4G/LTE
WAN2	EWAN(LAN1)
Keep Backup Interface Connected	Disable
Minimum RSRP/RSSI	-105 / -90 dbm(-111~ -5 , 0:disable)
Connectivity Decision	Auto failover takes place after straight 3 consecutive failure in every 30 seconds.
Probe By Ping	<input checked="" type="checkbox"/> Enable
Ping Setting	<input type="radio"/> Gateway
	<input checked="" type="radio"/> Host 8.8.8.8
	Timeout 3 seconds
Probe By Signal Strength	<input checked="" type="checkbox"/> Enable
Minimum RSRP/RSSI	-105 / -90 dbm(-111~ -5 , 0:disable)
Save	

WAN Port Service Detection Policy

WAN1 (Primary): Choose a desired WAN as the primary WAN Link from the list.

WAN2 (Backup): Choose a desired WAN as the backup WAN Link from the list.

Keep Backup Interface Connected: Select the following option whether to keep the backup WAN (WAN2) interface connected to the Internet.

- ▶ **Disable:** Inactivate this feature.
- ▶ **Always:** Keep the backup WAN (WAN2) interface always connected to the Internet
- ▶ **By Signal Strength:** Enable and initiate automatic backup WAN to connect to the Internet at all time until the RSRP / RSSI of primary WAN is greater than the Minimum RSRP / RSSI.
 - **Minimum RSRP / RSSI:** Set a minimum requirement for RSRP and RSSI for the primary WAN. Value range from -111 ~ -5. 0 means don't care/no need to check this value.

NOTE: Both the RSRP and RSSI cannot be 0 at the same time.

Connectivity Decision & Probe Cycle: Set a number of times and time in seconds to determine when to switch to the backup link (WAN2) when primary link (WAN1) fails and vice versa.

Example, *Auto failover takes place after straight 3 consecutive failures in every 30 seconds* meaning all traffic will hand over to backup link (WAN2) after primary link fails to response in total of 90 seconds, 30 seconds for 3 consecutive failures.

Note: Failover and Failback follow the same **Connectivity Decision & Probe Cycle** rule to failover from WAN1 to WAN2 or fallback from WAN2 to WAN1.

Failover/Fallback Rule Decisions:

1. **Probe by Ping:** Enable Ping to the gateway or an IP address
 - ▶ **Gateway:** Internal system will wait for responses to the pings from the gateway of the WAN.
 - ▶ **Host:** Internal system will wait for responses to the pings from a fixed IP address.
2. **Probe by Signal Strength:** Enable to measure the LTE signal strength
 - ▶ **Minimum RSRP / RSSI:** Set a minimum requirement for RSRP and RSSI for initiating automatic WAN failback or failover procedures.

The valid range is from -111 ~ -5. 0 means don't care/no need to check this value.

NOTE: Both the RSRP and RSSI cannot be 0 at the same time.

Click **Save** to apply settings.

❖ **Load Balance**

Load balance aggregates the bandwidth of the two WAN links to optimize traffic distribution.

When the primary Internet (WAN1) goes down, all traffic will be redirected to the backup (WAN2) to ensure service continuity.

▼ General Setting	
Dual WAN Mode	
Mode	Load Balance ▼
WAN Port Service Detection Policy	
WAN1	4G/LTE ▼
WAN2	EWAN(LAN1) ▼
Service Detection	<input checked="" type="radio"/> Enable <input type="radio"/> Disable
Connectivity Decision	Auto failover takes place after straight <input type="text" value="3"/> consecutive failure in every <input type="text" value="30"/> seconds.
Probe WAN1	<input type="radio"/> Gateway <input checked="" type="radio"/> Host <input type="text" value="8.8.8.8"/> Timeout <input type="text" value="3"/> seconds
Probe WAN2	<input type="radio"/> Gateway <input checked="" type="radio"/> Host <input type="text" value="8.8.4.4"/>
<input type="button" value="Save"/>	

WAN Port Service Detection Policy

WAN1 (Primary): Choose a desired WAN as the primary WAN Link from the list.

WAN2 (Backup): Choose a desired WAN as the backup WAN Link from the list.

Service Detection: Enable to detect WAN connectivity automatically.

Connectivity Decision & Probe Cycle: Set a number of times and time in seconds to determine when to turn-off the Load Balancing service.

Example, *Disable Load Balance after straight 3 consecutive failures in every 30 seconds* meaning all traffic will hand over to backup link (WAN2) after primary link fails to response in total of 90 seconds, 30 seconds for 3 consecutive failures.

Deactivate Load Balance Decision:

Probe Ping on WAN 1 / WAN2: Enable Ping to the gateway or an IP address

- ▶ **Gateway:** Internal system will wait for responses to the pings from the gateway of the WAN.
- ▶ **Host:** Internal system will wait for responses to the pings from a fixed IP address.

Click **Save** to apply settings

Outbound Load Balance

The connections are distributed over WAN1 and WAN2 so that it can utilize bandwidth of both WAN ports. With Outbound load balance, traffic may be routed to a faster link when one of the WAN links is slower or congested so that user gains better throughput and less delay.

User can distribute outbound traffic based on **Session Mechanism** or **IP Hash Mechanism**.

Base on Session Mechanism:

Balance by Session (Round Robin): Automatically assign requests/traffics to each WAN interface based on real-time WAN traffic-handling capacity.

OR

Balance by Session weight: Manually Balance session traffic based on a weight ratio.

Example: Session weight by 3:1 meaning forward 3 requests to WAN1 and 1 request to WAN2.

Base on IP Hash Mechanism:

Balance by weight: Use an IP hash to balance traffic based on a ratio. It is to guarantee requests from the same IP address get forward to the same WAN interface.

Click **Save** to apply settings

Protocol Binding

Protocol Binding lets you direct specific traffic to go out from a specific WAN port. Policies determine how specific types of internet traffic are routed, for example, traffic from a specific IP address is granted access to only one WAN port rather than using both of the WAN ports as with load balancing.

▼ Protocol Binding

Rule Index	1 ▼	
Active	<input checked="" type="radio"/> Yes <input type="radio"/> No	
Bind Interface	WAN1 ▼	(Current WAN1 Mode: 4G/LTE , Current WAN2 Mode: EWAN)
Source IP Address	0.0.0.0	(0.0.0.0 means Don't care)
Subnet Mask	0.0.0.0	
Port Number	0	(0 means Don't care)
Destination IP Address	0.0.0.0	(0.0.0.0 means Don't care)
Subnet Mask	0.0.0.0	
Port Number	0	(0 means Don't care)
DSCP	0	(Value Range:0~64, 64 means Don't care)
Protocol	TCP ▼	

Protocol Binding List

#	Active	Interface	Source IP Address/Mask	Destination IP Address/Mask	Source Port	Destination Port	DSCP	Protocol

Rule Index: The numeric rule indicator. The maximum entry is up to 16.

Active: Click YES to activate the rule

Bind Interface: The dedicated WAN interface that guarantees to handle this traffic request.

Source IP Address: Enter the local network, known as source, IP address of the origin of a traffic/packet. 0.0.0.0 means any IP address in the network.

Subnet Mask: Enter the subnet of the source network.

Port Number: Enter the port number which defines the application.

Destination IP Address: Enter the destination / remote WAN IP address where the traffic/packet is going to. Enter 0.0.0.0 if no need to route to a specific IP address

Subnet Mask: Enter the subnet of the designation network.

Port Number: Enter the port number which defines the application.

DSCP: The DSCP value. Value Range from 0~64; 64 means any value/unspecified

Protocol: Select a protocol, TCP, UDP, ICMP, to use for this traffic.

Click **Save** to apply settings

Example:

All traffics from IP 192.168.1.100/255.255.255.0 with port 8080 will go through WAN1 interface.

The only time it would go through WAN2 interface is when WAN1 has no Internet connection.

Protocol Binding List								
#	Active	Interface	Source IP Address/Mask	Destination IP Address/Mask	Source Port	Destination Port	DSCP	Protocol
1	Yes	WAN1	192.168.1.100/ 255.255.255.0	0.0.0.0/ 0.0.0.0	8080	0	0	TCP

Advanced Setup

Advanced configuration features provide advanced features, including [Firewall](#), [Routing](#), [NAT](#), [VRRP](#), [Static DNS](#), [QoS](#), [Time Schedule](#), [Mail Alert](#) and [Serial Port](#) for advanced users.

Firewall

Your router includes a firewall for helping to prevent attacks from hackers. In addition to this, when using NAT (Network Address Translation) the router acts as a “natural” Internet firewall, since all PCs on your LAN use private IP addresses that cannot be directly accessed from the Internet.

Firewall	
Firewall	<input type="radio"/> Enabled <input checked="" type="radio"/> Disabled
SPI	<input type="radio"/> Enabled <input checked="" type="radio"/> Disabled
(WARNING: If You enabled SPI, all traffics initiated from WAN would be blocked, including DMZ, Virtual Server, and ACL WAN side.)	
Save	

Firewall: To automatically detect and block Denial of Service (DoS) attacks, such as Ping of Death, SYN Flood, Port Scan and Land Attack.

- ▶ **Enabled:** Activate your firewall function.
- ▶ **Disabled:** Deactivate the firewall function.

SPI: If you enabled SPI, all traffics initiated from WAN would be blocked, including DMZ, Virtual Server, and ACL WAN side.

- ▶ **Enabled:** Activate your SPI function.
- ▶ **Disabled:** Deactivate the SPI function.

Click **Save** to apply settings

Routing

This is static route feature. You are equipped with the capability to control the routing of all the traffic across your network. With each routing rule created, user can specifically assign the destination where the traffic will be routed to.

▼ Routing Table							
Index	Destination IP Address	Subnet Mask	Gateway IP Address	Metric	Interface	Edit	Drop
1	192.168.1.0	255.255.255.0	0.0.0.0	0	br0		
2	127.0.0.0	255.255.0.0	0.0.0.0	0	loopback		
3	239.0.0.0	255.0.0.0	0.0.0.0	0	br0		

Add Route

Index #: The numeric route indicator.

Destination IP Address: IP address of the destination network

Subnet Mask: The subnet mask of destination network.

Gateway IP Address: IP address of the gateway or existing interface that this route uses.

Metric: It represents the cost of transmission for routing purposes. The number need not be precise, but it must be between 1 and 15.

Interface: Media/channel selected to append the route.

Edit: Edit the route; this icon is not shown for system default route.

Drop: Drop the route; this icon is not shown for system default route.

Add Route

▼ Static Route	
Destination IP Address	<input type="text" value="0.0.0.0"/>
Destination Subnet Mask	<input type="text" value="0.0.0.0"/>
Gateway IP Address / Interface	<input type="radio"/> <input type="text" value="0.0.0.0"/> <input checked="" type="radio"/> <input type="text" value="4G/LTE"/>
Metric	<input type="text" value="1"/>
<input type="button" value="Save"/> <input type="button" value="Back"/>	

Destination IP Address: This is the destination subnet IP address.

Destination Subnet Mask: The subnet mask of destination network.

Gateway IP Address or Interface: This is the gateway IP address or existing interface to which packets are to be forwarded.

Metric: It represents the cost of transmission for routing purposes. The number need not be precise, but it must be between 1 and 15.

Click **Save** to add this route.

NAT

The NAT (Network Address Translation) feature transforms a private IP into a public IP, allowing multiple users to access the internet through a single IP account, sharing the single IP address. NAT break the originally envisioned model of IP end-to-end connectivity across the internet so NAT can cause problems where IPSec/ PPTP encryption is applied or some application layer protocols such as SIP phones are located behind a NAT. And NAT makes it difficult for systems behind a NAT to accept incoming communications.

▼ NAT	
NAT Status	Enable
ALG	
VPN Passthrough	<input checked="" type="radio"/> Enabled <input type="radio"/> Disabled
SIP ALG	<input checked="" type="radio"/> Enabled <input type="radio"/> Disabled
DMZ / Virtual Server	
Interface	4G/LTE ▼
DMZ	▶ Edit
Virtual Server	▶ Edit

NAT Status: Enabled. (Disabled if WAN connection is in **BRIDGE** mode)

ALG

VPN Passthrough: VPN pass-through is a feature of routers which allows VPN client on a private network to establish outbound VPNs unhindered.

SIP ALG: Enable the SIP ALG when SIP phone needs ALG to pass through the NAT. Disable the SIP ALG when SIP phone includes NAT-Traversal algorithm.

DMZ / Virtual Server

Interface: Select a WAN interface connection to allow external access to your internal network.

Service Index: Associated to EWAN interface marking each EWAN service (0-7), to select which EWAN service the DMZ and Virtual server are applied to.

Click **DMZ** [▶ Edit](#) or **Virtual Server** [▶ Edit](#) to move on to set the DMZ or Virtual Server parameters, which are represented in the following scenario.

DMZ

NOTE: This feature disables automatically if WAN connection is in BRIDGE mode or NAT is being turned OFF.

The DMZ Host is a local computer which has all UDP and TCP ports exposed to the Internet. When setting an internal IP address as the DMZ Host, all incoming packets will be forwarded to this local host device. Packet filter or virtual server entries will take priority over forwarding internet packets to the DMZ host.

DMZ

DMZ for: Single IPs Account/ EWAN(LAN1)

DMZ: Enabled Disabled

DMZ Host IP Address: 0.0.0.0

Save Back

Except Ports

Port:

Protocol: TCP

Description: Add

DMZ Export Ports Listing					
Index	Description	Protocol	Port	Edit	Delete
1	N/A	N/A	N/A		
2	N/A	N/A	N/A		
3	N/A	N/A	N/A		
4	N/A	N/A	N/A		
5	N/A	N/A	N/A		
6	N/A	N/A	N/A		

DMZ for (via a WAN Interface): Allows outside network to connect in and communicate with internal LAN devices via a specific WAN interface.

DMZ:

- ▶ **Enabled:** Activate the DMZ function.
- ▶ **Disabled:** Deactivate the DMZ function.

DMZ Host IP Address: Give a static IP address to the DMZ Host when **Enabled** radio button is checked. Be aware that this IP will be exposed to the WAN/Internet.

Click **Save** to apply settings

Except Ports

Except Ports: Bypass UDP or/and TCP ports, in the list, being forwarded to the DMZ host.

Port: Enter port to be monitored.

Protocol: Enter the protocol to be monitored.

Description: Enter a description to this rule.

Example: Skip port 80 (UDP/TCP) in the list. All Incoming request to access to port 80 (Web GUI) will be forwarded to the embedded HTTP server of MX-230 M1 instead of the DMZ host.

Click **Add** to add an entry to the Except Listing.

Virtual Server

NOTE: This feature disables automatically if WAN connection is in BRIDGE mode or NAT is being turned OFF.

Virtual Server is also known as Port Forwarding that allows MX-230 M1 to direct incoming traffic to a specific device in the network.

Configure a virtual rule in MX-230 M1 for remote users accessing services such as Web or FTP services via the public (WAN) IP address that can be automatically redirected to local servers in the LAN network. Depending on the requested service (TCP/UDP port number), the device redirects the external service request to the appropriate server within the LAN network.

▼ Virtual Server

Virtual Server for	4G/LTE
Protocol	TCP ▼
Start Port Number	<input style="width: 60px;" type="text" value="21"/>
End Port Number	<input style="width: 60px;" type="text" value="21"/>
Local IP Address	<input style="width: 100px;" type="text" value="192.168.1.110"/>
Start Port Number (Local)	<input style="width: 60px;" type="text" value="21"/>
End Port Number(Local)	<input style="width: 60px;" type="text" value="21"/>

Rule	Protocol	Start Port	End port	Local IP Address	Start Port Local	End Port Local	Edit	Drop
0	TCP	21	21	192.168.1.110	21	21		
1	N/A	N/A	N/A	N/A	N/A	N/A		
2	N/A	N/A	N/A	N/A	N/A	N/A		
3	N/A	N/A	N/A	N/A	N/A	N/A		
4	N/A	N/A	N/A	N/A	N/A	N/A		
5	N/A	N/A	N/A	N/A	N/A	N/A		
6	N/A	N/A	N/A	N/A	N/A	N/A		
7	N/A	N/A	N/A	N/A	N/A	N/A		
8	N/A	N/A	N/A	N/A	N/A	N/A		
9	N/A	N/A	N/A	N/A	N/A	N/A		
10	N/A	N/A	N/A	N/A	N/A	N/A		

Virtual Server for: Indicate the related WAN interface to allow outside network to communicate with the internal LAN device.

Protocol: Choose the application protocol.

Start / End Port Number: Enter a port or port range you want to forward.

(Example: Start / End: 1000 or Start: 1000, End: 2000).

The starting port must be greater than zero (0). The end port must be greater than or equal to the start port.

Local IP Address: Enter the server IP address in the network to receive the traffic/packets.

Start / End Port Number (Local): Enter the start / end port number of the local application (service).

Examples of well-known and registered port numbers are shown below. For further information, please see IANA's website at <http://www.iana.org/assignments/port-numbers>

Well-known and Registered Ports

Port Number	Protocol	Description
21	TCP	FTP Control
22	TCP & UDP	SSH Remote Login Protocol
23	TCP	Telnet
25	TCP	SMTP (Simple Mail Transfer Protocol)
53	TCP & UDP	DNS (Domain Name Server)
69	UDP	TFTP (Trivial File Transfer Protocol)
80	TCP	World Wide Web HTTP
110	TCP	POP3 (Post Office Protocol Version 3)
443	TCP & UDP	HTTPS
1503	TCP	T.120
1720	TCP	H.323
7070	UDP	RealAudio



Attention

Using port forwarding does have security implications, as outside users will be able to connect to PCs on your network. For this reason you are advised to use specific Virtual Server entries just for the ports your application requires, instead of using DMZ. As doing so will result in all connections from the WAN attempt to access to your public IP of the DMZ PC specified.

If you have disabled the NAT option in the WAN-ISP section, the Virtual Server function will hence be invalid.

If the DHCP server option is enabled, you have to be very careful in assigning the IP addresses of the virtual servers in order to avoid conflicts. The easiest way of configuring Virtual Servers is to manually assign static IP address to each virtual server PC, with an address that does not fall into the range of IP addresses that are to be issued by the DHCP server. You can configure the virtual server IP address manually, but it must still be in the same subnet as the router.

Example: How to setup Port Forwarding for port 21 (FTP server)

If you have a FTP server in your LAN network and want others to access it through WAN.

Step 1: Assign a static IP to your local computer that is hosting the FTP server.

Step 2: Login to the Gateway and go to **Configuration / Advanced Setup / NAT / Virtual Server**.

FTP server uses TCP protocol with port 21.

Enter "21" to Start and End Port Number. The MX-230 M1 will accept port 21 requests from WAN side.

Enter the static IP assigned to the local PC that is hosting the FTP server. Ex: 192.168.1.102

Enter "21" to Local Start and End Port number. The MX-230 M1 will forward port 21 request from WAN to the specific LAN PC (Example: 192.168.1.102) in the network.

Step 3: Click **Save** to save settings.

Virtual Server

Virtual Server for	4G/LTE
Protocol	TCP
Start Port Number	21
End Port Number	21
Local IP Address	192.168.1.110
Start Port Number (Local)	21
End Port Number(Local)	21

Virtual Server Listing								
Rule	Protocol	Start Port	End port	Local IP Address	Start Port Local	End Port Local	Edit	Drop
0	TCP	21	21	192.168.1.110	21	21		
1	N/A	N/A	N/A	N/A	N/A	N/A		
2	N/A	N/A	N/A	N/A	N/A	N/A		
3	N/A	N/A	N/A	N/A	N/A	N/A		
4	N/A	N/A	N/A	N/A	N/A	N/A		
5	N/A	N/A	N/A	N/A	N/A	N/A		
6	N/A	N/A	N/A	N/A	N/A	N/A		
7	N/A	N/A	N/A	N/A	N/A	N/A		
8	N/A	N/A	N/A	N/A	N/A	N/A		
9	N/A	N/A	N/A	N/A	N/A	N/A		
10	N/A	N/A	N/A	N/A	N/A	N/A		

VRRP

VRRP is designed to eliminate the single point of failure inherent in the static default routed environment. VRRP specifies an election protocol that dynamically assigns responsibility for a virtual router to one of the VRRP routers in a LAN. The VRRP router controlling the IP address associated with a virtual router is called the Master, and forwards packets sent to these IP addresses. The election process provides dynamic fail-over in the forwarding responsibility should the Master become unavailable. Any of the virtual router's IP addresses in a LAN can then be used as the default first hop router by end-hosts. The advantage gained from using VRRP is a higher availability default path without requiring configuration of dynamic routing or router discovery protocols on every end-host.

VRRP	
VRRP	<input type="radio"/> Activated <input checked="" type="radio"/> Deactivated
VRID	<input type="text" value="1"/> (1~255)
Priority	<input type="text" value="100"/> (1~254)
Preempt Mode	<input checked="" type="radio"/> Activated <input type="radio"/> Deactivated
VRIP	<input type="text" value="192.168.1.253"/>
Advertisement Period	<input type="text" value="1"/> (1~2147483647)
<input type="button" value="Save"/>	

VRRP: Click to activate the feature.

VRID: Virtual Router Identifier. Configured item in the range 1-255 (decimal). A master or backup router running the VRRP protocol may participate in one VRID instance.

Priority: Specifies the sending VRRP router's priority for the virtual router. Higher values equal higher priority. The priority value for the VRRP router that owns the IP address associated with the virtual router **MUST** be 255. VRRP routers backing up a virtual router **MUST** use priority values between 1 and 254. The default priority value for VRRP routers backing up a virtual router is 100. The priority value zero (0) has special meaning indicating that the current Master has stopped participating in VRRP. This is used to trigger Backup routers to quickly transition to Master without having to wait for the current Master to timeout.

Preempt Mode: When preempt mode is activated, a backup router always takes over the responsibility of the master router. When deactivated, the lower priority backup is left in the master state.

VRIP: An IP address which is associated with the virtual router.

Advertisement period: Indicates the time interval in seconds between advertisements. Default in 1 second.

Click **Save** to apply settings.

Static DNS

The Domain Name System (DNS) is a hierarchical naming system built on a distributed database for computers, services, or any resource connected to the Internet or a private network associates various information with domain names assigned to each of the participating entities. Most importantly, it translates domain names meaningful to humans into the numerical identifiers associated with networking equipment for the purpose of locating and addressing these devices worldwide.

An often-used analogy to explain the Domain Name System is that it serves as the phone book for the Internet by translating human-friendly computer hostnames into IP addresses. For example, the domain name `www.example.com` can be translated into the addresses `192.0.32.10` (IPv4).

Static DNS

IP Address

Domain Name

Static DNS Listing

Index	IP Address	Domain Name	Edit	Delete

IP Address: The IP address you are going to give a specific domain name.

Domain Name: The friendly domain name for the IP address.

Click **Save** to apply settings.

QoS

QoS helps you control the upload traffic of each application from LAN (Ethernet and/or Wireless) to WAN (Internet).

It facilitates you the features to control the quality of throughput for each application. This is useful when there on certain types of data you want give higher priority to, such as voice data packets given higher priority than web data packets.

Quality of Service

SW QoS Activated Deactivated

Bandwidth

LAN to WAN Bandwidth Kbps

WAN to LAN

EWAN(LAN2) Bandwidth Kbps

4G/LTE Bandwidth Kbps

Rule Index	<input type="text" value="1"/>	Wan Interfae	<input type="text" value="EWAN(LAN2)"/>	Application	<input type="text"/>
Direction	<input type="text" value="LAN to WAN"/>	Protocol	<input type="text" value="Any"/>	DSCP Marking	<input type="text" value="Disable"/>
Rate Type	<input type="text" value="Limited(Maximum)"/>	Rate	<input type="text"/>	Priority	<input type="text" value="High"/>
Internal IP Address	<input type="text" value="0.0.0.0"/> ~ <input type="text" value="0.0.0.0"/>	Internal Port	<input type="text" value="0"/> ~ <input type="text" value="0"/> **		
External IP Address	<input type="text" value="0.0.0.0"/> ~ <input type="text" value="0.0.0.0"/>	External Port	<input type="text" value="0"/> ~ <input type="text" value="0"/> **		

Note * : 0.0.0.0 ~ 0.0.0.0 means all IPs

Note * : 0 ~ 0 means all Ports

QOS Control Listing

Index	Application	Direction	Rate Type	Rate	Wan Interface
-------	-------------	-----------	-----------	------	---------------

SW QoS: Select **Activate** to enable the QoS

LAN to WAN (Bandwidth): You want to control the traffic from local network to the outside (Upstream). You can assign the priority for the application or you can limit the rate of the application.

Eg: you have a FTP server inside the local network, and you want to have a limited control by the QoS policy and so you need to add a policy with LAN to WAN direction setting.

WAN to LAN (Bandwidth): Control traffic from WAN to LAN (Downstream).

Click **Bandwidth Save** to save settings.

Rule Index: Index marking for each rule up to maximum of 16.

- ▶ **WAN Interface:** Select a WAN interface connection to allow external access to your internal network.
- ▶ **Application:** Assign a name that identifies the new QoS application rule. Select from the list box for quick setup.

Direction: Shows the direction mode of the QoS application

- ▶ **Protocol:** Select a protocol from the drop down list
- ▶ **DSCP Marking:** Differentiated Services Code Point (DSCP), it is the first 6 bits in the ToS byte. DSCP Marking allows users to classify the traffic of the application to be executed according to the DSCP value.

Rate Type: Choose *Limited* (Maximum) or *Guaranteed* (Minimum) to specify the data rate is allowed for this policy.

- ▶ **Rate:** Specify the data rate in Kbps.
- ▶ **Priority:** Set the priority given to each policy/application. Specify the priority for the use of bandwidth. You can specify which application can have higher priority to acquire the bandwidth. Its default setting is set to High. You may adjust this setting to fit your policy / application.

Internal IP Address: The IP address values for Local LAN devices you want to give control.

- ▶ **Internal Port:** The Port number on the LAN side, it is used to identify an application.

External IP Address: The IP address on remote / WAN side.

- ▶ **External Port:** The Port number on the remote / WAN side.

Click **Save** to apply settings.

To Remove a Policy: Simply select the Index then hit the **Delete** button to remove from the list.

Time Schedule

The Time Schedule supports up to **16** timeslots which helps you to manage your Internet connection. In each time profile, you may schedule specific day(s) i.e. Monday through Sunday to restrict or allowing the usage of the Internet by users or applications.

This Time Schedule correlates closely with router’s time, since router does not have a real time clock on board; it uses the Simple Network Time Protocol (SNTP) to get the current time from an SNTP server from the Internet.

Time Schedule							
Rule Index	1 ▾						
Rule Name	TimeSlot1						
	Mon.	Tues.	Wed.	Thur.	Fri.	Sat.	Sun.
Day of Week	<input type="checkbox"/>	<input type="checkbox"/>	<input type="checkbox"/>	<input type="checkbox"/>	<input type="checkbox"/>	<input type="checkbox"/>	<input type="checkbox"/>
Start Time	00:00	00:00	00:00	00:00	00:00	00:00	00:00
End Time	00:00	00:00	00:00	00:00	00:00	00:00	00:00
Save							

Time Index: The rule indicator (0-15) for identifying each timeslot.

Name: User-defined identification for each time period.

Day of Week: Mon. to Sun. Specify the time interval for each timeslot from “Day of Week”.

Start Time: The starting point of the interval for the timeslot, anytime in 00:00 – 24:00.

End Time: The ending point of the interval for the timeslot, anytime in 00:00 – 24:00.

Click **Save** to apply your settings.

Example, you can add a timeslot named “TimeSlot1” which features a period from 9:00 of Monday to 18:00 of Tuesday.

Time Schedule							
Rule Index	0 ▾						
Rule Name	TimeSlot1						
	Mon.	Tues.	Wed.	Thur.	Fri.	Sat.	Sun.
Day of Week	<input checked="" type="checkbox"/>	<input checked="" type="checkbox"/>	<input type="checkbox"/>	<input type="checkbox"/>	<input type="checkbox"/>	<input type="checkbox"/>	<input type="checkbox"/>
Start Time	09:00	00:00	00:00	00:00	00:00	00:00	00:00
End Time	24:00	18:00	00:00	00:00	00:00	00:00	00:00
Save							

Another TimeSlot2 spanning from 09:00 to 18:00 of Wednesday

Time Schedule							
Rule Index	1 ▾						
Rule Name	TimeSlot2						
	Mon.	Tues.	Wed.	Thur.	Fri.	Sat.	Sun.
Day of Week	<input type="checkbox"/>	<input type="checkbox"/>	<input checked="" type="checkbox"/>	<input type="checkbox"/>	<input type="checkbox"/>	<input type="checkbox"/>	<input type="checkbox"/>
Start Time	00:00	00:00	09:00	00:00	00:00	00:00	00:00
End Time	00:00	00:00	18:00	00:00	00:00	00:00	00:00
Save							

Mail Alert

Mail alert is designed to keep system administrator or other relevant personnel alerted of any unexpected events that might have occurred to the network computers or server for monitoring efficiency. With this alert system, appropriate solutions may be tackled to fix problems that may have arisen so that the server can be properly maintained.

Mail Alert	
Server Information	
SMTP Server	<input type="text"/>
Username	<input type="text"/>
Password	<input type="password" value="....."/>
Sender's E-mail	<input type="text"/> (Must be XXX@yyy.zzz)
SSL/TLS	<input type="checkbox"/> Enable
Port	<input type="text" value="25"/> (1~65535)
<input type="button" value="Account Test"/>	
WAN IP Change Alert	
Recipient's E-mail	<input type="text"/> (Must be XXX@yyy.zzz)
4G/LTE Usage Allowance	
Recipient's E-mail	<input type="text"/> (Must be XXX@yyy.zzz)
<input type="button" value="Apply"/>	

Server Information

SMTP Server: Enter the SMTP server that you would like to use for sending emails.

Username: Enter the username of your email account to be used by the SMTP server.

Password: Enter the password of your email account.

Sender's Email: Enter your email address.

SSL/TLS: Check to whether to enable SSL encryption feature.

Port: the port, default is 25.

Account Test: Click the button to test the connectivity and feasibility to your sender's e-mail.

WAN IP Change Alert

Recipient's Email (WAN IP Change Alert): Enter a valid e-mail address to receive an alert message when WAN IP change has been detected.

Recipient's Email (3G/4G-LTE Usage Allowance): Enter a valid e-mail address to receive an alert message when the 3G or 4G/LTE over Usage Allowance occurs.

Click **Apply** button to save settings

Serial (RS-232 Console Port)

Here is the Serial RS-232 console configuration to connect with any existing industrial machine.

Serial	
General Settings	
Baud Rate	115200 ▼
Data Bits	8 bits ▼
Parity	None ▼
Stop Bits	1 bit ▼
Application	
Mode	Disabled ▼
<input type="button" value="Save"/>	

General Settings

Baud Rate: Specify the desire baud rate (speed) run on this serial port

Data Bits: Specify the number of data bits contained in a frame

Parity: A simple form of error detection in a frame

Stop Bits: Specify the stop bits of a frame

Application

Mode: Select one of the mode from the list, **Disable / Modbus/TCP / UDP Server / UDP Client / TCP Server / TCP Client / Telnet Server / SSH Server.**

- ▶ **Disable:** Disable the serial port, RS-232.
- ▶ **Modbus/TCP:** Modbus is a master/slave communication uses IP over Ethernet to carry data between devices/machines

Mode	Modbus/TCP ▼
Port	502
Response Timeout	3000 ms

- **Port:** Generally uses port 502, master and slave must use the same port. Specify port other than port 502 if desired.
- **Response Timeout (ms):** Specify a response time-out in milliseconds. After the response timeout expires, default is in 3000ms (3 seconds), data transactions will get aborted.

Here are the possible causes for a timeout to occur:

- Serial connection errors between the MX-230 M1 and the serial device
- Hardware issue with the Serial device
- Serial device response time is longer than the specified Response Timeout value. Increase the time-out value to see if it helps

▶ **UDP Server:**

Application	
Mode	UDP Server ▼
Port	782
Save	

- **Port:** Default used 782 (tcp/udp) port for UDP Server. Specify a tcp/udp port other than port 782 if needed.

▶ **UDP Client:**

Application	
Mode	UDP Client ▼
Remote Host Name / IP	
Port	782
Save	

- **Port:** Default used 782 (tcp/udp) port for UDP Client. Specify a tcp/udp port other than port 782 if needed.
- **Remote Host Name / IP:** Enter either remote server's name or IP address.

▶ **TCP Server:**

Mode	TCP Server ▼
Port	782
Empty Serial Buffer When TCP Connection is Established	<input checked="" type="radio"/> Yes <input type="radio"/> No
Data Packet Delimitier	<input type="radio"/> Inter-character Time Gap <input type="text" value="1000"/> msec(1~30000) <input checked="" type="radio"/> Characters <input type="text" value="0x0d0a"/> ("0x"+Hex Code,e.g. "0x0d" or "0x0d0a")
TCP Idle Timeout	<input type="text" value="60"/> seconds (10~180)
Save	

- **Port:** Default used 782(tcp/udp) for TCP Server. Specify a tcp/udp port other than port 782 if needed.
- **Empty Serial Buffer When TCP Connection is Established:** When TCP link connection is established, serial buffer will get deleted. Enable to empty the buffer after TCP connection is up.
- **Data packet Delimitier:** A way to keep packets in tract.
 - **Inter-character Time Gap:** Default time is in 1000ms. After time has reached, serial data will be transmitted. Time range from 1 – 30000ms.
 - **Character Delimitier:** Default characters are 0x0d0a. Serial data will get transmitted when seeing the specified character(s), in this case, 0x0d0a. Valid characters “0x” + Hex code
- **TCP Idle Timeout (Seconds):** Default time is in 60 seconds. Specify an idle time-out in

seconds. After the timeout expires, meaning no data transmission within the defined time, serial connection will get aborted. Time range from 10 – 180 seconds

► **TCP Client:**

Mode	TCP Client ▼
Remote Host Name / IP	<input type="text"/>
Port	<input type="text" value="782"/>
Empty Serial Buffer When TCP Connection is Established	<input checked="" type="radio"/> Yes <input type="radio"/> No
Data Packet Delimiter	<input type="radio"/> Inter-character Time Gap <input type="text" value="1000"/> msec(1~30000)
	<input checked="" type="radio"/> Characters <input type="text" value="0x0d0a"/> ("0x"+Hex Code,e.g. "0x0d" or "0x0d0a")
TCP Idle Timeout	<input type="text" value="60"/> seconds (10~180)
<input type="button" value="Save"/>	

- **Remote Host Name / IP:** Enter either TCP server’s name or IP address.
- **Port:** Default used 782(tcp/udp) for TCP Client. Specify a tcp/udp port other than port 782 if needed.
- **Empty Serial Buffer When TCP Connection is Established:** When TCP link connection is established, serial buffer will get deleted. Enable to empty the buffer after TCP connection is up.
- **Data packet Delimiter:** A way to keep packets in tract.
 - **Inter-character Time Gap:** Default time is in 1000ms. After time has reached, serial data will be transmitted. Time range from 1 – 30000ms.
 - **Character Delimiter:** Default characters are 0x0d0a. Serial data will get transmitted when seeing the specified character(s), in this case, 0x0d0a. Valid characters “0x” + Hex code.
- **TCP Idle Timeout (Seconds):** Default time is in 60 seconds. Specify an idle time-out in seconds. After the timeout expires, meaning no data transmission within the defined time, serial connection will get aborted. Time range from 10 – 180 seconds.

► **Telnet Server:**

Mode	Telnet Server ▼
Port	<input type="text" value="782"/>
<input type="button" value="Save"/>	

- **Port:** Default used 782(tcp/udp) for Telnet Server. Specify a tcp/udp port other than port 782 if needed. Port 23 is being reserved, don’t use this port.

Note: MX-230 M1 uses port 23 as default port the embedded Telnet server.

▶ **SSH Server:**

Mode	SSH Server ▼
Port	782
<input type="button" value="Save"/>	

- **Port:** Default use 782(tcp/udp), for SSH Server. Specify a tcp/udp port other than port 782 if needed. Port 22 is being reserved, don't use this port.

Note: MX-230 M1 uses port 22 as default port the embedded SSH server.

Click **Save** to apply settings

Access Management

Device Management

Device Management	
Device Host Name	
Host Name	<input type="text" value="home.gateway"/>
<input type="button" value="Save"/>	
Embedded Web Server	
HTTP Port	<input type="text" value="80"/> (The default HTTP port number is 80.)
HTTPS Port	<input type="text" value="443"/> (The default HTTPS port number is 443.)
HTTPS Server Certificate Index	<input type="text" value="Default"/>
<input type="button" value="Save"/>	

Device Host Name

Host Name: Enter the host name of the router. Default is **home.gateway**

Embedded Web Server

HTTP Port: It is the embedded web server (Web GUI) accessing port, default is **80**. It can be changed other port other than port 80, e.g. port **8080**.

HTTPS Port: Similar to HTTP which is an unencrypted communication using port 80. HTTPS is encrypted by SSL using port 443 instead.

HTTPS Server Certificate Index: *HTTPS* known as HTTP-over-SSL tunnel protocol. Select a certificate to identify the system web server. When accessing to the web server (Web GUI), the browser will issue a warning page.

To import certificates, go to **Maintenance >> Certificate Management** to upload files. Otherwise, select **Default** certificate and CA.

Click **Save** to apply settings.

SNMP

Simple Network Management Protocol (SNMP) is a protocol used for exchanging management information between network devices. The MX-230 M1 serves as a SNMP agent that allows a manager station to manage and monitor the router through the network.

SNMP	
SNMP	<input type="radio"/> Activated <input checked="" type="radio"/> Deactivated
Get Community	<input type="text"/>
Set Community	<input type="text"/>
Trap Manager IP	<input type="text" value="0.0.0.0"/>
System Name	<input type="text"/>
System Location	<input type="text"/>
System Contact	<input type="text"/>
SNMPv3	
SNMPv3	<input type="radio"/> Enable <input checked="" type="radio"/> Disable
Username	<input type="text"/>
Access Permissions	Read Only ▾
Authentication Protocol	MD5 ▾
Authentication Key	<input type="text"/> (8~31 characters)
Privacy Protocol	DES ▾
Privacy Key	<input type="text"/> (8~31 characters)
<input type="button" value="Save"/>	

SNMP: Activate to enable SNMP.

Get Community: Type the Get Community, which is the password for the incoming Get-and-GetNext requests from the management station.

Set Community: Type the Set Community, which is the password for incoming Set requests from the management station.

Trap Manager IP: Enter the IP of the server receiving the trap message (when some exception occurs) sent by this SNMP agent.

System Name / Location / Contact: String descriptions of the SNMP agent.

SNMPv3

SNMPv3: Enable to activate the SNMPv3.

User Name: Enter the name allowed to access the SNMP agent.

Access Permissions: Set the access permissions for the user; RO--read only and RW--read and writer.

Authentication Protocol: Select the authentication protocol, MD5 and SHA. SNMP agent can communicate with the manager station through authentication and encryption to secure the message exchange. Set the authentication and encryption information here and below.

Authentication Key: Set the authentication key, 8-31 characters.

Privacy Protocol: Select the privacy mode, DES and AES.

Privacy Key: Set the privacy key, 8-31 characters.

Click **Save** to apply settings.

Syslog

Use the Syslog to collect system event information to a remote log server.

▼ Syslog	
Remote System Log	<input type="radio"/> Activated <input checked="" type="radio"/> Deactivated
Server IP Address	<input type="text" value="0.0.0.0"/>
Server UDP Port	<input type="text" value="514"/>
<input type="button" value="Save"/>	

Remote System Log: Select **Activated** to enable this feature

Server IP Address: Assign the remote log server IP address.

Server UDP Port: Assign the remote log server port, 514 is commonly used.

Click **Save** to apply settings.

Universal Plug & Play

UPnP offers peer-to-peer network connectivity for PCs and other network devices, along with control and data transfer between devices. UPnP offers many advantages for users running NAT routers through UPnP NAT Traversal, and on supported systems makes tasks such as port forwarding much easier by letting the application control the required settings, removing the need for the user to control advanced configuration of their device.

Both the user's Operating System and the relevant application must support UPnP in addition to the router.

▼ Universal Plug & Play	
UPnP	<input type="radio"/> Activated <input checked="" type="radio"/> Deactivated
Auto-configured	<input type="radio"/> Activated <input checked="" type="radio"/> Deactivated (by UPnP-enabled Application)
<input type="button" value="Save"/>	

UPnP: Select this checkbox to activate UPnP. Be aware that anyone could use an UPnP application to open the web configuration's login screen without entering the MX-230 M1's IP address

Auto-configured: Select this check box to allow UPnP-enabled applications to automatically configure the MX-230 M1 so that they can communicate through the MX-230 M1, for example by using NAT traversal, UPnP applications automatically reserve a NAT forwarding port in order to communicate with another UPnP enabled device; this eliminates the need to manually configure port forwarding for the UPnP enabled application.

Click **Save** to apply settings.

Dynamic DNS (DDNS)

The Dynamic DNS function allows you to alias a dynamic IP address to a static hostname, allowing users whose ISP does not assign them a static IP address to use a domain name. This is especially useful for hosting servers via your internet connection, so that anyone wishing to connect to you may use your domain name, rather than having to use your dynamic IP address, which changes from time to time. This dynamic IP address is the WAN IP address of the router, which is assigned to you by your ISP.

Here users can register different WAN interfaces with different DNS Providers.

If you do not have a DDNS account, please choose a DDNS Service Provider from the list then go to their website to create an account first.

Dynamic DNS	
Dynamic DNS	<input type="radio"/> Activated <input checked="" type="radio"/> Deactivated
Service Provider	www.dyndns.org (dynamic) ▼
My Host Name	<input type="text"/>
Username	<input type="text"/>
Password	<input type="text"/>
Wildcard support	<input type="radio"/> Yes <input checked="" type="radio"/> No
Period	25 Day(s) ▼
<input type="button" value="Save"/>	

Dynamic DNS: Select this check box to activate Dynamic DNS.

Service Provider: Select from drop-down menu for the appropriate service provider, for example: www.dyndns.org.

My Host Name: Type the domain name assigned to your MX-230 M1 by your Dynamic DNS provider.

Username / Password: Enter the user name and password of the account you created with this service provider.

Wildcard support: Select this check box to enable DYNDNS Wildcard.

Period: Set the time period on how often the MX-230 M1 will update the DDNS server with your current external IP address.

Click **Save** to apply settings.

Example: How to register a DDNS account

If you do not have an account with Dynamic DNS, please go to www.dyndns.org to register an account first.

User **test1** register a Dynamic Domain Names in DDNS provider <http://www.dyndns.org/>.

DDNS: www.hometest.com using username/password test/test

Dynamic DNS	
Dynamic DNS	<input checked="" type="radio"/> Activated <input type="radio"/> Deactivated
Service Provider	www.dyndns.org (dynamic) ▼
My Host Name	myhome.dyndns.org
Username	myhome-123
Password	*****
Wildcard support	<input type="radio"/> Yes <input checked="" type="radio"/> No
Period	25 Day(s) ▼
<input type="button" value="Save"/>	

Access Control

Access Control Listing allows you to determine which services/protocols can access the MX-230 M1 interface from which computers. It is a management tool aimed to allow IPs (set in secure IP address) to access specified embedded applications (Web, etc., user can set) through some specified interface (LAN, WAN or both). User can have an elaborate understanding in the examples below.

The maximum number of entry is **16**.

▼ Access Control

Access Control Activated Deactivated

Access Control Editing

Rule Index: ▼

Active: Yes No

Secure IP Address: ~ (0.0.0.0 ~ 0.0.0.0 means all IPs)

Application: ▼

Interface: ▼

Access Control Listing

Index	Active	Secure IP Address	Application	Interface
0	Yes	0.0.0.0-0.0.0.0	ALL	LAN
1	Yes	0.0.0.0-0.0.0.0	Ping	WAN

Access Control: Select whether to make Access Control function available.

Rule Index: The numeric rule indicator.

Active: **Yes** to activate the rule.

Secure IP Address: The default 0.0.0.0 allows any client to use this service to manage the MX-230 M1. Type an IP address range to restrict access to the client(s) without a matching IP address.

Application: Choose a service that you want to all access to all the secure IP clients. The drop-down menu lists all the common used applications.

Interface: Select the access interface. Choices are **LAN**, **WAN** and **Both**.

Click **Save** to apply settings.

By default, the “Access Control” has **two default rules**.

Default Rule 1: (Index 1), a rule to allow only clients from LAN to have access to all embedded applications (Web, FTP, etc.). Under this situation, clients from WAN cannot access the router even from Ping.

Access Control

Access Control Activated Deactivated

Access Control Editing

Rule Index: 1 ▼

Active: Yes No

Secure IP Address: 0.0.0.0 ~ 0.0.0.0 (0.0.0.0 ~ 0.0.0.0 means all IPs)

Application: ALL ▼

Interface: LAN ▼

Access Control Listing

Index	Active	Secure IP Address	Application	Interface
1	Yes	0.0.0.0-0.0.0.0	ALL	LAN
2	Yes	0.0.0.0-0.0.0.0	Ping	WAN



Default Rule 2: (Index 2), an ACL rule to open Ping to WAN side.

Access Control

Access Control Activated Deactivated

Access Control Editing

Rule Index: 1 ▼

Active: Yes No

Secure IP Address: 0.0.0.0 ~ 0.0.0.0 (0.0.0.0 ~ 0.0.0.0 means all IPs)

Application: ALL ▼

Interface: LAN ▼

Access Control Listing

Index	Active	Secure IP Address	Application	Interface
1	Yes	0.0.0.0-0.0.0.0	ALL	LAN
2	Yes	0.0.0.0-0.0.0.0	Ping	WAN



Packet Filter

You can filter the packages by MAC address, IP address, Protocol, Port number and Application or URL.

❖ Filter Type - IP & MAC Filter

Packet Filter

Filter Type: IP & MAC Filter ▼

IP & MAC Filter Editing

Action: Black List ▼

Rule Index: 1 ▼

Individual Active: Yes No

Interface: 4G/LTE ▼

Direction: Both ▼

Type: IPv4 ▼

Source IP Address: 0.0.0.0 (0.0.0.0 means Don't care)

Source Subnet Mask: 0.0.0.0

Source Port Number: 0 (0 means Don't care)

Destination IP Address: 0.0.0.0 (0.0.0.0 means Don't care)

Destination Subnet Mask: 0.0.0.0

Destination Port Number: 0 (0 means Don't care)

DSCP: 64 (Value Range:0~64, 64 means Don't care)

Protocol: Any ▼

Time Schedule: Always ▼

Save Delete

IP & MAC Filter List

Index	Active	Interface	Direction	Source IP(IPv6) Address/Mask(Prefix)	Destination IP(IPv6) Address/Mask(Prefix)	Source MAC Address	Source Port	Destination Port	DSCP	Protocol
-------	--------	-----------	-----------	---	--	--------------------------	----------------	---------------------	------	----------

IP & MAC Filter Editing

Rule Index: The numeric rule indicator.

Individual Active: **Yes** to enable the rule.

Action: This is how to deal with the packets matching the rule. Allow please select White List or block selecting Black List.

Interface: Select to determine which interface the rule will be applied to.

Direction: Select to determine whether the rule applies to outgoing packets, incoming packets or packets of both directions.

Type: Choose type of field you want to specify to monitor. Select “IPv4” for IPv4 address, port number and protocol. Select “IPv6” for IPv6 address, port number and protocol. Select “MAC” for MAC address

► **IPv4 (Cont.)**

Source IP Address	<input type="text" value="0.0.0.0"/>	<small>(0.0.0.0 means Don't care)</small>
Source Subnet Mask	<input type="text" value="0.0.0.0"/>	
Source Port Number	<input type="text" value="0"/>	<small>(0 means Don't care)</small>
Destination IP Address	<input type="text" value="0.0.0.0"/>	<small>(0.0.0.0 means Don't care)</small>
Destination Subnet Mask	<input type="text" value="0.0.0.0"/>	
Destination Port Number	<input type="text" value="0"/>	<small>(0 means Don't care)</small>
DSCP	<input type="text" value="0"/>	<small>(Value Range:0~64, 64 means Don't care)</small>
Protocol	<input type="text" value="TCP"/> ▼	

Source IP Address: The source IP address of packets to be monitored. 0.0.0.0 means “Don’t care”.

Source Subnet Mask: Enter the subnet mask of the source network.

Source Port Number: The source port number of packets to be monitored. 0 means “Don’t care”.

Destination IP Address: The destination IP address of packets to be monitored. 0.0.0.0 means “Don’t care”.

Destination Subnet Mask: Enter the subnet mask of the destination network.

Destination Port Number: This is the Port that defines the application. (E.g. HTTP is port 80.)

DSCP: DSCP: Differentiated Services Code Point, it is recommended that this option be configured by an advanced user or keep 0. (0 means Don’t care.)

Protocol: Specify the packet type (TCP, UDP, ICMP, and ICMPv6) that the rule applies to.

► **IPv6**

Source IPv6 Address	<input type="text" value="0:0:0:0:0:0:0:0"/>	<small>(0:0:0:0:0:0:0:0 means Don't care)</small>
Source IPv6 Prefix	<input type="text" value="32"/>	
Source Port Number	<input type="text" value="0"/>	<small>(0 means Don't care)</small>
Destination IPv6 Address	<input type="text" value="0:0:0:0:0:0:0:0"/>	<small>(0:0:0:0:0:0:0:0 means Don't care)</small>
Destination IPv6 Prefix	<input type="text" value="32"/>	
Destination Port Number	<input type="text" value="0"/>	<small>(0 means Don't care)</small>
DSCP	<input type="text" value="0"/>	<small>(Value Range:0~64, 64 means Don't care)</small>
Protocol	<input type="text" value="TCP"/> ▼	

Source IP (IPv6) Address/ Prefix: The source IP address or range of packets to be monitored.

Source Port Number: The source port number of packets to be monitored.

Destination IP (IPv6) Address/ Prefix: The destination subnet IP address.

Destination Port Number: This is the Port or Port Ranges that defines the application.

DSCP: show the set DSCP.

Protocol: It is the packet protocol type used by the application. Select either **TCP** or **UDP** or

ICMP or ICMPv6

▶ **MAC**

Type	MAC ▼
Source MAC Address	<input type="text"/>

Source MAC Address: show the MAC address of the rule applied.

Time Schedule: Select a TimeSlot to activate the rule. Go to [Time Schedule](#) to configure a time control first.

Click **Save** to apply settings.

❖ Filter Type- URL Filter

▼ Packet Filter	
Packet Filter	
Filter Type	URL Filter ▼
URL Filter Editing	
URL Filter Rule Index	1 ▼
Individual Active	<input type="radio"/> Yes <input checked="" type="radio"/> No
URL (Host)	<input type="text"/>
Time Schedule	Always ▼
<input type="button" value="Save"/> <input type="button" value="Delete"/>	
URL Filter Listing	
Index	Active
URL	

URL Filter: Select **Activated** to enable URL Filter.

URL Filter Rule Index: The numeric rule indicator.

Individual Active: To give control to the specific URL access individually, for example, you want to prohibit access to www.yahoo.com, please first press Activated in “URL Filter” field, and also Yes in “Individual Active” field; if some time you want to allow access to this URL, you simply select No in individual active field. In a word, the command serves as a switch to the access of some specific URL with the filter on.

URL (Host): Specified URL which is prohibited from accessing.

Time Schedule: Select a TimeSlot to activate the rule. Go to [Time Schedule](#) to configure a time control first.

Click **Save** to apply settings.

CWMP (TR-069)

CWMP, short for CPE WAN Management Protocol, also called TR069 is a Broadband Forum technical specification entitled CPE WAN Management Protocol (CWMP). It defines an application layer protocol for remote management of end-user devices. It defines an application layer protocol for remote management of end-user devices.

As a bidirectional SOAP/HTTP based protocol it can provides the communication between customer premises equipment (CPE) and Auto Configuration Server (ACS). It includes both a safe configuration and the control of other CPE management functions within an integrated framework. In the course of the booming broadband market, the number of different internet access possibilities grew as well (e.g. modems, routers, gateways, set-top box, VoIP-phones).At the same time the configuration of this equipment became more complicated –too complicated for end-users. For this reason, TR-069 was developed. It provides the possibility of auto configuration of the access types. Using TR-069 the terminals can get in contact with the Auto Configuration Servers (ACS) and establish the configuration automatically and let ACS configure CPE automatically.

CWMP (TR-069)	
CWMP	<input type="radio"/> Activated <input checked="" type="radio"/> Deactivated
ACS Login Information	
URL	<input type="text" value="http://cpe.bectechnologies.com/comserver/node1/tr069"/>
Username	<input type="text" value="testcpe"/>
Password	<input type="text" value="ac5entry"/>
Connection Request Information	
Path	<input type="text"/>
Username	<input type="text" value="conexant"/>
Password	<input type="text" value="welcome"/>
Periodic Inform Config	
Periodic Inform	<input checked="" type="radio"/> Activated <input type="radio"/> Deactivated
Interval	<input type="text" value="870"/>
Bind Wan Interface	
Interface	<input type="text" value="Auto"/>
NATT Config	
NATT Server	<input type="text"/>
NATT Period	<input type="text"/>
<input type="button" value="Save"/>	

CWMP: Select activated to enable CWMP.

ACS Login Information

URL: Enter the ACS server login URL.

User Name: Specify the ACS User Name for ACS authentication to the connection from CPE.

Password: Enter the ACS server login password.

Connection Request Information

Path: Local path in HTTP URL for an ACS to make a Connection Request notification to the CPE.

Username: Username used to authenticate an ACS making a Connection Request to the CPE.

Password: Password used to authenticate an ACS making a Connection Request to the CPE.

Periodic Inform Config

Periodic Inform: Select Activated to authorize the router to send an Inform message to the ACS automatically.

Interval(s): Specify the inform interval time (sec) which CPE used to periodically send inform message to automatically connect to ACS. When the inform interval time arrives, the CPE will send inform message to automatically connect to ACS.

Bind WAN Interface

Interface: Specify any available or a single WAN interface to handle TR-069 requests.

NATT Config - This is a proprietary feature provided by BEC. May leave them in blank, no configuration is required.

NATT Server: By BEC administrator only.

NATT Period: By BEC administrator only.

Click **Save** to apply settings.

Parental Control

This feature provides Web content filtering offering safer and more reliable web surfing for users especially for parents to protect network security and control the contents for children at home.

Parental Control	
Provider	www.opendns.com
Parental Control	<input type="radio"/> Activated <input checked="" type="radio"/> Deactivated
Host Name	<input type="text"/>
Username	<input type="text"/>
Password	<input type="text"/>
**Parental Control provides Web content filtering while surfing the web safer and more reliable. Please get an account and configure at the selected Provider in advance.	
<input type="button" value="Save"/>	

To activate this feature, please log on to www.opendns.com to get an OpenDNS account first.

Parent Control Provider: Hosted by www.opendns.com

Parent Control: Enable the feature by clicking the **Activated**

Host Name: It is the domain name of your OpenDNS. If you don't have one, please leave it blank.

Username / Password: Put down your OpenDNS account username and password

Click **Save** to apply settings.

BECentral Management

BECentral is a cloud-based device management platform that provides operators with a comprehensive suite of services to manage devices in real-time.

▼ BECentral Management

BECentral Management	<input type="radio"/> Activated <input checked="" type="radio"/> Deactivated
BECentral Management URL	<input type="text" value="becentral.becloud.io"/>
BECentral Management Port	<input type="text" value="48883"/>
Organization ID	<input type="text" value="DEFAULT"/>
Tag ID	<input type="text"/>
Device Report Interval	<input type="text" value="480"/>
Interface	<input type="text" value="ALL"/>
<input type="button" value="Save"/>	

BECentral Management: Activate to enable the feature.

BECentral Management URL: Access path to the BECentral.

BECentral Management Port: Port listened by the BECentral.

Organization ID: Customer ID (By BE C administrator only)

Tag ID: By BEC administrator only.

Device Report Interval: Enter the interval time in seconds to send inform message periodically to the BECentral.

Interface: Specify any available or a single WAN interface to handle BECentral requests.

Maintenance

User Management

User Management provides the Administrator with the ability to grant access control and manage GUI login credentials for each user.

There are two access management levels, Administrator and User.

The default root account, Administrator (admin), has full access to all the features listed and ability to create other accounts with features to allow other users to access to. The User account is with limited access (specified by advanced users with admin account) to the GUI.

Total of **8** accounts can be created to grant access to manage the MX-230 M1 via the web page.

❖ Administrator Account

admin/admin is the root/default account username and password.

NOTE: This username / password may vary by different Internet Service Providers.

Login using the Administrator account, you will have the full accessibility to manage & control your gateway device and can also create user accounts for others to control some of the open configuration settings.

User Management	
User Account	
Index	1 ▼
Username	admin
New Password
Confirm Password
<input type="button" value="Save"/> <input type="button" value="Delete"/>	
User Account Listing	
Index	User Name
1	admin
2	user

User Setup

Index: The numeric account indicator. The maximum entry is up to 8 accounts.

User Name: Create account(s) user name for GUI management.

New Password: Enter a new password for this user account.

Confirmed Password: Re-enter the new password again; you must enter the password exactly the same as in the previous field

❖ **User Account**

user/user is the default user account username and password

NOTE: This username / password may vary by different Internet Service Providers.

User Management	
User Account	
Index	2 ▼
Username	user
New Password
Confirm Password
Web GUI Permission	
Guest Account	<input type="radio"/> Enable <input checked="" type="radio"/> Disable
Interface Setup	<input checked="" type="radio"/> Enable <input type="radio"/> Disable
Advanced Setup	<input checked="" type="radio"/> Enable <input type="radio"/> Disable
VPN Setup	<input checked="" type="radio"/> Enable <input type="radio"/> Disable
Access Management	<input checked="" type="radio"/> Enable <input type="radio"/> Disable
Maintenance	<input checked="" type="radio"/> Enable <input type="radio"/> Disable
<input type="button" value="Save"/> <input type="button" value="Delete"/>	

User Account Setup

Index #: The numeric account indicator. The maximum entry is up to 8.

Username: Create account(s) user name for GUI management.

New Password: Password for the user account.

Confirm Password: Re-enter the password.

Web GUI Permission

Guest Account: Enable to create this new guest account.





Interface Setup / Advanced Setup / Access Management / Maintenance: Enable to grant this user access to these features.





When someone accesses to the MX-230 M1 using this “user” account, he/she can only manage and configure the features that is pre-selected in **Web GUI Permission** for this account.

Click **Save** to apply settings.

Certificate Management

This feature is used for HTTPS Server authentication of the device using certificate. If the imported certificate doesn't match the authorized certificate with the Server then no access is allowed.

Local Certificate Listing			
Index	Certificate Name	Edit	Delete
1			
2			

Trusted CA Listing			
Index	Certificate Name	Edit	Delete
1			
2			

Edit: Click  (Edit) to import a certificate.

Delete: Click  (Delete) to remove the certificate from the list.

Local Certificate Listing

Local Certificate

Index	1 ▼		
Certificate Name	<input style="width: 90%;" type="text"/>		
	<input type="checkbox"/> PKCS12		
Certificate File	<input type="button" value="Choose File"/> No file chosen	<input type="button" value="Upload"/>	(Please upload Certificate File.)
Private Key File	<input type="button" value="Choose File"/> No file chosen	<input type="button" value="Upload"/>	(Please upload Private Key File.)
Password	<input style="background-color: #ffff00;" type="password" value="....."/>		

After clicked "Upload", please wait for 5 seconds and then click "Apply".

Index #: The numeric account indicator. The maximum entry is up to 2.

Certificate Name: Description of the certificate.

PKCS12: Every certificate is accompanied by a private key. Upload both files if PKCS is disabled. Enable PKCS12 to put Certificate & Private Key in the same file, like *.p12, *.pfx.

Certificate File: Browse to locate the target certificate file on PC before uploading it.

Private Key File: Browse to locate the target file on PC before uploading it. If PKCS enabled, please ignore this setting.

Password: Enter the password if any, which is used to protect the private key. Otherwise, leave it empty.

Click **Apply** to save settings.

Trusted CA Listing

▼ Trusted CA	
Index	1 ▼
CA Name	<input type="text"/>
CA Certificate File	<input type="button" value="Choose File"/> No file chosen <input type="button" value="Upload"/> (Please upload CA Certificate File.)
After clicked "Upload", please wait for 5 seconds and then click "Apply".	
<input type="button" value="Apply"/> <input type="button" value="Back"/>	

Index #: The numeric account indicator. The maximum entry is up to 2.

CA Name: Description of the CA.

CA Certificate File: Browse to locate the target certificate file on PC before uploading it.

Click **Apply** to save settings.

Time Zone

With default, MX-230 M1 does not contain the correct local time and date.

There are several options to setup, maintain, and configure current local time/date on the MX-230 M1. If you plan to use **Time Schedule** feature, it is extremely important you set up the Time Zone correctly.

Time Zone	
Current Date/Time	N/A (Can't find NTP server)
Time Synchronization	
Synchronize time with	<input checked="" type="radio"/> NTP Server <input type="radio"/> PC's Clock <input type="radio"/> Manually
Time Zone	(GMT-06:00) Central Time (US & Canada), Maxico City, Saskatchewan ▾
Daylight Saving	<input type="radio"/> Enabled <input checked="" type="radio"/> Disabled
NTP Server Address	0.0.0.0 (0.0.0.0: Default Value)
<input type="button" value="Save"/>	

Synchronize time with: Select the methods to synchronize the time.

- ▶ **NTP Server automatically:** To synchronize time with the SNTP servers to get the current time from an SNTP server outside your network then choose your local time zone. After a successful connection to the Internet, MX-230 M1 will retrieve the correct local time from the SNTP server this is specified.
- ▶ **PC's Clock:** To synchronize time with the PC's clock.
- ▶ **Manually:** Select this to enter the SNMP server IP address manually.
 - ◆ **Date:** Month / Date / Year. Month – 1 ~ 12 (January ~ December).
 - ◆ **Time:** Hour: Minute: Second

Time Zone: Choose the time zone of your location. This will set the time difference between your time zone and Greenwich Mean Time (GMT).

Daylight Saving: Select this option if you use daylight savings time.

NTP Server Address: Enter the IP address of your time server. Check with your ISP/network administrator if you are unsure of this information.

Click **Save** to apply settings.

Firmware & Configuration

Firmware is the software that controls the hardware and provides all functionalities which are available in the GUI. This software may be improved and/or modified; your MX-230 M1 provides an easy way to update the code to take advantage of the changes. .

To upgrade the firmware of the MX-230 M1, you should download or copy the firmware to your local environment first. Click “**Choose File**” to specify the path of the firmware file. Then, click “**Upgrade**” to start upgrading process. After completing the firmware upgrade, the MX-230 M1 will automatically restart and run the new firmware.

Firmware & Configuraiton	
Upgrade	<input checked="" type="radio"/> Firmware <input type="radio"/> Configuration
System Restart with	<input checked="" type="radio"/> Current Settings <input type="radio"/> Factory Default Settings
File	<input type="button" value="Choose File"/> No file chosen
Backup Configuration	<input type="button" value="Backup"/>
Status	
It might take several minutes, don't power off it during upgrading. Device will restart after the upgrade.	
<input type="button" value="Upgrade"/>	

Upgrade: Choose Firmware or Configuration you want to update.

System Restart with:

- ▶ **Current Settings:** Restart the device with the current settings automatically when finishing upgrading.
- ▶ **Factory Default Settings:** Restart the device with factory default settings automatically when finishing upgrading.

File: Type in the location of the file you want to upload in this field or click **Browse** to find it.

Choose File: Click “**Choose File**” to find the configuration file or firmware file you want to upload. Remember that you must extract / decompress / unzip the .zip files before you can upload them.

Backup Configuration: Click **Backup** button to back up the current running configuration file and save it to your computer in the event that you need this configuration file to be restored back to your MX-230 M1 device when making false configurations and want to restore to the original settings.

Upgrade: Click “**Upgrade**” to begin the upload process. This process may take up to two minutes.

Firmware Upgrade	
File upload succeeded, starting flash erasing and programming!!	
Progress	<div style="width: 15%; height: 10px; background-color: #0070C0;"></div>
Percent	15 %



DO NOT turn off or power cycle the device while firmware upgrading is still in process.
Improper operation could damage your MX-230 M1.

System Restart

Click **System Restart** with option **Current Settings** to reboot your router.

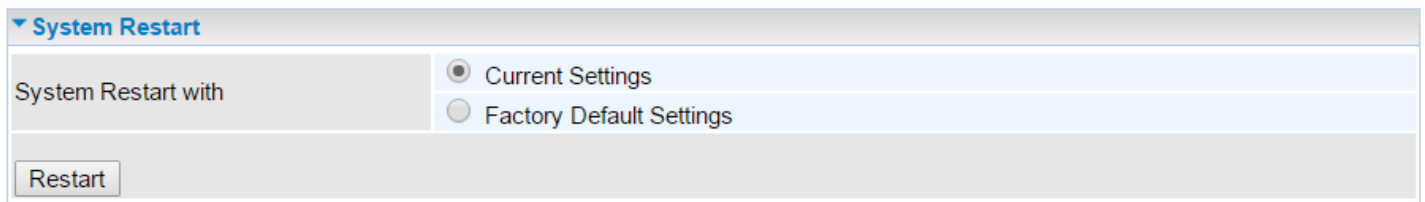

▼ System Restart

System Restart with

Current Settings

Factory Default Settings

Restart

If you wish to restart the router using the factory default settings (for example, after a firmware upgrade or if you have saved an incorrect configuration), select **Factory Default Settings** to restore to factory default settings.

You may also restore your router to factory settings by holding the small Reset pinhole button on the back of your router in about more than 6s seconds whilst the router is turned on.

Auto Reboot

Schedule an automatic reboot for your MX-230 M1 to ensure proper operation and best performance. This reboot will only reboot with current configuration settings and not overwrite any existing settings.

▼ Auto Reboot										
Schedule	1.	<input type="checkbox"/> Enable	<input type="checkbox"/> Mon.	<input type="checkbox"/> Tues.	<input type="checkbox"/> Wed.	<input type="checkbox"/> Thur.	<input type="checkbox"/> Fri.	<input type="checkbox"/> Sat.	<input type="checkbox"/> Sun.	Time 00 : 00
	2.	<input type="checkbox"/> Enable	<input type="checkbox"/> Mon.	<input type="checkbox"/> Tues.	<input type="checkbox"/> Wed.	<input type="checkbox"/> Thur.	<input type="checkbox"/> Fri.	<input type="checkbox"/> Sat.	<input type="checkbox"/> Sun.	Time 00 : 00
Save										

Click **Save** to apply settings

Example: Schedule MX-230 M1 to reboot at 10:00pm (22:00) every weekday (Monday thru Friday) and reboot at 9:00am on Saturday and Sunday.

▼ Auto Reboot										
Schedule	1.	<input checked="" type="checkbox"/> Enable	<input checked="" type="checkbox"/> Mon.	<input checked="" type="checkbox"/> Tues.	<input checked="" type="checkbox"/> Wed.	<input checked="" type="checkbox"/> Thur.	<input checked="" type="checkbox"/> Fri.	<input type="checkbox"/> Sat.	<input type="checkbox"/> Sun.	Time 22 : 00
	2.	<input checked="" type="checkbox"/> Enable	<input type="checkbox"/> Mon.	<input type="checkbox"/> Tues.	<input type="checkbox"/> Wed.	<input type="checkbox"/> Thur.	<input type="checkbox"/> Fri.	<input type="checkbox"/> Sat.	<input type="checkbox"/> Sun.	Time 09 : 00
Save										

Diagnostics Tool

The Diagnostic Test page shows the test results for the connectivity of the physical layer and protocol layer for both LAN and WAN sides.

4G/LTE or EWAN (LAN1)

Diagnostic Tool

WAN Interface	4G/LTE ▼		
Testing Ethernet LAN Connection	N/A		
Ping Primary DNS (N/A)	N/A		
Ping www.google.com	N/A		
Ping other IP Address or Domain	<input type="radio"/> Yes <input checked="" type="radio"/> No	N/A	
Start			
Speed Test ▶	Upload	N/A	Download N/A
Trace Route	<input type="radio"/> Yes <input checked="" type="radio"/> No		
Start Trace Route			

Ping other IP Address: Click **Yes** if you wish to ping other IP address rather than google.com

Click **START:** to begin to diagnose the connection.

Diagnostic Tool

WAN Interface	4G/LTE ▼		
Testing Ethernet LAN Connection	N/A		
Ping Primary DNS (N/A)	N/A		
Ping www.google.com	N/A		
Ping other IP Address	<input type="radio"/> Yes <input checked="" type="radio"/> No	N/A	
Start			

Speed Time: Measure the current uplink and downlink speed rate.

- ▶ Take less than a minute to run the test.

Speed Test

Testing	<div style="width: 100%; height: 15px; background-color: #e0e0e0; position: relative;"> <div style="width: 10%; height: 100%; background-color: #0070c0;"></div> </div>		
---------	---	--	--

- ▶ Result in Uplink / Downlink

Speed Test

Result	NA	NA
Back		

Click **Back** to go back to the Diagnostic Tool.

Trace Route is to display how many hops (also view the exact hops) the packet of data has to take to get to the destination.

Click **Yes**, enter the IP address or domain then **Start Trace Route**.

Trace Route <input checked="" type="radio"/> Yes <input type="radio"/> No	
IP Address or Domain	<input type="text"/>
Max TTL Value	<input type="text" value="16"/> [2-30]
<input type="button" value="Start Trace Route"/>	

IP Address or Domain: Set the destination host (IP, domain name) to be traced.

Max TTL value: Set the max Time to live (TTL) value.

Shown as we “trace” www.billion.com below.

```

Trace www.billion.com

tracert to www.billion.com (125.227.205.188), 16 hops max, 60 byte packets
 1 172.16.1.254 (172.16.1.254) 0.472 ms 0.488 ms 0.643 ms
 2 122.96.153.233 (122.96.153.233) 7.354 ms 7.517 ms 7.704 ms
 3 221.6.12.69 (221.6.12.69) 7.921 ms 8.108 ms 8.256 ms
 4 221.6.1.253 (221.6.1.253) 8.392 ms 8.544 ms *
 5 219.158.99.245 (219.158.99.245) 36.110 ms 36.839 ms 37.001 ms
 6 * * *
 7 * * 219.158.103.26 (219.158.103.26) 40.731 ms
 8 211.72.233.194 (211.72.233.194) 65.969 ms 66.040 ms 66.019 ms
 9 220.128.6.126 (220.128.6.126) 61.726 ms 61.831 ms 61.960 ms
10 220.128.11.170 (220.128.11.170) 61.543 ms 61.583 ms 65.127 ms
11 220.128.17.85 (220.128.17.85) 63.436 ms 62.133 ms 65.862 ms
12 220.128.17.229 (220.128.17.229) 64.695 ms 64.849 ms 65.063 ms
13 168.95.229.145 (168.95.229.145) 61.915 ms 60.715 ms 60.825 ms
14 * * *
15 * * *
16 * * *
    
```

LAN

Diagnostic Tool	
WAN Interface	LAN
Testing Ethernet LAN Connection	N/A
Ping other IP Address or Domain <input type="radio"/> Yes <input checked="" type="radio"/> No	N/A
<input type="button" value="Start"/>	
Speed Test ▶	Upload NA Download NA

Ping other IP Address: Click **Yes** to ping any desired IP address or a domain.

Click **START** to begin to diagnose the connection.

Speed Time: Measure the current uplink and downlink speed rate.

- ▶ Take less than a minute to run the test.

▼ Speed Test

Testing 

▶ Result in Uplink / Downlink

▼ Speed Test

Result

Click **Back** to go back to the Diagnostic Tool.

Chapter 5: Troubleshooting

If your MX-230 M1 is not functioning properly, you can refer to this chapter for simple troubleshooting before contacting your service provider support. This can save you time and effort but if symptoms persist, consult your service provider.

Problems with the Router

Problem	Suggested Action
None of the LEDs is on when you turn on the router	Check the connection between the router and the adapter. If the problem persists, most likely it is due to the malfunction of your hardware. Please contact your service provider or BEC for technical support.
You have forgotten your login username or password	Try the default username "admin" and password "admin". If this fails, you can restore your router to its factory settings by pressing the reset button on the device rear side.

Problem with LAN Interface

Problem	Suggested Action
Cannot PING any PC on LAN	Check the Ethernet LEDs on the front panel. The LED should be on for the port that has a PC connected. If it does not lit, check to see if the cable between your router and the PC is properly connected. Make sure you have first uninstalled your firewall program before troubleshooting.
	Verify that the IP address and the subnet mask are consistent for both the router and the workstations.

Recovery Procedures

Problem	Suggested Action
<p>1. The front LEDs display incorrectly upgrade</p> <p>2. Still cannot access to the router management interface after pressing the RESET button.</p> <p>3. Software / Firmware upgrade failure</p>	<p>Before starting recovery process, please configure the IP address of the PC as 192.168.1.100 and proceed with the following step-by-step guide.</p> <ol style="list-style-type: none"> 1. Power the router off. 2. Press reset button and power on the router, once the Power lights Red, keeping press reset button over 6 seconds. 3. Internet LED flashes Green, router entering recovery procedure and router's IP will reset to Emergency IP address (Say 192.168.1.1). 4. Open browser and access http://192.168.1.1 to upload the firmware. 5. Internet LED lit Red, and router starts to write firmware into flash. Please DO NOT power off the router at this step. 6. Internet LED lit Green when successfully upgrade firmware. 7. Power cycle off/on the MX-230 M1

APPENDIX: PRODUCT SUPPORT & CONTACT

If you come across any problems please contact the dealer from where you have purchased the product.

Contact BEC @ <http://www.bectechnologies.net>

MAC OS is a registered Trademark of Apple Computer, Inc.

Windows 10 / 8 / 7 and Windows Vista are registered Trademarks of Microsoft Corporation

Federal Communication Commission Interference Statement

This equipment has been tested and found to comply with the limits for a Class B digital device, pursuant to Part 15 of the FCC Rules. These limits are designed to provide reasonable protection against harmful interference in a residential installation. This equipment generates, uses, and can radiate radio frequency energy and, if not installed and used in accordance with the instructions, may cause harmful interference to radio communications. However, there is no guarantee that interference will not occur in a particular installation. If this equipment does cause harmful interference to radio or television reception, which can be determined by turning the equipment off and on, the user is encouraged to try to correct the interference by one or more of the following measures:

- ♦ Reorient or relocate the receiving antenna.
- ♦ Increase the separation between the equipment and receiver.
- ♦ Connect the equipment into an outlet on a circuit different from that to which the receiver is connected.
- ♦ Consult the dealer or an experienced radio/TV technician for help.

FCC Caution:

This device complies with Part 15 of the FCC Rules. Operation is subject to the following two conditions:

- (1) This device may not cause harmful interference
- (2) This device must accept any interference received, including interference that may cause undesired operation.

Any changes or modifications not expressly approved by the party responsible for compliance could void the user's authority to operate this equipment. . This device and its antenna(s) must not be co-located or operating in conjunction with any other antenna or transmitter.

Co-location statement

This device and its antenna(s) must not be co-located or operating in conjunction with any other antenna or transmitter.

FCC Radiation Exposure Statement

This equipment complies with FCC radiation exposure limits set forth for an uncontrolled environment. This equipment should be installed and operated with minimum distance 20cm between the radiator & your body.