

FCC Test Report

Product Name : Advanced Industrial 4G/LTE Router, WWAN
Failover Manager
Trade Name : BEC, Billion
Model No. : MX-200, MX-200e, M100, MX-200A, MX-200Ae
FCC ID. : QI3BIL-MX200A

Applicant : Billion Electric Co., Ltd.
Address : 8F., No.192, Sec. 2, Zhongxing Rd., Xindian Dist.,
New Taipei City 231, Taiwan (R.O.C.)

Date of Receipt : May 26, 2017
Issued Date : Jul. 11, 2017
Report No. : 1760012R-HPUSP45V00
Report Version : V3.0



The test results relate only to the samples tested.

The test report shall not be reproduced except in full without the written approval of DEKRA Testing and Certification Co., Ltd.

Test Report Certification

Issued Date : Jul. 11, 2017

Report No. :1760012R-HPUSP45V00



Product Name : Advanced Industrial 4G/LTE Router,
WWAN Failover Manager

Applicant : Billion Electric Co., Ltd.

Address : 8F., No.192, Sec. 2, Zhongxing Rd., Xindian Dist., New Taipei
City 231, Taiwan (R.O.C.)

Manufacturer : Billion Electric Co., Ltd.

Model No. : MX-200, MX-200e, M100, MX-200A, MX-200Ae

FCC ID. : QI3BIL-MX200A

EUT Voltage : DC 9-56V

Testing Voltage : DC 12V(Power by Adapter AC120V/60Hz)

Trade Name : BEC, Billion

Applicable Standard : FCC CFR Title 47 Part 2
FCC CFR Title 47 Part 27 Subpart M
ANSI/TIA-603-D-2010

Test Lab : Hsin Chu Laboratory
No.372-2, Sec. 4, Zhongxing Rd., Zhudong Township,
Hsinchu County 310, Taiwan
TEL:+886-3-582-8001 / FAX:+886-3-582-8958

Test Result : Complied

Documented By : 

 (Demi Chang / Senior Engineering Adm. Specialist)

Tested By : 

 (JuBo Shen / Senior Engineer)

Approved By : 

 (Roy Wang / Director)

Revision History

Report No.	Version	Description	Issued Date
1760012R-HPUSP45V00	V3.0	Initial issue of report.	Jul. 11, 2017

Laboratory Information

We, **DEKRA Testing and Certification Co., Ltd.**, are an independent RF consultancy that was established the whole facility in our laboratories. The test facility has been accredited/accepted (audited or listed) by the following related bodies in compliance with ISO 17025 specified testing scopes:

Taiwan R.O.C.	:	TAF, Accreditation Number: 3024
USA	:	FCC, Registration Number: 834100
Canada	:	IC, Submission No: 181665 / IC Registration Number: 22397-1 / 22397-2 / 22397-3

The related certificate for our laboratories about the test site and management system can be downloaded from DEKRA Testing and Certification Co., Ltd. Web Site:

<http://www.dekra.com.tw/english/about/certificates.aspx?bval=5>

The address and introduction of DEKRA Testing and Certification Co., Ltd. laboratories can be founded in our Web site : http://www.dekra.com.tw/index_en.aspx

If you have any comments, Please don't hesitate to contact us. Our test sites as below:

- 1 No. 75-2, 3rd Lin, WangYe Keng, Yonghxing Tsuen, Qionglin Shiang, Hsinchu County 307, Taiwan (R.O.C.)
TEL:+886-3-592-8858 / FAX:+886-3-592-8859 E-Mail : info.tw@dekra.com
- 2 No.372, Sec. 4, Zhongxing Rd., Zhudong Township, Hsinchu County 31061, Taiwan
TEL: +886-3-582-8001 / FAX: +886-3-582-8958 E-Mail : info.tw@dekra.com
- 3 No.372-2, Sec. 4, Zhongxing Rd., Zhudong Township, Hsinchu County 31061, Taiwan
TEL: +886-3-582-8001 / FAX: +886-3-582-8958 E-Mail : info.tw@dekra.com

TABLE OF CONTENTS

Description	Page
1. General Information	7
1.1. EUT Description	7
1.2. Test Mode.....	9
1.3. Tested System Details.....	10
1.4. Configuration of tested System	10
1.5. EUT Exercise Software	10
2. Technical Test.....	11
2.1. Summary of Test Result	11
2.2. Test Environment	11
3. Peak Output Power	12
3.1. Test Equipment	12
3.2. Test Setup	13
3.3. Limits.....	14
3.4. Test Procedure	14
3.5. Uncertainty	14
3.6. Test Result	15
4. Occupied Bandwidth	18
4.1. Test Equipment	18
4.2. Test Setup	18
4.3. Limits.....	18
4.4. Test Procedure	18
4.5. Uncertainty	18
4.6. Test Result	19
5. Band Edge	31
5.1. Test Equipment	31
5.2. Test Setup	31
5.3. Limits.....	31
5.4. Test Procedure	32
5.5. Uncertainty	32
5.6. Test Result	33
6. Conducted Spurious Emission	35
6.1. Test Equipment	35
6.2. Test Setup	35
6.3. Limits.....	36
6.4. Test Procedure	36
6.5. Uncertainty	36
6.6. Test Result	37
7. Radiated Spurious Emission	43
7.1. Test Equipment	43
7.2. Test Setup	43

7.3.	Limits	44
7.4.	Test Procedure	45
7.5.	Uncertainty	45
7.6.	Test Result	46
8.	Frequency Stability Over Temperatures Variation	94
8.1.	Test Equipment	94
8.2.	Test Setup	94
8.3.	Limits	94
8.4.	Test Procedure	94
8.5.	Uncertainty	94
8.6.	Test Result	95
9.	Frequency Stability Over Voltage Variation	98
9.1.	Test Equipment	98
9.2.	Test Setup	98
9.3.	Limits	98
9.4.	Test Procedure	99
9.5.	Uncertainty	99
9.6.	Test Result	100
10.	Peak to Average Ratio.....	101
10.1.	Test Equipment.....	101
10.2.	Test Setup	101
10.3.	Limits	101
10.4.	Test Procedure	101
10.5.	Uncertainty	102
10.6.	Test Result.....	103
Attachment 1		104
Test Setup Photograph.....		104
Attachment 2.....		108
EUT External Photograph		108
Attachment 3.....		114
EUT Internal Photograph.....		114

1. General Information

1.1. EUT Description

Product Name	Advanced Industrial 4G/LTE Router, WWAN Failover Manager
Model No.	MX-200, MX-200e, M100, MX-200A, MX-200Ae
Trade Name	BEC, Billion
Tx Frequency Range	WCDMA Band 4: 1712.4-1752.6 MHz
Rx Frequency Range	WCDMA Band 4: 2112.4-2152.6 MHz
Type of Modulation	WCDMA: QPSK (Uplink); HSDPA/HSUPA: QPSK
HW Version	1.011
SW Version	1.04.1.103p

Antenna Information	
Antenna Type	Dipole Antenna
Antenna Gain	0.71 dBi (700-960MHz) 3.7 dBi (1710-2700MHz) 4.5 dBi (GPS)

Accessory Information	
Power Adapter	Billion, BA018-120120AXU I/P: 100-240V ~ 0.5A 50/60Hz O/P: 12V  1.2A Cable Out: Non-Shielded, 2m.
LTE Antenna	Cortec Technology Inc., AN0727-64DP5BSM (2pcs)
GPS Antenna	Cortec Technology Inc., AG1575-0250SM (1pcs)

Note:

1. This Advanced Industrial 4G/LTE Router, WWAN Failover Manager included WCDMA Band 2, WCDMA Band 4 and WCDMA Band 5 transmitting and receiving function.

2. The different of the each model is shown as below:

- * BEC MX-200 / BEC MX-200A : MXConnect M2M Advanced Industrial 4G/LTE Router
- * BEC MX-200e / BEC MX-200Ae : WWAN Failover Manager
- * Billion M100 : Advanced Industrial 4G/LTE Router

	MX-200	MX-200A	M100	MX-200e	MX-200Ae
Trade Name	BEC		Billion	BEC	
Hardware design	PCBA/Layout/Scheme/ Key component/housing / interface ...100% same				
LTE antennas(SMA)	Detachable LTE Antenna *2pcs				
GPS antenna (SMA)	1				
SIM slot (2FF)	1				
RS-232 (DB-9)	1				
Ethernet Giga port	2				
Power input	9-56VDC				
External color	Casing: Metal/Black				
Software function	with VPN			without VPN	

1.2. Test Mode

DEKRA has verified the construction and function in typical operation. The preliminary tests were performed in different data rate, and to find the worst condition, which was shown in this test report. The following table is the final test mode.

Final Test Model	
TX	Mode 1: WCDMA Band 4_Link Mode Mode 2: WCDMA Band 4_Idle Mode Mode 3: WCDMA Band 4_HSUPA Mode Mode 4: WCDMA Band 4_HSDPA Mode

1.3. Tested System Details

The types for all equipments, plus descriptions of all cables used in the tested system (including inserted cards) are:

Product	Manufacturer	Model No.	Serial No.	FCC ID	Power Cord
1 Horn	ELECTRO METRICS	EM6961	103326	DoC	--
2 Base Station Simulator	JRC	NJZ-2000	ET00477	DoC	--

1.4. Configuration of tested System

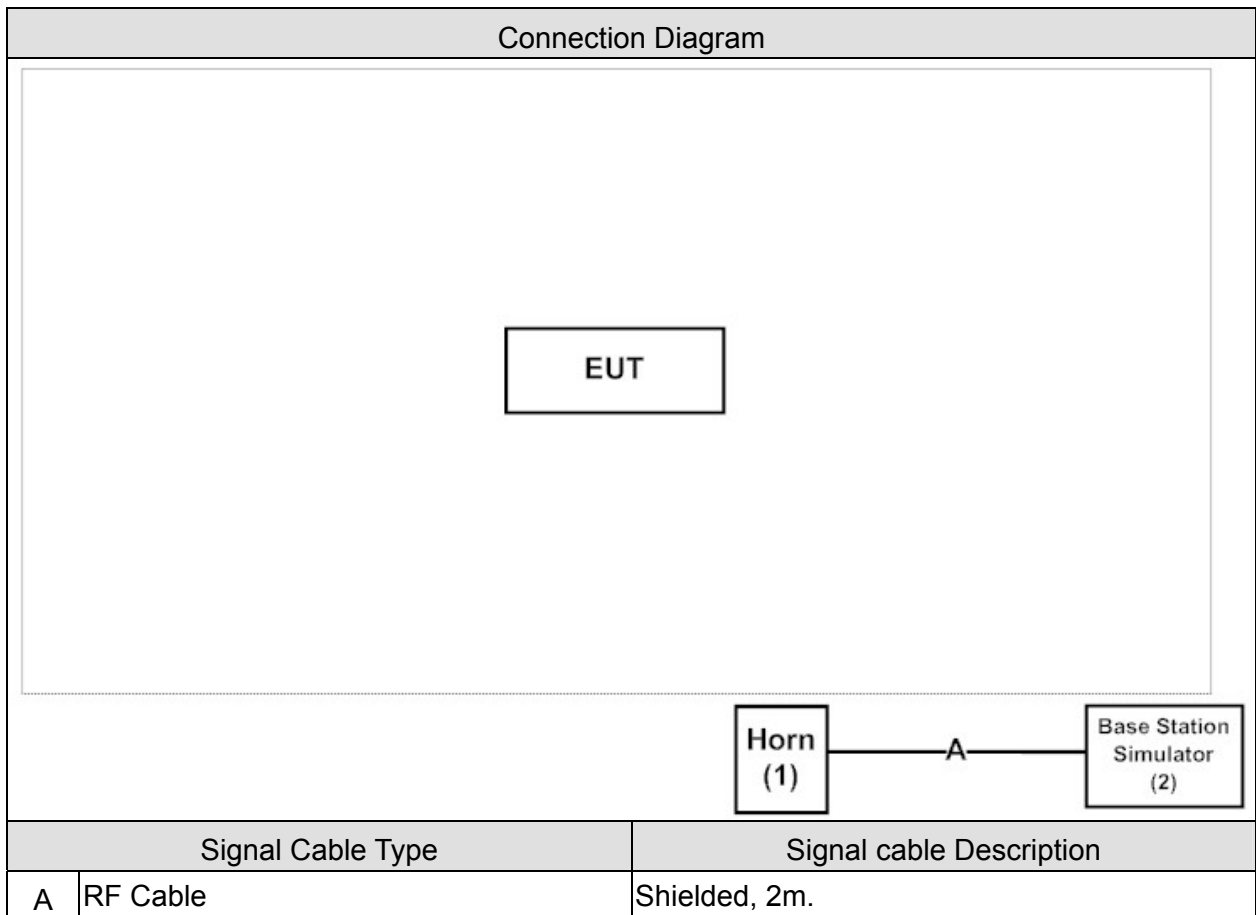

1.5. EUT Exercise Software

1	Setup the EUT as shown in Section 1.4.
2	Turn on the power of all equipment. Horn link with base station.
3	The EUT link with base station and it will continue receive the signal from WCDMA function.
4	Repeat the above procedure.

2. Technical Test

2.1. Summary of Test Result

Performed Item	FCC References	Result
Peak Output Power	FCC PART 2.1046 and PART 27.50(d)(4)	Pass
Occupied Bandwidth	FCC PART 2.1049 and PART 27.53(l)(6)	Pass
Spurious Emission At Antenna Terminals (+/- 1MHz)	FCC PART 2.1051 and PART 27.53(l)(4)(6)	Pass
Spurious Emission	FCC PART 2.1051 and PART 27.53(l)(4)(6)	Pass
Frequency Stability Under Temperature & Voltage Variations	FCC PART 2.1055(a)(l) and PART 27.54	Pass

2.2. Test Environment

Items	Required (IEC 68-1)	Actual
Temperature (°C)	15-35	23
Humidity (%RH)	25-75	52
Barometric pressure (mbar)	860-1060	950-1000

3. Peak Output Power

3.1. Test Equipment

The following test equipments are used during the test:

Peak Output Power - Conducted Measurement /SR10-H

Instrument	Manufacturer	Model No.	Serial No	Next Cal. Date
Signal & Spectrum Analyzer	R&S	FSVA40	101455	2017/11/27
Multisystem UE Tester	Japan radio	NJZ-2000	ET00477	2017/09/19
Directional Coupler	Agilent	778D	20402	2017/10/06

Peak Output Power - Radiated Measurement /CB4-H

Instrument	Manufacturer	Model No.	Serial No	Next Cal. Date
Bilog Antenna	Schaffner	CBL6112B	2891	2017/08/14
Horn Antenna	Schwarzbeck	BBHA 9120	D312	2017/10/25
Pre-Amplifier	EMCI	EMC0031835	980233	2018/02/02
Pre-Amplifier	Schwarzbeck	DBL-1840N506	013	2017/09/29
Pre-Amplifier	Miteq	JS41-001040000-58-5P	1573954	2017/10/04
Horn Antenna	Schwarzbeck	BBHA 9170	203	2017/08/28
Signal & Spectrum Analyzer	R&S	FSV40	101049	2018/01/05

Note: All equipments are calibrated with traceable calibrations. Each calibration is traceable to the national or international standards.

3.2. Test Setup

RF Conducted Measurement:

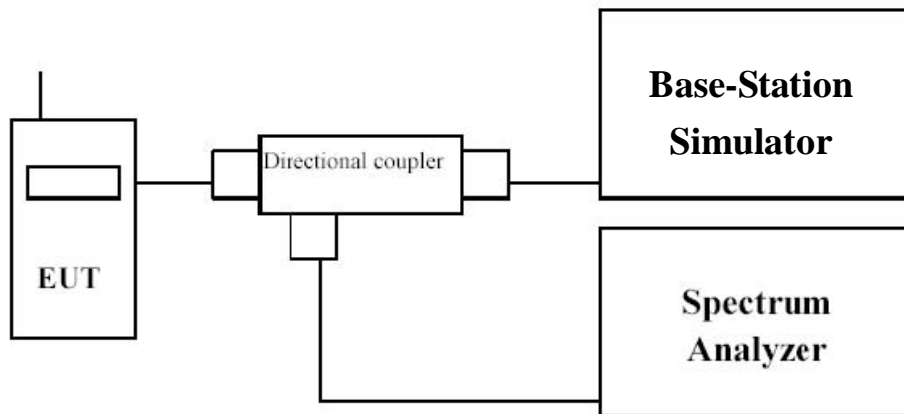

RF Radiated Measurement:

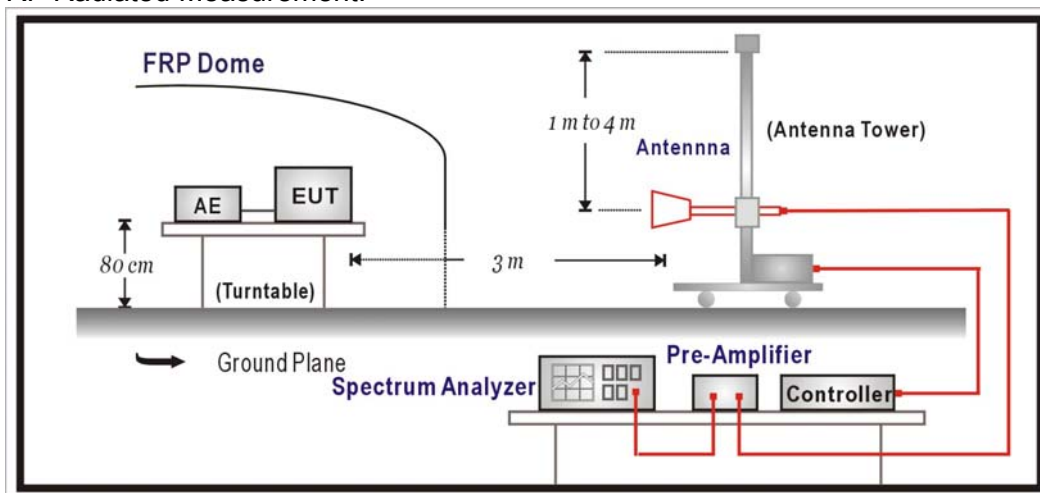

Substitution Measurement Setup:

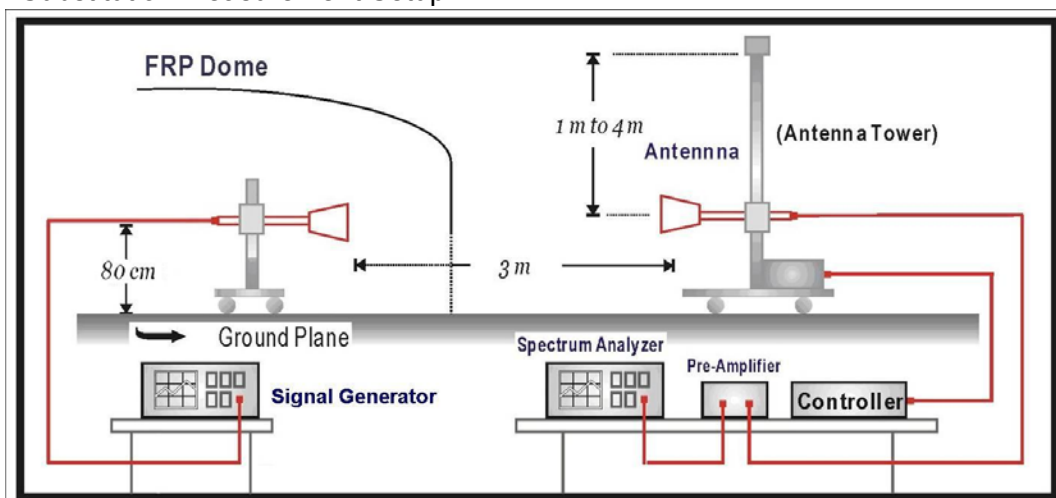

3.3. Limits

- (1) Main, Booster and Base Stations: Maximum E.I.R.P shall not exceed $33 \text{ dBW} + 10\log(X/Y)$ dBW, where X is the actual channel width in MHz and Y is either 6 MHz if prior to transition or the station is in the MBS following transition or 5.5 MHz if the station is in the LBS and UBS following transition.
- (2) Mobile and Other User Stations: 2.0 Watts EIRP.

3.4. Test Procedure

The conducted peak output power is measured using R&S Spectrum Analyzer. The EUT was set up for the rated peak power. All measurements were done at 3 channels: low, middle and high operational frequency range.

For measuring E.I.R.P peak power, EUT was placed on the turn-table which was rotated around 360 degrees to search the maximum radiation power and receiver antenna was rotated vertical and horizontal polarization to find the maximum polarization radiated power.

The EUT is replaced by a horn antenna connected to a signal generator tuned to the frequency of emission and level of signal generator adjusted to same level of emission. Both horizontal and vertical polarization of the antenna are set on measurement.

The radiated E.I.R.P power was calculated via the Correct factor, Reading Level, and Antenna gain as follows:

$$\text{E.I.R.P} = \text{Reading Level} + \text{Correct Factor} = \text{S.G.} - \text{Cable Loss} + \text{Antenna Gain}$$

3.5. Uncertainty

The measurement uncertainty is defined as $\pm 1.27 \text{ dB}$

3.6. Test Result

Product	Advanced Industrial 4G/LTE Router, WWAN Failover Manager		
Test Item	Peak Output Power		
Test Mode	Mode 1: WCDMA Band 4_Link mode		
Date of Test	2017/02/03	Test Site	SR10-H

Frequency (MHz)	Peak Power		Average Power		Limit (dBm)
	Reading Level (dBm)	Measure Level (dBm)	Reading Level (dBm)	Measure Level (dBm)	
1712.4	25.51	29.21	22.56	26.26	30
1732.6	25.18	28.88	22.39	26.09	30
1752.6	25.58	29.28	22.37	26.07	30

Product	Advanced Industrial 4G/LTE Router, WWAN Failover Manager		
Test Item	Peak Output Power		
Test Mode	Mode 3: WCDMA Band 4_HSUPA mode		
Date of Test	2017/02/15	Test Site	SR10-H

Frequency (MHz)	Peak Power		Average Power		Limit (dBm)
	Reading Level (dBm)	Measure Level (dBm)	Reading Level (dBm)	Measure Level (dBm)	
1712.4	25.23	27.60	20.72	23.09	30
1732.6	24.62	26.99	20.19	22.56	30
1752.6	24.88	27.25	20.57	22.94	30

Product	Advanced Industrial 4G/LTE Router, WWAN Failover Manager		
Test Item	Peak Output Power		
Test Mode	Mode 4: WCDMA Band 4_HSDPA mode		
Date of Test	2017/02/15	Test Site	SR10-H

Frequency (MHz)	Peak Power		Average Power		Limit (dBm)
	Reading Level (dBm)	Measure Level (dBm)	Reading Level (dBm)	Measure Level (dBm)	
1712.4	24.93	27.3	21.16	23.53	30
1732.6	24.7	27.07	20.87	23.21	30
1752.6	24.94	27.31	21.06	23.43	30

4. Occupied Bandwidth

4.1. Test Equipment

The following test equipments are used during the test:

Occupied Bandwidth/ SR10-H

Instrument	Manufacturer	Model No.	Serial No.	Next Cal. Date
Signal & Spectrum Analyzer	R&S	FSV40	101049	2018/01/22
Multisystem UE Tester	Japan radio	NJZ-2000	ET00477	2017/09/19
Directional Coupler	Agilent	778D	20402	2017/10/06

Note: All equipments are calibrated with traceable calibrations.

Each calibration is traceable to the national or international standards.

4.2. Test Setup

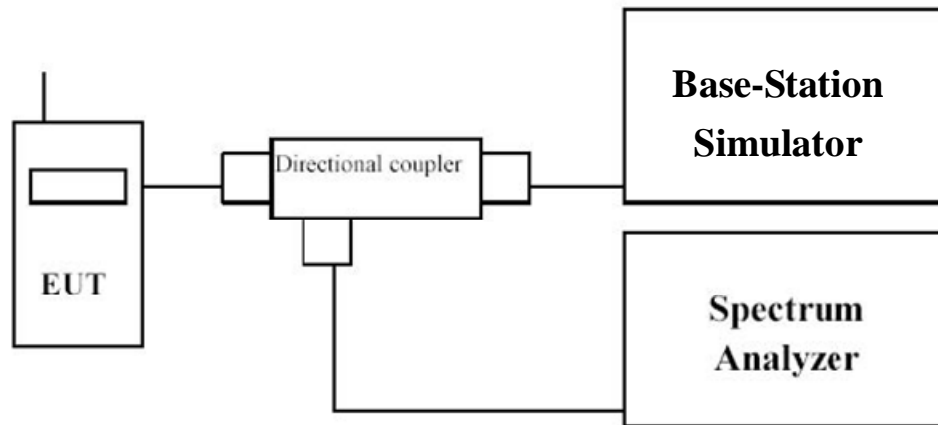

4.3. Limits

The emission bandwidth is defined as the width of the signal between two points, one below the carrier center frequency and one above the carrier center frequency, outside of which all emissions are attenuated at least 26 dB below the transmitter power.

4.4. Test Procedure

The occupied bandwidth is measured using R&S Spectrum Analyzer with a resolution bandwidth of 100 kHz, video bandwidth of 300 kHz and span of 10 MHz. The EUT was set up for the rated peak power under transmission mode and specific channel frequency. The standards required a measurement bandwidth is the fundamental emission below 26dB bandwidth.

4.5. Uncertainty

The measurement uncertainty is defined as ± 50 KHz

4.6. Test Result

Product	Advanced Industrial 4G/LTE Router, WWAN Failover Manager		
Test Item	Occupied Bandwidth		
Test Mode	Mode 1: WCDMA Band 4_Link mode		
Date of Test	2017/02/03	Test Site	SR10-H

Frequency (MHz)	-26B BW Measure Level (MHz)	99% BW Measure Level (MHz)	Limit (MHz)
1712.4	4.63	4.142	N/A
1732.6	4.657	4.131	N/A
1752.6	4.632	4.128	N/A

1712.4 MHz (-26dB BW)

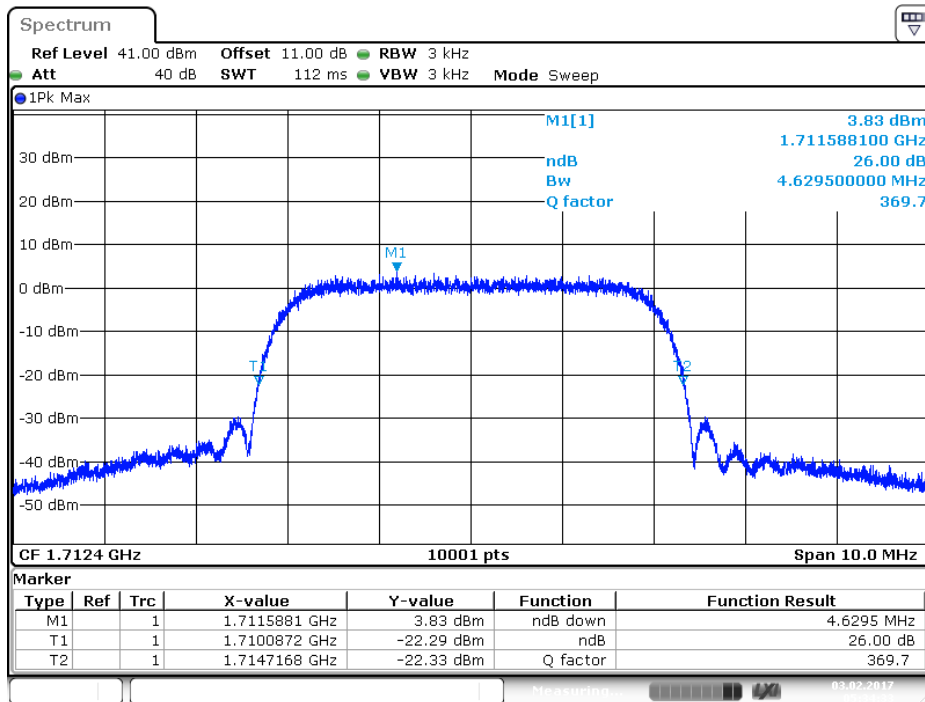

Date: 3 FEB 2017 05:34:33

1712.4 MHz (99% BW)

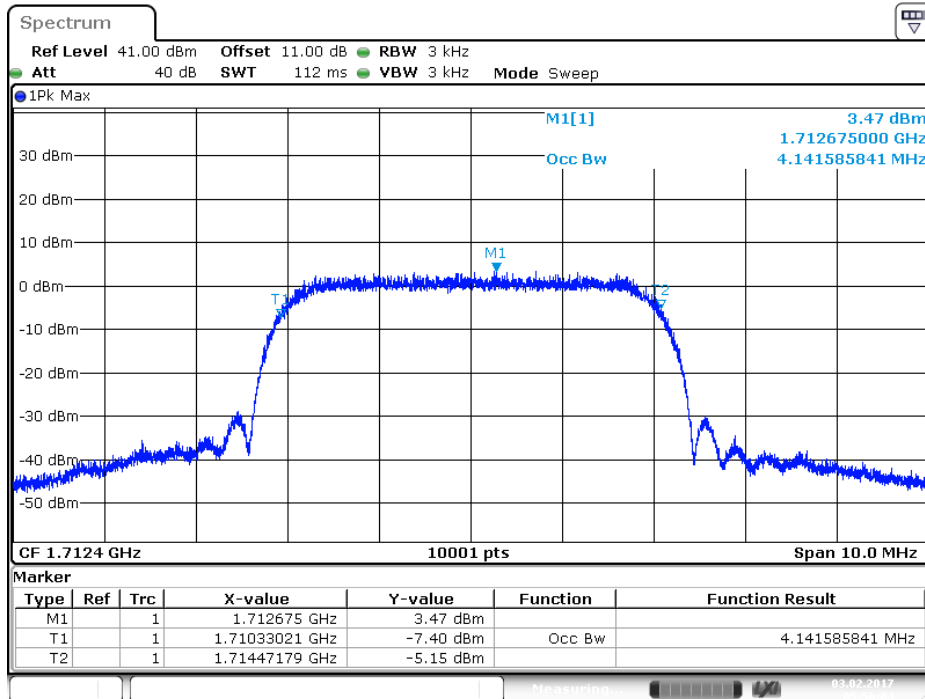

Date: 3 FEB 2017 05:56:04

1732.6 MHz (-26dB BW)

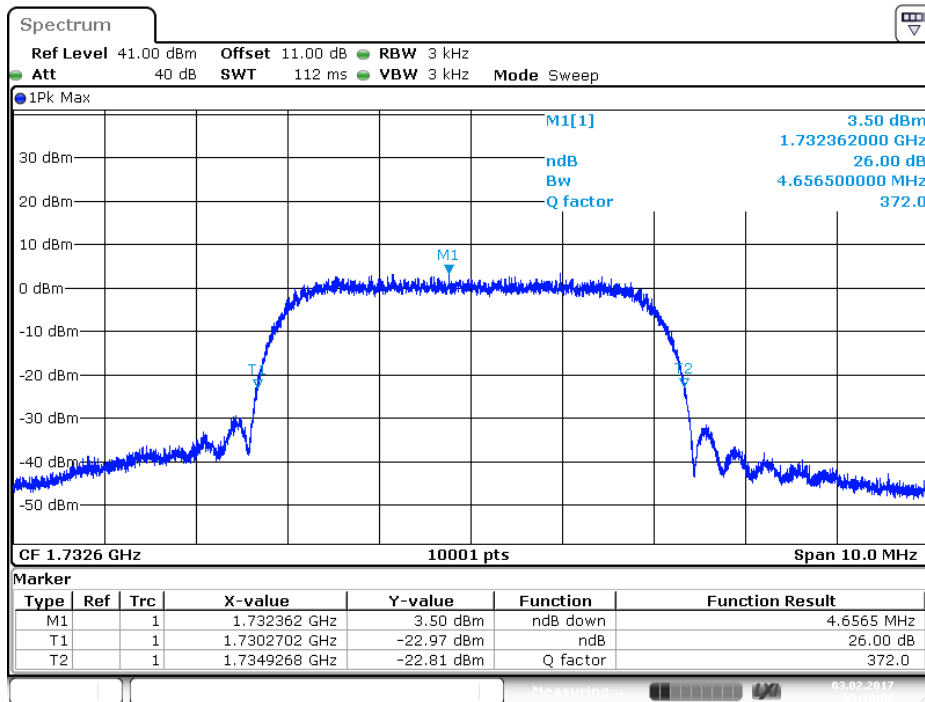

Date: 3 FEB 2017 05:36:08

1732.6 MHz (99% BW)

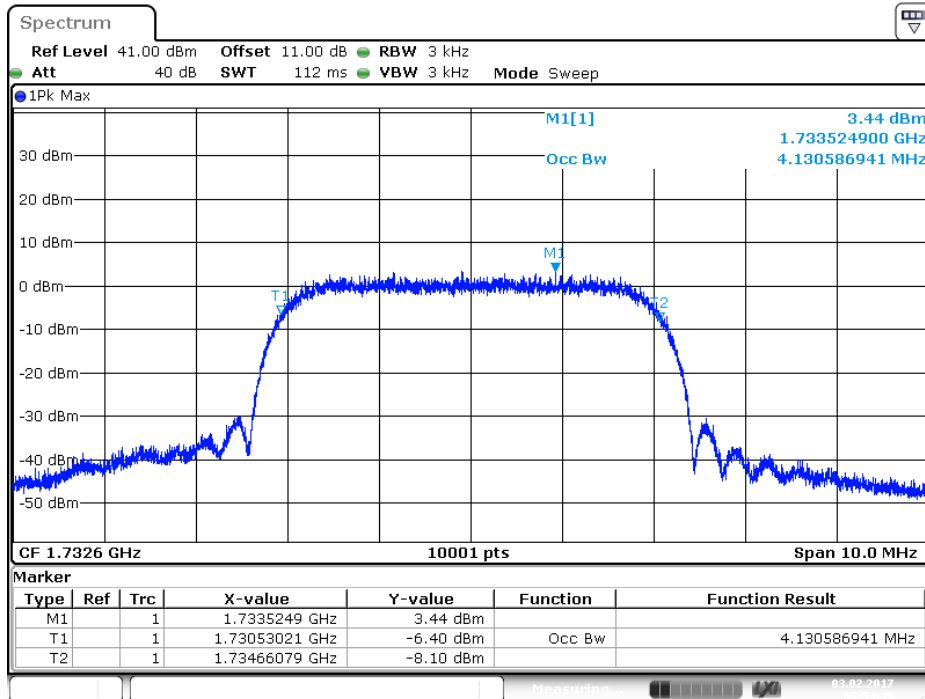

Date: 3 FEB 2017 05:54:46

1752.6MHz (-26dB BW)

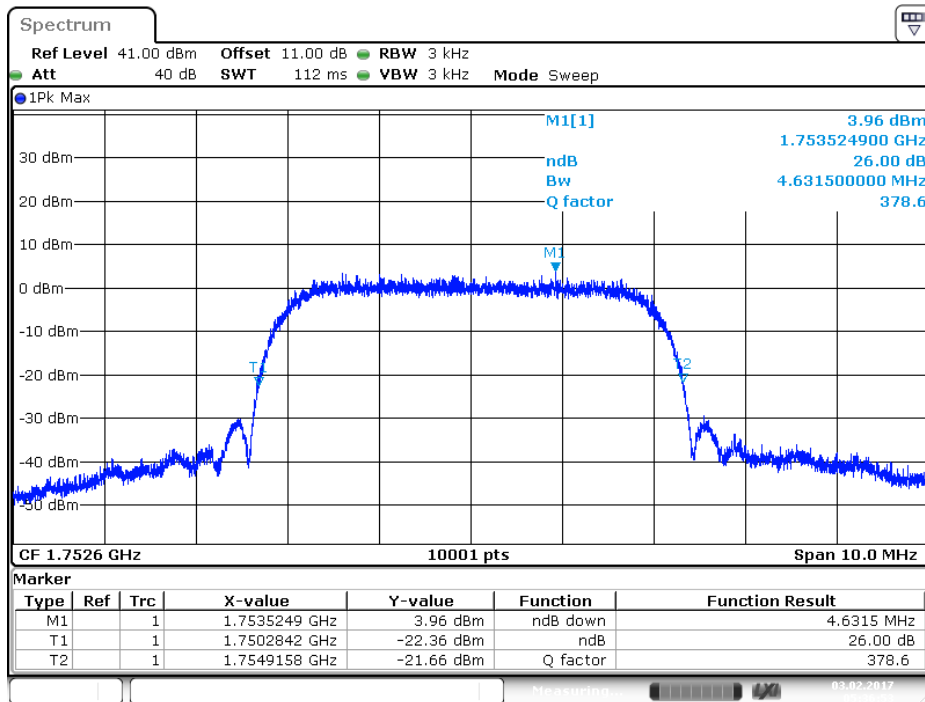

Date: 3 FEB 2017 05:36:53

1752.6MHz (99% BW)

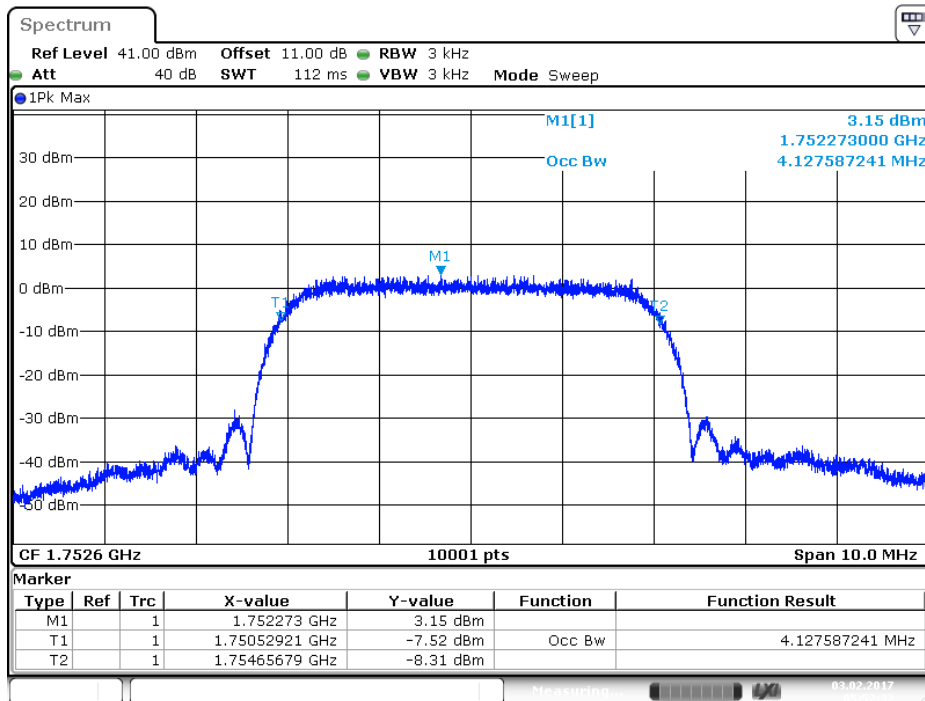

Date: 3 FEB 2017 05:52:32

Product	Advanced Industrial 4G/LTE Router, WWAN Failover Manager		
Test Item	Occupied Bandwidth		
Test Mode	Mode 3: WCDMA Band 4_HSUPA Mode		
Date of Test	2017/02/24	Test Site	SR10-H

Frequency (MHz)	-26B BW Measure Level (MHz)	99% BW Measure Level (MHz)	Limit (MHz)
1712.4	4.652	4.1316	N/A
1732.6	4.634	4.1346	N/A
1752.6	4.664	4.1336	N/A

1712.4 MHz (-26dB BW)

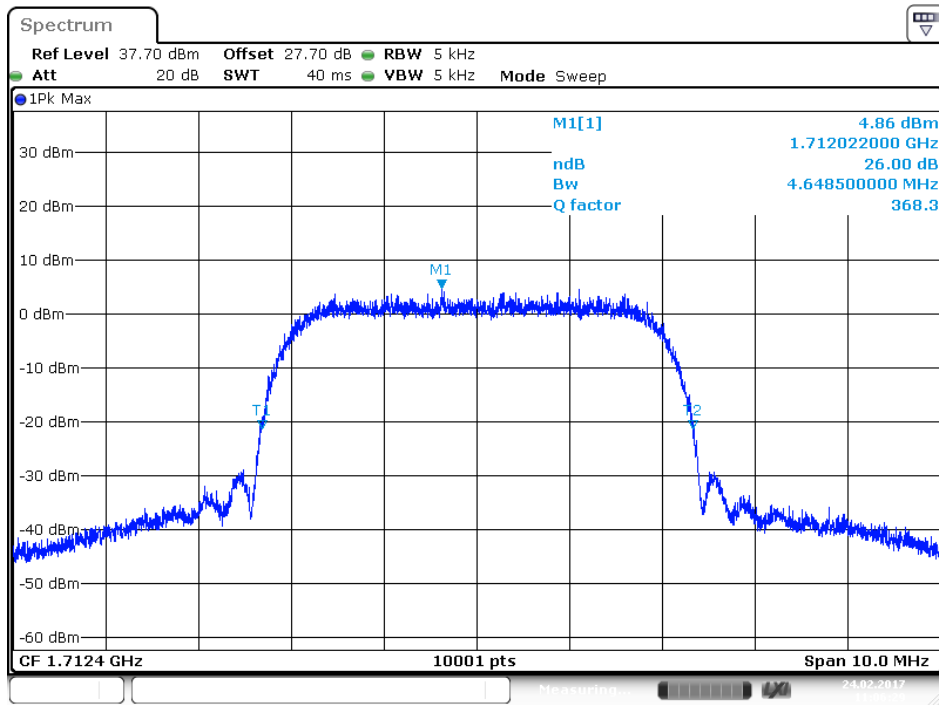

Date: 24.FEB.2017 11:06:29

1712.4 MHz (99% BW)

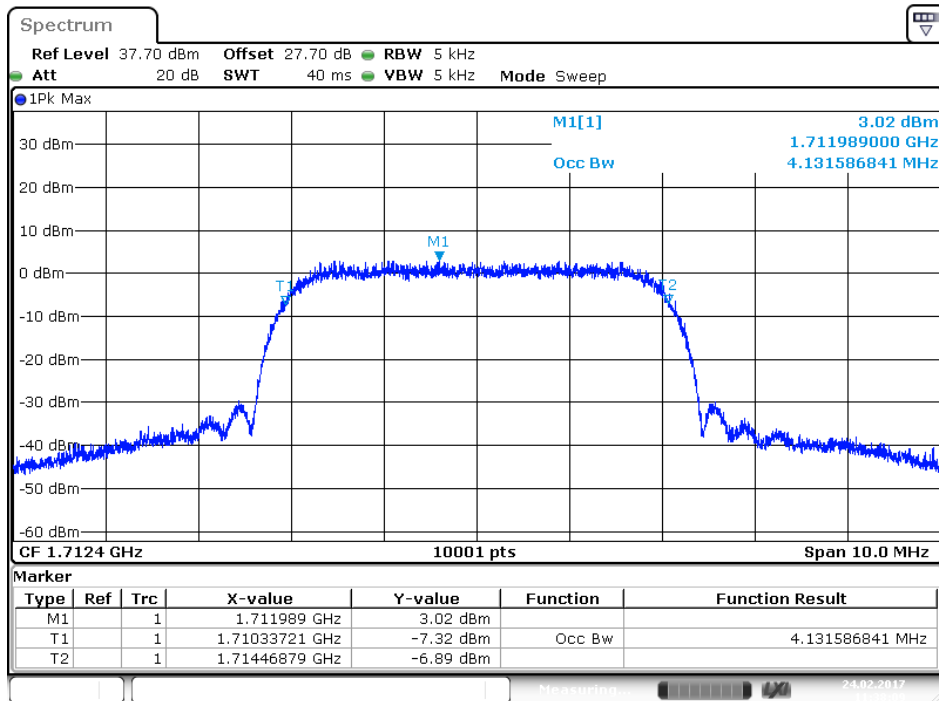

Date: 24.FEB.2017 11:38:09

1732.6 MHz (-26dB BW)

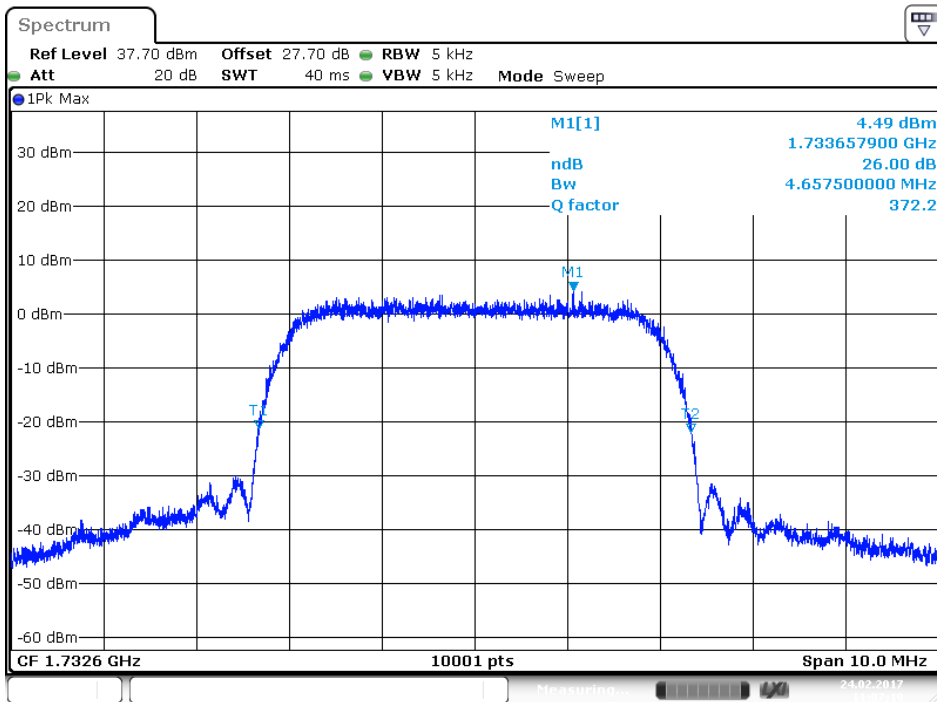

Date: 24.FEB.2017 11:07:19

1732.6 MHz (99% BW)

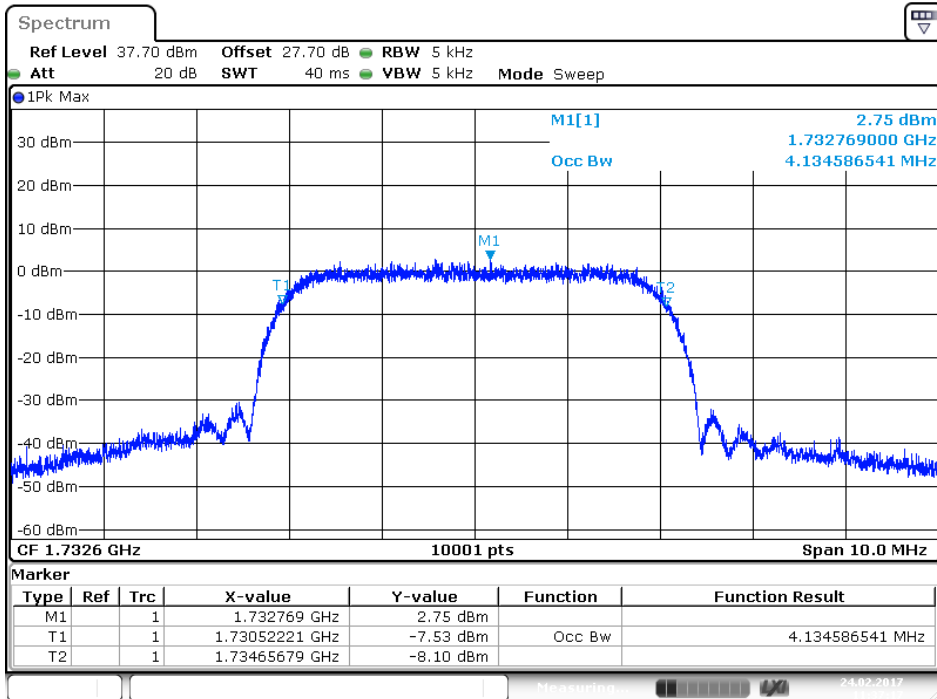

Date: 24.FEB.2017 11:37:18

1752.6MHz (-26dB BW)

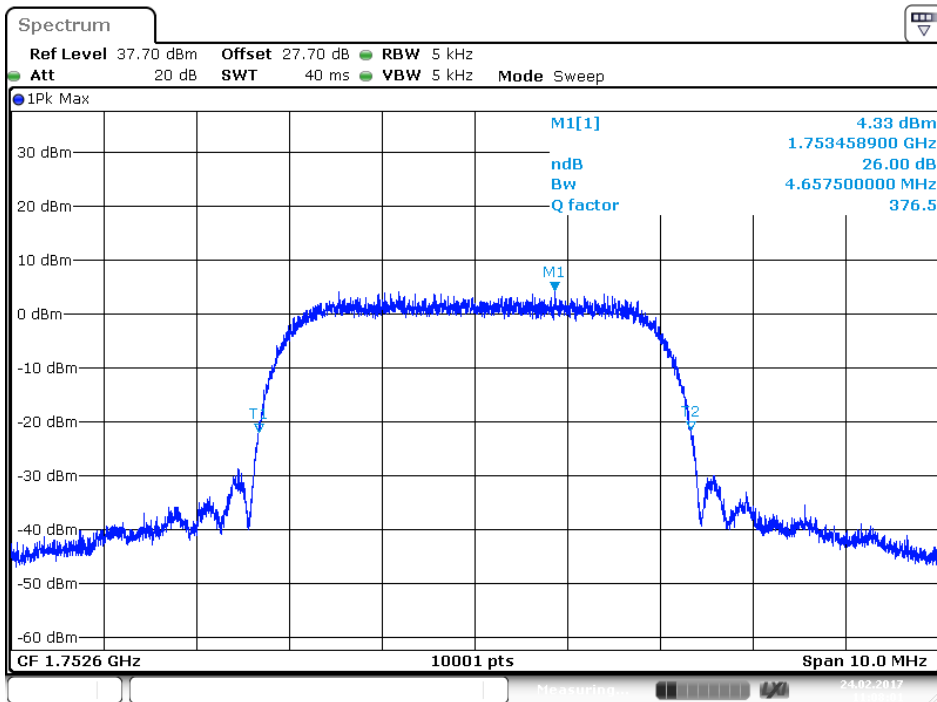

Date: 24.FEB.2017 11:08:01

1752.6MHz (99% BW)

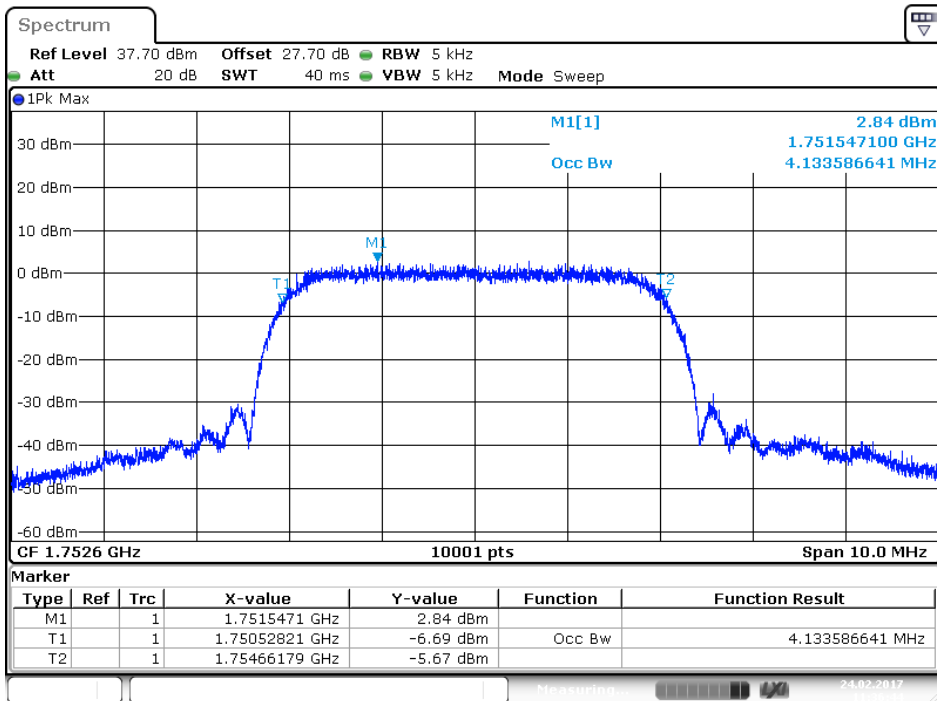

Date: 24.FEB.2017 11:36:44

Product	Advanced Industrial 4G/LTE Router, WWAN Failover Manager		
Test Item	Occupied Bandwidth		
Test Mode	Mode 4: WCDMA Band 4_HSDPA Mode		
Date of Test	2017/02/24	Test Site	SR10-H

Frequency (MHz)	-26B BW Measure Level (MHz)	99% BW Measure Level (MHz)	Limit (MHz)
1712.4	4.649	4.1406	N/A
1732.6	4.658	4.1340	N/A
1752.6	4.658	4.1356	N/A

1712.4 MHz (-26dB BW)

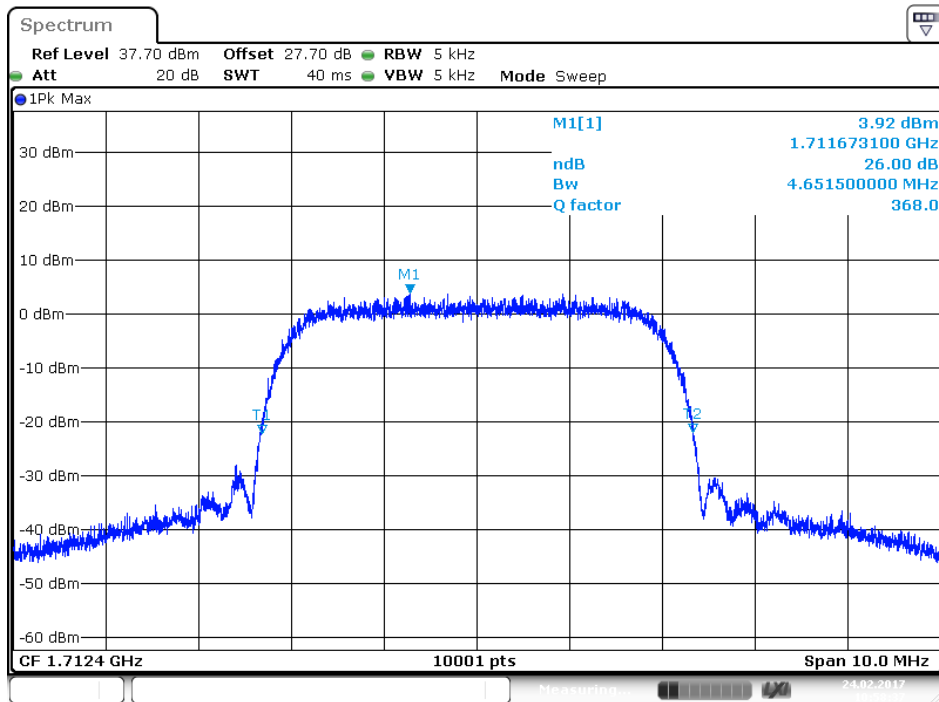

Date: 24.FEB.2017 10:58:37

1712.4 MHz (99% BW)

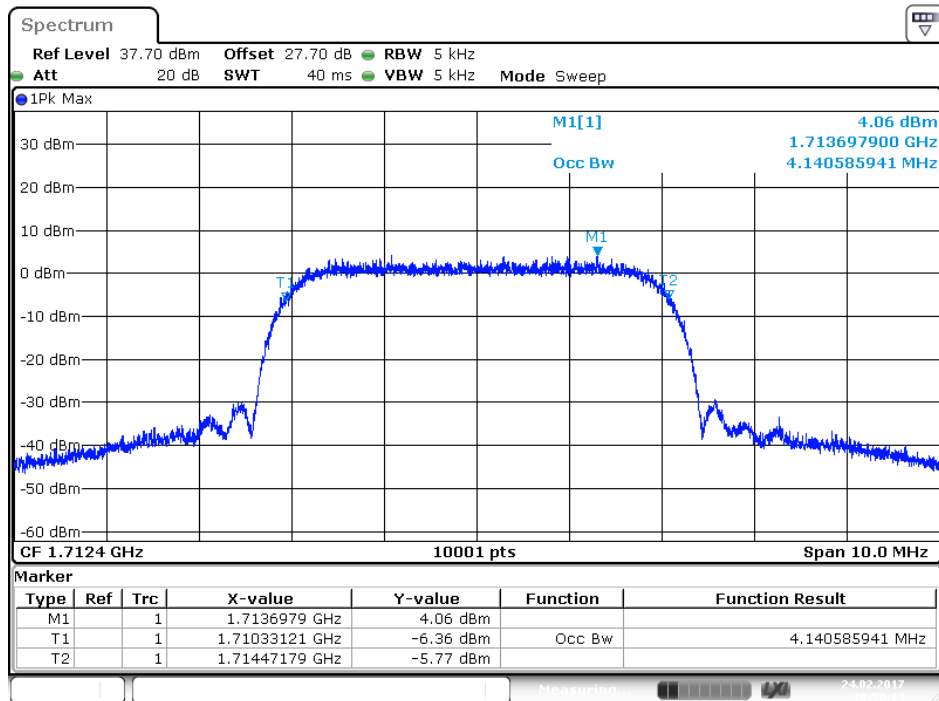

Date: 24.FEB.2017 10:50:14

1732.6 MHz (-26dB BW)

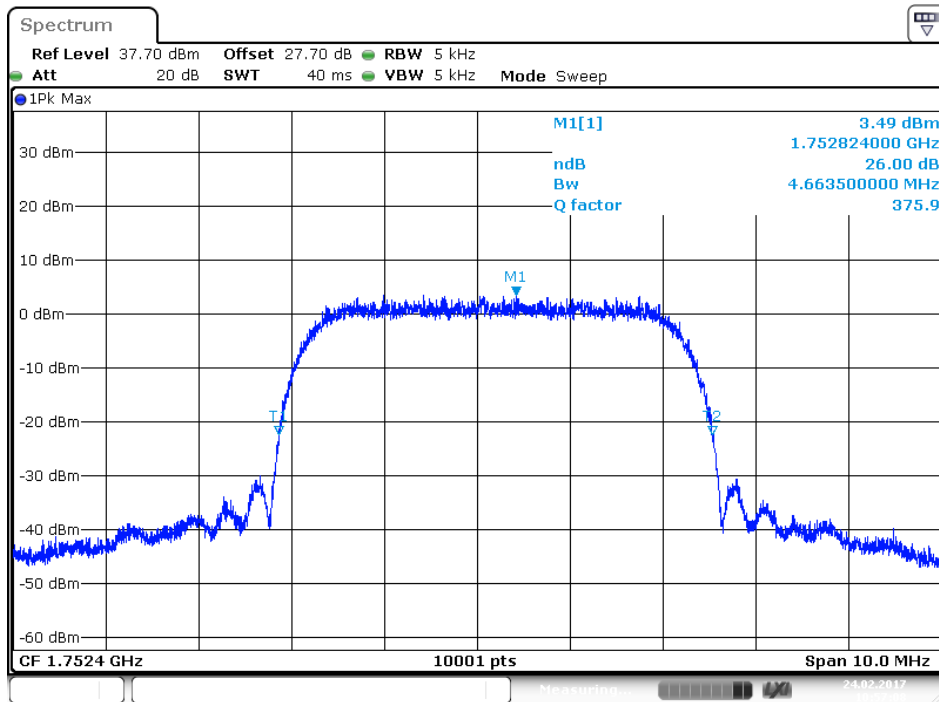

Date: 24.FEB.2017 10:57:08

1732.6 MHz (99% BW)

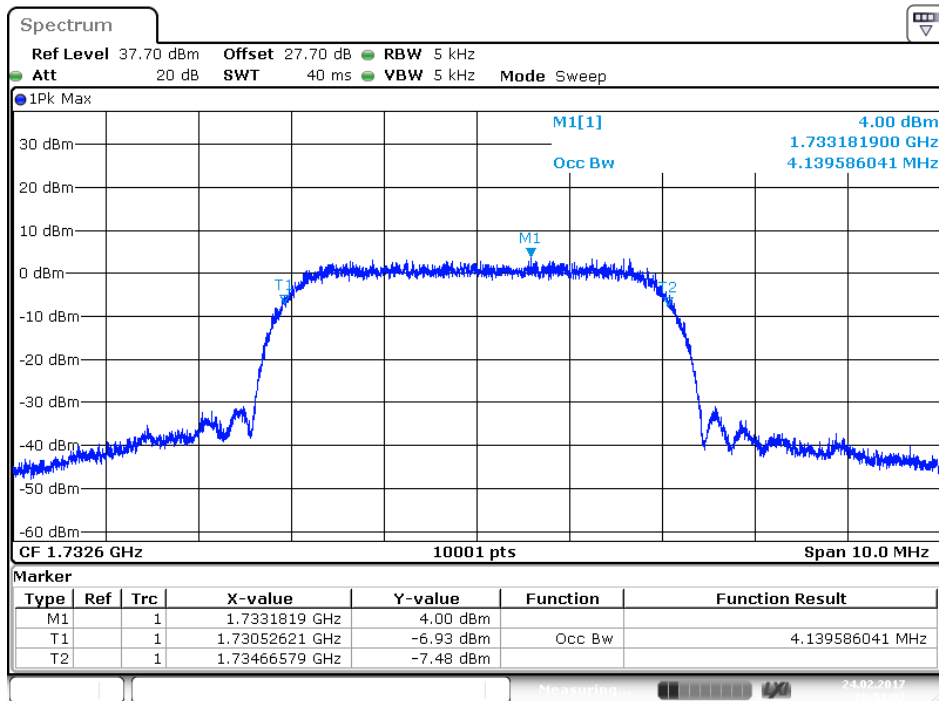

Date: 24.FEB.2017 10:51:02

1752.6MHz (-26dB BW)

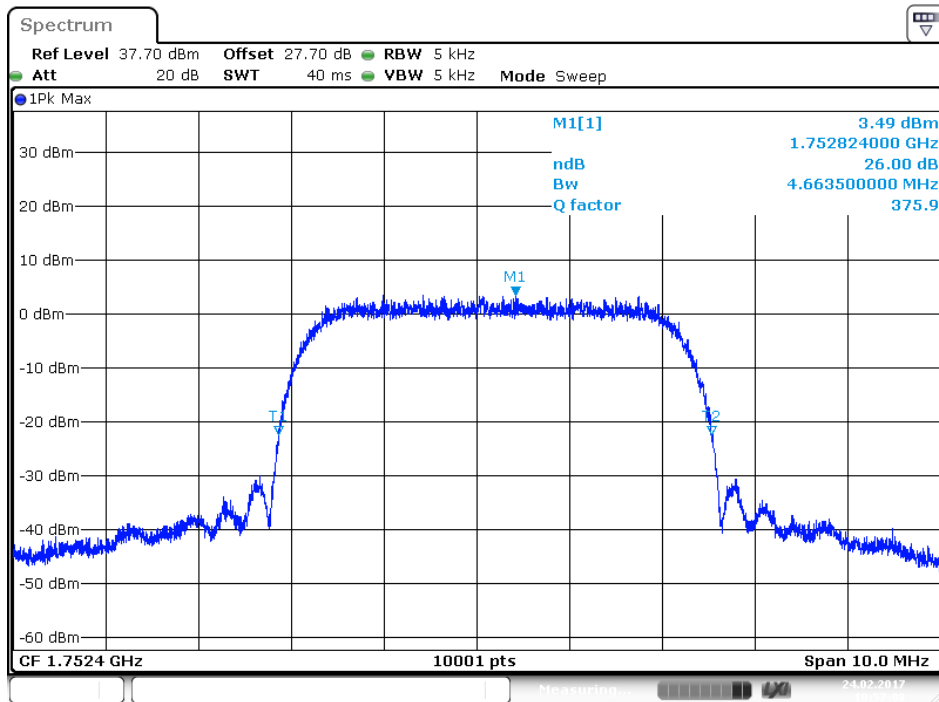

Date: 24.FEB.2017 10:57:08

1752.6MHz (99% BW)

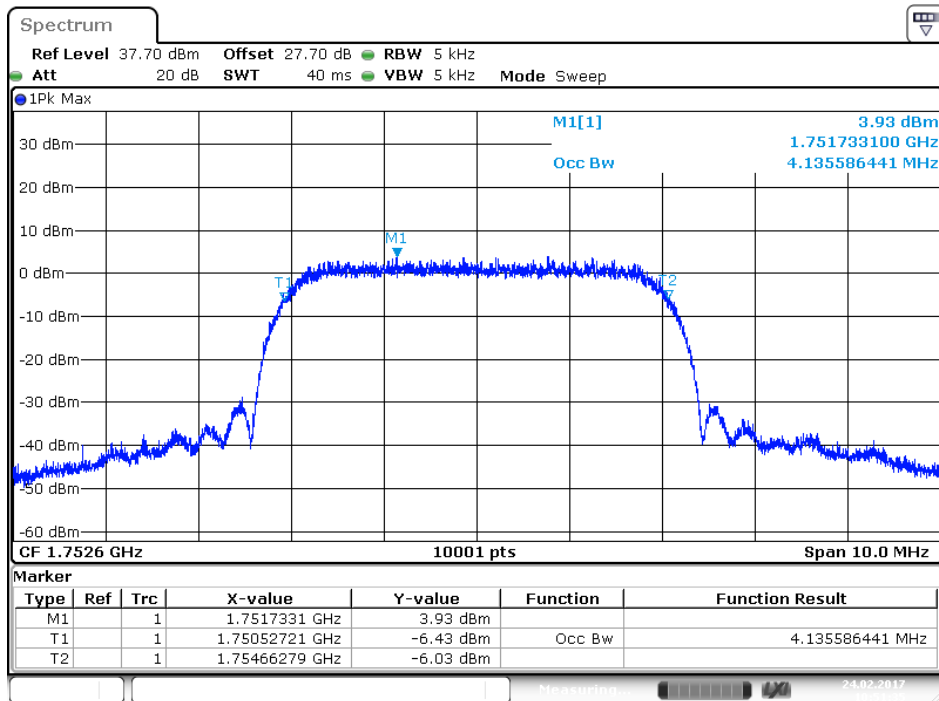

Date: 24.FEB.2017 10:51:36

5. Band Edge

5.1. Test Equipment

The following test equipment are used during the test:

Band edge / SR10-H

Instrument	Manufacturer	Model No.	Serial No.	Next Cal. Date
Signal & Spectrum Analyzer	R&S	FSV40	101049	2018/01/22
Multisystem UE Tester	Japan radio	NJZ-2000	ET00477	2017/09/19
Directional Coupler	Agilent	778D	20402	2017/10/06

Note: All equipments that need to calibrate are with calibration period of 1 year.

5.2. Test Setup

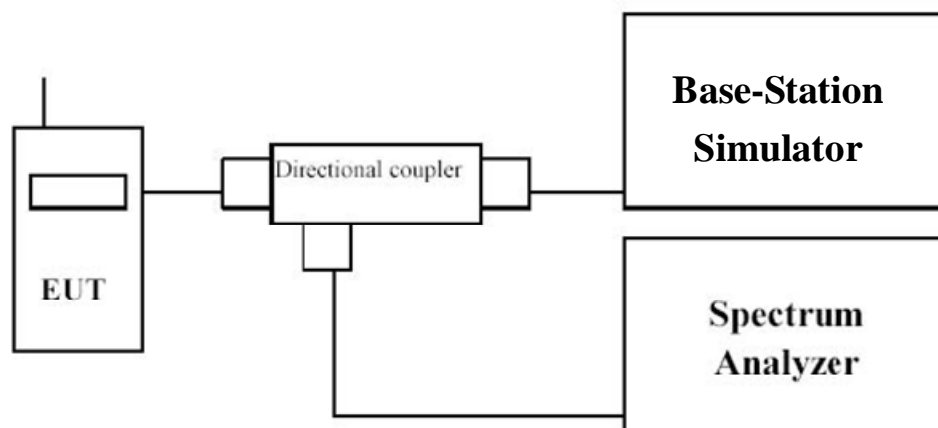

5.3. Limits

- (1) Fixed and Temporary Fixed Digital Stations: not less than $43 + \log (P)$ dB
- (2) Mobile Digital Stations: not less than $43 + \log (P)$ dB at the channel edge and $55 + \log (P)$ dB at 5.5 MHz from the channel edges

Sample Calculation:

Assume the EUT Output Power is 2 W = 33 dBm

$$43 + \log (P) \text{ dB}$$

$$43 + \log (2) = 46 \text{ dB}$$

$$33 \text{ dBm} - 46 \text{ dB} = -13 \text{ dBm}$$

$$55 + \log (2) = 58 \text{ dB}$$

$$33 \text{ dBm} - 58 \text{ dB} = -25 \text{ dBm}$$

5.4. Test Procedure

Conducted Measurement :

The EUT was set up for the rated peak power. The band edge was measured with Spectrum Analyzer with a resolution bandwidth of 100 kHz and video bandwidth of 300 kHz. All measurements were done at 2 channels: low and high operational frequency range.

The center frequency of spectrum is the band edge frequency and span is 7.5 MHz for test mode 1 (5 MHz bandwidth) and 15 MHz for test mode 2 (10 MHz bandwidth). The resolution bandwidth of spectrum is 100 kHz and video bandwidth of spectrum is 300 kHz.

Record the max trace plot into the test report.

Radiated Measurement :

EUT was placed on the turn-table which was rotated around 360 degrees to search the maximum radiation power and receiver antenna was rotated vertical and horizontal polarization to find the maximum polarization radiated power.

The EUT is replaced by a horn antenna connected to a signal generator tuned to the frequency of emission and level of signal generator adjusted to same level of emission. Both horizontal and vertical polarization of the antenna are set on measurement.

On any frequency, the limits shown are based on measuring equipment employing a peak detector function. The resolution bandwidth of spectrum analyzer is 100KHz. and video bandwidth is 300KHz.

The radiated band edge emission was calculated via the Correct factor, Reading Level, and Antenna gain as follows:

Emission Level = Reading Level + Correct Factor = S.G. – Cable Loss + Antenna Gain

5.5. Uncertainty

The measurement uncertainty

Conducted is defined as $\pm 1.27\text{dB}$

Radiated is defined as $\pm 3.9\text{dB}$

5.6. Test Result

Product	Advanced Industrial 4G/LTE Router, WWAN Failover Manager		
Test Item	Band Edge		
Test Mode	Mode 1: WCDMA Band 4_Link mode		
Date of Test	2017/02/03	Test Site	SR10-H

Low Channel (1712.4 MHz)

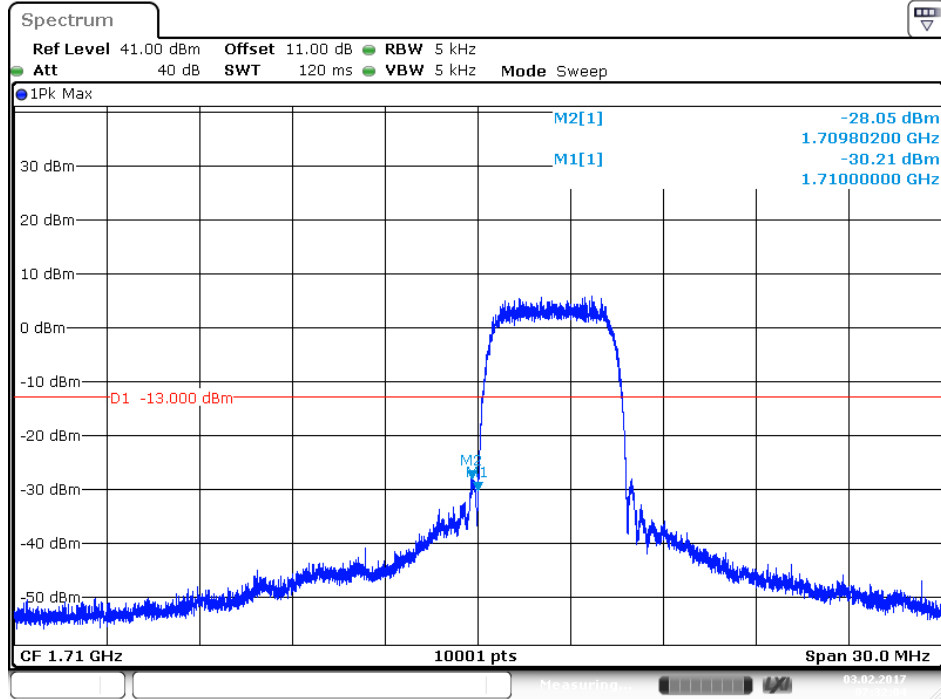

High Channel (1752.6 MHz)

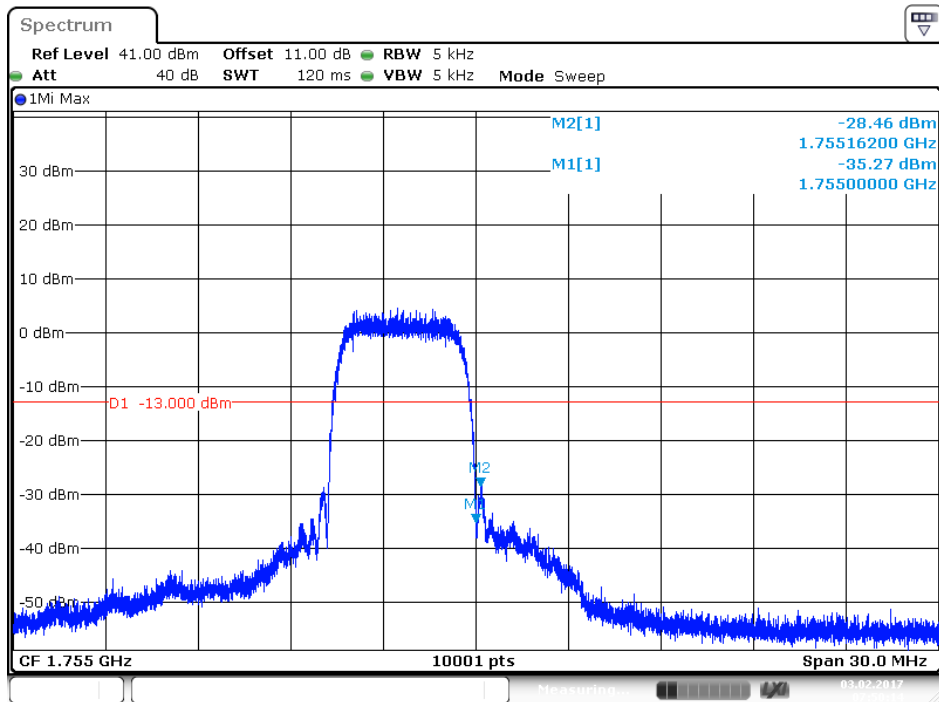

Date: 3 FEB 2017 07:50:14

6. Conducted Spurious Emission

6.1. Test Equipment

The following test equipments are used during the test:

Conducted Spurious Emission / SR10-H

Instrument	Manufacturer	Model No.	Serial No.	Next Cal. Date
Signal & Spectrum Analyzer	R&S	FSV40	101049	2018/01/22
Multisystem UE Tester	Japan radio	NJZ-2000	ET00477	2017/09/19
Directional Coupler	Agilent	778D	20402	2017/10/06

Note: All equipments are calibrated with traceable calibrations. Each calibration is traceable to the national or international standards.

6.2. Test Setup

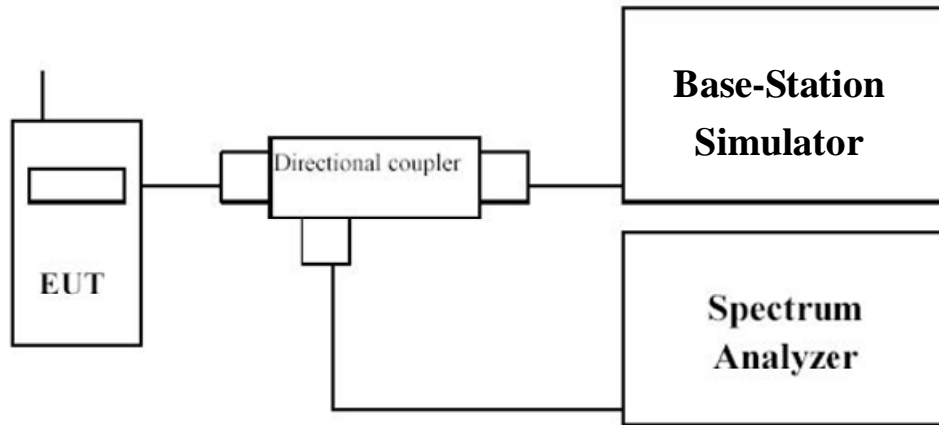

6.3. Limits

- (1) Fixed and Temporary Fixed Digital Stations: not less than $43 + \log (P)$ dB
- (2) Mobile Digital Stations: not less than $43 + \log (P)$ dB at the channel edge and $55 + \log (P)$ dB at 5.5 MHz from the channel edges

Sample Calculation:

Assume the EUT Output Power is $2 \text{ W} = 33 \text{ dBm}$

$43 + \log (P)$ dB

$43 + \log (2) = 46 \text{ dB}$

$33 \text{ dBm} - 46 \text{ dB} = -13 \text{ dBm}$

$55 + \log (2) = 58 \text{ dB}$

$33 \text{ dBm} - 58 \text{ dB} = -25 \text{ dBm}$

6.4. Test Procedure

The EUT was set up for the rated peak power. The power was measured with R&S Spectrum Analyzer. All measurements were done at 3 channels: low, middle and high operational frequency range.

When the spectrum scanned from 30MHz to 27GHz, it connected to the 10dB attenuator to the carried frequency. The spectrum set RBW = 1MHz, VBW = 3MHz. and using peak detection mode.

6.5. Uncertainty

The measurement uncertainty is defined as $\pm 1.27 \text{ dB}$

6.6. Test Result

Product	Advanced Industrial 4G/LTE Router, WWAN Failover Manager		
Test Item	Conducted Spurious Emission		
Test Mode	Mode 1: WCDMA Band 4_Link mode		
Date of Test	2017/02/03	Test Site	SR10-H

1712.4 MHz

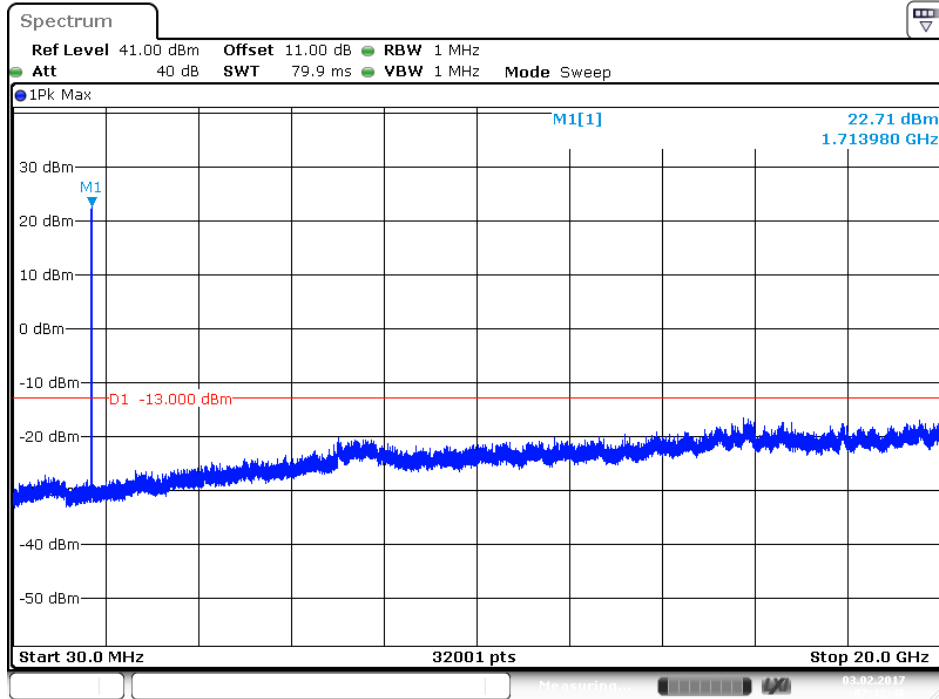

1732.6 MHz

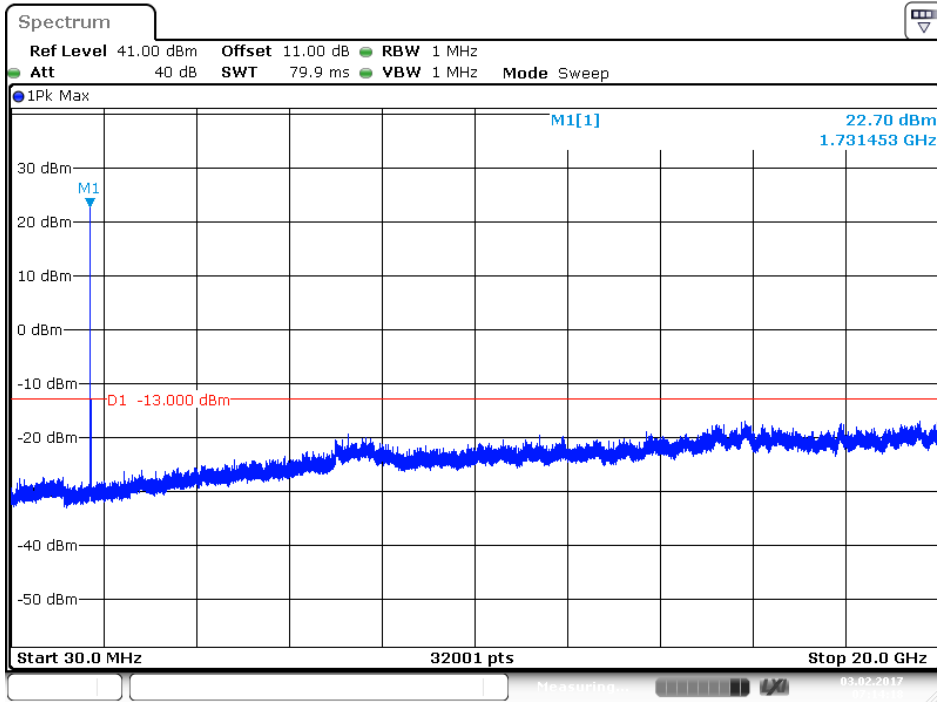

Date: 3 FEB 2017 07:14:19

1752.6 MHz

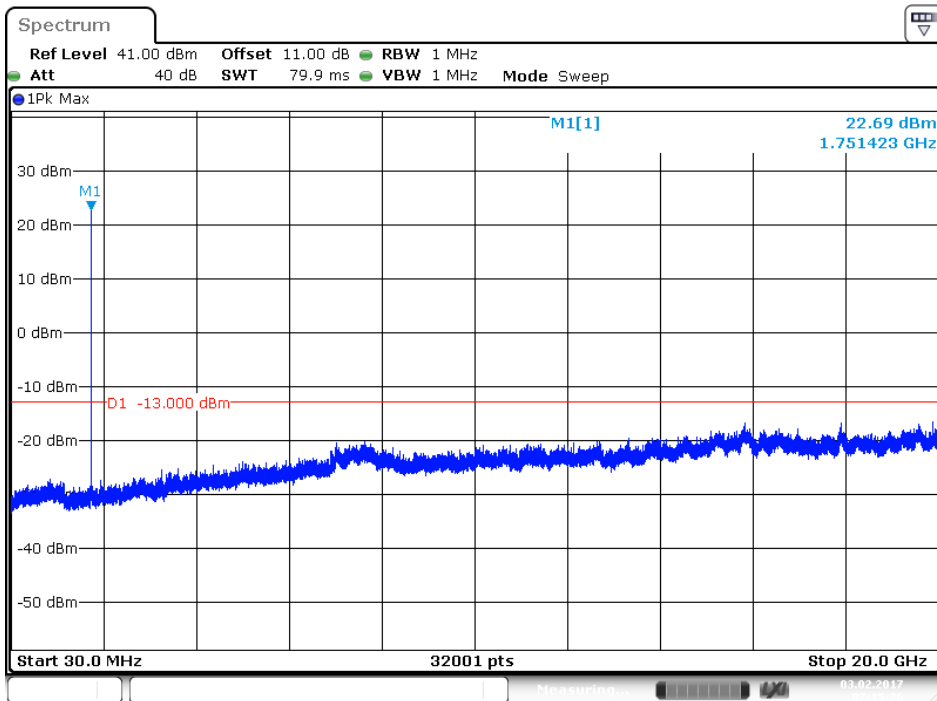

Date: 3 FEB 2017 07:15:27

Product	Advanced Industrial 4G/LTE Router, WWAN Failover Manager		
Test Item	Conducted Spurious Emission		
Test Mode	Mode 3: WCDMA Band 4_HSUPA Mode		
Date of Test	2017/02/24	Test Site	SR10-H

1712.4 MHz

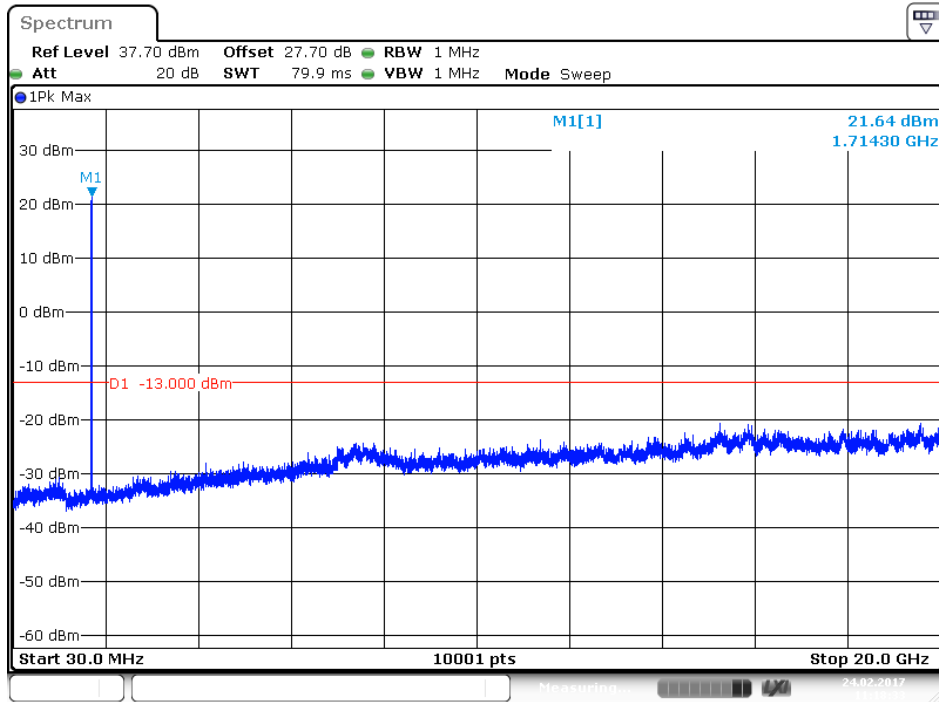

Date: 24.FEB.2017 11:18:34

1732.6 MHz

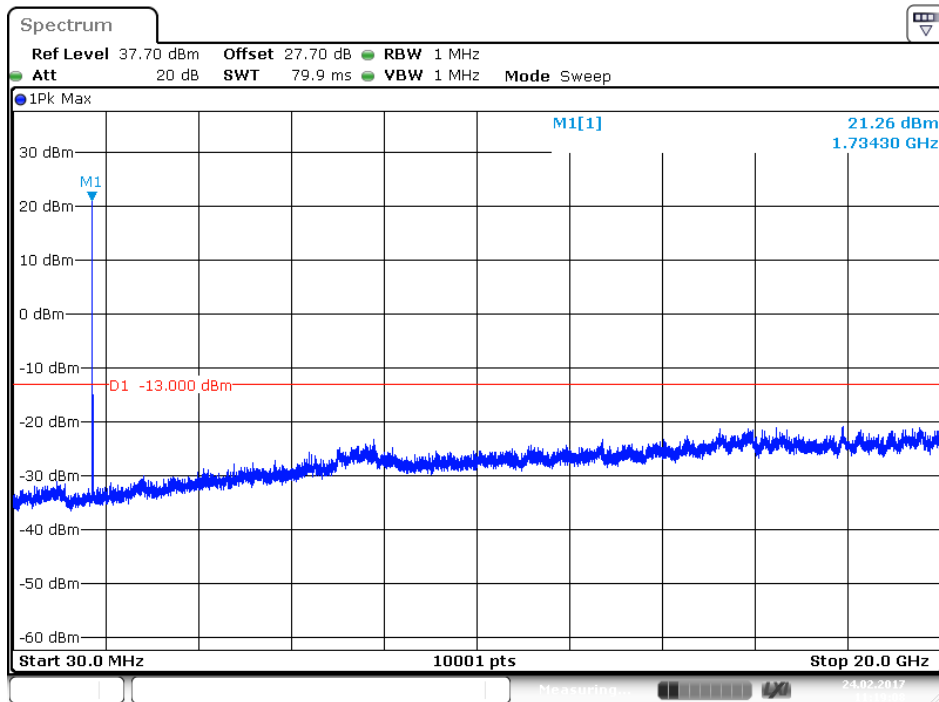

Date: 24.FEB.2017 11:19:08

1752.6 MHz

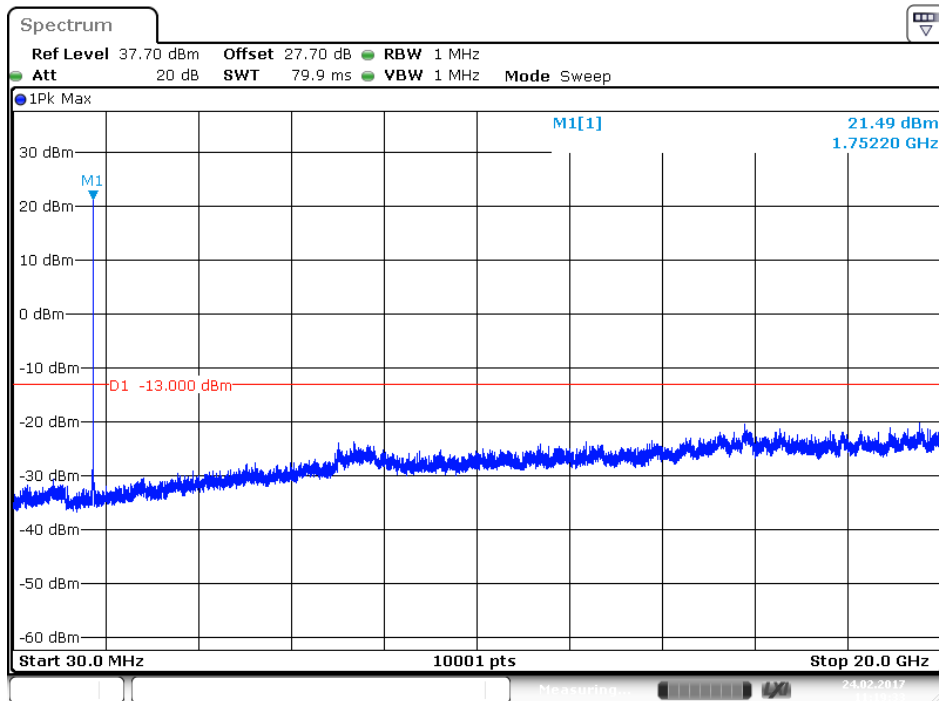

Date: 24.FEB.2017 11:19:34

Product	Advanced Industrial 4G/LTE Router, WWAN Failover Manager		
Test Item	Conducted Spurious Emission		
Test Mode	Mode 4: WCDMA Band 4_HSDPA Mode		
Date of Test	2017/02/24	Test Site	SR10-H

1712.4 MHz

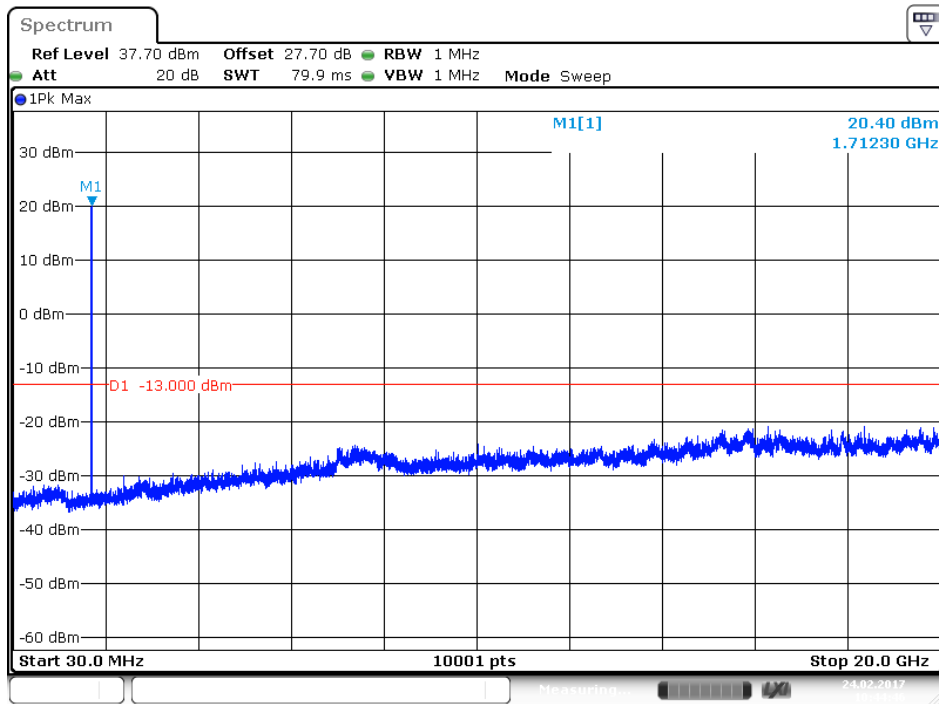

Date: 24.FEB.2017 10:44:46

1732.6 MHz

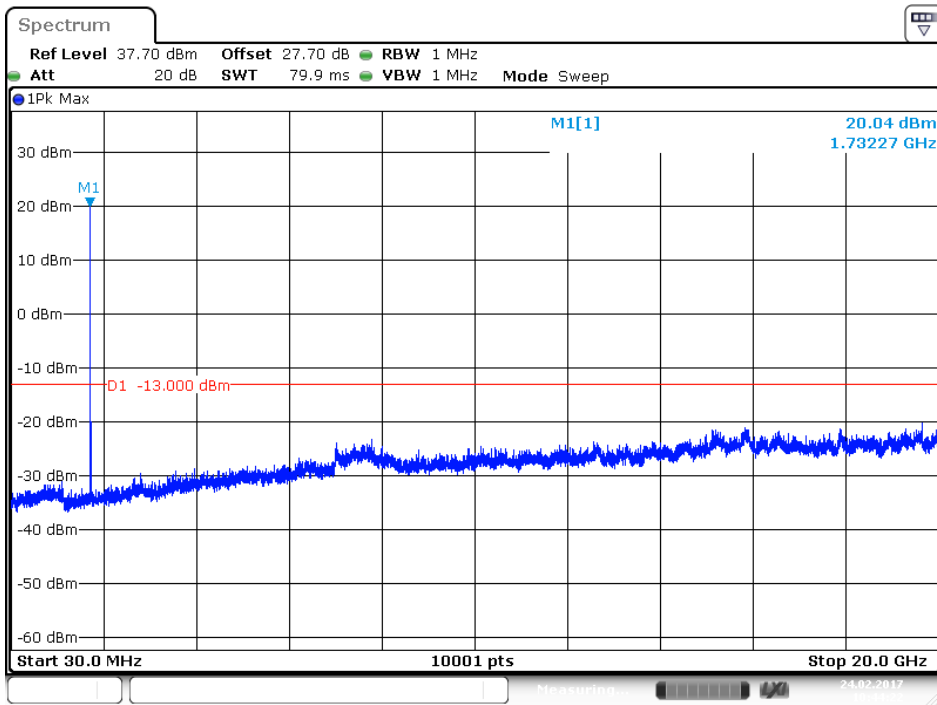

1752.6 MHz

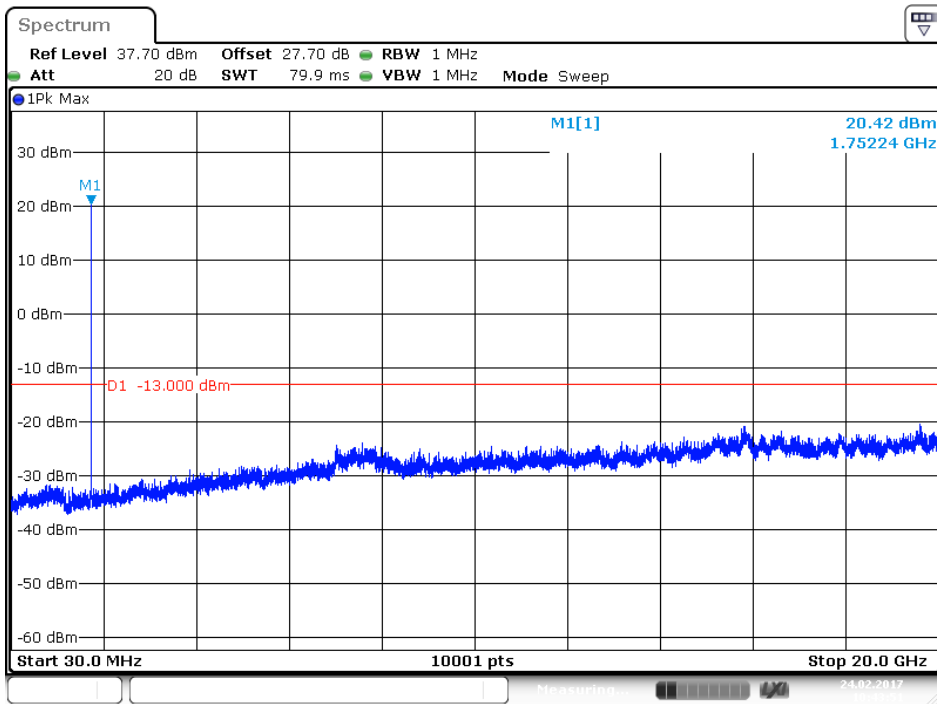

7. Radiated Spurious Emission

7.1. Test Equipment

The following test equipments are used during the test:

Radiated Emission / CB4-H

Instrument	Manufacturer	Model No.	Serial No	Next Cal. Date
Bilog Antenna	Schaffner	CBL6112B	2891	2017/08/14
Horn Antenna	Schwarzbeck	BBHA 9120	D312	2017/10/25
Pre-Amplifier	EMCI	EMC0031835	980233	2018/02/02
Pre-Amplifier	Schwarzbeck	DBL-1840N506	013	2017/09/29
Pre-Amplifier	Miteq	JS41-001040000 -58-5P	1573954	2017/10/04
Horn Antenna	Schwarzbeck	BBHA 9170	203	2017/08/28
Signal & Spectrum Analyzer	R&S	FSV40	101049	2018/01/22

Note: All equipment that need to calibrate are with calibration period of 1 year.

7.2. Test Setup

Under 1GHz Test Setup:

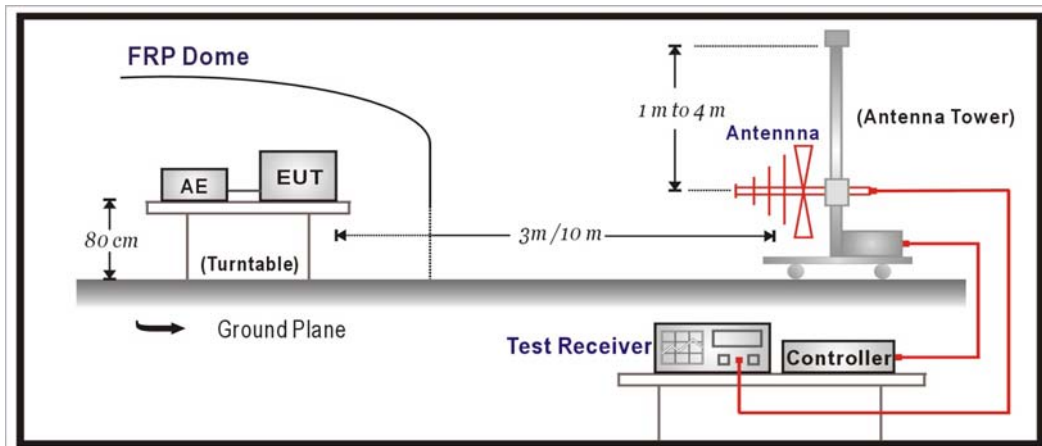

Above 1GHz Test Setup:

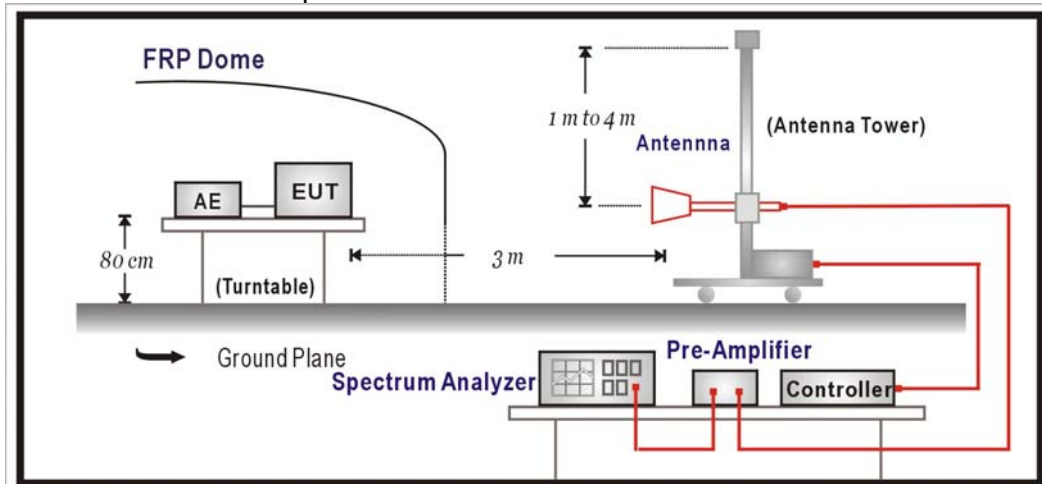

Substitution Measurement Setup:

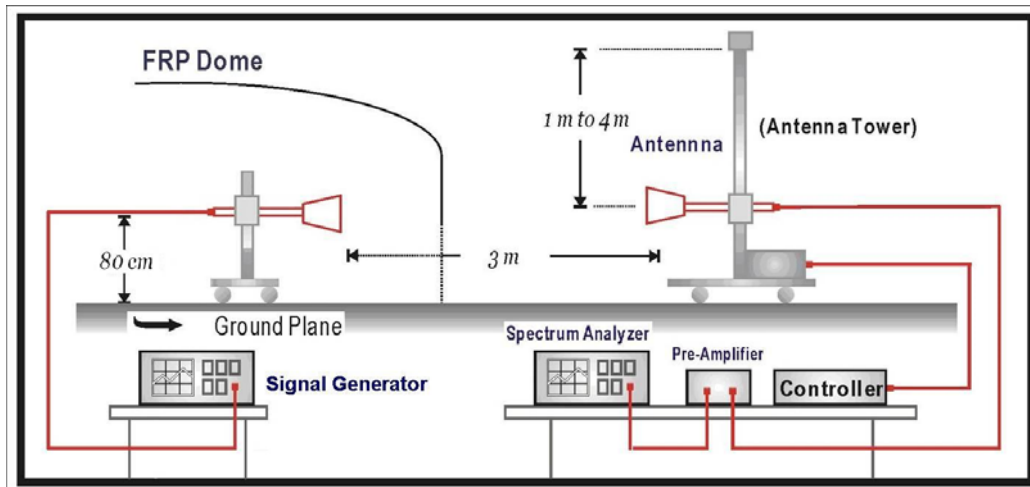

7.3. Limits

- (1) Fixed and Temporary Fixed Digital Stations: not less than $43 + \log (P)$ dB.
- (2) Mobile Digital Stations: not less than $43 + \log (P)$ dB at the channel edge and $55 + \log (P)$ dB at 5.5 MHz from the channel edges.

Sample Calculation:

Assume the EUT Output Power is $2 \text{ W} = 33 \text{ dBm}$

$43 + \log (P)$ dB

$43 + \log (2) = 46 \text{ dB}$

$33 \text{ dBm} - 46 \text{ dB} = -13 \text{ dBm}$

$55 + \log (2) = 58 \text{ dB}$

$33 \text{ dBm} - 58 \text{ dB} = -25 \text{ dBm}$

7.4. Test Procedure

For measuring E.I.R.P peak power, EUT was placed on the turn-table which was rotated around 360 degrees to search the maximum radiation power and receiver antenna was rotated vertical and horizontal polarization to find the maximum polarization radiated power.

The EUT is replaced by a horn antenna connected to a signal generator tuned to the frequency of emission and level of signal generator adjusted to same level of emission. Both horizontal and vertical polarization of the antenna are set on measurement.

On any frequency, the limits shown are based on measuring equipment employing a peak detector function. The resolution bandwidth of spectrum analyzer is 1MHz. and video bandwidth is 3MHz.

The radiated E.I.R.P power was calculated via the Correct factor, Reading Level, and Antenna gain as follows:

$$\text{E.I.R.P} = \text{Reading Level} + \text{Correct Factor} = \text{S.G.} - \text{Cable Loss} + \text{Antenna Gain}$$

7.5. Uncertainty

The measurement uncertainty

30MHz~1GHz as $\pm 3.19\text{dB}$

1GHz~27GHz as $\pm 3.9\text{dB}$

7.6. Test Result

30 MHz - 1 GHz Spurious:

Site : CB4-H	Time : 2017/02/04
Limit : FCC_CLASS_B_03M_QP	Margin : 6
Probe : CB4-H_FCC_EFS_S2_30M-1GHz_1116 - HORIZONTAL	Power : AC 120V / 60Hz
EUT : Advanced Industrial 4G/LTE Router, WWAN Failover Manager	Note : Mode 1: WCDMA Band 4_Link Mode 1732.6MHz

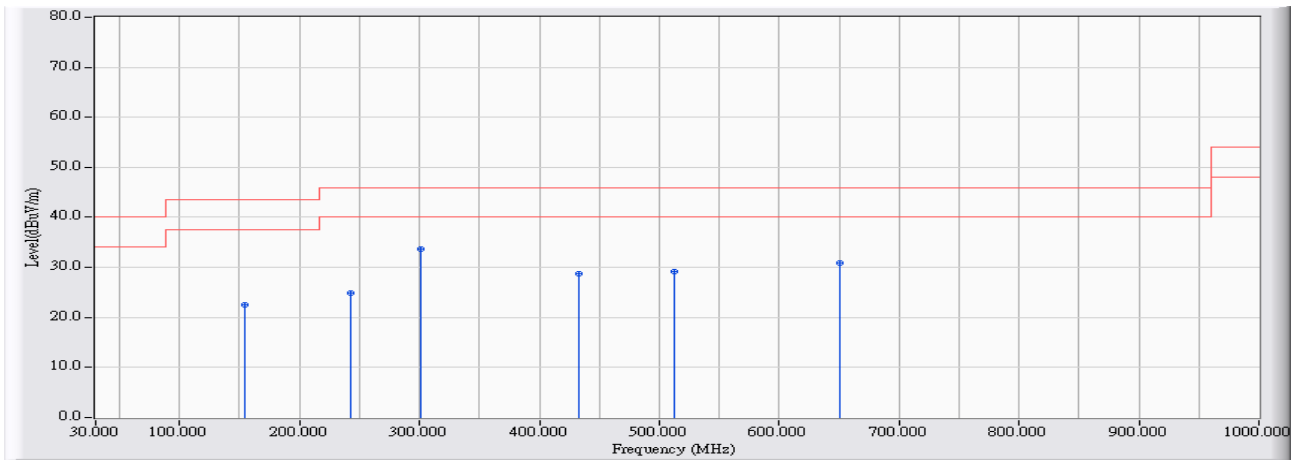

	Frequency (MHz)	Correct Factor (dB)	Reading Level (dBuV)	Measure Level (dBuV/m)	Margin (dB)	Limit (dBuV/m)	Detector Type
1	153.760	-22.464	45.088	22.623	-20.877	43.500	QUASPEAK
2	242.603	-20.653	45.623	24.971	-21.029	46.000	QUASPEAK
3	* 301.573	-19.382	52.996	33.614	-12.386	46.000	QUASPEAK
4	432.704	-15.406	44.251	28.845	-17.155	46.000	QUASPEAK
5	513.012	-13.579	42.739	29.160	-16.840	46.000	QUASPEAK
6	650.835	-12.886	43.774	30.888	-15.112	46.000	QUASPEAK

Note:

1. All Reading Levels are Quasi-Peak value.
2. “ * ”, means this data is the worst emission level.
3. Measurement Level = Reading Level + Correct Factor.

Site : CB4-H	Time : 2017/02/04
Limit : FCC_CLASS_B_03M_QP	Margin : 6
Probe : CB4-H_FCC_EFS_S2_30M-1GHz_1116 - VERTICAL	Power : AC 120V / 60Hz
EUT : Advanced Industrial 4G/LTE Router, WWAN Failover Manager	Note : Mode 1: WCDMA Band 4_Link 1732.6MHz

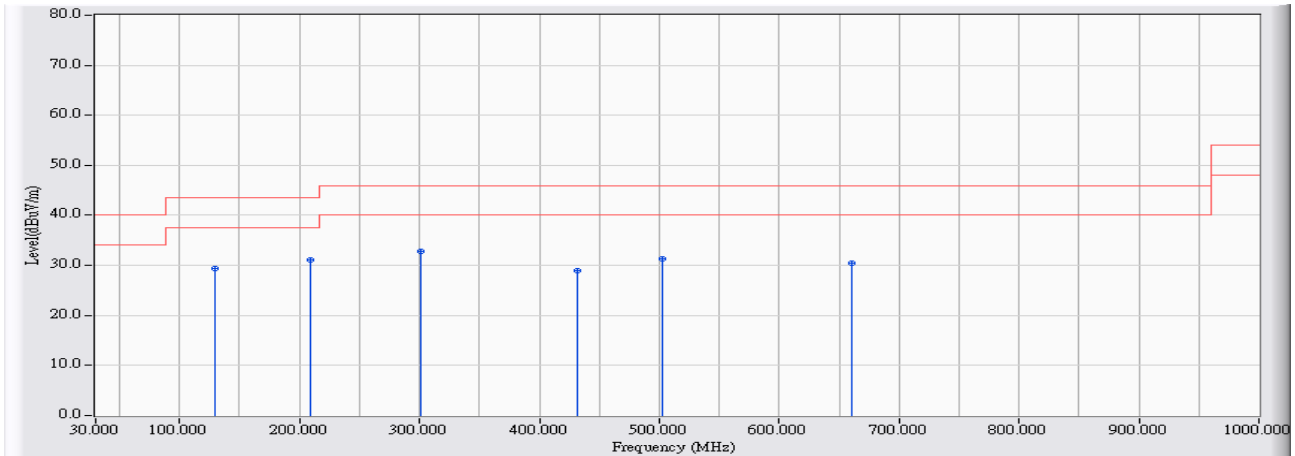

		Frequency (MHz)	Correct Factor (dB)	Reading Level (dBuV)	Measure Level (dBuV/m)	Margin (dB)	Limit (dBuV/m)	Detector Type
1		129.609	-21.254	50.654	29.400	-14.100	43.500	QUASPEAK
2	*	209.238	-22.530	53.732	31.202	-12.298	43.500	QUASPEAK
3		301.573	-19.382	52.095	32.713	-13.287	46.000	QUASPEAK
4		431.540	-15.442	44.418	28.976	-17.024	46.000	QUASPEAK
5		501.955	-13.957	45.194	31.237	-14.763	46.000	QUASPEAK
6		660.534	-12.189	42.589	30.400	-15.600	46.000	QUASPEAK

Note:

1. All Reading Levels are Quasi-Peak value.
2. “ * ”, means this data is the worst emission level.
3. Measurement Level = Reading Level + Correct Factor.

Site : CB4-H	Time : 2017/02/04
Limit : FCC_CLASS_B_03M_QP	Margin : 6
Probe : CB4-H_FCC_EFS_S2_30M-1GHz_1116 - HORIZONTAL	Power : AC 120V / 60Hz
EUT : Advanced Industrial 4G/LTE Router, WWAN Failover Manager	Note : Mode 2: WCDMA Band 4_Idle Mode 1732.6MHz

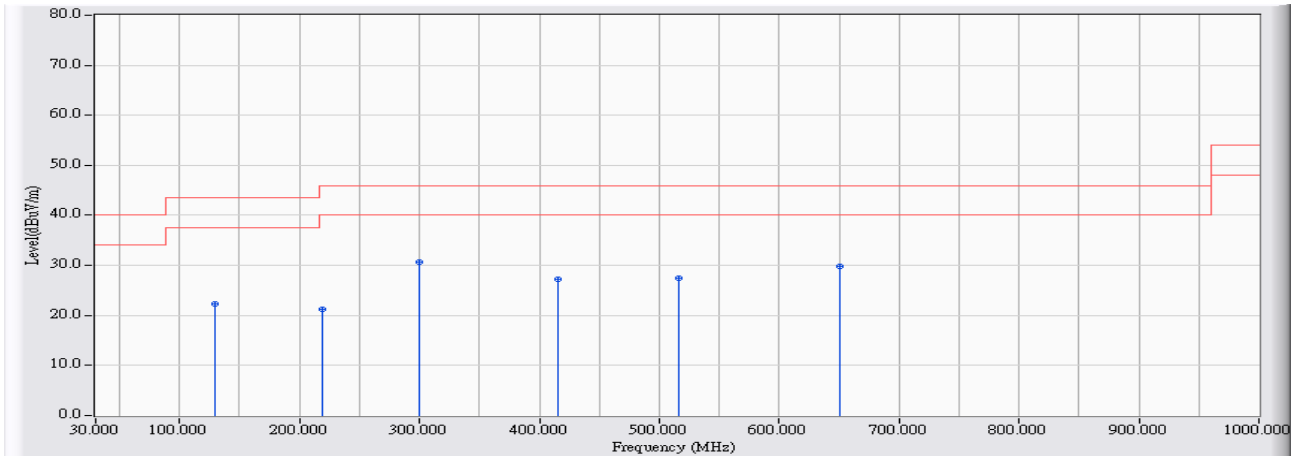

	Frequency (MHz)	Correct Factor (dB)	Reading Level (dBuV)	Measure Level (dBuV/m)	Margin (dB)	Limit (dBuV/m)	Detector Type
1	129.318	-21.252	43.502	22.251	-21.249	43.500	QUASPEAK
2	219.325	-22.084	43.399	21.315	-24.685	46.000	QUASPEAK
3	* 300.021	-19.403	50.105	30.702	-15.298	46.000	QUASPEAK
4	415.536	-15.700	42.932	27.231	-18.769	46.000	QUASPEAK
5	515.824	-13.570	41.010	27.440	-18.560	46.000	QUASPEAK
6	649.962	-12.929	42.838	29.909	-16.091	46.000	QUASPEAK

Note:

1. All Reading Levels are Quasi-Peak value.
2. “ * ”, means this data is the worst emission level.
3. Measurement Level = Reading Level + Correct Factor.

Site : CB4-H	Time : 2017/02/04
Limit : FCC_CLASS_B_03M_QP	Margin : 6
Probe : CB4-H_FCC_EFS_S2_30M-1GHz_1116 - VERTICAL	Power : AC 120V / 60Hz
EUT : Advanced Industrial 4G/LTE Router, WWAN Failover Manager	Note : Mode 2: WCDMA Band 4_Idle Mode 1732.6MHz

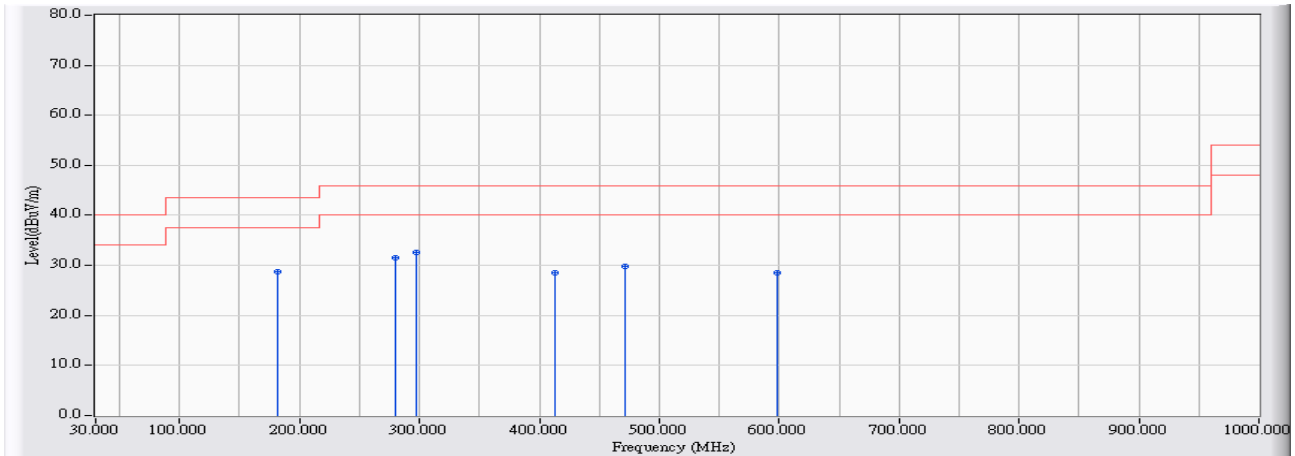

	Frequency (MHz)	Correct Factor (dB)	Reading Level (dBuV)	Measure Level (dBuV/m)	Margin (dB)	Limit (dBuV/m)	Detector Type
1	182.178	-23.999	52.769	28.770	-14.730	43.500	QUASPEAK
2	280.041	-19.350	50.923	31.572	-14.428	46.000	QUASPEAK
3	* 297.499	-19.382	51.973	32.592	-13.408	46.000	QUASPEAK
4	413.306	-15.625	44.154	28.530	-17.470	46.000	QUASPEAK
5	470.918	-14.564	44.333	29.769	-16.231	46.000	QUASPEAK
6	598.848	-12.756	41.190	28.434	-17.566	46.000	QUASPEAK

Note:

1. All Reading Levels are Quasi-Peak value.
2. “ * ”, means this data is the worst emission level.
3. Measurement Level = Reading Level + Correct Factor.

Site : CB4-H	Time : 2017/02/24
Limit : FCC_Part22/24_00M_00M_PK	Margin : 6
Probe : CB4_CE_Sub_S2_30M-1GHz_1116 - HORIZONTAL	Power : AC 120V / 60Hz
EUT : Advanced Industrial 4G/LTE Router, WWAN Failover Manager	Note : Mode 3: WCDMA Band 4_HSUPA Mode _1732.6_HSUPA_Link

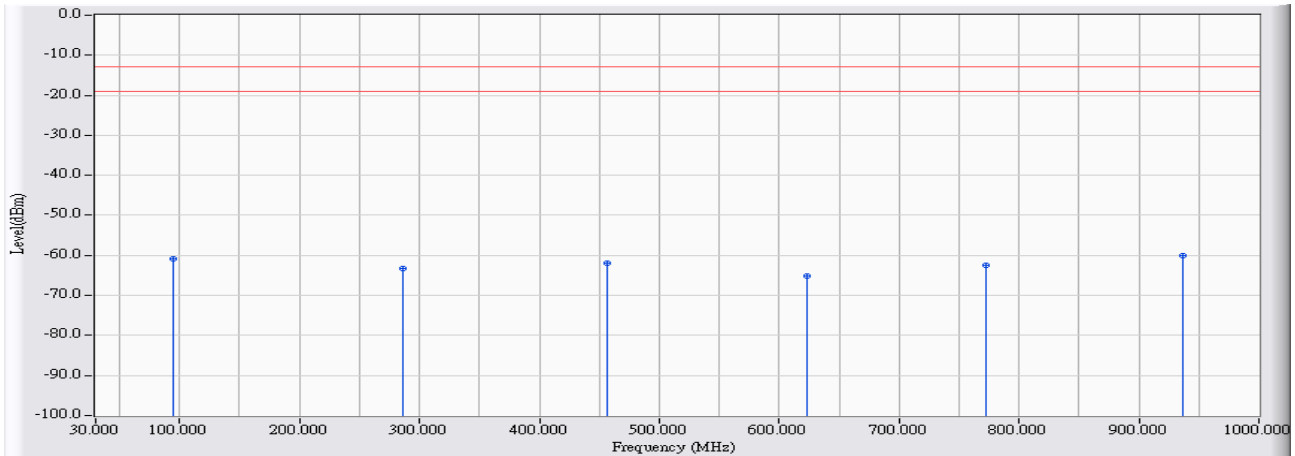

	Frequency (MHz)	Correct Factor (dB)	Reading Level (dBm)	Measure Level (dBm)	Margin (dB)	Limit (dBm)	Detector Type
1	94.208	-28.119	-32.844	-60.964	-47.964	-13.000	PEAK
2	285.569	-21.083	-42.193	-63.275	-50.275	-13.000	PEAK
3	456.951	-14.938	-47.055	-61.993	-48.993	-13.000	PEAK
4	622.999	-11.897	-53.122	-65.019	-52.019	-13.000	PEAK
5	772.170	-10.033	-52.536	-62.568	-49.568	-13.000	PEAK
6	* 936.180	-7.789	-52.233	-60.022	-47.022	-13.000	PEAK

Note:

1. All Reading Levels are Quasi-Peak value.
2. “ * ”, means this data is the worst emission level.
3. Measurement Level = Reading Level + Correct Factor.

Site : CB4-H	Time : 2017/02/24
Limit : FCC_Part22/24_00M_00M_PK	Margin : 6
Probe : CB4_CE_Sub_S2_30M-1GHz_1116 - VERTICAL	Power : AC 120V / 60Hz
EUT : Advanced Industrial 4G/LTE Router, WWAN Failover Manager	Note : Mode 3: WCDMA Band 4_HSUPA Mode _1732.6_HSUPA_Link

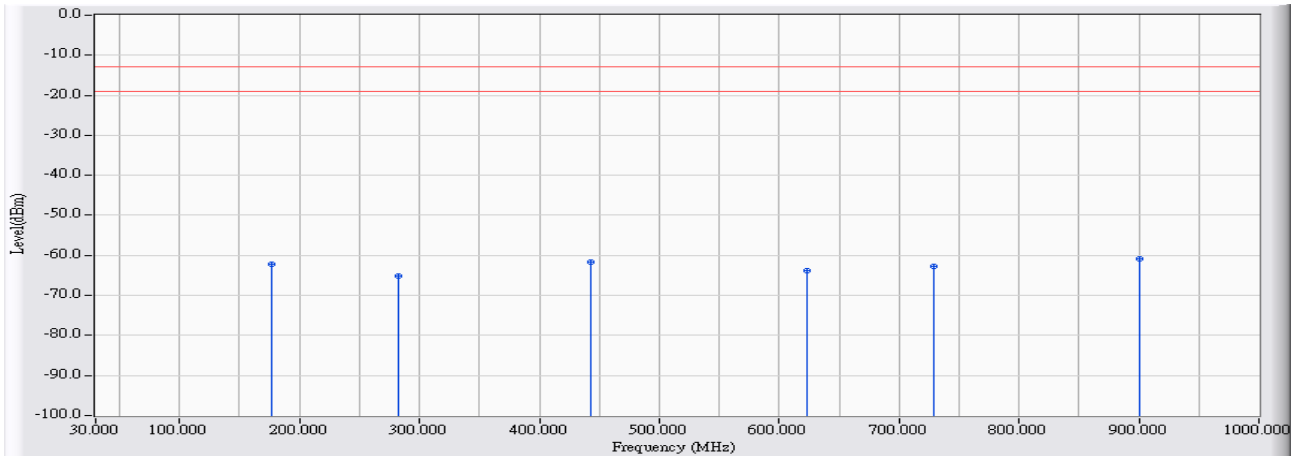

		Frequency (MHz)	Correct Factor (dB)	Reading Level (dBm)	Measure Level (dBm)	Margin (dB)	Limit (dBm)	Detector Type
1		176.261	-22.817	-39.383	-62.200	-49.200	-13.000	PEAK
2		281.981	-20.672	-44.433	-65.105	-52.105	-13.000	PEAK
3		442.403	-15.449	-46.288	-61.737	-48.737	-13.000	PEAK
4		623.290	-11.322	-52.539	-63.862	-50.862	-13.000	PEAK
5		728.718	-10.291	-52.316	-62.607	-49.607	-13.000	PEAK
6	*	900.100	-8.774	-52.177	-60.951	-47.951	-13.000	PEAK

Note:

1. All Reading Levels are Quasi-Peak value.
2. “ * ”, means this data is the worst emission level.
3. Measurement Level = Reading Level + Correct Factor.

Site : CB4-H	Time : 2017/02/24
Limit : FCC_Part22/24_00M_00M_PK	Margin : 6
Probe : CB4_CE_Sub_S2_30M-1GHz_1116 - HORIZONTAL	Power : AC 120V / 60Hz
EUT : Advanced Industrial 4G/LTE Router, WWAN Failover Manager	Note : Mode 3: WCDMA Band 4_HSUPA Mode _1732.6_HSUPA_Idle

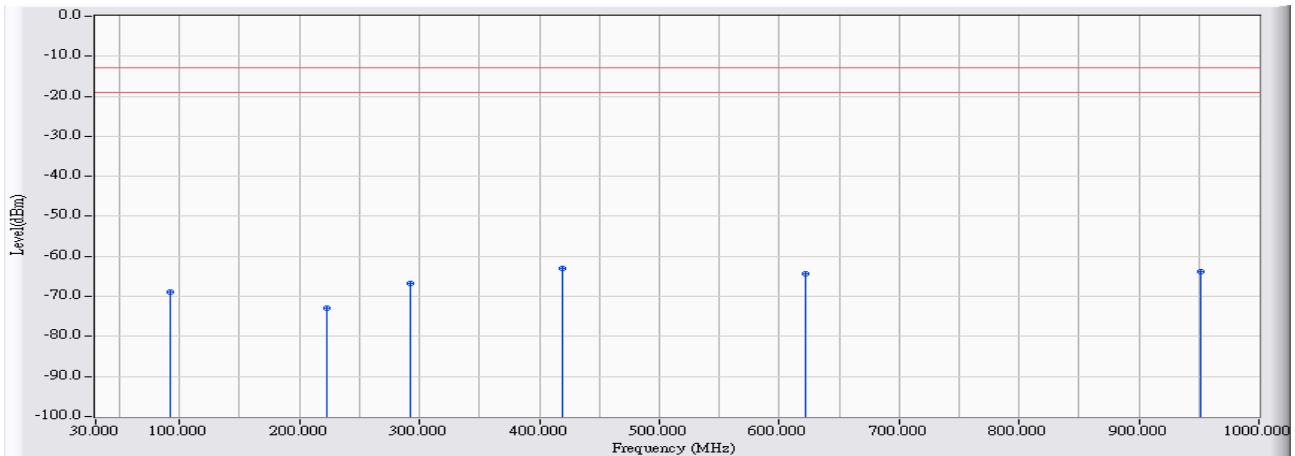

	Frequency (MHz)	Correct Factor (dB)	Reading Level (dBm)	Measure Level (dBm)	Margin (dB)	Limit (dBm)	Detector Type
1	91.977	-28.191	-40.727	-68.918	-55.918	-13.000	PEAK
2	223.011	-25.614	-47.288	-72.902	-59.902	-13.000	PEAK
3	292.553	-20.755	-46.108	-66.862	-53.862	-13.000	PEAK
4	* 419.804	-16.270	-46.618	-62.888	-49.888	-13.000	PEAK
5	621.835	-11.854	-52.517	-64.371	-51.371	-13.000	PEAK
6	951.020	-7.443	-56.354	-63.798	-50.798	-13.000	PEAK

Note:

1. All Reading Levels are Quasi-Peak value.
2. “ * ”, means this data is the worst emission level.
3. Measurement Level = Reading Level + Correct Factor.

Site : CB4-H	Time : 2017/02/24
Limit : FCC_Part22/24_00M_00M_PK	Margin : 6
Probe : CB4_CE_Sub_S2_30M-1GHz_1116 - VERTICAL	Power : AC 120V / 60Hz
EUT : Advanced Industrial 4G/LTE Router, WWAN Failover Manager	Note : Mode 3: WCDMA Band 4_HSUPA Mode _1732.6_HSUPA_Idle

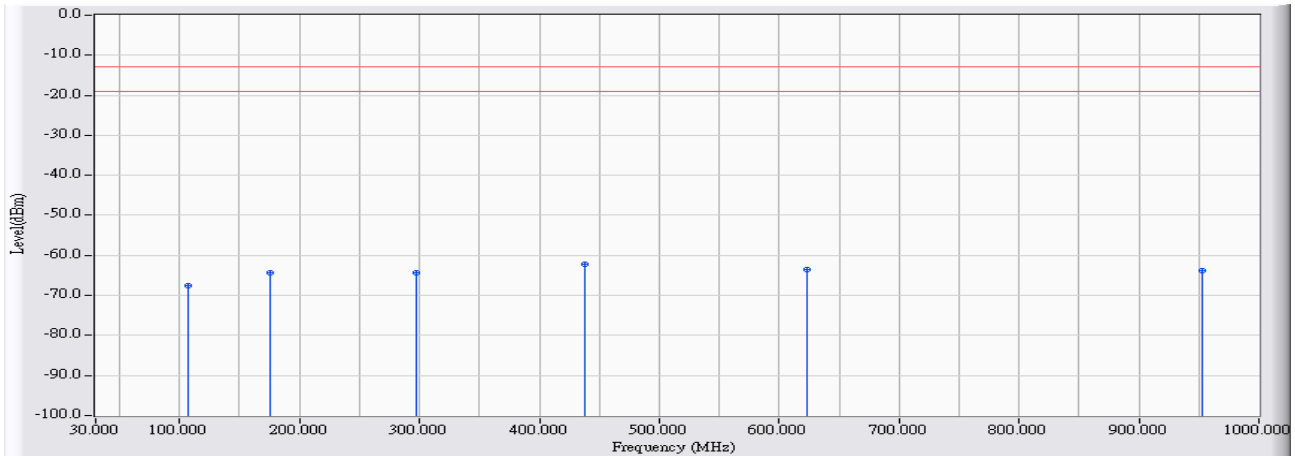

	Frequency (MHz)	Correct Factor (dB)	Reading Level (dBm)	Measure Level (dBm)	Margin (dB)	Limit (dBm)	Detector Type
1	107.592	-20.366	-47.197	-67.562	-54.562	-13.000	PEAK
2	175.873	-22.781	-41.561	-64.342	-51.342	-13.000	PEAK
3	296.917	-20.322	-44.023	-64.346	-51.346	-13.000	PEAK
4	* 438.329	-15.660	-46.616	-62.275	-49.275	-13.000	PEAK
5	623.387	-11.326	-52.190	-63.516	-50.516	-13.000	PEAK
6	952.475	-7.518	-56.346	-63.863	-50.863	-13.000	PEAK

Note:

1. All Reading Levels are Quasi-Peak value.
2. “ * ”, means this data is the worst emission level.
3. Measurement Level = Reading Level + Correct Factor.

Site : CB4-H	Time : 2017/02/24
Limit : FCC_Part22/24_00M_00M_PK	Margin : 6
Probe : CB4_CE_Sub_S2_30M-1GHz_1116 - HORIZONTAL	Power : AC 120V / 60Hz
EUT : Advanced Industrial 4G/LTE Router, WWAN Failover Manager	Note : Mode 4: WCDMA Band 4_HSDPA Mode _1880_HSDPA_Link

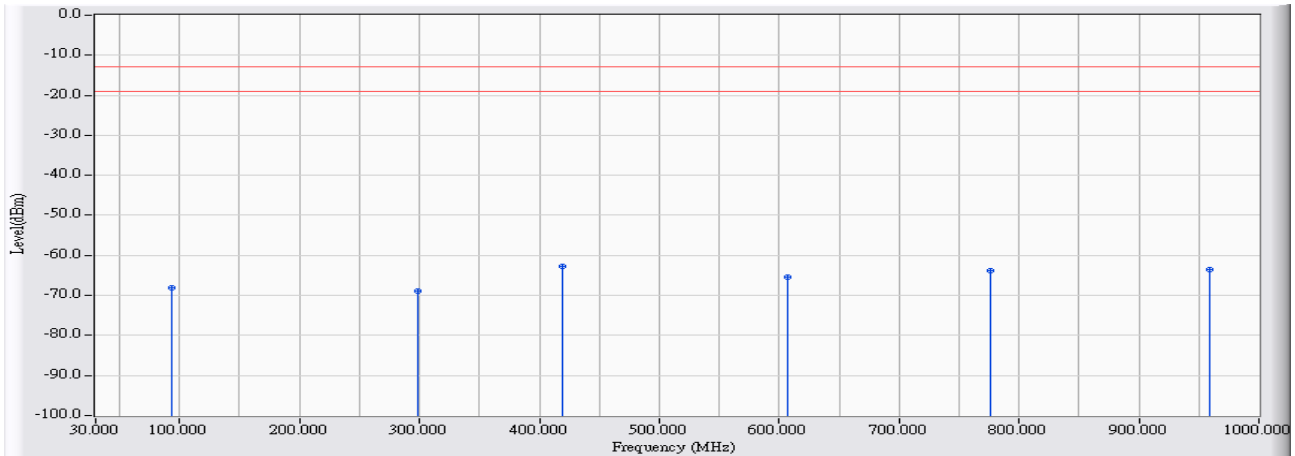

	Frequency (MHz)	Correct Factor (dB)	Reading Level (dBm)	Measure Level (dBm)	Margin (dB)	Limit (dBm)	Detector Type
1	92.947	-28.160	-40.004	-68.164	-55.164	-13.000	PEAK
2	298.081	-20.550	-48.395	-68.945	-55.945	-13.000	PEAK
3	* 419.125	-16.247	-46.510	-62.757	-49.757	-13.000	PEAK
4	606.413	-12.341	-52.964	-65.305	-52.305	-13.000	PEAK
5	776.728	-9.599	-54.115	-63.715	-50.715	-13.000	PEAK
6	959.264	-7.921	-55.674	-63.595	-50.595	-13.000	PEAK

Note:

1. All Reading Levels are Quasi-Peak value.
2. “ * ”, means this data is the worst emission level.
3. Measurement Level = Reading Level + Correct Factor.

Site : CB4-H	Time : 2017/02/24
Limit : FCC_Part22/24_00M_00M_PK	Margin : 6
Probe : CB4_CE_Sub_S2_30M-1GHz_1116 - VERTICAL	Power : AC 120V / 60Hz
EUT : Advanced Industrial 4G/LTE Router, WWAN Failover Manager	Note : Mode 4: WCDMA Band 4_HSDPA Mode _1880_HSDPA_Link

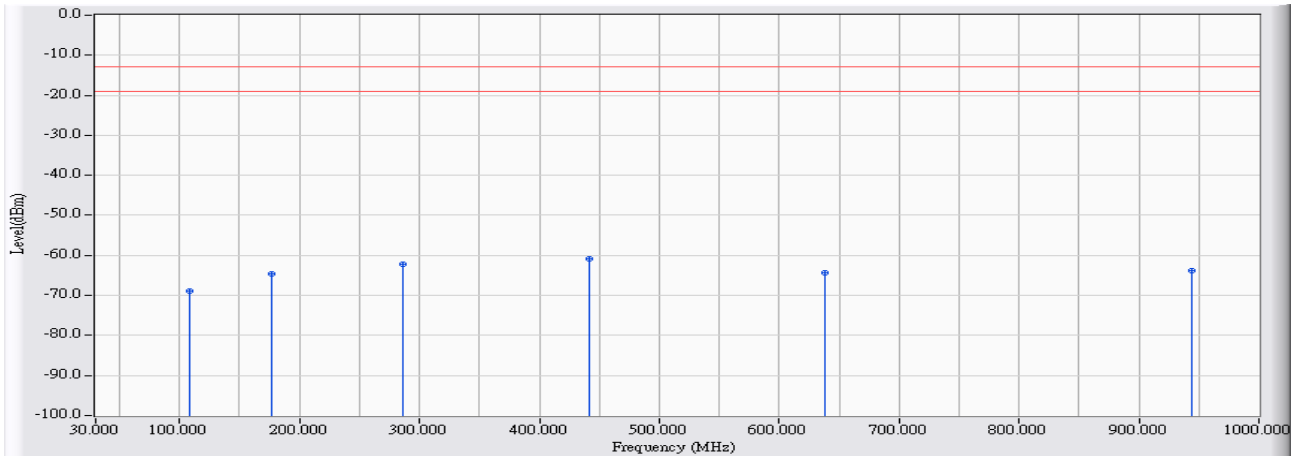

	Frequency (MHz)	Correct Factor (dB)	Reading Level (dBm)	Measure Level (dBm)	Margin (dB)	Limit (dBm)	Detector Type
1	108.368	-20.446	-48.373	-68.818	-55.818	-13.000	PEAK
2	176.164	-22.809	-41.837	-64.645	-51.645	-13.000	PEAK
3	286.151	-20.545	-41.619	-62.164	-49.164	-13.000	PEAK
4	* 441.045	-15.532	-45.222	-60.754	-47.754	-13.000	PEAK
5	638.129	-12.094	-52.202	-64.295	-51.295	-13.000	PEAK
6	943.455	-7.435	-56.420	-63.855	-50.855	-13.000	PEAK

Note:

1. All Reading Levels are Quasi-Peak value.
2. “ * ”, means this data is the worst emission level.
3. Measurement Level = Reading Level + Correct Factor.

Site : CB4-H	Time : 2017/02/24
Limit : FCC_Part22/24_00M_00M_PK	Margin : 6
Probe : CB4_CE_Sub_S2_30M-1GHz_1116 - HORIZONTAL	Power : AC 120V / 60Hz
EUT : Advanced Industrial 4G/LTE Router, WWAN Failover Manager	Note : Mode 4: WCDMA Band 4_HSDPA Mode _1732.6_HSDPA_Idle

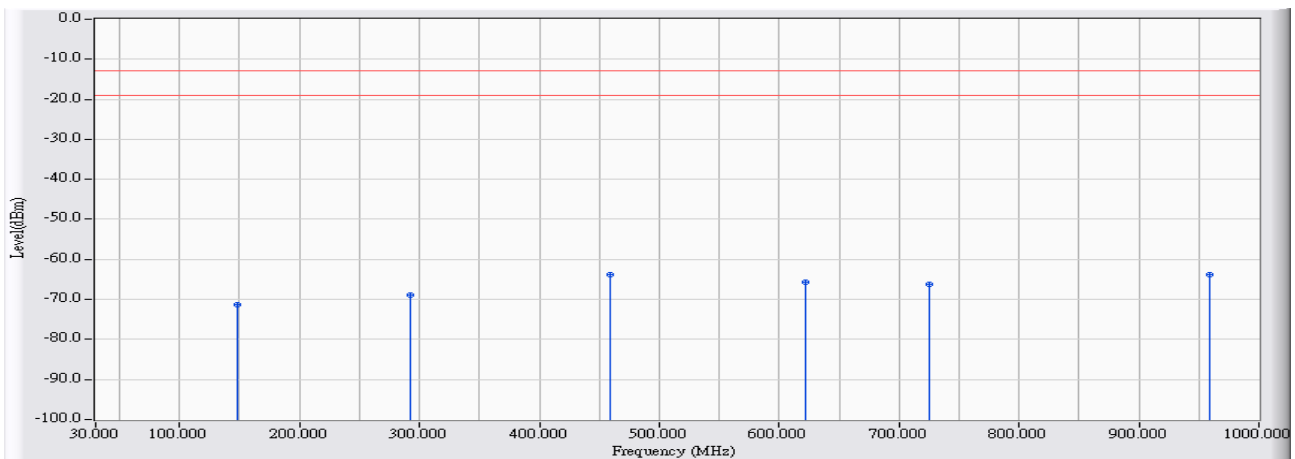

	Frequency (MHz)	Correct Factor (dB)	Reading Level (dBm)	Measure Level (dBm)	Margin (dB)	Limit (dBm)	Detector Type
1	147.649	-28.094	-43.328	-71.422	-58.422	-13.000	PEAK
2	292.068	-20.772	-48.150	-68.922	-55.922	-13.000	PEAK
3	* 459.376	-14.893	-48.893	-63.786	-50.786	-13.000	PEAK
4	622.417	-11.876	-53.934	-65.810	-52.810	-13.000	PEAK
5	725.614	-10.835	-55.443	-66.278	-53.278	-13.000	PEAK
6	958.779	-7.894	-55.956	-63.849	-50.849	-13.000	PEAK

Note:

1. All Reading Levels are Quasi-Peak value.
2. “ * ”, means this data is the worst emission level.
3. Measurement Level = Reading Level + Correct Factor.

Site : CB4-H	Time : 2017/02/24
Limit : FCC_Part22/24_00M_00M_PK	Margin : 6
Probe : CB4_CE_Sub_S2_30M-1GHz_1116 - VERTICAL	Power : AC 120V / 60Hz
EUT : Advanced Industrial 4G/LTE Router, WWAN Failover Manager	Note : Mode 4: WCDMA Band 4_HSDPA Mode _1732.6_HSDPA_Idle

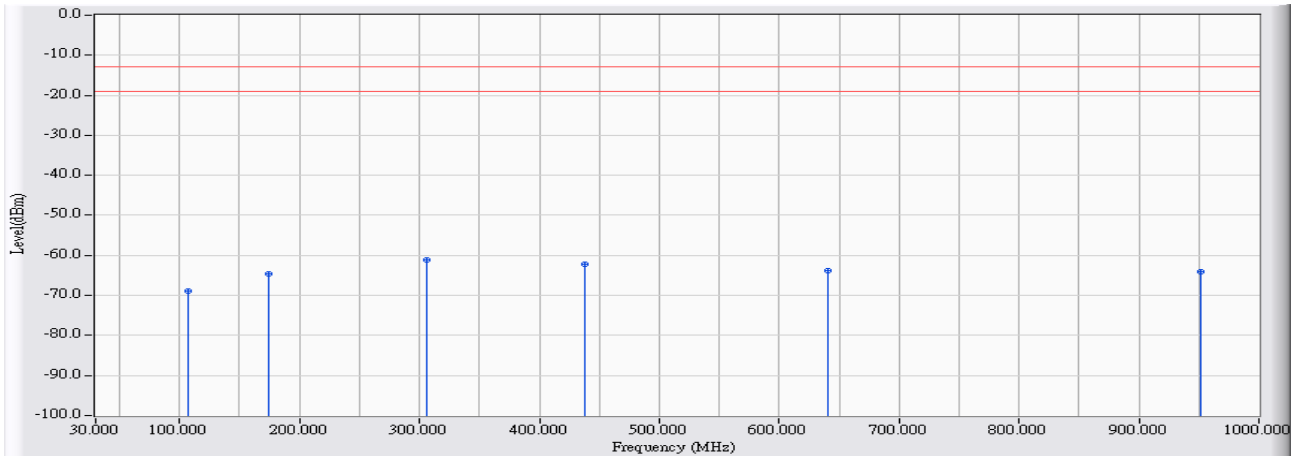

	Frequency (MHz)	Correct Factor (dB)	Reading Level (dBm)	Measure Level (dBm)	Margin (dB)	Limit (dBm)	Detector Type
1	107.592	-20.366	-48.518	-68.883	-55.883	-13.000	PEAK
2	174.225	-22.694	-42.033	-64.726	-51.726	-13.000	PEAK
3	* 305.743	-20.171	-40.882	-61.052	-48.052	-13.000	PEAK
4	438.329	-15.660	-46.583	-62.242	-49.242	-13.000	PEAK
5	640.166	-12.214	-51.682	-63.896	-50.896	-13.000	PEAK
6	951.602	-7.469	-56.602	-64.070	-51.070	-13.000	PEAK

Note:

1. All Reading Levels are Quasi-Peak value.
2. “ * ”, means this data is the worst emission level.
3. Measurement Level = Reading Level + Correct Factor.

Harmonic & Spurious:

Site : CB4-H	Time : 2017/02/04
Limit : FCC_Part27(outband)_00M_PK	Margin : 6
Probe : CB4-H_CE_Sub_B432_1-18GHz_3M_1116 - HORIZONTAL	Power : AC 120V / 60Hz
EUT : Advanced Industrial 4G/LTE Router, WWAN Failover Manager	Note : Mode 1: WCDMA Band 4_Link Mode 1712.4MHz

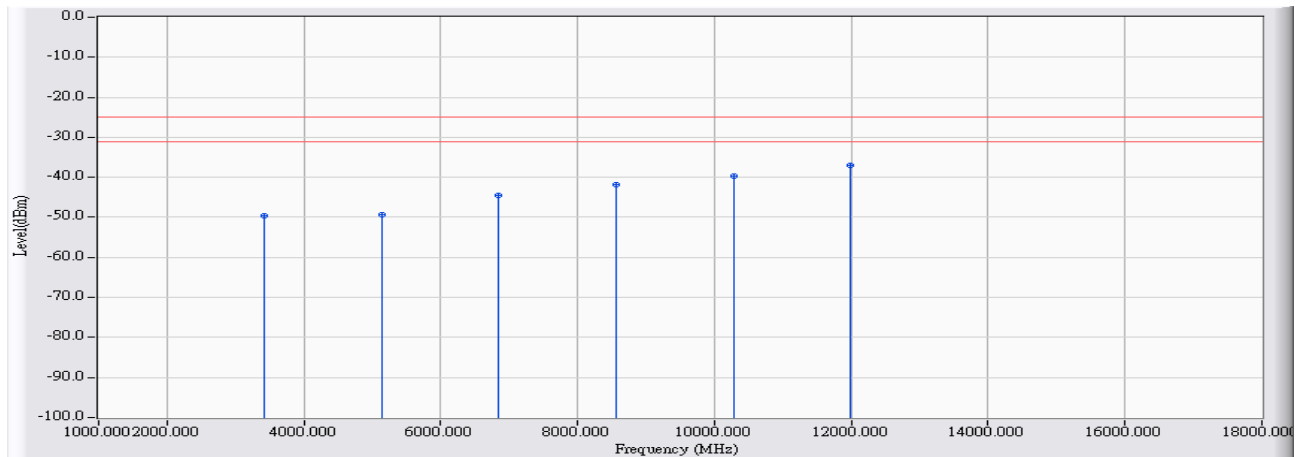

	Frequency (MHz)	Correct Factor (dB)	Reading Level (dBm)	Measure Level (dBm)	Margin (dB)	Limit (dBm)	Detector Type
1	3424.800	17.946	-67.490	-49.543	-24.543	-25.000	PEAK
2	5137.200	20.368	-69.630	-49.262	-24.262	-25.000	PEAK
3	6849.600	25.503	-69.880	-44.377	-19.377	-25.000	PEAK
4	8562.000	27.718	-69.530	-41.812	-16.812	-25.000	PEAK
5	10274.400	29.907	-69.520	-39.613	-14.613	-25.000	PEAK
6	* 11986.800	31.781	-68.790	-37.009	-12.009	-25.000	PEAK

Note:

1. All readings above 1GHz are performed with peak and/or average measurements as necessary.
2. Peak measurements: RBW = 1MHz, VBW = 1MHz, Sweep: Auto.
3. Average measurements: RBW = 1MHz, VBW = 10 Hz, Sweep: Auto.
4. “ * ”, means this data is the worst emission level.
5. Measurement Level = Reading Level + Correct Factor.
6. The average measurement was not performed when the peak measured data under the limit of average detection.
7. The Emission above 18GHz were not included is because their levels are too low.

Site : CB4-H	Time : 2017/02/04
Limit : FCC_Part27(outband)_00M_PK	Margin : 6
Probe : CB4-H_CE_Sub_B432_1-18GHz_3M_1116 - VERTICAL	Power : AC 120V / 60Hz
EUT : Advanced Industrial 4G/LTE Router, WWAN Failover Manager	Note : Mode 1: WCDMA Band 4_Link Mode 1712.4MHz

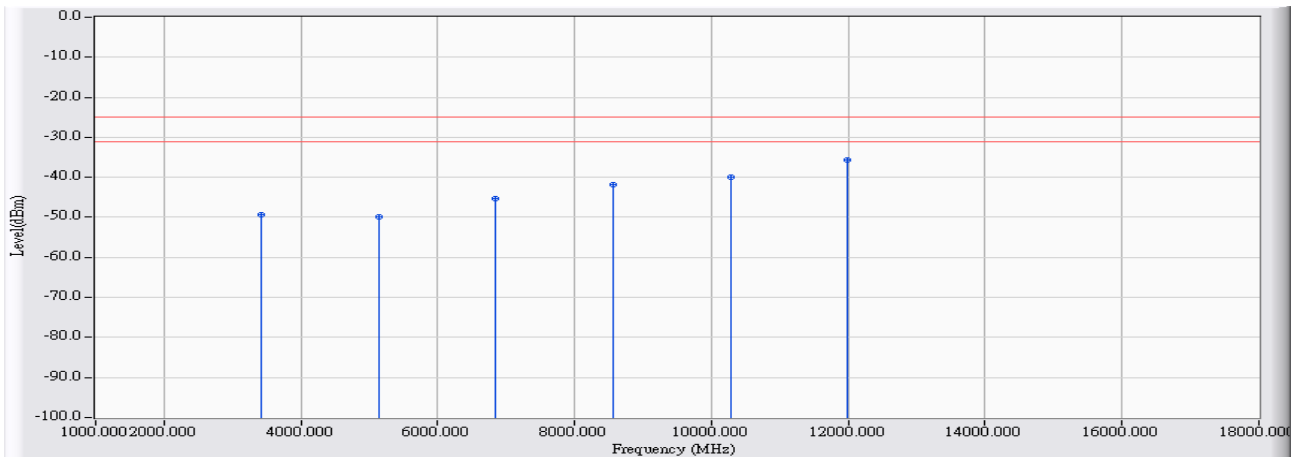

	Frequency (MHz)	Correct Factor (dB)	Reading Level (dBm)	Measure Level (dBm)	Margin (dB)	Limit (dBm)	Detector Type
1	3424.800	18.681	-68.040	-49.359	-24.359	-25.000	PEAK
2	5137.200	20.058	-69.890	-49.832	-24.832	-25.000	PEAK
3	6849.600	24.252	-69.660	-45.408	-20.408	-25.000	PEAK
4	8562.000	27.831	-69.780	-41.949	-16.949	-25.000	PEAK
5	10274.400	29.837	-69.850	-40.013	-15.013	-25.000	PEAK
6	* 11986.800	33.192	-68.810	-35.618	-10.618	-25.000	PEAK

Note:

1. All readings above 1GHz are performed with peak and/or average measurements as necessary.
2. Peak measurements: RBW = 1MHz, VBW = 1MHz, Sweep: Auto.
3. Average measurements: RBW = 1MHz, VBW = 10 Hz, Sweep: Auto.
4. “ * ”, means this data is the worst emission level.
5. Measurement Level = Reading Level + Correct Factor.
6. The average measurement was not performed when the peak measured data under the limit of average detection.
7. The Emission above 18GHz were not included is because their levels are too low.

Site : CB4-H	Time : 2017/02/04
Limit : FCC_Part27(outband)_00M_PK	Margin : 6
Probe : CB4-H_CE_Sub_B432_1-18GHz_3M_1116 - HORIZONTAL	Power : AC 120V / 60Hz
EUT : Advanced Industrial 4G/LTE Router, WWAN Failover Manager	Note : Mode 1: WCDMA Band 4_Link Mode 1732.6MHz

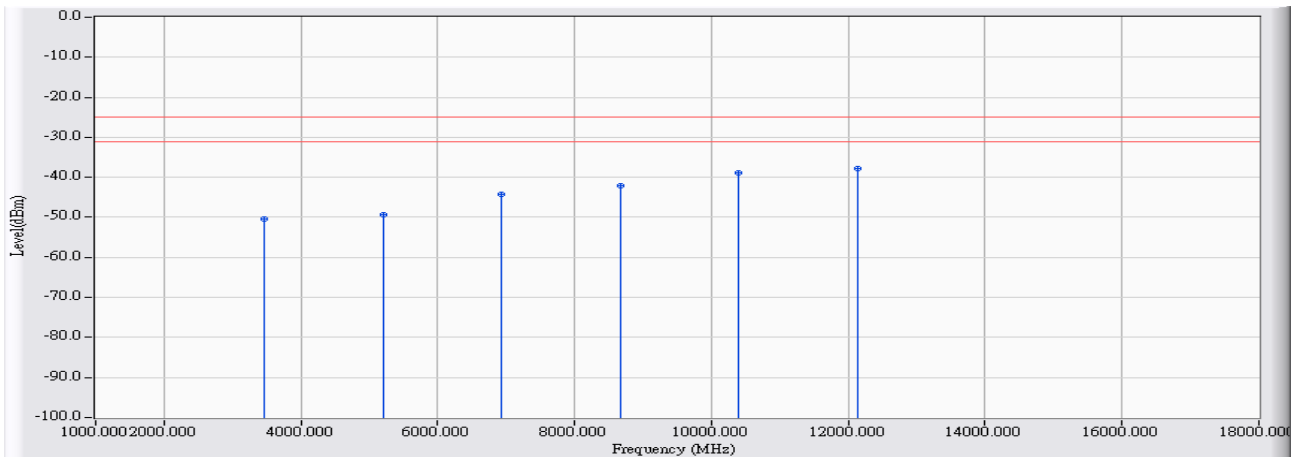

		Frequency (MHz)	Correct Factor (dB)	Reading Level (dBm)	Measure Level (dBm)	Margin (dB)	Limit (dBm)	Detector Type
1		3465.200	18.053	-68.480	-50.427	-25.427	-25.000	PEAK
2		5197.800	20.410	-69.700	-49.290	-24.290	-25.000	PEAK
3		6930.400	25.752	-69.970	-44.218	-19.218	-25.000	PEAK
4		8663.000	27.955	-70.060	-42.104	-17.104	-25.000	PEAK
5		10395.600	30.189	-69.080	-38.892	-13.892	-25.000	PEAK
6	*	12128.200	32.099	-69.860	-37.760	-12.760	-25.000	PEAK

Note:

1. All readings above 1GHz are performed with peak and/or average measurements as necessary.
2. Peak measurements: RBW = 1MHz, VBW = 1MHz, Sweep: Auto.
3. Average measurements: RBW = 1MHz, VBW = 10 Hz, Sweep: Auto.
4. “ * ”, means this data is the worst emission level.
5. Measurement Level = Reading Level + Correct Factor.
6. The average measurement was not performed when the peak measured data under the limit of average detection.
7. The Emission above 18GHz were not included is because their levels are too low.

Site : CB4-H	Time : 2017/02/04
Limit : FCC_Part27(outband)_00M_PK	Margin : 6
Probe : CB4-H_CE_Sub_B432_1-18GHz_3M_1116 - VERTICAL	Power : AC 120V / 60Hz
EUT : Advanced Industrial 4G/LTE Router, WWAN Failover Manager	Note : Mode 1: WCDMA Band 4_Link Mode 1732.6MHz

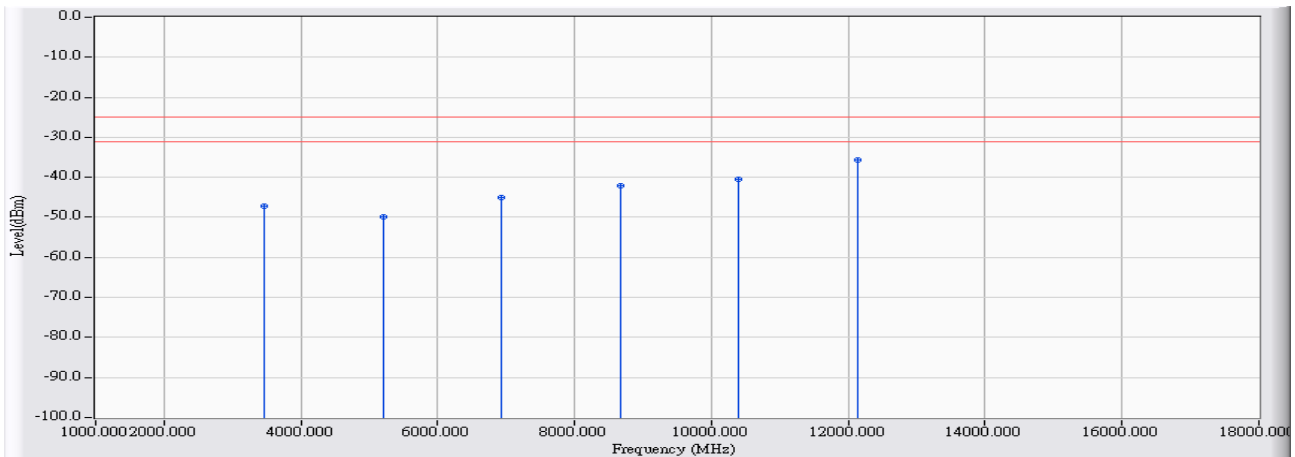

		Frequency (MHz)	Correct Factor (dB)	Reading Level (dBm)	Measure Level (dBm)	Margin (dB)	Limit (dBm)	Detector Type
1		3465.200	18.835	-65.950	-47.115	-22.115	-25.000	PEAK
2		5197.800	20.127	-69.910	-49.783	-24.783	-25.000	PEAK
3		6930.400	24.330	-69.380	-45.051	-20.051	-25.000	PEAK
4		8663.000	28.252	-70.350	-42.098	-17.098	-25.000	PEAK
5		10395.600	29.748	-70.140	-40.393	-15.393	-25.000	PEAK
6	*	12128.200	33.614	-69.310	-35.696	-10.696	-25.000	PEAK

Note:

1. All readings above 1GHz are performed with peak and/or average measurements as necessary.
2. Peak measurements: RBW = 1MHz, VBW = 1MHz, Sweep: Auto.
3. Average measurements: RBW = 1MHz, VBW = 10 Hz, Sweep: Auto.
4. “ * ”, means this data is the worst emission level.
5. Measurement Level = Reading Level + Correct Factor.
6. The average measurement was not performed when the peak measured data under the limit of average detection.
7. The Emission above 18GHz were not included is because their levels are too low.

Site : CB4-H	Time : 2017/02/04
Limit : FCC_Part27(outband)_00M_PK	Margin : 6
Probe : CB4-H_CE_Sub_B432_1-18GHz_3M_1116 - HORIZONTAL	Power : AC 120V / 60Hz
EUT : Advanced Industrial 4G/LTE Router, WWAN Failover Manager	Note : Mode 1: WCDMA Band 4_Link Mode 1752.6MHz

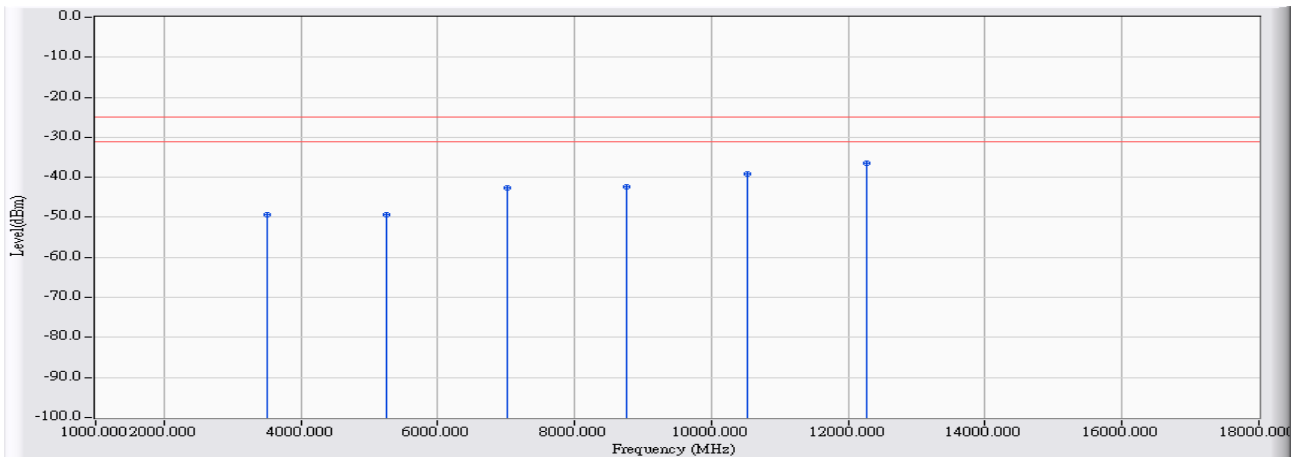

		Frequency (MHz)	Correct Factor (dB)	Reading Level (dBm)	Measure Level (dBm)	Margin (dB)	Limit (dBm)	Detector Type
1		3505.200	18.158	-67.530	-49.372	-24.372	-25.000	PEAK
2		5257.800	20.452	-69.870	-49.418	-24.418	-25.000	PEAK
3		7010.400	25.972	-68.600	-42.628	-17.628	-25.000	PEAK
4		8763.000	28.191	-70.520	-42.329	-17.329	-25.000	PEAK
5		10515.600	30.462	-69.630	-39.168	-14.168	-25.000	PEAK
6	*	12268.200	32.464	-69.000	-36.536	-11.536	-25.000	PEAK

Note:

1. All readings above 1GHz are performed with peak and/or average measurements as necessary.
2. Peak measurements: RBW = 1MHz, VBW = 1MHz, Sweep: Auto.
3. Average measurements: RBW = 1MHz, VBW = 10 Hz, Sweep: Auto.
4. “ * ”, means this data is the worst emission level.
5. Measurement Level = Reading Level + Correct Factor.
6. The average measurement was not performed when the peak measured data under the limit of average detection.
7. The Emission above 18GHz were not included is because their levels are too low.

Site : CB4-H	Time : 2017/02/04
Limit : FCC_Part27(outband)_00M_PK	Margin : 6
Probe : CB4-H_CE_Sub_B432_1-18GHz_3M_1116 - VERTICAL	Power : AC 120V / 60Hz
EUT : Advanced Industrial 4G/LTE Router, WWAN Failover Manager	Note : Mode 1: WCDMA Band 4_Link Mode 1752.6MHz

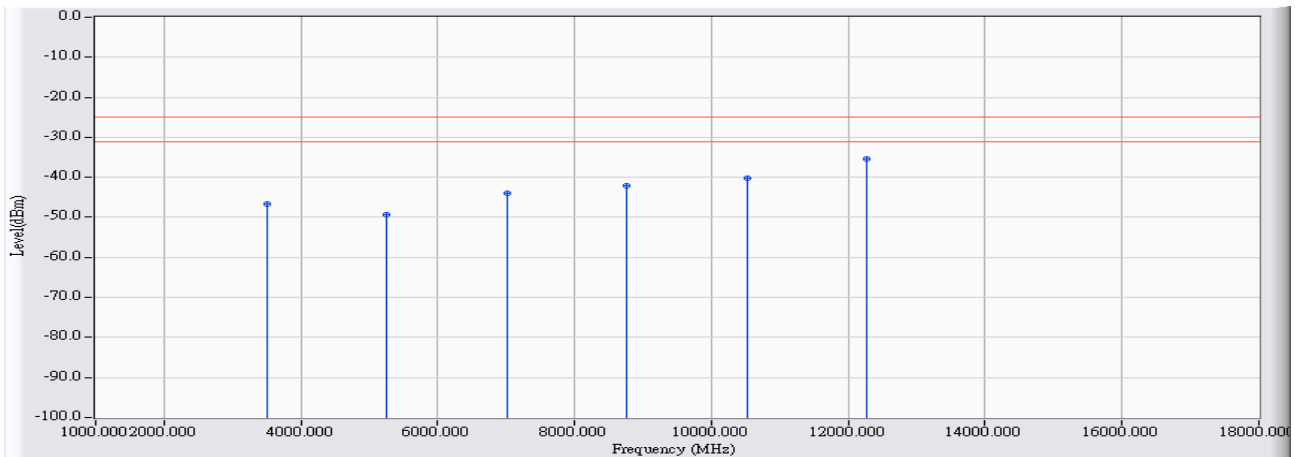

		Frequency (MHz)	Correct Factor (dB)	Reading Level (dBm)	Measure Level (dBm)	Margin (dB)	Limit (dBm)	Detector Type
1		3505.200	18.981	-65.600	-46.620	-21.620	-25.000	PEAK
2		5257.800	20.195	-69.440	-49.245	-24.245	-25.000	PEAK
3		7010.400	24.437	-68.300	-43.863	-18.863	-25.000	PEAK
4		8763.000	28.669	-70.710	-42.040	-17.040	-25.000	PEAK
5		10515.600	29.682	-69.890	-40.208	-15.208	-25.000	PEAK
6	*	12268.200	34.048	-69.490	-35.442	-10.442	-25.000	PEAK

Note:

1. All readings above 1GHz are performed with peak and/or average measurements as necessary.
2. Peak measurements: RBW = 1MHz, VBW = 1MHz, Sweep: Auto.
3. Average measurements: RBW = 1MHz, VBW = 10 Hz, Sweep: Auto.
4. “ * ”, means this data is the worst emission level.
5. Measurement Level = Reading Level + Correct Factor.
6. The average measurement was not performed when the peak measured data under the limit of average detection.
7. The Emission above 18GHz were not included is because their levels are too low.

Site : CB4-H	Time : 2017/02/04
Limit : FCC_Part27(outband)_00M_PK	Margin : 6
Probe : CB4-H_CE_Sub_B432_1-18GHz_3M_1116 - HORIZONTAL	Power : AC 120V / 60Hz
EUT : Advanced Industrial 4G/LTE Router, WWAN Failover Manager	Note : Mode 2: WCDMA Band 4_Idle Mode 1712.4MHz

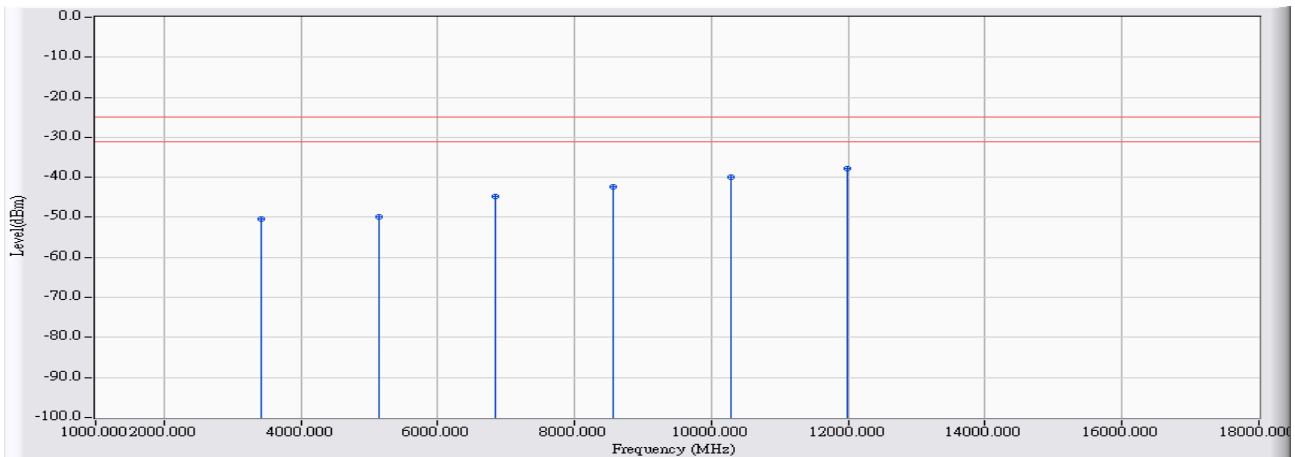

		Frequency (MHz)	Correct Factor (dB)	Reading Level (dBm)	Measure Level (dBm)	Margin (dB)	Limit (dBm)	Detector Type
1		3424.800	17.946	-68.250	-50.303	-25.303	-25.000	PEAK
2		5137.200	20.368	-70.350	-49.982	-24.982	-25.000	PEAK
3		6849.600	25.503	-70.340	-44.837	-19.837	-25.000	PEAK
4		8562.000	27.718	-70.170	-42.452	-17.452	-25.000	PEAK
5		10274.400	29.907	-69.720	-39.813	-14.813	-25.000	PEAK
6	*	11986.800	31.781	-69.630	-37.849	-12.849	-25.000	PEAK

Note:

1. All readings above 1GHz are performed with peak and/or average measurements as necessary.
2. Peak measurements: RBW = 1MHz, VBW = 1MHz, Sweep: Auto.
3. Average measurements: RBW = 1MHz, VBW = 10 Hz, Sweep: Auto.
4. “ * ”, means this data is the worst emission level.
5. Measurement Level = Reading Level + Correct Factor.
6. The average measurement was not performed when the peak measured data under the limit of average detection.
7. The Emission above 18GHz were not included is because their levels are too low.

Site : CB4-H	Time : 2017/02/04
Limit : FCC_Part27(outband)_00M_PK	Margin : 6
Probe : CB4-H_CE_Sub_B432_1-18GHz_3M_1116 - VERTICAL	Power : AC 120V / 60Hz
EUT : Advanced Industrial 4G/LTE Router, WWAN Failover Manager	Note : Mode 2: WCDMA Band 4_Idle Mode 1712.4MHz

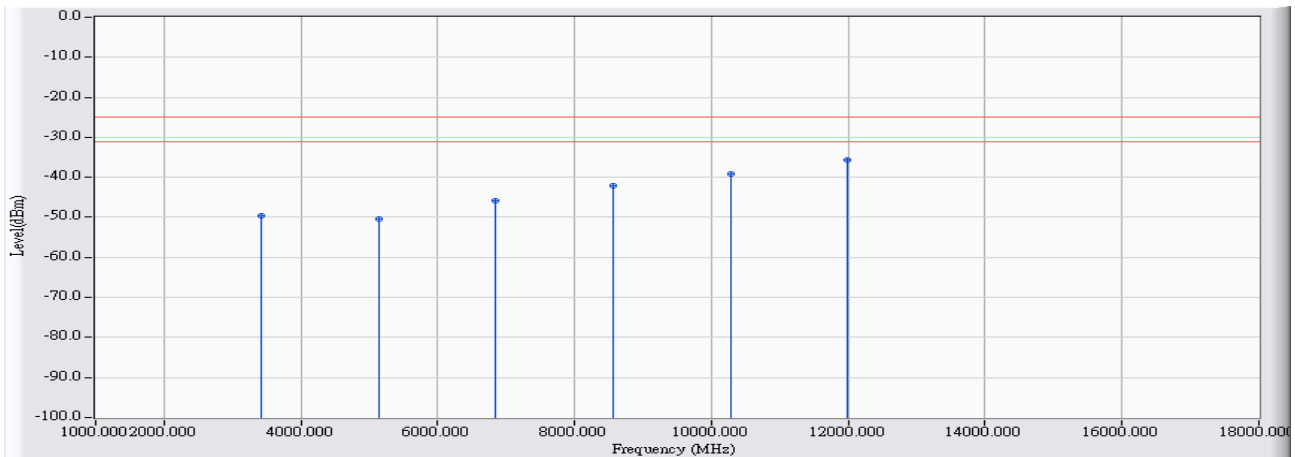

		Frequency (MHz)	Correct Factor (dB)	Reading Level (dBm)	Measure Level (dBm)	Margin (dB)	Limit (dBm)	Detector Type
1		3424.800	18.681	-68.350	-49.669	-24.669	-25.000	PEAK
2		5137.200	20.058	-70.530	-50.472	-25.472	-25.000	PEAK
3		6849.600	24.252	-70.170	-45.918	-20.918	-25.000	PEAK
4		8562.000	27.831	-70.030	-42.199	-17.199	-25.000	PEAK
5		10274.400	29.837	-68.950	-39.113	-14.113	-25.000	PEAK
6	*	11986.800	33.192	-68.950	-35.758	-10.758	-25.000	PEAK

Note:

1. All readings above 1GHz are performed with peak and/or average measurements as necessary.
2. Peak measurements: RBW = 1MHz, VBW = 1MHz, Sweep: Auto.
3. Average measurements: RBW = 1MHz, VBW = 10 Hz, Sweep: Auto.
4. “ * ”, means this data is the worst emission level.
5. Measurement Level = Reading Level + Correct Factor.
6. The average measurement was not performed when the peak measured data under the limit of average detection.
7. The Emission above 18GHz were not included is because their levels are too low.

Site : CB4-H	Time : 2017/02/04
Limit : FCC_Part27(outband)_00M_PK	Margin : 6
Probe : CB4-H_CE_Sub_B432_1-18GHz_3M_1116 - HORIZONTAL	Power : AC 120V / 60Hz
EUT : Advanced Industrial 4G/LTE Router, WWAN Failover Manager	Note : Mode 2: WCDMA Band 4_Idle Mode 1732.6MHz

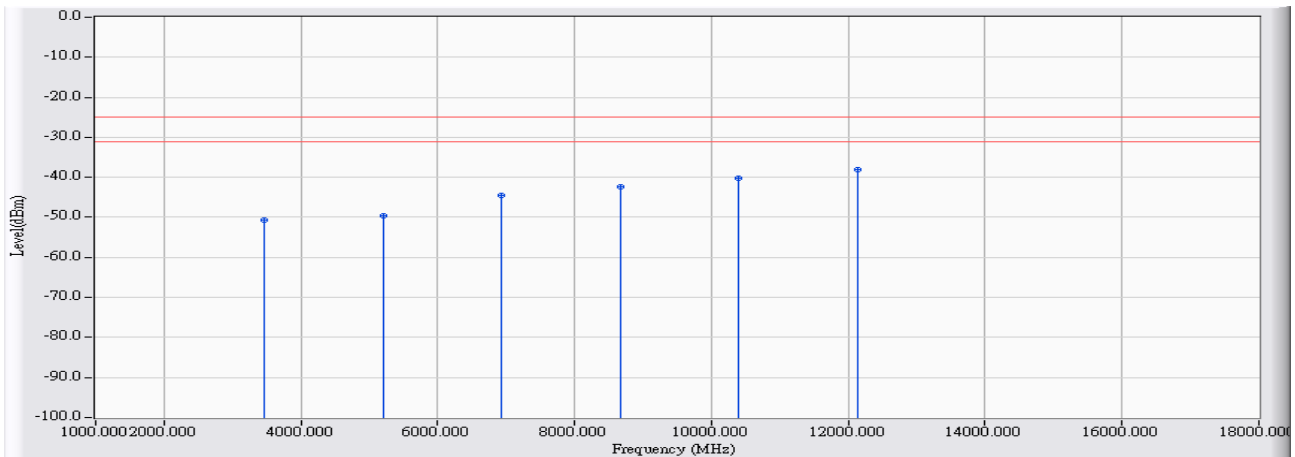

		Frequency (MHz)	Correct Factor (dB)	Reading Level (dBm)	Measure Level (dBm)	Margin (dB)	Limit (dBm)	Detector Type
1		3465.200	18.053	-68.800	-50.747	-25.747	-25.000	PEAK
2		5197.800	20.410	-69.890	-49.480	-24.480	-25.000	PEAK
3		6930.400	25.752	-70.380	-44.628	-19.628	-25.000	PEAK
4		8663.000	27.955	-70.310	-42.354	-17.354	-25.000	PEAK
5		10395.600	30.189	-70.490	-40.302	-15.302	-25.000	PEAK
6	*	12128.200	32.099	-70.170	-38.070	-13.070	-25.000	PEAK

Note:

1. All readings above 1GHz are performed with peak and/or average measurements as necessary.
2. Peak measurements: RBW = 1MHz, VBW = 1MHz, Sweep: Auto.
3. Average measurements: RBW = 1MHz, VBW = 10 Hz, Sweep: Auto.
4. “ * ”, means this data is the worst emission level.
5. Measurement Level = Reading Level + Correct Factor.
6. The average measurement was not performed when the peak measured data under the limit of average detection.
7. The Emission above 18GHz were not included is because their levels are too low.

Site : CB4-H	Time : 2017/02/04
Limit : FCC_Part27(outband)_00M_PK	Margin : 6
Probe : CB4-H_CE_Sub_B432_1-18GHz_3M_1116 - VERTICAL	Power : AC 120V / 60Hz
EUT : Advanced Industrial 4G/LTE Router, WWAN Failover Manager	Note : Mode 2: WCDMA Band 4_Idle Mode 1732.6MHz

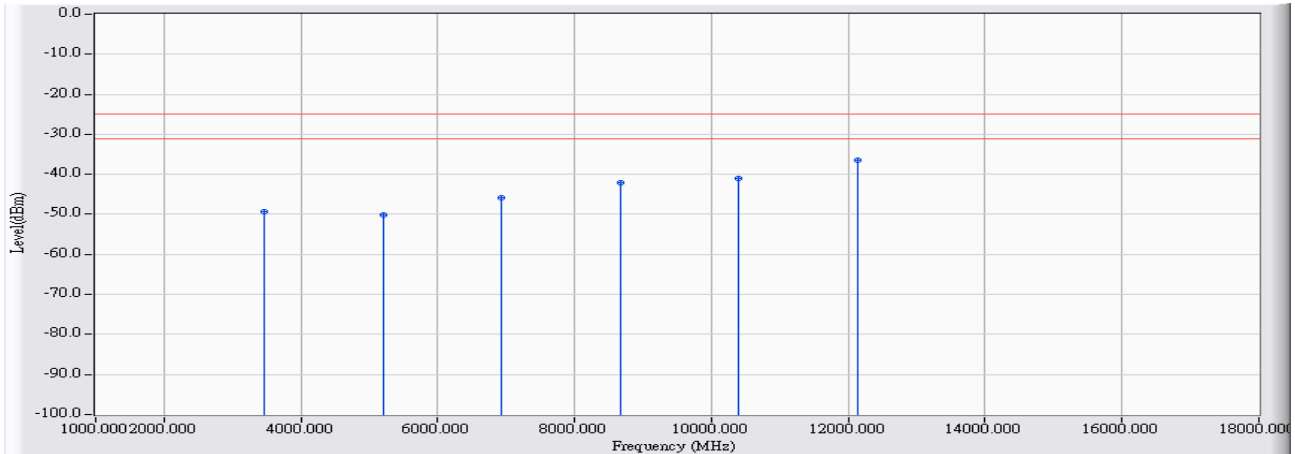

		Frequency (MHz)	Correct Factor (dB)	Reading Level (dBm)	Measure Level (dBm)	Margin (dB)	Limit (dBm)	Detector Type
1		3465.200	18.835	-68.240	-49.405	-24.405	-25.000	PEAK
2		5197.800	20.127	-70.140	-50.013	-25.013	-25.000	PEAK
3		6930.400	24.330	-70.150	-45.821	-20.821	-25.000	PEAK
4		8663.000	28.252	-70.380	-42.128	-17.128	-25.000	PEAK
5		10395.600	29.748	-70.650	-40.903	-15.903	-25.000	PEAK
6	*	12128.200	33.614	-69.960	-36.346	-11.346	-25.000	PEAK

Note:

1. All readings above 1GHz are performed with peak and/or average measurements as necessary.
2. Peak measurements: RBW = 1MHz, VBW = 1MHz, Sweep: Auto.
3. Average measurements: RBW = 1MHz, VBW = 10 Hz, Sweep: Auto.
4. “ * ”, means this data is the worst emission level.
5. Measurement Level = Reading Level + Correct Factor.
6. The average measurement was not performed when the peak measured data under the limit of average detection.
7. The Emission above 18GHz were not included is because their levels are too low.

Site : CB4-H	Time : 2017/02/04
Limit : FCC_Part27(outband)_00M_PK	Margin : 6
Probe : CB4-H_CE_Sub_B432_1-18GHz_3M_1116 - HORIZONTAL	Power : AC 120V / 60Hz
EUT : Advanced Industrial 4G/LTE Router, WWAN Failover Manager	Note : Mode 2: WCDMA Band 4_Idle Mode 1752.6MHz

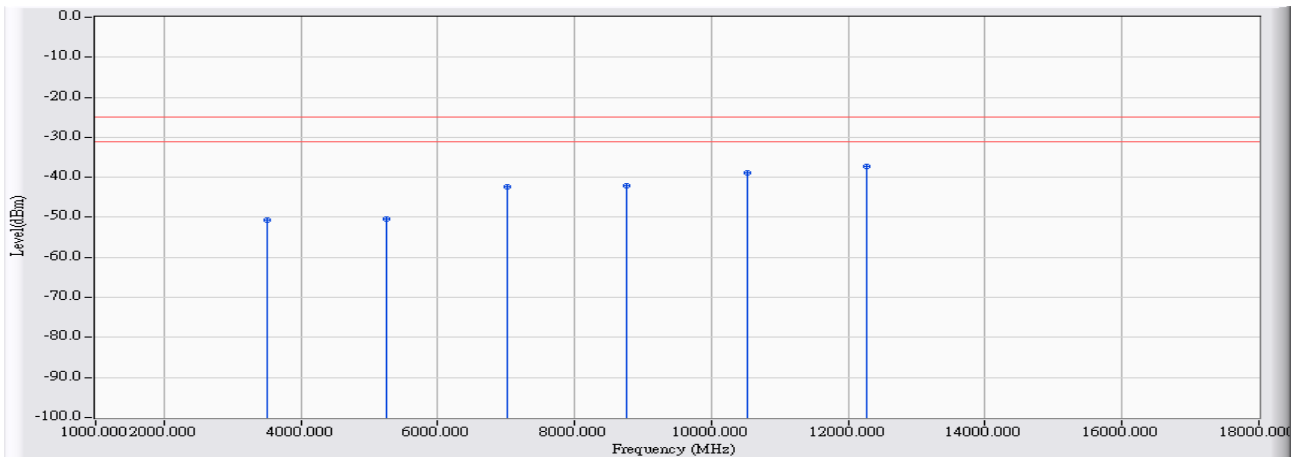

		Frequency (MHz)	Correct Factor (dB)	Reading Level (dBm)	Measure Level (dBm)	Margin (dB)	Limit (dBm)	Detector Type
1		3505.200	18.158	-68.770	-50.612	-25.612	-25.000	PEAK
2		5257.800	20.452	-70.730	-50.278	-25.278	-25.000	PEAK
3		7010.400	25.972	-68.300	-42.328	-17.328	-25.000	PEAK
4		8763.000	28.191	-70.210	-42.019	-17.019	-25.000	PEAK
5		10515.600	30.462	-69.340	-38.878	-13.878	-25.000	PEAK
6	*	12268.200	32.464	-69.790	-37.326	-12.326	-25.000	PEAK

Note:

1. All readings above 1GHz are performed with peak and/or average measurements as necessary.
2. Peak measurements: RBW = 1MHz, VBW = 1MHz, Sweep: Auto.
3. Average measurements: RBW = 1MHz, VBW = 10 Hz, Sweep: Auto.
4. “ * ”, means this data is the worst emission level.
5. Measurement Level = Reading Level + Correct Factor.
6. The average measurement was not performed when the peak measured data under the limit of average detection.
7. The Emission above 18GHz were not included is because their levels are too low.

Site : CB4-H	Time : 2017/02/04
Limit : FCC_Part27(outband)_00M_PK	Margin : 6
Probe : CB4-H_CE_Sub_B432_1-18GHz_3M_1116 - VERTICAL	Power : AC 120V / 60Hz
EUT : Advanced Industrial 4G/LTE Router, WWAN Failover Manager	Note : Mode 2: WCDMA Band 4_Idle Mode 1752.6MHz

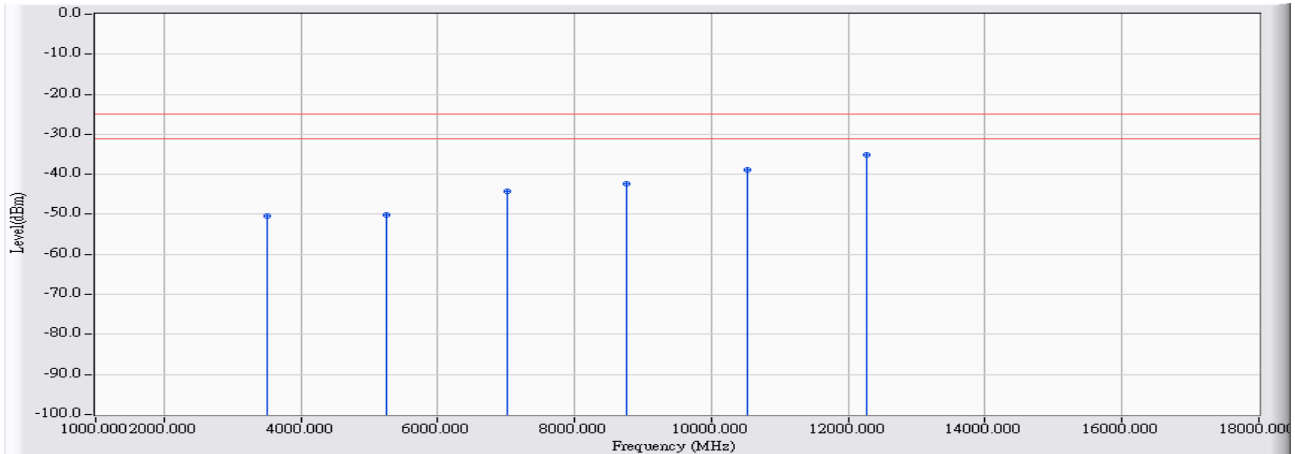

		Frequency (MHz)	Correct Factor (dB)	Reading Level (dBm)	Measure Level (dBm)	Margin (dB)	Limit (dBm)	Detector Type
1		3505.200	18.981	-69.280	-50.300	-25.300	-25.000	PEAK
2		5257.800	20.195	-70.430	-50.235	-25.235	-25.000	PEAK
3		7010.400	24.437	-68.690	-44.253	-19.253	-25.000	PEAK
4		8763.000	28.669	-71.140	-42.470	-17.470	-25.000	PEAK
5		10515.600	29.682	-68.680	-38.998	-13.998	-25.000	PEAK
6	*	12268.200	34.048	-69.270	-35.222	-10.222	-25.000	PEAK

Note:

1. All readings above 1GHz are performed with peak and/or average measurements as necessary.
2. Peak measurements: RBW = 1MHz, VBW = 1MHz, Sweep: Auto.
3. Average measurements: RBW = 1MHz, VBW = 10 Hz, Sweep: Auto.
4. “ * ”, means this data is the worst emission level.
5. Measurement Level = Reading Level + Correct Factor.
6. The average measurement was not performed when the peak measured data under the limit of average detection.
7. The Emission above 18GHz were not included is because their levels are too low.

Site : CB4-H	Time : 2017/02/24
Limit : FCC_Part27(outband)_00M_PK	Margin : 6
Probe : CB4_CE_Sub_B432_1-18GHz_3M_1116 - HORIZONTAL	Power : AC 120V / 60Hz
EUT : Advanced Industrial 4G/LTE Router, WWAN Failover Manager	Note : Mode 3: WCDMA Band 4_HSUPA Mode _1712.4_HSUPA_Link

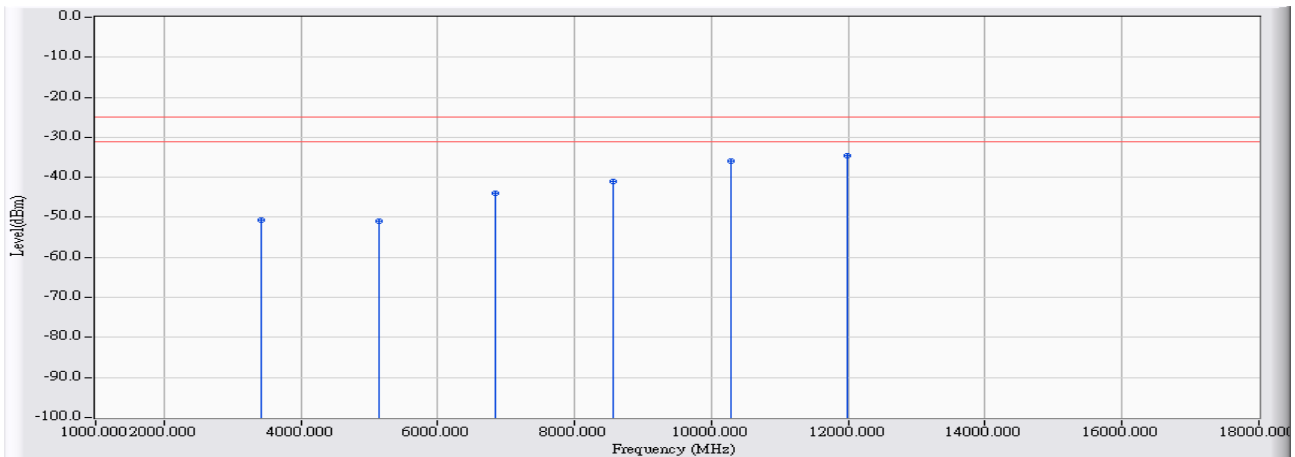

	Frequency (MHz)	Correct Factor (dB)	Reading Level (dBm)	Measure Level (dBm)	Margin (dB)	Limit (dBm)	Detector Type
1	3424.800	17.529	-68.250	-50.720	-25.720	-25.000	PEAK
2	5137.200	20.315	-71.180	-50.865	-25.865	-25.000	PEAK
3	6849.600	26.912	-71.010	-44.099	-19.099	-25.000	PEAK
4	8562.000	30.527	-71.440	-40.913	-15.913	-25.000	PEAK
5	10274.400	34.070	-69.980	-35.911	-10.911	-25.000	PEAK
6	* 11986.800	35.477	-70.060	-34.583	-9.583	-25.000	PEAK

Note:

1. All readings above 1GHz are performed with peak and/or average measurements as necessary.
2. Peak measurements: RBW = 1MHz, VBW = 1MHz, Sweep: Auto.
3. Average measurements: RBW = 1MHz, VBW = 10 Hz, Sweep: Auto.
4. “ * ”, means this data is the worst emission level.
5. Measurement Level = Reading Level + Correct Factor.
6. The average measurement was not performed when the peak measured data under the limit of average detection.
7. The Emission above 18GHz were not included is because their levels are too low.

Site : CB4-H	Time : 2017/02/24
Limit : FCC_Part27(outband)_00M_PK	Margin : 6
Probe : CB4_CE_Sub_B432_1-18GHz_3M_1116 - VERTICAL	Power : AC 120V / 60Hz
EUT : Advanced Industrial 4G/LTE Router, WWAN Failover Manager	Note : Mode 3: WCDMA Band 4_HSUPA Mode _1712.4_HSUPA_Link

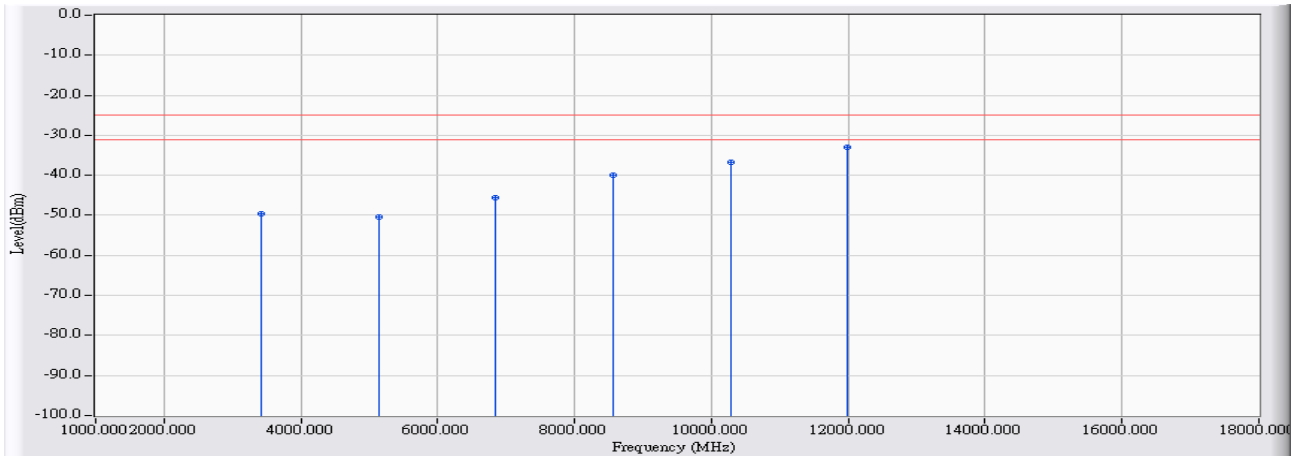

	Frequency (MHz)	Correct Factor (dB)	Reading Level (dBm)	Measure Level (dBm)	Margin (dB)	Limit (dBm)	Detector Type
1	3424.800	18.264	-67.870	-49.606	-24.606	-25.000	PEAK
2	5137.200	20.005	-70.460	-50.454	-25.454	-25.000	PEAK
3	6849.600	25.661	-71.180	-45.520	-20.520	-25.000	PEAK
4	8562.000	30.640	-70.560	-39.920	-14.920	-25.000	PEAK
5	10274.400	34.000	-70.670	-36.670	-11.670	-25.000	PEAK
6	* 11986.800	36.888	-69.890	-33.002	-8.002	-25.000	PEAK

Note:

1. All readings above 1GHz are performed with peak and/or average measurements as necessary.
2. Peak measurements: RBW = 1MHz, VBW = 1MHz, Sweep: Auto.
3. Average measurements: RBW = 1MHz, VBW = 10 Hz, Sweep: Auto.
4. “ * ”, means this data is the worst emission level.
5. Measurement Level = Reading Level + Correct Factor.
6. The average measurement was not performed when the peak measured data under the limit of average detection.
7. The Emission above 18GHz were not included is because their levels are too low.

Site : CB4-H	Time : 2017/02/24
Limit : FCC_Part27(outband)_00M_PK	Margin : 6
Probe : CB4_CE_Sub_B432_1-18GHz_3M_1116 - HORIZONTAL	Power : AC 120V / 60Hz
EUT : Advanced Industrial 4G/LTE Router, WWAN Failover Manager	Note : Mode 3: WCDMA Band 4_HSUPA Mode _1732.6_HSUPA_Link

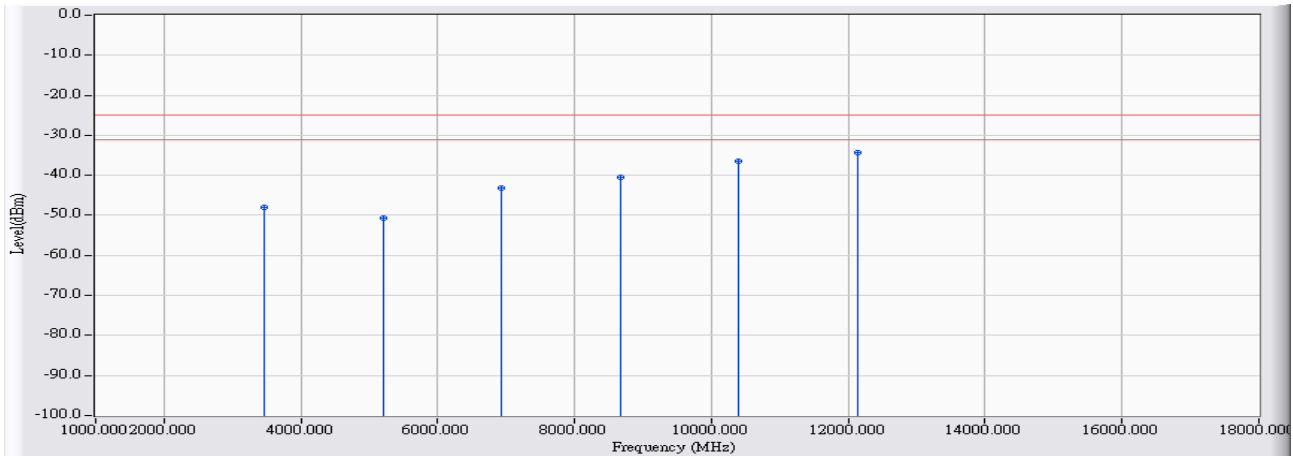

	Frequency (MHz)	Correct Factor (dB)	Reading Level (dBm)	Measure Level (dBm)	Margin (dB)	Limit (dBm)	Detector Type
1	3465.200	17.629	-65.610	-47.981	-22.981	-25.000	PEAK
2	5197.800	20.384	-71.180	-50.797	-25.797	-25.000	PEAK
3	6930.400	27.253	-70.480	-43.228	-18.228	-25.000	PEAK
4	8663.000	30.958	-71.450	-40.492	-15.492	-25.000	PEAK
5	10385.600	34.247	-70.660	-36.413	-11.413	-25.000	PEAK
6	* 12128.200	35.717	-69.900	-34.183	-9.183	-25.000	PEAK

Note:

1. All readings above 1GHz are performed with peak and/or average measurements as necessary.
2. Peak measurements: RBW = 1MHz, VBW = 1MHz, Sweep: Auto.
3. Average measurements: RBW = 1MHz, VBW = 10 Hz, Sweep: Auto.
4. “ * ”, means this data is the worst emission level.
5. Measurement Level = Reading Level + Correct Factor.
6. The average measurement was not performed when the peak measured data under the limit of average detection.
7. The Emission above 18GHz were not included is because their levels are too low.

Site : CB4-H	Time : 2017/02/24
Limit : FCC_Part27(outband)_00M_PK	Margin : 6
Probe : CB4_CE_Sub_B432_1-18GHz_3M_1116 - VERTICAL	Power : AC 120V / 60Hz
EUT : Advanced Industrial 4G/LTE Router, WWAN Failover Manager	Note : Mode 3: WCDMA Band 4_HSUPA Mode _1732.6_HSUPA_Link

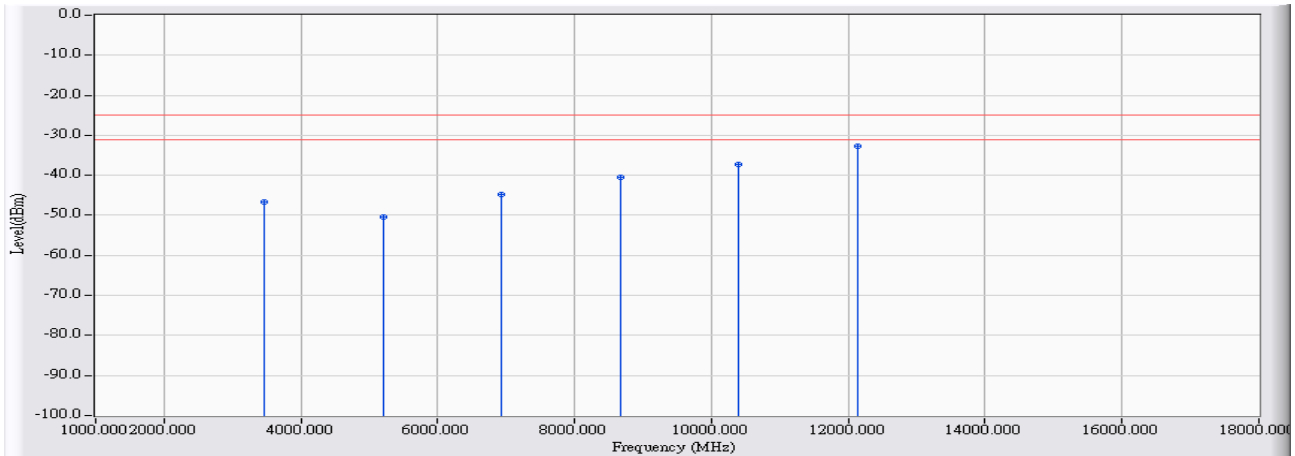

	Frequency (MHz)	Correct Factor (dB)	Reading Level (dBm)	Measure Level (dBm)	Margin (dB)	Limit (dBm)	Detector Type
1	3465.200	18.411	-65.140	-46.729	-21.729	-25.000	PEAK
2	5197.800	20.101	-70.570	-50.470	-25.470	-25.000	PEAK
3	6930.400	25.831	-70.470	-44.640	-19.640	-25.000	PEAK
4	8663.000	31.255	-71.660	-40.405	-15.405	-25.000	PEAK
5	10395.600	33.823	-71.210	-37.388	-12.388	-25.000	PEAK
6	* 12128.200	37.232	-69.930	-32.699	-7.699	-25.000	PEAK

Note:

1. All readings above 1GHz are performed with peak and/or average measurements as necessary.
2. Peak measurements: RBW = 1MHz, VBW = 1MHz, Sweep: Auto.
3. Average measurements: RBW = 1MHz, VBW = 10 Hz, Sweep: Auto.
4. “ * ”, means this data is the worst emission level.
5. Measurement Level = Reading Level + Correct Factor.
6. The average measurement was not performed when the peak measured data under the limit of average detection.
7. The Emission above 18GHz were not included is because their levels are too low.

Site : CB4-H	Time : 2017/02/24
Limit : FCC_Part27(outband)_00M_PK	Margin : 6
Probe : CB4_CE_Sub_B432_1-18GHz_3M_1116 - HORIZONTAL	Power : AC 120V / 60Hz
EUT : Advanced Industrial 4G/LTE Router, WWAN Failover Manager	Note : Mode 3: WCDMA Band 4_HSUPA Mode _1752.6_HSUPA_Link

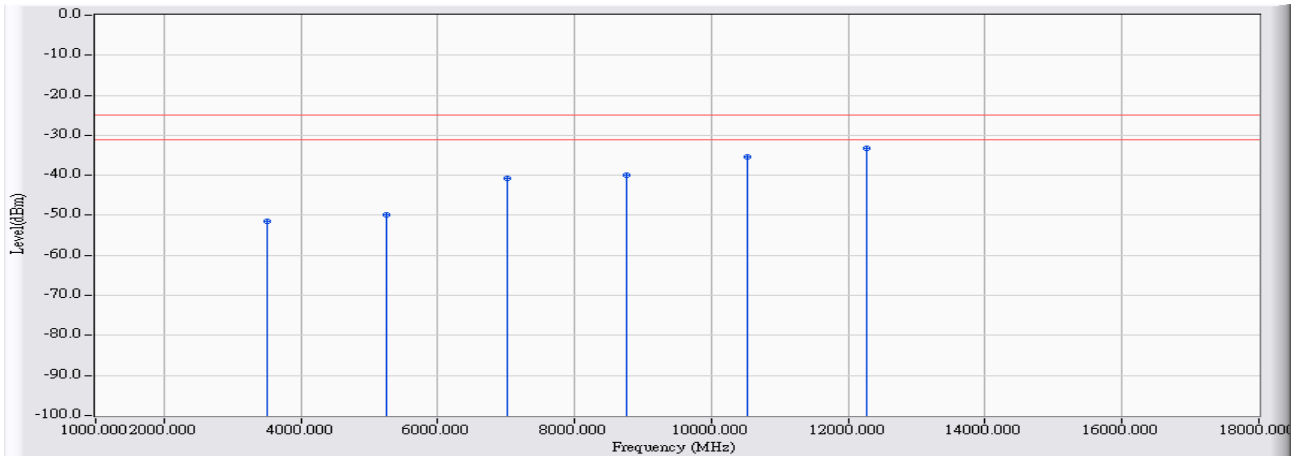

	Frequency (MHz)	Correct Factor (dB)	Reading Level (dBm)	Measure Level (dBm)	Margin (dB)	Limit (dBm)	Detector Type
1	3505.200	17.728	-69.290	-51.562	-26.562	-25.000	PEAK
2	5257.800	20.451	-70.440	-49.990	-24.990	-25.000	PEAK
3	7010.400	27.562	-68.310	-40.748	-15.748	-25.000	PEAK
4	8763.000	31.386	-71.370	-39.984	-14.984	-25.000	PEAK
5	10515.600	34.454	-69.720	-35.266	-10.266	-25.000	PEAK
6	* 12268.200	35.981	-69.240	-33.259	-8.259	-25.000	PEAK

Note:

1. All readings above 1GHz are performed with peak and/or average measurements as necessary.
2. Peak measurements: RBW = 1MHz, VBW = 1MHz, Sweep: Auto.
3. Average measurements: RBW = 1MHz, VBW = 10 Hz, Sweep: Auto.
4. “ * ”, means this data is the worst emission level.
5. Measurement Level = Reading Level + Correct Factor.
6. The average measurement was not performed when the peak measured data under the limit of average detection.
7. The Emission above 18GHz were not included is because their levels are too low.

Site : CB4-H	Time : 2017/02/24
Limit : FCC_Part27(outband)_00M_PK	Margin : 6
Probe : CB4_CE_Sub_B432_1-18GHz_3M_1116 - VERTICAL	Power : AC 120V / 60Hz
EUT : Advanced Industrial 4G/LTE Router, WWAN Failover Manager	Note : Mode 3: WCDMA Band 4_HSUPA Mode _1752.6_HSUPA_Link

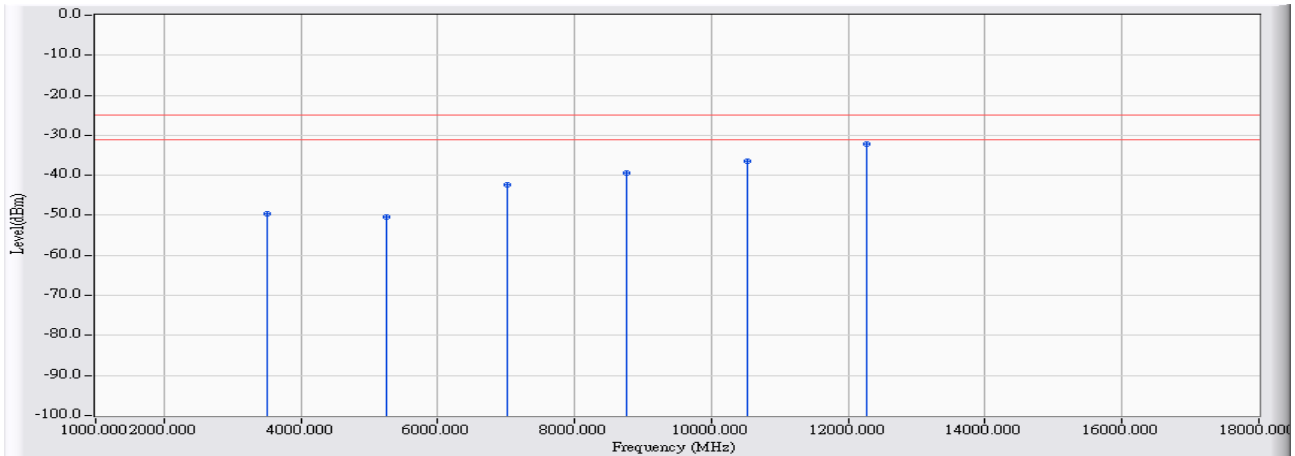

	Frequency (MHz)	Correct Factor (dB)	Reading Level (dBm)	Measure Level (dBm)	Margin (dB)	Limit (dBm)	Detector Type
1	3505.200	18.551	-68.040	-49.490	-24.490	-25.000	PEAK
2	5257.800	20.194	-70.590	-50.396	-25.396	-25.000	PEAK
3	7010.400	26.027	-68.500	-42.473	-17.473	-25.000	PEAK
4	8763.000	31.864	-71.360	-39.495	-14.495	-25.000	PEAK
5	10515.600	33.674	-70.110	-36.437	-11.437	-25.000	PEAK
6	* 12268.200	37.565	-69.680	-32.115	-7.115	-25.000	PEAK

Note:

1. All readings above 1GHz are performed with peak and/or average measurements as necessary.
2. Peak measurements: RBW = 1MHz, VBW = 1MHz, Sweep: Auto.
3. Average measurements: RBW = 1MHz, VBW = 10 Hz, Sweep: Auto.
4. “ * ”, means this data is the worst emission level.
5. Measurement Level = Reading Level + Correct Factor.
6. The average measurement was not performed when the peak measured data under the limit of average detection.
7. The Emission above 18GHz were not included is because their levels are too low.

Site : CB4-H	Time : 2017/02/24
Limit : FCC_Part27(outband)_00M_PK	Margin : 6
Probe : CB4_CE_Sub_B432_1-18GHz_3M_1116 - HORIZONTAL	Power : AC 120V / 60Hz
EUT : Advanced Industrial 4G/LTE Router, WWAN Failover Manager	Note : Mode 3: WCDMA Band 4_HSUPA Mode _1712.4_HSUPA_Idle

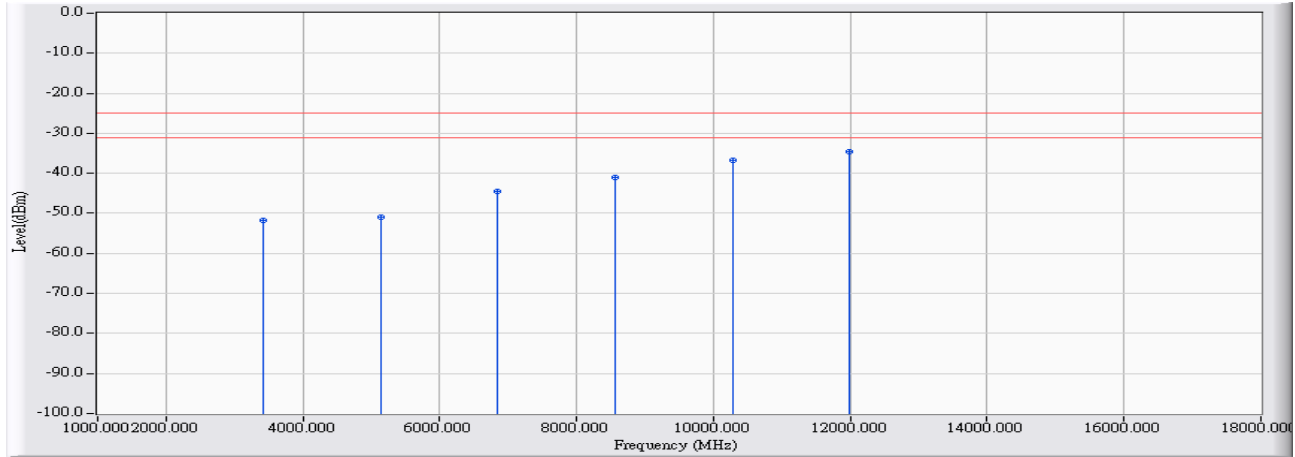

	Frequency (MHz)	Correct Factor (dB)	Reading Level (dBm)	Measure Level (dBm)	Margin (dB)	Limit (dBm)	Detector Type
1	3424.800	17.529	-69.180	-51.650	-26.650	-25.000	PEAK
2	5137.200	20.315	-71.330	-51.015	-26.015	-25.000	PEAK
3	6849.600	26.912	-71.530	-44.619	-19.619	-25.000	PEAK
4	8562.000	30.527	-71.420	-40.893	-15.893	-25.000	PEAK
5	10274.400	34.070	-70.700	-36.631	-11.631	-25.000	PEAK
6	* 11986.800	35.477	-70.160	-34.683	-9.683	-25.000	PEAK

Note:

1. All readings above 1GHz are performed with peak and/or average measurements as necessary.
2. Peak measurements: RBW = 1MHz, VBW = 1MHz, Sweep: Auto.
3. Average measurements: RBW = 1MHz, VBW = 10 Hz, Sweep: Auto.
4. “ * ”, means this data is the worst emission level.
5. Measurement Level = Reading Level + Correct Factor.
6. The average measurement was not performed when the peak measured data under the limit of average detection.
7. The Emission above 18GHz were not included is because their levels are too low.

Site : CB4-H	Time : 2017/02/24
Limit : FCC_Part27(outband)_00M_PK	Margin : 6
Probe : CB4_CE_Sub_B432_1-18GHz_3M_1116 - VERTICAL	Power : AC 120V / 60Hz
EUT : Advanced Industrial 4G/LTE Router, WWAN Failover Manager	Note : Mode 3: WCDMA Band 4_HSUPA Mode _1712.4_HSUPA_Idle

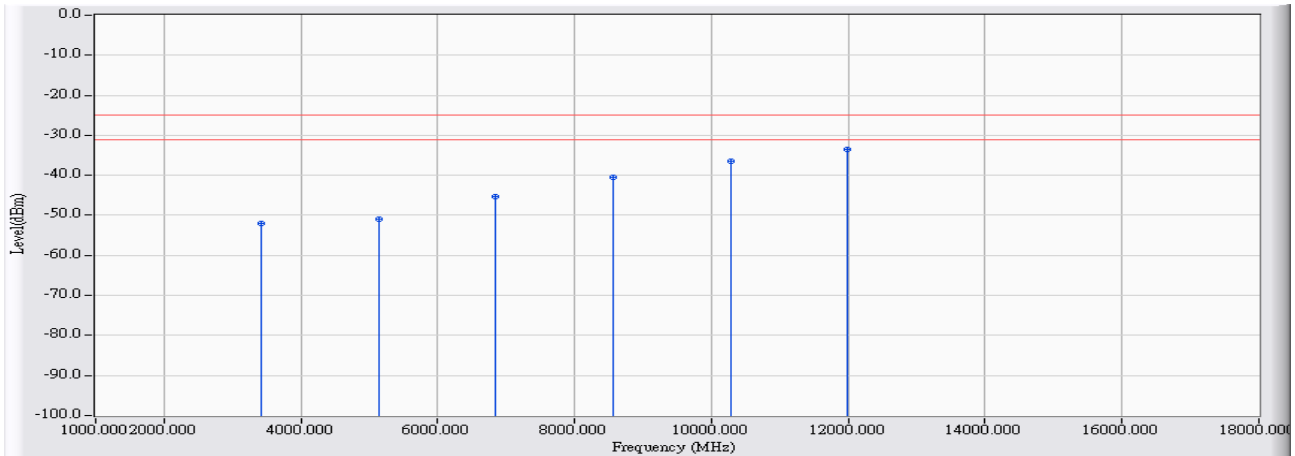

	Frequency (MHz)	Correct Factor (dB)	Reading Level (dBm)	Measure Level (dBm)	Margin (dB)	Limit (dBm)	Detector Type
1	3424.800	18.264	-70.240	-51.976	-26.976	-25.000	PEAK
2	5137.200	20.005	-70.810	-50.804	-25.804	-25.000	PEAK
3	6849.600	25.661	-70.920	-45.260	-20.260	-25.000	PEAK
4	8562.000	30.640	-71.150	-40.510	-15.510	-25.000	PEAK
5	10274.400	34.000	-70.530	-36.530	-11.530	-25.000	PEAK
6	* 11986.800	36.888	-70.430	-33.542	-8.542	-25.000	PEAK

Note:

1. All readings above 1GHz are performed with peak and/or average measurements as necessary.
2. Peak measurements: RBW = 1MHz, VBW = 1MHz, Sweep: Auto.
3. Average measurements: RBW = 1MHz, VBW = 10 Hz, Sweep: Auto.
4. “ * ”, means this data is the worst emission level.
5. Measurement Level = Reading Level + Correct Factor.
6. The average measurement was not performed when the peak measured data under the limit of average detection.
7. The Emission above 18GHz were not included is because their levels are too low.

Site : CB4-H	Time : 2017/02/24
Limit : FCC_Part27(outband)_00M_PK	Margin : 6
Probe : CB4_CE_Sub_B432_1-18GHz_3M_1116 - HORIZONTAL	Power : AC 120V / 60Hz
EUT : Advanced Industrial 4G/LTE Router, WWAN Failover Manager	Note : Mode 3: WCDMA Band 4_HSUPA Mode _1732.6_HSUPA_Idle

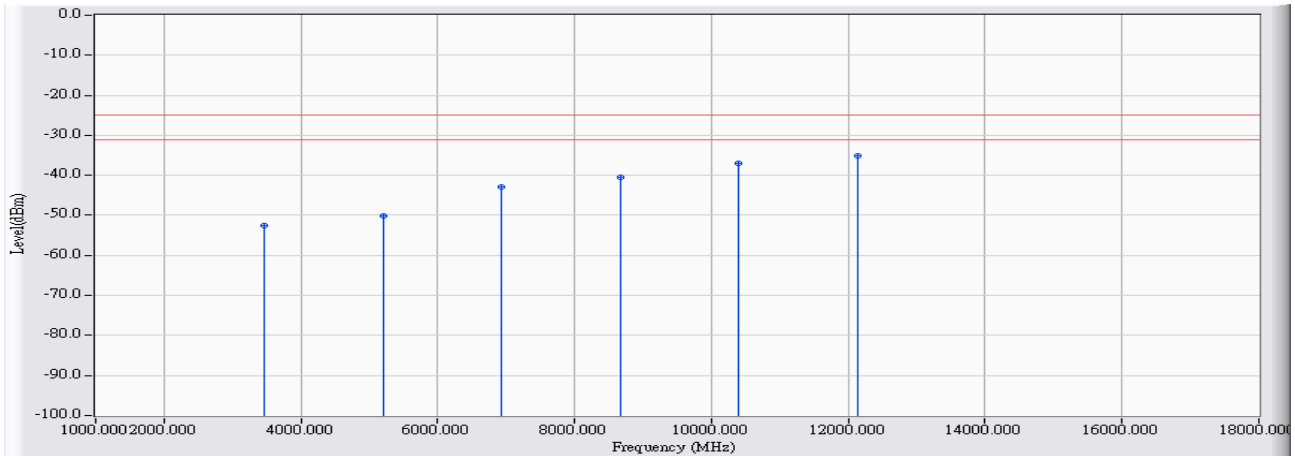

	Frequency (MHz)	Correct Factor (dB)	Reading Level (dBm)	Measure Level (dBm)	Margin (dB)	Limit (dBm)	Detector Type
1	3465.200	17.629	-70.240	-52.611	-27.611	-25.000	PEAK
2	5197.800	20.384	-70.610	-50.227	-25.227	-25.000	PEAK
3	6930.400	27.253	-70.250	-42.998	-17.998	-25.000	PEAK
4	8663.000	30.958	-71.490	-40.532	-15.532	-25.000	PEAK
5	10395.600	34.264	-71.280	-37.017	-12.017	-25.000	PEAK
6	* 12128.200	35.717	-70.910	-35.193	-10.193	-25.000	PEAK

Note:

1. All readings above 1GHz are performed with peak and/or average measurements as necessary.
2. Peak measurements: RBW = 1MHz, VBW = 1MHz, Sweep: Auto.
3. Average measurements: RBW = 1MHz, VBW = 10 Hz, Sweep: Auto.
4. “ * ”, means this data is the worst emission level.
5. Measurement Level = Reading Level + Correct Factor.
6. The average measurement was not performed when the peak measured data under the limit of average detection.
7. The Emission above 18GHz were not included is because their levels are too low.

Site : CB4-H	Time : 2017/02/24
Limit : FCC_Part27(outband)_00M_PK	Margin : 6
Probe : CB4_CE_Sub_B432_1-18GHz_3M_1116 - VERTICAL	Power : AC 120V / 60Hz
EUT : Advanced Industrial 4G/LTE Router, WWAN Failover Manager	Note : Mode 3: WCDMA Band 4_HSUPA Mode _1732.6_HSUPA_Idle

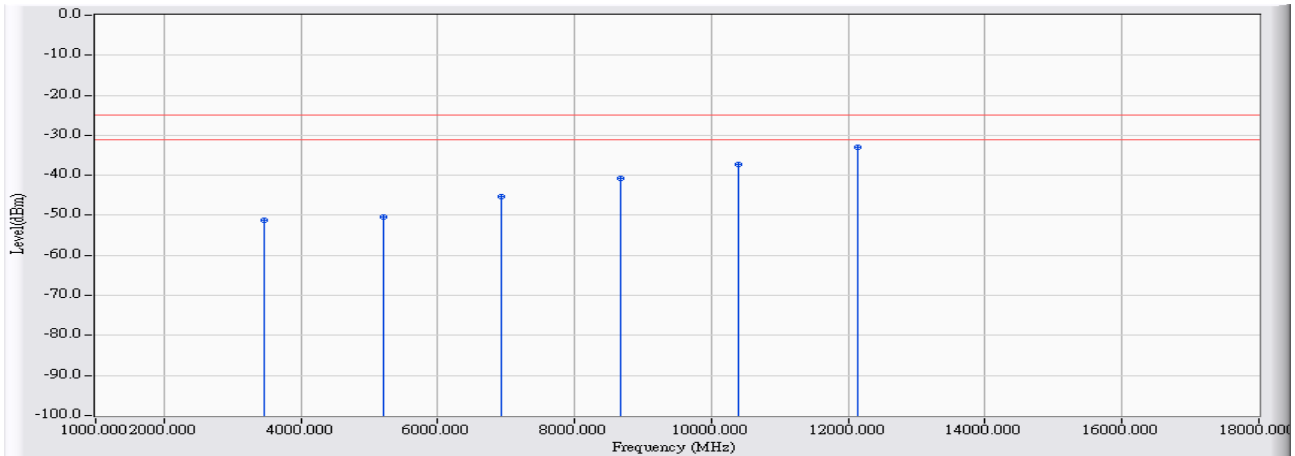

	Frequency (MHz)	Correct Factor (dB)	Reading Level (dBm)	Measure Level (dBm)	Margin (dB)	Limit (dBm)	Detector Type
1	3465.200	18.411	-69.620	-51.209	-26.209	-25.000	PEAK
2	5197.800	20.101	-70.570	-50.470	-25.470	-25.000	PEAK
3	6930.400	25.831	-71.170	-45.340	-20.340	-25.000	PEAK
4	8663.000	31.255	-71.930	-40.675	-15.675	-25.000	PEAK
5	10395.600	33.823	-71.030	-37.208	-12.208	-25.000	PEAK
6	* 12128.200	37.232	-70.300	-33.069	-8.069	-25.000	PEAK

Note:

1. All readings above 1GHz are performed with peak and/or average measurements as necessary.
2. Peak measurements: RBW = 1MHz, VBW = 1MHz, Sweep: Auto.
3. Average measurements: RBW = 1MHz, VBW = 10 Hz, Sweep: Auto.
4. “ * ”, means this data is the worst emission level.
5. Measurement Level = Reading Level + Correct Factor.
6. The average measurement was not performed when the peak measured data under the limit of average detection.
7. The Emission above 18GHz were not included is because their levels are too low.

Site : CB4-H	Time : 2017/02/24
Limit : FCC_Part27(outband)_00M_PK	Margin : 6
Probe : CB4_CE_Sub_B432_1-18GHz_3M_1116 - HORIZONTAL	Power : AC 120V / 60Hz
EUT : Advanced Industrial 4G/LTE Router, WWAN Failover Manager	Note : Mode 3: WCDMA Band 4_HSUPA Mode _1752.6_HSUPA_Idle

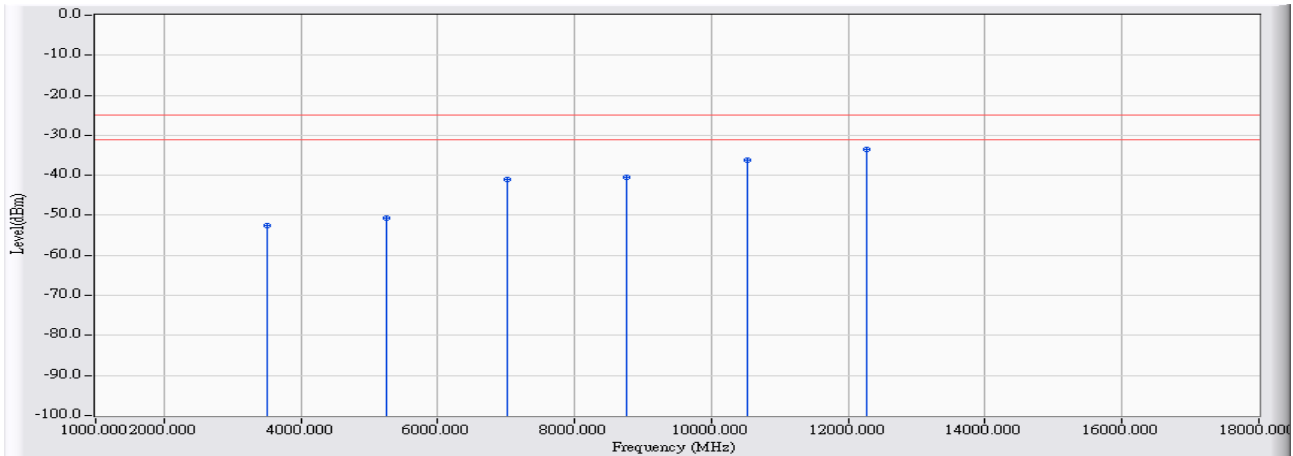

		Frequency (MHz)	Correct Factor (dB)	Reading Level (dBm)	Measure Level (dBm)	Margin (dB)	Limit (dBm)	Detector Type
1		3505.200	17.728	-70.230	-52.502	-27.502	-25.000	PEAK
2		5257.800	20.451	-71.000	-50.550	-25.550	-25.000	PEAK
3		7010.400	27.562	-68.680	-41.118	-16.118	-25.000	PEAK
4		8763.000	31.386	-71.910	-40.524	-15.524	-25.000	PEAK
5		10515.600	34.454	-70.520	-36.066	-11.066	-25.000	PEAK
6	*	12268.200	35.981	-69.520	-33.539	-8.539	-25.000	PEAK

Note:

1. All readings above 1GHz are performed with peak and/or average measurements as necessary.
2. Peak measurements: RBW = 1MHz, VBW = 1MHz, Sweep: Auto.
3. Average measurements: RBW = 1MHz, VBW = 10 Hz, Sweep: Auto.
4. “ * ”, means this data is the worst emission level.
5. Measurement Level = Reading Level + Correct Factor.
6. The average measurement was not performed when the peak measured data under the limit of average detection.
7. The Emission above 18GHz were not included is because their levels are too low.

Site : CB4-H	Time : 2017/02/24
Limit : FCC_Part27(outband)_00M_PK	Margin : 6
Probe : CB4_CE_Sub_B432_1-18GHz_3M_1116 - VERTICAL	Power : AC 120V / 60Hz
EUT : Advanced Industrial 4G/LTE Router, WWAN Failover Manager	Note : Mode 3: WCDMA Band 4_HSUPA Mode _1752.6_HSUPA_Idle

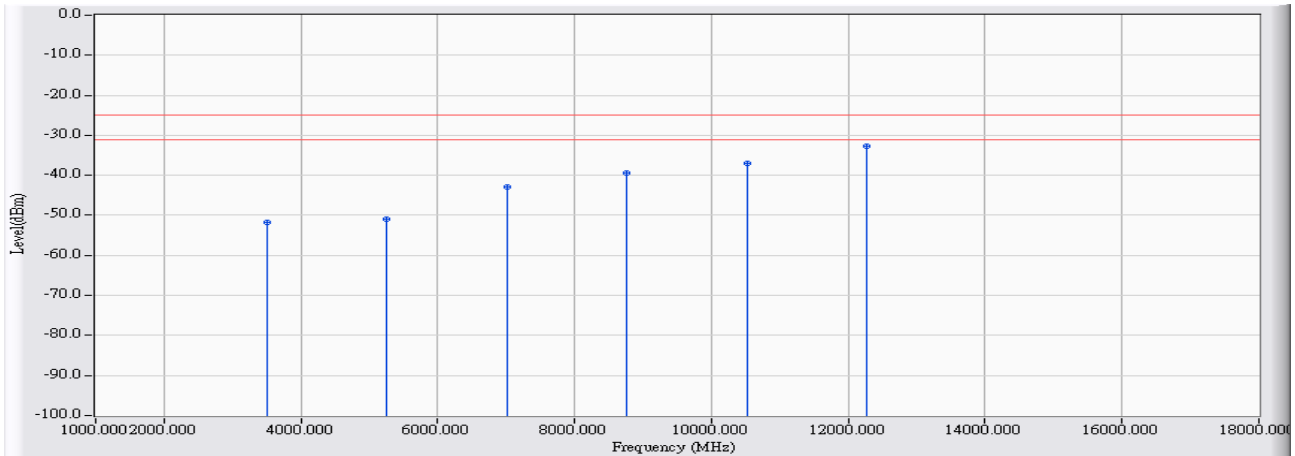

	Frequency (MHz)	Correct Factor (dB)	Reading Level (dBm)	Measure Level (dBm)	Margin (dB)	Limit (dBm)	Detector Type
1	3505.200	18.551	-70.370	-51.820	-26.820	-25.000	PEAK
2	5257.800	20.194	-71.140	-50.946	-25.946	-25.000	PEAK
3	7010.400	26.027	-68.900	-42.873	-17.873	-25.000	PEAK
4	8763.000	31.864	-71.260	-39.395	-14.395	-25.000	PEAK
5	10515.600	33.674	-70.690	-37.017	-12.017	-25.000	PEAK
6	* 12268.200	37.565	-70.260	-32.695	-7.695	-25.000	PEAK

Note:

1. All readings above 1GHz are performed with peak and/or average measurements as necessary.
2. Peak measurements: RBW = 1MHz, VBW = 1MHz, Sweep: Auto.
3. Average measurements: RBW = 1MHz, VBW = 10 Hz, Sweep: Auto.
4. “ * ”, means this data is the worst emission level.
5. Measurement Level = Reading Level + Correct Factor.
6. The average measurement was not performed when the peak measured data under the limit of average detection.
7. The Emission above 18GHz were not included is because their levels are too low.

Site : CB4-H	Time : 2017/02/24
Limit : FCC_Part27(outband)_00M_PK	Margin : 6
Probe : CB4_CE_Sub_B432_1-18GHz_3M_1116 - HORIZONTAL	Power : AC 120V / 60Hz
EUT : Advanced Industrial 4G/LTE Router, WWAN Failover Manager	Note : Mode 4: WCDMA Band 4_HSDPA Mode _1712.4_HSDPA_Link

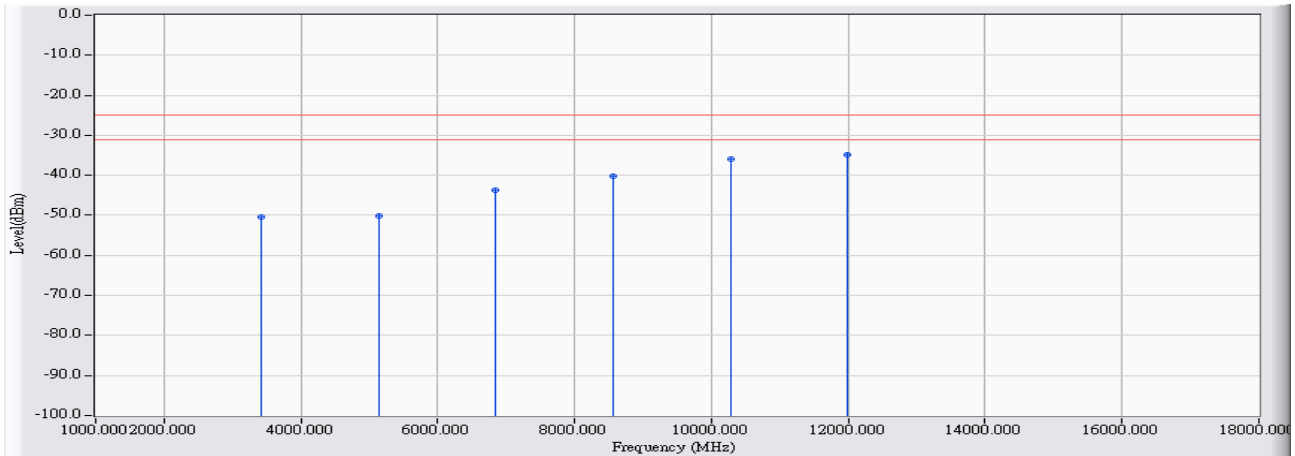

	Frequency (MHz)	Correct Factor (dB)	Reading Level (dBm)	Measure Level (dBm)	Margin (dB)	Limit (dBm)	Detector Type
1	3424.800	17.529	-67.880	-50.350	-25.350	-25.000	PEAK
2	5137.200	20.315	-70.540	-50.225	-25.225	-25.000	PEAK
3	6849.600	26.912	-70.610	-43.699	-18.699	-25.000	PEAK
4	8562.000	30.527	-70.790	-40.263	-15.263	-25.000	PEAK
5	10274.400	34.070	-70.070	-36.001	-11.001	-25.000	PEAK
6	* 11986.800	35.477	-70.240	-34.763	-9.763	-25.000	PEAK

Note:

1. All readings above 1GHz are performed with peak and/or average measurements as necessary.
2. Peak measurements: RBW = 1MHz, VBW = 1MHz, Sweep: Auto.
3. Average measurements: RBW = 1MHz, VBW = 10 Hz, Sweep: Auto.
4. “ * ”, means this data is the worst emission level.
5. Measurement Level = Reading Level + Correct Factor.
6. The average measurement was not performed when the peak measured data under the limit of average detection.
7. The Emission above 18GHz were not included is because their levels are too low.

Site : CB4-H	Time : 2017/02/24
Limit : FCC_Part27(outband)_00M_PK	Margin : 6
Probe : CB4_CE_Sub_B432_1-18GHz_3M_1116 - VERTICAL	Power : AC 120V / 60Hz
EUT : Advanced Industrial 4G/LTE Router, WWAN Failover Manager	Note : Mode 4: WCDMA Band 4_HSDPA Mode _1712.4_HSDPA_Link

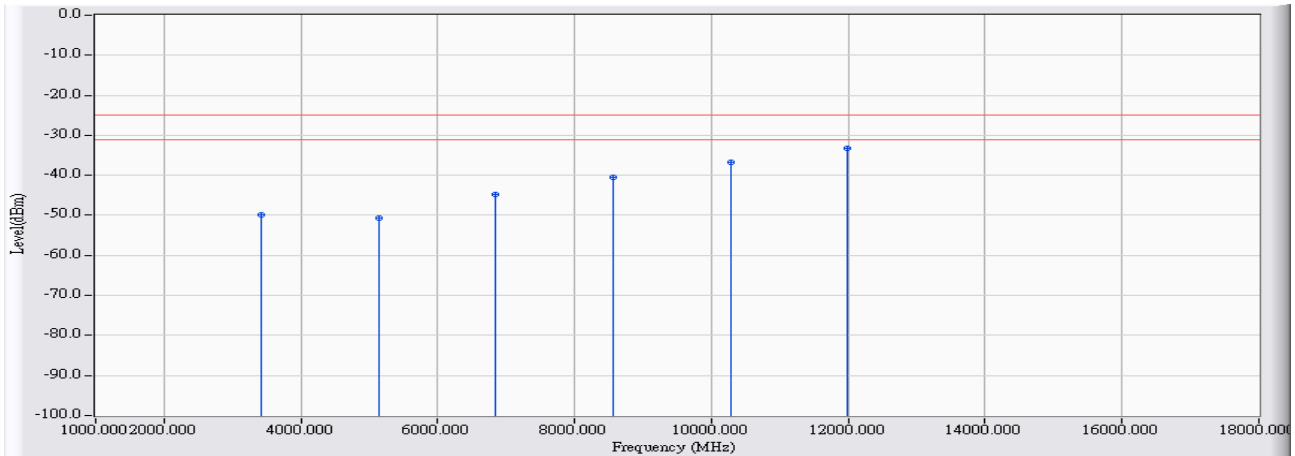

	Frequency (MHz)	Correct Factor (dB)	Reading Level (dBm)	Measure Level (dBm)	Margin (dB)	Limit (dBm)	Detector Type
1	3424.800	18.264	-68.100	-49.836	-24.836	-25.000	PEAK
2	5137.200	20.005	-70.640	-50.634	-25.634	-25.000	PEAK
3	6849.600	25.661	-70.540	-44.880	-19.880	-25.000	PEAK
4	8562.000	30.640	-71.140	-40.500	-15.500	-25.000	PEAK
5	10274.400	34.000	-70.670	-36.670	-11.670	-25.000	PEAK
6	* 11986.800	36.888	-70.070	-33.182	-8.182	-25.000	PEAK

Note:

1. All readings above 1GHz are performed with peak and/or average measurements as necessary.
2. Peak measurements: RBW = 1MHz, VBW = 1MHz, Sweep: Auto.
3. Average measurements: RBW = 1MHz, VBW = 10 Hz, Sweep: Auto.
4. “ * ”, means this data is the worst emission level.
5. Measurement Level = Reading Level + Correct Factor.
6. The average measurement was not performed when the peak measured data under the limit of average detection.
7. The Emission above 18GHz were not included is because their levels are too low.

Site : CB4-H	Time : 2017/02/24
Limit : FCC_Part27(outband)_00M_PK	Margin : 6
Probe : CB4_CE_Sub_B432_1-18GHz_3M_1116 - HORIZONTAL	Power : AC 120V / 60Hz
EUT : Advanced Industrial 4G/LTE Router, WWAN Failover Manager	Note : Mode 4: WCDMA Band 4_HSDPA Mode _1732.6_HSDPA_Link

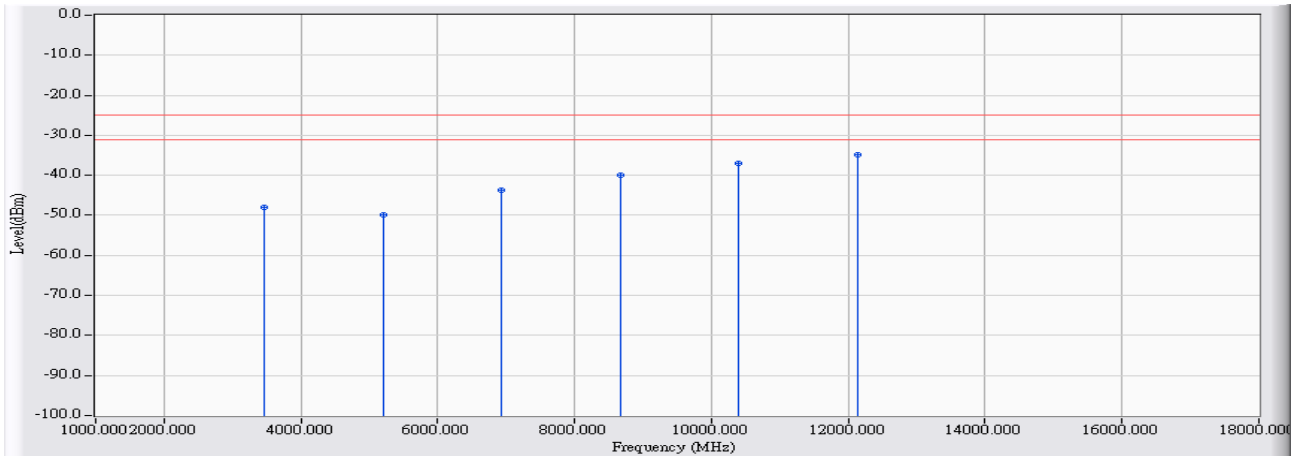

	Frequency (MHz)	Correct Factor (dB)	Reading Level (dBm)	Measure Level (dBm)	Margin (dB)	Limit (dBm)	Detector Type
1	3465.200	17.629	-65.680	-48.051	-23.051	-25.000	PEAK
2	5197.800	20.384	-70.310	-49.927	-24.927	-25.000	PEAK
3	6930.400	27.253	-70.900	-43.648	-18.648	-25.000	PEAK
4	8663.000	30.958	-70.880	-39.922	-14.922	-25.000	PEAK
5	10395.600	34.264	-71.330	-37.067	-12.067	-25.000	PEAK
6	* 12128.200	35.717	-70.670	-34.953	-9.953	-25.000	PEAK

Note:

1. All readings above 1GHz are performed with peak and/or average measurements as necessary.
2. Peak measurements: RBW = 1MHz, VBW = 1MHz, Sweep: Auto.
3. Average measurements: RBW = 1MHz, VBW = 10 Hz, Sweep: Auto.
4. “ * ”, means this data is the worst emission level.
5. Measurement Level = Reading Level + Correct Factor.
6. The average measurement was not performed when the peak measured data under the limit of average detection.
7. The Emission above 18GHz were not included is because their levels are too low.

Site : CB4-H	Time : 2017/02/24
Limit : FCC_Part27(outband)_00M_PK	Margin : 6
Probe : CB4_CE_Sub_B432_1-18GHz_3M_1116 - VERTICAL	Power : AC 120V / 60Hz
EUT : Advanced Industrial 4G/LTE Router, WWAN Failover Manager	Note : Mode 4: WCDMA Band 4_HSDPA Mode _1732.6_HSDPA_Link

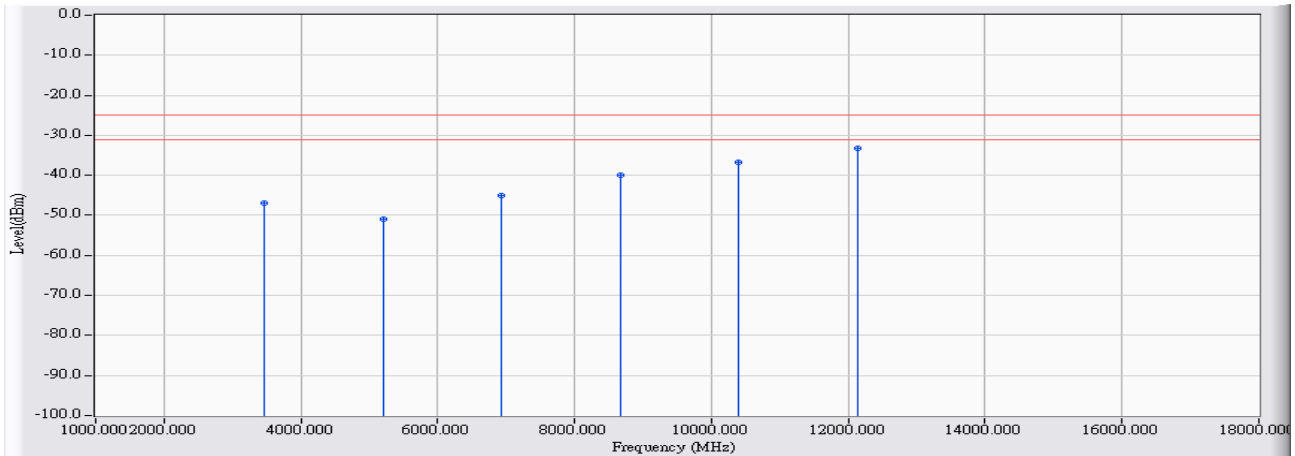

	Frequency (MHz)	Correct Factor (dB)	Reading Level (dBm)	Measure Level (dBm)	Margin (dB)	Limit (dBm)	Detector Type
1	3465.200	18.411	-65.320	-46.909	-21.909	-25.000	PEAK
2	5197.800	20.101	-70.920	-50.820	-25.820	-25.000	PEAK
3	6930.400	25.831	-70.900	-45.070	-20.070	-25.000	PEAK
4	8663.000	31.255	-71.230	-39.975	-14.975	-25.000	PEAK
5	10395.600	33.823	-70.520	-36.698	-11.698	-25.000	PEAK
6	* 12128.200	37.232	-70.460	-33.229	-8.229	-25.000	PEAK

Note:

1. All readings above 1GHz are performed with peak and/or average measurements as necessary.
2. Peak measurements: RBW = 1MHz, VBW = 1MHz, Sweep: Auto.
3. Average measurements: RBW = 1MHz, VBW = 10 Hz, Sweep: Auto.
4. “ * ”, means this data is the worst emission level.
5. Measurement Level = Reading Level + Correct Factor.
6. The average measurement was not performed when the peak measured data under the limit of average detection.
7. The Emission above 18GHz were not included is because their levels are too low.

Site : CB4-H	Time : 2017/02/24
Limit : FCC_Part27(outband)_00M_PK	Margin : 6
Probe : CB4_CE_Sub_B432_1-18GHz_3M_1116 - HORIZONTAL	Power : AC 120V / 60Hz
EUT : Advanced Industrial 4G/LTE Router, WWAN Failover Manager	Note : Mode 4: WCDMA Band 4_HSDPA Mode _1752.6_HSDPA_Link

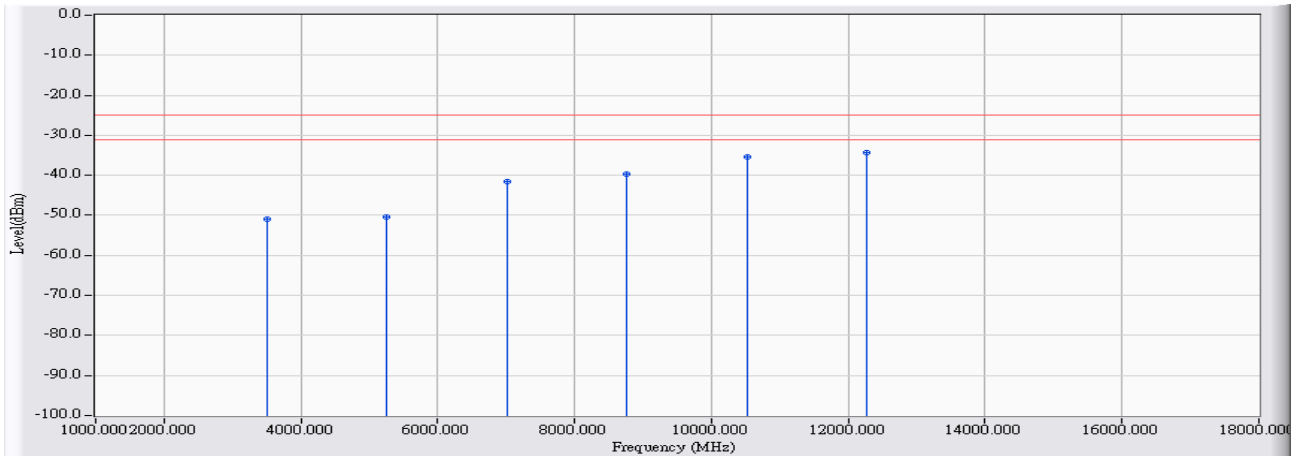

	Frequency (MHz)	Correct Factor (dB)	Reading Level (dBm)	Measure Level (dBm)	Margin (dB)	Limit (dBm)	Detector Type
1	3505.200	17.728	-68.550	-50.822	-25.822	-25.000	PEAK
2	5257.800	20.451	-70.800	-50.350	-25.350	-25.000	PEAK
3	7010.400	27.562	-69.170	-41.608	-16.608	-25.000	PEAK
4	8763.000	31.386	-70.950	-39.564	-14.564	-25.000	PEAK
5	10515.600	34.454	-69.900	-35.446	-10.446	-25.000	PEAK
6	* 12268.200	35.981	-70.380	-34.399	-9.399	-25.000	PEAK

Note:

1. All readings above 1GHz are performed with peak and/or average measurements as necessary.
2. Peak measurements: RBW = 1MHz, VBW = 1MHz, Sweep: Auto.
3. Average measurements: RBW = 1MHz, VBW = 10 Hz, Sweep: Auto.
4. “ * ”, means this data is the worst emission level.
5. Measurement Level = Reading Level + Correct Factor.
6. The average measurement was not performed when the peak measured data under the limit of average detection.
7. The Emission above 18GHz were not included is because their levels are too low.

Site : CB4-H	Time : 2017/02/24
Limit : FCC_Part27(outband)_00M_PK	Margin : 6
Probe : CB4_CE_Sub_B432_1-18GHz_3M_1116 - VERTICAL	Power : AC 120V / 60Hz
EUT : Advanced Industrial 4G/LTE Router, WWAN Failover Manager	Note : Mode 4: WCDMA Band 4_HSDPA Mode _1752.6_HSDPA_Link

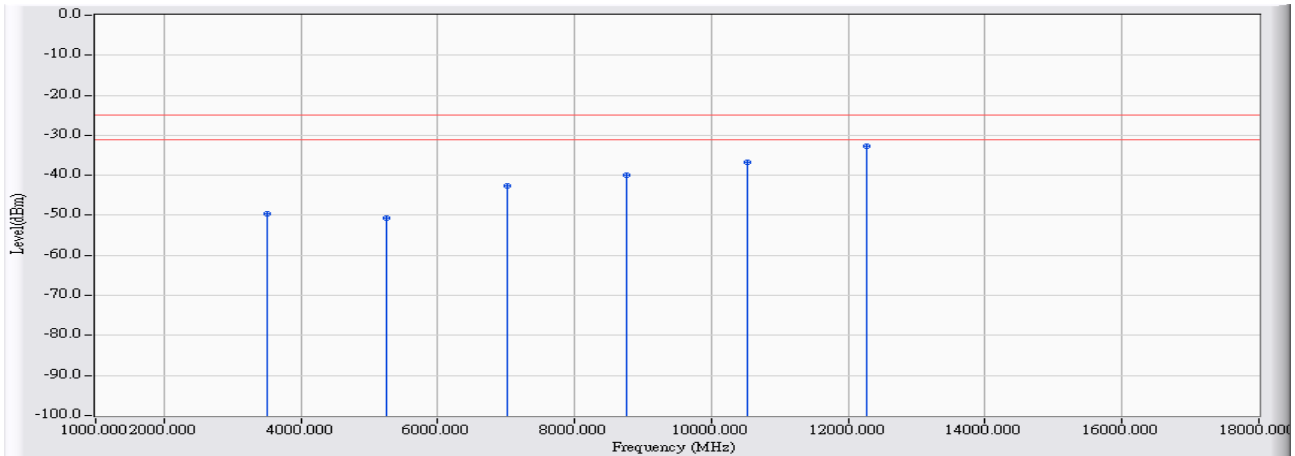

	Frequency (MHz)	Correct Factor (dB)	Reading Level (dBm)	Measure Level (dBm)	Margin (dB)	Limit (dBm)	Detector Type
1	3505.200	18.551	-68.170	-49.620	-24.620	-25.000	PEAK
2	5257.800	20.194	-70.870	-50.676	-25.676	-25.000	PEAK
3	7010.400	26.027	-68.530	-42.503	-17.503	-25.000	PEAK
4	8763.000	31.864	-71.780	-39.915	-14.915	-25.000	PEAK
5	10515.600	33.674	-70.530	-36.857	-11.857	-25.000	PEAK
6	* 12268.200	37.565	-70.320	-32.755	-7.755	-25.000	PEAK

Note:

1. All readings above 1GHz are performed with peak and/or average measurements as necessary.
2. Peak measurements: RBW = 1MHz, VBW = 1MHz, Sweep: Auto.
3. Average measurements: RBW = 1MHz, VBW = 10 Hz, Sweep: Auto.
4. “ * ”, means this data is the worst emission level.
5. Measurement Level = Reading Level + Correct Factor.
6. The average measurement was not performed when the peak measured data under the limit of average detection.
7. The Emission above 18GHz were not included is because their levels are too low.

Site : CB4-H	Time : 2017/02/24
Limit : FCC_Part27(outband)_00M_PK	Margin : 6
Probe : CB4_CE_Sub_B432_1-18GHz_3M_1116 - HORIZONTAL	Power : AC 120V / 60Hz
EUT : Advanced Industrial 4G/LTE Router, WWAN Failover Manager	Note : Mode 4: WCDMA Band 4_HSDPA Mode _1712.4_HSDPA_Idle

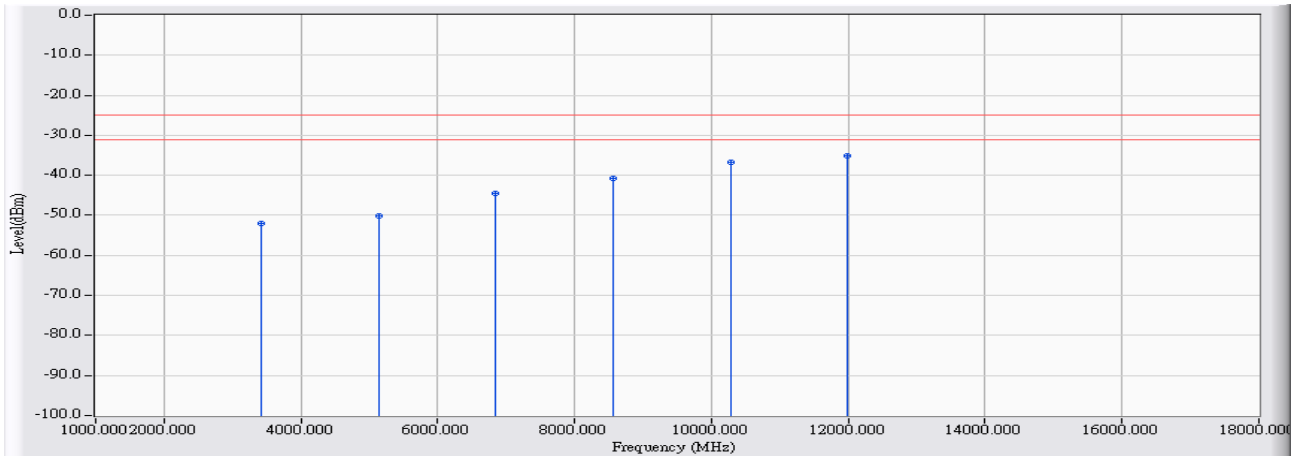

	Frequency (MHz)	Correct Factor (dB)	Reading Level (dBm)	Measure Level (dBm)	Margin (dB)	Limit (dBm)	Detector Type
1	3424.800	17.529	-69.540	-52.010	-27.010	-25.000	PEAK
2	5137.200	20.315	-70.560	-50.245	-25.245	-25.000	PEAK
3	6849.600	26.912	-71.480	-44.569	-19.569	-25.000	PEAK
4	8562.000	30.527	-71.190	-40.663	-15.663	-25.000	PEAK
5	10274.400	34.070	-70.710	-36.641	-11.641	-25.000	PEAK
6	* 11986.800	35.477	-70.710	-35.233	-10.233	-25.000	PEAK

Note:

1. All readings above 1GHz are performed with peak and/or average measurements as necessary.
2. Peak measurements: RBW = 1MHz, VBW = 1MHz, Sweep: Auto.
3. Average measurements: RBW = 1MHz, VBW = 10 Hz, Sweep: Auto.
4. “ * ”, means this data is the worst emission level.
5. Measurement Level = Reading Level + Correct Factor.
6. The average measurement was not performed when the peak measured data under the limit of average detection.
7. The Emission above 18GHz were not included is because their levels are too low.

Site : CB4-H	Time : 2017/02/24
Limit : FCC_Part27(outband)_00M_PK	Margin : 6
Probe : CB4_CE_Sub_B432_1-18GHz_3M_1116 - VERTICAL	Power : AC 120V / 60Hz
EUT : Advanced Industrial 4G/LTE Router, WWAN Failover Manager	Note : Mode 4: WCDMA Band 4_HSDPA Mode _1712.4_HSDPA_Idle

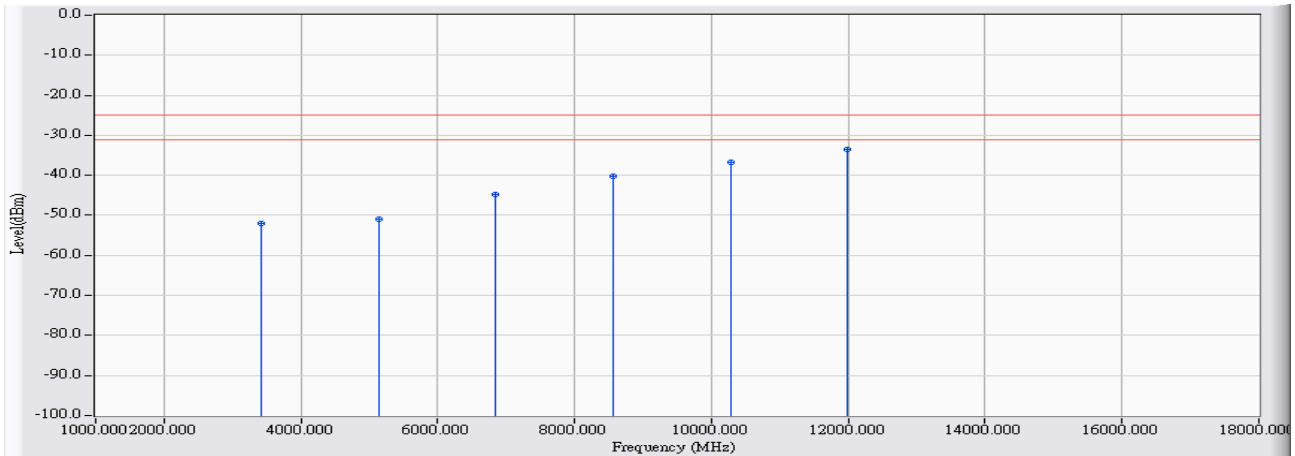

		Frequency (MHz)	Correct Factor (dB)	Reading Level (dBm)	Measure Level (dBm)	Margin (dB)	Limit (dBm)	Detector Type
1		3424.800	18.264	-70.190	-51.926	-26.926	-25.000	PEAK
2		5137.200	20.005	-71.070	-51.064	-26.064	-25.000	PEAK
3		6849.600	25.661	-70.320	-44.660	-19.660	-25.000	PEAK
4		8562.000	30.640	-70.850	-40.210	-15.210	-25.000	PEAK
5		10274.400	34.000	-70.670	-36.670	-11.670	-25.000	PEAK
6	*	11986.800	36.888	-70.330	-33.442	-8.442	-25.000	PEAK

Note:

1. All readings above 1GHz are performed with peak and/or average measurements as necessary.
2. Peak measurements: RBW = 1MHz, VBW = 1MHz, Sweep: Auto.
3. Average measurements: RBW = 1MHz, VBW = 10 Hz, Sweep: Auto.
4. “ * ”, means this data is the worst emission level.
5. Measurement Level = Reading Level + Correct Factor.
6. The average measurement was not performed when the peak measured data under the limit of average detection.
7. The Emission above 18GHz were not included is because their levels are too low.

Site : CB4-H	Time : 2017/02/24
Limit : FCC_Part27(outband)_00M_PK	Margin : 6
Probe : CB4_CE_Sub_B432_1-18GHz_3M_1116 - HORIZONTAL	Power : AC 120V / 60Hz
EUT : Advanced Industrial 4G/LTE Router, WWAN Failover Manager	Note : Mode 4: WCDMA Band 4_HSDPA Mode _1732.6_HSDPA_Idle

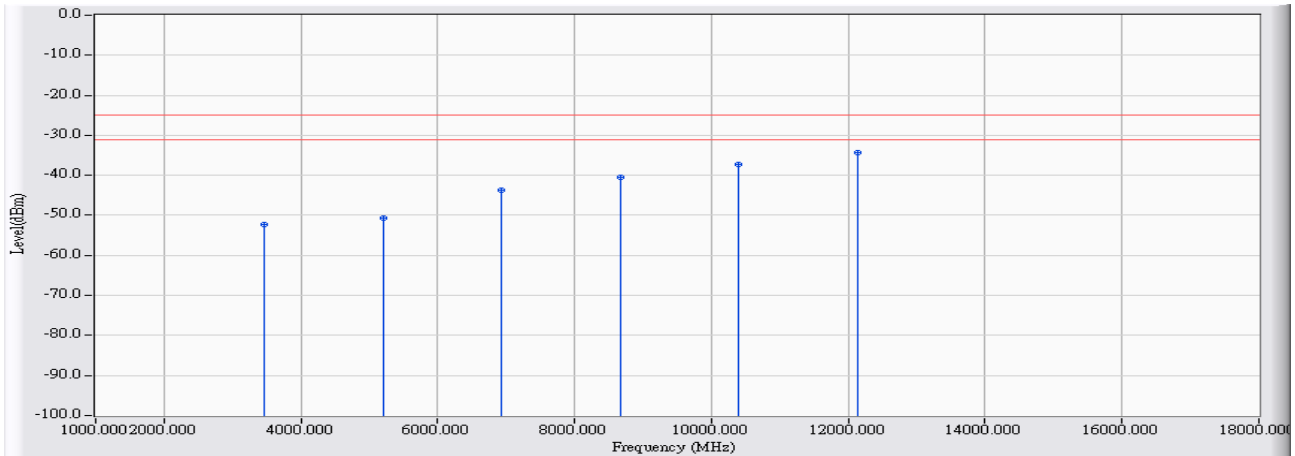

	Frequency (MHz)	Correct Factor (dB)	Reading Level (dBm)	Measure Level (dBm)	Margin (dB)	Limit (dBm)	Detector Type
1	3465.200	17.629	-69.950	-52.321	-27.321	-25.000	PEAK
2	5197.800	20.384	-70.940	-50.557	-25.557	-25.000	PEAK
3	6930.400	27.253	-71.050	-43.798	-18.798	-25.000	PEAK
4	8663.000	30.958	-71.550	-40.592	-15.592	-25.000	PEAK
5	10395.600	34.264	-71.540	-37.277	-12.277	-25.000	PEAK
6	* 12128.200	35.717	-70.100	-34.383	-9.383	-25.000	PEAK

Note:

1. All readings above 1GHz are performed with peak and/or average measurements as necessary.
2. Peak measurements: RBW = 1MHz, VBW = 1MHz, Sweep: Auto.
3. Average measurements: RBW = 1MHz, VBW = 10 Hz, Sweep: Auto.
4. “ * ”, means this data is the worst emission level.
5. Measurement Level = Reading Level + Correct Factor.
6. The average measurement was not performed when the peak measured data under the limit of average detection.
7. The Emission above 18GHz were not included is because their levels are too low.

Site : CB4-H	Time : 2017/02/24
Limit : FCC_Part27(outband)_00M_PK	Margin : 6
Probe : CB4_CE_Sub_B432_1-18GHz_3M_1116 - VERTICAL	Power : AC 120V / 60Hz
EUT : Advanced Industrial 4G/LTE Router, WWAN Failover Manager	Note : Mode 4: WCDMA Band 4_HSDPA Mode _1732.6_HSDPA_Idle

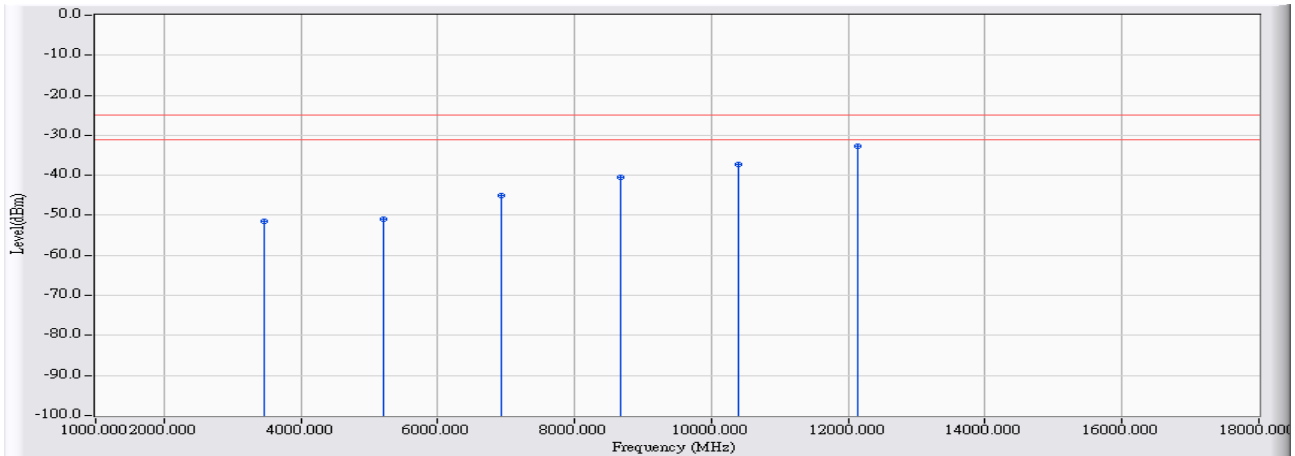

	Frequency (MHz)	Correct Factor (dB)	Reading Level (dBm)	Measure Level (dBm)	Margin (dB)	Limit (dBm)	Detector Type
1	3465.200	18.411	-69.770	-51.359	-26.359	-25.000	PEAK
2	5197.800	20.101	-71.110	-51.010	-26.010	-25.000	PEAK
3	6930.400	25.831	-70.890	-45.060	-20.060	-25.000	PEAK
4	8663.000	31.255	-71.610	-40.355	-15.355	-25.000	PEAK
5	10395.600	33.823	-71.130	-37.308	-12.308	-25.000	PEAK
6	* 12128.200	37.232	-69.830	-32.599	-7.599	-25.000	PEAK

Note:

1. All readings above 1GHz are performed with peak and/or average measurements as necessary.
2. Peak measurements: RBW = 1MHz, VBW = 1MHz, Sweep: Auto.
3. Average measurements: RBW = 1MHz, VBW = 10 Hz, Sweep: Auto.
4. “ * ”, means this data is the worst emission level.
5. Measurement Level = Reading Level + Correct Factor.
6. The average measurement was not performed when the peak measured data under the limit of average detection.
7. The Emission above 18GHz were not included is because their levels are too low.

Site : CB4-H	Time : 2017/02/24
Limit : FCC_Part27(outband)_00M_PK	Margin : 6
Probe : CB4_CE_Sub_B432_1-18GHz_3M_1116 - HORIZONTAL	Power : AC 120V / 60Hz
EUT : Advanced Industrial 4G/LTE Router, WWAN Failover Manager	Note : Mode 4: WCDMA Band 4_HSDPA Mode _1752.6_HSDPA_Idle

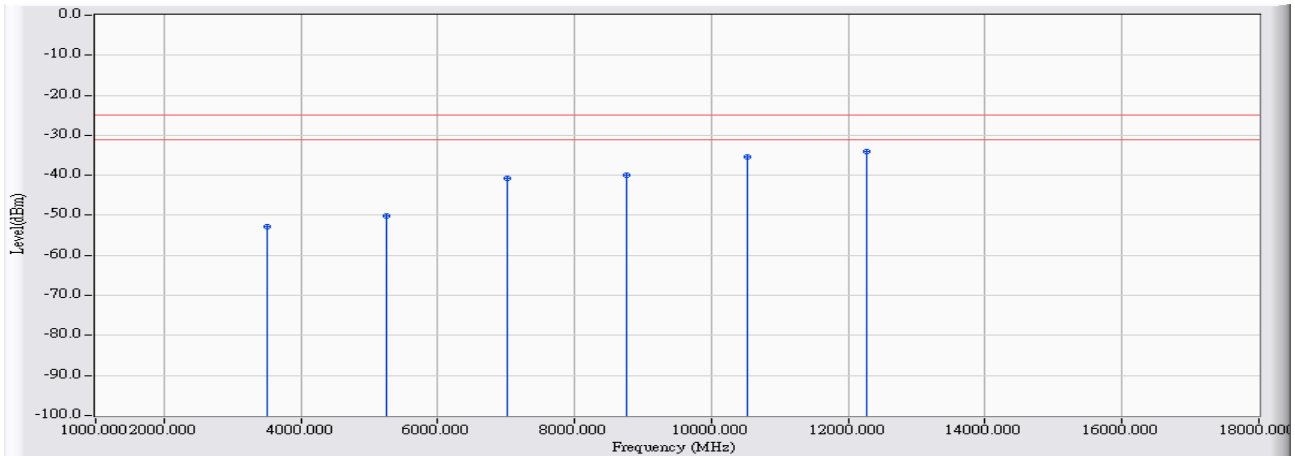

		Frequency (MHz)	Correct Factor (dB)	Reading Level (dBm)	Measure Level (dBm)	Margin (dB)	Limit (dBm)	Detector Type
1		3505.200	17.728	-70.480	-52.752	-27.752	-25.000	PEAK
2		5257.800	20.451	-70.650	-50.200	-25.200	-25.000	PEAK
3		7010.400	27.562	-68.230	-40.668	-15.668	-25.000	PEAK
4		8763.000	31.386	-71.300	-39.914	-14.914	-25.000	PEAK
5		10515.600	34.454	-69.950	-35.496	-10.496	-25.000	PEAK
6	*	12268.200	35.981	-69.940	-33.959	-8.959	-25.000	PEAK

Note:

1. All readings above 1GHz are performed with peak and/or average measurements as necessary.
2. Peak measurements: RBW = 1MHz, VBW = 1MHz, Sweep: Auto.
3. Average measurements: RBW = 1MHz, VBW = 10 Hz, Sweep: Auto.
4. “ * ”, means this data is the worst emission level.
5. Measurement Level = Reading Level + Correct Factor.
6. The average measurement was not performed when the peak measured data under the limit of average detection.
7. The Emission above 18GHz were not included is because their levels are too low.

Site : CB4-H	Time : 2017/02/24
Limit : FCC_Part27(outband)_00M_PK	Margin : 6
Probe : CB4_CE_Sub_B432_1-18GHz_3M_1116 - VERTICAL	Power : AC 120V / 60Hz
EUT : Advanced Industrial 4G/LTE Router, WWAN Failover Manager	Note : Mode 4: WCDMA Band 4_HSDPA Mode _1752.6_HSDPA_Idle

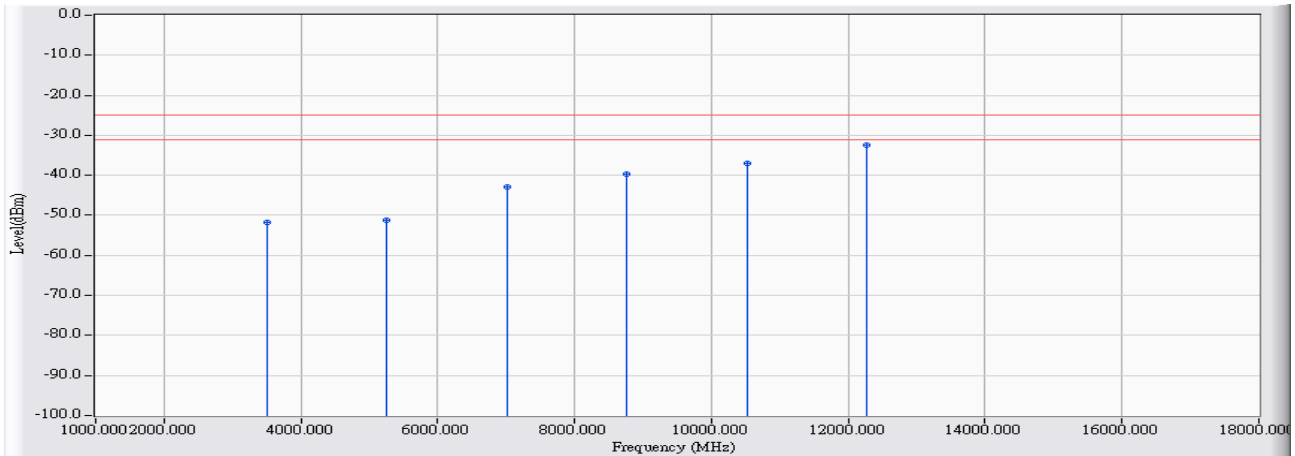

	Frequency (MHz)	Correct Factor (dB)	Reading Level (dBm)	Measure Level (dBm)	Margin (dB)	Limit (dBm)	Detector Type
1	3505.200	18.551	-70.230	-51.680	-26.680	-25.000	PEAK
2	5257.800	20.194	-71.420	-51.226	-26.226	-25.000	PEAK
3	7010.400	26.027	-68.960	-42.933	-17.933	-25.000	PEAK
4	8763.000	31.864	-71.600	-39.735	-14.735	-25.000	PEAK
5	10515.600	33.674	-70.780	-37.107	-12.107	-25.000	PEAK
6	* 12268.200	37.565	-70.120	-32.555	-7.555	-25.000	PEAK

Note:

1. All readings above 1GHz are performed with peak and/or average measurements as necessary.
2. Peak measurements: RBW = 1MHz, VBW = 1MHz, Sweep: Auto.
3. Average measurements: RBW = 1MHz, VBW = 10 Hz, Sweep: Auto.
4. “ * ”, means this data is the worst emission level.
5. Measurement Level = Reading Level + Correct Factor.
6. The average measurement was not performed when the peak measured data under the limit of average detection.
7. The Emission above 18GHz were not included is because their levels are too low.

8. Frequency Stability Over Temperatures Variation

8.1. Test Equipment

The following test equipments are used during the test:

Frequency Stability Over Temperatures Variation / SR10-H

Instrument	Manufacturer	Model No.	Serial No	Next Cal. Date
Temperature & Humidity Chamber	WIT	TH-1S-B	1082101	2018/01/18
Signal & Spectrum Analyzer	R&S	FSV40	101049	2018/01/22

Note: All equipments that need to calibrate are with calibration period of 1 year.

8.2. Test Setup

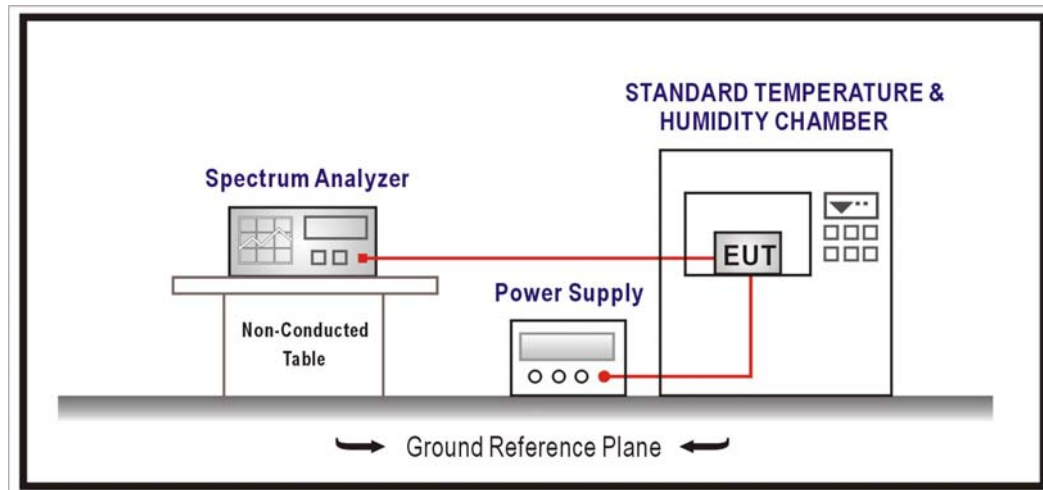

8.3. Limits

The frequency stability shall be measured with variation of ambient temperature as follows: From -30° to $+50^{\circ}$ centigrade for all equipment. Frequency measurements shall be made at the extremes of the specified temperature range and at intervals of not more than 10° centigrade through the range.

8.4. Test Procedure

Power must be turned off when changing from one temperature to another. Power warm up is at least 15 min and power applied should perform before recording frequency error. The temperature range step is 10 degrees in this test items. All temperature levels shall be holding the $\pm 0.5^{\circ}\text{C}$ during the measurement testing. The each temperature step shall be at least 0.5 hours, consider the EUT could be test under the stability condition.

8.5. Uncertainty

The measurement uncertainty is defined as $\pm 100\text{KHz}$

8.6. Test Result

Product	Advanced Industrial 4G/LTE Router, WWAN Failover Manager		
Test Item	Frequency Stability Over Temperatures Variation		
Test Mode	Mode 1: WCDMA Band 4_Link mode		
Date of Test	2017/02/06	Test Site	SR10-H

1712.4 MHz

TEMPERATURE	Frequency Error(Hz)	Frequency Error (ppm)
-30	-6	0.0034
-20	-5	0.0029
-10	6	-0.0036
0	11	-0.0062
+10	11	-0.0062
+20	23	-0.0133
+30	-21	0.0122
+40	24	-0.0143
+50	26	-0.0153

Product	Advanced Industrial 4G/LTE Router, WWAN Failover Manager		
Test Item	Frequency Stability Over Temperatures Variation		
Test Mode	Mode 1: WCDMA Band 4_Link mode		
Date of Test	2017/02/06	Test Site	SR10-H

1732.6 MHz

TEMPERATURE	Frequency Error(Hz)	Frequency Error (ppm)
-30	-4	0.0021
-20	-3	0.0019
-10	-3	0.0020
0	8	-0.0045
+10	-7	0.0043
+20	22	-0.0127
+30	-20	0.0115
+40	-4	0.0025
+50	20	-0.0118

Product	Advanced Industrial 4G/LTE Router, WWAN Failover Manager		
Test Item	Frequency Stability Over Temperatures Variation		
Test Mode	Mode 1: WCDMA Band 4_Link mode		
Date of Test	2017/02/06	Test Site	SR10-H

1752.6 MHz

TEMPERATURE	Frequency Error(Hz)	Frequency Error (ppm)
-30	11	-0.0061
-20	9	-0.0053
-10	-5	0.0029
0	-6	0.0037
+10	-8	0.0047
+20	-21	0.0118
+30	-21	0.0122
+40	-22	0.0128
+50	-19	0.0108

9. Frequency Stability Over Voltage Variation

9.1. Test Equipment

The following test equipments are used during the test:

Frequency Stability Over Voltage Variation / SR10-H

Instrument	Manufacturer	Model No.	Serial No	Next Cal. Date
Temperature & Humidity Chamber	WIT	TH-1S-B	1082101	2018/01/18
Signal & Spectrum Analyzer	R&S	FSV40	101049	2018/01/22

Note: All equipments that need to calibrate are with calibration period of 1 year.

9.2. Test Setup

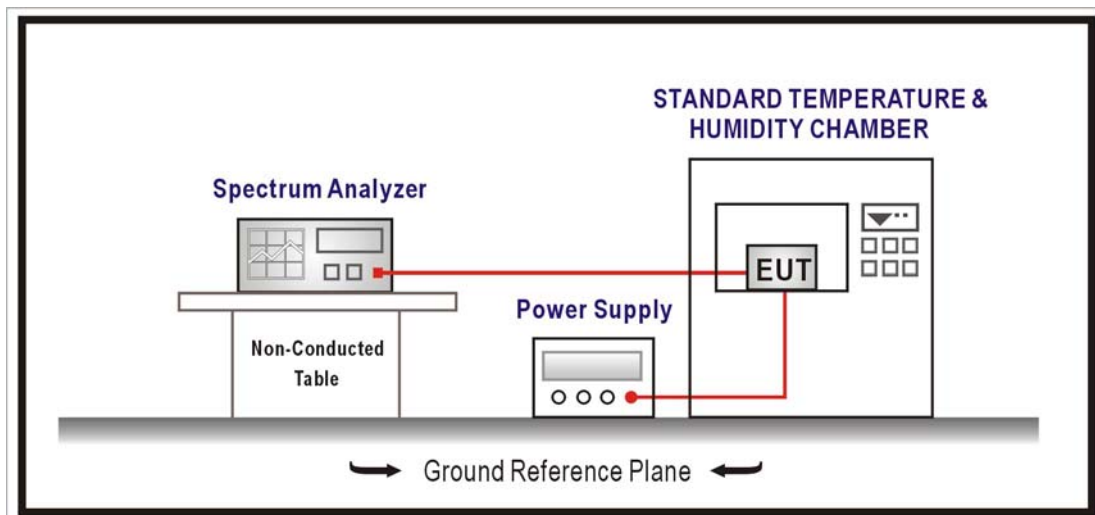

9.3. Limits

The frequency stability shall be measured with variation of primary supply voltage as follows:

- (1) Vary primary supply voltage from 85 to 115 percent of the nominal value for other than hand carried battery equipment.
- (2) For hand carried, battery powered equipment, reduce primary supply voltage to the battery operating end point which shall be specified by the manufacturer.
- (3) The supply voltage shall be measured at the input to the cable normally provided with the equipment, or at the power supply terminals if cables are not normally provided. Effects on frequency of transmitter keying (except for broadcast transmitters) and any heating element cycling at the nominal supply voltage and at each extreme also shall be shown.

9.4. Test Procedure

Power must be removed when changing from one voltage to another voltage. Power warm up is at least 15 min and power applied should perform before recording frequency error.

EUT is connected the external power supply to control the DC input power. The various Volts set from the minimum 4.5 Volts to 5.5 Volts. Each step shall be record the frequency error rate.

9.5. Uncertainty

The measurement uncertainty is defined as $\pm 100\text{KHz}$.

9.6. Test Result

Product	Advanced Industrial 4G/LTE Router, WWAN Failover Manager		
Test Item	Frequency Stability Over Voltage Variation		
Test Mode	Mode 1: WCDMA Band 4_Link mode		
Date of Test	2016/12/28	Test Site	SR10-H

1712.4 MHz

Voltage (VDC)	Frequency Error(Hz)	Frequency Error(ppm)
4.2	17	-0.0098
3.7	19	-0.0111
3.4	20	-0.0119

1732.6 MHz

Voltage (VDC)	Frequency Error(Hz)	Frequency Error(ppm)
4.2	-11	0.0065
3.7	-3	0.0016
3.4	5	-0.0031

1752.6 MHz

Voltage (VDC)	Frequency Error(Hz)	Frequency Error(ppm)
4.2	-12	0.0069
3.7	-18	0.0100
3.4	-18	0.0101

10. Peak to Average Ratio

10.1. Test Equipment

The following test equipments are used during the test:

Peak to Average Ratio / SR10-H

Instrument	Manufacturer	Model No.	Serial No.	Next Cal. Date
Signal & Spectrum Analyzer	R&S	FSV40	101049	2018/01/22
Multisystem UE Tester	Japan radio	NJZ-2000	ET00477	2017/09/19
Directional Coupler	Agilent	778D	20402	2017/10/06

Note: All equipments are calibrated with traceable calibrations.

Each calibration is traceable to the national or international standards.

10.2. Test Setup

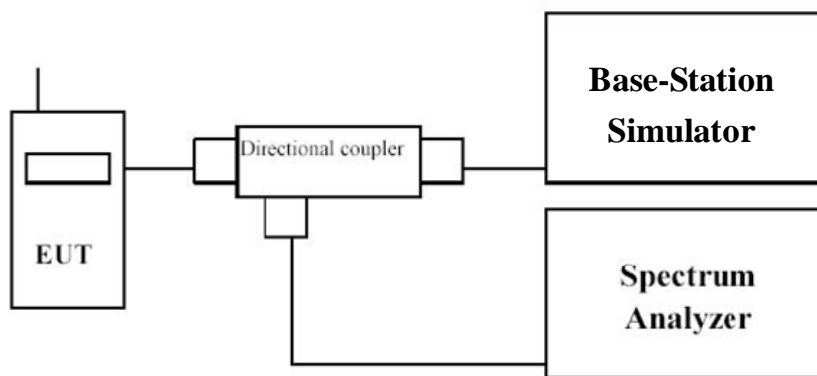

10.3. Limits

The peak-to-average power ratio (PAPR) of the transmitter output power must not exceed 13 dB. The PAPR measurements should be made using either an instrument with complementary cumulative distribution function (CCDF) capabilities to determine that PAPR will not exceed 13 dB for more than 0.1 percent of the time or other Commission approved procedure.

10.4. Test Procedure

- a) Refer to instrument's analyzer instruction manual for details on how to use the power statistics/CCDF function;
- b) Set resolution/measurement bandwidth \geq signal's occupied bandwidth;
- c) Set the number of counts to a value that stabilizes the measured CCDF curve;
- d) Set the measurement interval as follows:
 - 1) for continuous transmissions, set to 1 ms,

2) for burst transmissions, employ an external trigger that is synchronized with the EUT burst timing sequence, or use the internal burst trigger with a trigger level that allows the burst to stabilize and set the measurement interval to a time that is less than or equal to the burst duration.

e) Record the maximum PAPR level associated with a probability of 0.1%.

10.5. Uncertainty

The measurement uncertainty is defined as ± 1.5 dB

10.6. Test Result

Product	Advanced Industrial 4G/LTE Router, WWAN Failover Manager
Test Mode	Peak to Average Ratio
Test Condition	WCDMA_Band4

