



FCC 47 CFR PART 15 SUBPART C

TEST REPORT

For

Point-to-Point Fibre Wireless-N VPN VoIP Gateway

Model:

**BiPAC 9800VNX-PD, BiPAC 9800VNXL-PD, BiPAC 9800VN-PD, BiPAC 9800VNL-PD,
BiPAC 9800VX-PD, BiPAC 9800VXL-PD, BiPAC 9800V-PD, BiPAC 9800VL-PD,
BiPAC 9800X-PD, BiPAC 9800XL-PD, BiPAC 9800N-PD, BiPAC 9800NL-PD,
BiPAC 9800-PD, BiPAC 9800L-PD, BiPAC 9800VNX, BiPAC 9800VNXL, BiPAC 9800VN,
BiPAC 9800VNL, BiPAC 9800VX, BiPAC 9800VXL, BiPAC 9800V, BiPAC 9800VL,
BiPAC 9800X, BiPAC 9800XL, BiPAC 9800N, BiPAC 9800NL, BiPAC 9800,
BiPAC 9800L, BEC 9800VN, BEC 9800VNL, BEC 9800V, BEC 9800VL, BEC 9800N, BEC
9810VN, BEC 9810VNL**

Trade Name: Billion

Issued to

Billion Electric Co., Ltd.
8F., No.192, Sec. 2, Zhongxing Rd., Xindian Dist.,
New Taipei City 231, Taiwan (R.O.C.)

Issued by

Compliance Certification Services Inc.
No.11, Wugong 6th Rd., Wugu Dist.,
New Taipei City 24891, Taiwan. (R.O.C.)
<http://www.ccsrf.com>
service@ccsrf.com

Issued Date: December 9, 2013



Note: This report shall not be reproduced except in full, without the written approval of Compliance Certification Services Inc. This document may be altered or revised by Compliance Certification Services Inc. personnel only, and shall be noted in the revision section of the document.



Revision History

Rev.	Issue Date	Revisions	Effect Page	Revised By
00	December 9, 2013	Initial Issue	ALL	Eunice Shen



TABLE OF CONTENTS

1. TEST RESULT CERTIFICATION.....	4
2. EUT DESCRIPTION	5
3. TEST METHODOLOGY	7
3.1 EUT CONFIGURATION	7
3.2 EUT EXERCISE.....	7
3.3 GENERAL TEST PROCEDURES.....	7
3.4 FCC PART 15.205 RESTRICTED BANDS OF OPERATIONS.....	8
3.5 DESCRIPTION OF TEST MODES	9
4. INSTRUMENT CALIBRATION.....	10
4.1 MEASURING INSTRUMENT CALIBRATION	10
4.2 MEASUREMENT EQUIPMENT USED	10
4.3 MEASUREMENT UNCERTAINTY	11
5. FACILITIES AND ACCREDITATIONS	12
5.1 FACILITIES	12
5.2 EQUIPMENT.....	12
5.3 TABLE OF ACCREDITATIONS AND LISTINGS.....	13
6. SETUP OF EQUIPMENT UNDER TEST	14
6.1 SETUP CONFIGURATION OF EUT.....	14
6.2 SUPPORT EQUIPMENT	14
7. FCC PART 15.247 REQUIREMENTS.....	15
7.1 6DB BANDWIDTH.....	15
7.2 PEAK POWER.....	35
7.3 BAND EDGES MEASUREMENT	37
7.4 PEAK POWER SPECTRAL DENSITY.....	67
7.5 SPURIOUS EMISSIONS.....	87
7.6 RADIATED EMISSIONS	106
7.7 POWERLINE CONDUCTED EMISSIONS.....	123
APPENDIX I PHOTOGRAPHS OF TEST SETUP.....	126
APPENDIX 1 - PHOTOGRAPHS OF EUT	



1. TEST RESULT CERTIFICATION

Applicant: Billion Electric Co., Ltd.
8F., No.192, Sec. 2, Zhongxing Rd., Xindian Dist., New Taipei City 231, Taiwan (R.O.C.)

Equipment Under Test: Point-to-Point Fibre Wireless-N VPN VoIP Gateway

Trade Name: Billion

Model Number: BiPAC 9800VNX-PD, BiPAC 9800VNXL-PD, BiPAC 9800VN-PD, BiPAC 9800VNL-PD, BiPAC 9800VX-PD, BiPAC 9800VXL-PD, BiPAC 9800V-PD, BiPAC 9800VL-PD, BiPAC 9800X-PD, BiPAC 9800XL-PD, BiPAC 9800N-PD, BiPAC 9800NL-PD, BiPAC 9800-PD, BiPAC 9800L-PD, BiPAC 9800VNX, BiPAC 9800VNXL, BiPAC 9800VN, BiPAC 9800VNL, BiPAC 9800VX, BiPAC 9800VXL, BiPAC 9800V, BiPAC 9800VL, BiPAC 9800X, BiPAC 9800XL, BiPAC 9800N, BiPAC 9800NL, BiPAC 9800, BiPAC 9800L, BEC 9800VN, BEC 9800VNL, BEC 9800V, BEC 9800VL, BEC 9800N, BEC 9810VN, BEC 9810VNL

Date of Test: November 6 ~ December 19, 2013

APPLICABLE STANDARDS	
STANDARD	TEST RESULT
FCC 47 CFR Part 15 Subpart C	No non-compliance noted

We hereby certify that:

The above equipment was tested by Compliance Certification Services Inc. The test data, data evaluation, test procedures, and equipment configurations shown in this report were made in accordance with the procedures given in ANSI C63.4: 2009 and the energy emitted by the sample EUT tested as described in this report is in compliance with the requirements of FCC Rules Part 15.207, 15.209, 15.247.

The test results of this report relate only to the tested sample EUT identified in this report.

Approved by:

Reviewed by:

Miller Lee
Section Manager
Compliance Certification Services Inc.

Angel Cheng
Section Manager
Compliance Certification Services Inc.



2. EUT DESCRIPTION

Product	Point-to-Point Fibre Wireless-N VPN VoIP Gateway					
Trade Name	Billion					
Model Number	BiPAC 9800VNX-PD, BiPAC 9800VNXL-PD, BiPAC 9800VN-PD, BiPAC 9800VNL-PD, BiPAC 9800VX-PD, BiPAC 9800VXL-PD, BiPAC 9800V-PD, BiPAC 9800VL-PD, BiPAC 9800X-PD, BiPAC 9800XL-PD, BiPAC 9800N-PD, BiPAC 9800NL-PD, BiPAC 9800-PD, BiPAC 9800L-PD, BiPAC 9800VNX, BiPAC 9800VNXL, BiPAC 9800VN, BiPAC 9800VNL, BiPAC 9800VX, BiPAC 9800VXL, BiPAC 9800V, BiPAC 9800VL, BiPAC 9800X, BiPAC 9800XL, BiPAC 9800N, BiPAC 9800NL, BiPAC 9800, BiPAC 9800L, BEC 9800VN, BEC 9800VNL, BEC 9800V, BEC 9800VL, BEC 9800N, BEC 9810VN, BEC 9810VNL					
Model Discrepancy	1. Difference of the 35 model numbers (list on this report) is just for different functions only.					
		<i>Wireless-N</i>	<i>USB</i>	<i>VoIP</i>	<i>VPN</i>	<i>PoE (Power over Ethernet port#4)</i>
	<i>BiPAC 9800VNX-PD</i>	V	V	V	V	V
	<i>BiPAC 9800VNXL-PD</i>	V	V	V	X	V
	<i>BiPAC 9800VN-PD</i>	V	X	V	V	V
	<i>BiPAC 9800VNL-PD</i>	V	X	V	X	V
	<i>BiPAC 9800VX-PD</i>	X	V	V	V	V
	<i>BiPAC 9800VXL-PD</i>	X	V	V	X	V
	<i>BiPAC 9800V-PD</i>	X	X	V	V	V
	<i>BiPAC 9800VL-PD</i>	X	X	V	X	V
	<i>BiPAC 9800X-PD</i>	X	V	X	V	V
	<i>BiPAC 9800XL-PD</i>	X	V	X	X	V
	<i>BiPAC 9800N-PD</i>	V	X	X	V	V
	<i>BiPAC 9800NL-PD</i>	V	X	X	X	V
	<i>BiPAC 9800-PD</i>	X	X	X	V	V
	<i>BiPAC 9800L-PD</i>	X	X	X	X	V
	<i>BiPAC 9800VNX</i>	V	V	V	V	X
	<i>BiPAC 9800VNXL</i>	V	V	V	X	X
	<i>BiPAC 9800VN</i>	V	X	V	V	X
	<i>BiPAC 9800VNL</i>	V	X	V	X	X
	<i>BiPAC 9800VX</i>	X	V	V	V	X
	<i>BiPAC 9800VXL</i>	X	V	V	X	X
	<i>BiPAC 9800V</i>	X	X	V	V	X
	<i>BiPAC 9800VL</i>	X	X	V	X	X
	<i>BiPAC 9800X</i>	X	V	X	V	X
	<i>BiPAC 9800XL</i>	X	V	X	X	X
	<i>BiPAC 9800N</i>	V	X	X	V	X
	<i>BiPAC 9800NL</i>	V	X	X	X	X
	<i>BiPAC 9800</i>	X	X	X	V	X
	<i>BiPAC 9800L</i>	X	X	X	X	X
	<i>BEC 9800VN</i>	V	V	V	X	V
	<i>BEC 9800VNL</i>	V	X	V	X	V
<i>BEC 9800V</i>	X	V	V	X	V	
<i>BEC 9800VL</i>	X	X	V	X	V	
<i>BEC 9800N</i>	V	X	X	X	V	
<i>BEC 9810VN</i>	V	V	V	X	X	
<i>BEC 9810VNL</i>	V	X	V	X	X	
2. The EUT comes with two different external colors, please refer to the external photos for reference.						
Received Date	November 5, 2013					



Power Adapter	EGB / Model: PAW018A12UL I/P: 100-240V, 50/60Hz, 0.5A O/P: 12V, 1.5A
Frequency Range	IEEE 802.11b/g/ IEEE 802.11n HT 20mode 2412 ~ 2462 MHz IEEE 802.11n HT 40 mode: 2422 ~ 2452 MHz
Transmit Power	IEEE 802.11b mode: 17.61 dBm (0.0577W) IEEE 802.11g mode: 24.86 dBm (0.3062W) IEEE 802.11n HT 20 mode: 25.29 dBm (0.3381W) IEEE 802.11n HT 40 mode: 23.96 dBm (0.2489W)
Modulation Technique	IEEE 802.11b mode: DSSS IEEE 802.11g mode: OFDM IEEE 802.11n HT 20 mode: OFDM IEEE 802.11n HT 40 mode: OFDM
Number of Channels	IEEE 802.11b/g mode: 11 Channels IEEE 802.11n HT 20 mode: 11 Channels IEEE 802.11n HT 40 mode: 7 Channels
Antenna Specification	Gain: 2 dBi
Antenna Designation	Dipole Antenna

Remark:

1. The sample selected for test was engineering sample that approximated to production product and was provided by manufacturer.
2. This submittal(s) (test report) is intended for FCC ID: QI3BIL-9800VNXPDP filing to comply with Section 15.207, 15.209 and 15.247 of the FCC Part 15, Subpart C Rules.



3. TEST METHODOLOGY

The tests documented in this report were performed in accordance with ANSI C63.4: 2009 and FCC CFR 47 Part 15.207, 15.209, 15.247, KDB558074.

3.1 EUT CONFIGURATION

The EUT configuration for testing is installed on RF field strength measurement to meet the Commissions requirement and operating in a manner that intends to maximize its emission characteristics in a continuous normal application.

3.2 EUT EXERCISE

The EUT was operated in the engineering mode to fix the TX frequency that was for the purpose of the measurements.

According to its specifications, the EUT must comply with the requirements of the Section 15.207, 15.209 and 15.247 under the FCC Rules Part 15 Subpart C.

3.3 GENERAL TEST PROCEDURES

Conducted Emissions

The EUT is placed on the turntable, which is 0.8 m above ground plane. According to the requirements in Section 13.1.4.1 of ANSI C63.4 Conducted emissions from the EUT measured in the frequency range between 0.15 MHz and 30MHz using CISPR Quasi-peak and average detector modes.

Radiated Emissions

The EUT is placed on a turn table, which is 0.8 m above ground plane. The turntable shall rotate 360 degrees to determine the position of maximum emission level. EUT is set 3m away from the receiving antenna, which varied from 1m to 4m to find out the highest emission. And also, each emission was to be maximized by changing the polarization of receiving antenna both horizontal and vertical. In order to find out the maximum emissions, exploratory radiated emission measurements were made according to the requirements in Section 13.1.4.1 of ANSI C63.4.



3.4 FCC PART 15.205 RESTRICTED BANDS OF OPERATIONS

(a) Except as shown in paragraph (d) of this section, only spurious emissions are permitted in any of the frequency bands listed below:

MHz	MHz	MHz	GHz
0.090 - 0.110	16.42 - 16.423	399.9 - 410	4.5 - 5.15
¹ 0.495 - 0.505	16.69475 - 16.69525	608 - 614	5.35 - 5.46
2.1735 - 2.1905	16.80425 - 16.80475	960 - 1240	7.25 - 7.75
4.125 - 4.128	25.5 - 25.67	1300 - 1427	8.025 - 8.5
4.17725 - 4.17775	37.5 - 38.25	1435 - 1626.5	9.0 - 9.2
4.20725 - 4.20775	73 - 74.6	1645.5 - 1646.5	9.3 - 9.5
6.215 - 6.218	74.8 - 75.2	1660 - 1710	10.6 - 12.7
6.26775 - 6.26825	108 - 121.94	1718.8 - 1722.2	13.25 - 13.4
6.31175 - 6.31225	123 - 138	2200 - 2300	14.47 - 14.5
8.291 - 8.294	149.9 - 150.05	2310 - 2390	15.35 - 16.2
8.362 - 8.366	156.52475 -	2483.5 - 2500	17.7 - 21.4
8.37625 - 8.38675	156.52525	2655 - 2900	22.01 - 23.12
8.41425 - 8.41475	156.7 - 156.9	3260 - 3267	23.6 - 24.0
12.29 - 12.293	162.0125 - 167.17	3332 - 3339	31.2 - 31.8
12.51975 - 12.52025	167.72 - 173.2	3345.8 - 3358	36.43 - 36.5
12.57675 - 12.57725	240 - 285	3600 - 4400	(²)
13.36 - 13.41	322 - 335.4		

¹ Until February 1, 1999, this restricted band shall be 0.490-0.510 MHz.

² Above 38.6

(b) Except as provided in paragraphs (d) and (e), the field strength of emissions appearing within these frequency bands shall not exceed the limits shown in Section 15.209. At frequencies equal to or less than 1000 MHz, compliance with the limits in Section 15.209 shall be demonstrated using measurement instrumentation employing a CISPR quasi-peak detector. Above 1000 MHz, compliance with the emission limits in Section 15.209 shall be demonstrated based on the average value of the measured emissions. The provisions in Section 15.35 apply to these measurements.



3.5 DESCRIPTION OF TEST MODES

The EUT (model: BiPAC 9800VNX-PD) is a 2x2 configuration spatial MIMO (2Tx & 2Rx) without beam forming function that operate in double TX chains and double RX chains. The 2x2 configuration is implemented with two outside TX & RX chains (Chain 0 and 1).

Software used to control the EUT for staying in continuous transmitting mode was programmed.

After verification, all tests were carried out with the worst case test modes as shown below except radiated spurious emission below 1GHz and power line conducted emissions below 30MHz, which worst case was in normal link mode only.

IEEE 802.11b mode:

Channel Low (2412MHz), Channel Mid (2437MHz) and Channel High (2462MHz) with 1Mbps data rate and cyclic delay diversity were chosen for full testing.

IEEE 802.11g mode:

Channel Low (2412MHz), Channel Mid (2437MHz) and Channel High (2462MHz) with 6Mbps data rate and cyclic delay diversity were chosen for full testing.

IEEE 802.11n HT 20 mode:

Channel Low (2412MHz), Channel Mid (2437MHz) and Channel High (2462MHz) with 6.5Mbps data rate were chosen for full testing.

IEEE 802.11n HT 40 mode:

Channel Low (2422MHz), Channel Mid (2437MHz) and Channel High (2452MHz) with 13.5Mbps data rate were chosen for full testing.



4. INSTRUMENT CALIBRATION

4.1 MEASURING INSTRUMENT CALIBRATION

The measuring equipment, which was utilized in performing the tests documented herein, has been calibrated in accordance with the manufacturer's recommendations for utilizing calibration equipment, which is traceable to recognized national standards.

4.2 MEASUREMENT EQUIPMENT USED

Equipment Used for Emissions Measurement

Remark: Each piece of equipment is scheduled for calibration once a year.

Conducted Emissions Test Site				
Name of Equipment	Manufacturer	Model	Serial Number	Calibration Due
Spectrum Analyzer	Agilent	E4446A	MY43360131	03/20/2014
Power Meter	Anritsu	ML2495A	1012009	06/04/2014
Power Sensor	Anritsu	MA2411A	0917072	06/04/2014

3M Chamber Test Site				
Name of Equipment	Manufacturer	Model	Serial Number	Calibration Due
Spectrum Analyzer	Agilent	E4446A	US42510268	11/05/2014
EMI Test Receiver	R&S	ESCI	100064	02/28/2014
Pre-Amplifier	Mini-Circuits	ZFL-1000LN	SF350700823	01/12/2014
Pre-Amplifier	MITEQ	AFS44-00102650-42-10P-44	1415367	11/18/2014
Bilog Antenna	Sunol Sciences	JB3	A030105	10/01/2014
Horn Antenna	EMCO	3117	00055165	02/13/2014
Horn Antenna	EMCO	3116	2487	10/09/2014
Loop Antenna	EMCO	6502	8905/2356	06/12/2014
Turn Table	CCS	CC-T-1F	N/A	N.C.R
Antenna Tower	CCS	CC-A-1F	N/A	N.C.R
Controller	CCS	CC-C-1F	N/A	N.C.R
Site NSA	CCS	N/A	N/A	12/21/2014
Test S/W	EZ-EMC (CCS-3A1RE)			

Conducted Emission room				
Name of Equipment	Manufacturer	Model	Serial Number	Calibration Due
EMI Test Receiver	R&S	ESCI	101073	07/30/2014
LISN	R&S	ENV216	101054	06/05/2014
LISN	SCHWARZBECK	NSLK 8127	8127-541	12/09/2014
Capacitive Voltage Probe	FCC	F-CVP-1	100185	03/15/2014
Test S/W	CCS-3A1-CE			



4.3 MEASUREMENT UNCERTAINTY

PARAMETER	UNCERTAINTY
Powerline Conducted Emission	+/- 1.2575
3M Semi Anechoic Chamber / <200M	+/- 4.0138
3M Semi Anechoic Chamber / 200M~1000M	+/- 3.9483
3M Semi Anechoic Chamber / 1G~8G	+/- 2.5975
3M Semi Anechoic Chamber / 8G~18G	+/- 2.6112
3M Semi Anechoic Chamber / 18G~26G	+/- 2.7389
3M Semi Anechoic Chamber / 26G~40G	+/- 2.9683

Remark: This uncertainty represents an expanded uncertainty expressed at approximately the 95% confidence level using a coverage factor of $k=2$.



5. FACILITIES AND ACCREDITATIONS

5.1 FACILITIES

All measurement facilities used to collect the measurement data are located at

No.199, Chungshen Road, Hsintien City, Taipei Hsien, Taiwan, R.O.C.

Tel: 886-2-2217-0894 / Fax: 886-2-2217-1029

No.11, Wugong 6th Rd., Wugu Dist., New Taipei City 24891, Taiwan. (R.O.C.)

Tel: 886-2-2299-9720 / Fax: 886-2-2298-4045

No.81-1, Lane 210, Bade 2nd Rd., Lujhu Township, Taoyuan County 33841, TAIWAN, R.O.C.

Tel: 886-3-324-0332 / Fax: 886-3-324-5235

The sites are constructed in conformance with the requirements of ANSI C63.7, ANSI C63.4 and CISPR Publication 22.

5.2 EQUIPMENT

Radiated emissions are measured with one or more of the following types of linearly polarized antennas: tuned dipole, biconical, log periodic, bi-log, and/or ridged waveguide, horn. Spectrum analyzers with pre-selectors and quasi-peak detectors are used to perform radiated measurements.



Conducted emissions are measured with Line Impedance Stabilization Networks and EMI Test Receivers.

Calibrated wideband preamplifiers, coaxial cables, and coaxial attenuators are also used for making measurements.

All receiving equipment conforms to CISPR Publication 16-1, "Radio Interference Measuring Apparatus and Measurement Methods."



5.3 TABLE OF ACCREDITATIONS AND LISTINGS

Country	Agency	Scope of Accreditation	Logo
USA	FCC	3M Semi Anechoic Chamber (FCC MRA: TW1039) to perform FCC Part 15 measurements	 FCC MRA: TW1039
Taiwan	TAF	LP0002, RTTE01, FCC Method-47 CFR Part 15 Subpart C, D, E, RSS-210, RSS-310 IDA TS SRD, AS/NZS 4268, AS/NZS 4771, TS 12.1 & 12.2, ETSI EN 300 440-1, ETSI EN 300 440-2, ETSI EN 300 328, ETSI EN 300 220-1, ETSI EN 300 220-2, ETSI EN 301 893, ETSI EN 301 489-1/3/7/17 FCC OET Bulletin 65 + Supplement C, EN 50360, EN 50361, EN 50371, RSS 102, EN 50383, EN 50385, EN 50392, IEC 62209, CNS 14958-1, CNS 14959 FCC Method -47 CFR Part 15 Subpart B IEC / EN 61000-3-2, IEC / EN 61000-3-3, IEC / EN 61000-4-2/3/4/5/6/8/11	
Canada	Industry Canada	3M Semi Anechoic Chamber (IC 2324G-1 / IC 2324G-2) to perform	

* No part of this report may be used to claim or imply product endorsement by A2LA or any agency of the US Government.



6. SETUP OF EQUIPMENT UNDER TEST

6.1 SETUP CONFIGURATION OF EUT

See test photographs attached in Appendix II for the actual connections between EUT and support equipment.

6.2 SUPPORT EQUIPMENT

No	Equipment	Brand	Model	Series No.	FCC ID	Power Cord
1.	NB (Remote)	HP	Pavilion dv6	CNF9491GLJ	N/A	Unshielded, 2.0m
2.	NB (Remote)	HP	Pavilion dv6	VX250PA#ABO	N/A	Unshielded, 2.0m
3.	Terminal	N/A	N/A	N/A	N/A	N/A
4.	Switch	D-LINK	N/A	N/A	N/A	Unshielded, 1.8m
5.	Telephone	TOMAT	MT-909	N/A	N/A	Unshielded, 3.0m
6.	Telephone	TOMAT	MT-909	N/A	N/A	Unshielded, 3.0m
7.	Printer	EPSON	Stylus-C63	FAPY150360	N/A	Unshielded, 1.8m

Remark:

1. All the equipment/cables were placed in the worst-case configuration to maximize the emission during the test.
2. Grounding was established in accordance with the manufacturer's requirements and conditions for the intended use.



7. FCC PART 15.247 REQUIREMENTS

7.1 6DB BANDWIDTH

LIMIT

According to §15.247(a)(2), systems using digital modulation techniques may operate in the 902 - 928 MHz, 2400 - 2483.5 MHz, and 5725 - 5850 MHz bands. The minimum 6dB bandwidth shall be at least 500 kHz.

Test Configuration

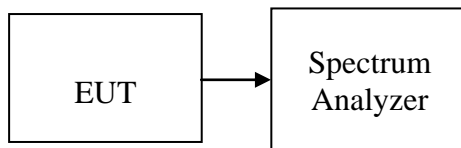

TEST PROCEDURE

The transmitter output is connected to the spectrum analyzer. Set the RBW=100kHz the emission bandwidth, VBW $\geq 3 \times$ RBW, Detector = Peak, Trace mode = max hold, Sweep = auto couple. Measure the maximum width of the emission that is constrained by the frequencies associated with the two amplitude points (upper and lower) that are attenuated by 6dB relative to the maximum level measured in the fundamental emission.

TEST RESULTS

No non-compliance noted.



Test Data

Test mode: IEEE 802.11b mode

Channel	Frequency (MHz)	Bandwidth (MHz)	Limit (kHz)	Result
Low	2412	10.5	>500	PASS
Mid	2437	10.5		PASS
High	2462	11.3334		PASS

Test mode: IEEE 802.11g mode

Channel	Frequency (MHz)	Bandwidth (MHz)	Limit (kHz)	Result
Low	2412	16.4167	>500	PASS
Mid	2437	16.5		PASS
High	2462	16.5		PASS

Test mode: IEEE 802.11n HT 20 mode / Chain 0

Channel	Frequency (MHz)	Bandwidth (MHz)	Limit (kHz)	Result
Low	2412	17.6667	>500	PASS
Mid	2437	17.6667		PASS
High	2462	17.6667		PASS

Test mode: IEEE 802.11n HT 20 mode / Chain 1

Channel	Frequency (MHz)	Bandwidth (MHz)	Limit (kHz)	Result
Low	2412	17.6667	>500	PASS
Mid	2437	17.6667		PASS
High	2462	17.6667		PASS

Test mode: IEEE 802.11n HT 40 mode / Chain 0

Channel	Frequency (MHz)	Bandwidth (MHz)	Limit (kHz)	Result
Low	2422	36.1667	>500	PASS
Mid	2437	36		PASS
High	2452	36		PASS

Test mode: IEEE 802.11n HT 40 mode / Chain 1

Channel	Frequency (MHz)	Bandwidth (MHz)	Limit (kHz)	Result
Low	2422	36.0833	>500	PASS
Mid	2437	35.9166		PASS
High	2452	36		PASS



Test Plot

IEEE 802.11b mode

6dB Bandwidth (CH Low)

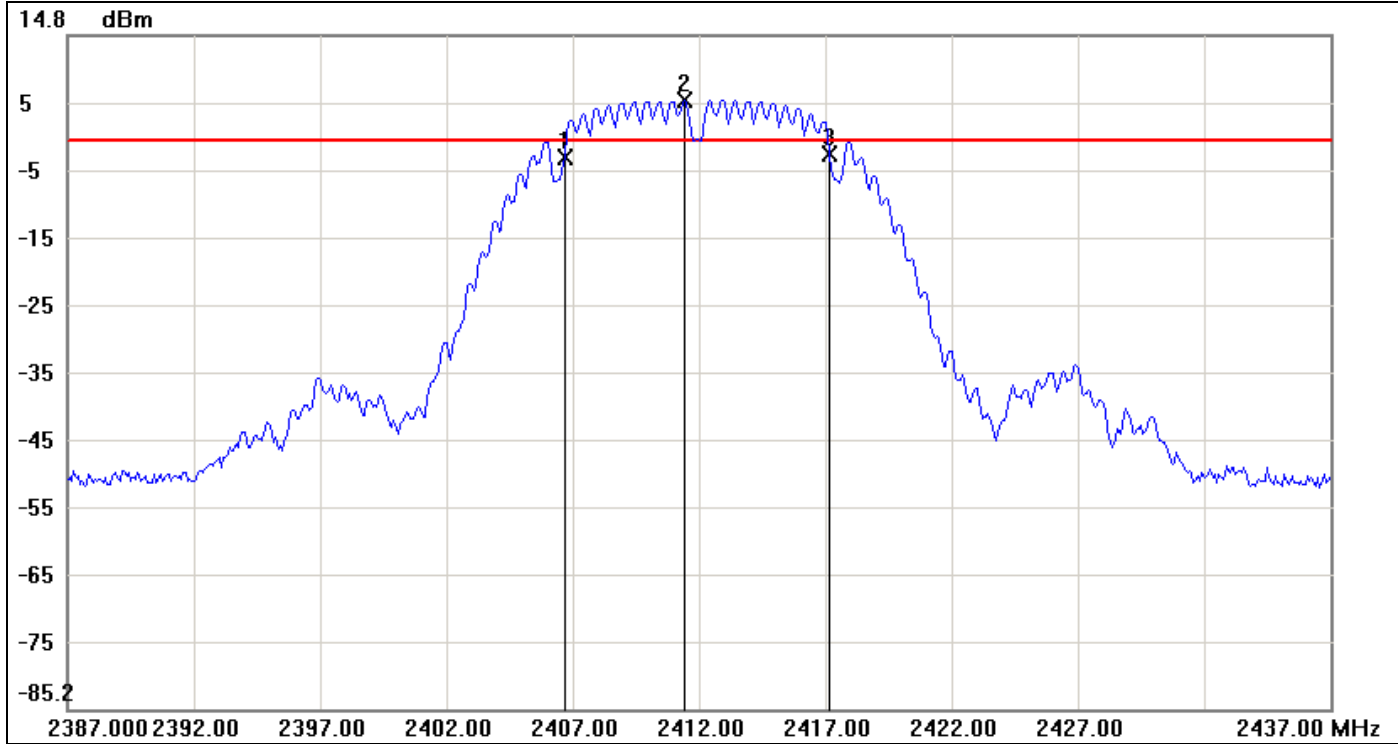

No.	Frequency(MHz)	Result(dBm)	Limit(dBm)	Margin(dBm)
1	2406.6667	-3.19	-0.88	-2.31
2	2412.4167	5.12	-0.88	6.00
3	2417.1667	-2.78	-0.88	-1.90

No.		Δ Frequency(MHz)	Δ Level(dB)
1	mk3-mk1	10.5	0.41



6dB Bandwidth (CH Mid)

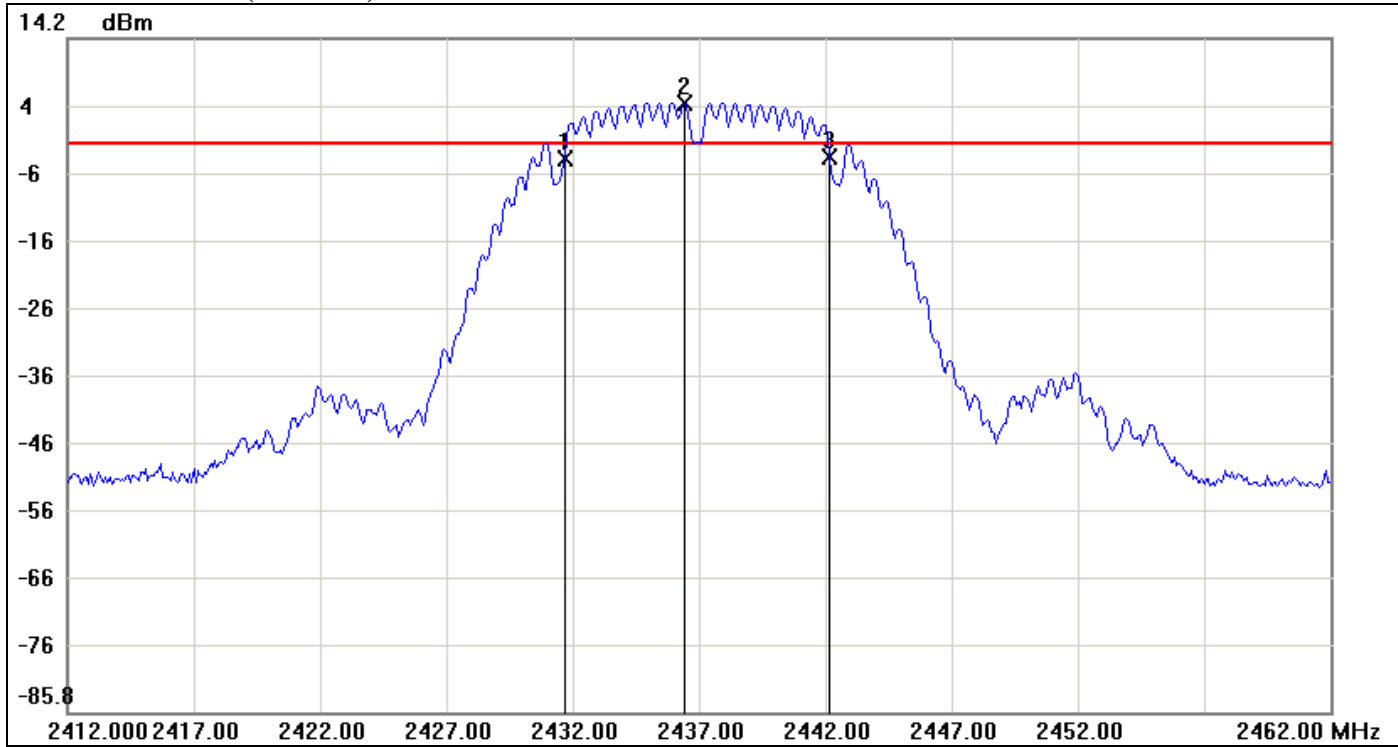

No.	Frequency(MHz)	Result(dBm)	Limit(dBm)	Margin(dBm)
1	2431.6667	-3.63	-1.42	-2.21
2	2436.4167	4.58	-1.42	6.00
3	2442.1667	-3.39	-1.42	-1.97

No.		Δ Frequency(MHz)	Δ Level(dB)
1	mk3-mk1	10.5	0.24



6dB Bandwidth (CH High)

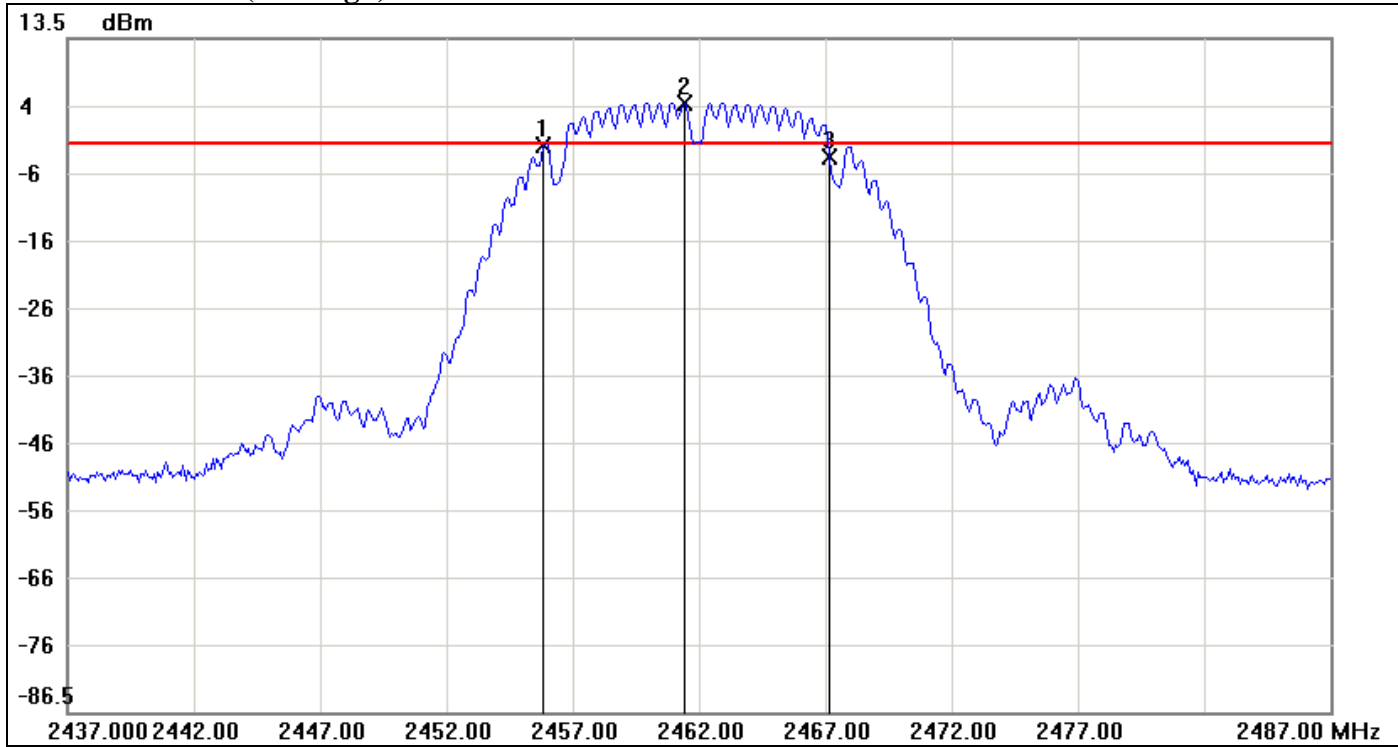

No.	Frequency(MHz)	Result(dBm)	Limit(dBm)	Margin(dBm)
1	2455.8333	-2.43	-2.12	-0.31
2	2461.4167	3.88	-2.12	6.00
3	2467.1667	-4.20	-2.12	-2.08

No.		Δ Frequency(MHz)	Δ Level(dB)
1	mk3-mk1	11.3334	-1.77



IEEE 802.11g mode

6dB Bandwidth (CH Low)

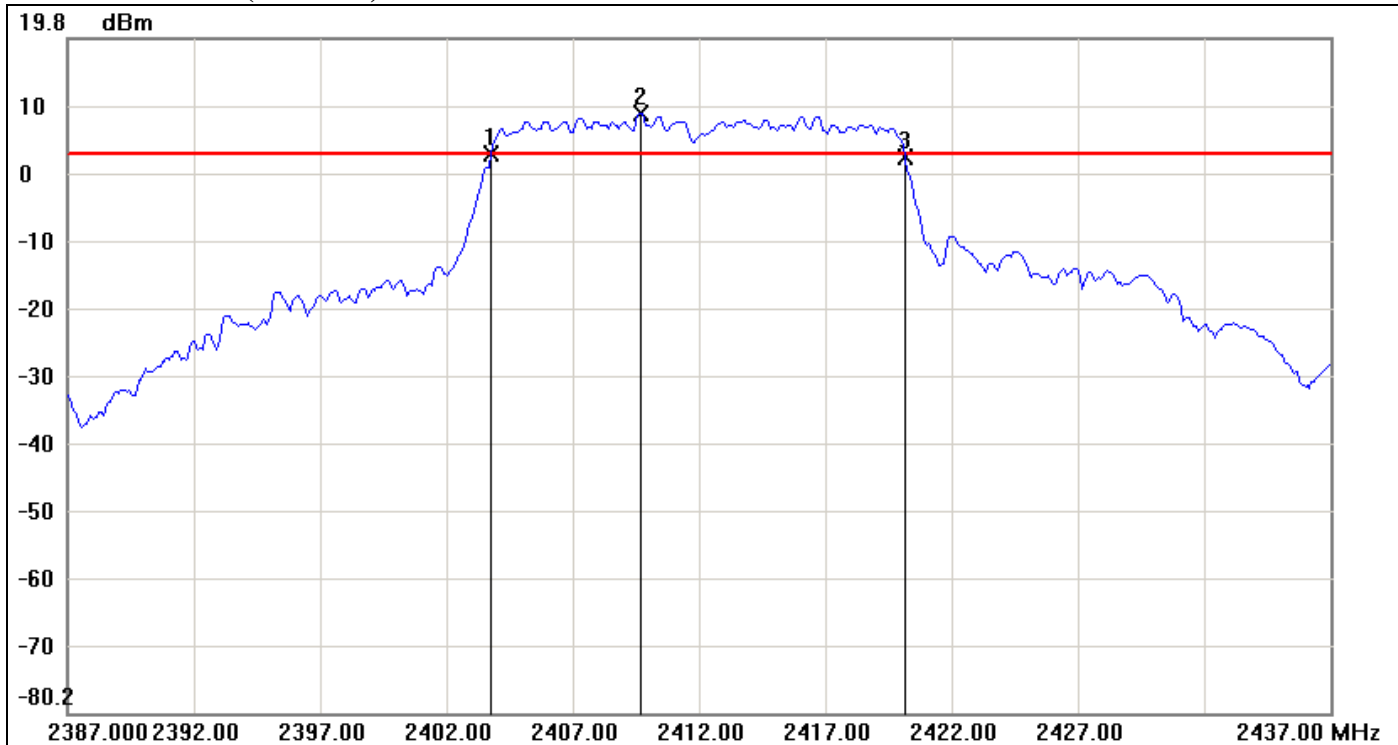

No.	Frequency(MHz)	Result(dBm)	Limit(dBm)	Margin(dBm)
1	2403.7500	2.64	2.70	-0.06
2	2409.6667	8.70	2.70	6.00
3	2420.1667	2.23	2.70	-0.47

No.		Δ Frequency(MHz)	Δ Level(dB)
1	mk3-mk1	16.4167	-0.41



6dB Bandwidth (CH Mid)

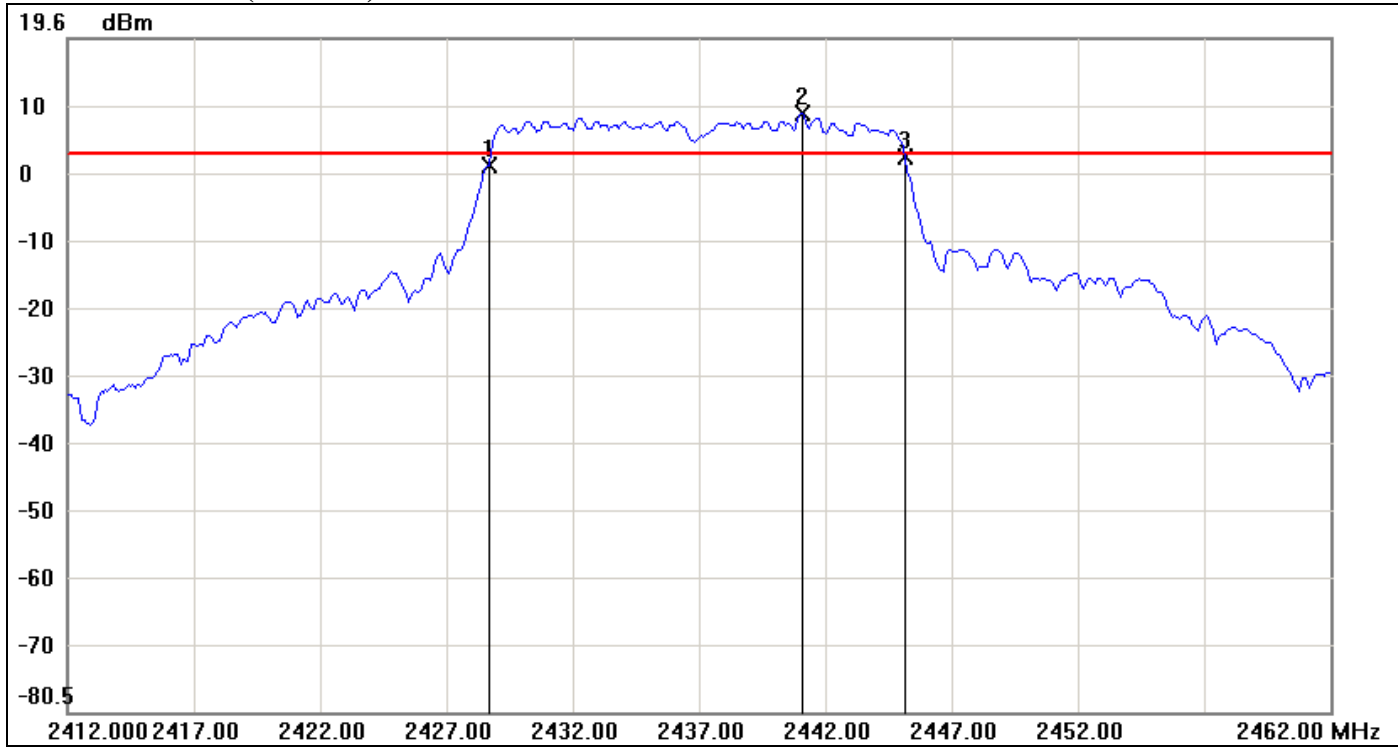

No.	Frequency(MHz)	Result(dBm)	Limit(dBm)	Margin(dBm)
1	2428.6667	0.77	2.37	-1.60
2	2441.0833	8.37	2.37	6.00
3	2445.1667	1.90	2.37	-0.47

No.		Δ Frequency(MHz)	Δ Level(dB)
1	mk3-mk1	16.5	1.13



6dB Bandwidth (CH High)

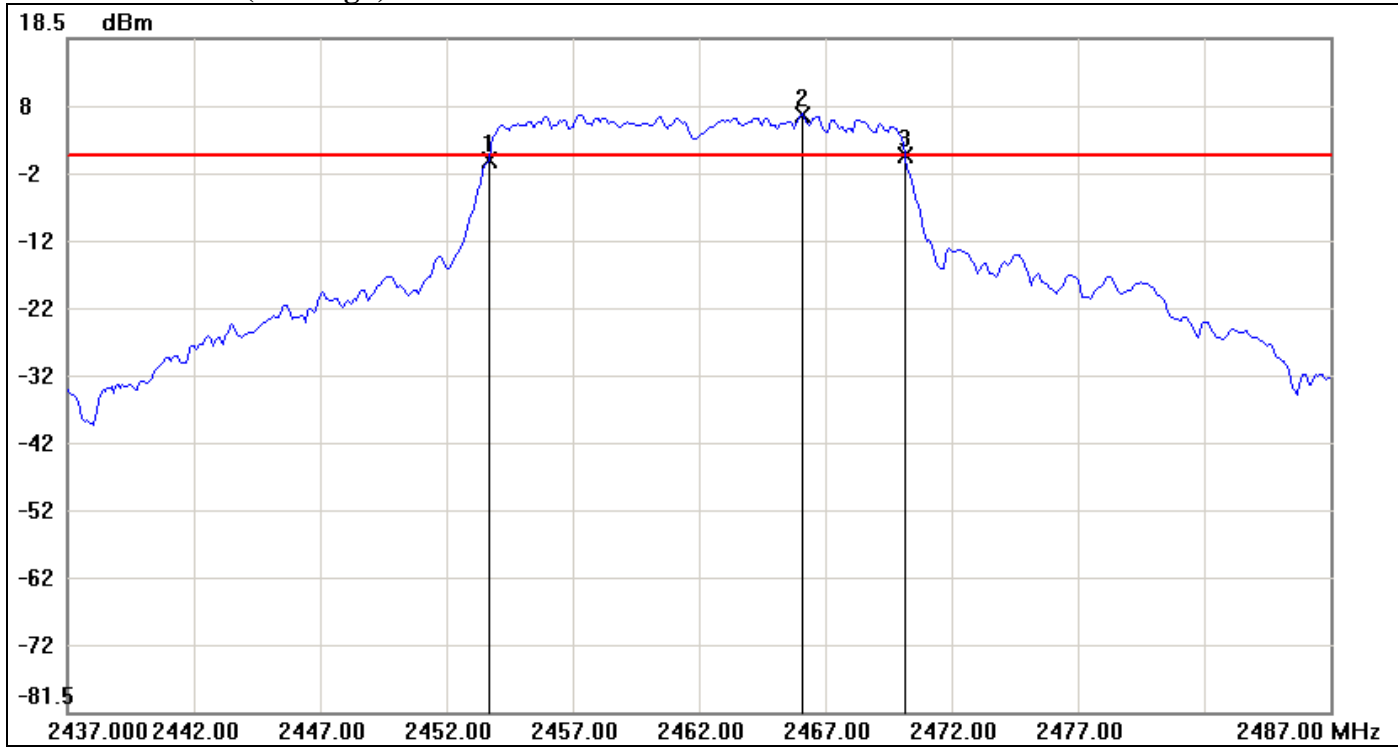

No.	Frequency(MHz)	Result(dBm)	Limit(dBm)	Margin(dBm)
1	2453.6667	0.31	1.21	-0.90
2	2466.0833	7.21	1.21	6.00
3	2470.1667	1.10	1.21	-0.11

No.		Δ Frequency(MHz)	Δ Level(dB)
1	mk3-mk1	16.5	0.79



IEEE 802.11n HT 20 mode / Chain 0

6dB Bandwidth (CH Low)

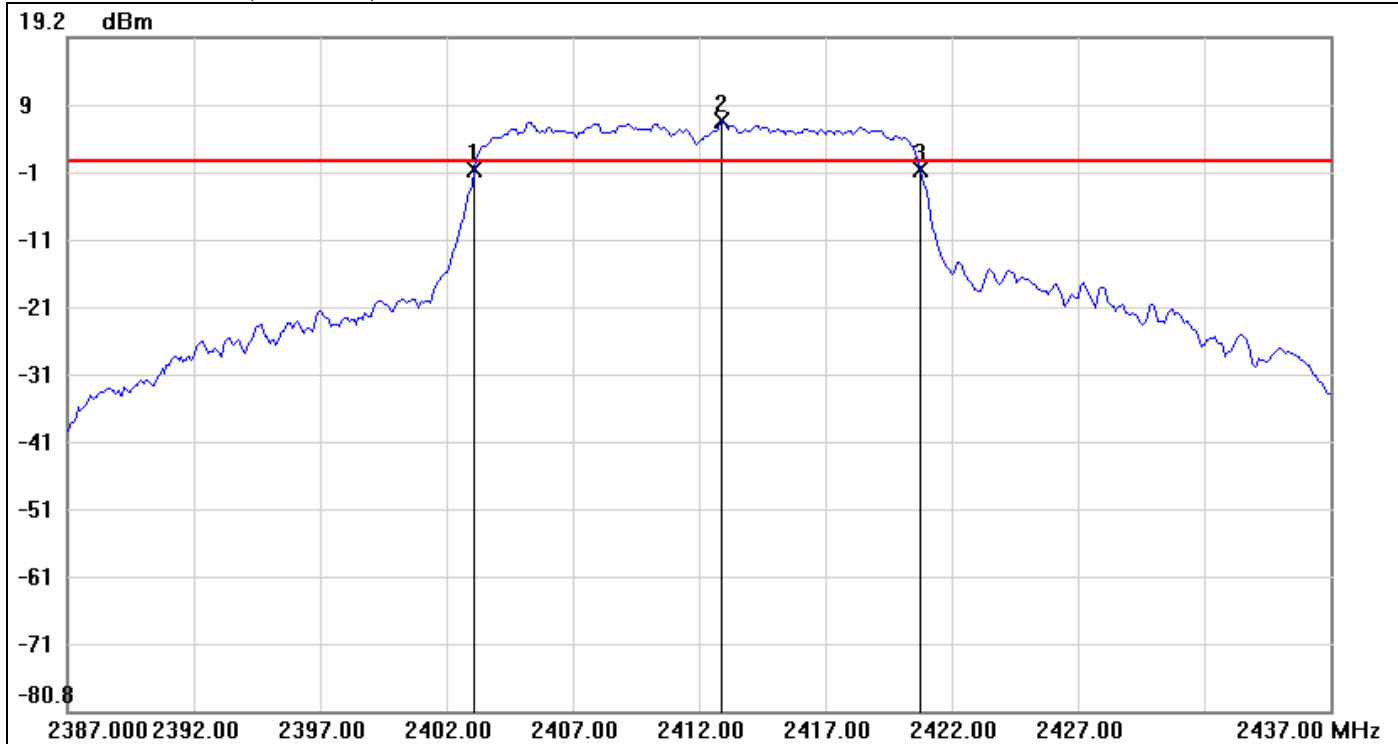

No.	Frequency(MHz)	Result(dBm)	Limit(dBm)	Margin(dBm)
1	2403.0833	-0.53	0.68	-1.21
2	2412.9167	6.68	0.68	6.00
3	2420.7500	-0.44	0.68	-1.12

No.		ΔFrequency(MHz)	ΔLevel(dB)
1	mk3-mk1	17.6667	0.09



6dB Bandwidth (CH Mid)

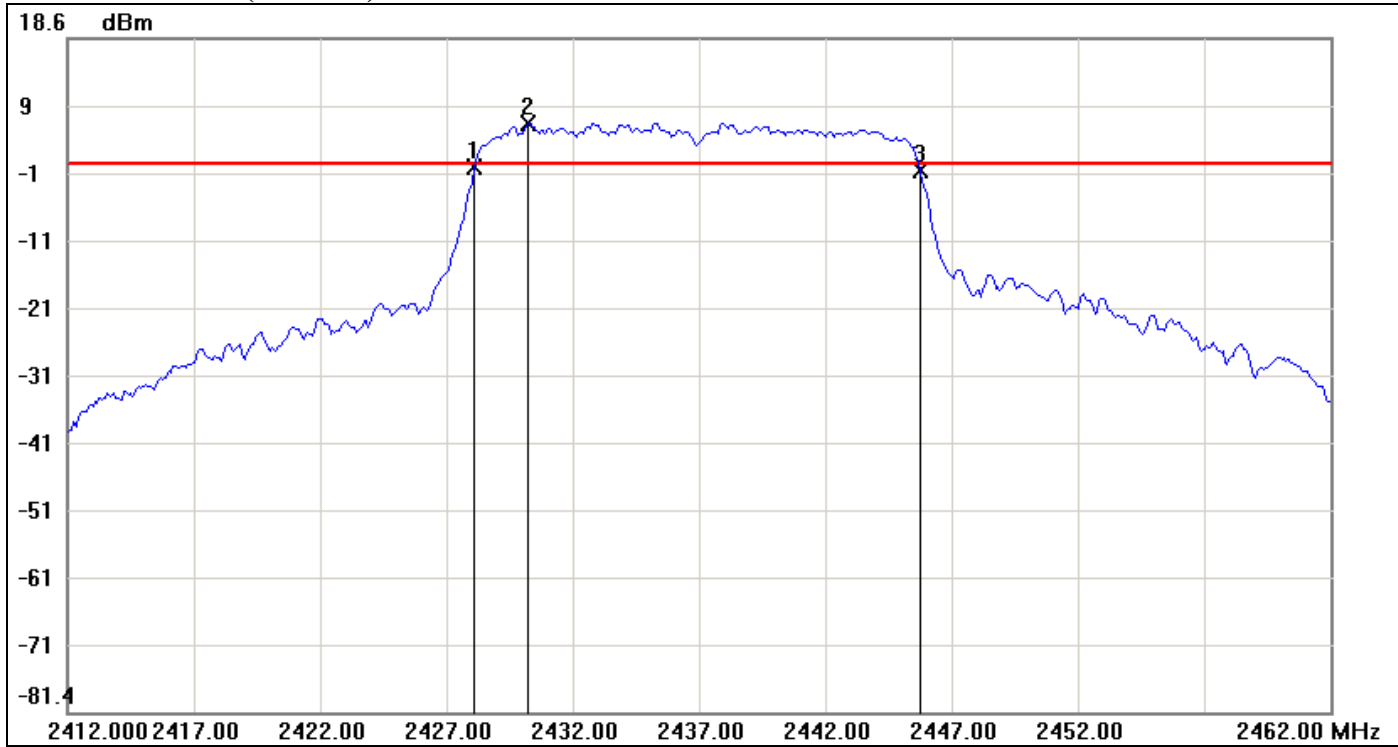

No.	Frequency(MHz)	Result(dBm)	Limit(dBm)	Margin(dBm)
1	2428.0833	-0.43	0.05	-0.48
2	2430.2500	6.05	0.05	6.00
3	2445.7500	-1.02	0.05	-1.07

No.		Δ Frequency(MHz)	Δ Level(dB)
1	mk3-mk1	17.6667	-0.59



6dB Bandwidth (CH High)

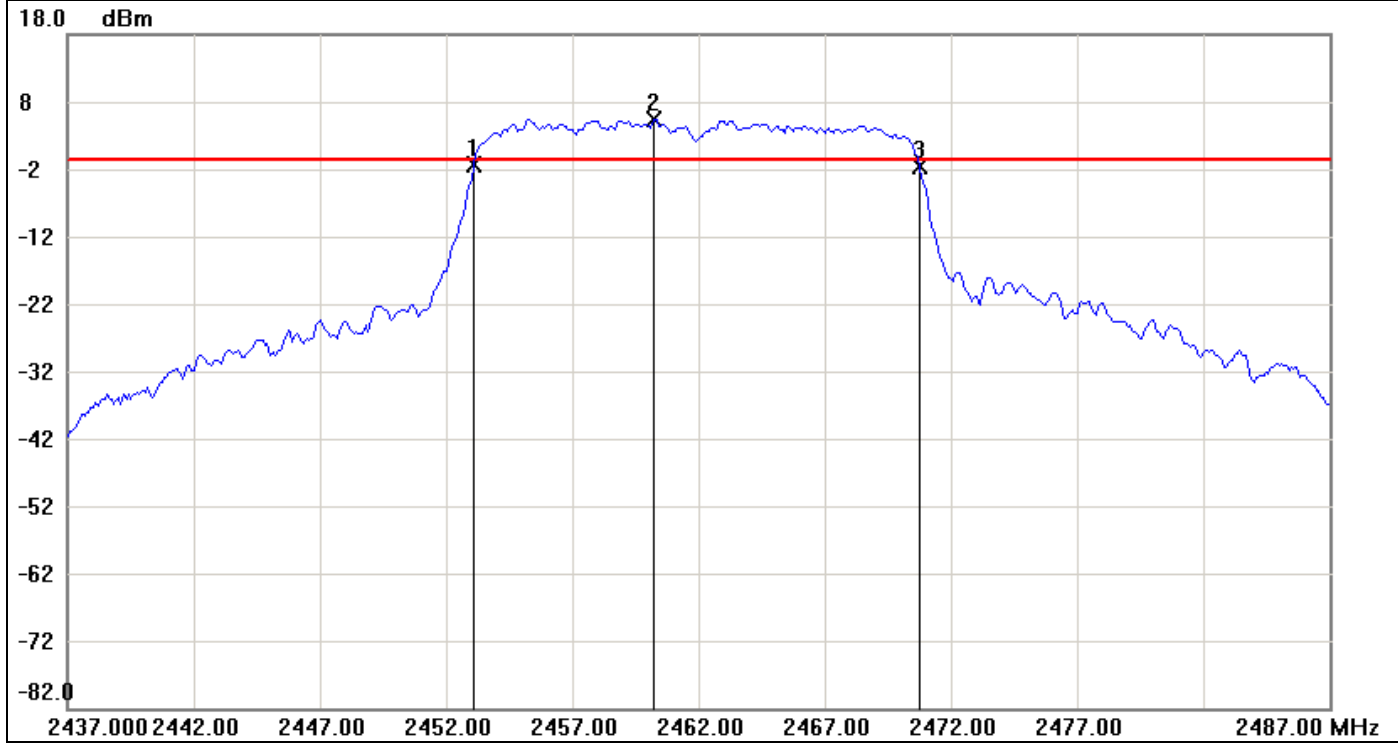

No.	Frequency(MHz)	Result(dBm)	Limit(dBm)	Margin(dBm)
1	2453.0833	-1.40	-0.50	-0.90
2	2460.2500	5.50	-0.50	6.00
3	2470.7500	-1.62	-0.50	-1.12

No.		Δ Frequency(MHz)	Δ Level(dB)
1	mk3-mk1	17.6667	-0.22



IEEE 802.11n HT 20 mode / Chain 1

6dB Bandwidth (CH Low)

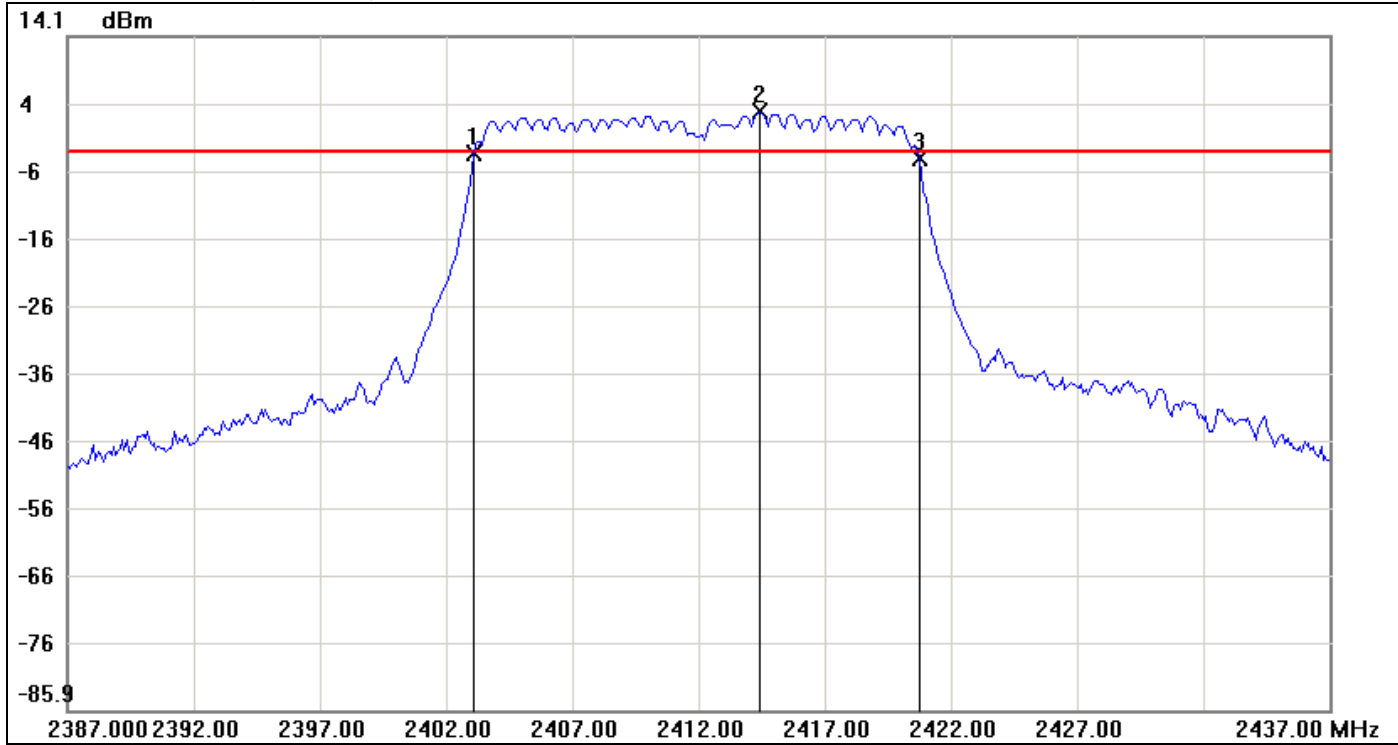

No.	Frequency(MHz)	Result(dBm)	Limit(dBm)	Margin(dBm)
1	2403.0833	-3.34	-3.12	-0.22
2	2414.4167	2.88	-3.12	6.00
3	2420.7500	-3.95	-3.12	-0.83

No.		Δ Frequency(MHz)	Δ Level(dB)
1	mk3-mk1	17.6667	-0.61



6dB Bandwidth (CH Mid)

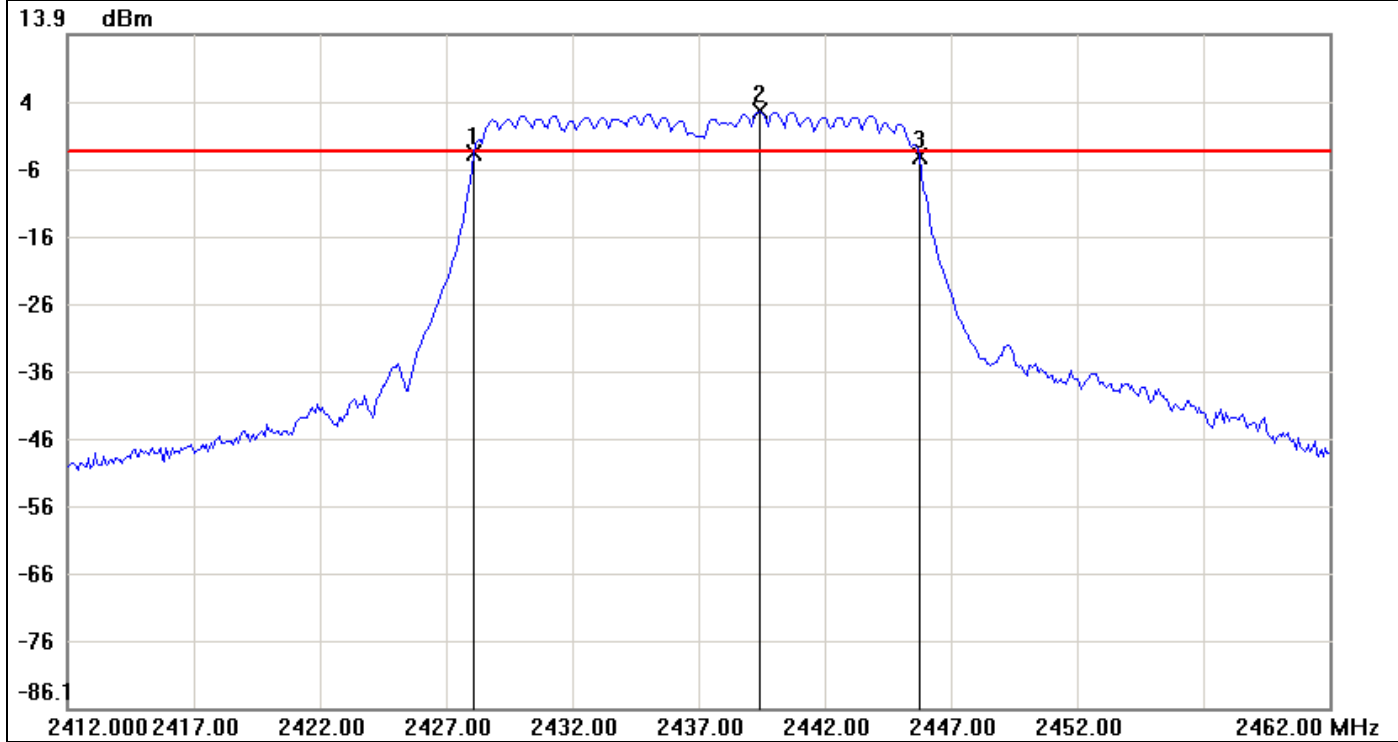

No.	Frequency(MHz)	Result(dBm)	Limit(dBm)	Margin(dBm)
1	2428.0833	-3.82	-3.59	-0.23
2	2439.4167	2.41	-3.59	6.00
3	2445.7500	-4.29	-3.59	-0.70

No.		Δ Frequency(MHz)	Δ Level(dB)
1	mk3-mk1	17.6667	-0.47



6dB Bandwidth (CH High)

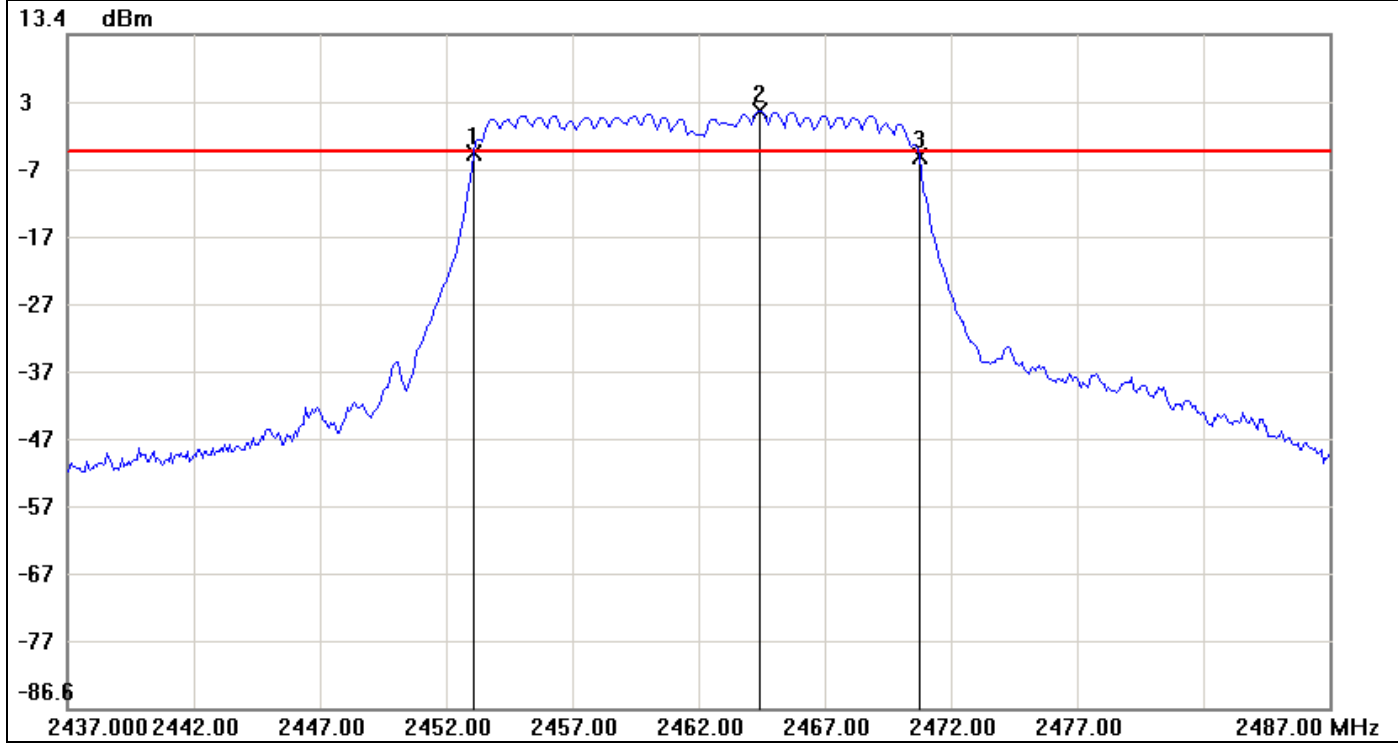

No.	Frequency(MHz)	Result(dBm)	Limit(dBm)	Margin(dBm)
1	2453.0833	-4.21	-3.98	-0.23
2	2464.4167	2.02	-3.98	6.00
3	2470.7500	-4.79	-3.98	-0.81

No.		Δ Frequency(MHz)	Δ Level(dB)
1	mk3-mk1	17.6667	-0.58



IEEE 802.11n HT 40 mode / Chain 0

6dB Bandwidth (CH Low)

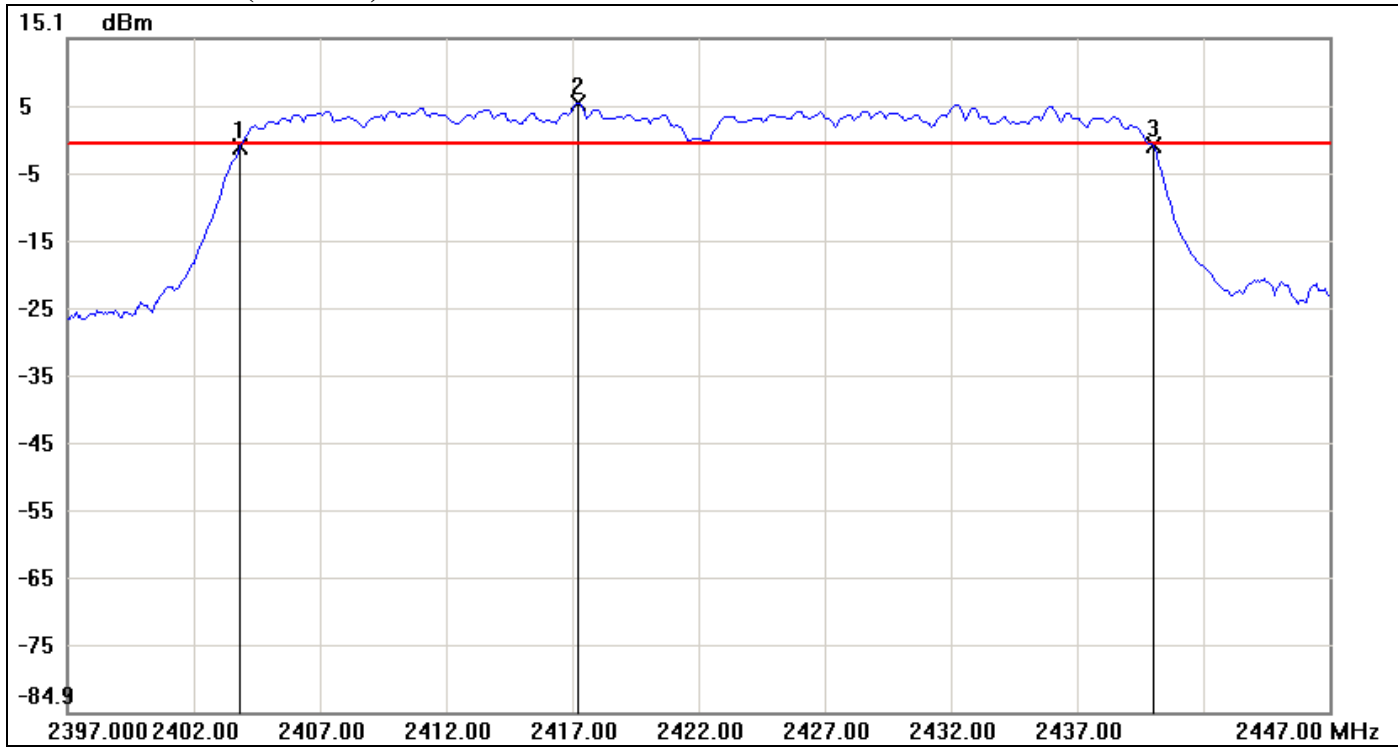

No.	Frequency(MHz)	Result(dBm)	Limit(dBm)	Margin(dBm)
1	2403.8333	-1.15	-0.64	-0.51
2	2417.2500	5.36	-0.64	6.00
3	2440.0000	-0.82	-0.64	-0.18

No.		Δ Frequency(MHz)	Δ Level(dB)
1	mk3-mk1	36.1667	0.33



6dB Bandwidth (CH Mid)

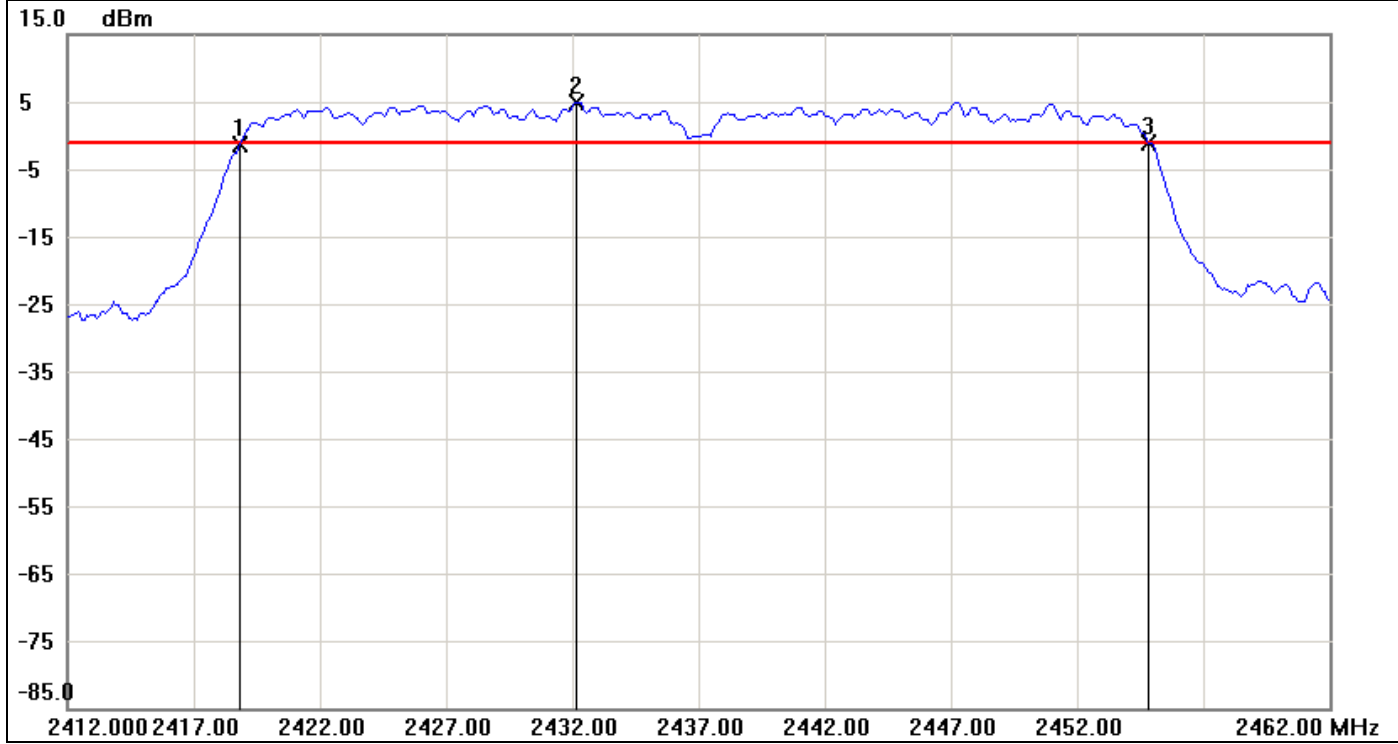

No.	Frequency(MHz)	Result(dBm)	Limit(dBm)	Margin(dBm)
1	2418.8333	-1.52	-1.08	-0.44
2	2432.1667	4.92	-1.08	6.00
3	2454.8333	-1.17	-1.08	-0.09

No.		Δ Frequency(MHz)	Δ Level(dB)
1	mk3-mk1	36	0.35



6dB Bandwidth (CH High)

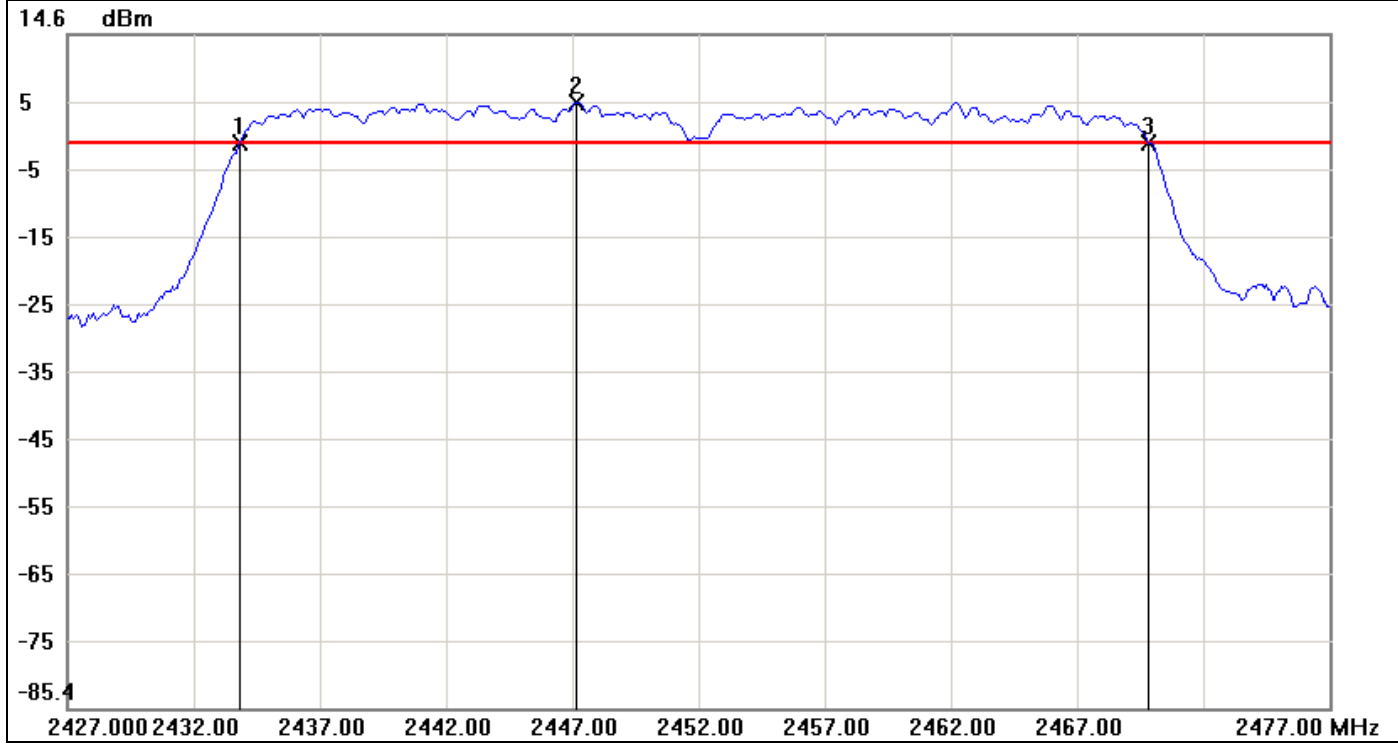

No.	Frequency(MHz)	Result(dBm)	Limit(dBm)	Margin(dBm)
1	2433.8333	-1.58	-1.42	-0.16
2	2447.1667	4.58	-1.42	6.00
3	2469.8333	-1.43	-1.42	-0.01

No.		Δ Frequency(MHz)	Δ Level(dB)
1	mk3-mk1	36	0.15



IEEE 802.11n HT 40 mode / Chain 1

6dB Bandwidth (CH Low)

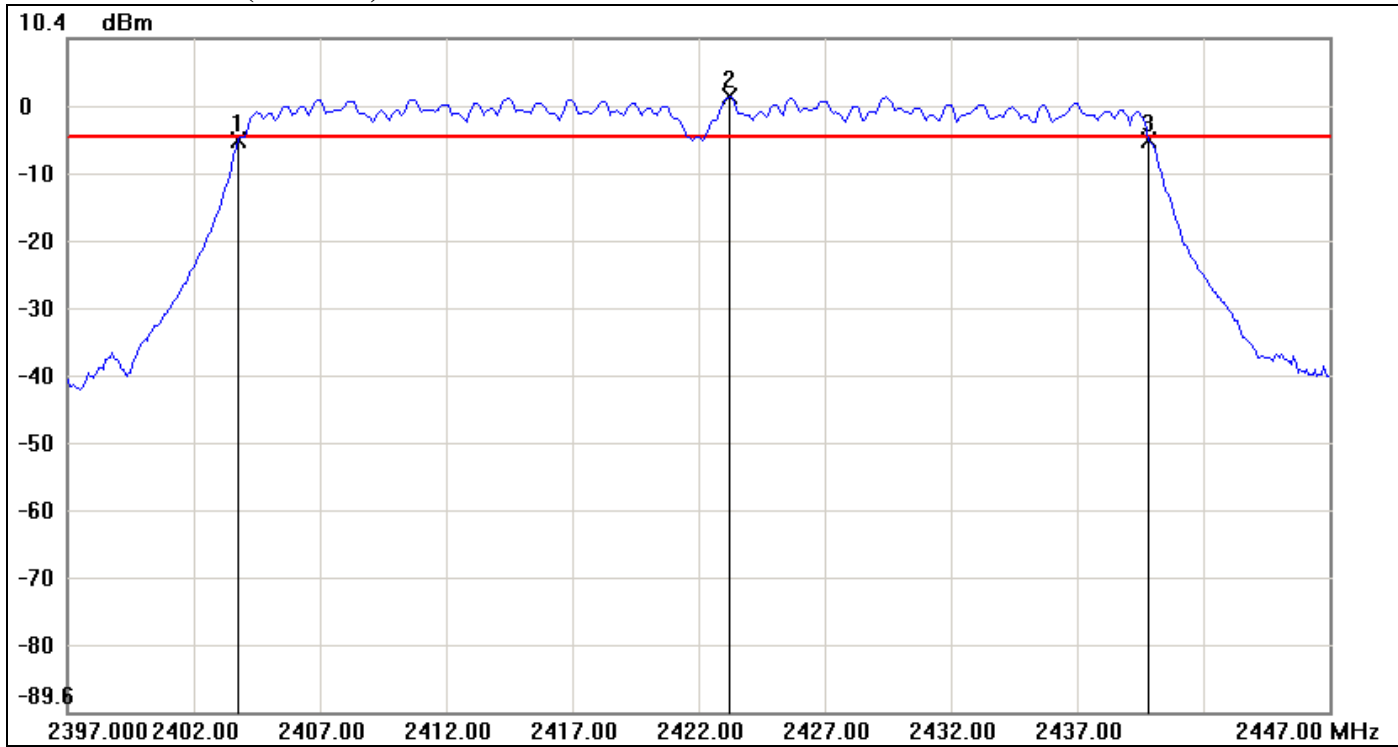

No.	Frequency(MHz)	Result(dBm)	Limit(dBm)	Margin(dBm)
1	2403.7500	-4.74	-4.33	-0.41
2	2423.2500	1.67	-4.33	6.00
3	2439.8333	-4.75	-4.33	-0.42

No.		Δ Frequency(MHz)	Δ Level(dB)
1	mk3-mk1	36.0833	-0.01



6dB Bandwidth (CH Mid)

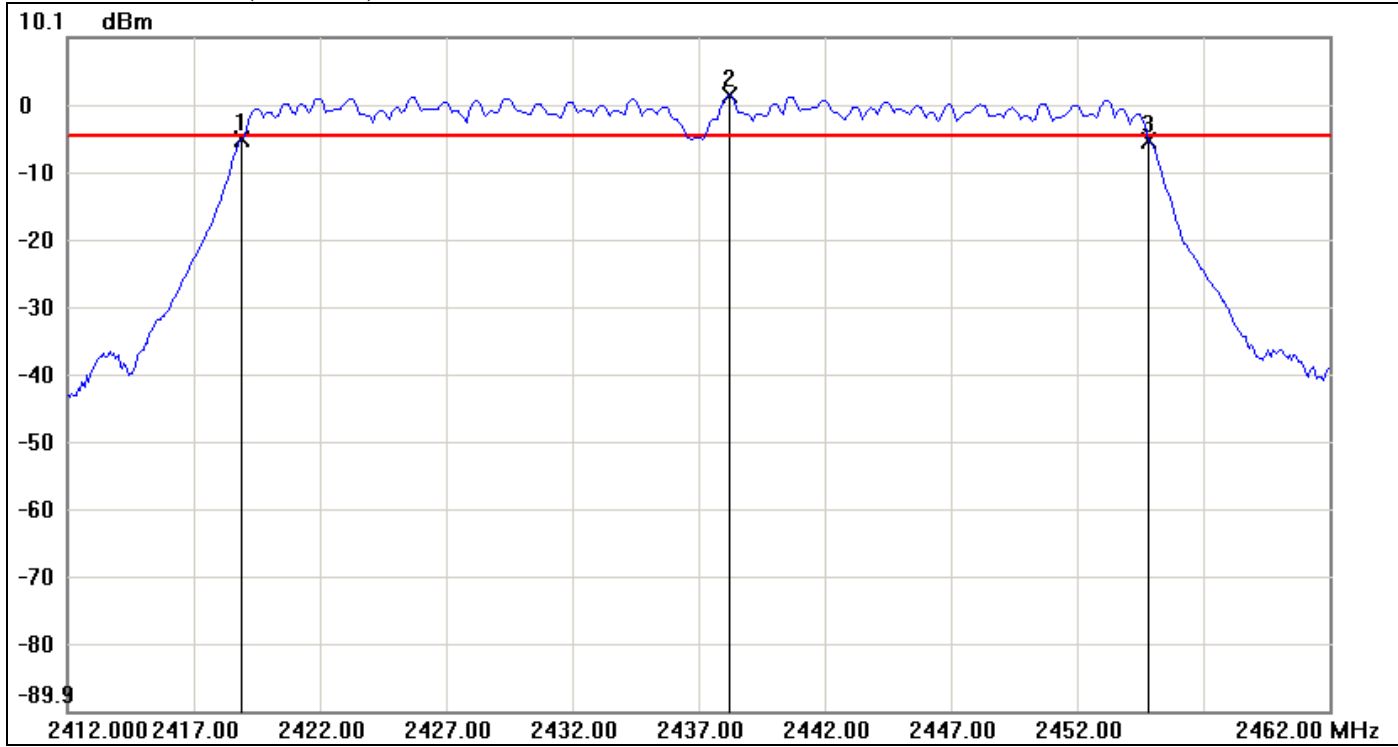

No.	Frequency(MHz)	Result(dBm)	Limit(dBm)	Margin(dBm)
1	2418.9167	-5.02	-4.55	-0.47
2	2438.2500	1.45	-4.55	6.00
3	2454.8333	-5.17	-4.55	-0.62

No.		Δ Frequency(MHz)	Δ Level(dB)
1	mk3-mk1	35.9166	-0.15



6dB Bandwidth (CH High)

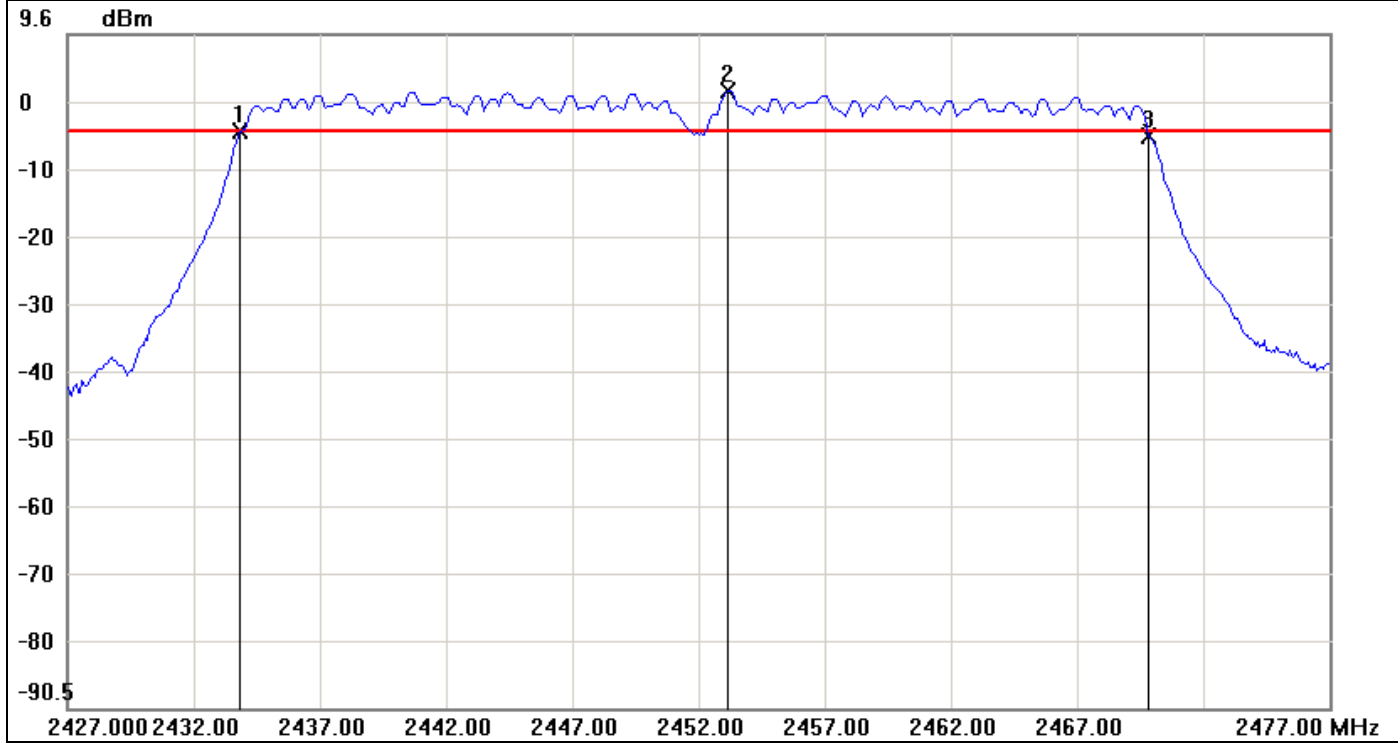

No.	Frequency(MHz)	Result(dBm)	Limit(dBm)	Margin(dBm)
1	2433.8333	-4.87	-4.87	0.00
2	2453.1667	1.13	-4.87	6.00
3	2469.8333	-5.49	-4.87	-0.62

No.		Δ Frequency(MHz)	Δ Level(dB)
1	mk3-mk1	36	-0.62



7.2 PEAK POWER

LIMIT

The maximum peak output power of the intentional radiator shall not exceed the following:

1. According to §15.247(b)(3), for systems using digital modulation in the bands of 902-928 MHz, 2400-2483.5 MHz, and 5725-5850 MHz: 1 Watt.
2. According to §15.247(b)(4), the conducted output power limit specified in paragraph (b) of this section is based on the use of antennas with directional gains that do not exceed 6 dBi. Except as shown in paragraph (c) of this section, if transmitting antennas of directional gain greater than 6 dBi are used, the conducted output power from the intentional radiator shall be reduced below the stated values in paragraphs (b)(1), (b)(2), and (b)(3) of this section, as appropriate, by the amount in dB that the directional gain of the antenna exceeds 6 dBi.

Test Configuration

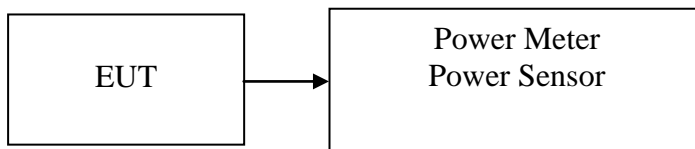

TEST PROCEDURE

The transmitter output is connected to the Power Meter. The Power Meter is set to the peak power detection.



Test Data

Test mode: IEEE 802.11b mode

Channel	Frequency (MHz)	Output Power (dBm)	Output Power (W)	Limit (W)	Result
Low	2412	17.61	0.0577	1.00	PASS
Mid	2437	17.06	0.0508		PASS
High	2462	16.35	0.0432		PASS

Test mode: IEEE 802.11g mode

Channel	Frequency (MHz)	Output Power (dBm)	Output Power (W)	Limit (W)	Result
Low	2412	24.86	0.3062	1.00	PASS
Mid	2437	24.49	0.2812		PASS
High	2462	23.99	0.2506		PASS

Test mode: IEEE 802.11n HT 20 mode

Channel	Frequency (MHz)	Chain 0 Output Power (dBm)	Chain 1 Output Power (dBm)	Total Output Power (dBm)	Output Power (W)	Limit (W)	Result
Low	2412	23.90	19.67	25.29	0.3381	1.00	PASS
Mid	2437	23.35	19.38	24.81	0.3027		PASS
High	2462	22.79	18.93	24.29	0.2685		PASS

Test mode: IEEE 802.11n HT 40 mode

Channel	Frequency (MHz)	Chain 0 Output Power (dBm)	Chain 1 Output Power (dBm)	Total Output Power (dBm)	Output Power (W)	Limit (W)	Result
Low	2422	22.54	18.40	23.96	0.2489	1.00	PASS
Mid	2437	22.27	18.09	23.67	0.2328		PASS
High	2452	21.93	17.85	23.36	0.2168		PASS

Remark: Total Output Power (w) = Chain 0 (10^(Output Power /10)/1000)+ Chain 1 (10^(Output Power /10)/1000)



7.3 BAND EDGES MEASUREMENT

LIMIT

According to §15.247(d), in any 100 kHz bandwidth outside the frequency bands in which the spread spectrum intentional radiator is operating, the radio frequency power that is produced by the intentional radiator shall be at least 20 dB below that in the 100 kHz bandwidth within the band that contains the highest level of the desired power, based on either an RF conducted or a radiated measurement, provided the transmitter demonstrates compliance with the peak conducted power limits. In addition, radiated emissions which fall in the restricted bands, as defined in §15.205(a), must also comply with the radiated emission limits specified in 15.209(a) (see Section 15.205(c)).

Test Configuration

For Radiated

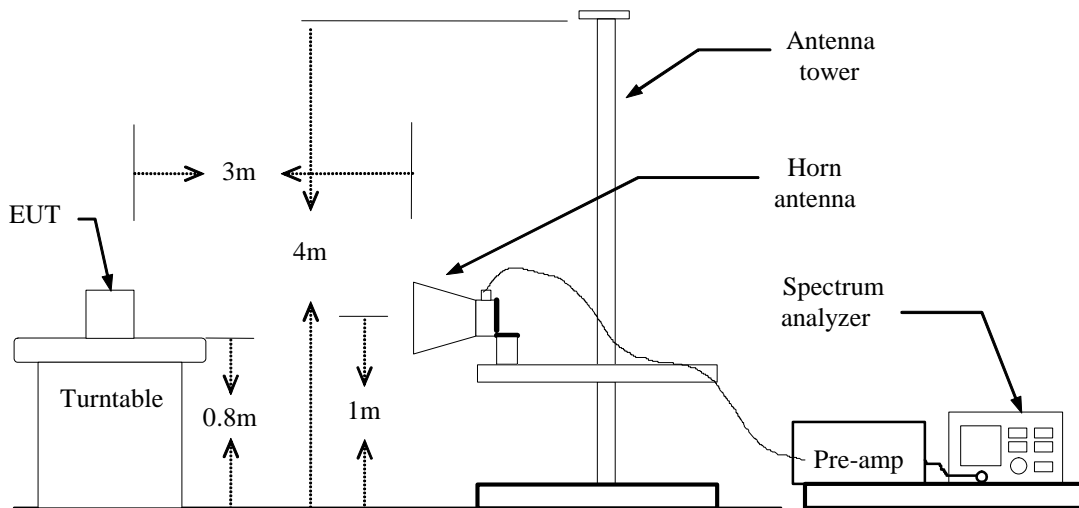

For Conducted

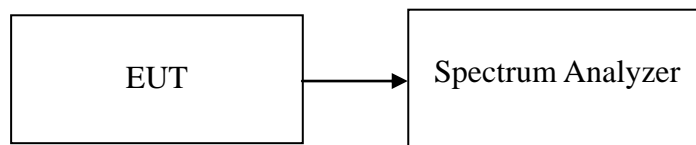



TEST PROCEDURE

For Radiated

1. The EUT is placed on a turntable, which is 0.8m above the ground plane.
2. The turntable shall be rotated for 360 degrees to determine the position of maximum emission level.
3. EUT is set 3m away from the receiving antenna, which is varied from 1m to 4m to find out the highest emission.
4. Set the spectrum analyzer in the following setting in order to capture the lower and upper band-edges of the emission:
 - (a) PEAK: RBW=1MHz / VBW=3MHz / Sweep=AUTO
 - (b) AVERAGE: RBW=1MHz / VBW= 300Hz / Sweep=AUTO
5. Repeat the procedures until all the PEAK and AVERAGE versus POLARIZATION are measured.

For Conducted

Conducted RF measurements of the transmitter output were made to confirm that the EUT antenna port conducted emissions meet the specified limit and to identify any spurious signals that require further investigation or measurements on the radiated emissions site.

The transmitter output is connected to the spectrum analyzer. The resolution bandwidth is set to 100 kHz. The video bandwidth is set to 100 kHz.

TEST RESULTS

Refer to attach spectrum analyzer data chart.



Band Edges (IEEE 802.11b mode / CH Low)

Detector mode: Peak

Polarity: Vertical

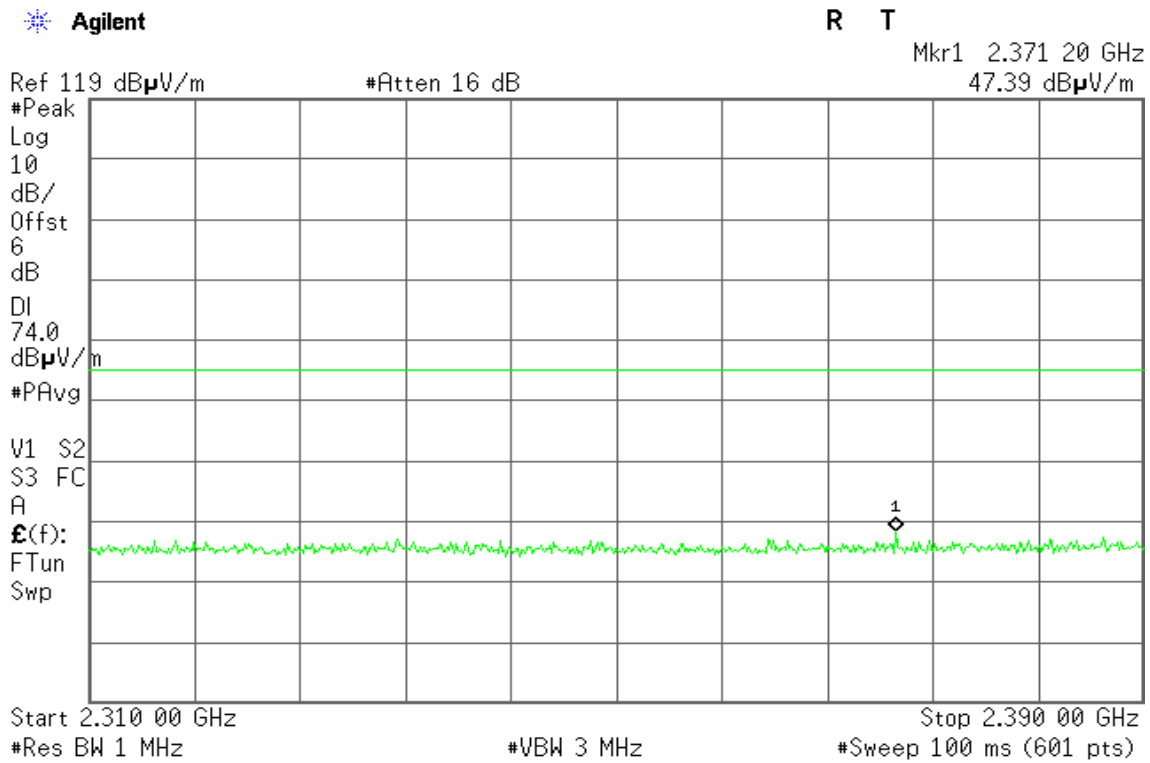

Detector mode: Average

Polarity: Vertical

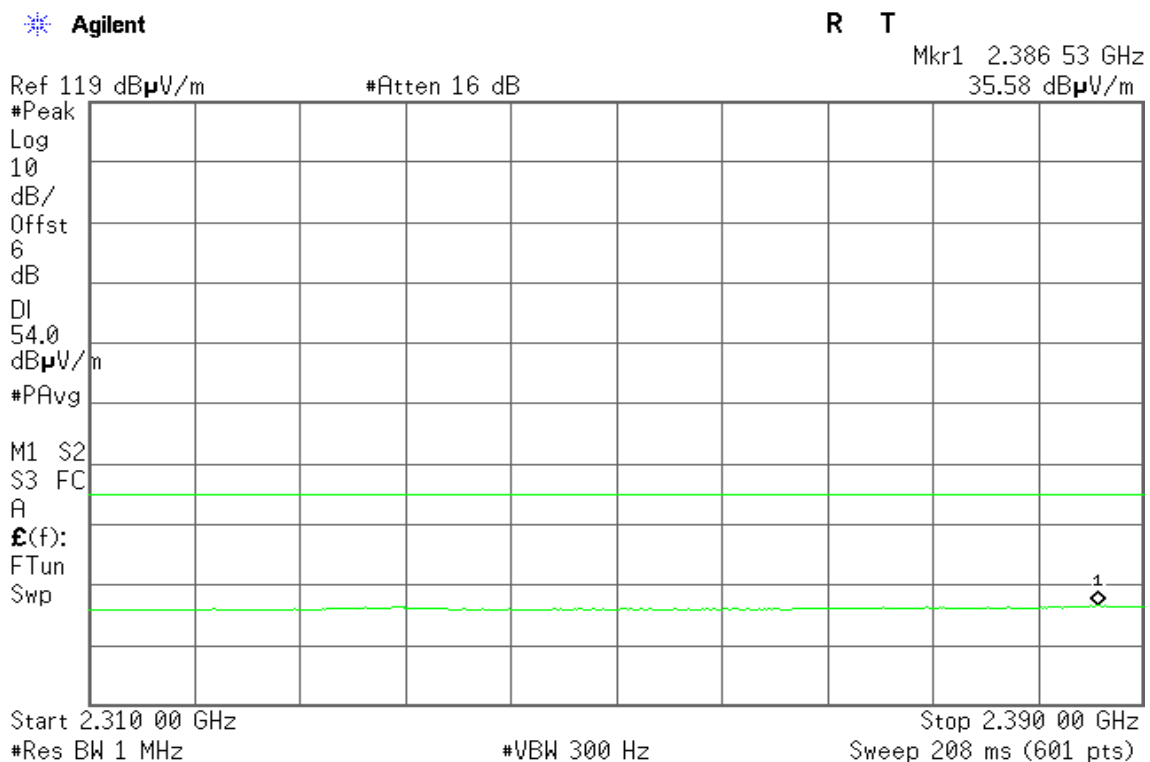



Detector mode: Peak

Polarity: Horizontal

Agilent

R T

Mkr1 2.384 93 GHz
46.87 dB μ V/m

Ref 119 dB μ V/m

#Atten 16 dB

#Peak

Log

10

dB/

Offst

6

dB

DI

74.0

dB μ V/m

#PAvg

V1 S2

S3 FC

A

$\mathcal{E}(f)$:

FTun

Swp

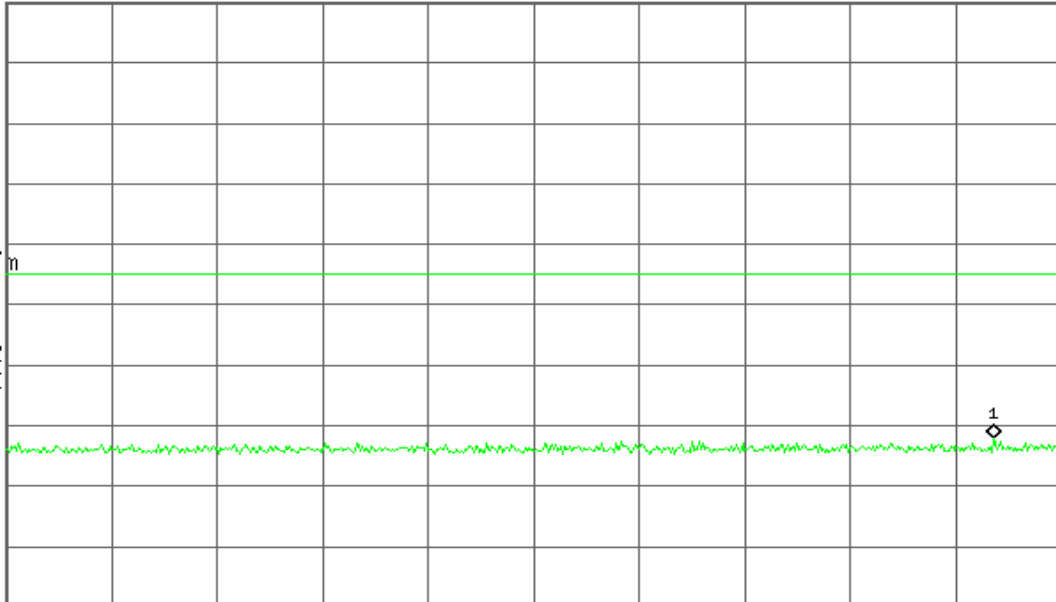

Start 2.310 00 GHz

Stop 2.390 00 GHz

#Res BW 1 MHz

#VBW 3 MHz

#Sweep 100 ms (601 pts)

Detector mode: Average

Polarity: Horizontal

Agilent

R T

Mkr1 2.388 40 GHz
35.22 dB μ V/m

Ref 119 dB μ V/m

#Atten 16 dB

#Peak

Log

10

dB/

Offst

6

dB

DI

54.0

dB μ V/m

#PAvg

W1 S2

S3 FC

A

$\mathcal{E}(f)$:

FTun

Swp

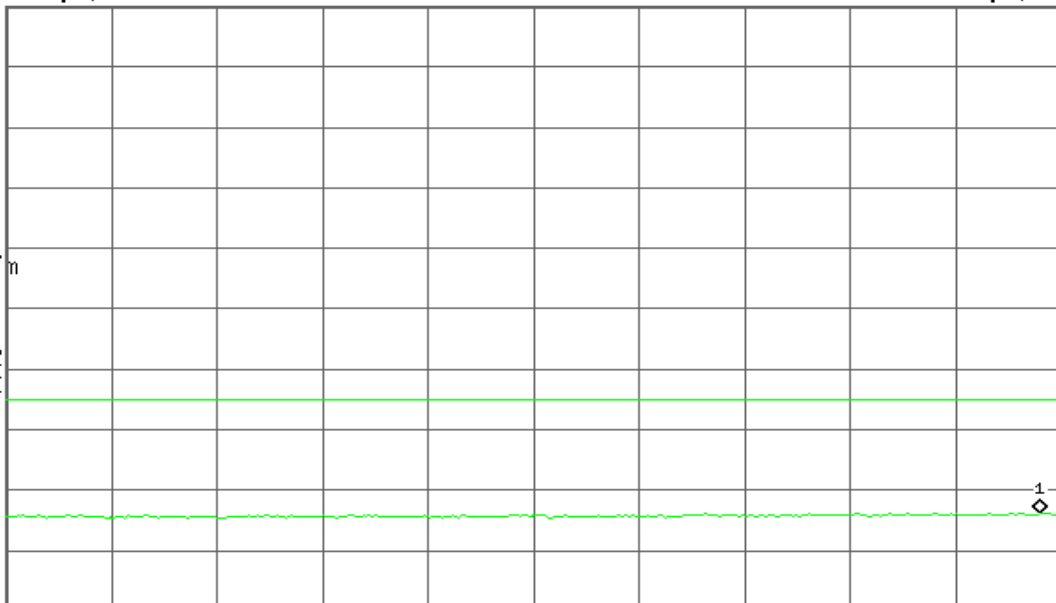

Start 2.310 00 GHz

Stop 2.390 00 GHz

#Res BW 1 MHz

#VBW 300 Hz

Sweep 208 ms (601 pts)



Band Edges (IEEE 802.11b mode / CH High)

Detector mode: Peak

Polarity: Vertical

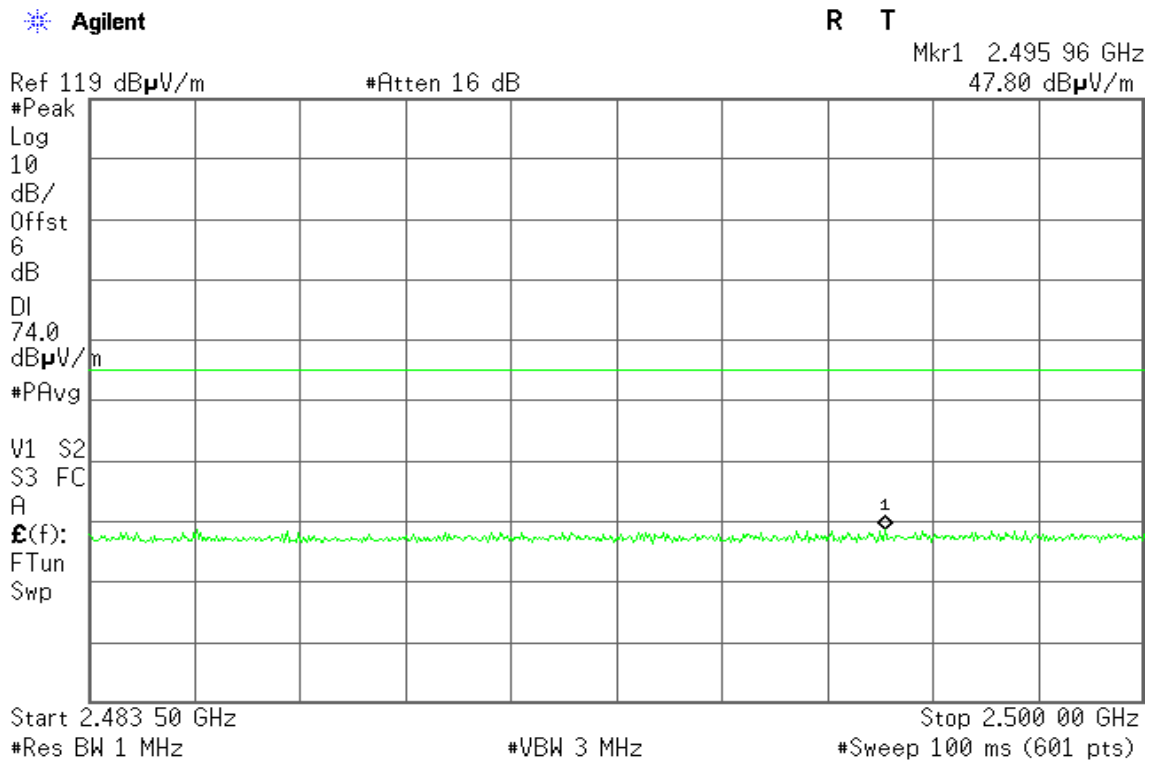

Detector mode: Average

Polarity: Vertical

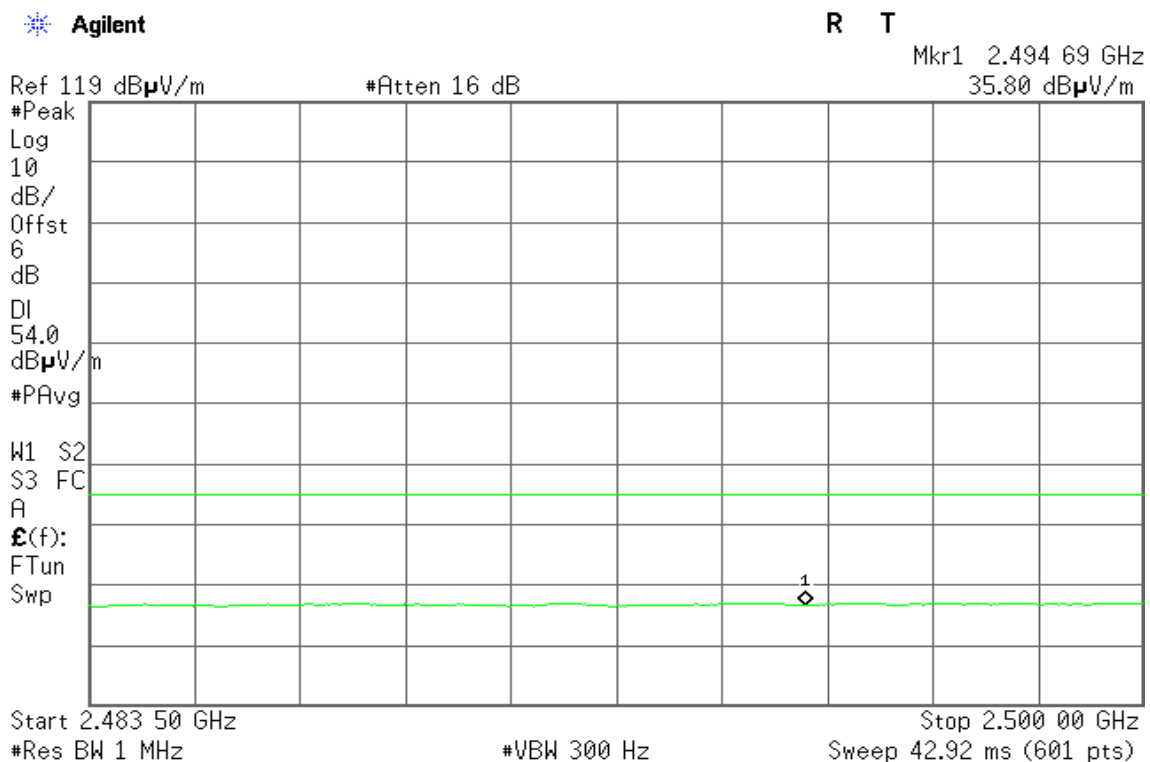



Detector mode: Peak

Polarity: Horizontal

Agilent

R T

Mkr1 2.483 91 GHz
48.38 dB μ V/m

Ref 119 dB μ V/m

#Atten 16 dB

#Peak

Log

10

dB/

Offst

6

dB

DI

74.0

dB μ V/m

#PAvg

V1 S2

S3 FC

A

$\mathcal{E}(f)$:

FTun

Swp

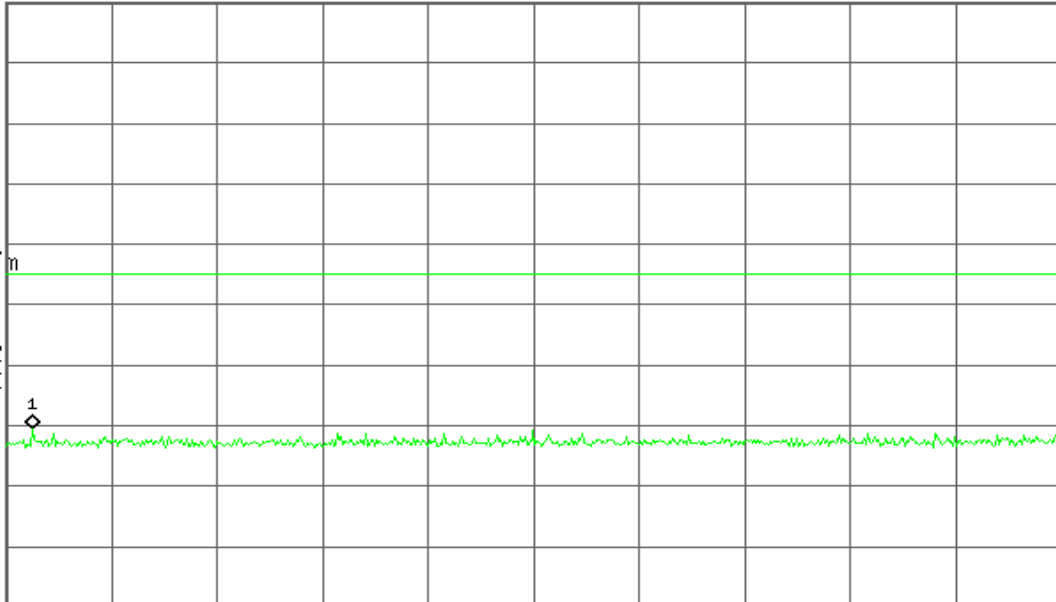

Start 2.483 50 GHz

Stop 2.500 00 GHz

#Res BW 1 MHz

#VBW 3 MHz

#Sweep 100 ms (601 pts)

Detector mode: Average

Polarity: Horizontal

Agilent

R T

Mkr1 2.499 92 GHz
36.51 dB μ V/m

Ref 119 dB μ V/m

#Atten 16 dB

#Peak

Log

10

dB/

Offst

6

dB

DI

54.0

dB μ V/m

#PAvg

M1 S2

S3 FC

A

$\mathcal{E}(f)$:

FTun

Swp



Start 2.483 50 GHz

Stop 2.500 00 GHz

#Res BW 1 MHz

#VBW 300 Hz

Sweep 42.92 ms (601 pts)



Band Edges (IEEE 802.11g mode / CH Low)

Detector mode: Peak

Polarity: Vertical

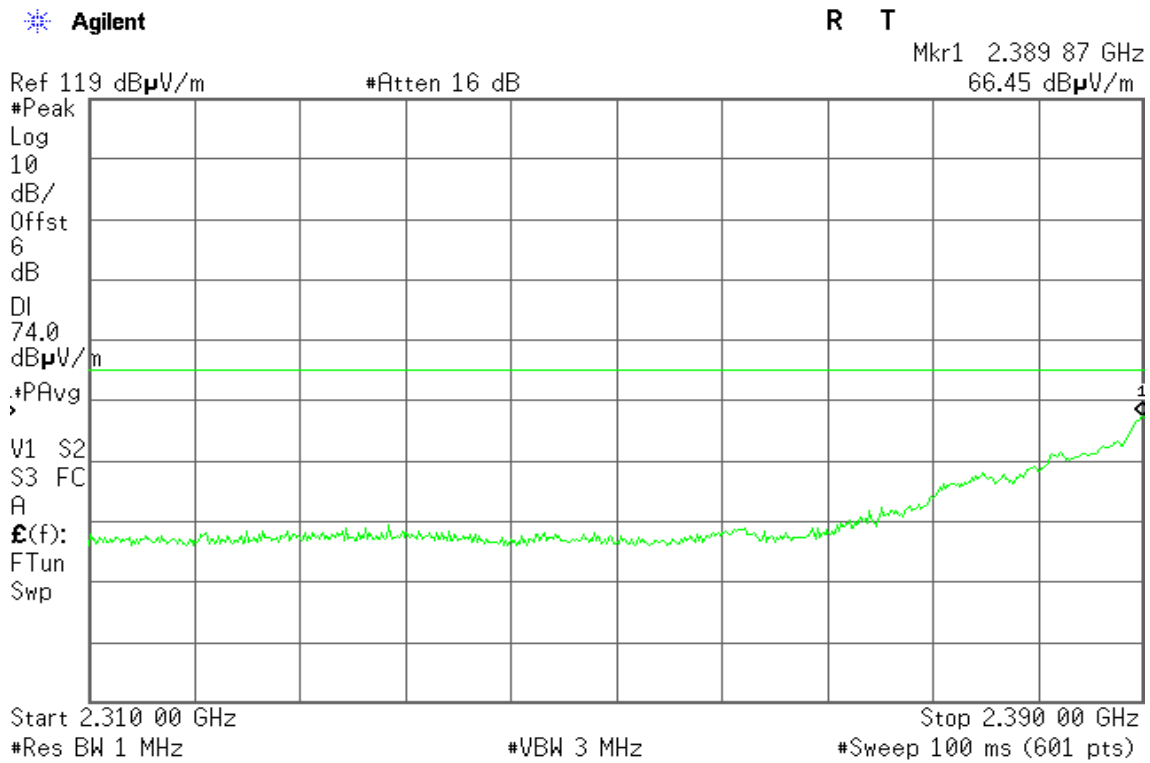

Detector mode: Average

Polarity: Vertical

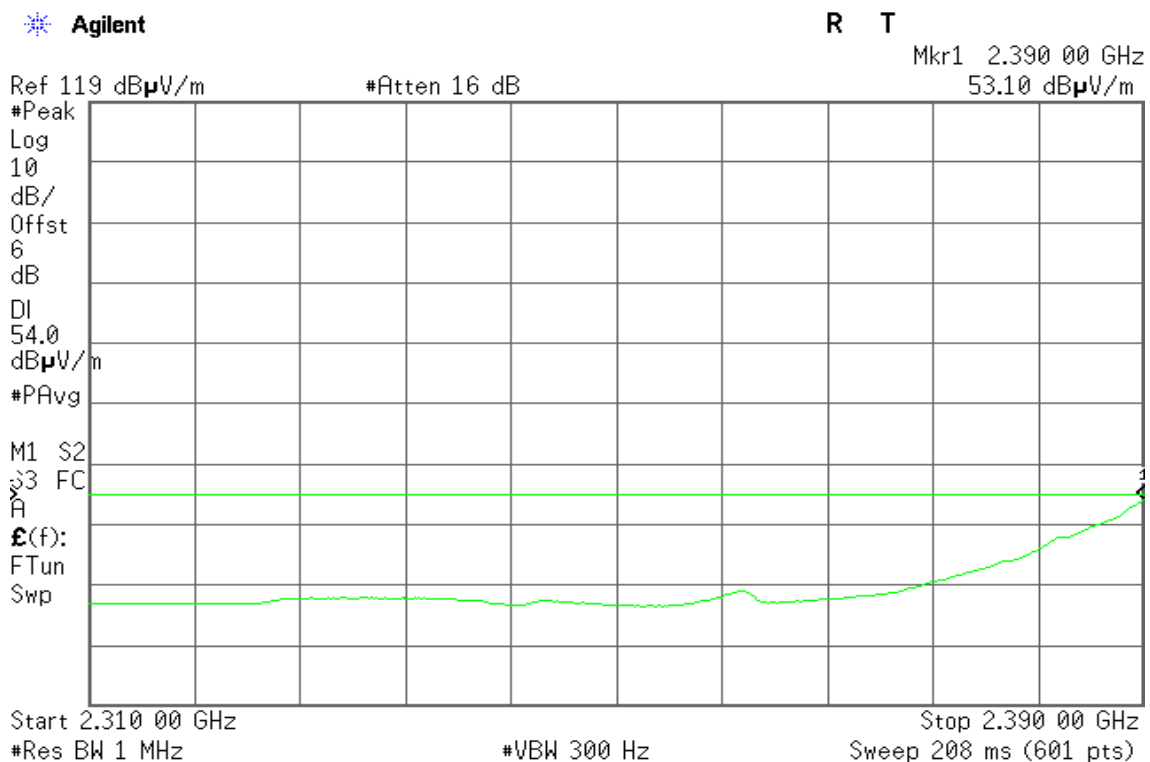



Detector mode: Peak

Polarity: Horizontal

Agilent

R T

Mkr1 2.389 87 GHz
57.81 dB μ V/m

Ref 119 dB μ V/m

#Atten 16 dB

#Peak

Log

10

dB/

Offst

6

dB

DI

74.0

dB μ V/m

#PAvg

J1 S2

S3 FC

A

$\mathcal{E}(f)$:

FTun

Swp

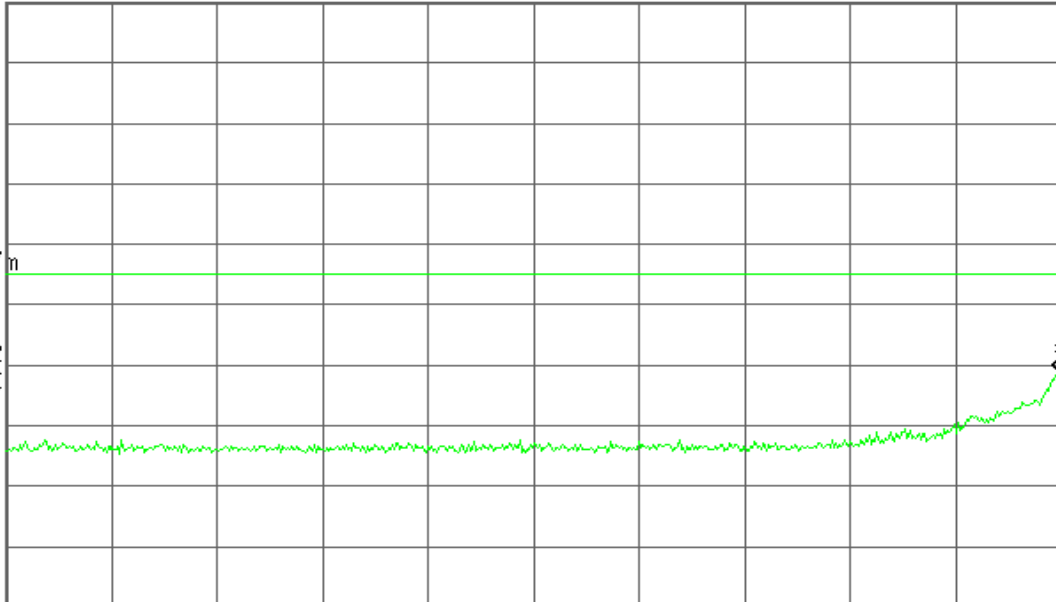

Start 2.310 00 GHz

Stop 2.390 00 GHz

#Res BW 1 MHz

#VBW 3 MHz

#Sweep 100 ms (601 pts)

Detector mode: Average

Polarity: Horizontal

Agilent

R T

Mkr1 2.390 00 GHz
43.78 dB μ V/m

Ref 119 dB μ V/m

#Atten 16 dB

#Peak

Log

10

dB/

Offst

6

dB

DI

54.0

dB μ V/m

#PAvg

M1 S2

S3 FC

A

$\mathcal{E}(f)$:

FTun

Swp

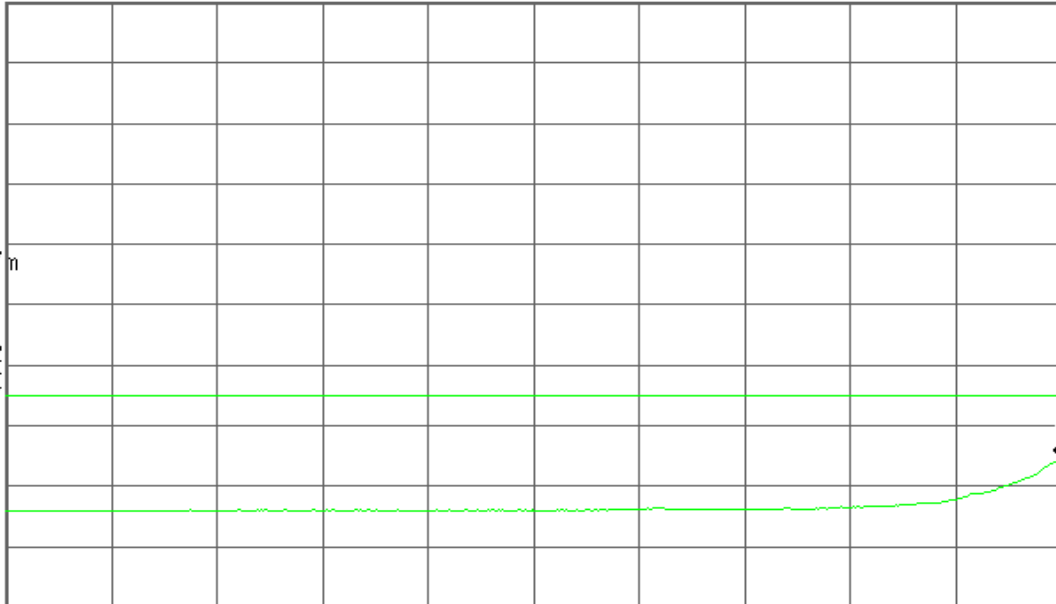

Start 2.310 00 GHz

Stop 2.390 00 GHz

#Res BW 1 MHz

#VBW 300 Hz

Sweep 208 ms (601 pts)



Band Edges (IEEE 802.11g mode / CH High)

Detector mode: Peak

Polarity: Vertical

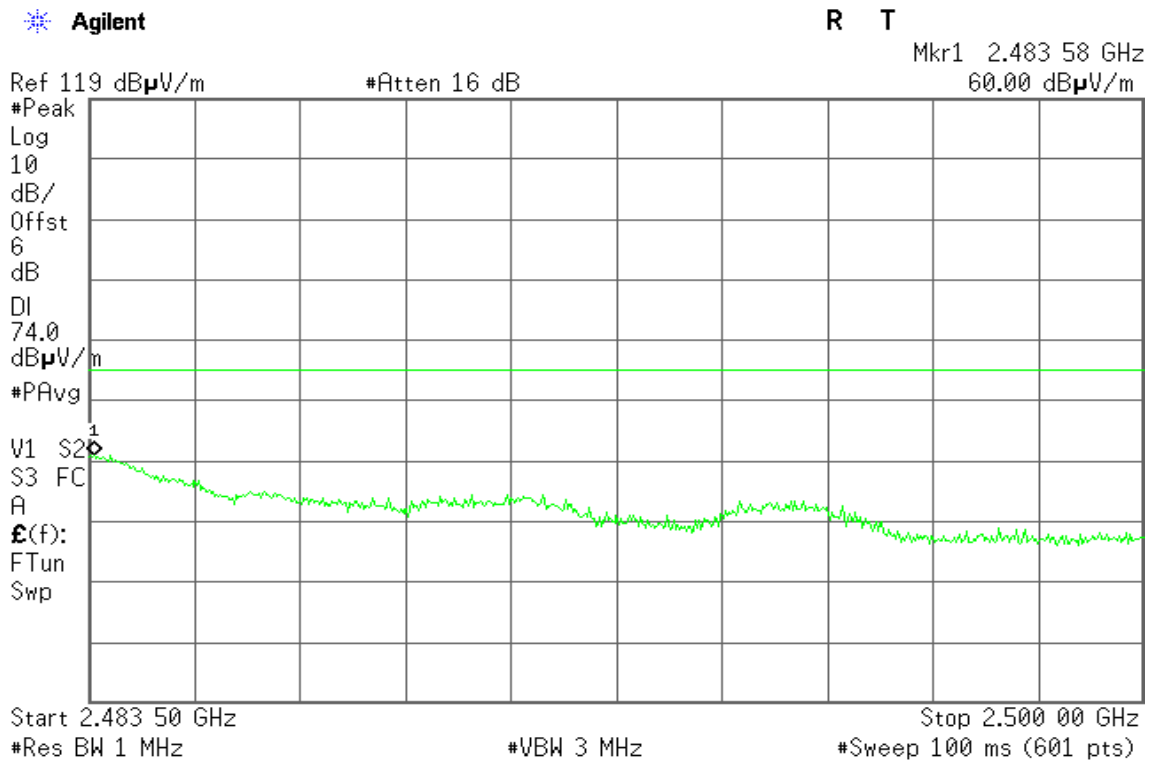

Detector mode: Average

Polarity: Vertical

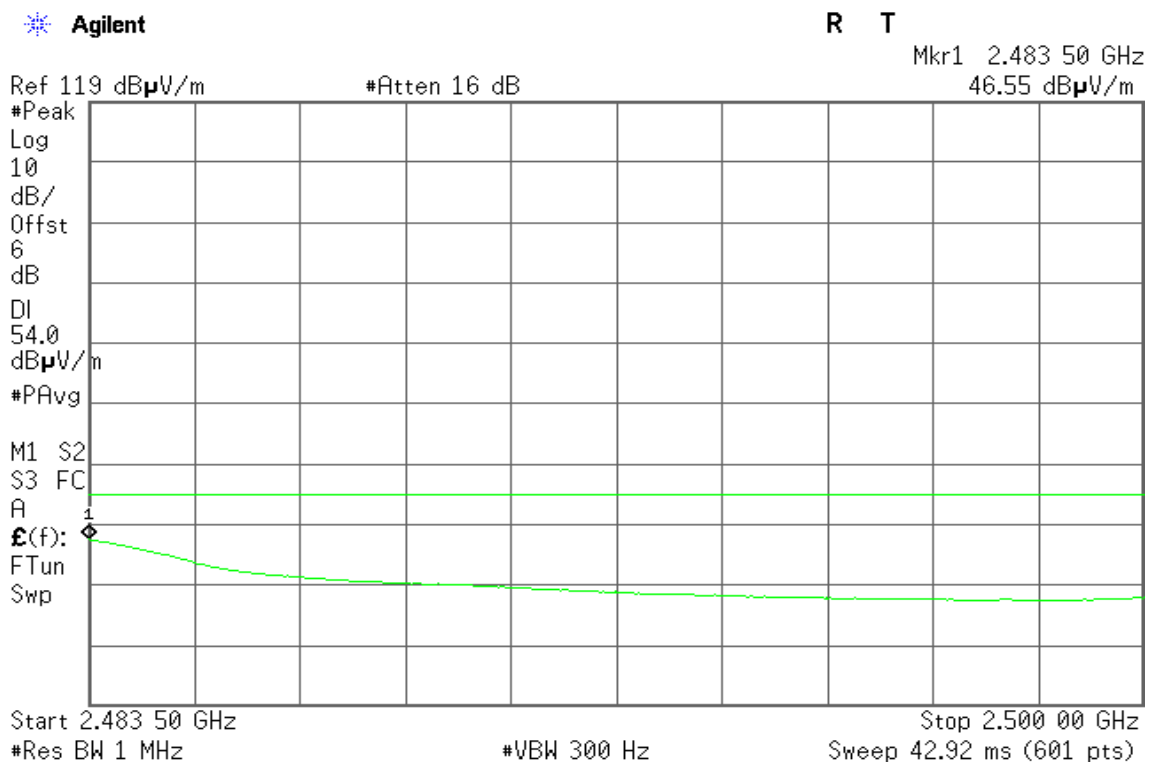



Detector mode: Peak

Polarity: Horizontal

Agilent

R T

Mkr1 2.483 58 GHz
53.98 dB μ V/m

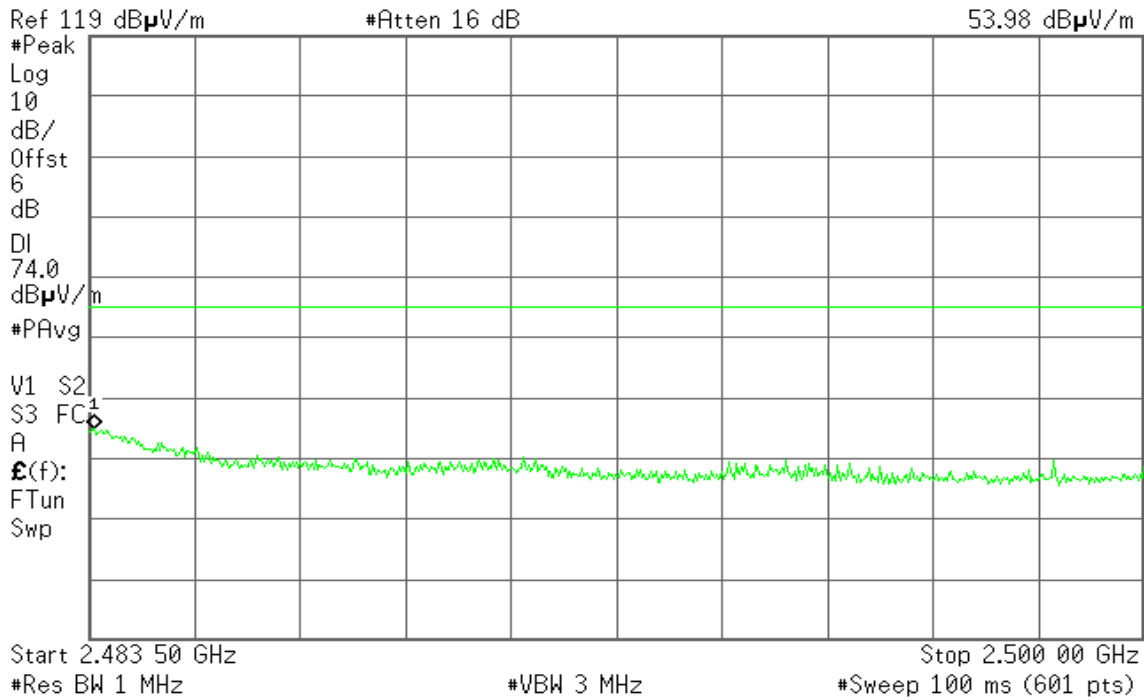

Detector mode: Average

Polarity: Horizontal

Agilent

R T

Mkr1 2.483 58 GHz
40.70 dB μ V/m

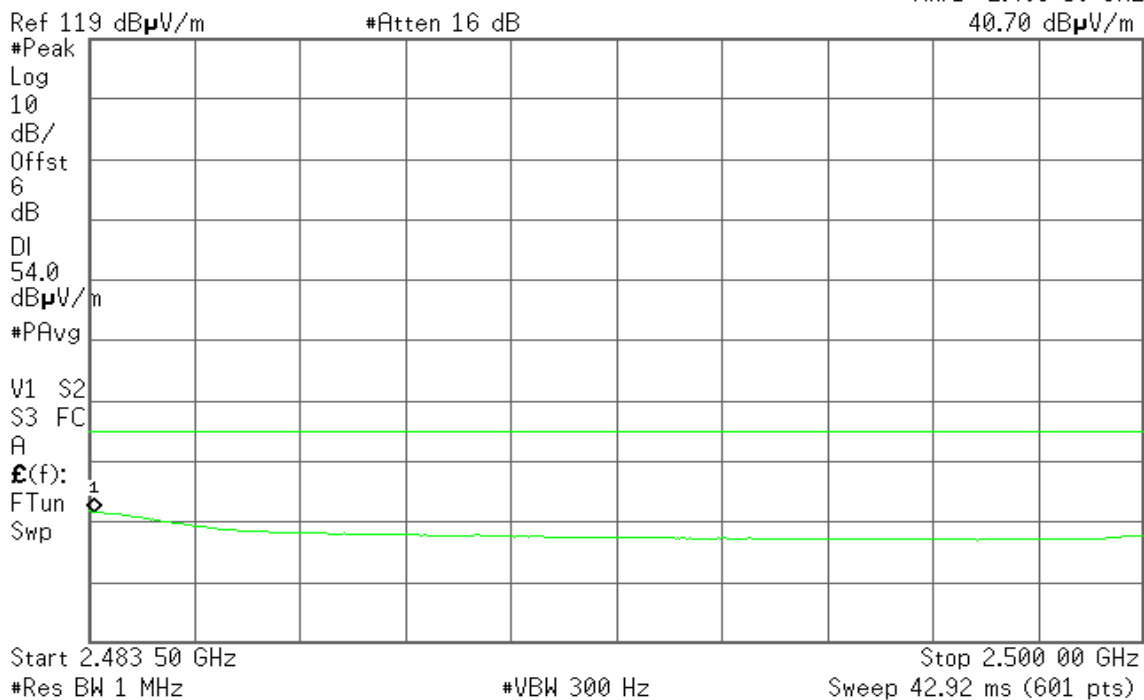



Band Edges (IEEE 802.11n HT 20 mode / CH Low)

Detector mode: Peak

Polarity: Vertical

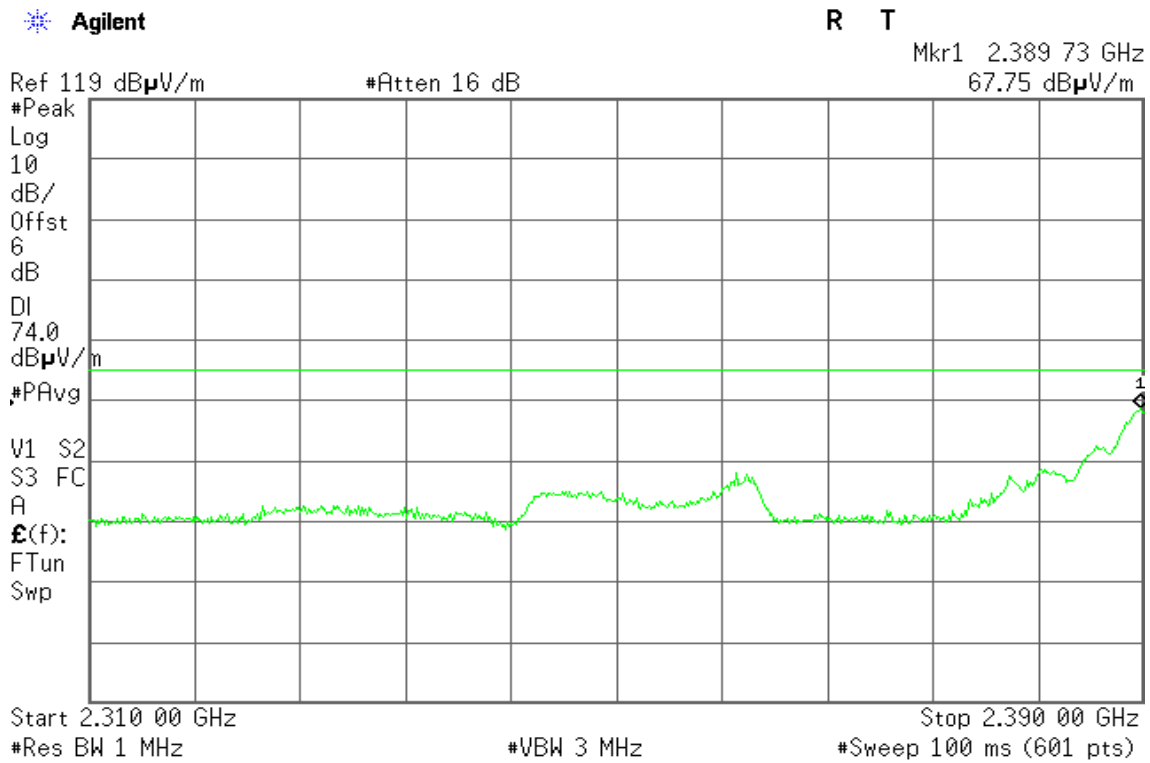

Detector mode: Average

Polarity: Vertical

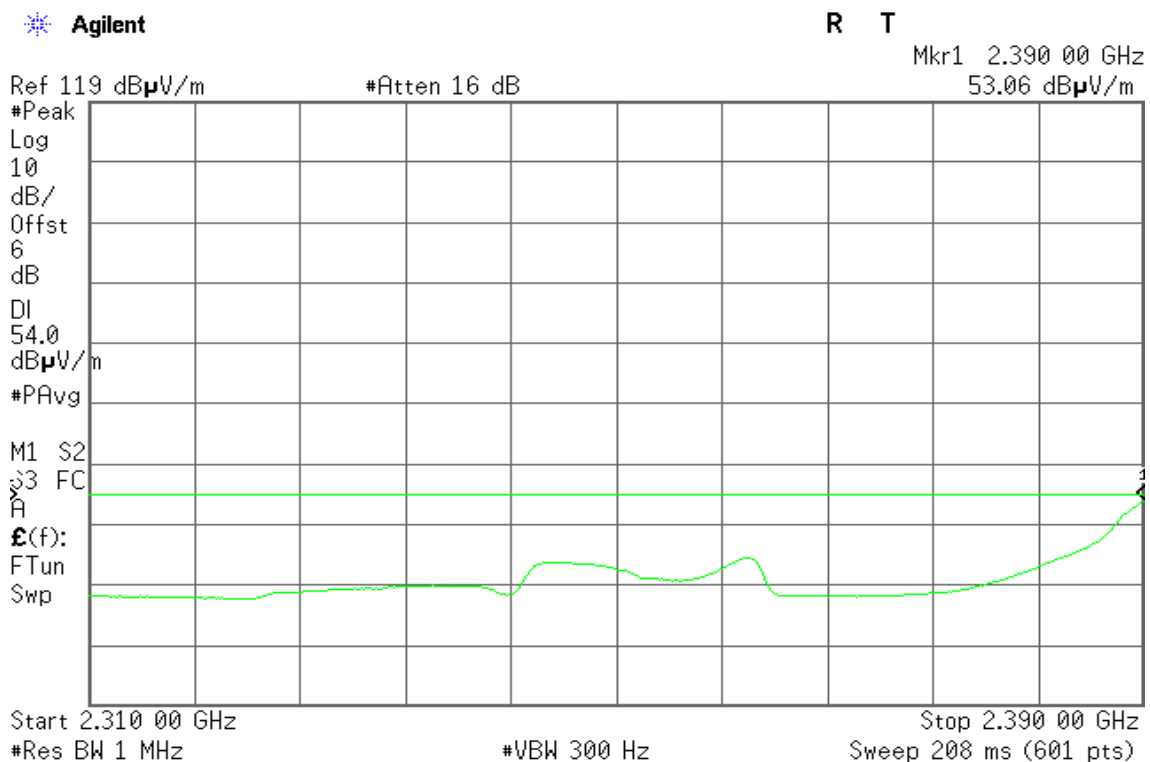



Detector mode: Peak

Polarity: Horizontal

Agilent

R T

Mkr1 2.389 47 GHz
55.13 dB μ V/m

Ref 119 dB μ V/m

#Atten 16 dB

#Peak

Log

10

dB/

Offst

6

dB

DI

74.0

dB μ V/m

#PAvg

V1 S2

S3 FC

A

$\mathcal{E}(f)$:

FTun

Swp

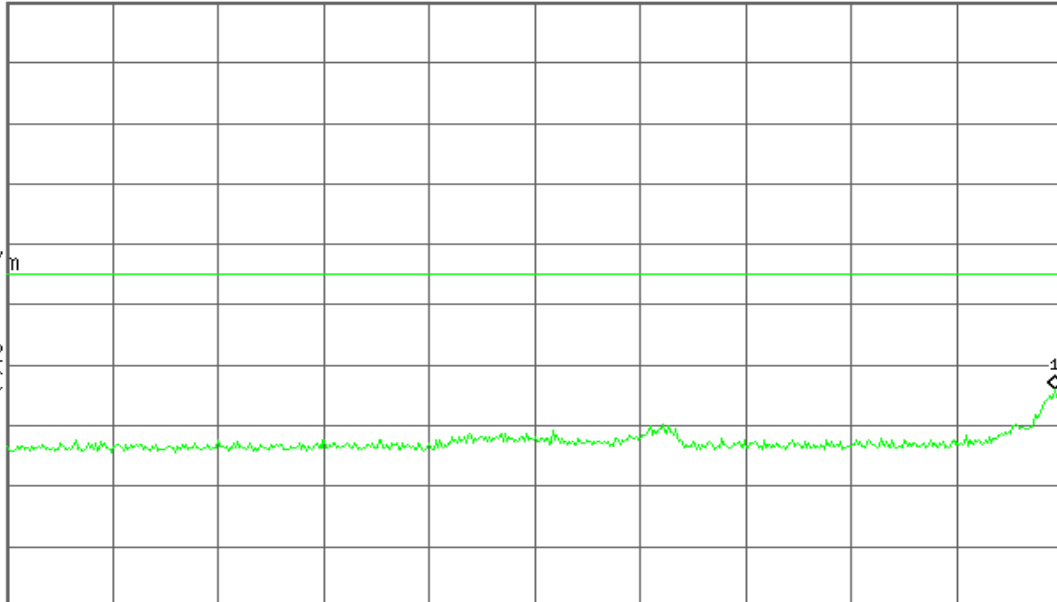

Start 2.310 00 GHz

Stop 2.390 00 GHz

#Res BW 1 MHz

#VBW 3 MHz

#Sweep 100 ms (601 pts)

Detector mode: Average

Polarity: Horizontal

Agilent

R T

Mkr1 2.390 00 GHz
40.26 dB μ V/m

Ref 119 dB μ V/m

#Atten 16 dB

#Peak

Log

10

dB/

Offst

6

dB

DI

54.0

dB μ V/m

#PAvg

W1 S2

S3 FC

A

$\mathcal{E}(f)$:

fTun

Swp



Start 2.310 00 GHz

Stop 2.390 00 GHz

#Res BW 1 MHz

#VBW 300 Hz

Sweep 208 ms (601 pts)



Band Edges (IEEE 802.11n HT 20 mode / CH High)

Detector mode: Peak

Polarity: Vertical

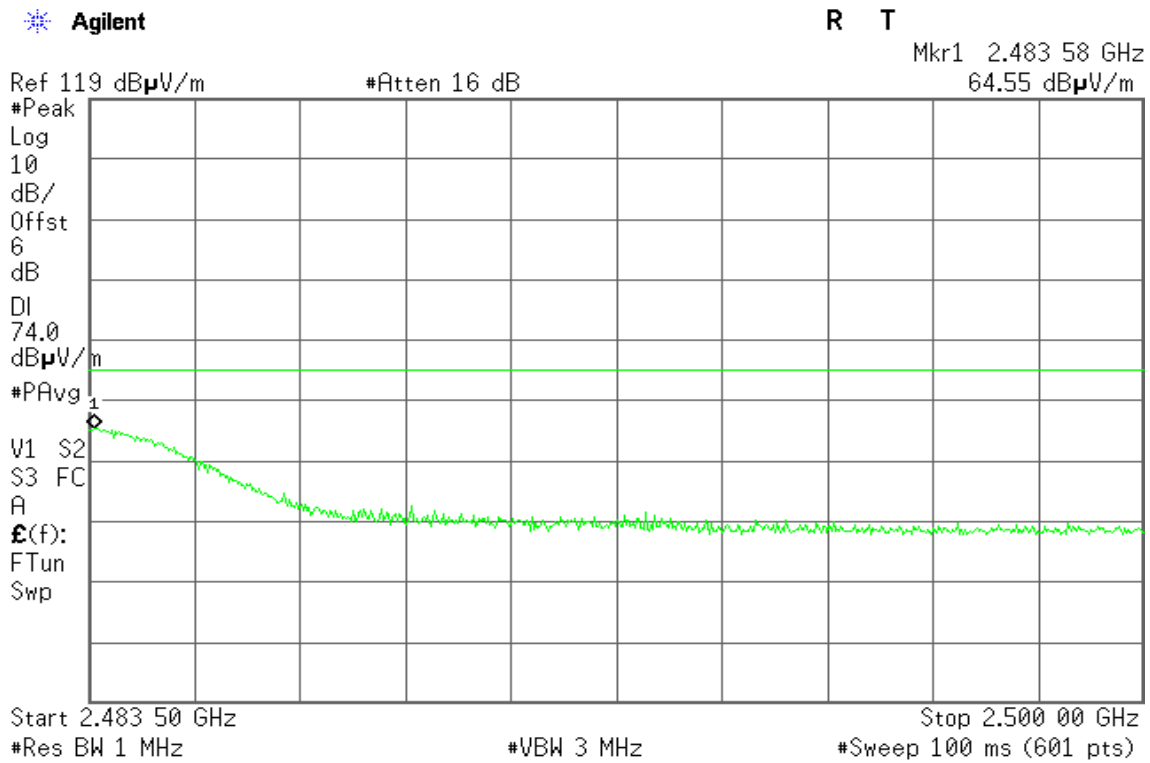

Detector mode: Average

Polarity: Vertical

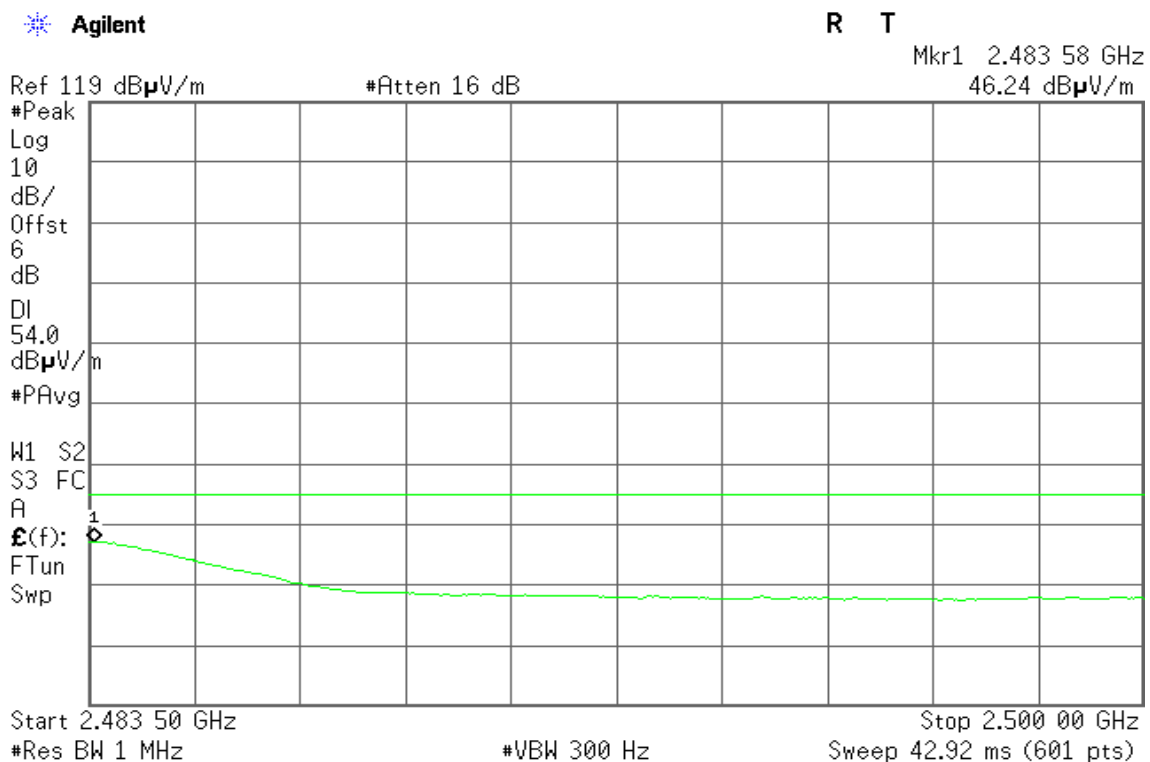



Detector mode: Peak

Polarity: Horizontal

Agilent

R T

Mkr1 2.483 69 GHz
49.32 dBµV/m

Ref 119 dBµV/m

#Atten 16 dB

#Peak

Log

10

dB/

Offst

6

dB

DI

74.0

dBµV/m

#PAvg

V1 S2

S3 FC

A

£(f):

FTun

Swp

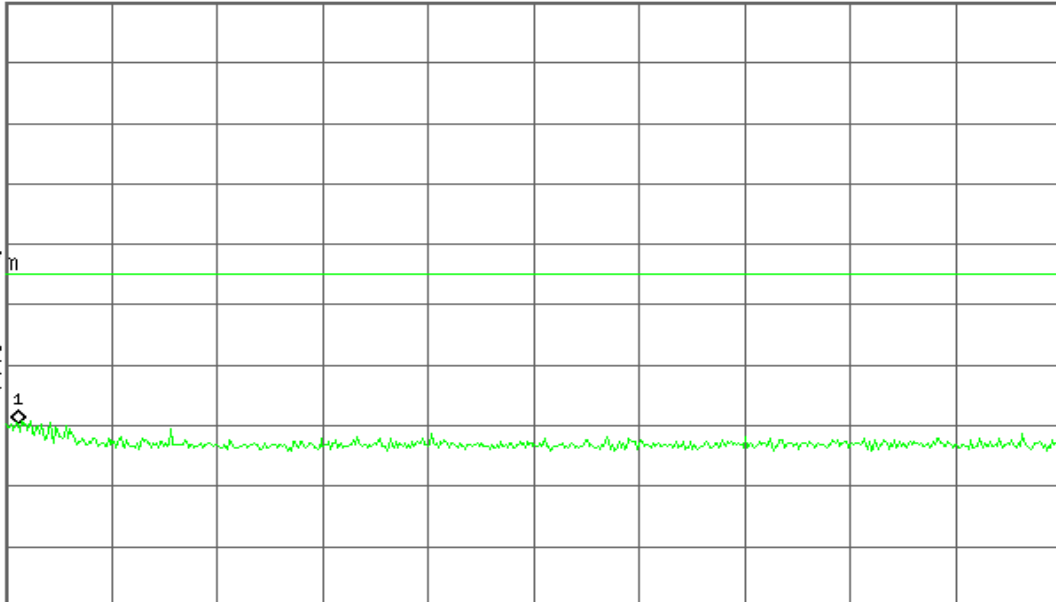

Start 2.483 50 GHz

Stop 2.500 00 GHz

#Res BW 1 MHz

#VBW 3 MHz

#Sweep 100 ms (601 pts)

Detector mode: Average

Polarity: Horizontal

Agilent

R T

Mkr1 2.483 69 GHz
36.65 dBµV/m

Ref 119 dBµV/m

#Atten 16 dB

#Peak

Log

10

dB/

Offst

6

dB

DI

54.0

dBµV/m

#PAvg

W1 S2

S3 FC

A

£(f):

FTun

Swp



Start 2.483 50 GHz

Stop 2.500 00 GHz

#Res BW 1 MHz

#VBW 300 Hz

Sweep 42.92 ms (601 pts)



Band Edges (IEEE 802.11n HT 40 mode / CH Low)

Detector mode: Peak

Polarity: Vertical

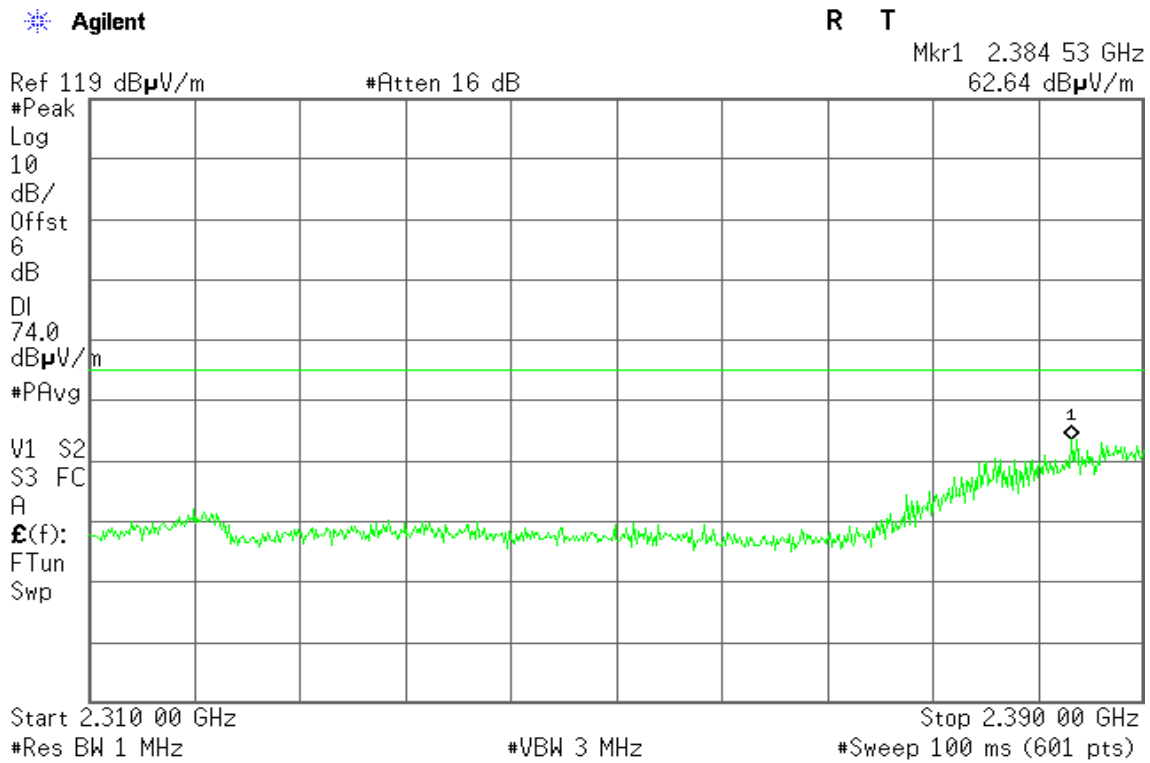

Detector mode: Average

Polarity: Vertical

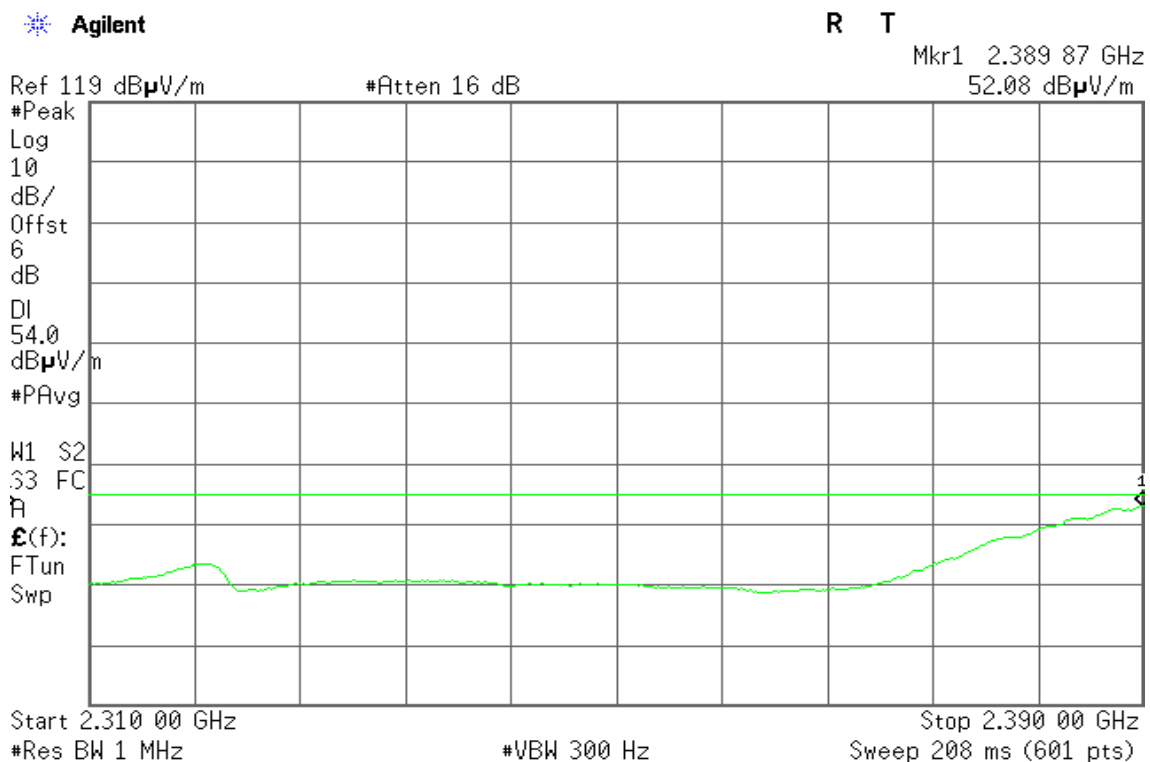



Detector mode: Peak

Polarity: Horizontal

Agilent

R T

Mkr1 2.389 07 GHz
50.80 dBµV/m

Ref 119 dBµV/m

#Atten 16 dB

#Peak

Log

10

dB/

Offst

6

dB

DI

74.0

dBµV/m

#PAvg

V1 S2

S3 FC

A

£(f):

FTun

Swp

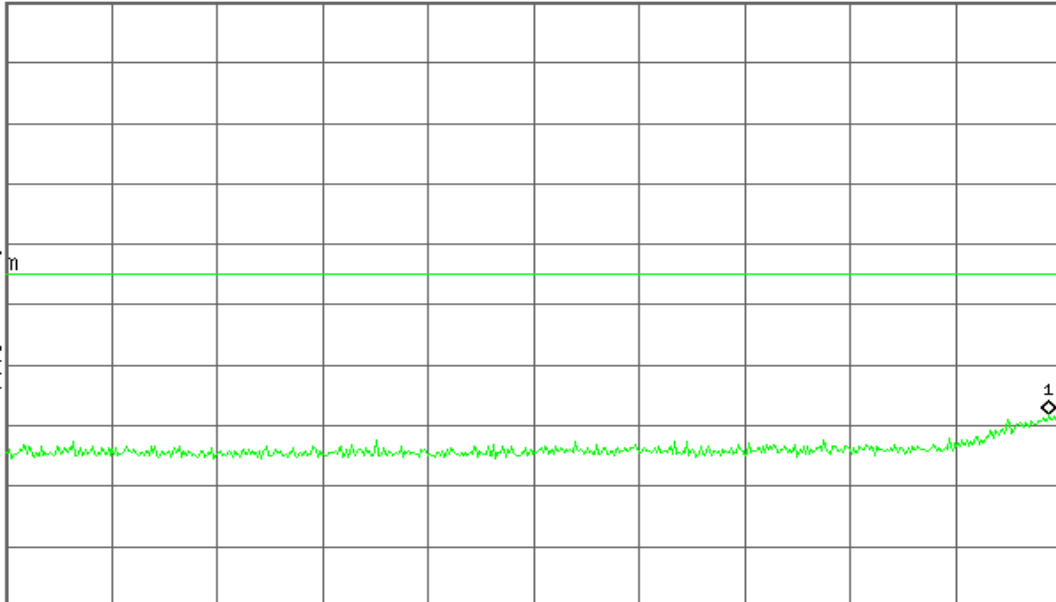

Start 2.310 00 GHz

Stop 2.390 00 GHz

#Res BW 1 MHz

#VBW 3 MHz

#Sweep 100 ms (601 pts)

Detector mode: Average

Polarity: Horizontal

Agilent

R T

Mkr1 2.389 20 GHz
42.42 dBµV/m

Ref 119 dBµV/m

#Atten 16 dB

#Peak

Log

10

dB/

Offst

6

dB

DI

54.0

dBµV/m

#PAvg

V1 S2

S3 FC

A

£(f):

FTun

Swp

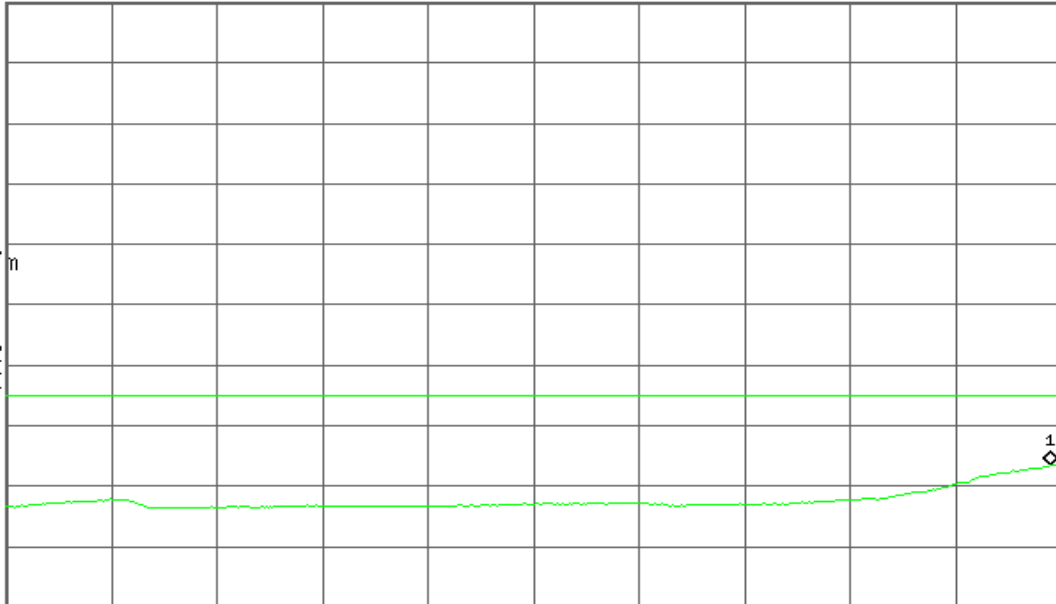

Start 2.310 00 GHz

Stop 2.390 00 GHz

#Res BW 1 MHz

#VBW 300 Hz

Sweep 208 ms (601 pts)



Band Edges (IEEE 802.11n HT 40 mode / CH High)

Detector mode: Peak

Polarity: Vertical

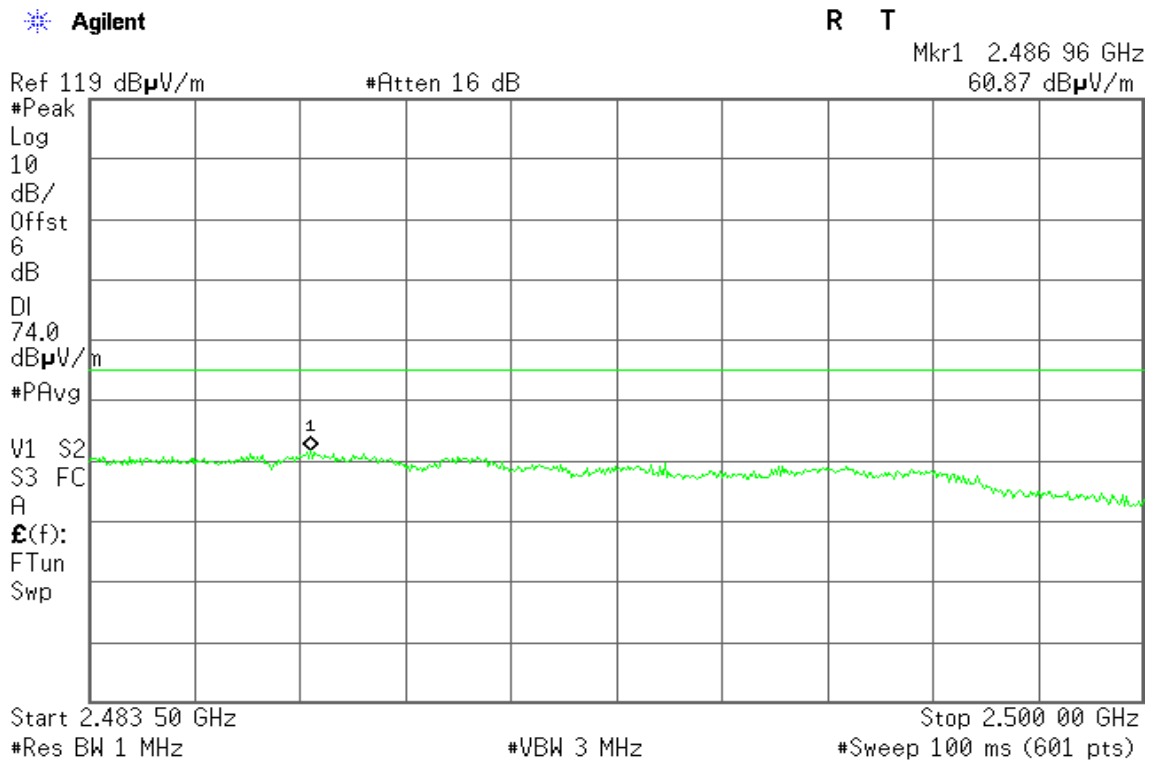

Detector mode: Average

Polarity: Vertical

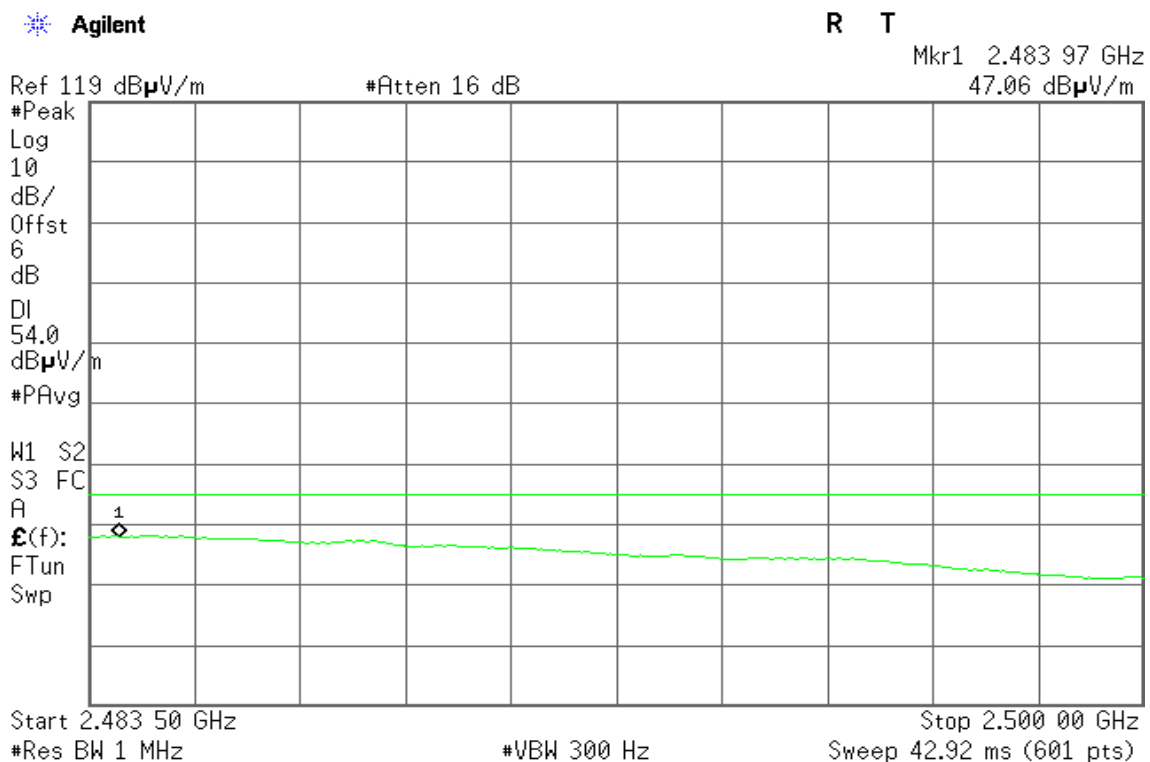



Detector mode: Peak

Polarity: Horizontal

Agilent

R T

Mkr1 2.483 66 GHz
49.96 dB μ V/m

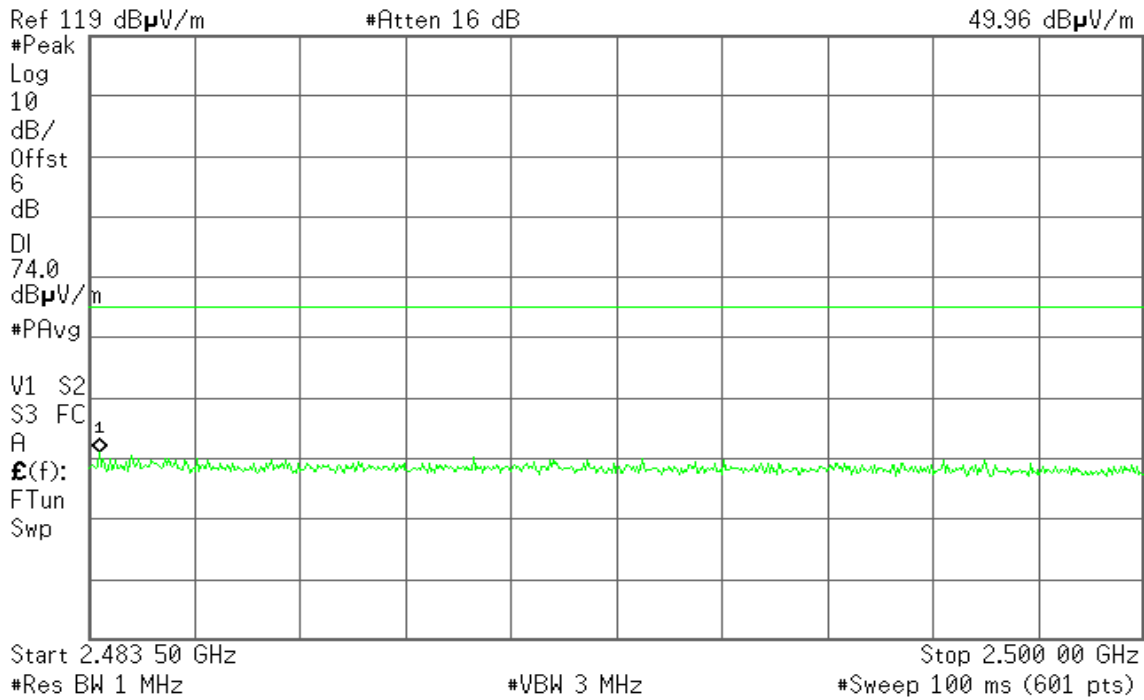

Detector mode: Average

Polarity: Horizontal

Agilent

R T

Mkr1 2.483 66 GHz
36.88 dB μ V/m

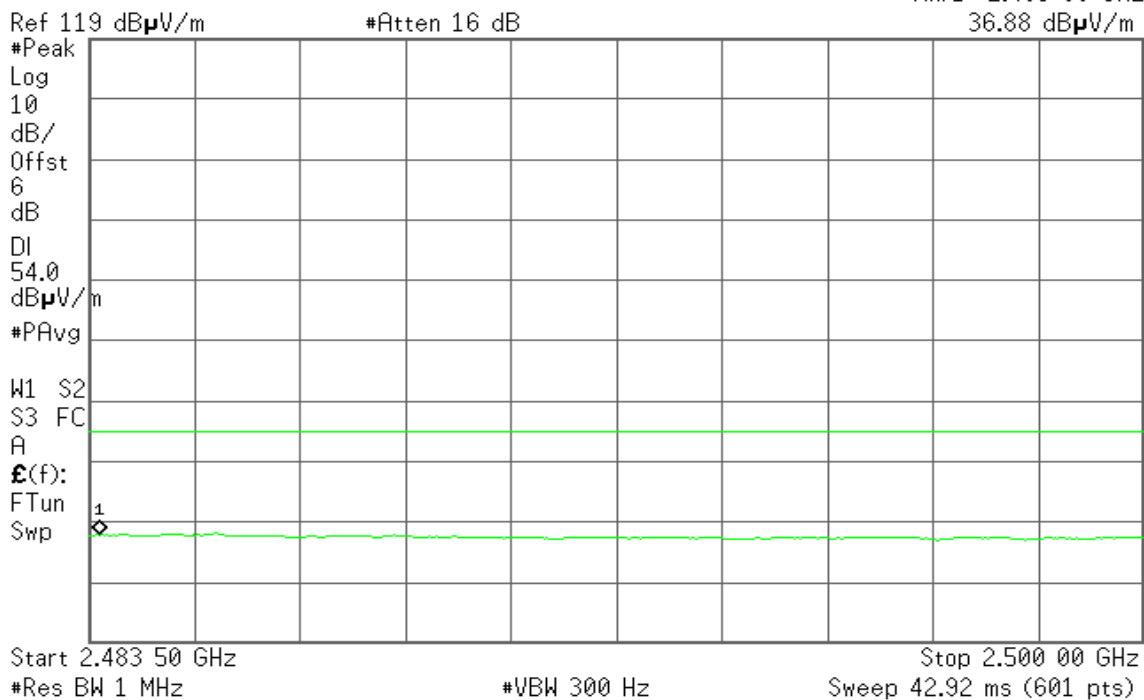



Test Plot

Conducted Band Edges (IEEE 802.11b mode / CH Low)

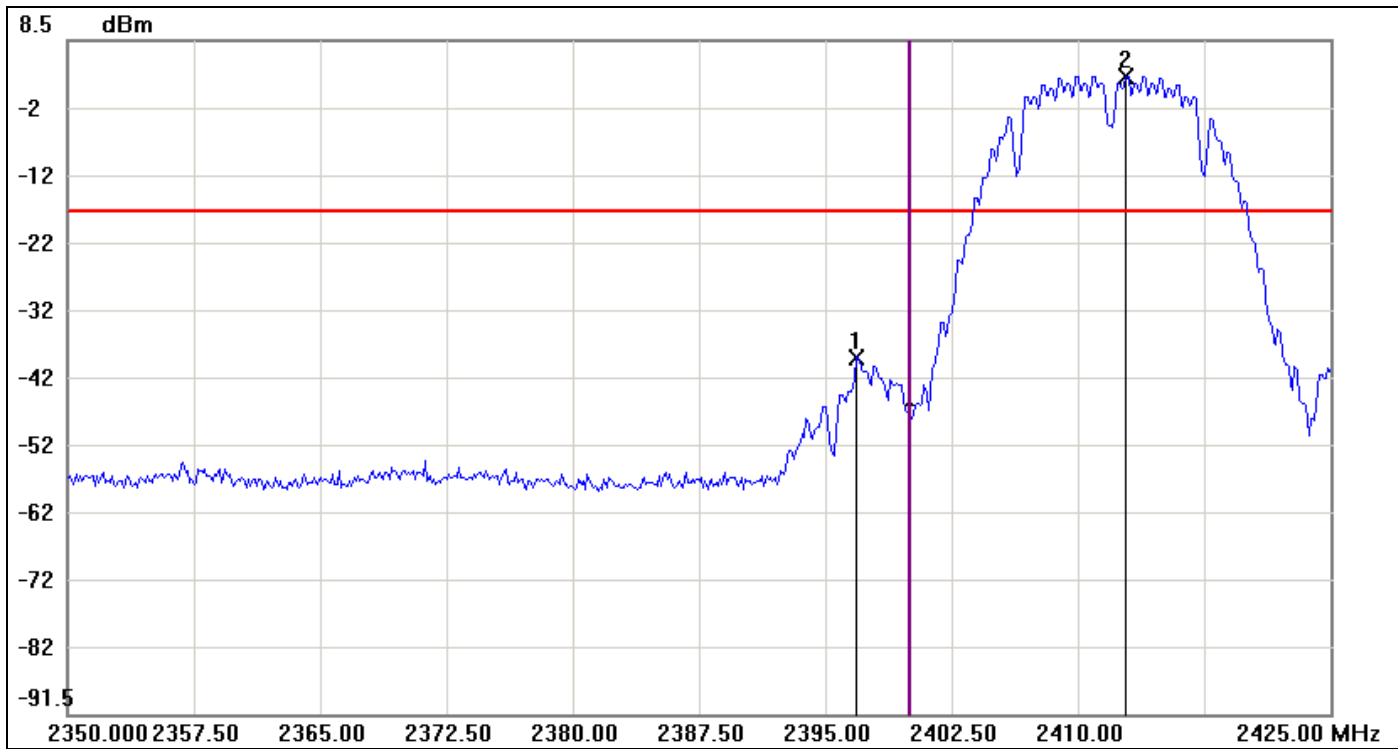

No.	Frequency(MHz)	Result(dBm)	Limit(dBm)	Margin(dBm)
1	2396.8750	-38.53	-16.89	-21.64
2	2412.8750	3.11	-16.89	20.00



Conducted Band Edges (IEEE 802.11b mode / CH High)

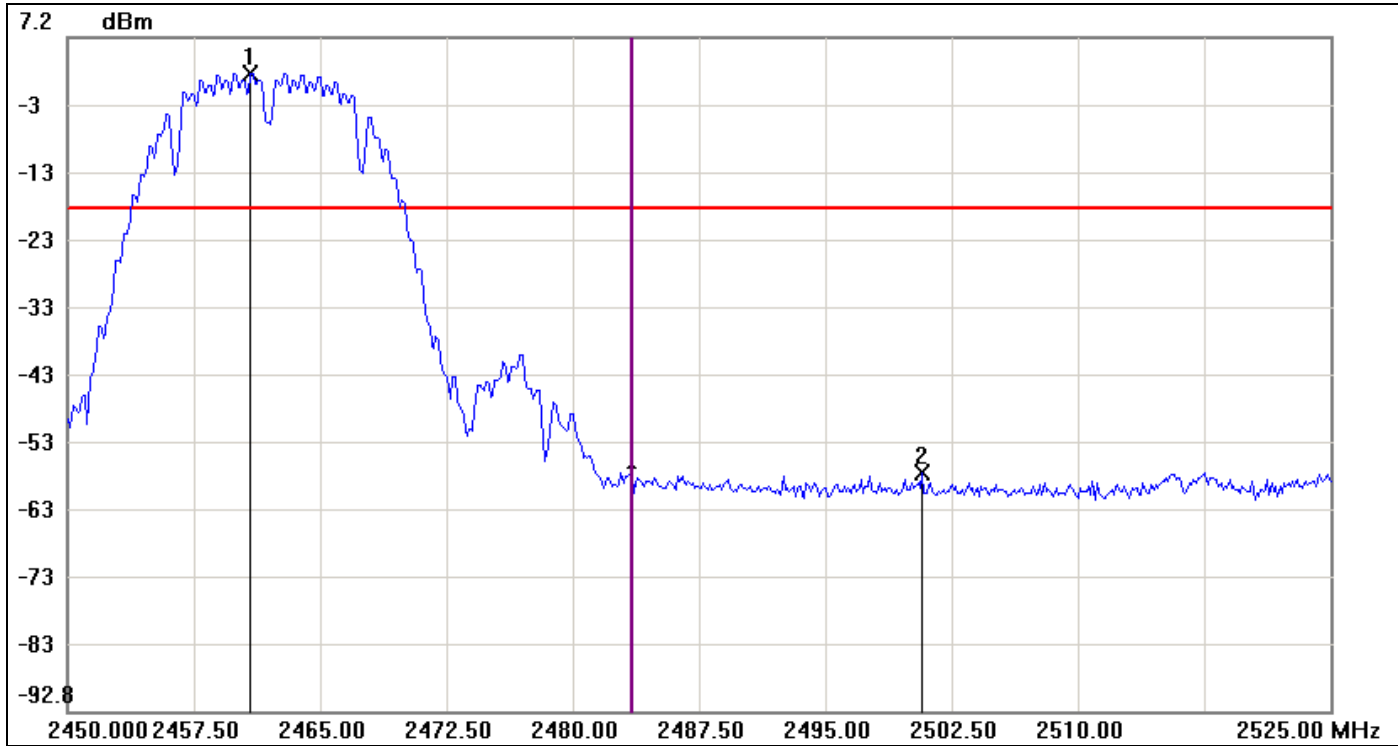

No.	Frequency(MHz)	Result(dBm)	Limit(dBm)	Margin(dBm)
1	2460.8750	1.85	-18.15	20.00
2	2500.7500	-57.30	-18.15	-39.15



Conducted Band Edges (IEEE 802.11g mode / CH Low)

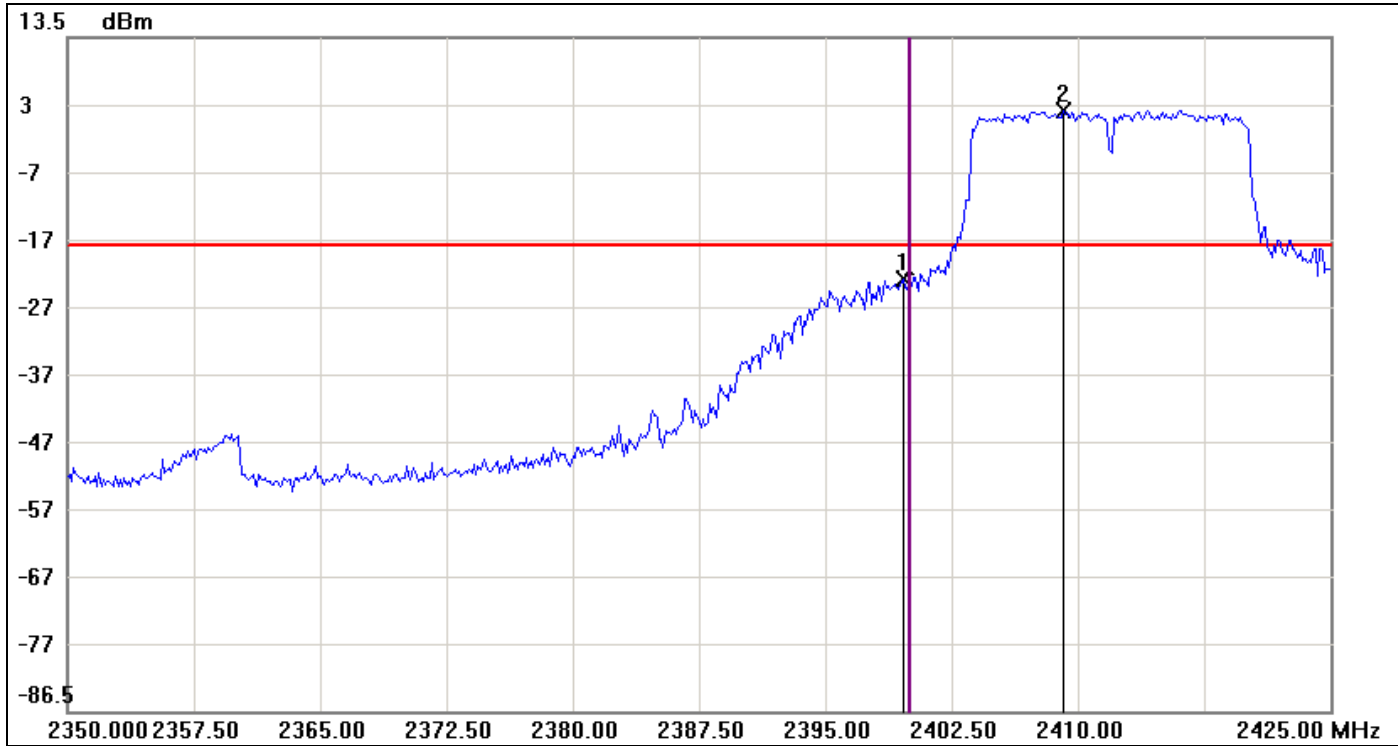

No.	Frequency(MHz)	Result(dBm)	Limit(dBm)	Margin(dBm)
1	2399.6250	-22.49	-17.42	-5.07
2	2409.1250	2.58	-17.42	20.00



Conducted Band Edges (IEEE 802.11g mode / CH High)

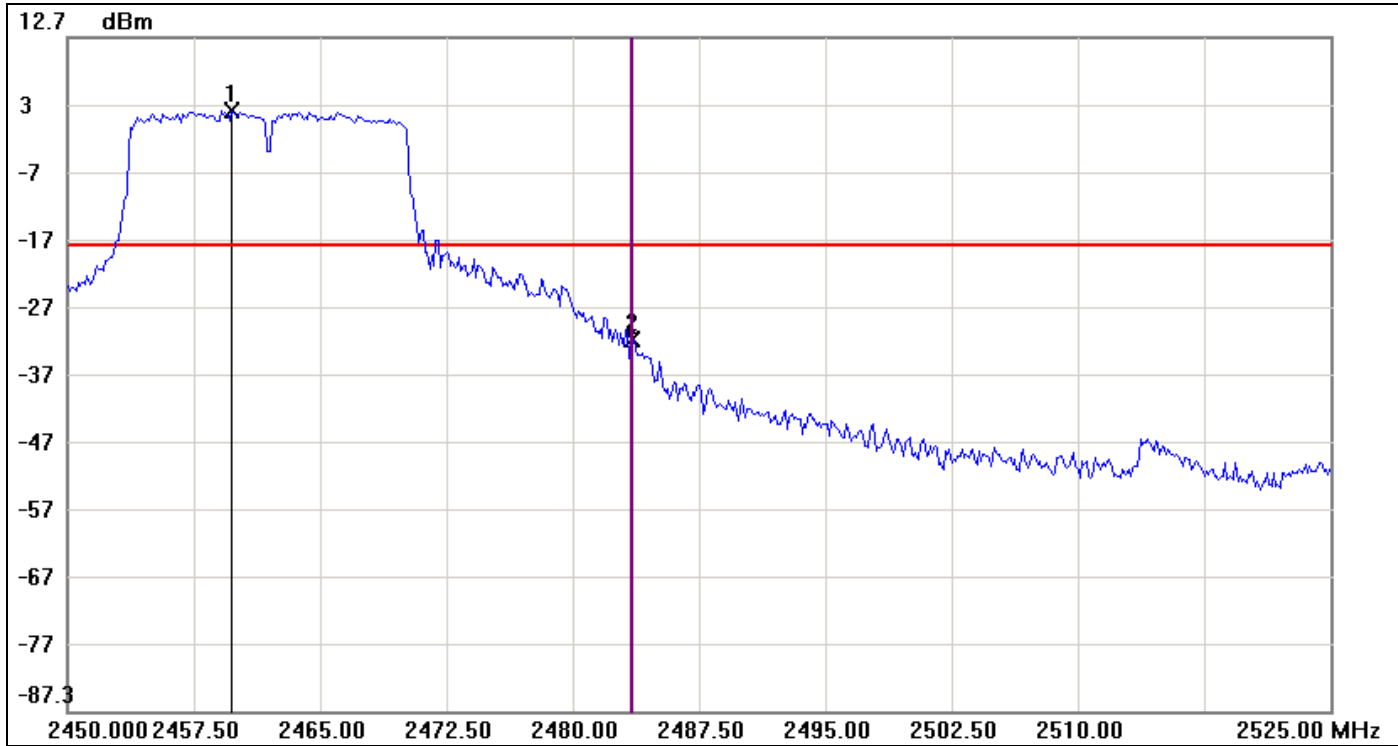

No.	Frequency(MHz)	Result(dBm)	Limit(dBm)	Margin(dBm)
1	2459.7500	1.85	-18.15	20.00
2	2483.5000	-32.15	-18.15	-14.00



Conducted Band Edges (IEEE 802.11n HT 20 mode / CH Low / Chain 0)

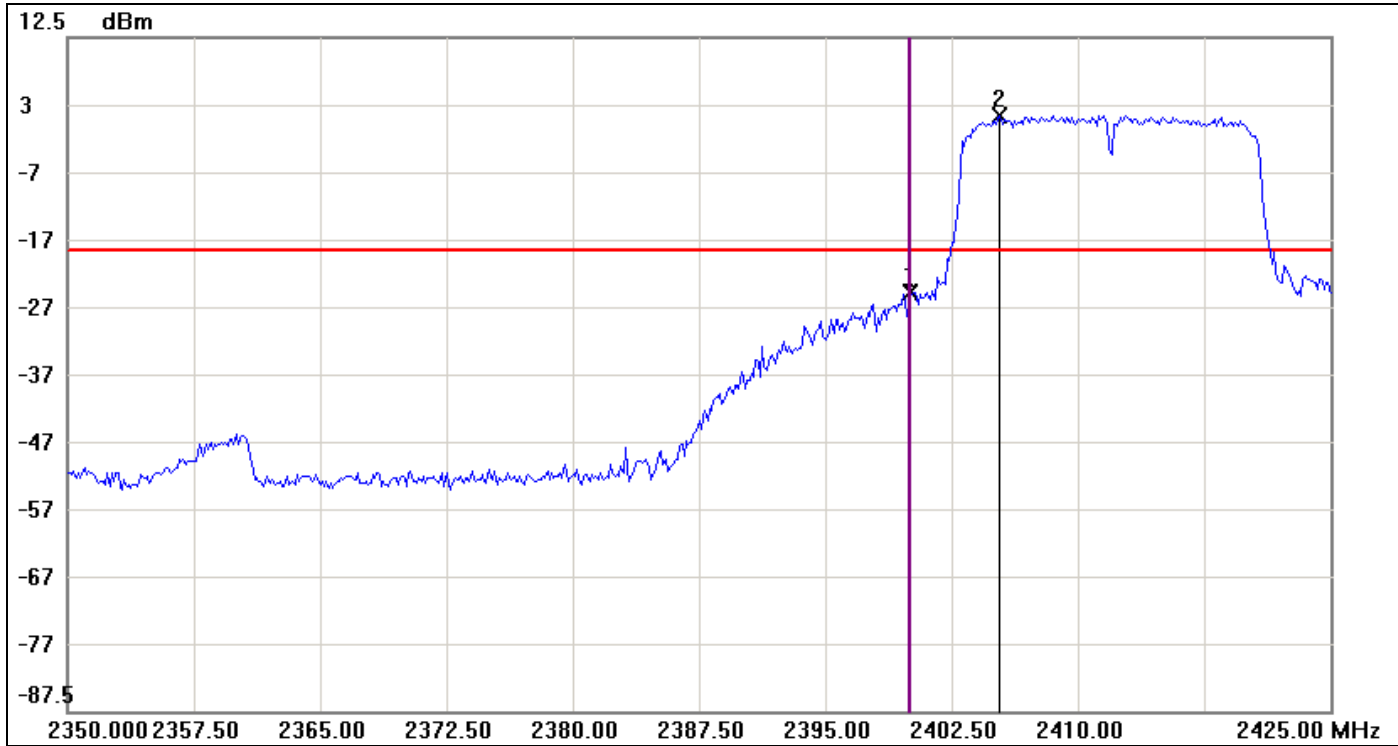

No.	Frequency(MHz)	Result(dBm)	Limit(dBm)	Margin(dBm)
1	2400.0000	-25.45	-19.07	-6.38
2	2405.3750	0.93	-19.07	20.00



Conducted Band Edges (IEEE 802.11n HT 20 mode / CH High / Chain 0)

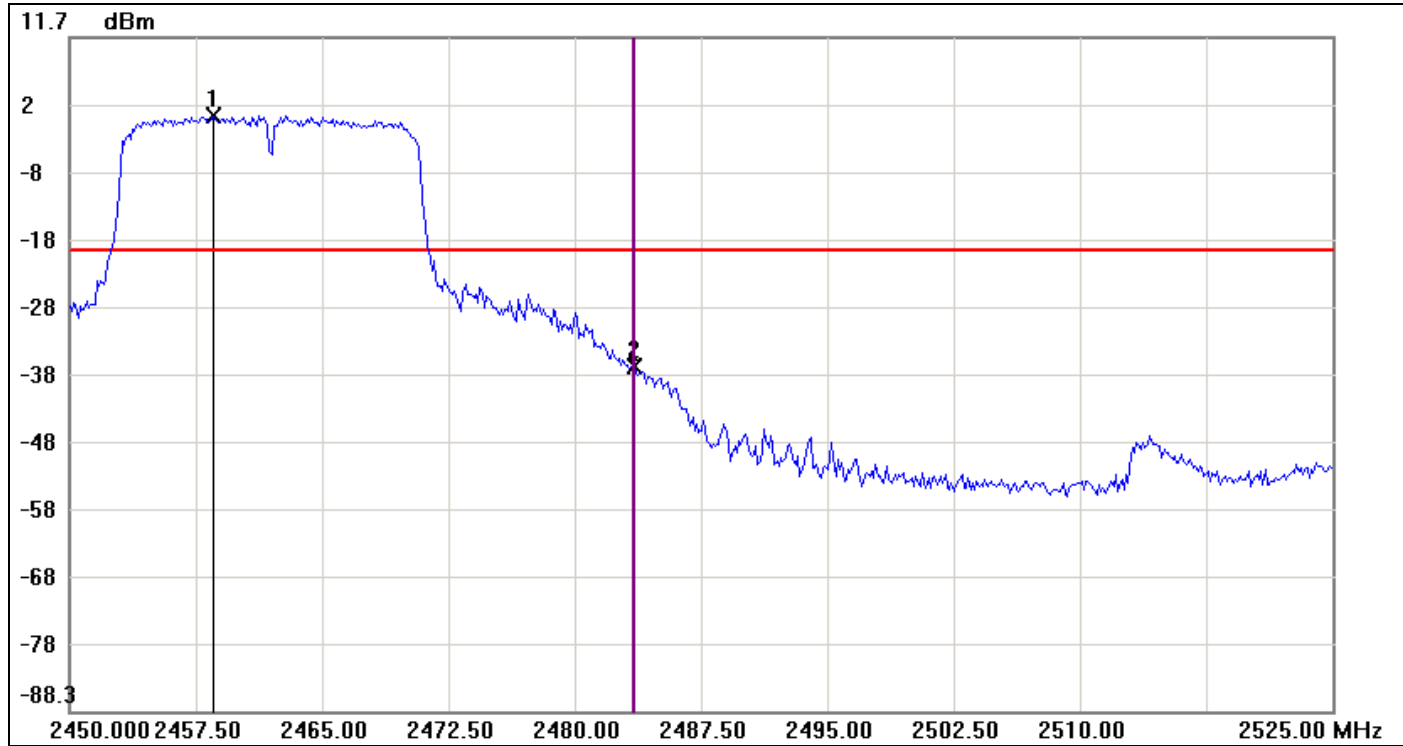

No.	Frequency(MHz)	Result(dBm)	Limit(dBm)	Margin(dBm)
1	2458.5000	0.13	-19.87	20.00
2	2483.5000	-37.17	-19.87	-17.30



Conducted Band Edges (IEEE 802.11n HT 20 mode / CH Low / Chain 1)

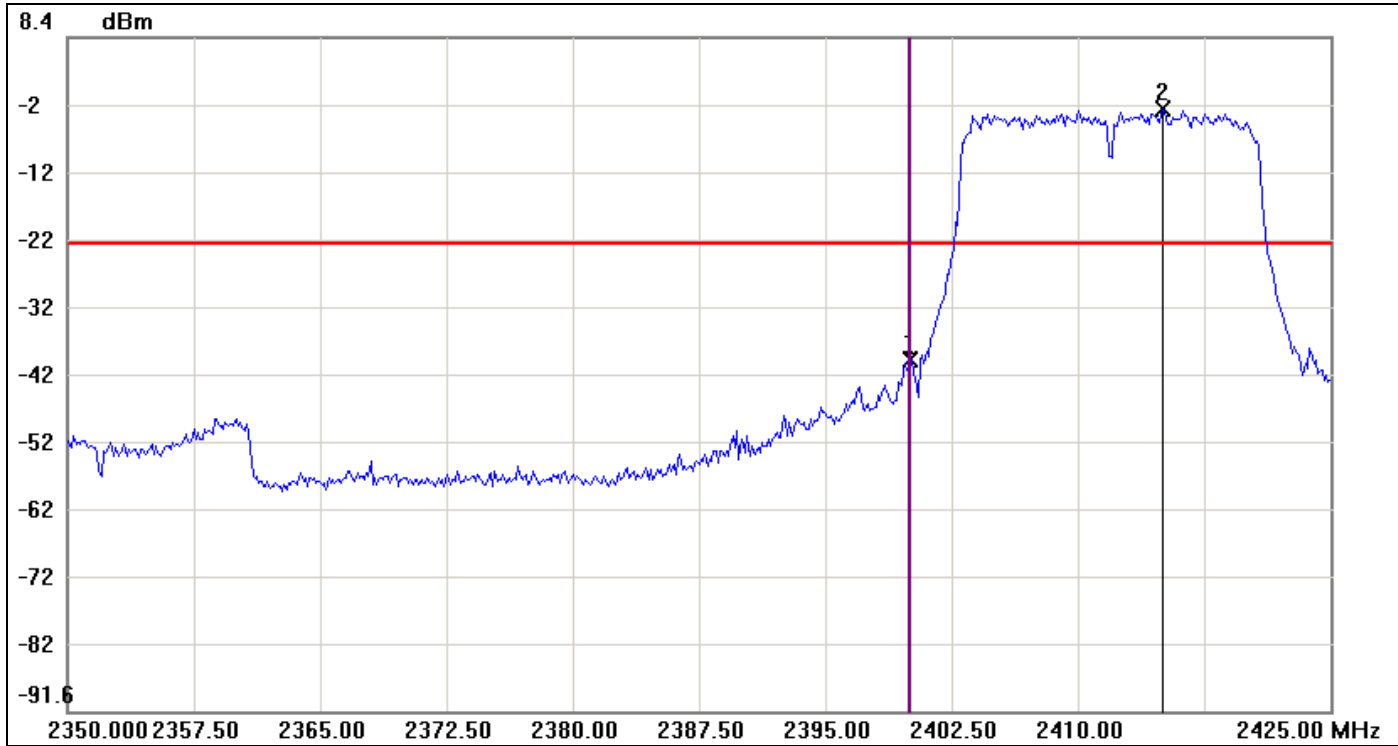

No.	Frequency(MHz)	Result(dBm)	Limit(dBm)	Margin(dBm)
1	2400.0000	-39.44	-22.28	-17.16
2	2415.0000	-2.28	-22.28	20.00



Conducted Band Edges (IEEE 802.11n HT 20 mode / CH High / Chain 1)

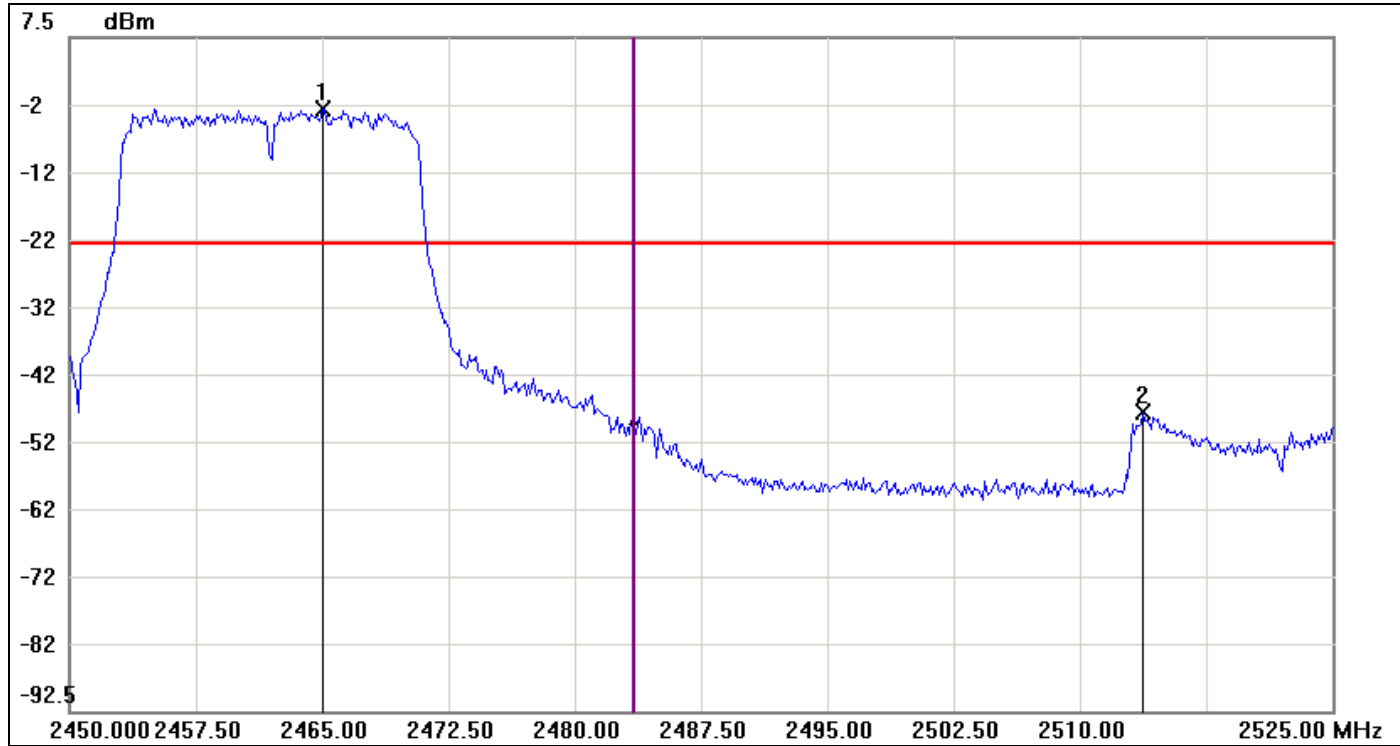

No.	Frequency(MHz)	Result(dBm)	Limit(dBm)	Margin(dBm)
1	2465.0000	-2.99	-22.99	20.00
2	2513.7500	-48.05	-22.99	-25.06



Conducted Band Edges (IEEE 802.11n HT 40 mode / CH Low / Chain 0)

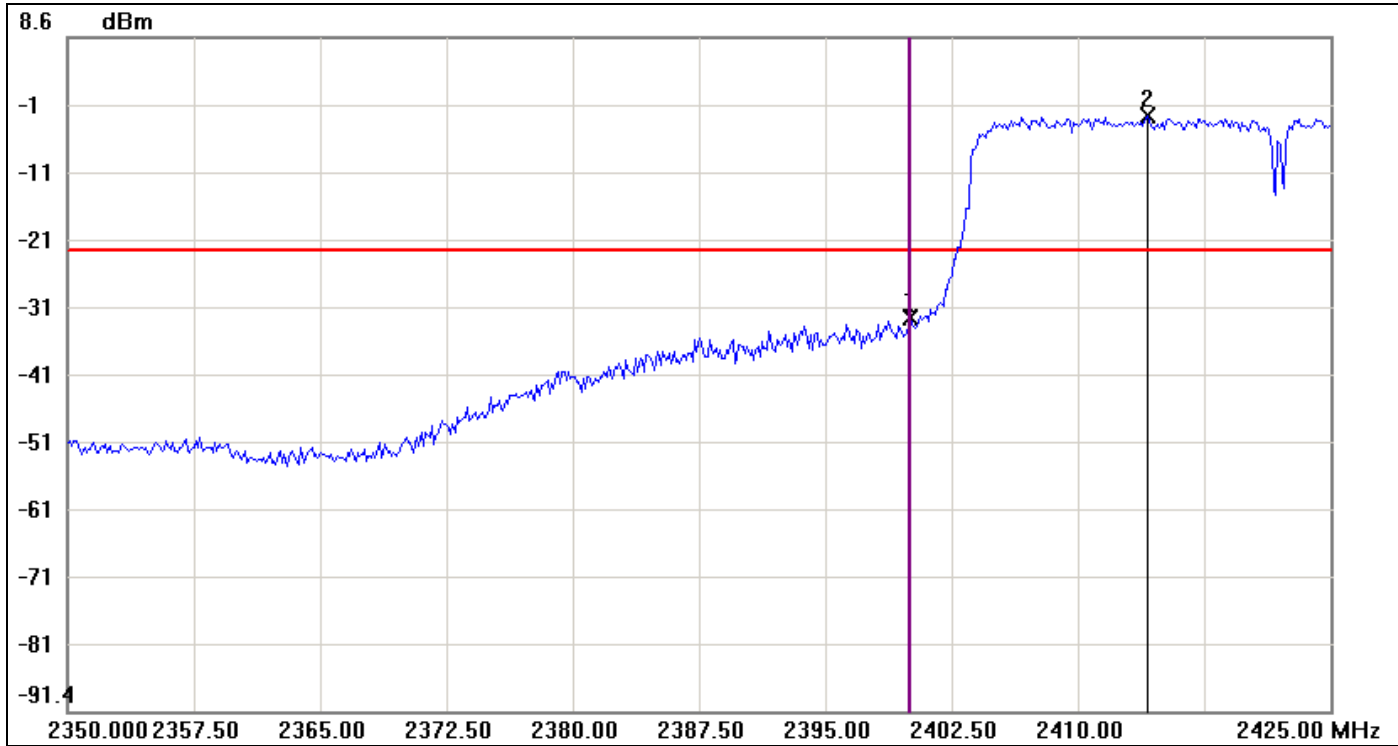

No.	Frequency(MHz)	Result(dBm)	Limit(dBm)	Margin(dBm)
1	2400.0000	-32.90	-23.11	-9.79
2	2414.1250	-3.11	-23.11	20.00



Conducted Band Edges (IEEE 802.11n HT 40 mode / CH High / Chain 0)

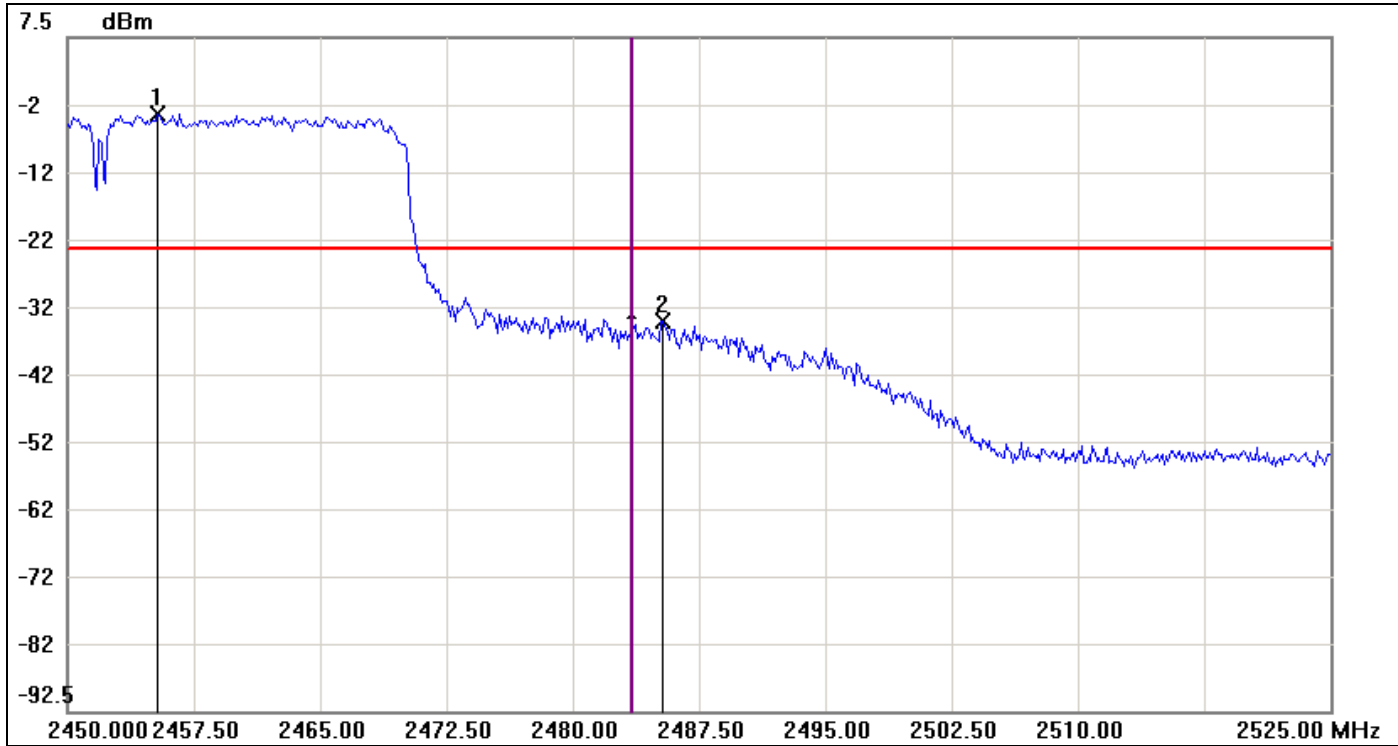

No.	Frequency(MHz)	Result(dBm)	Limit(dBm)	Margin(dBm)
1	2455.3750	-3.75	-23.75	20.00
2	2485.3750	-34.47	-23.75	-10.72



Conducted Band Edges (IEEE 802.11n HT 40 mode / CH Low / Chain 1)

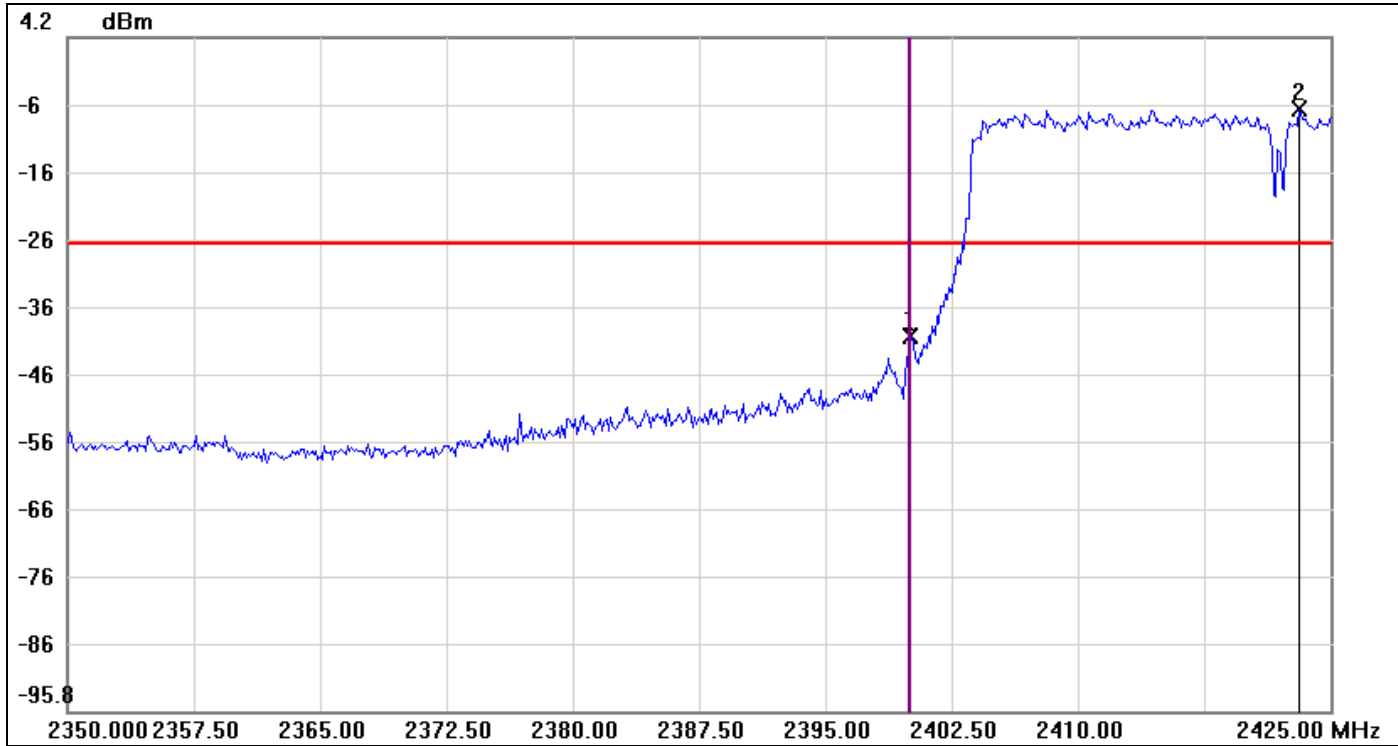

No.	Frequency(MHz)	Result(dBm)	Limit(dBm)	Margin(dBm)
1	2400.0000	-40.02	-26.35	-13.67
2	2423.1250	-6.35	-26.35	20.00



Conducted Band Edges (IEEE 802.11n HT 40 mode / CH High / Chain 1)

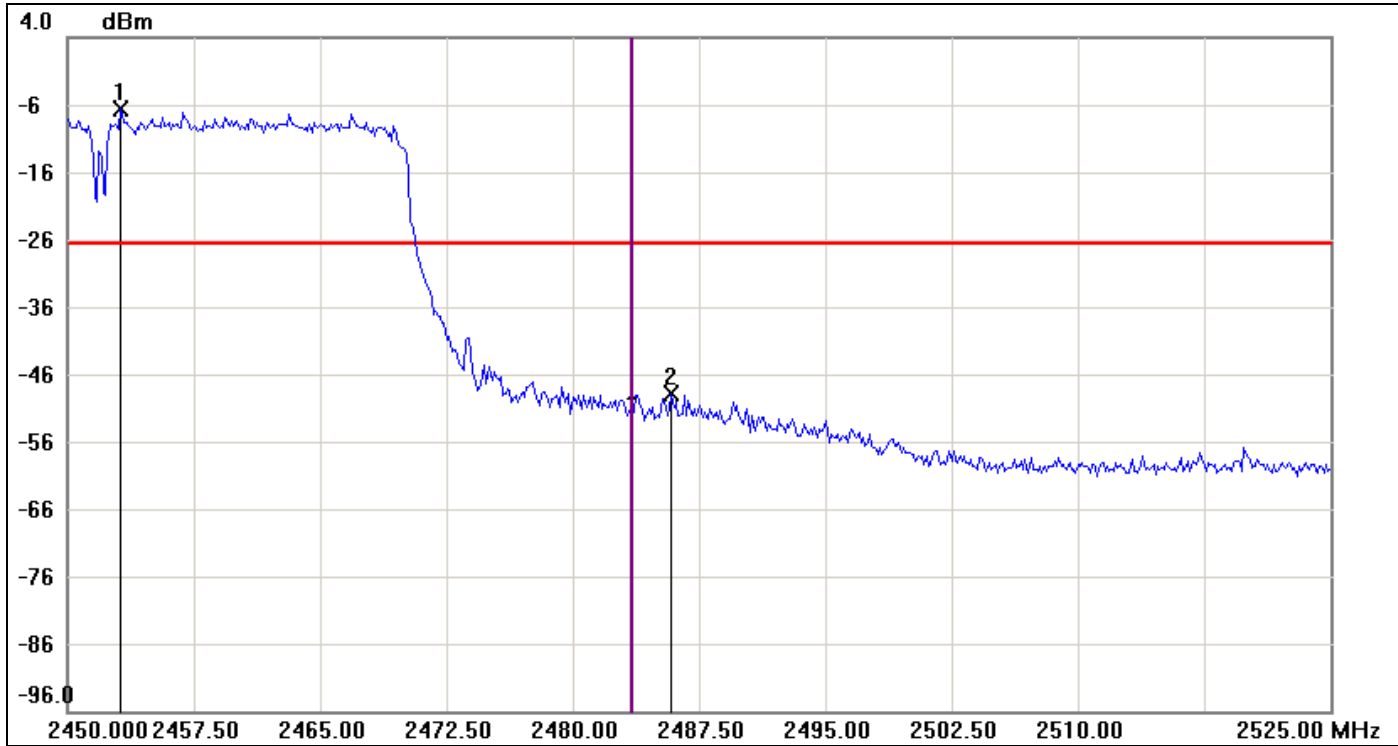

No.	Frequency(MHz)	Result(dBm)	Limit(dBm)	Margin(dBm)
1	2453.1250	-6.69	-26.69	20.00
2	2485.8750	-48.99	-26.69	-22.30



7.4 PEAK POWER SPECTRAL DENSITY

LIMIT

1. According to §15.247(e), for digitally modulated systems, the power spectral density conducted from the intentional radiator to the antenna shall not be greater than 8 dBm in any 3 kHz band during any time interval of continuous transmission.
2. According to §15.247(f), the digital modulation operation of the hybrid system, with the frequency hopping turned off, shall comply with the power density requirements of paragraph (d) of this section.

Test Configuration

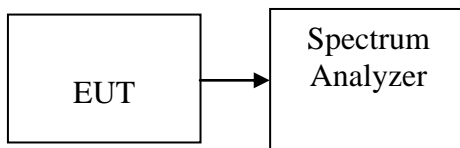

TEST PROCEDURE

The transmitter output is connected to a spectrum analyzer. Set the RBW = 100 kHz, VBW \geq 300 kHz, span to 1.5 times the DTS bandwidth, Detector = peak, Trace mode = max hold, Sweep = auto couple. Use the peak marker function to determine the maximum amplitude level within the RBW. If measured value exceeds limit, reduce RBW (no less than 3 kHz).

TEST RESULTS

No non-compliance noted.

**Test Data****Test mode: IEEE 802.11b mode**

Channel	Frequency (MHz)	PPSD (dBm)	Limit (dBm)	Result
Low	2412	-8.85	8.00	PASS
Mid	2437	-9.42		PASS
High	2462	-10.15		PASS

Test mode: IEEE 802.11g mode

Channel	Frequency (MHz)	PPSD (dBm)	Limit (dBm)	Result
Low	2412	-5.04	8.00	PASS
Mid	2437	-4.89		PASS
High	2462	-5.47		PASS

Test mode: IEEE 802.11n HT 20 mode

Channel	Frequency (MHz)	Chain 0 PPSD (dBm)	Chain 1 PPSD (dBm)	PPSD (dBm)	Limit (dBm)	Result
Low	2412	-5.90	-11.07	-4.75	8.00	PASS
Mid	2437	-6.82	-10.66	-5.32		PASS
High	2462	-6.80	-11.60	-5.56		PASS

Test mode: IEEE 802.11n HT 40 mode

Channel	Frequency (MHz)	Chain 0 PPSD (dBm)	Chain 1 PPSD (dBm)	PPSD (dBm)	Limit (dBm)	Result
Low	2422	-9.90	-14.26	-8.54	8.00	PASS
Mid	2437	-10.19	-14.56	-8.84		PASS
High	2452	-9.51	-14.65	-8.35		PASS

Remark: Total PPSD (dBm) = $10 * \text{LOG}(10^{\text{Chain 0 PPSD} / 10} + 10^{\text{Chain 2 PPSD} / 10})$



Test Plot

IEEE 802.11b mode

PPSD (CH Low)

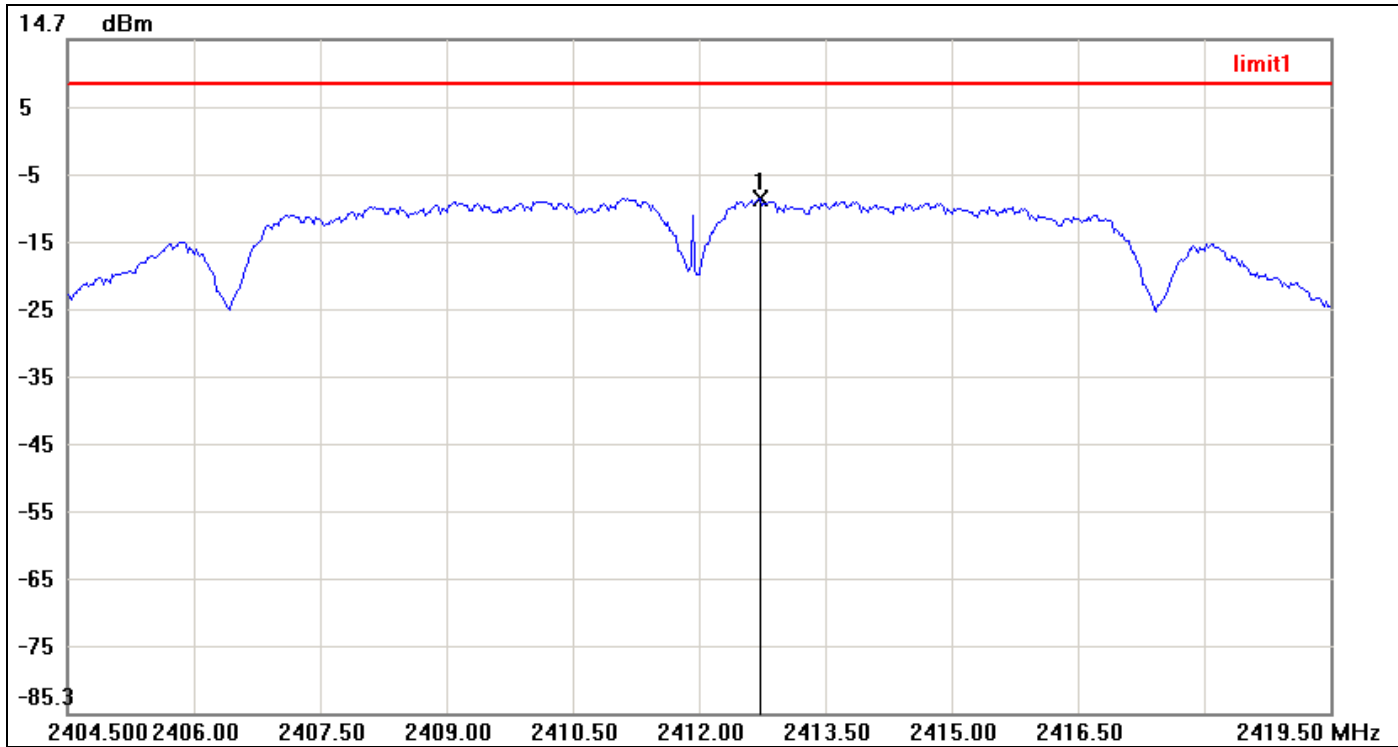

No.	Frequency(MHz)	Result(dBm)	Limit(dBm)	Margin(dBm)
1	2412.7250	-8.85	8.00	-16.85



PPSD (CH Mid)

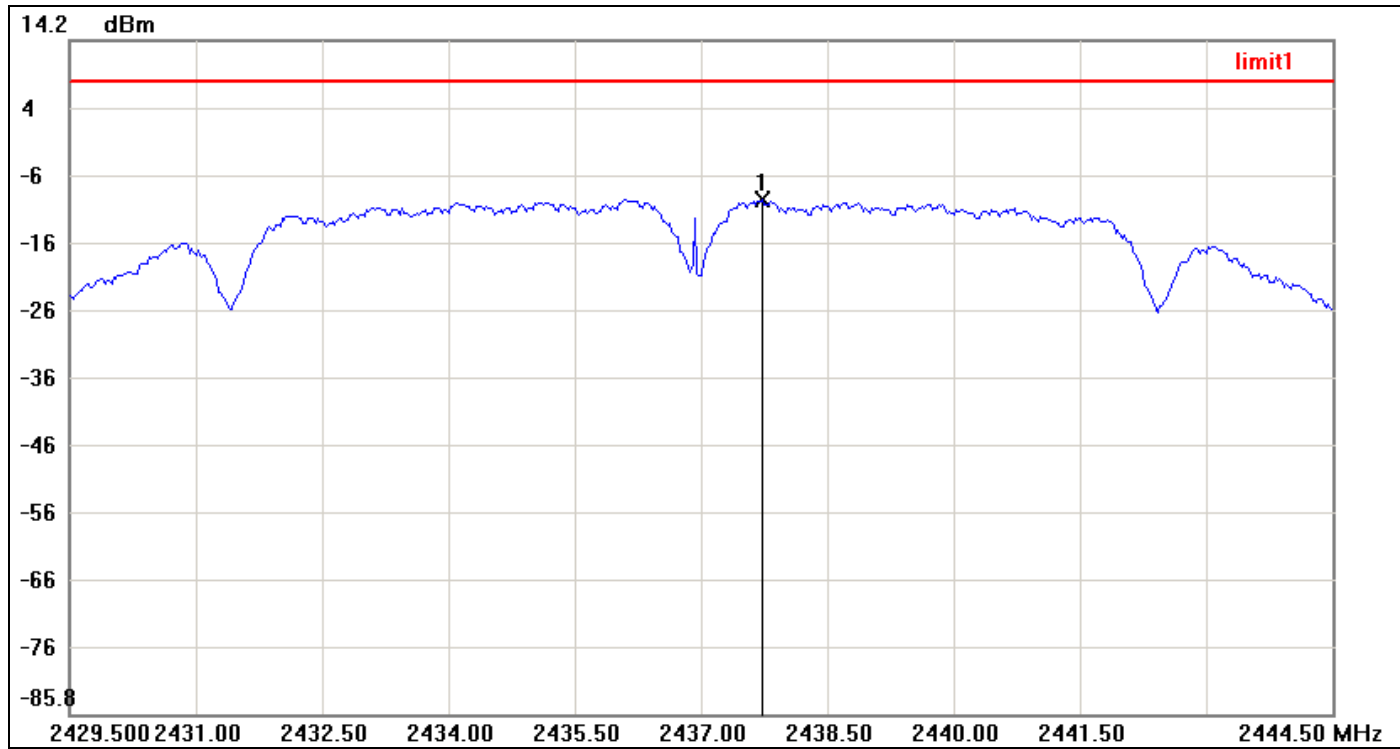

No.	Frequency(MHz)	Result(dBm)	Limit(dBm)	Margin(dBm)
1	2437.7250	-9.42	8.00	-17.42



PPSD (CH High)

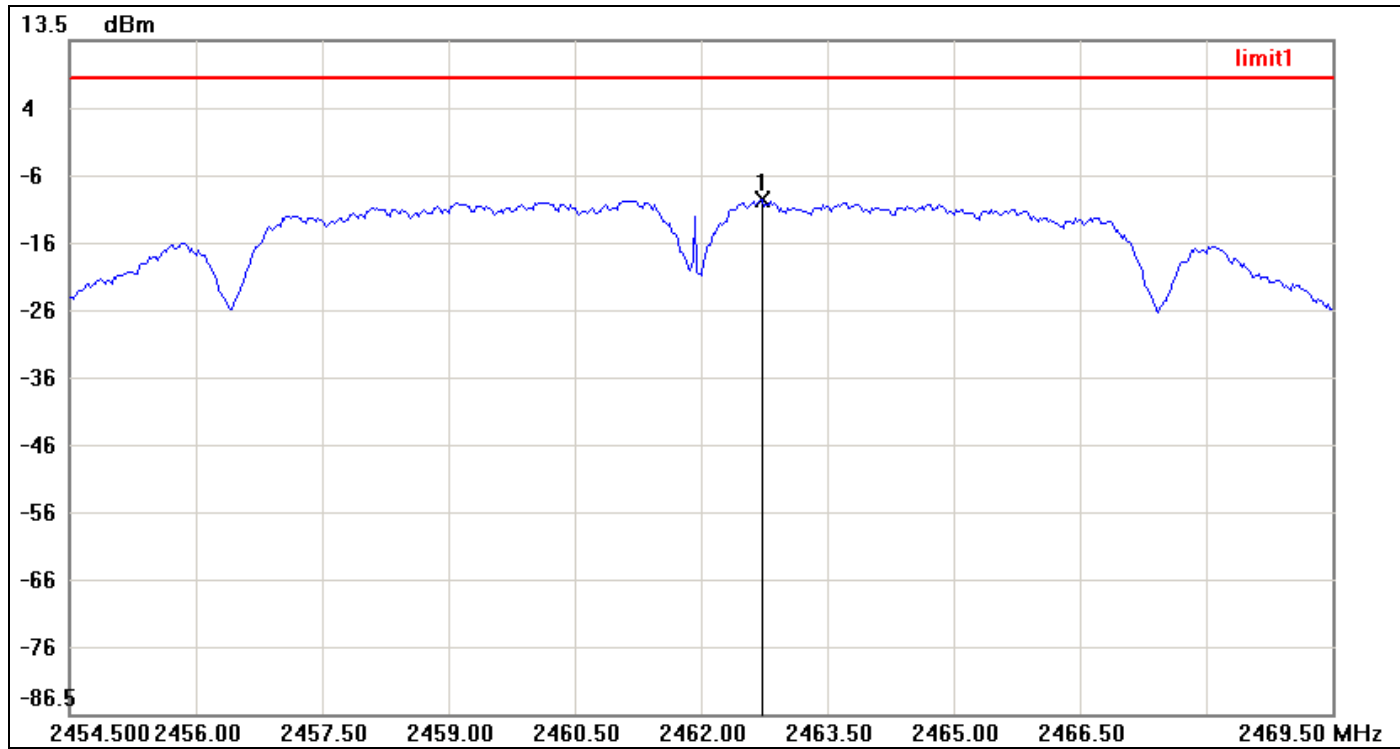

No.	Frequency(MHz)	Result(dBm)	Limit(dBm)	Margin(dBm)
1	2462.7250	-10.15	8.00	-18.15



IEEE 802.11g mode

PPSD (CH Low)

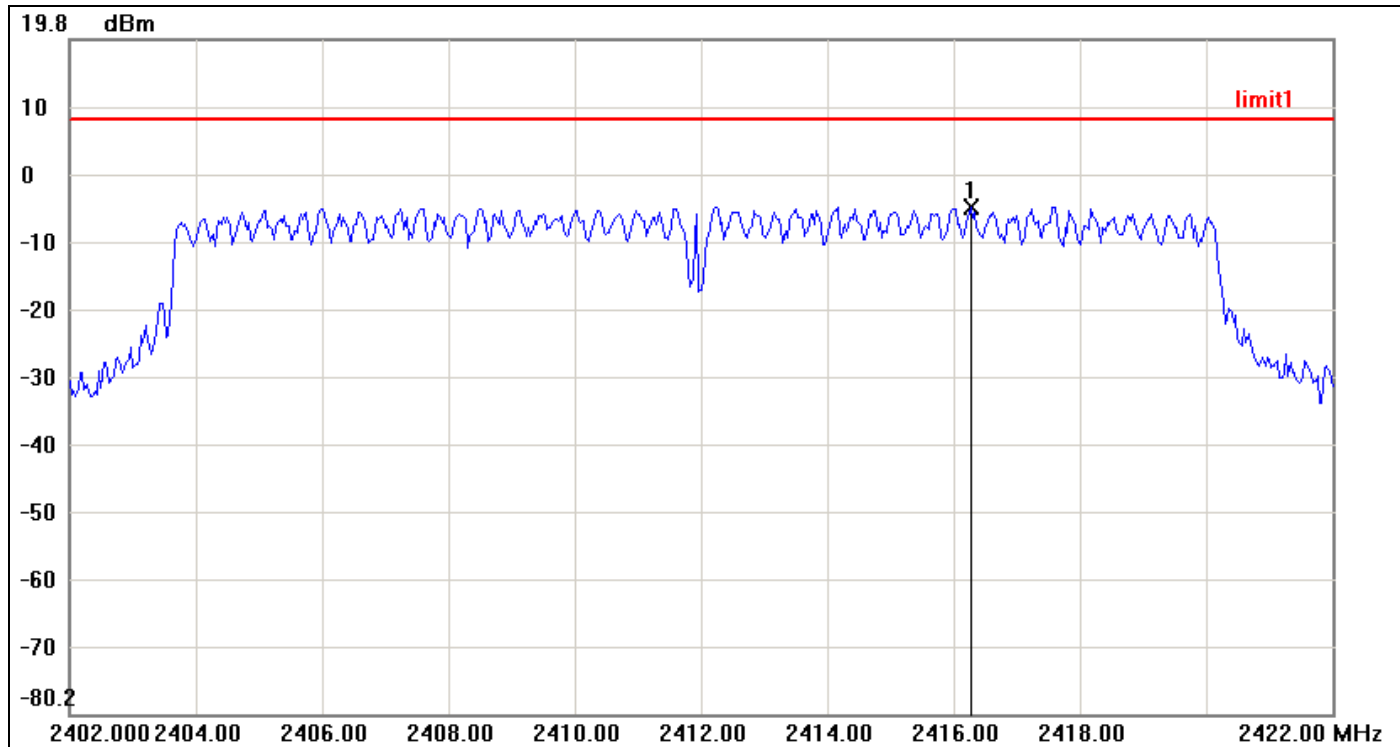

No.	Frequency(MHz)	Result(dBm)	Limit(dBm)	Margin(dBm)
1	2416.2667	-5.04	8.00	-13.04



PPSD (CH Mid)

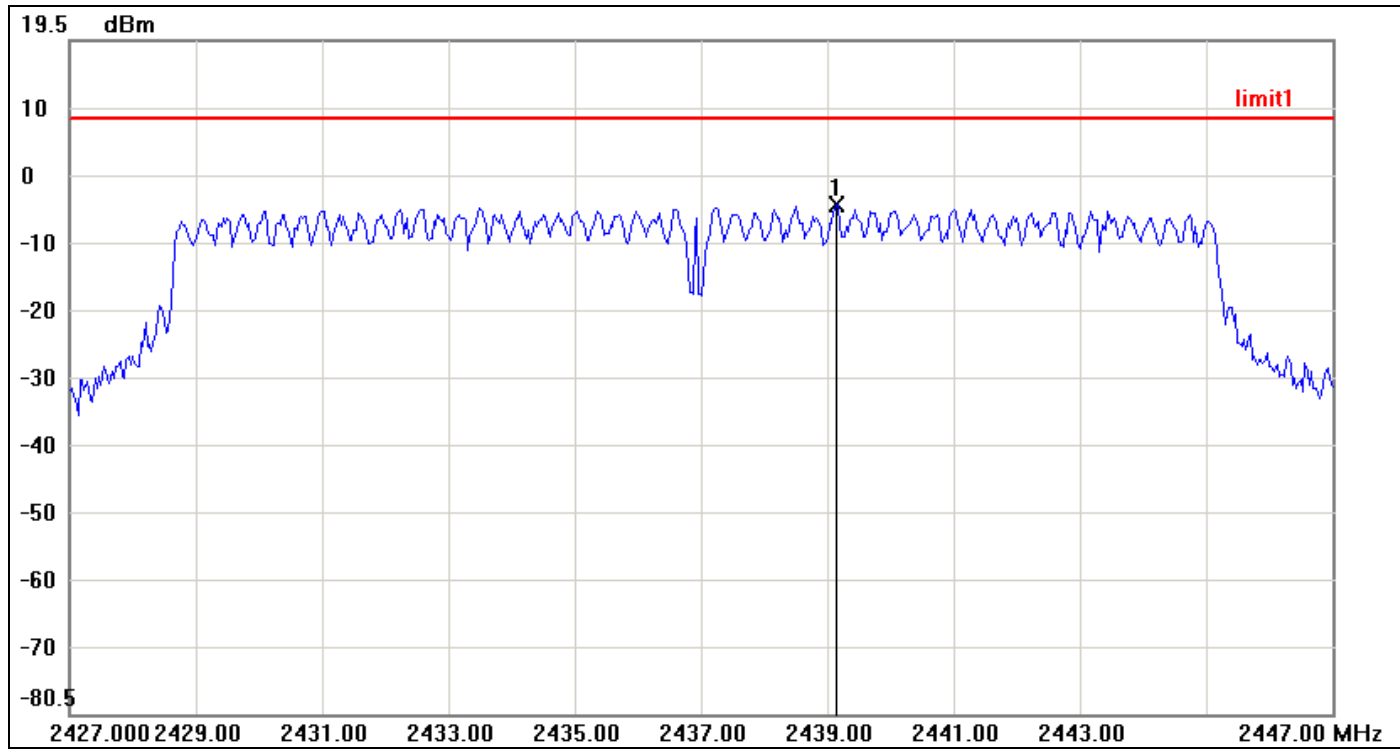

No.	Frequency(MHz)	Result(dBm)	Limit(dBm)	Margin(dBm)
1	2439.1333	-4.89	8.00	-12.89



PPSD (CH High)

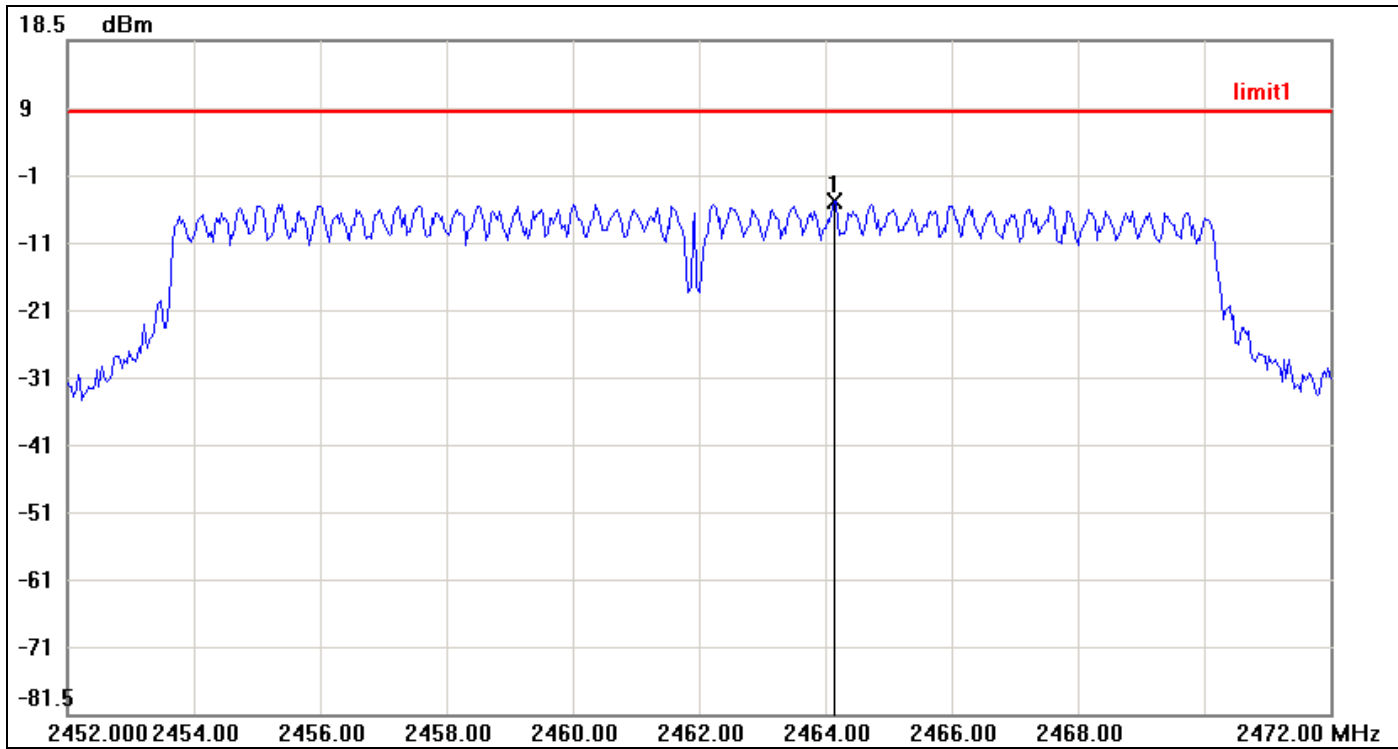

No.	Frequency(MHz)	Result(dBm)	Limit(dBm)	Margin(dBm)
1	2464.1333	-5.47	8.00	-13.47



IEEE 802.11n HT 20 mode / Chain 0

PPSD (CH Low)

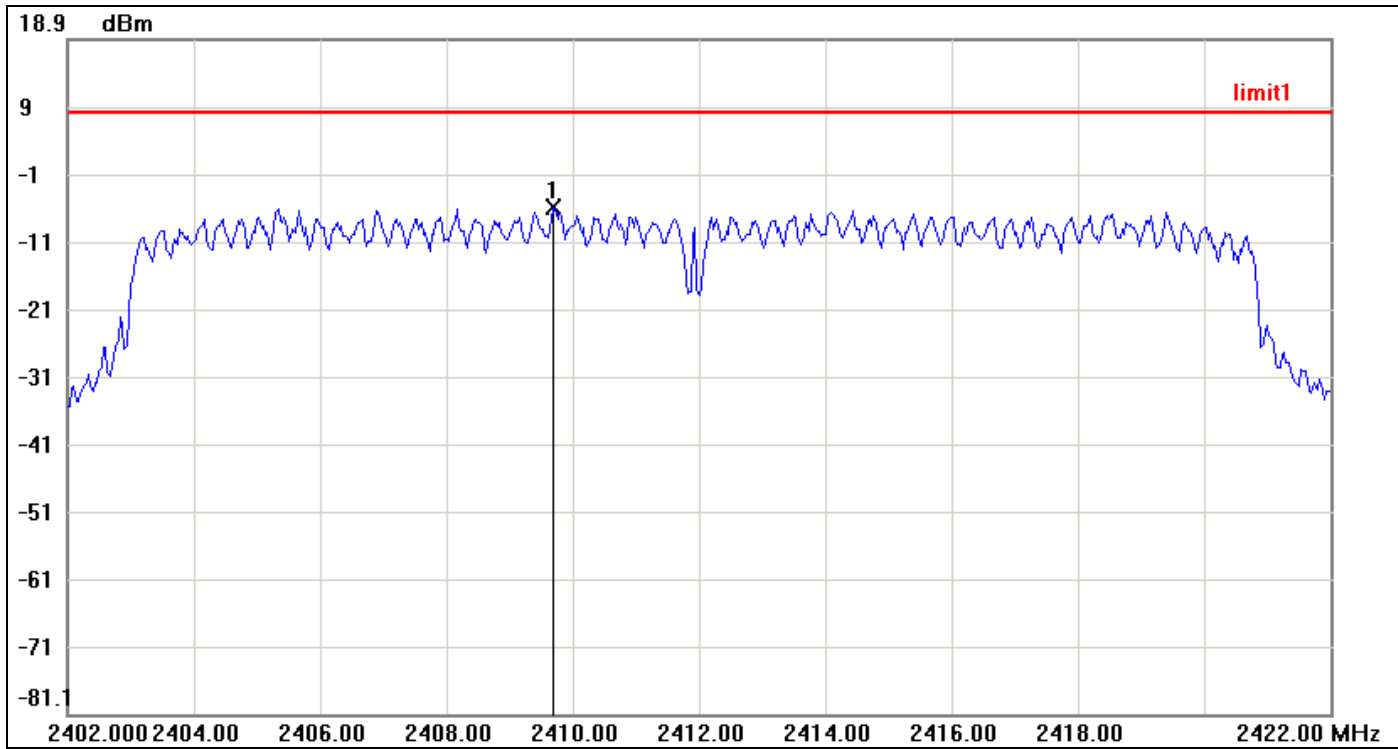

No.	Frequency(MHz)	Result(dBm)	Limit(dBm)	Margin(dBm)
1	2409.7000	-5.90	8.00	-13.90



PPSD (CH Mid)

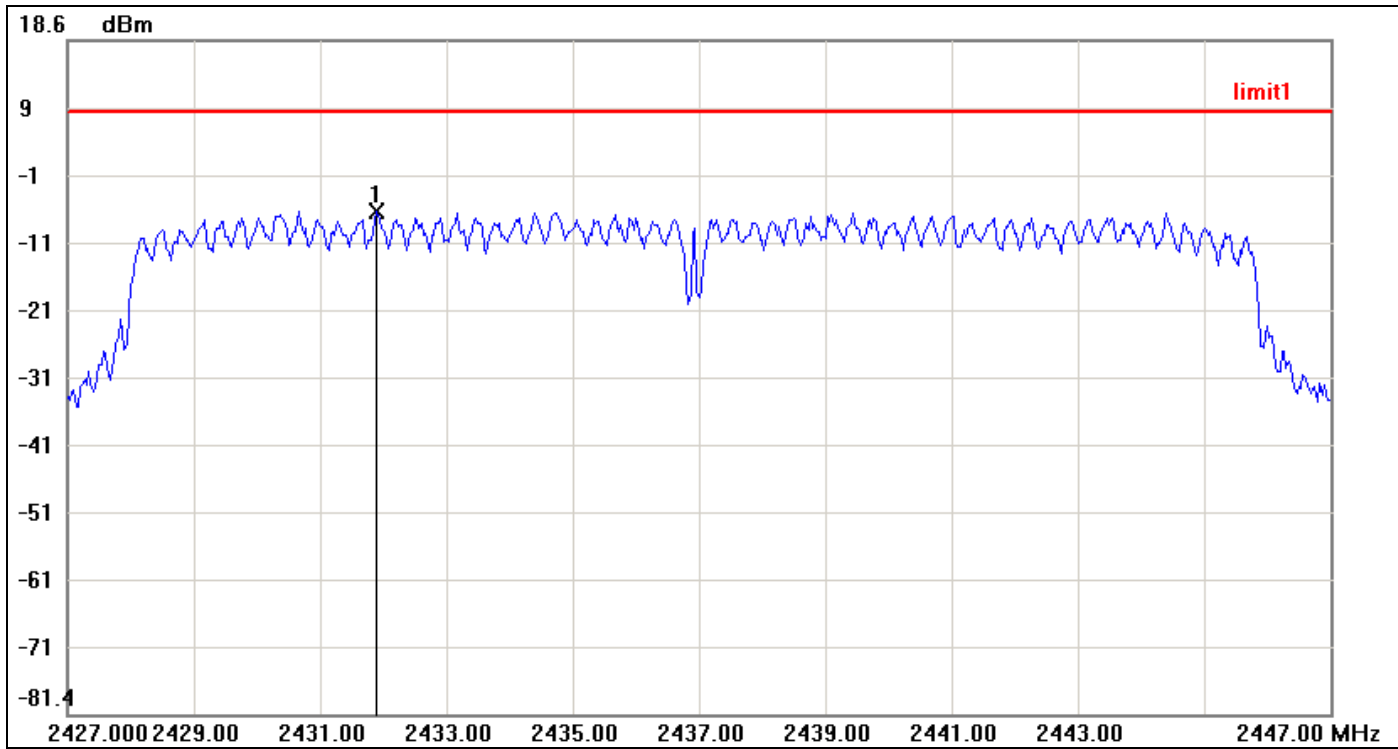

No.	Frequency(MHz)	Result(dBm)	Limit(dBm)	Margin(dBm)
1	2431.9000	-6.82	8.00	-14.82



PPSD (CH High)

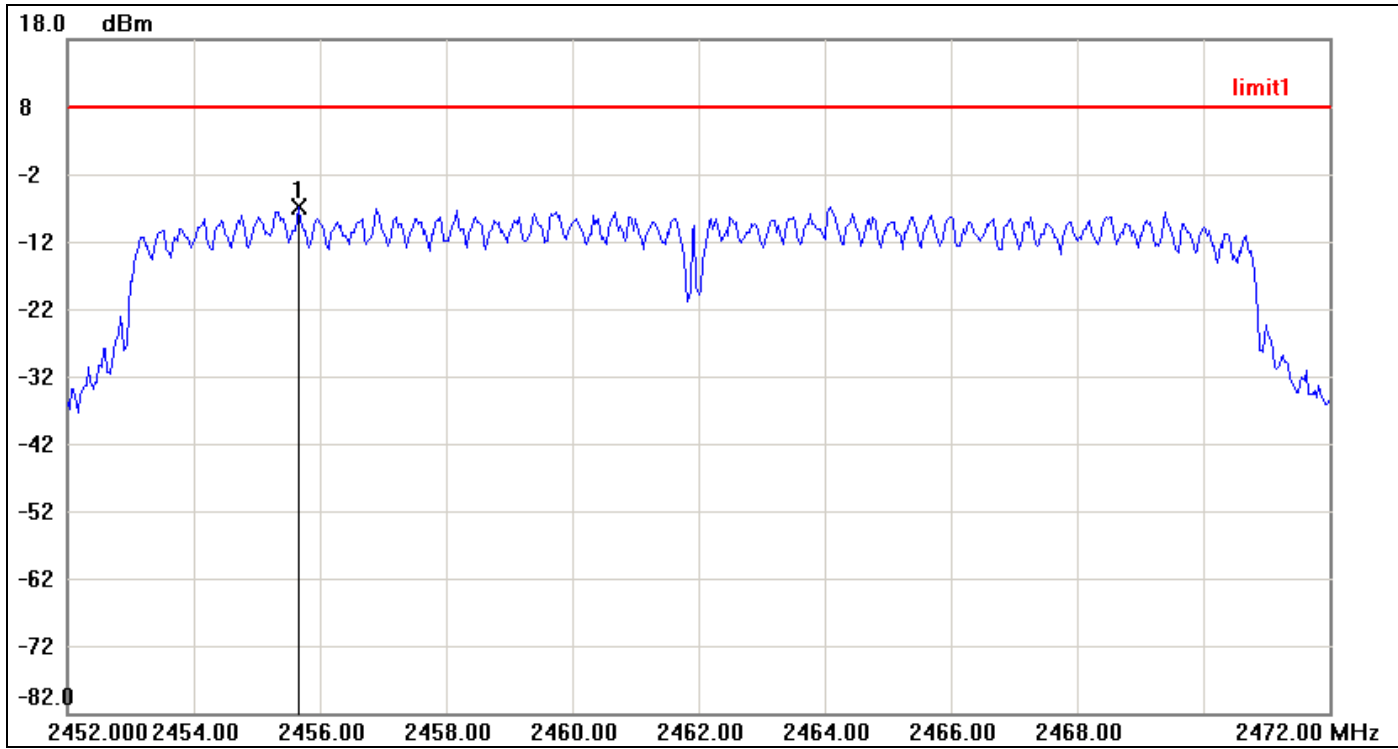

No.	Frequency(MHz)	Result(dBm)	Limit(dBm)	Margin(dBm)
1	2455.6667	-6.80	8.00	-14.80



IEEE 802.11n HT 20 mode / Chain 1

PPSD (CH Low)

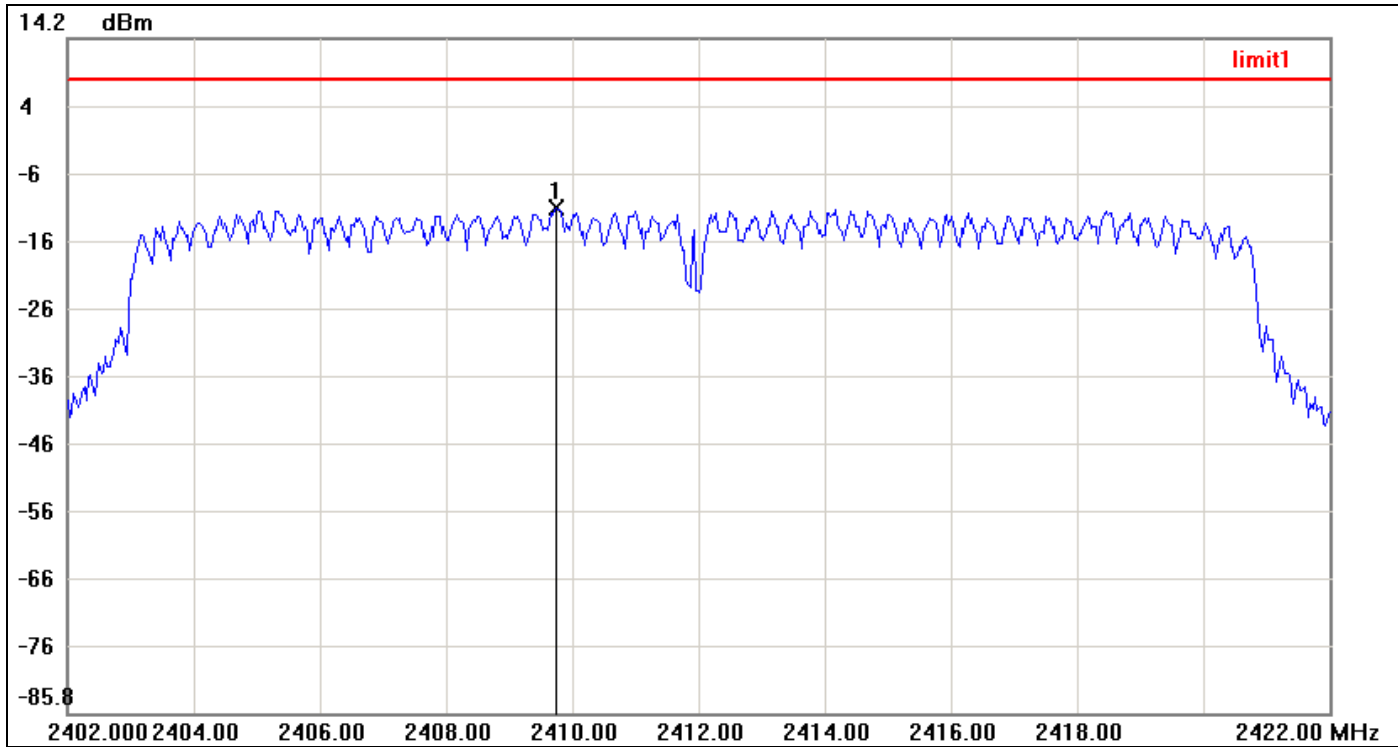

No.	Frequency(MHz)	Result(dBm)	Limit(dBm)	Margin(dBm)
1	2409.7333	-11.07	8.00	-19.07



PPSD (CH Mid)

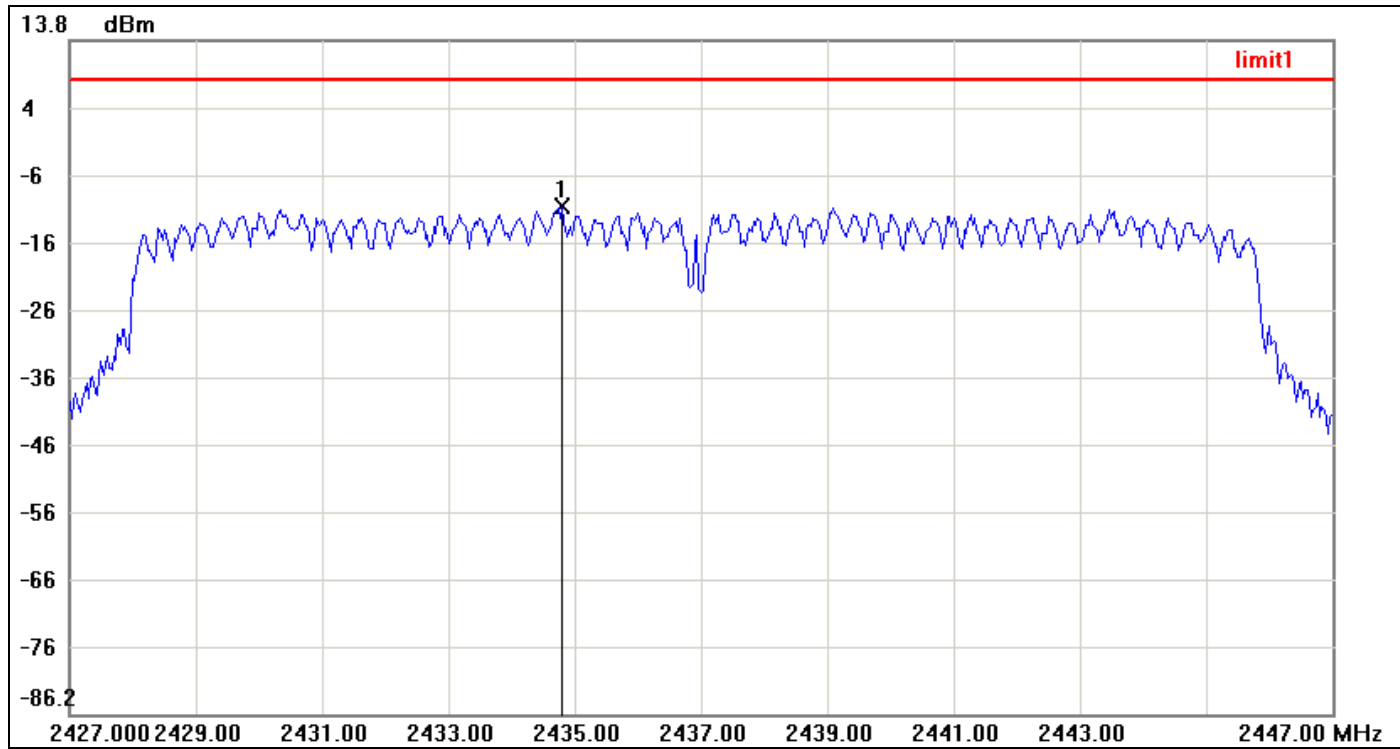

No.	Frequency(MHz)	Result(dBm)	Limit(dBm)	Margin(dBm)
1	2434.8000	-10.66	8.00	-18.66



PPSD (CH High)

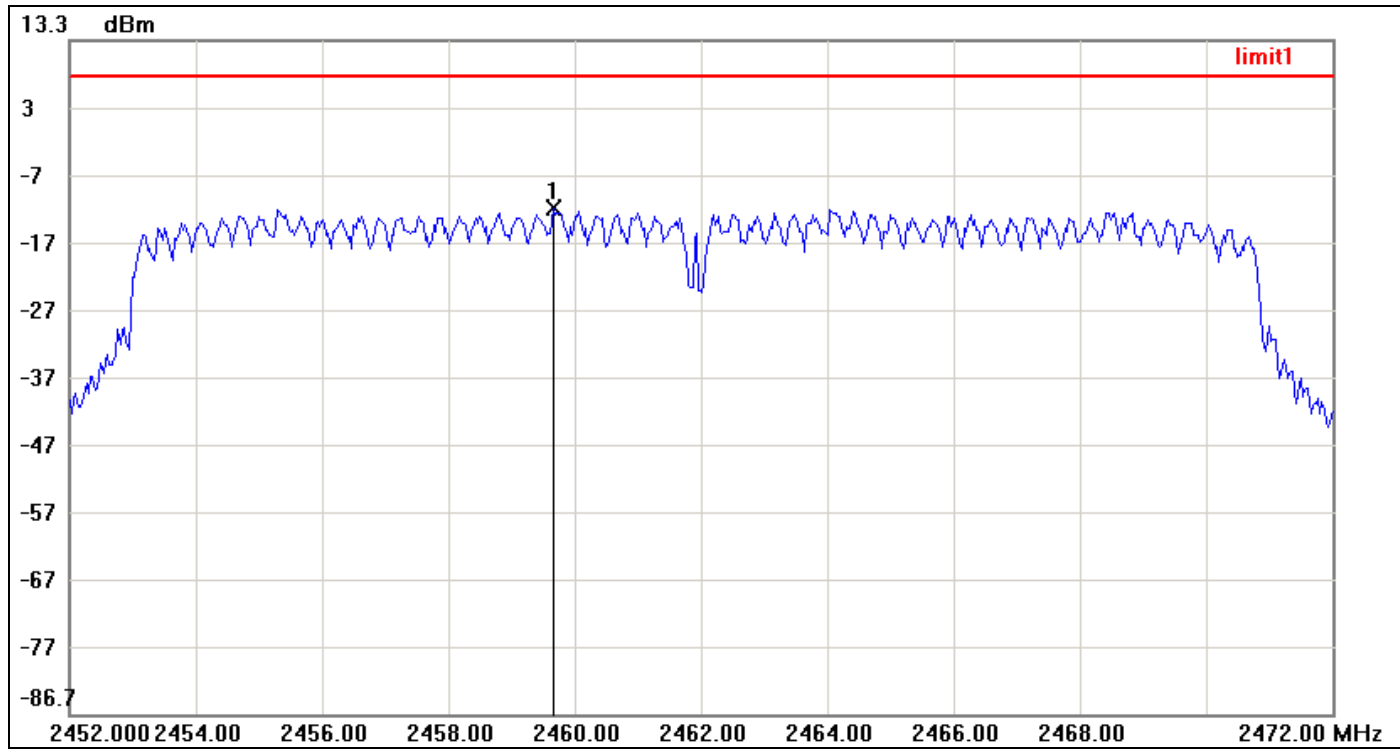

No.	Frequency(MHz)	Result(dBm)	Limit(dBm)	Margin(dBm)
1	2459.6667	-11.60	8.00	-19.60



IEEE 802.11n HT 40 mode / Chain 0

PPSD (CH Low)

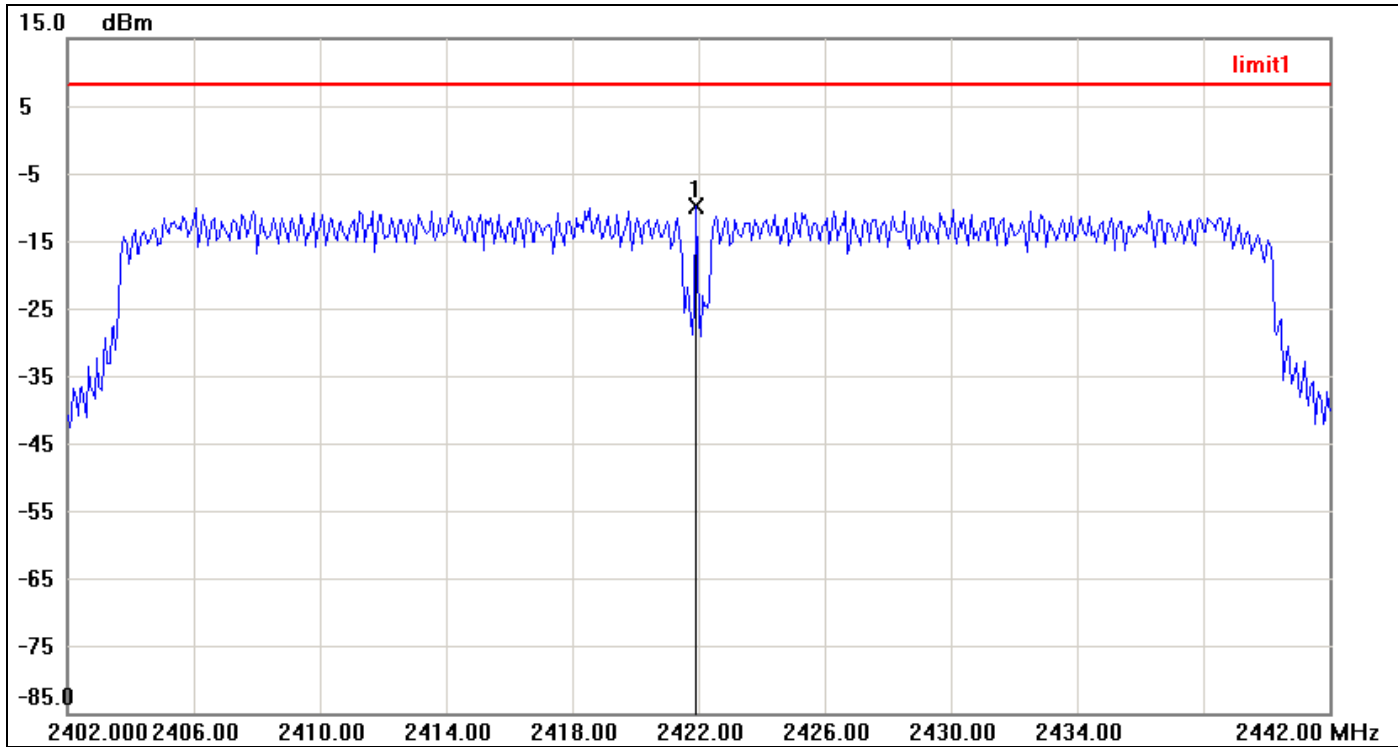

No.	Frequency(MHz)	Result(dBm)	Limit(dBm)	Margin(dBm)
1	2421.9333	-9.90	8.00	-17.90



PPSD (CH Mid)

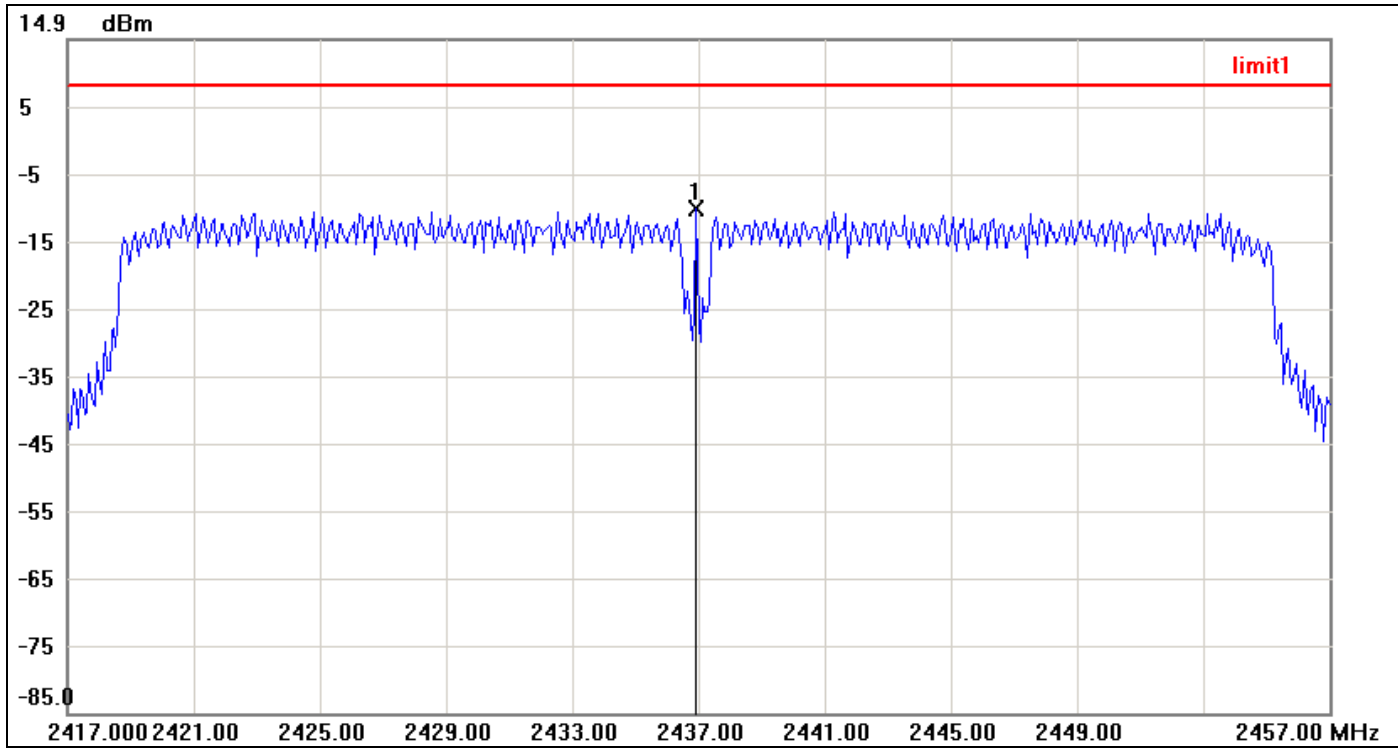

No.	Frequency(MHz)	Result(dBm)	Limit(dBm)	Margin(dBm)
1	2436.9333	-10.19	8.00	-18.19



PPSD (CH High)

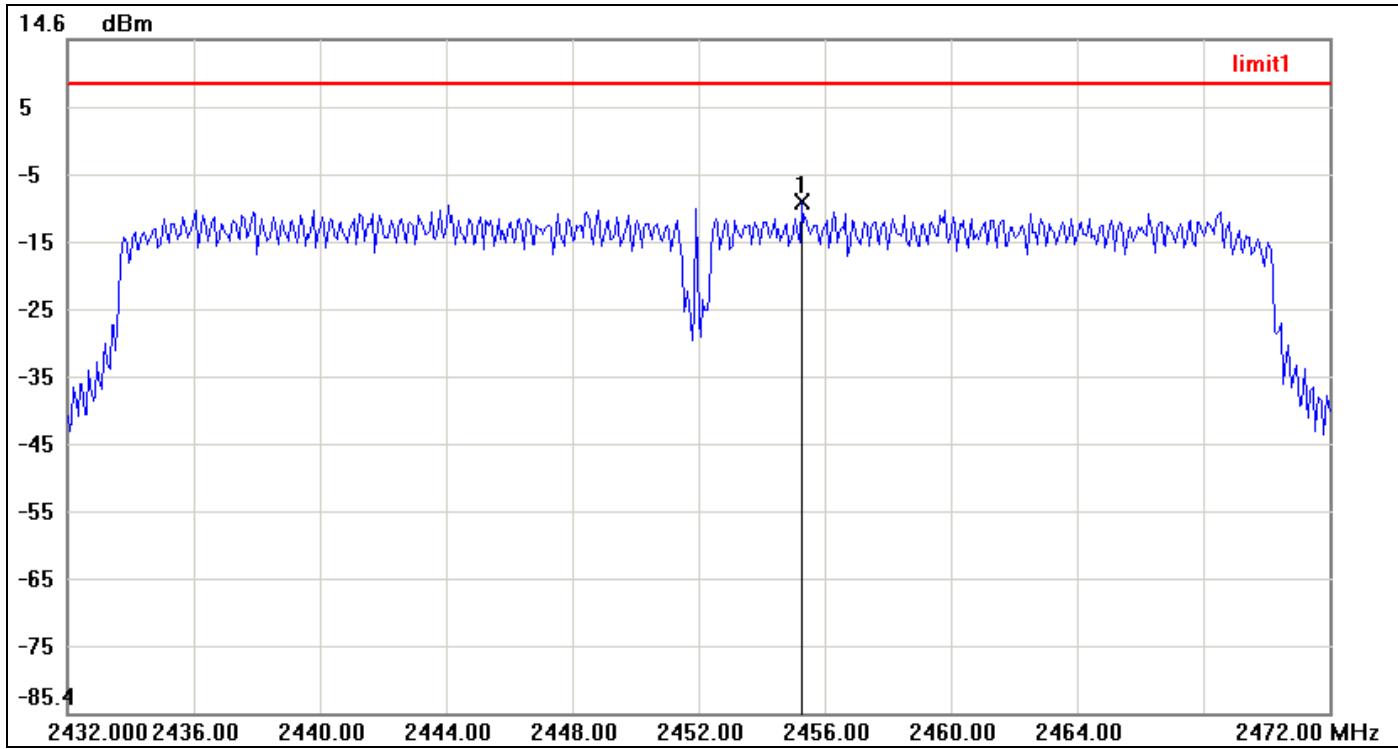

No.	Frequency(MHz)	Result(dBm)	Limit(dBm)	Margin(dBm)
1	2455.2667	-9.51	8.00	-17.51



IEEE 802.11n HT 40 mode / Chain 1

PPSD (CH Low)

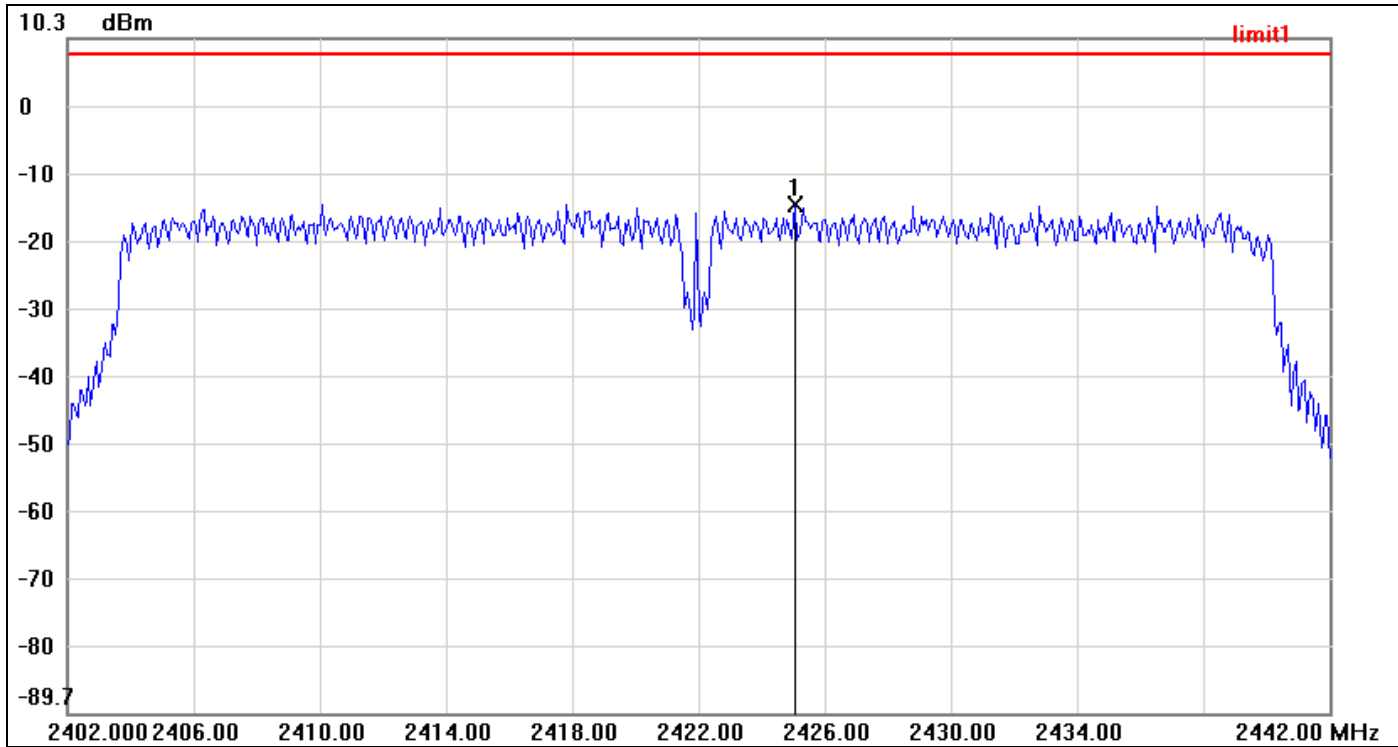

No.	Frequency(MHz)	Result(dBm)	Limit(dBm)	Margin(dBm)
1	2425.0667	-14.26	8.00	-22.26



PPSD (CH Mid)

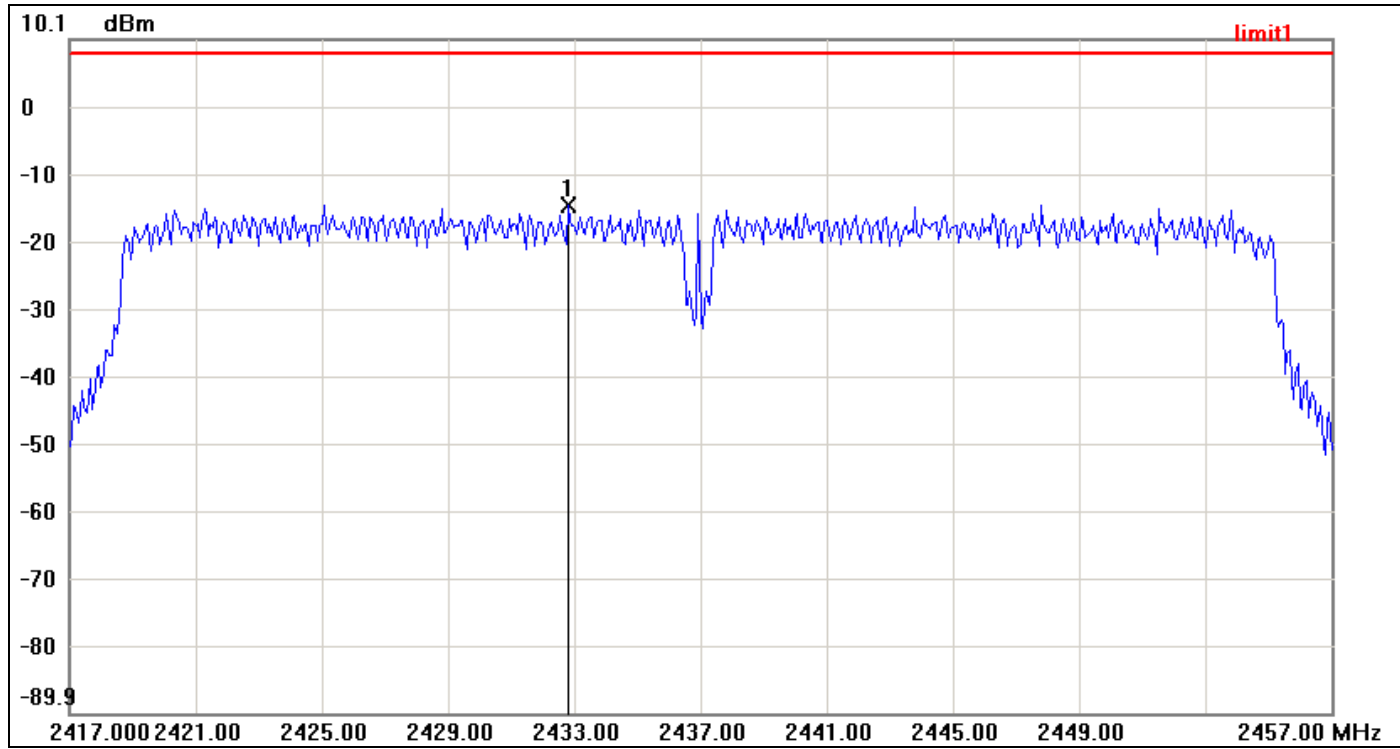

No.	Frequency(MHz)	Result(dBm)	Limit(dBm)	Margin(dBm)
1	2432.8000	-14.56	8.00	-22.56



PPSD (CH High)

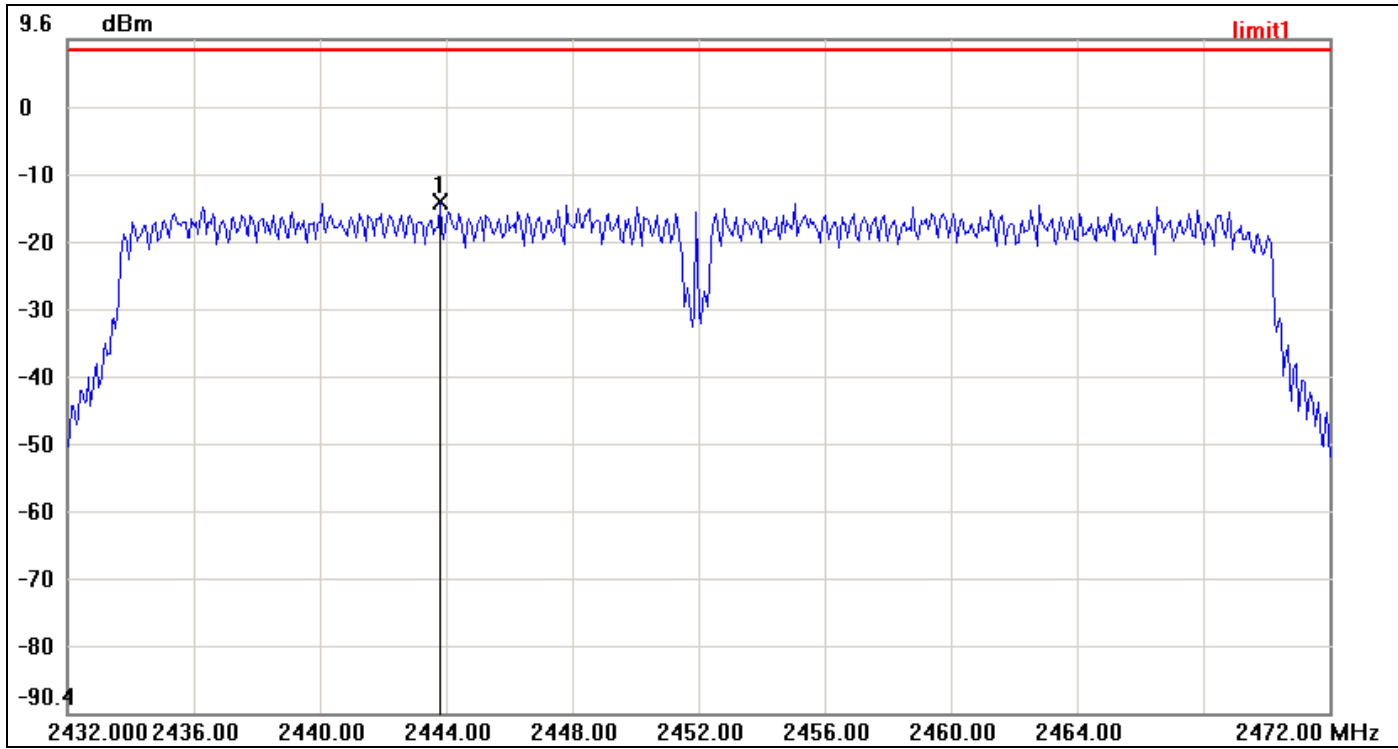

No.	Frequency(MHz)	Result(dBm)	Limit(dBm)	Margin(dBm)
1	2443.8000	-14.65	8.00	-22.65



7.5 SPURIOUS EMISSIONS

7.5.1 Conducted Measurement

LIMIT

According to §15.247(d), in any 100 kHz bandwidth outside the frequency bands in which the spread spectrum intentional radiator is operating, the radio frequency power that is produced by the intentional radiator shall be at least 20 dB below that in the 100 kHz bandwidth within the band that contains the highest level of the desired power, based on either an RF conducted or a radiated measurement, provided the transmitter demonstrates compliance with the peak conducted power limits. In addition, radiated emissions which fall in the restricted bands, as defined in §15.205(a), must also comply with the radiated emission limits specified in 15.209(a) (see Section 15.205(c)).

Test Configuration

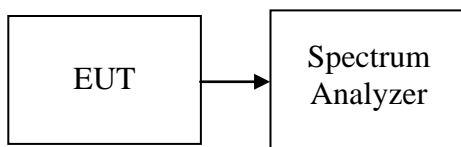

TEST PROCEDURE

Conducted RF measurements of the transmitter output were made to confirm that the EUT antenna port conducted emissions meet the specified limit and to identify any spurious signals that require further investigation or measurements on the radiated emissions site.

The transmitter output is connected to the spectrum analyzer. The resolution bandwidth is set to 100 kHz. The video bandwidth is set to 100 kHz.

Measurements are made over the 13GHz to 26GHz range with the transmitter set to the lowest, middle, and highest channels.

TEST RESULTS

No non-compliance noted.



Test Plot

IEEE 802.11b mode

CH Low

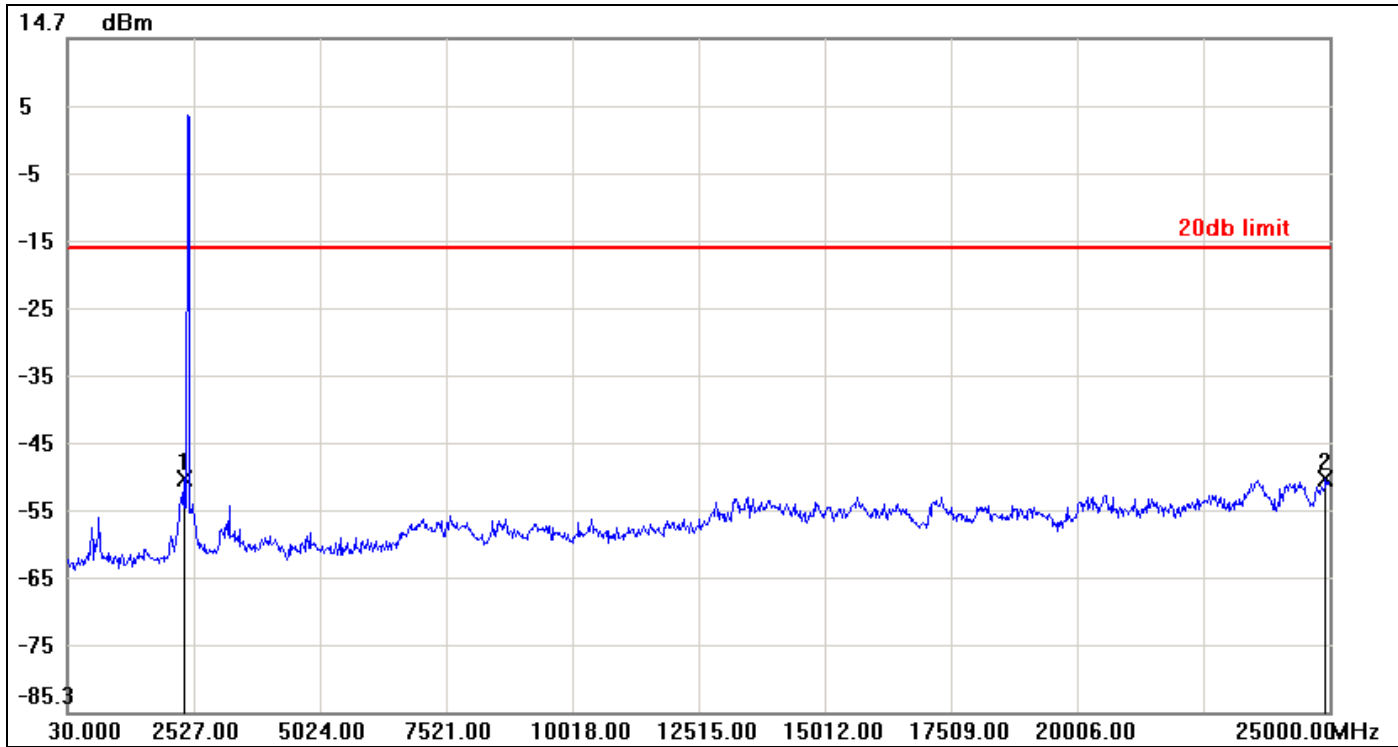

No.	Frequency(MHz)	Result(dBm)	Limit(dBm)	Margin(dBm)
1	2327.2400	-50.57	-16.39	-34.18
2	24925.0900	-50.72	-16.39	-34.33



CH Mid

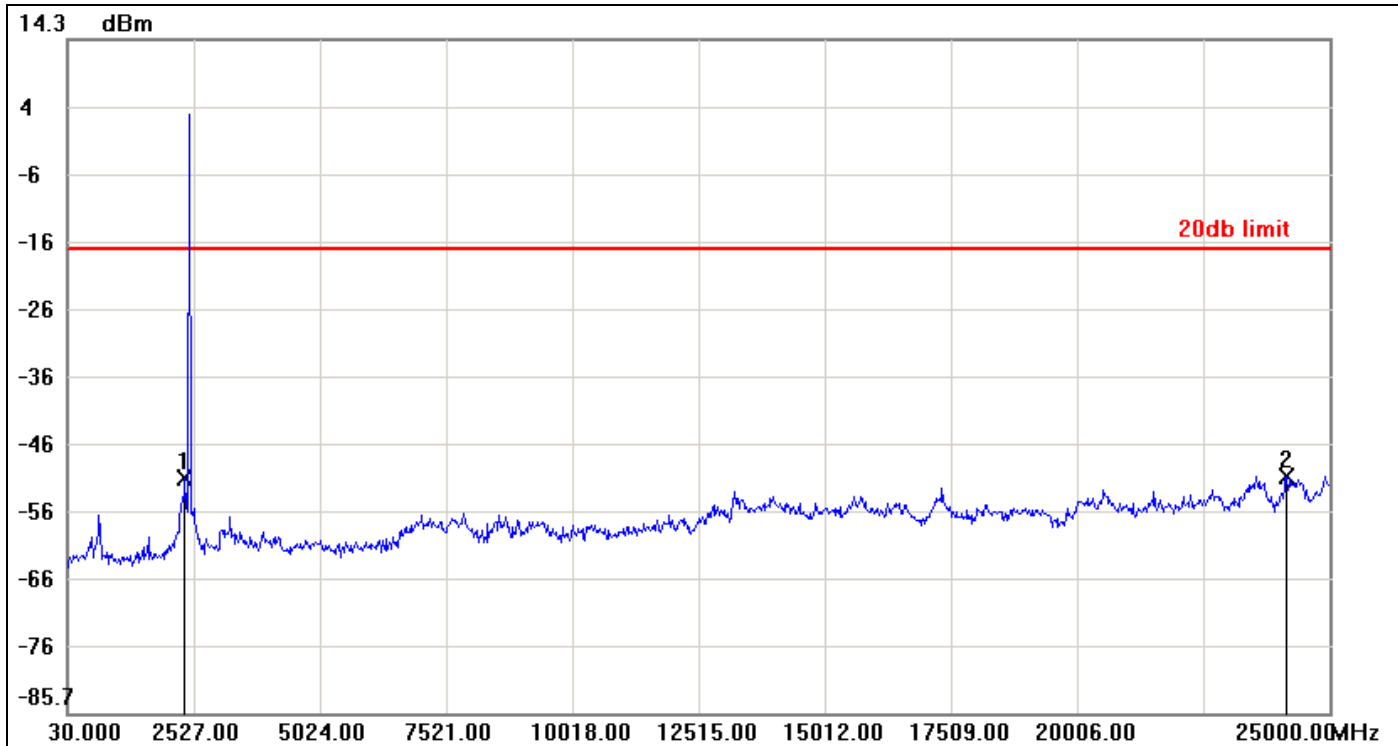

No.	Frequency(MHz)	Result(dBm)	Limit(dBm)	Margin(dBm)
1	2352.2100	-50.94	-16.92	-34.02
2	24151.0200	-50.55	-16.92	-33.63



CH High

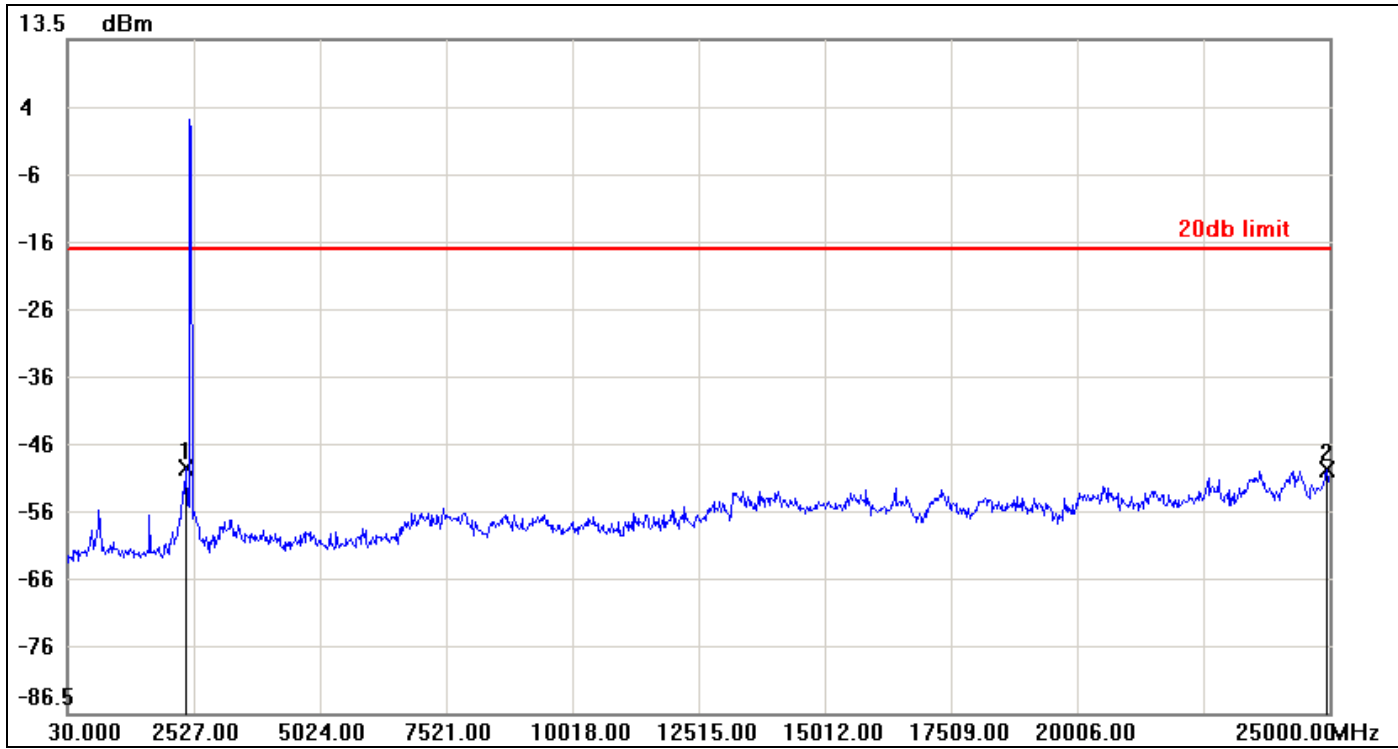

No.	Frequency(MHz)	Result(dBm)	Limit(dBm)	Margin(dBm)
1	2377.1800	-50.10	-17.67	-32.43
2	24950.0600	-50.42	-17.67	-32.75



IEEE 802.11g mode

CH Low

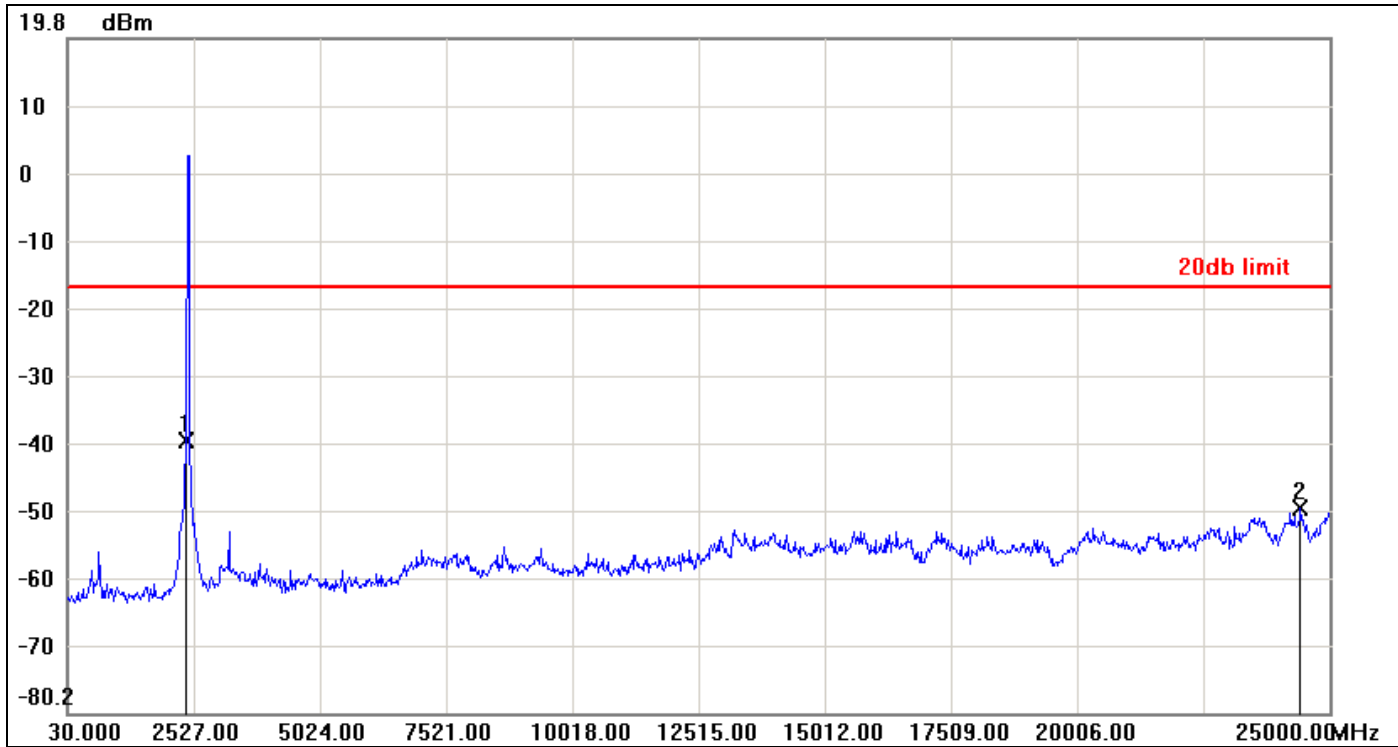

No.	Frequency(MHz)	Result(dBm)	Limit(dBm)	Margin(dBm)
1	2377.1800	-39.74	-17.04	-22.70
2	24425.6900	-49.70	-17.04	-32.66



CH Mid

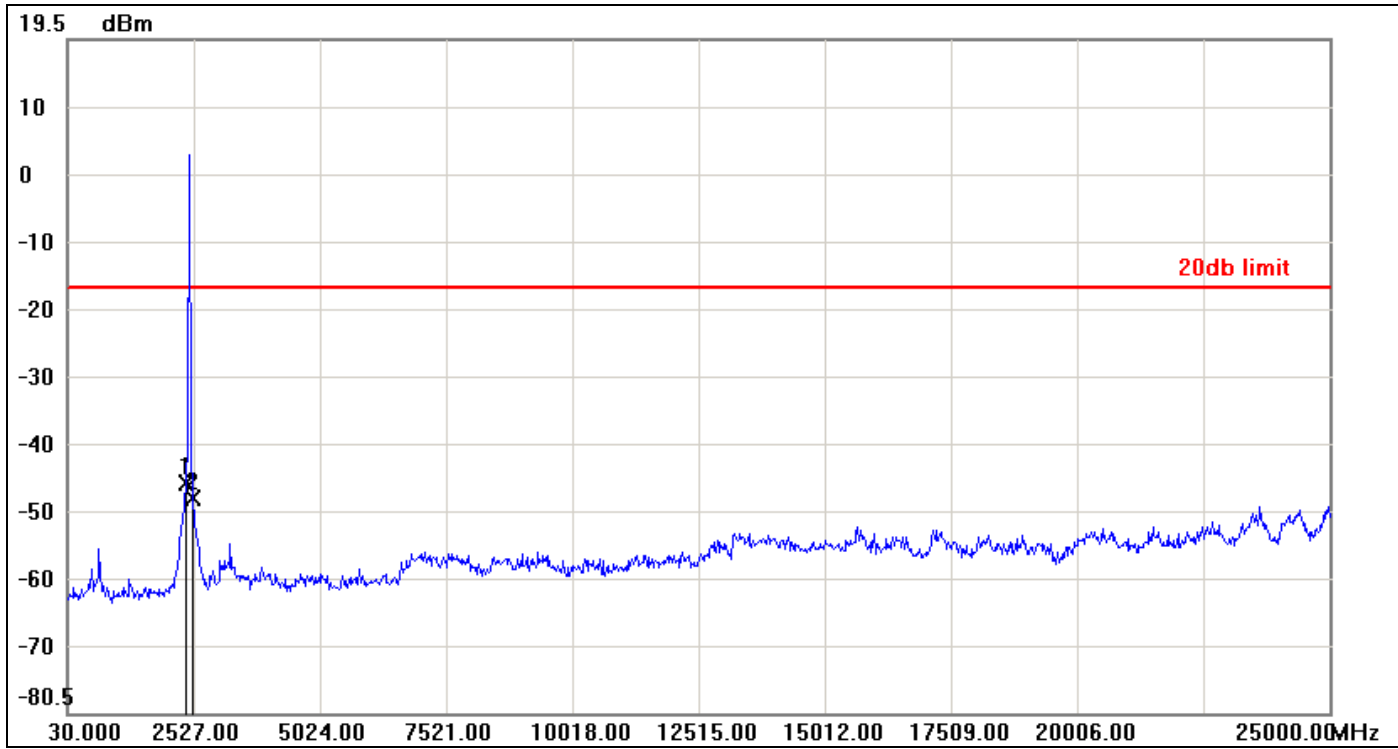

No.	Frequency(MHz)	Result(dBm)	Limit(dBm)	Margin(dBm)
1	2377.1800	-46.40	-17.40	-29.00
2	2502.0300	-48.54	-17.40	-31.14



CH High

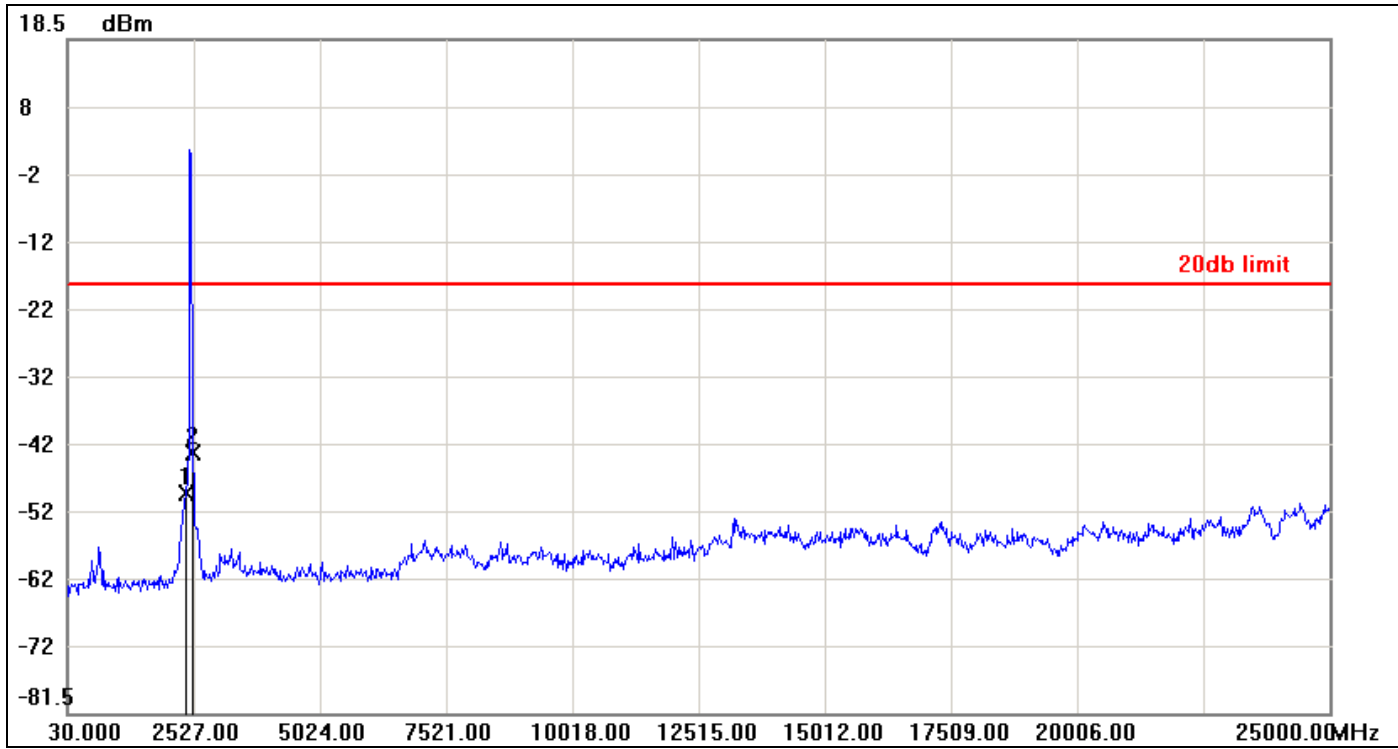

No.	Frequency(MHz)	Result(dBm)	Limit(dBm)	Margin(dBm)
1	2377.1800	-48.85	-17.93	-30.92
2	2502.0300	-42.85	-17.93	-24.92



IEEE 802.11n HT 20 mode / Chain 0

CH Low

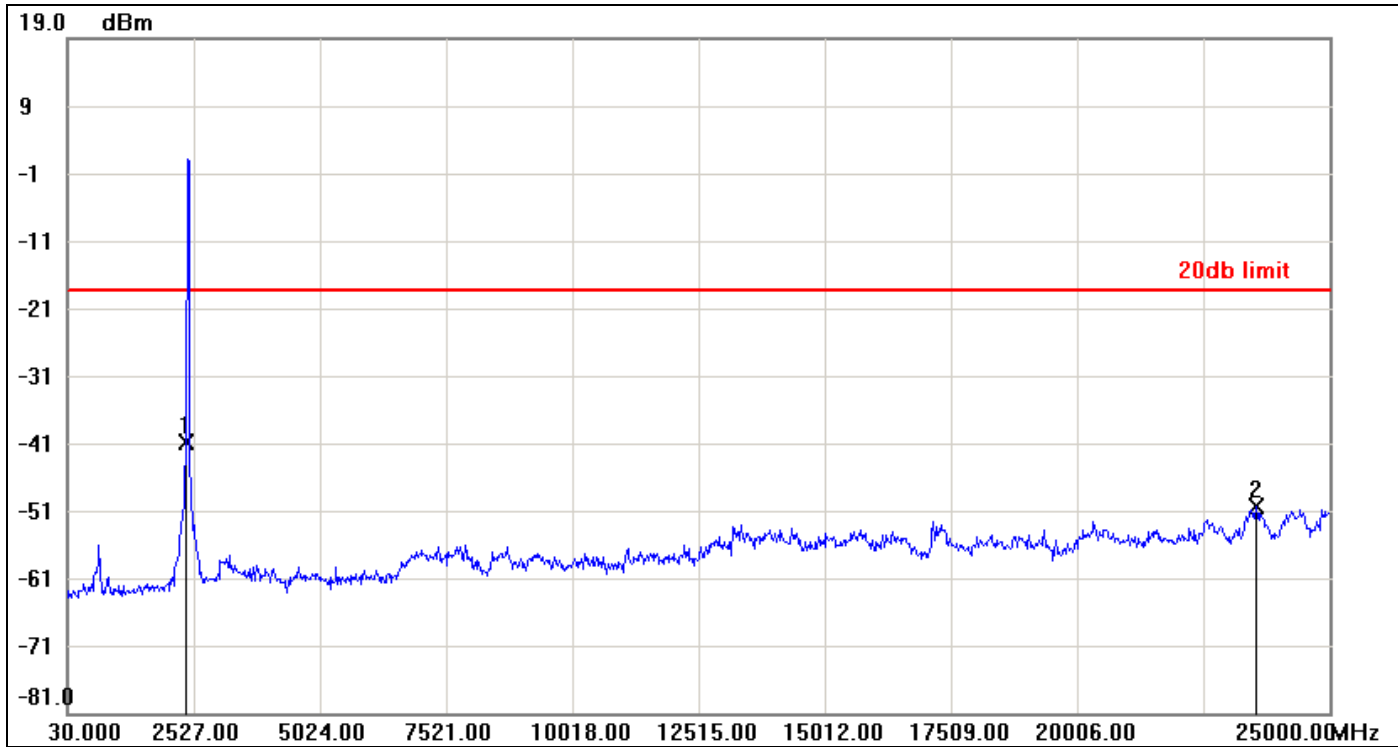

No.	Frequency(MHz)	Result(dBm)	Limit(dBm)	Margin(dBm)
1	2377.1800	-40.76	-18.44	-22.32
2	23551.7400	-50.42	-18.44	-31.98



CH Mid

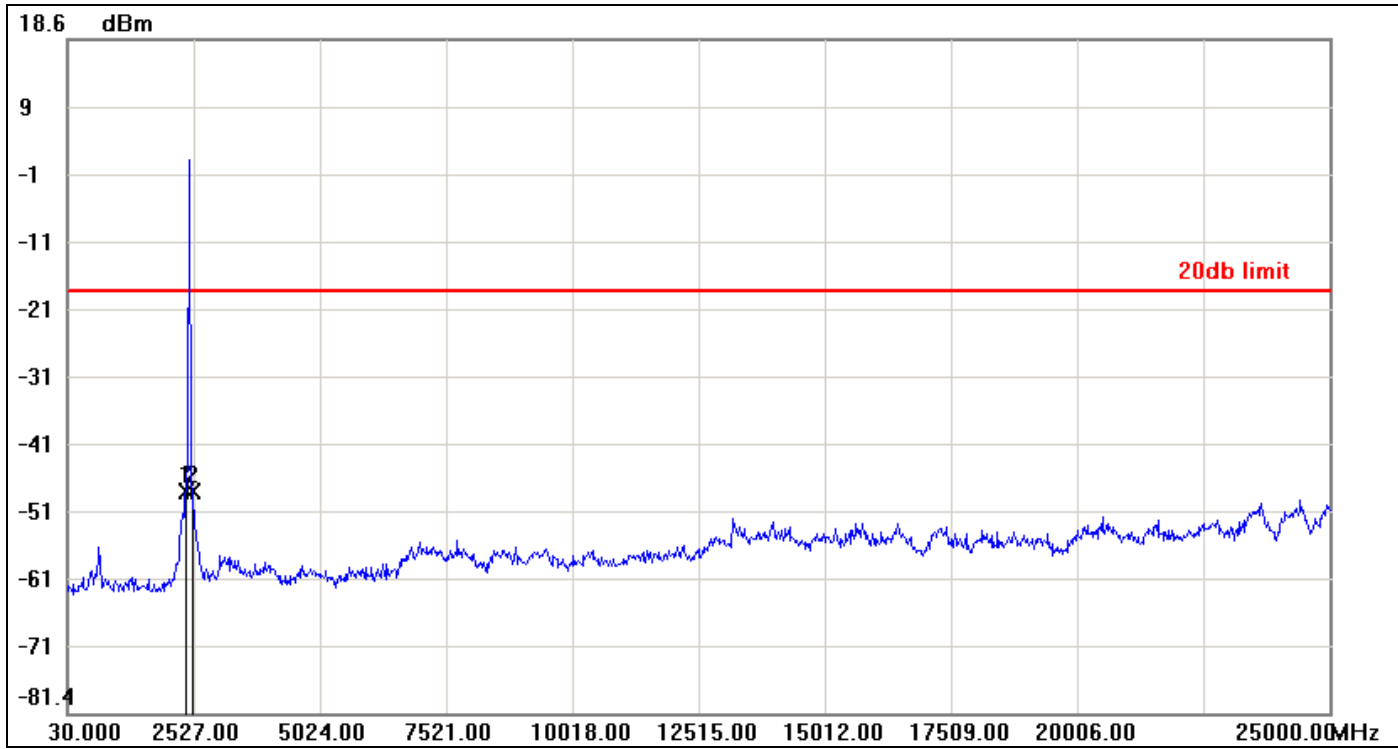

No.	Frequency(MHz)	Result(dBm)	Limit(dBm)	Margin(dBm)
1	2377.1800	-48.48	-18.83	-29.65
2	2502.0300	-48.67	-18.83	-29.84



CH High

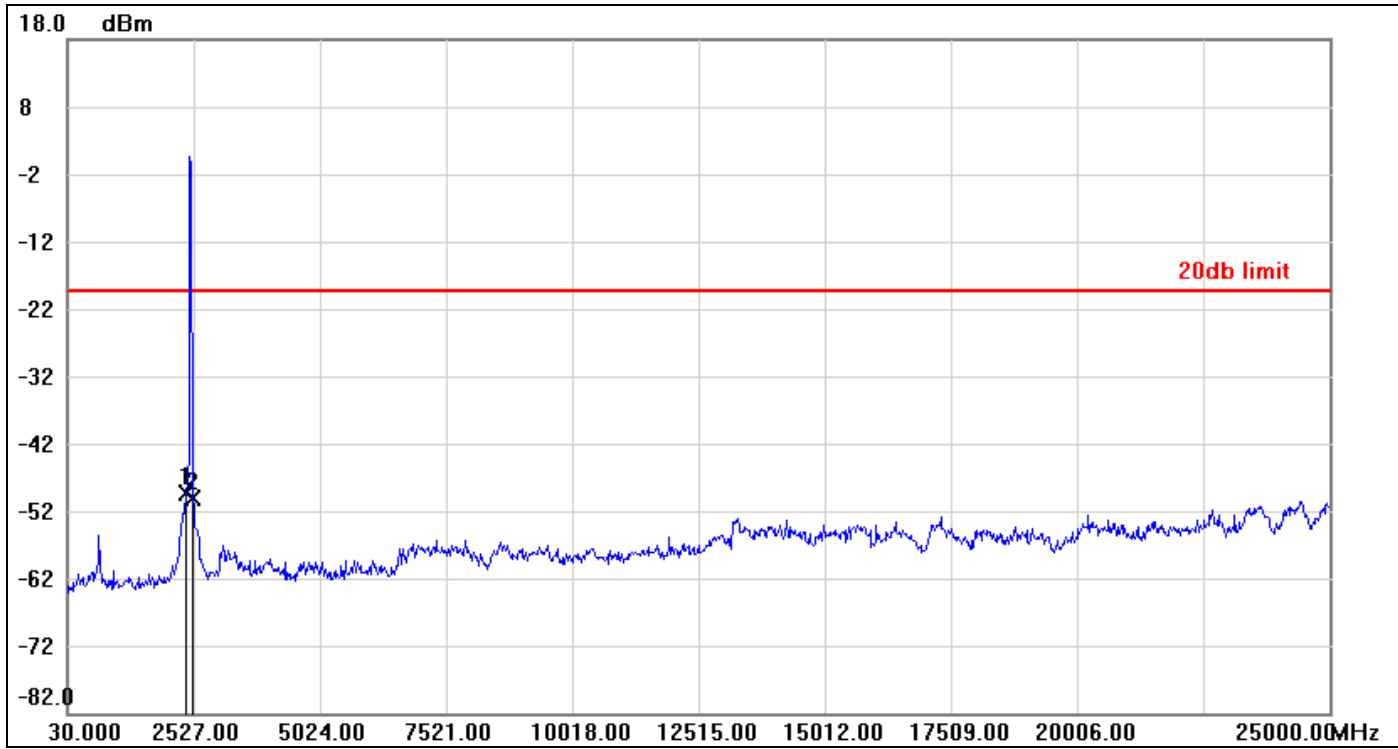

No.	Frequency(MHz)	Result(dBm)	Limit(dBm)	Margin(dBm)
1	2377.1800	-49.27	-19.46	-29.81
2	2502.0300	-50.16	-19.46	-30.70



IEEE 802.11n HT 20 mode / Chain 1

CH Low

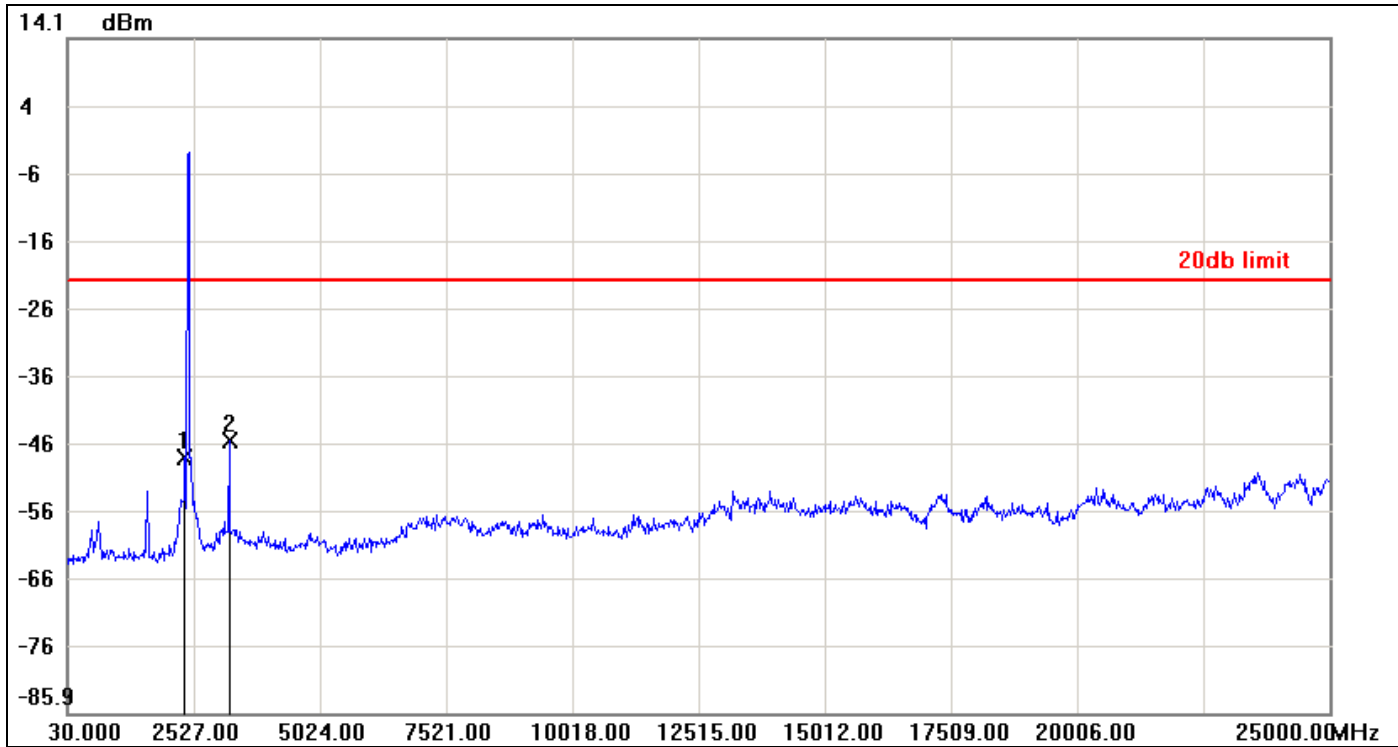

No.	Frequency(MHz)	Result(dBm)	Limit(dBm)	Margin(dBm)
1	2352.2100	-47.95	-21.89	-26.06
2	3226.1600	-45.43	-21.89	-23.54



CH Mid

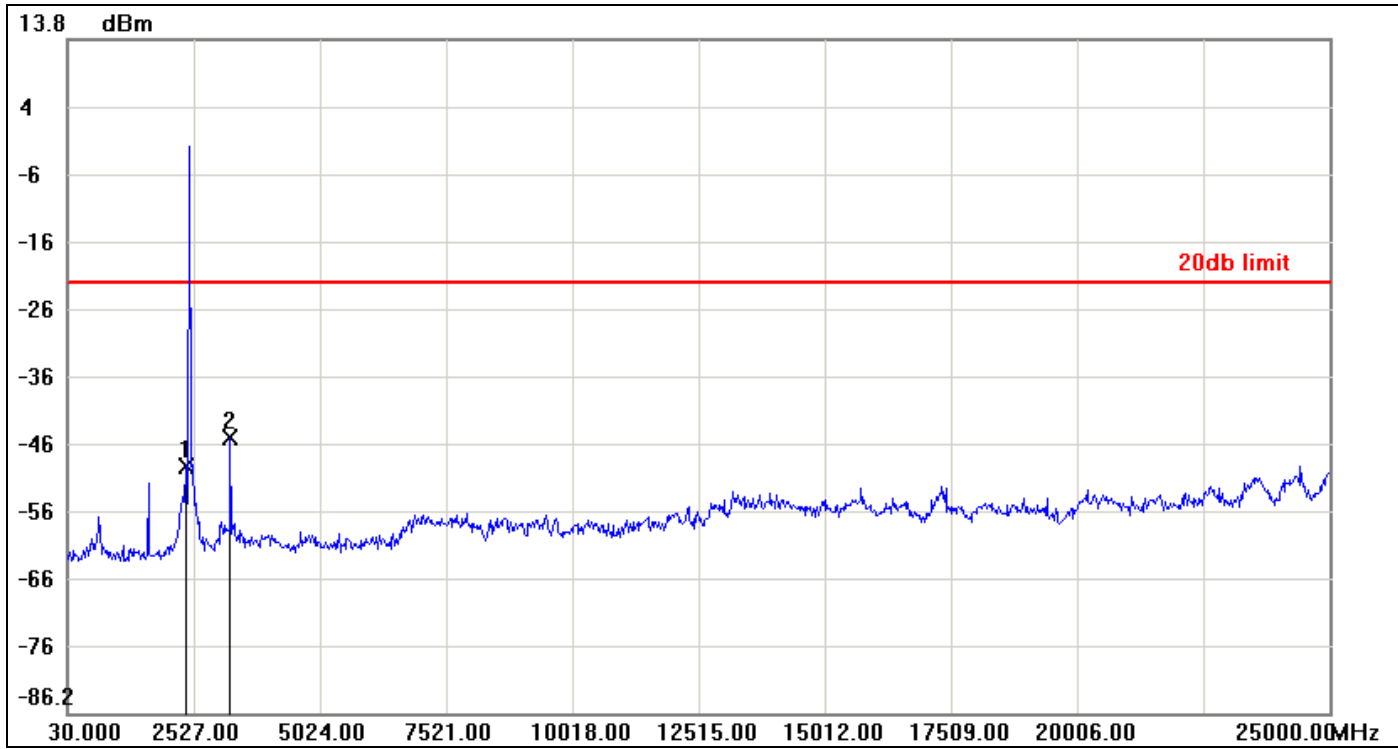

No.	Frequency(MHz)	Result(dBm)	Limit(dBm)	Margin(dBm)
1	2377.1800	-49.65	-22.33	-27.32
2	3251.1300	-45.31	-22.33	-22.98



CH High

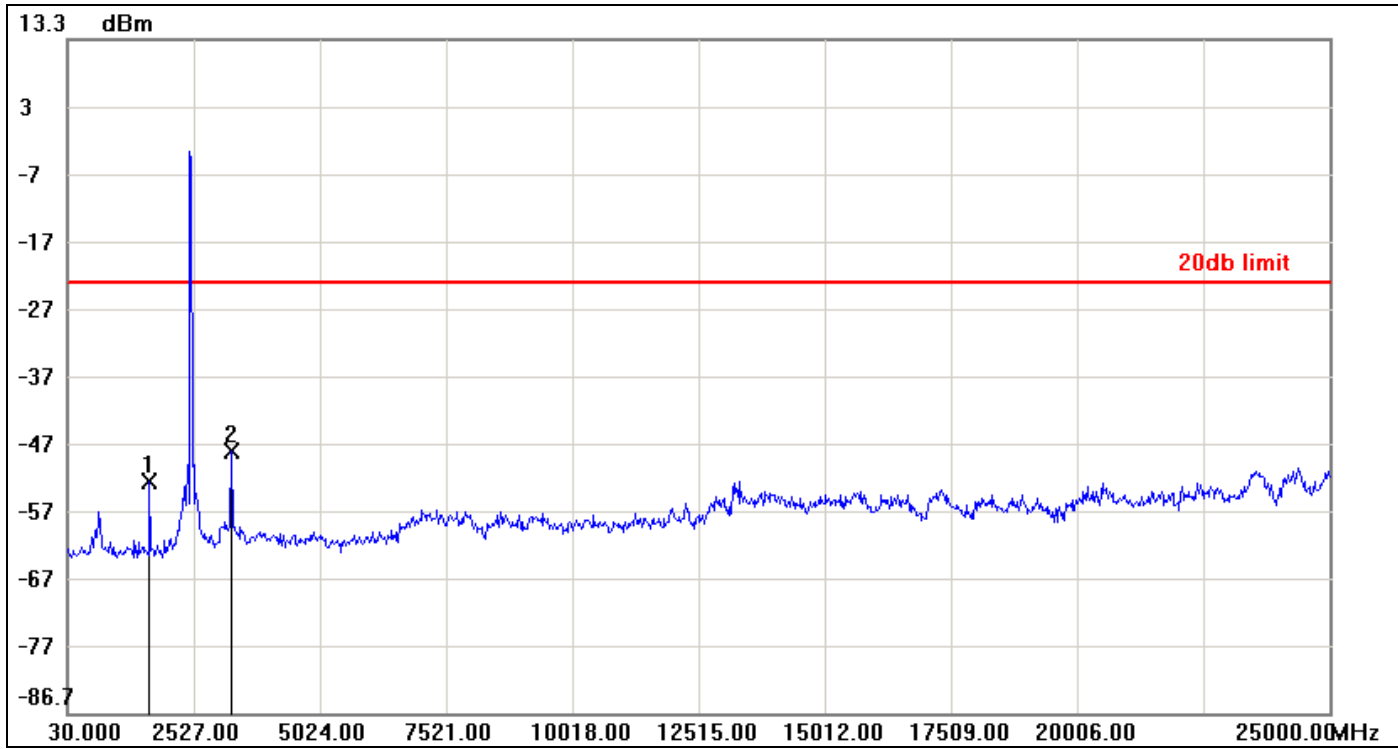

No.	Frequency(MHz)	Result(dBm)	Limit(dBm)	Margin(dBm)
1	1653.0500	-52.24	-22.71	-29.53
2	3276.1000	-47.73	-22.71	-25.02



IEEE 802.11n HT 40 mode / Chain 0

CH Low

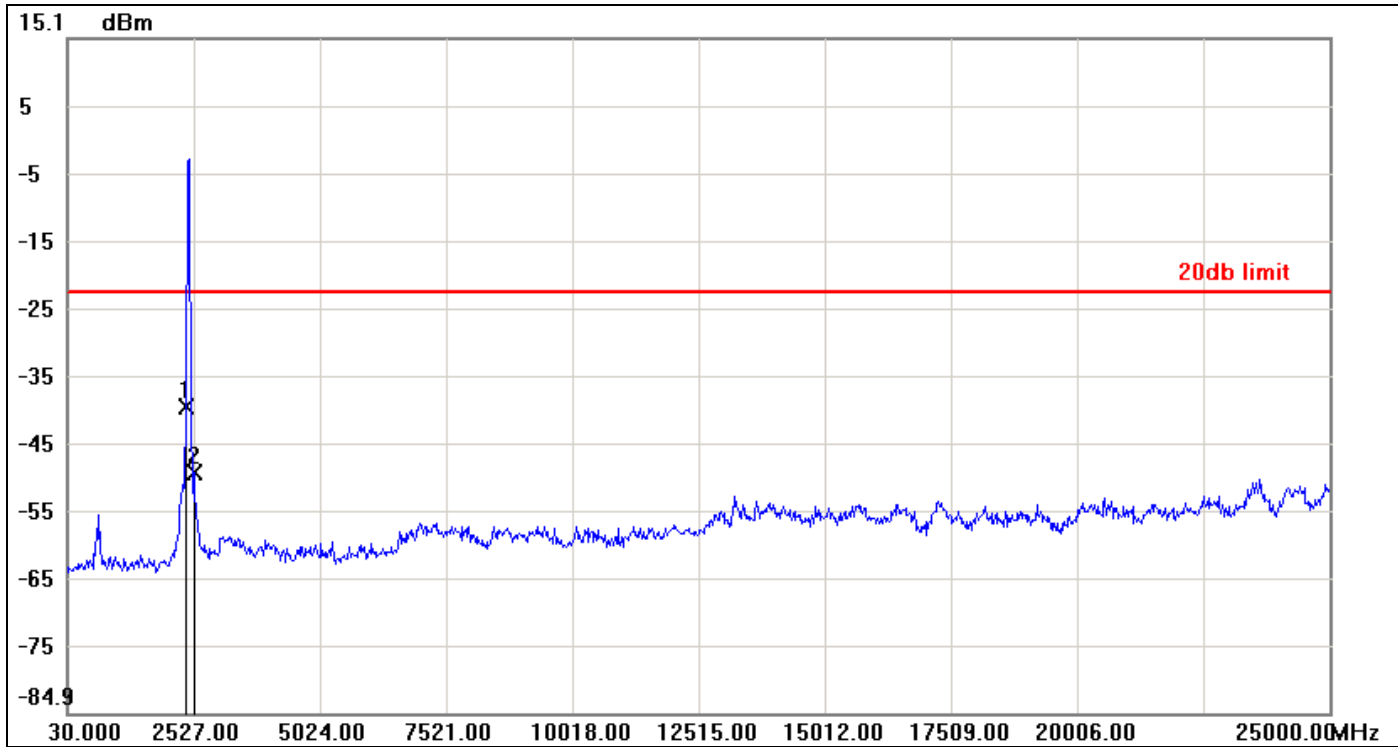

No.	Frequency(MHz)	Result(dBm)	Limit(dBm)	Margin(dBm)
1	2377.1800	-39.66	-22.68	-16.98
2	2527.0000	-49.35	-22.68	-26.67



CH Mid



No.	Frequency(MHz)	Result(dBm)	Limit(dBm)	Margin(dBm)
1	2377.1800	-49.18	-22.93	-26.25
2	23451.8600	-50.53	-22.93	-27.60



CH High

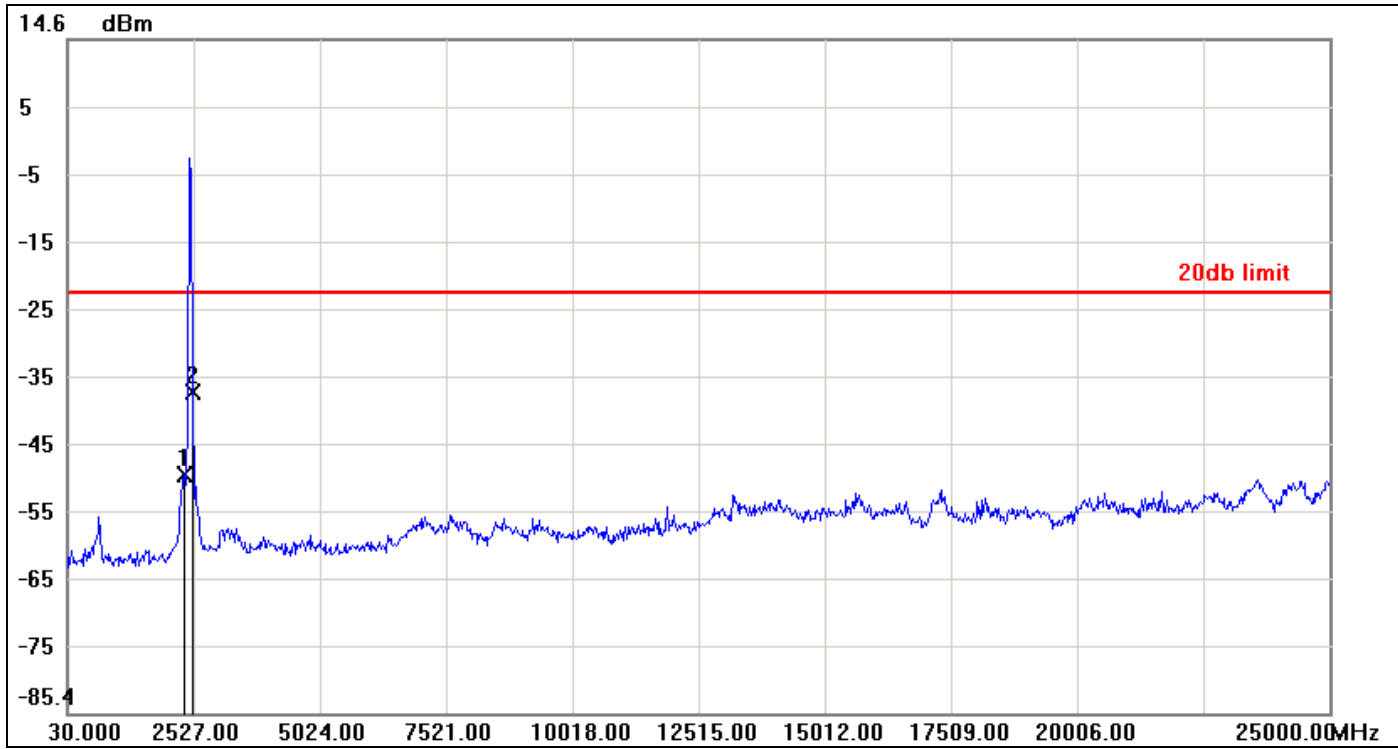

No.	Frequency(MHz)	Result(dBm)	Limit(dBm)	Margin(dBm)
1	2352.2100	-49.99	-22.96	-27.03
2	2502.0300	-37.89	-22.96	-14.93



IEEE 802.11n HT 40 mode / Chain 1

CH Low

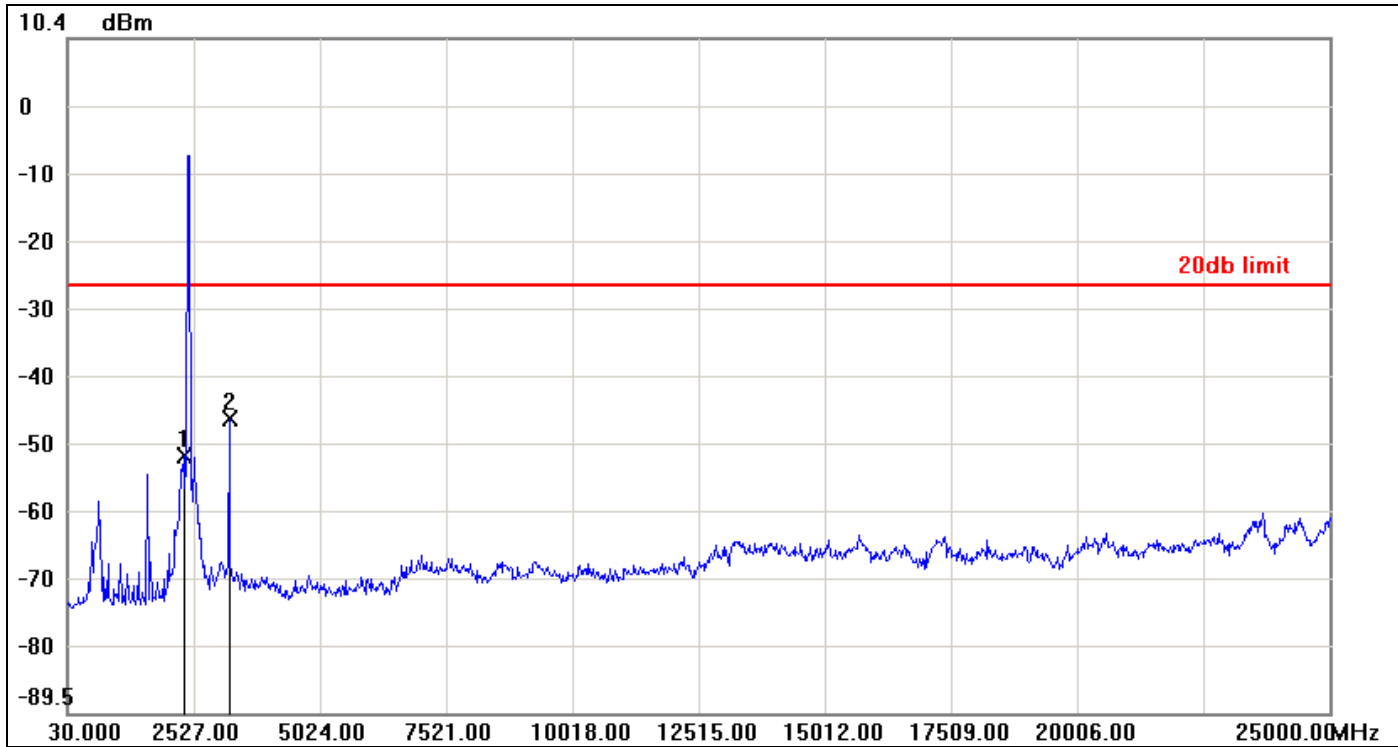

No.	Frequency(MHz)	Result(dBm)	Limit(dBm)	Margin(dBm)
1	2327.2400	-51.34	-26.11	-25.23
2	3226.1600	-45.99	-26.11	-19.88



CH Mid

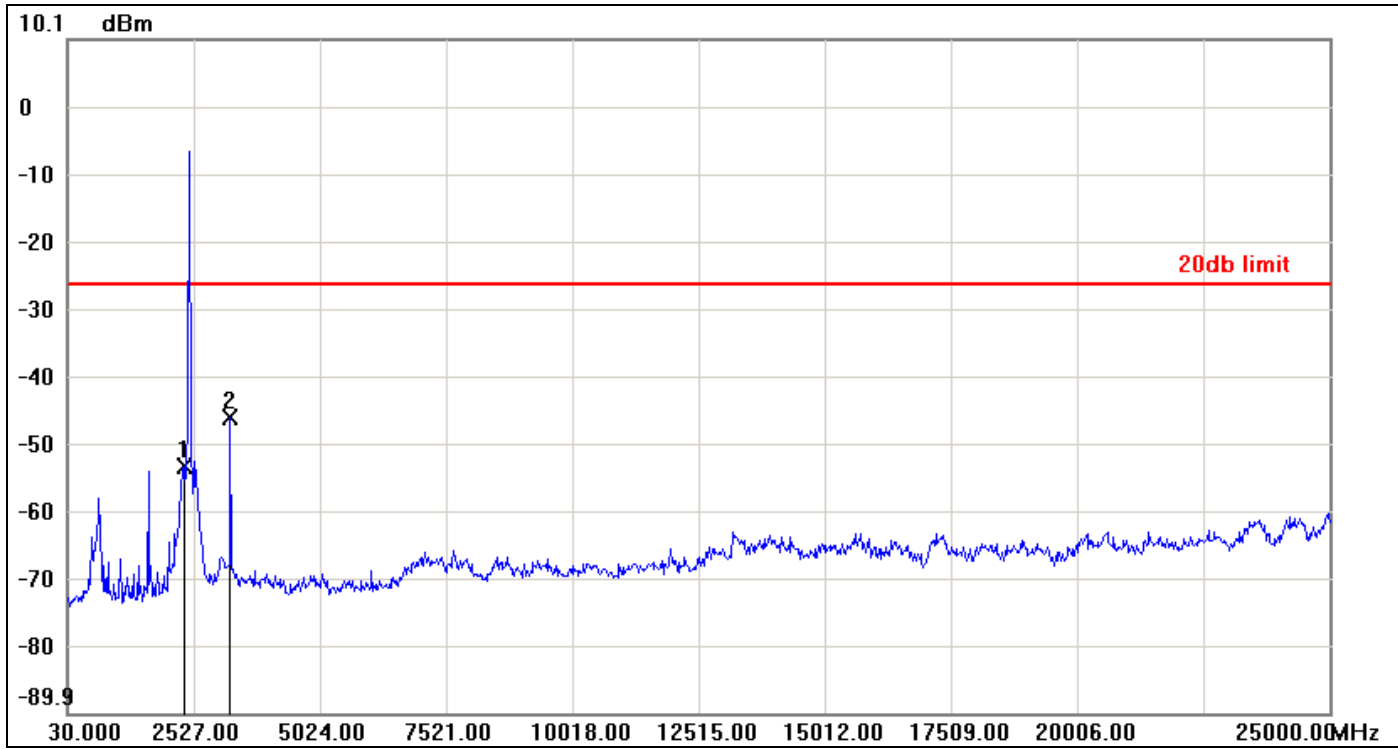

No.	Frequency(MHz)	Result(dBm)	Limit(dBm)	Margin(dBm)
1	2327.2400	-53.18	-26.36	-26.82
2	3251.1300	-46.10	-26.36	-19.74



CH High



No.	Frequency(MHz)	Result(dBm)	Limit(dBm)	Margin(dBm)
1	2327.2400	-51.87	-26.56	-25.31
2	3276.1000	-47.36	-26.56	-20.80



7.6 RADIATED EMISSIONS

LIMIT

1. According to §15.209(a), except as provided elsewhere in this Subpart, the emissions from an intentional radiator shall not exceed the field strength levels specified in the following table:

Frequency (MHz)	Field Strength ($\mu\text{V/m}$)	Measurement Distance (m)
0.009 - 0.490	2400/F(kHz)	300
0.490 - 1.705	24000/F(kHz)	30
1.705 – 30.0	30	30
30-88	100	3
88-216	150	3
216-960	200	3
Above 960	500	3

Remark: Except as provided in paragraph (g), fundamental emissions from intentional radiators operating under this Section shall not be located in the frequency bands 54-72 MHz, 76-88 MHz, 174-216 MHz or 470-806 MHz. However, operation within these frequency bands is permitted under other sections of this Part, e.g., Sections 15.231 and 15.241.

2. In the emission table above, the tighter limit applies at the band edges.

Frequency (MHz)	Field Strength ($\mu\text{V/m}$ at 3-meter)	Field Strength (dB $\mu\text{V/m}$ at 3-meter)
0.009 - 0.490	2400/F(kHz) +80	20LOG((2400/F(kHz))+80)
0.490 - 1.705	24000/F(kHz) +40	20LOG((24000/F(kHz))+40)
1.705 – 30.0	30	69.54
30-88	100	40
88-216	150	43.5
216-960	200	46
Above 960	500	54



Test Configuration

9kHz ~ 30MHz

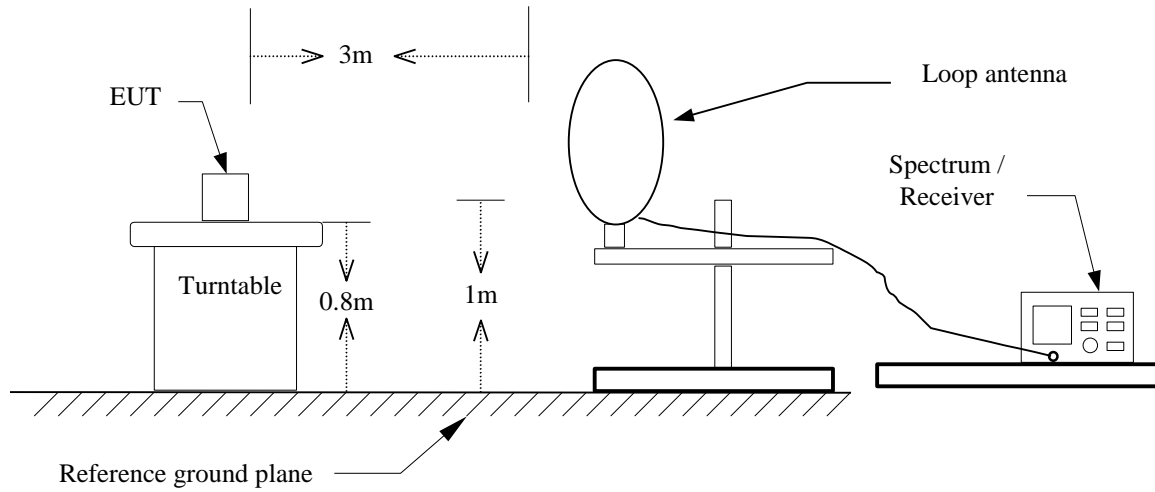

30MHz ~ 1GHz

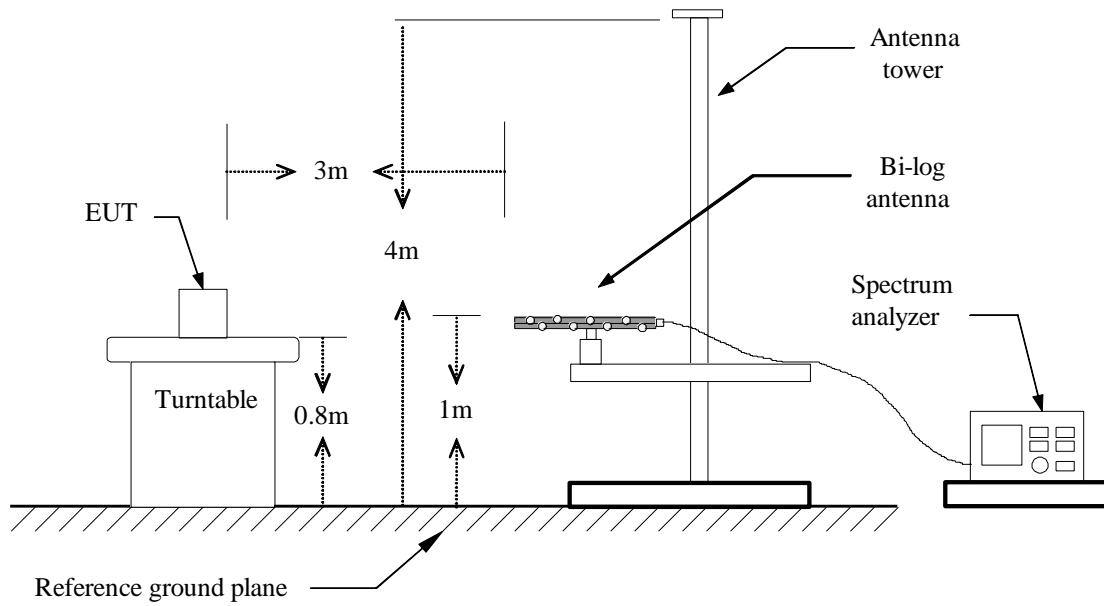



Above 1 GHz

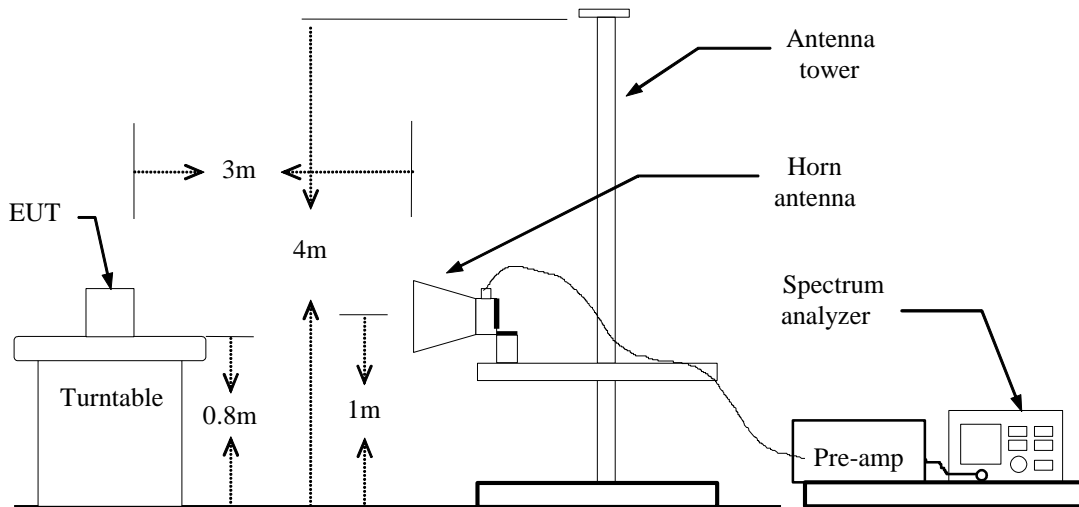



TEST PROCEDURE

1. The EUT is placed on a turntable, which is 0.8m above ground plane.
2. The turntable shall be rotated for 360 degrees to determine the position of maximum emission level.
3. EUT is set 3m away from the receiving antenna, which is varied from 1m to 4m to find out the highest emissions.
4. Maximum procedure was performed on the six highest emissions to ensure EUT compliance.
5. And also, each emission was to be maximized by changing the polarization of receiving antenna both horizontal and vertical.
6. Set the spectrum analyzer in the following setting as:
Below 1GHz:
RBW=100kHz / VBW=300kHz / Sweep=AUTO
Above 1GHz:
(a) PEAK: RBW=VBW=1MHz / Sweep=AUTO
(b) AVERAGE: RBW=1MHz / VBW=300Hz / Sweep=AUTO
7. Repeat above procedures until the measurements for all frequencies are complete.

TEST RESULTS

No non-compliance noted.

**Below 1GHz**

Operation Mode: Normal Link **Test Date:** December 19, 2013
Temperature: 16°C **Tested by:** Alan Wu
Humidity: 59% RH **Polarity:** Ver. / Hor.

Frequency (MHz)	Corr. Factor (dB)	Meter Reading at 10 m (dBμV/m)	Limits (Class B) (dBμV/m)	Emission Level at 10 m (dBμV/m)	Margin Value (dB)	Ant. Pol. (H/V)
40.00	-15.94	38.40	30.00	22.46	-7.54	V
233.20	-20.21	38.70	30.00	18.50	-11.51	V
585.00	-10.57	38.40	37.00	27.84	-9.17	V
643.50	-7.87	32.30	37.00	24.43	-12.57	V
750.00	-4.36	34.10	37.00	29.74	-7.26	V
875.00	-3.12	36.90	37.00	33.79	-3.22	V
40.00	-15.94	40.00	30.00	24.06	-5.94	H
301.00	-15.55	39.60	37.00	24.05	-12.95	H
440.00	-11.28	37.10	37.00	25.82	-11.18	H
500.00	-10.09	35.20	37.00	25.11	-11.89	H
750.00	-5.15	33.70	37.00	28.55	-8.45	H
975.00	-3.12	35.80	37.00	32.69	-4.32	H

Remark:

1. No emission found between lowest internal used/generated frequency to 30MHz (9kHz~30MHz)
2. Radiated emissions measured in frequency range from 30 MHz to 1000MHz were made with an instrument using peak/quasi-peak detector mode.
3. Measurements above show only up to 6 maximum emissions noted, or would be lesser, with " N/A " remark, if no specific emissions from the EUT are recorded (ie: margin>20dB from the applicable limit) and considered that's already beyond the background noise floor.
4. Margin (dB) = Result (dBuV/m) – Limit (dBuV/m).



Above 1 GHz

Operation Mode: TX / IEEE 802.11b / CH Low

Test Date: December 2, 2013

Temperature: 27°C

Tested by: David Lee

Humidity: 53 % RH

Polarity: Ver. / Hor.

Frequency (MHz)	Reading (dBuV)	Correction Factor (dB/m)	Result (dBuV/m)	Limit (dBuV/m)	Margin (dB)	Remark	Ant. Pol. (H/V)
1906.667	50.32	-6.36	43.96	74.00	-30.04	peak	V
4825.000	51.71	2.74	54.45	74.00	-19.55	peak	V
4825.000	49.98	2.74	52.72	54.00	-1.28	AVG	V
N/A							
1753.333	51.35	-7.15	44.20	74.00	-29.80	peak	H
4825.000	45.46	2.74	48.20	74.00	-25.80	peak	H
N/A							

Remark:

1. Measuring frequencies from 1 GHz to the 10th harmonic of highest fundamental frequency.
2. Radiated emissions measured in frequency above 1000MHz were made with an instrument using peak/average detector mode.
3. Average test would be performed if the peak result were greater than the average limit or as required by the applicant.
4. Data of measurement within this frequency range shown “ --- ” in the table above means the reading of emissions are attenuated more than 20dB below the permissible limits or the field strength is too small to be measured.
5. Measurements above show only up to 6 maximum emissions noted, or would be lesser, with “ N/A ” remark, if no specific emissions from the EUT are recorded (ie: margin>20dB from the applicable limit) and considered that's already beyond the background noise floor.
6. Margin (dB) = Remark result (dBuV/m) – Average limit (dBuV/m).



Operation Mode: TX / IEEE 802.11b / CH Mid

Test Date: December 2, 2013

Temperature: 27°C

Tested by: David Lee

Humidity: 53 % RH

Polarity: Ver. / Hor.

Frequency (MHz)	Reading (dBuV)	Correction Factor (dB/m)	Result (dBuV/m)	Limit (dBuV/m)	Margin (dB)	Remark	Ant. Pol. (H/V)
1996.667	51.41	-5.90	45.51	74.00	-28.49	peak	V
4875.000	49.56	2.85	52.41	74.00	-21.59	peak	V
4875.000	48.16	2.85	51.01	54.00	-2.99	AVG	V
N/A							
2306.667	51.10	-5.27	45.83	74.00	-28.17	peak	H
4875.000	44.09	2.85	46.94	74.00	-27.06	peak	H
N/A							

Remark:

1. Measuring frequencies from 1 GHz to the 10th harmonic of highest fundamental frequency.
2. Radiated emissions measured in frequency above 1000MHz were made with an instrument using peak/average detector mode.
3. Average test would be performed if the peak result were greater than the average limit or as required by the applicant.
4. Data of measurement within this frequency range shown " --- " in the table above means the reading of emissions are attenuated more than 20dB below the permissible limits or the field strength is too small to be measured.
5. Measurements above show only up to 6 maximum emissions noted, or would be lesser, with " N/A " remark, if no specific emissions from the EUT are recorded (ie: margin > 20dB from the applicable limit) and considered that's already beyond the background noise floor.
6. Margin (dB) = Remark result (dBuV/m) – Average limit (dBuV/m).



Operation Mode: TX / IEEE 802.11b / CH High

Test Date: December 2, 2013

Temperature: 27°C

Tested by: David Lee

Humidity: 53 % RH

Polarity: Ver. / Hor.

Frequency (MHz)	Reading (dBuV)	Correction Factor (dB/m)	Result (dBuV/m)	Limit (dBuV/m)	Margin (dB)	Remark	Ant. Pol. (H/V)
2203.333	51.30	-5.49	45.81	74.00	-28.19	peak	V
4925.000	46.31	2.97	49.28	74.00	-24.72	peak	V
N/A							
1463.333	49.85	-8.62	41.23	74.00	-32.77	peak	H
2236.667	50.65	-5.42	45.23	74.00	-28.77	peak	H
4925.000	41.51	2.97	44.48	74.00	-29.52	peak	H
N/A							

Remark:

1. Measuring frequencies from 1 GHz to the 10th harmonic of highest fundamental frequency.
2. Radiated emissions measured in frequency above 1000MHz were made with an instrument using peak/average detector mode.
3. Average test would be performed if the peak result were greater than the average limit or as required by the applicant.
4. Data of measurement within this frequency range shown " --- " in the table above means the reading of emissions are attenuated more than 20dB below the permissible limits or the field strength is too small to be measured.
5. Measurements above show only up to 6 maximum emissions noted, or would be lesser, with " N/A " remark, if no specific emissions from the EUT are recorded (ie: margin > 20dB from the applicable limit) and considered that's already beyond the background noise floor.
6. Margin (dB) = Remark result (dBuV/m) – Average limit (dBuV/m).



Operation Mode: TX / IEEE 802.11g / CH Low

Test Date: December 2, 2013

Temperature: 27°C

Tested by: David Lee

Humidity: 53 % RH

Polarity: Ver. / Hor.

Frequency (MHz)	Reading (dBuV)	Correction Factor (dB/m)	Result (dBuV/m)	Limit (dBuV/m)	Margin (dB)	Remark	Ant. Pol. (H/V)
2140.000	50.72	-5.61	45.11	74.00	-28.89	peak	V
4816.667	54.37	2.72	57.09	74.00	-16.91	peak	V
4816.667	45.52	2.72	48.24	54.00	-5.76	AVG	V
7225.000	39.20	9.39	48.59	74.00	-25.41	peak	V
N/A							
2150.000	50.84	-5.59	45.25	74.00	-28.75	peak	H
4825.000	49.33	2.74	52.07	74.00	-21.93	peak	H
4825.000	39.73	2.74	42.47	54.00	-11.53	AVG	H
N/A							

Remark:

1. Measuring frequencies from 1 GHz to the 10th harmonic of highest fundamental frequency.
2. Radiated emissions measured in frequency above 1000MHz were made with an instrument using peak/average detector mode.
3. Average test would be performed if the peak result were greater than the average limit or as required by the applicant.
4. Data of measurement within this frequency range shown " --- " in the table above means the reading of emissions are attenuated more than 20dB below the permissible limits or the field strength is too small to be measured.
5. Measurements above show only up to 6 maximum emissions noted, or would be lesser, with " N/A " remark, if no specific emissions from the EUT are recorded (ie: margin > 20dB from the applicable limit) and considered that's already beyond the background noise floor.
6. Margin (dB) = Remark result (dBuV/m) – Average limit (dBuV/m).



Operation Mode: TX / IEEE 802.11g / CH Mid

Test Date: December 2, 2013

Temperature: 27°C

Tested by: David Lee

Humidity: 53 % RH

Polarity: Ver. / Hor.

Frequency (MHz)	Reading (dBuV)	Correction Factor (dB/m)	Result (dBuV/m)	Limit (dBuV/m)	Margin (dB)	Remark	Ant. Pol. (H/V)
2300.000	52.74	-5.30	47.44	74.00	-26.56	peak	V
4875.000	50.67	2.85	53.52	74.00	-20.48	peak	V
4875.000	43.37	2.85	46.22	54.00	-7.78	AVG	V
N/A							
2290.000	50.68	-5.32	45.36	74.00	-28.64	peak	H
4875.000	44.95	2.85	47.80	74.00	-26.20	peak	H
N/A							

Remark:

1. Measuring frequencies from 1 GHz to the 10th harmonic of highest fundamental frequency.
2. Radiated emissions measured in frequency above 1000MHz were made with an instrument using peak/average detector mode.
3. Average test would be performed if the peak result were greater than the average limit or as required by the applicant.
4. Data of measurement within this frequency range shown " --- " in the table above means the reading of emissions are attenuated more than 20dB below the permissible limits or the field strength is too small to be measured.
5. Measurements above show only up to 6 maximum emissions noted, or would be lesser, with " N/A " remark, if no specific emissions from the EUT are recorded (ie: margin > 20dB from the applicable limit) and considered that's already beyond the background noise floor.
6. Margin (dB) = Remark result (dBuV/m) – Average limit (dBuV/m).



Operation Mode: TX / IEEE 802.11g / CH High

Test Date: December 2, 2013

Temperature: 27°C

Tested by: David Lee

Humidity: 53 % RH

Polarity: Ver. / Hor.

Frequency (MHz)	Reading (dBuV)	Correction Factor (dB/m)	Result (dBuV/m)	Limit (dBuV/m)	Margin (dB)	Remark	Ant. Pol. (H/V)
2376.667	52.42	-4.95	47.47	74.00	-26.53	peak	V
4925.000	47.01	2.97	49.98	74.00	-24.02	peak	V
N/A							
2323.333	50.67	-5.20	45.47	74.00	-28.53	peak	H
4925.000	43.66	2.97	46.63	74.00	-27.37	peak	H
N/A							

Remark:

1. Measuring frequencies from 1 GHz to the 10th harmonic of highest fundamental frequency.
2. Radiated emissions measured in frequency above 1000MHz were made with an instrument using peak/average detector mode.
3. Average test would be performed if the peak result were greater than the average limit or as required by the applicant.
4. Data of measurement within this frequency range shown " --- " in the table above means the reading of emissions are attenuated more than 20dB below the permissible limits or the field strength is too small to be measured.
5. Measurements above show only up to 6 maximum emissions noted, or would be lesser, with " N/A " remark, if no specific emissions from the EUT are recorded (ie: margin > 20dB from the applicable limit) and considered that's already beyond the background noise floor.
6. Margin (dB) = Remark result (dBuV/m) – Average limit (dBuV/m).



Operation Mode: TX / IEEE 802.11n HT 20 mode / CH Low

Test Date: December 2, 2013

Temperature: 27°C

Tested by: David Lee

Humidity: 53 % RH

Polarity: Ver. / Hor.

Frequency (MHz)	Reading (dBuV)	Correction Factor (dB/m)	Result (dBuV/m)	Limit (dBuV/m)	Margin (dB)	Remark	Ant. Pol. (H/V)
2346.667	60.70	-5.09	55.61	74.00	-18.39	peak	V
2346.667	52.49	-5.09	47.40	54.00	-6.60	AVG	V
4825.000	50.72	2.74	53.46	74.00	-20.54	peak	V
4825.000	42.07	2.74	44.81	54.00	-9.19	AVG	V
N/A							
2360.000	51.98	-5.03	46.95	74.00	-27.05	peak	H
4833.333	47.93	2.76	50.69	74.00	-23.31	peak	H
N/A							

Remark:

1. Measuring frequencies from 1 GHz to the 10th harmonic of highest fundamental frequency.
2. Radiated emissions measured in frequency above 1000MHz were made with an instrument using peak/average detector mode.
3. Average test would be performed if the peak result were greater than the average limit or as required by the applicant.
4. Data of measurement within this frequency range shown " --- " in the table above means the reading of emissions are attenuated more than 20dB below the permissible limits or the field strength is too small to be measured.
5. Measurements above show only up to 6 maximum emissions noted, or would be lesser, with " N/A " remark, if no specific emissions from the EUT are recorded (ie: margin > 20dB from the applicable limit) and considered that's already beyond the background noise floor.
6. Margin (dB) = Remark result (dBuV/m) – Average limit (dBuV/m).



Operation Mode: TX / IEEE 802.11n HT 20 mode / CH Mid

Test Date: December 2, 2013

Temperature: 27°C

Tested by: David Lee

Humidity: 53 % RH

Polarity: Ver. / Hor.

Frequency (MHz)	Reading (dBuV)	Correction Factor (dB/m)	Result (dBuV/m)	Limit (dBuV/m)	Margin (dB)	Remark	Ant. Pol. (H/V)
2370.000	59.81	-4.98	54.83	74.00	-19.17	peak	V
2370.000	51.48	-4.98	46.50	54.00	-7.50	AVG	V
2490.000	57.77	-4.01	53.76	74.00	-20.24	peak	V
2490.000	48.31	-4.01	44.30	54.00	-9.70	AVG	V
4875.000	46.48	2.85	49.33	74.00	-24.67	peak	V
N/A							
2490.000	53.09	-4.01	49.08	74.00	-24.92	peak	H
2490.000	44.51	-4.01	40.50	54.00	-13.50	AVG	H
4866.667	44.71	2.84	47.55	74.00	-26.45	peak	H
N/A							

Remark:

1. Measuring frequencies from 1 GHz to the 10th harmonic of highest fundamental frequency.
2. Radiated emissions measured in frequency above 1000MHz were made with an instrument using peak/average detector mode.
3. Average test would be performed if the peak result were greater than the average limit or as required by the applicant.
4. Data of measurement within this frequency range shown " --- " in the table above means the reading of emissions are attenuated more than 20dB below the permissible limits or the field strength is too small to be measured.
5. Measurements above show only up to 6 maximum emissions noted, or would be lesser, with " N/A " remark, if no specific emissions from the EUT are recorded (ie: margin > 20dB from the applicable limit) and considered that's already beyond the background noise floor.
6. Margin (dB) = Remark result (dBuV/m) – Average limit (dBuV/m).



Operation Mode: TX / IEEE 802.11n HT 20 mode / CH High **Test Date:** December 2, 2013

Temperature: 27°C **Tested by:** David Lee

Humidity: 53 % RH **Polarity:** Ver. / Hor.

Frequency (MHz)	Reading (dBuV)	Correction Factor (dB/m)	Result (dBuV/m)	Limit (dBuV/m)	Margin (dB)	Remark	Ant. Pol. (H/V)
2303.333	55.30	-5.29	50.01	74.00	-23.99	peak	V
2516.667	53.52	-3.90	49.62	74.00	-24.38	peak	V
4925.000	42.93	2.97	45.90	74.00	-28.10	peak	V
N/A							
2216.667	50.92	-5.46	45.46	74.00	-28.54	peak	H
N/A							

Remark:

1. Measuring frequencies from 1 GHz to the 10th harmonic of highest fundamental frequency.
2. Radiated emissions measured in frequency above 1000MHz were made with an instrument using peak/average detector mode.
3. Average test would be performed if the peak result were greater than the average limit or as required by the applicant.
4. Data of measurement within this frequency range shown “ --- ” in the table above means the reading of emissions are attenuated more than 20dB below the permissible limits or the field strength is too small to be measured.
5. Measurements above show only up to 6 maximum emissions noted, or would be lesser, with “ N/A ” remark, if no specific emissions from the EUT are recorded (ie: margin > 20dB from the applicable limit) and considered that's already beyond the background noise floor.
6. Margin (dB) = Remark result (dBuV/m) – Average limit (dBuV/m).



Operation Mode: TX / IEEE 802.11n HT 40 mode / CH Low

Test Date: December 2, 2013

Temperature: 27°C

Tested by: David Lee

Humidity: 53 % RH

Polarity: Ver. / Hor.

Frequency (MHz)	Reading (dBuV)	Correction Factor (dB/m)	Result (dBuV/m)	Limit (dBuV/m)	Margin (dB)	Remark	Ant. Pol. (H/V)
2560.000	55.34	-3.83	51.51	74.00	-22.49	peak	V
4850.000	42.91	2.80	45.71	74.00	-28.29	peak	V
N/A							
2066.667	51.00	-5.75	45.25	74.00	-28.75	peak	H
N/A							

Remark:

1. Measuring frequencies from 1 GHz to the 10th harmonic of highest fundamental frequency.
2. Radiated emissions measured in frequency above 1000MHz were made with an instrument using peak/average detector mode.
3. Average test would be performed if the peak result were greater than the average limit or as required by the applicant.
4. Data of measurement within this frequency range shown “ --- ” in the table above means the reading of emissions are attenuated more than 20dB below the permissible limits or the field strength is too small to be measured.
5. Measurements above show only up to 6 maximum emissions noted, or would be lesser, with “ N/A ” remark, if no specific emissions from the EUT are recorded (ie: margin > 20dB from the applicable limit) and considered that's already beyond the background noise floor.
6. Margin (dB) = Remark result (dBuV/m) – Average limit (dBuV/m).



Operation Mode: TX / IEEE 802.11n HT 40 mode / CH Mid

Test Date: December 2, 2013

Temperature: 27°C

Tested by: David Lee

Humidity: 53 % RH

Polarity: Ver. / Hor.

Frequency (MHz)	Reading (dBuV)	Correction Factor (dB/m)	Result (dBuV/m)	Limit (dBuV/m)	Margin (dB)	Remark	Ant. Pol. (H/V)
2543.333	53.93	-3.86	50.07	74.00	-23.93	peak	V
2543.333	48.98	-3.86	45.12	54.00	-8.88	AVG	V
4866.667	43.07	2.84	45.91	74.00	-28.09	peak	V
N/A							
2256.667	50.71	-5.38	45.33	74.00	-28.67	peak	H
N/A							

Remark:

1. Measuring frequencies from 1 GHz to the 10th harmonic of highest fundamental frequency.
2. Radiated emissions measured in frequency above 1000MHz were made with an instrument using peak/average detector mode.
3. Average test would be performed if the peak result were greater than the average limit or as required by the applicant.
4. Data of measurement within this frequency range shown “ --- ” in the table above means the reading of emissions are attenuated more than 20dB below the permissible limits or the field strength is too small to be measured.
5. Measurements above show only up to 6 maximum emissions noted, or would be lesser, with “ N/A ” remark, if no specific emissions from the EUT are recorded (ie: margin > 20dB from the applicable limit) and considered that's already beyond the background noise floor.
6. Margin (dB) = Remark result (dBuV/m) – Average limit (dBuV/m).



Operation Mode: TX / IEEE 802.11n HT 40 mode / CH High Test Date: December 2, 2013

Temperature: 27°C

Tested by: David Lee

Humidity: 53 % RH

Polarity: Ver. / Hor.

Frequency (MHz)	Reading (dBuV)	Correction Factor (dB/m)	Result (dBuV/m)	Limit (dBuV/m)	Margin (dB)	Remark	Ant. Pol. (H/V)
2553.333	53.05	-3.84	49.21	74.00	-24.79	peak	V
2553.333	46.15	-3.84	42.31	54.00	-11.69	AVG	V
4908.333	41.32	2.93	44.25	74.00	-29.75	peak	V
N/A							
2326.667	50.79	-5.18	45.61	74.00	-28.39	peak	H
N/A							

Remark:

1. Measuring frequencies from 1 GHz to the 10th harmonic of highest fundamental frequency.
2. Radiated emissions measured in frequency above 1000MHz were made with an instrument using peak/average detector mode.
3. Average test would be performed if the peak result were greater than the average limit or as required by the applicant.
4. Data of measurement within this frequency range shown " --- " in the table above means the reading of emissions are attenuated more than 20dB below the permissible limits or the field strength is too small to be measured.
5. Measurements above show only up to 6 maximum emissions noted, or would be lesser, with " N/A " remark, if no specific emissions from the EUT are recorded (ie: margin > 20dB from the applicable limit) and considered that's already beyond the background noise floor.
6. Margin (dB) = Remark result (dBuV/m) – Average limit (dBuV/m).



7.7 POWERLINE CONDUCTED EMISSIONS

LIMIT

According to §15.207(a), except as shown in paragraphs (b) and (c) of this section, for an intentional radiator that is designed to be connected to the public utility (AC) power line, the radio frequency voltage that is conducted back onto the AC power line on any frequency or frequencies within the band 150 kHz to 30 MHz shall not exceed the limits in the following table, as measured using a 50 μ H/50 ohms line impedance stabilization network (LISN). Compliance with the provisions of this paragraph shall be based on the measurement of the radio frequency voltage between each power line and ground at the power terminal. The lower limit applies at the boundary between the frequency ranges.

Frequency Range (MHz)	Limits (dB μ V)	
	Quasi-peak	Average
0.15 to 0.50	66 to 56*	56 to 46*
0.50 to 5	56	46
5 to 30	60	50

* Decreases with the logarithm of the frequency.

Test Configuration

See test photographs attached in Appendix II for the actual connections between EUT and support equipment.

TEST PROCEDURE

1. The EUT was placed on a table, which is 0.8m above ground plane.
2. Maximum procedure was performed on the six highest emissions to ensure EUT compliance.
3. Repeat above procedures until all frequency measured were complete.



TEST RESULTS

The initial step in collecting conducted data is a spectrum analyzer peak scan of the measurement range. Significant peaks are then marked as shown on the following data page, and these signals are then quasi-peaked.

Test Data

Operation Mode: Normal Link **Test Date:** November 6, 2013
Temperature: 24°C **Tested by:** Peter Chang
Humidity: 50% RH

Freq. (MHz)	QP Reading (dBuV)	AV Reading (dBuV)	Corr. factor (dB/m)	QP Result (dBuV/m)	AV Result (dBuV/m)	QP Limit (dBuV)	AV Limit (dBuV)	QP Margin (dB)	AV Margin (dB)	Note
0.1613	37.68	9.67	9.61	47.29	19.28	65.39	55.40	-18.10	-36.12	L1
0.1944	40.01	20.95	9.62	49.63	30.57	63.84	53.85	-14.21	-23.28	L1
1.0373	26.80	12.47	9.65	36.45	22.12	56.00	46.00	-19.55	-23.88	L1
1.2777	27.24	13.91	9.66	36.90	23.57	56.00	46.00	-19.10	-22.43	L1
1.4812	27.33	12.93	9.66	36.99	22.59	56.00	46.00	-19.01	-23.41	L1
1.7779	26.31	17.67	9.67	35.98	27.34	56.00	46.00	-20.02	-18.66	L1
0.1535	38.49	10.41	9.66	48.15	20.07	65.80	55.81	-17.65	-35.74	L2
0.1784	39.04	16.58	9.67	48.71	26.25	64.56	54.56	-15.85	-28.31	L2
0.1943	39.86	21.14	9.67	49.53	30.81	63.85	53.85	-14.32	-23.04	L2
0.2426	31.05	12.29	9.67	40.72	21.96	62.00	52.01	-21.28	-30.05	L2
2.0551	25.99	10.35	9.73	35.72	20.08	56.00	46.00	-20.28	-25.92	L2
10.6686	23.18	16.25	9.90	33.08	26.15	60.00	50.00	-26.92	-23.85	L2

Remark:

1. Measuring frequencies from 0.15 MHz to 30MHz.
2. The emissions measured in frequency range from 0.15 MHz to 30MHz were made with an instrument using Quasi-peak detector and average detector.
3. The IF bandwidth of SPA between 0.15MHz and 30MHz was 10 kHz; the IF bandwidth of Test Receiver between 0.15MHz and 30MHz was 9 kHz;
4. L1 = Line One (Live Line) / L2 = Line Two (Neutral Line)



Test Plots

Conducted emissions (Line 1)

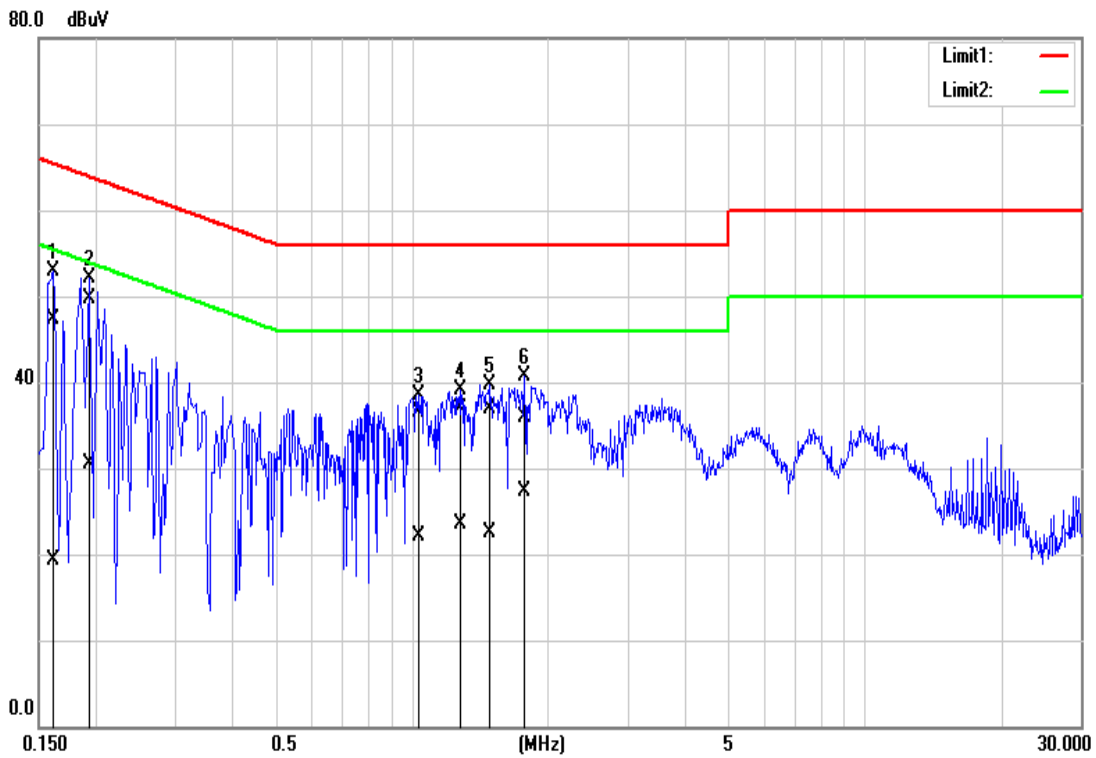

Conducted emissions (Line 2)

