



**FCC 47 CFR PART 15 SUBPART C AND ANSI C63.10:2013
TEST REPORT**

For

Dual-lines VDSL2/ADSL2+ Wireless-AC 3G/4G LTE VPN Firewall Router

Model : BiPAC 8920AX

**Data Applies To : Please refer to section 2
(altogether 17 series models)**

Issued for

Billion Electric Co., Ltd.

**8F., No.192, Sec. 2, Zhongxing Rd., Xindian Dist., New Taipei City 231,
Taiwan (R.O.C.)**

Issued by

**Compliance Certification Services Inc.
Hsinchu Lab.**

**No.989-1, Wenshan Rd., Shangshan Village,
Qionglin Township, Hsinchu County 30741, Taiwan (R.O.C.)**

TEL: +886-3-5921698

FAX: +886-3-5921108

<http://www.ccsrf.com>

E-Mail : service@ccsrf.com

Issued Date: August 26, 2015



Note: *This report shall not be reproduced except in full, without the written approval of Compliance Certification Services Inc. This document may be altered or revised by Compliance Certification Services Inc. personnel only, and shall be noted in the revision section of the document. The client should not use it to claim product endorsement by TAF or any government agencies. The test results of this report relate only to the tested sample identified in this report.*



Revision History

Rev.	Issue Date	Revisions	Effect Page	Revised By
00	06/08/2015	Initial Issue	All Page 157	Michelle Chiu
01	08/26/2015	Revised Remark Description	P.37-38	Gloria Chang



TABLE OF CONTENTS

TITLE	PAGE NO.
1. TEST REPORT CERTIFICATION	4
2. EUT DESCRIPTION	5
3. DESCRIPTION OF TEST MODES	9
4. TEST METHODOLOGY	10
5. FACILITIES AND ACCREDITATION.....	10
5.1 FACILITIES	10
5.2 ACCREDITATIONS.....	10
5.3 MEASUREMENT UNCERTAINTY	11
6. SETUP OF EQUIPMENT UNDER TEST.....	12
7. FCC PART 15.247 REQUIREMENTS.....	14
7.1 6dB BANDWIDTH	14
7.2 MAXIMUM PEAK OUTPUT POWER	30
7.3 AVERAGE POWER	33
7.4 POWER SPECTRAL DENSITY	36
7.5 CONDUCTED SPURIOUS EMISSION	53
7.6 RADIATED EMISSION.....	75
7.7 CONDUCTED EMISSION.....	145
APPENDIX I CO-LOCATION	150
APPENDIX II SETUP PHOTOS	154



1. TEST REPORT CERTIFICATION

Applicant : Billion Electric Co., Ltd.
Address : 8F, No.192, Sec. 2, Zhongxing Rd., Xindian Dist.,
 New Taipei City 231, Taiwan (R.O.C.)
Equipment Under Test : Dual-lines VDSL2/ADSL2+ Wireless-AC 3G/4G LTE VPN
 Firewall Router
Model : BiPAC 8920AX
Data Applies To : Please refer to section 2 (altogether 17 series models)
Tested Date : May 05 ~ June 03, 2015

APPLICABLE STANDARD	
Standard	Test Result
FCC Part 15 Subpart C AND ANSI C63.10:2013	PASS

WE HEREBY CERTIFY THAT: The above equipment has been tested by Compliance Certification Services Inc., and found compliance with the requirements set forth in the technical standards mentioned above. The results of testing in this report apply only to the product/system, which was tested. Other similar equipment will not necessarily produce the same results due to production tolerance and measurement uncertainties.

Approved by:

Sb. Lu
Sr. Engineer

Reviewed by:

Gundam Lin
Sr. Engineer

**2. EUT DESCRIPTION**

Product Name	Dual-lines VDSL2/ADSL2+ Wireless-AC 3G/4G LTE VPN Firewall Router
Model Number	BiPAC 8920AX
Data Applies To	Please refer to section 2 (altogether 17 series models)
Identify Number	T150505S06
Received Date	May 05, 2015
Frequency Range	IEEE 802.11b/g, 802.11gn HT20 : 2412MHz ~ 2462MHz IEEE 802.11gn HT40 : 2422MHz ~ 2452MHz
Transmit Power	IEEE 802.11b : 18.71dBm (0.0743W) IEEE 802.11g : 28.57dBm (0.7194W) IEEE 802.11gn HT20 : 29.31dBm (0.8531W) IEEE 802.11gn HT40 : 26.13dBm (0.4102W)
Channel Spacing	IEEE 802.11b/g, 802.11gn HT20/HT40 : 5MHz
Channel Number	IEEE 802.11b/g, 802.11gn HT20: 11 Channels IEEE 802.11gn HT40 : 7 Channels
Transmit Data Rate	IEEE 802.11b : up to 11 Mbps IEEE 802.11g : up to 54 Mbps IEEE 802.11gn (HT20,800ns GI) : up to 130 Mbps IEEE 802.11gn (HT20,400ns GI) : up to 144.4 Mbps IEEE 802.11gn (HT40,800ns GI) : up to 270 Mbps IEEE 802.11gn (HT40,400ns GI) : up to 300 Mbps
Type of Modulation	IEEE 802.11b : DSSS (CCK, DQPSK, DBPSK) IEEE 802.11g : OFDM (64QAM, 16QAM, QPSK, BPSK) IEEE 802.11gn HT20/40 : OFDM (64QAM, 16QAM, QPSK, BPSK)
Antenna Type	Dipole Antenna × 2 : Antenna 0 (Chain 0), Antenna Gain 3.5 dBi Antenna 1 (Chain 1), Antenna Gain 3.5 dBi
Power Rating	15Vdc
Test Voltage	120Vac, 60Hz
DC Power Cable Type	Non-shielded cable 1.5m × 1 (Non-detachable)
I/O Port	LAN Port × 4, WAN Port × 1, USB Port × 1, Power Port × 1, DSL Port × 1



Power Adapter :

No.	Manufacturer	Model No.	Power Input	Power Output
1	Ktec	KSAS0251500200HU	100-240Vac, 50/60Hz, 0.9A	15Vdc, 2.0A

Remark :

1. The sample selected for test was engineering sample that approximated to production product and was provided by manufacturer.
2. For more details, please refer to the User's manual of the EUT.
3. The model BiPAC 8920AX was considered the main model for testing.
4. This submittal(s) (test report) is intended for FCC ID: QI3BIL-8920AX filing to comply with Section 15.207, 15.209 and 15.247 of the FCC Part 15, Subpart C Rules.



The difference of the model :

Difference Item Model	Trade Name	xDSL Dual-lines	Wireless AC	USB	VPN
BiPAC 8920AX	Billion	O	O	O	O
BiPAC 8920AXL	Billion	O	O	O	X
BiPAC 8921AXL	Billion	O	O	O	X
BiPAC 8920X	Billion	O	X	O	O
BiPAC 8920XL	Billion	O	X	O	X
BiPAC 8900AX	Billion	X	O	O	O
BiPAC 8900AXL	Billion	X	O	O	X
BiPAC 8900X	Billion	X	X	O	O
BiPAC 8900XL	Billion	X	X	O	X

Note : " O " means all the same and " X " means the difference.



Difference Item Model	Trade Name	xDSL Dual-lines	Wireless AC	USB	VPN
BEC 8920X	BEC	O	O	O	O
BEC 8920AC	BEC	O	O	O	X
BEC 8920ACS	BEC	O	O	O	X
BEC 8920V	BEC	O	X	O	O
BEC 8920	BEC	O	X	O	X
BEC 8900X	BEC	X	O	O	O
BEC 8900AC	BEC	X	O	O	X
BEC 8900V	BEC	X	X	O	O
BEC 8900	BEC	X	X	O	X

Note : " O " means all the same and " X " means the difference.



3. DESCRIPTION OF TEST MODES

The EUT is an 802.11gn MIMO transceiver in Dual-lines VDSL2/ADSL2+ Wireless-AC 3G/4G LTE VPN Firewall Router form factor.

IEEE 802.11b mode (1TX / RX): Chain 0 (Ant 0) transmit/receive.

IEEE 802.11g, IEEE 802.11gn HT20/HT40 (2TX / 2RX) :

Chain 0 (Ant 0) & Chain 1(Ant 1) transmit/receive.

Conducted Emission / Radiated Emission Test (Below 1 GHz)

1. The following test modes were scanned during the preliminary test:

No.	Pre-Test Mode
1	Normal Operating

2. After the preliminary scan, the following test mode was found to produce the highest emission level.

Final Test Mode		
Emission	Radiated Emission	Normal Operating
	Conducted Emission	

Remark : Then, the above highest emission mode of the configuration of the EUT and cable was chosen for all final test items.

Conducted / Radiated Emission Test (Above 1 GHz)

IEEE 802.11b, 802.11g, 802.11gn HT20 mode

The EUT had been tested under operating condition.

There are three channels have been tested as following :

Channel	Frequency (MHz)
Low	2412
Middle	2437
High	2462

IEEE 802.11b mode : 1Mbps data rate (worst case) were chosen for full testing.

IEEE 802.11g mode : 6Mbps data rate (worst case) were chosen for full testing.

IEEE 802.11gn HT20 mode : 6.5Mbps data rate (worst case) were chosen for full testing.

IEEE 802.11gn HT40 mode

The EUT had been tested under operating condition.

There are three channels have been tested as following :

Channel	Frequency (MHz)
Low	2422
Middle	2437
High	2452

IEEE 802.11gn HT40 mode : 13.5Mbps data rate (worst case) were chosen for full testing.



4. TEST METHODOLOGY

The tests documented in this report were performed in accordance with ANSI C63.10: 2013 and FCC CFR 47, 15.207, 15.209, 15.247.

5. FACILITIES AND ACCREDITATION

5.1 FACILITIES

All measurement facilities used to collect the measurement data are located at

No.989-1, Wenshan Rd., Shangshan Village,
Qionglin Township, Hsinchu County 30741, Taiwan (R.O.C.)

The sites are constructed in conformance with the requirements of ANSI C63.10:2013 and CISPR 22. All receiving equipment conforms to CISPR 16-1-1, CISPR 16-1-2, CISPR 16-1-3, CISPR 16-1-4, CISPR 16-1-5.

5.2 ACCREDITATIONS

Our laboratories are accredited and approved by the following approval agencies according to ISO/IEC 17025.

Taiwan	TAF
---------------	-----

The measuring facility of laboratories has been authorized or registered by the following approval agencies.

Canada	INDUSTRY CANADA
Japan	VCCI
Taiwan	BSMI
USA	FCC MRA

Copies of granted accreditation certificates are available for downloading from our web site, <http://www.ccsrf.com>

Remark: FCC Designation Number TW1027.



5.3 MEASUREMENT UNCERTAINTY

The following table is for the measurement uncertainty, which is calculated as per the document CISPR 16-4-2.

PARAMETER	UNCERTAINTY
Semi Anechoic Chamber (966 Chamber_C) / Radiated Emission, 30 to 1000 MHz	+/- 3.97
Semi Anechoic Chamber (966 Chamber_C) / Radiated Emission, 1 to 18GHz	+/- 3.58
Semi Anechoic Chamber (966 Chamber_C) / Radiated Emission, 18 to 26 GHz	+/- 3.59
Semi Anechoic Chamber (966 Chamber_C) / Radiated Emission, 26 to 40 GHz	+/- 3.81
Conducted Emission (Mains Terminals), 9kHz to 30MHz	+/- 2.48

This uncertainty represents an expanded uncertainty expressed at approximately the 95% confidence level using a coverage factor of k=2.

Consistent with industry standard (e.g. CISPR 22, clause 11, Measurement Uncertainty) determining compliance with the limits shall be base on the results of the compliance measurement. Consequently the measure emissions being less than the maximum allowed emission result in this be a compliant test or passing test.

The acceptable measurement uncertainty value without requiring revision of the compliance statement is base on conducted and radiated emissions being less than U_{CISPR} which is 3.6dB and 5.2dB respectively. CCS values (called U_{Lab} in CISPR 16-4-2) is less than U_{CISPR} as shown in the table above. Therefore, MU need not be considered for compliance.



6. SETUP OF EQUIPMENT UNDER TEST

SUPPORT EQUIPMENT

No.	Product	Manufacturer	Model No.	Serial No.
1	Notebook PC	TOSHIBA	M840	9C104267C
2	Notebook PC	TOSHIBA	PORTEGE R30-A	1E101235H
3	Notebook PC	HP	ProBook 4421s	CNF03242PJ
4	Notebook PC	IBM (Lenovo)	ThinkPad T61 7663-AS6	L3F3864
5	CMTS	ZyXEL	IES-1000	S2Z3322195
6	USB2.0 Flash Disk	Kingston	DTSE9H/8GB	---

No.	Power & Signal Cable Description
1	Non-shielded RJ-45 cable, 12m × 2
2	Non-shielded RJ-45 cable, 1.5m × 3
3	Non-shielded RJ-11 cable, 12m × 1

SETUP DIAGRAM FOR TESTS

EUT & peripherals setup diagram is shown in appendix setup photos.

EUT OPERATING CONDITION

RF Mode :

1. EUT & peripherals setup diagram is shown in appendix setup photos.
2. Run Test software. “ Mtool

TX Mode:

⇒ **Tx Data Rate:**

- CCK 1Mbps Bandwidth 20 (IEEE 802.11b mode)
- OFDM 6Mbps Bandwidth 20 (IEEE 802.11g mode)
- MCS8 13Mbps Bandwidth 20 (IEEE 802.11gn HT20 mode)
- MCS8 27Mbps Bandwidth 40 (IEEE 802.11gn HT20 mode)

⇒ **Power control**

- IEEE 802.11b Channel Low (2412MHz) Chain0 Power set 58
- IEEE 802.11b Channel Mid (2442MHz) Chain0 Power set 60
- IEEE 802.11b Channel High (2462MHz) Chain0 Power set 60
- IEEE 802.11g Channel Low (2412MHz) Chain0/Chain1 Power set 46
- IEEE 802.11g Channel Mid (2442MHz) Chain0/Chain1 Power set 70
- IEEE 802.11g Channel High (2462MHz) Chain0/Chain1 Power set 46



IEEE 802.11n HT20 Channel Low (2412MHz) Chain0/Chain1 Power set 48
IEEE 802.11n HT20 Channel Mid (2442MHz) Chain0/Chain1 Power set 72
IEEE 802.11n HT20 Channel High (2462MHz) Chain0/Chain1 Power set 48
IEEE 802.11n HT40 Channel Low (2422MHz) Chain0/Chain1 Power set 42
IEEE 802.11n HT40 Channel Mid (2442MHz) Chain0/Chain1 Power set 60
IEEE 802.11n HT40 Channel High (2452MHz) Chain0/Chain1 Power set 42

3. All of the functions are under run.
4. Start test.

Normal Mode :

All the equipment/cables were placed in the worst-case configuration to maximize the emission during the test. Grounding was established in accordance with the manufacturer's requirements and conditions for the intended use.

1. EUT & peripherals setup diagram is shown in appendix setup photos.
2. EUT RJ-45 port link to Notebook PC 1, 2 (DHCP).
2. EUT link to Notebook PC 3 with WiFi (DHCP).
4. CMTS RJ-45 port link to Notebook PC 4 (IP192.168.1.XXX).
5. EUT RJ-11 port link to CMTS.
6. Notebook PC 1, 2, 3 ping Notebook PC 4 192.168.1.xxx.
7. All of the functions are under run.
8. Start test.



7. FCC PART 15.247 REQUIREMENTS

7.1 6dB BANDWIDTH

LIMITS

§ 15.247(a) (2) For direct sequence systems, the minimum 6dB bandwidth shall be at least 500kHz.

TEST EQUIPMENT

Name of Equipment	Manufacturer	Model	Serial Number	Calibration Due
EXA Signal Analyzer	Agilent	N9010A	MY52220817	03/19/2016

Remark: Each piece of equipment is scheduled for calibration once a year.

TEST SETUP



TEST PROCEDURE

1. The transmitter output was connected to a spectrum analyzer.
2. Set RBW = 100 kHz.
3. Set the video bandwidth (VBW) $\geq 3 \times$ RBW.
4. Detector = Peak.
5. Trace mode = max hold.
6. Sweep = auto couple.
7. Allow the trace to stabilize.
8. Measure the maximum width of the emission that is constrained by the frequencies associated with the two outermost amplitude points (upper and lower frequencies) that are attenuated by 6 dB relative to the maximum level measured in the fundamental emission.



TEST RESULTS

IEEE 802.11b Mode

Channel	Channel Frequency (MHz)	6dB Bandwidth (MHz)	Minimum Limit (kHz)	Pass / Fail
		Chain 0		
Low	2412	8.0450	500	PASS
Middle	2437	8.0340	500	PASS
High	2462	8.0720	500	PASS

IEEE 802.11g Mode (Two TX)

Channel	Channel Frequency (MHz)	6dB Bandwidth (MHz)		Minimum Limit (kHz)	Pass / Fail
		Chain 0	Chain 1		
Low	2412	14.1200	15.6600	500	PASS
Middle	2437	16.3200	15.0500	500	PASS
High	2462	15.6700	15.0900	500	PASS

IEEE 802.11gn HT20 Mode (Two TX)

Channel	Channel Frequency (MHz)	6dB Bandwidth (MHz)		Minimum Limit (kHz)	Pass / Fail
		Chain 0	Chain 1		
Low	2412	16.0100	15.0700	500	PASS
Middle	2437	14.1600	15.6100	500	PASS
High	2462	14.1900	16.6700	500	PASS

IEEE 802.11gn HT40 Mode (Two TX)

Channel	Channel Frequency (MHz)	6dB Bandwidth (MHz)		Minimum Limit (kHz)	Pass / Fail
		Chain 0	Chain 1		
Low	2422	36.0000	36.3300	500	PASS
Middle	2437	34.4400	34.1900	500	PASS
High	2452	36.3200	35.0700	500	PASS



6dB BANDWIDTH

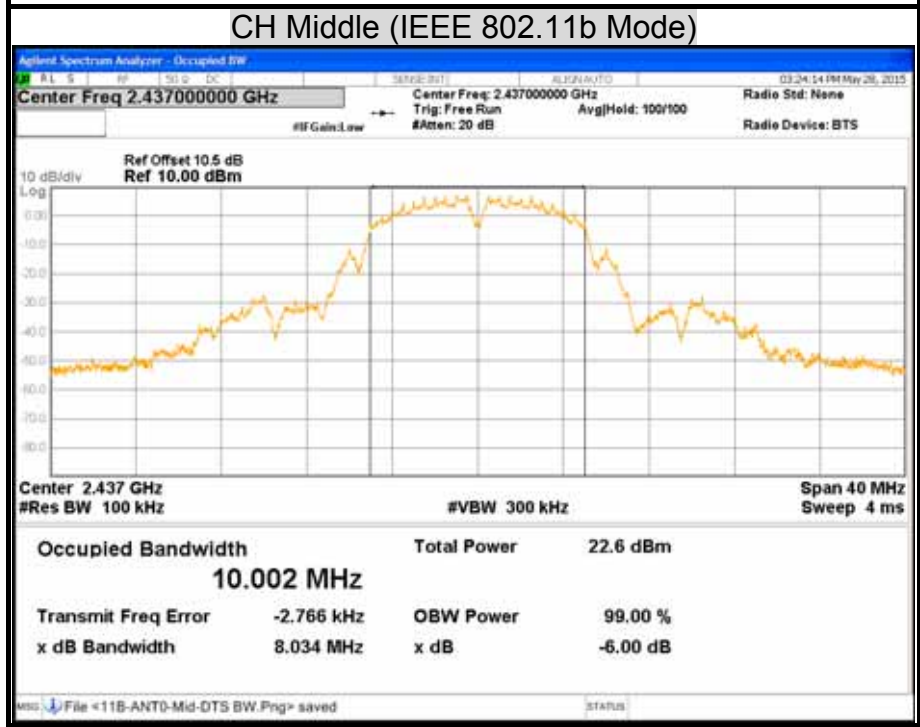
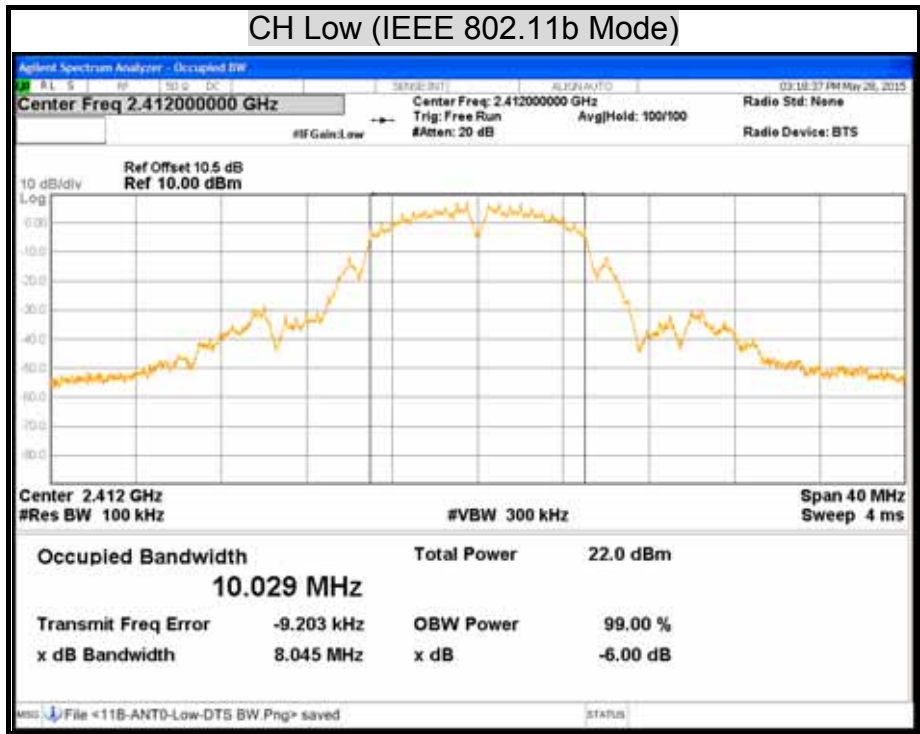

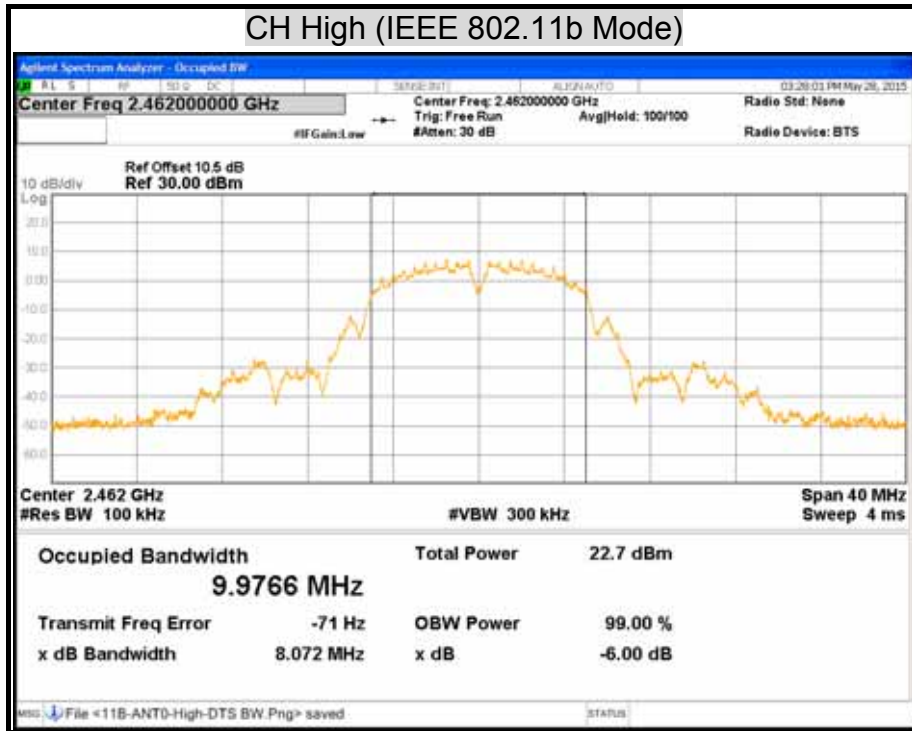



CH Low (IEEE 802.11g Mode / Chain 0)

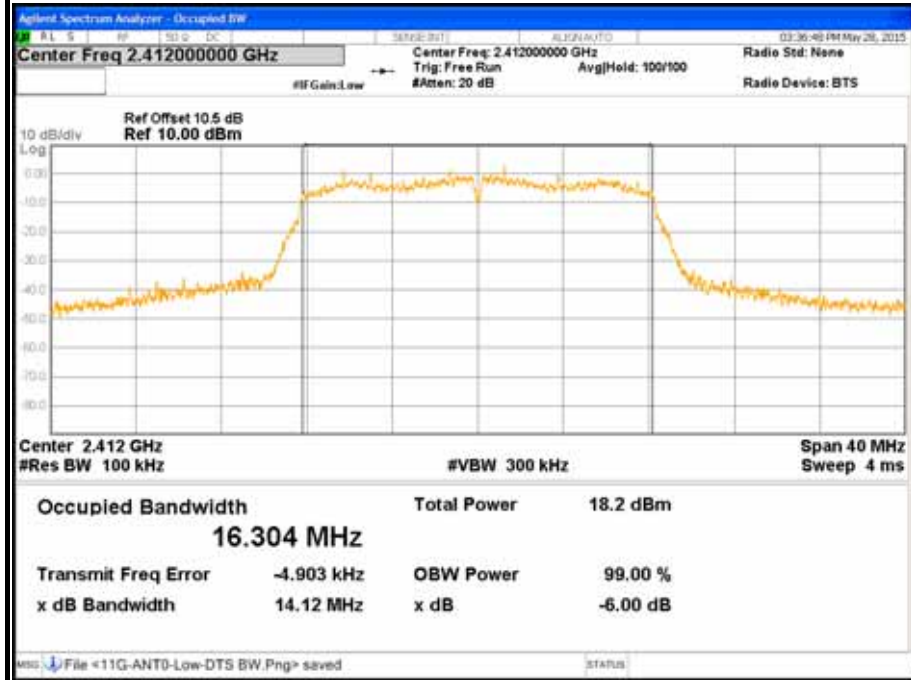

CH Middle (IEEE 802.11g Mode / Chain 0)

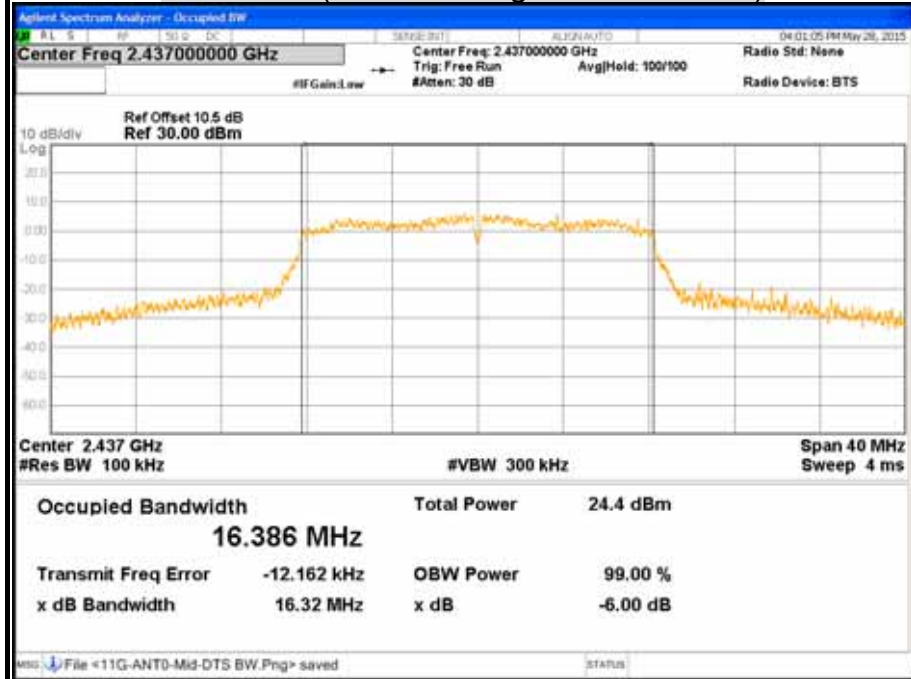

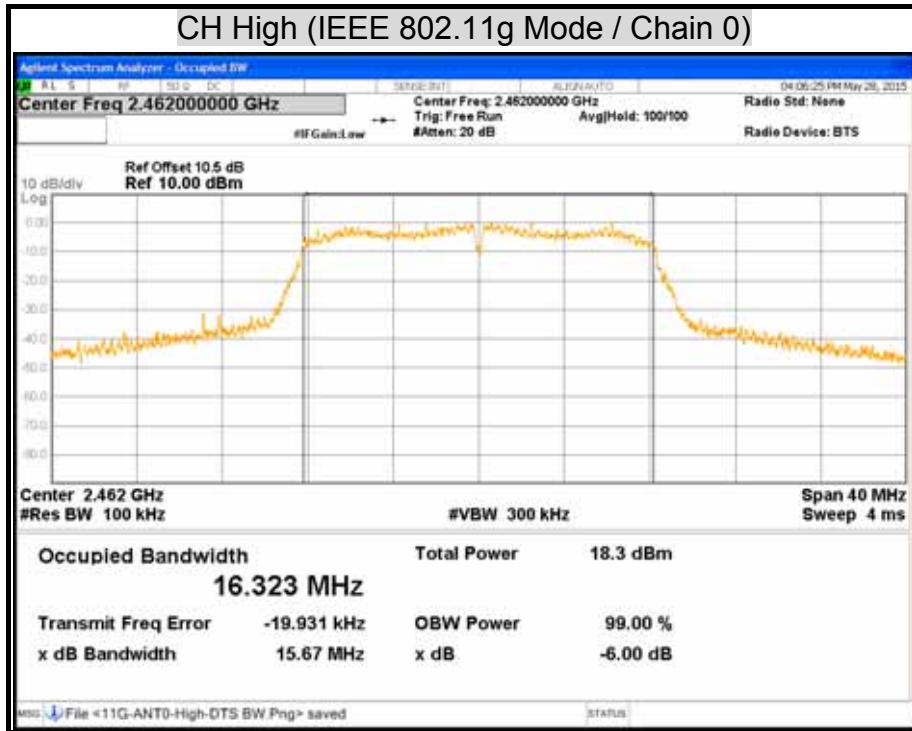

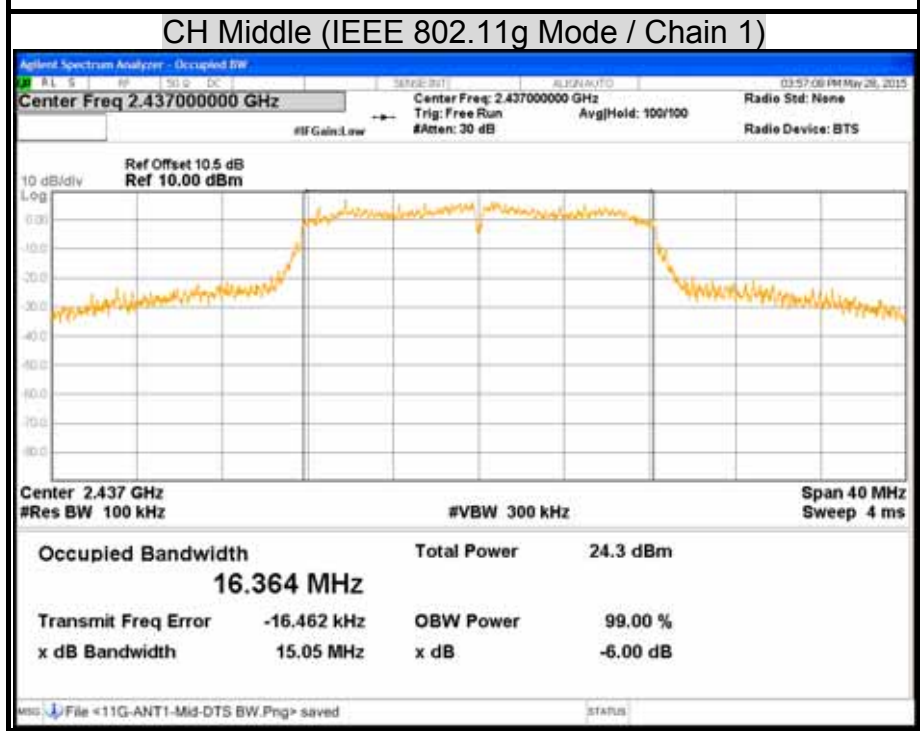
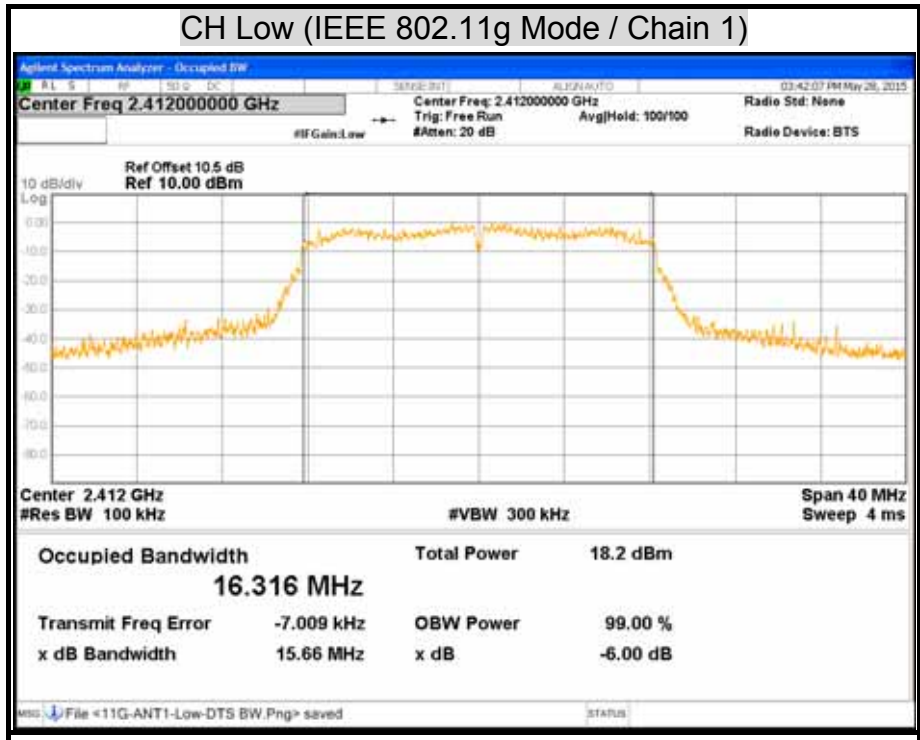

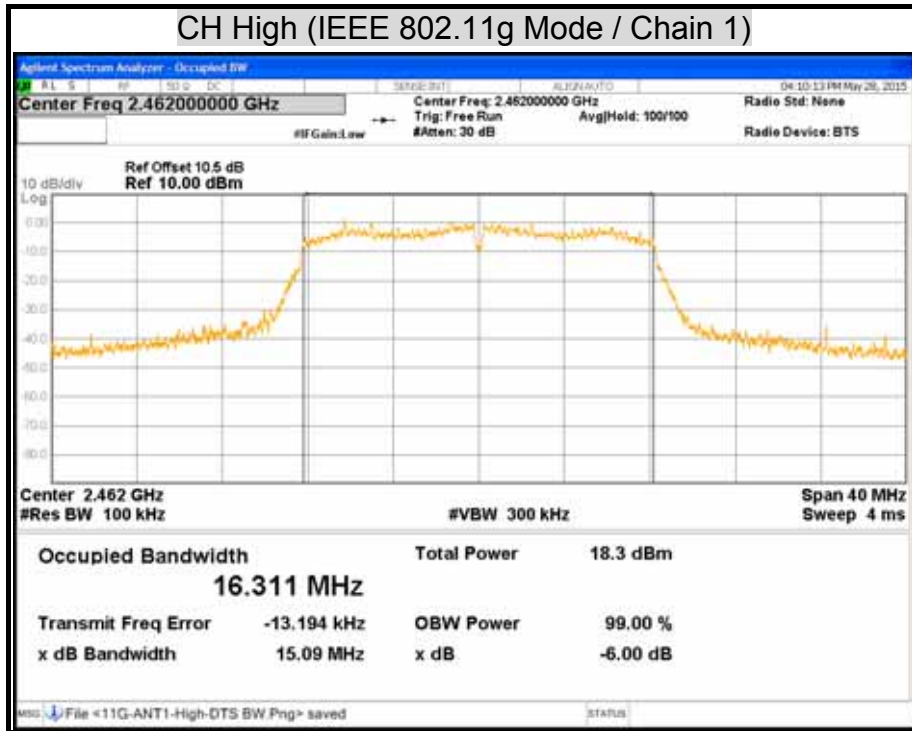

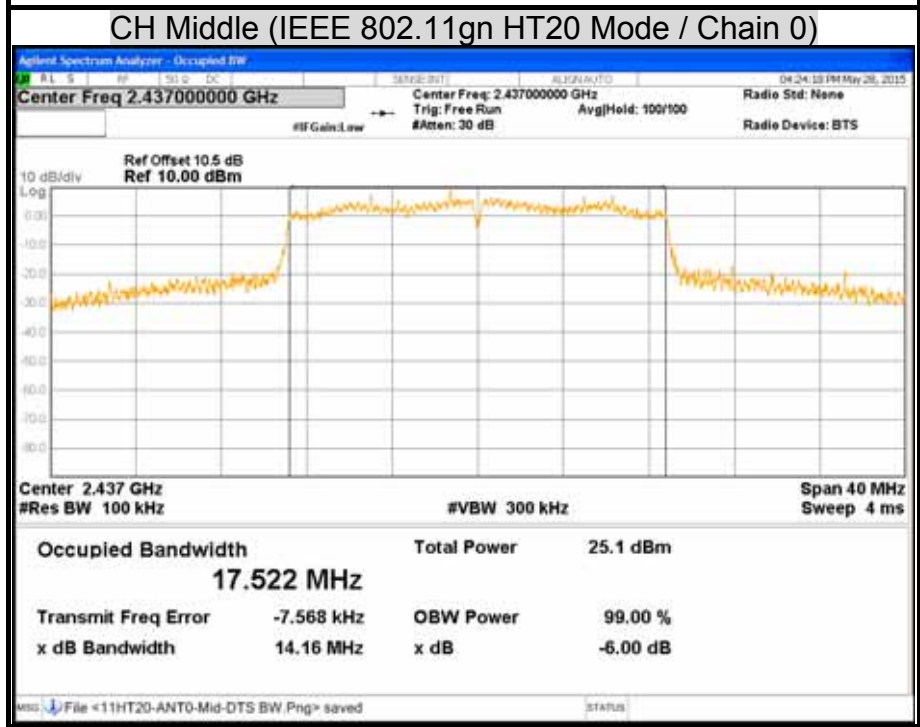
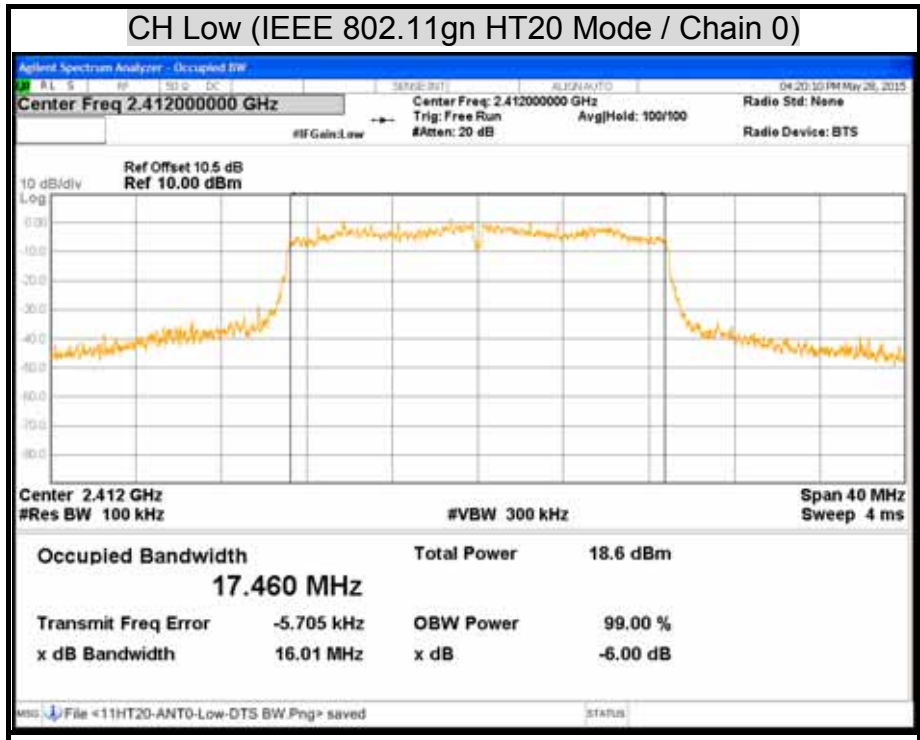

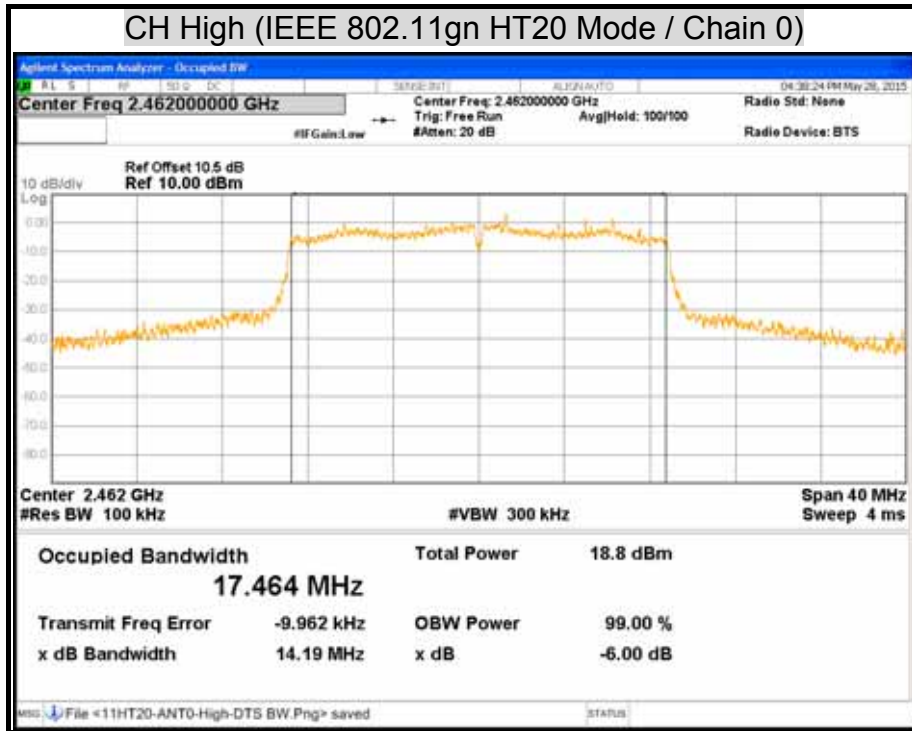

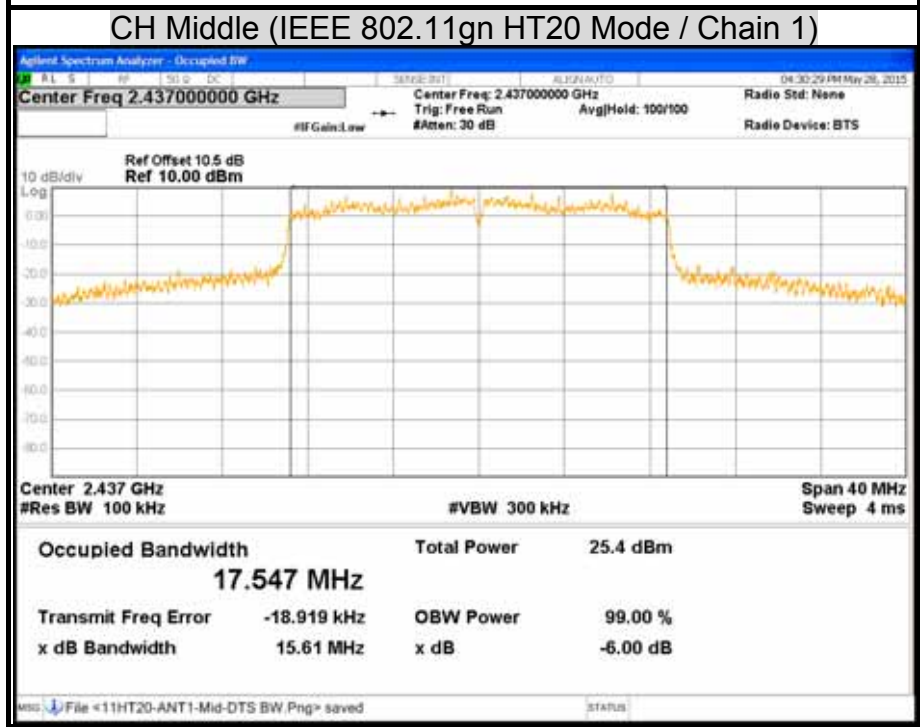
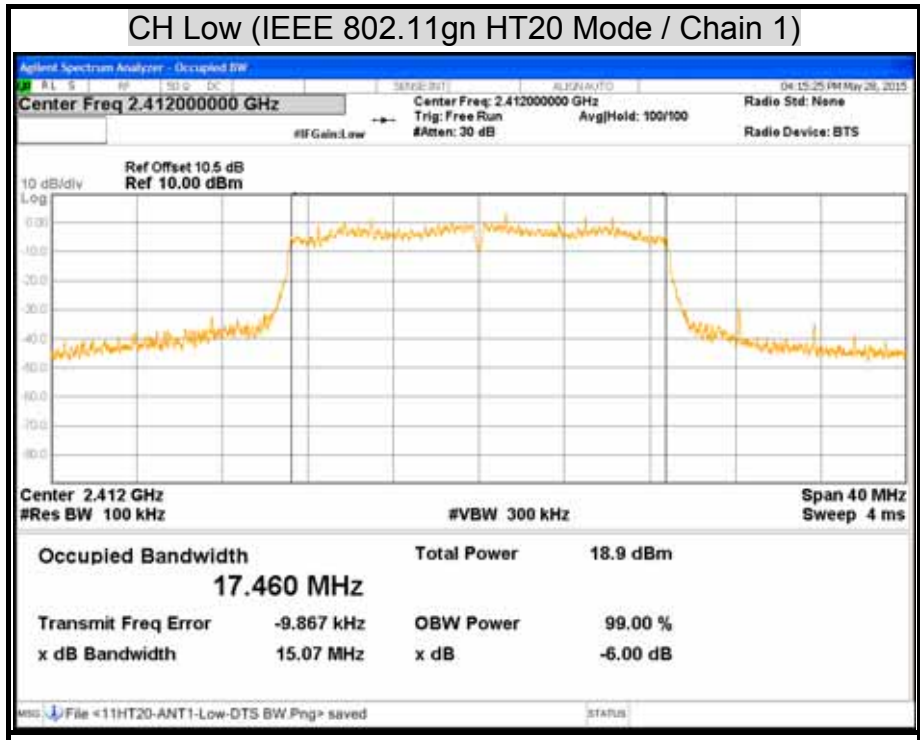

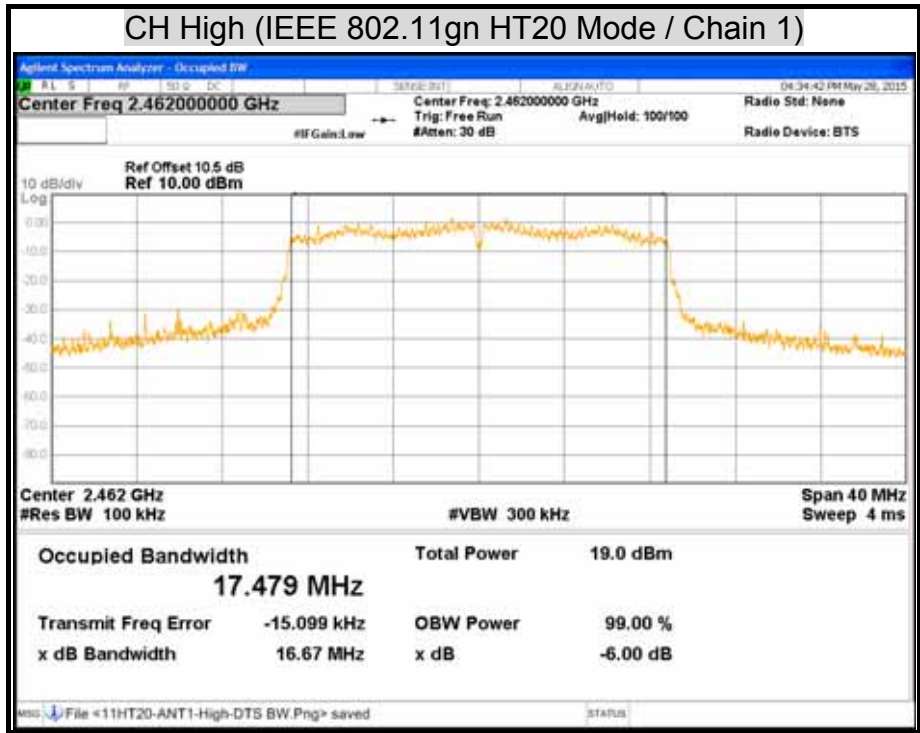

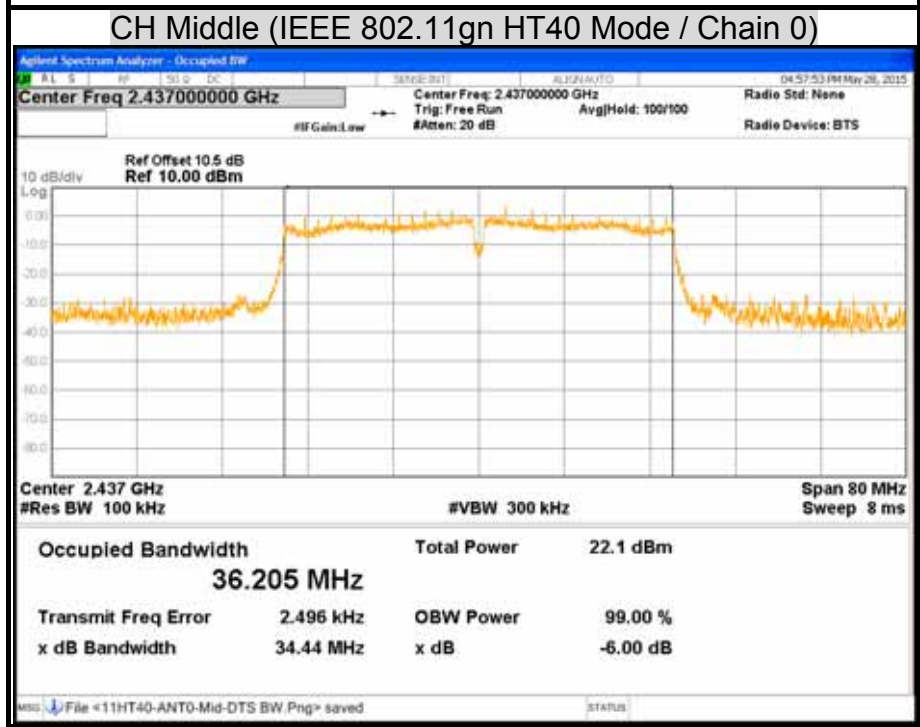
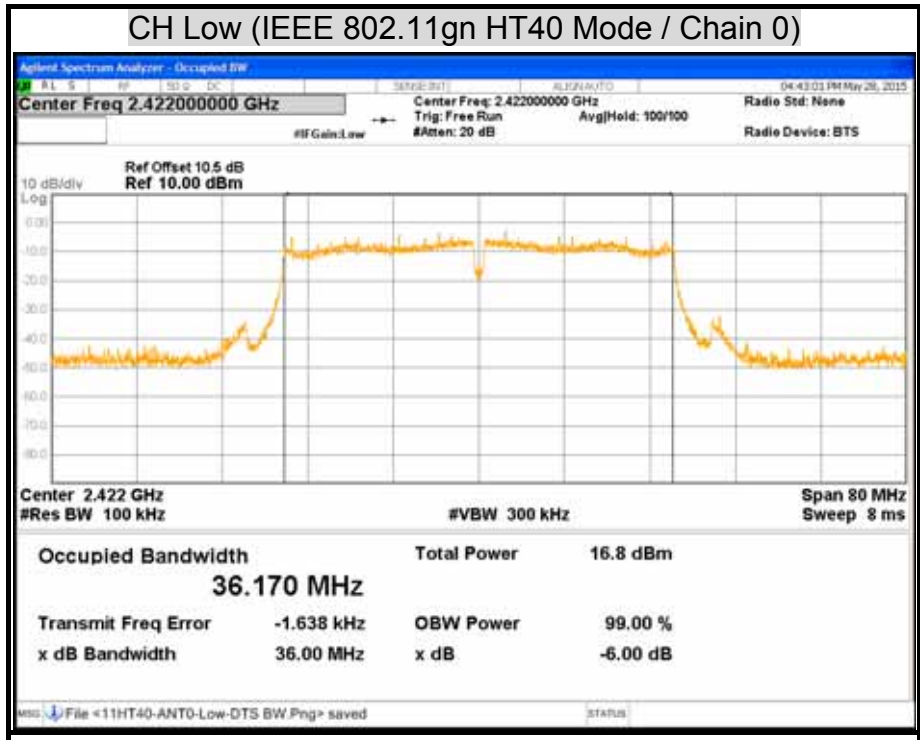

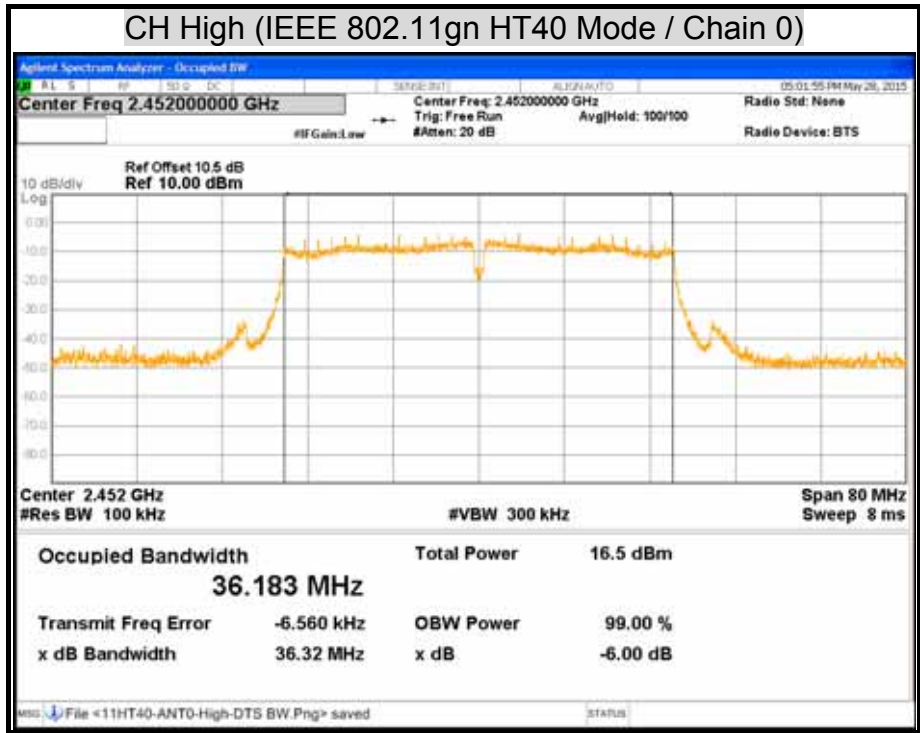

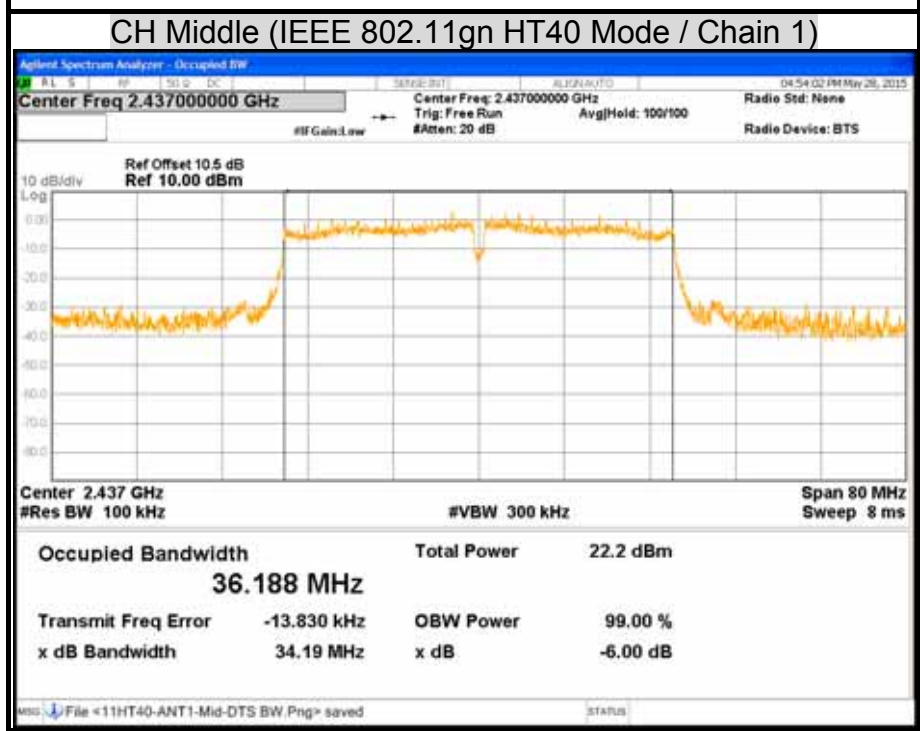
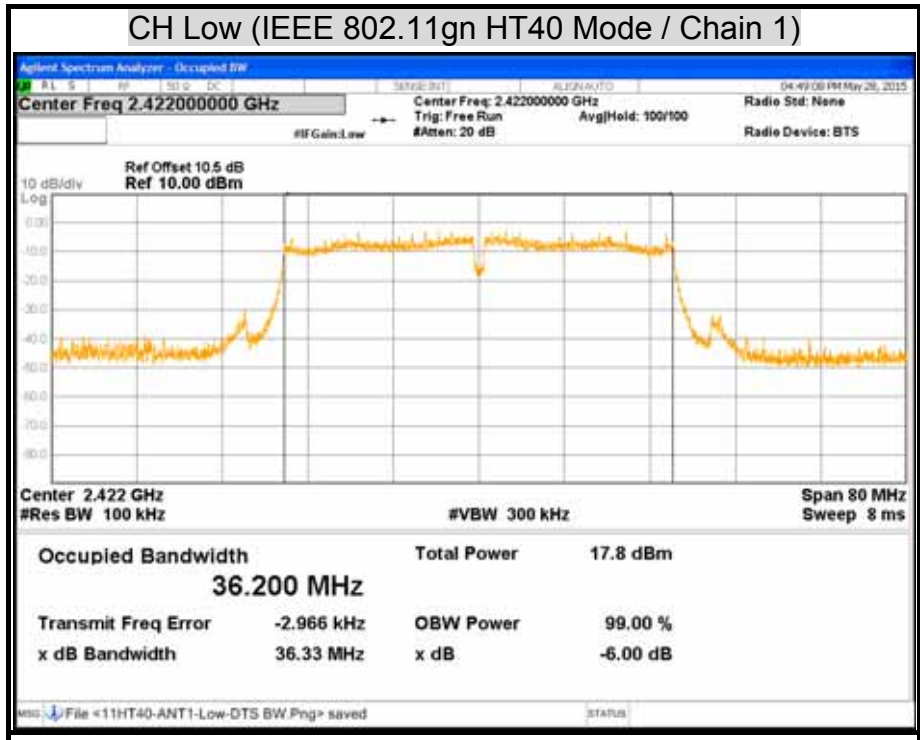

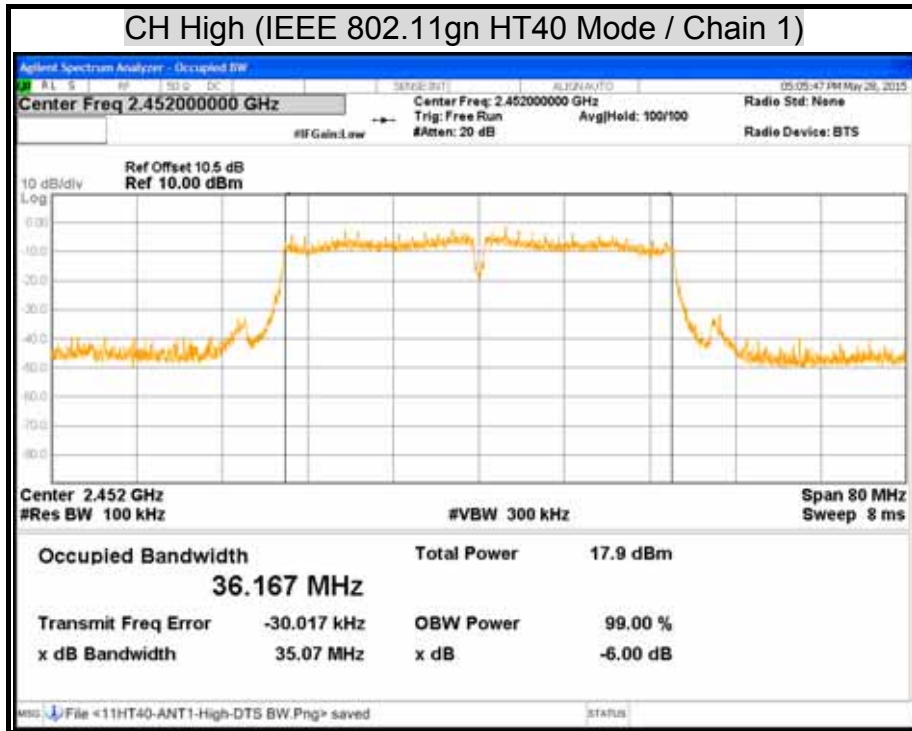



7.2 MAXIMUM PEAK OUTPUT POWER

LIMITS

§ 15.247(b) The maximum peak output power of the intentional radiator shall not exceed the following :

§ 15.247(b) (3) For systems using digital modulation in the 902-928 MHz, 2400-2483.5 MHz, and 5725-5850 MHz bands : 1 watt.

§ 15.247(b) (4) Except as shown in paragraphs (c) of this section, if transmitting antennas of directional gain greater than 6 dBi are used the peak output power from the intentional radiator shall be reduced below the stated values in paragraphs (b)(1) or (b)(2), and (b)(3) of this section, as appropriate, by the amount in dB that the directional gain of the antenna exceeds 6 dBi.

TEST EQUIPMENT

Name of Equipment	Manufacturer	Model	Serial Number	Calibration Due
Power Meter	Anritsu	ML2495A	1149001	12/11/2015
Power Sensor	Anritsu	MA2411B	1126148	12/11/2015

Remark: Each piece of equipment is scheduled for calibration once a year.

TEST SETUP



TEST PROCEDURE

The transmitter output is connected to the power meter. The power meter is set to the peak power detection.



TEST RESULTS

IEEE 802.11b Mode

Channel	Channel Frequency (MHz)	Peak Power (dBm)		Peak Power Limit		Pass / Fail
		Chain 0		(dBm)	(W)	
		(dBm)	(W)			
Low	2412	18.07	0.0641	30	1	PASS
Middle	2437	18.55	0.0716	30	1	PASS
High	2462	18.71	0.0743	30	1	PASS

Remark:

1. At final test to get the worst-case emission at 1Mbps.
2. The cable assembly insertion loss of 10.5dB (including 10 dB pad and 0.5 dB cable) was Entered as an offset in the power meter to allow for direct reading of power.

IEEE 802.11g Mode (Two TX)

Channel	Channel Frequency (MHz)	Peak Power (dBm)		Peak Power Total		Peak Power Limit		Pass / Fail
		Chain 0	Chain 1	(dBm)	(W)	(dBm)	(W)	
Low	2412	19.39	19.68	22.55	0.1799	30	1	PASS
Middle	2437	25.47	25.65	28.57	0.7194	30	1	PASS
High	2462	19.49	19.68	22.60	0.1820	30	1	PASS

Remark:

1. At final test to get the worst-case emission at 6Mbps.
2. The cable assembly insertion loss of 10.5dB (including 10 dB pad and 0.5 dB cable) was Entered as an offset in the power meter to allow for direct reading of power.
3. Array gain = 0 dB for NANT ≤ 4, power limit do not reduce.
4. Total peak power = Chain 0 + Chain 1.



IEEE 802.11gn HT20 Mode (Two TX)

Channel	Channel Frequency (MHz)	Peak Power (dBm)		Peak Power Total		Peak Power Limit		Pass / Fail
		Chain 0	Chain 1	(dBm)	(W)	(dBm)	(W)	
Low	2412	19.71	20.13	22.94	0.1968	30	1	PASS
Middle	2437	26.02	26.57	29.31	0.8531	30	1	PASS
High	2462	19.83	20.44	23.16	0.2070	30	1	PASS

Remark:

1. At final test to get the worst-case emission at 6.5Mbps.
2. The cable assembly insertion loss of 10.5dB (including 10 dB pad and 0.5 dB cable) was Entered as an offset in the power meter to allow for direct reading of power.
3. Array gain = 0 dB for NANT ≤ 4, power limit do not reduce.
4. Total peak power = Chain 0 + Chain 1.

IEEE 802.11gn HT40 Mode (Two TX)

Channel	Channel Frequency (MHz)	Peak Power (dBm)		Peak Power Total		Peak Power Limit		Pass / Fail
		Chain 0	Chain 1	(dBm)	(W)	(dBm)	(W)	
Low	2422	17.97	18.85	21.44	0.1393	30	1	PASS
Middle	2437	22.97	23.27	26.13	0.4102	30	1	PASS
High	2452	17.53	18.97	21.32	0.1355	30	1	PASS

Remark:

1. At final test to get the worst-case emission at 13.5Mbps.
2. The cable assembly insertion loss of 10.5dB (including 10 dB pad and 0.5 dB cable) was Entered as an offset in the power meter to allow for direct reading of power.
3. Array gain = 0 dB for NANT ≤ 4, power limit do not reduce.
4. Total peak power = Chain 0 + Chain 1.



7.3 AVERAGE POWER

LIMITS

None; for reporting purposes only.

TEST EQUIPMENT

Name of Equipment	Manufacturer	Model	Serial Number	Calibration Due
Power Meter	ANRITSU	ML2495A	1149001	12/11/2015
Power Sensor	ANRITSU	MA2411B	1126148	12/11/2015

Remark: Each piece of equipment is scheduled for calibration once a year.

TEST SETUP



TEST PROCEDURE

The transmitter output is connected to the power meter. The power meter is set to the average power detection.



TEST RESULTS

IEEE 802.11b Mode

Channel	Channel Frequency (MHz)	Average Power (dBm)
	Chain 0	
Low	2412	15.46
Middle	2437	16.04
High	2462	16.27

Remark:

1. At final test to get the worst-case emission at 1Mbps.
2. The cable assembly insertion loss of 10.5 dB (including 10 dB pad and 0.5 dB cable) was Entered as an offset in the power meter to allow for direct reading of power.

IEEE 802.11g Mode (Two TX)

Channel	Channel Frequency (MHz)	Average Power Output (dBm)		Average Power Total (dBm)
		Chain 0	Chain 1	
Low	2412	12.38	12.37	15.38
Middle	2437	18.58	18.42	21.51
High	2462	12.39	12.41	15.41

Remark:

1. At final test to get the worst-case emission at 6Mbps.
2. The cable assembly insertion loss of 10.5 dB (including 10 dB pad and 0.5 dB cable) was Entered as an offset in the power meter to allow for direct reading of power.



IEEE 802.11gn HT20 Mode (Two TX)

Channel	Channel Frequency (MHz)	Average Power Output (dBm)		Average Power Total (dBm)
		Chain 0	Chain 1	
Low	2412	12.79	12.71	15.76
Middle	2437	19.26	19.18	22.23
High	2462	12.81	12.91	15.87

Remark:

1. At final test to get the worst-case emission at 6.5Mbps.
2. The cable assembly insertion loss of 10.5 dB (including 10 dB pad and 0.5 dB cable) was Entered as an offset in the power meter to allow for direct reading of power.

IEEE 802.11gn HT40 Mode (Two TX)

Channel	Channel Frequency (MHz)	Average Power Output (dBm)		Average Power Total (dBm)
		Chain 0	Chain 1	
Low	2422	10.85	11.35	14.12
Middle	2437	15.90	15.85	18.89
High	2452	10.46	11.44	13.99

Remark:

1. At final test to get the worst-case emission at 13.5Mbps.
2. The cable assembly insertion loss of 10.5 dB (including 10 dB pad and 0.5 dB cable) was Entered as an offset in the power meter to allow for direct reading of power.



7.4 POWER SPECTRAL DENSITY

LIMITS

§ 15.247(e) For digitally modulated systems, the power spectral density conducted from the intentional radiator to the antenna shall not greater than 8 dBm in any 3 kHz band during any time interval of continuous transmission.

TEST EQUIPMENT

Name of Equipment	Manufacturer	Model	Serial Number	Calibration Due
EXA Signal Analyzer	Agilent	N9010A	MY52220817	03/19/2016

Remark: Each piece of equipment is scheduled for calibration once a year.

TEST SETUP



TEST PROCEDURE

1. The transmitter output was connected to the spectrum analyzer.
2. Set analyzer center frequency to DTS channel center frequency.
3. Set the span to 1.5 times the DTS channel bandwidth.
4. Set the RBW to: $3 \text{ kHz} \leq \text{RBW} \leq 100 \text{ kHz}$.
5. Set the VBW $\geq 3 \times \text{RBW}$.
6. Detector = peak.
7. Sweep time = auto couple.
8. Trace mode = max hold.
9. Allow trace to fully stabilize.
10. Use the peak marker function to determine the maximum amplitude level within the RBW.
11. If measured value exceeds limit, reduce RBW (no less than 3 kHz) and repeat.



TEST RESULTS

IEEE 802.11b Mode

Channel	Channel Frequency (MHz)	Final RF Power Level in 3KHz BW (dBm)	Minimum Limit (dBm)	Pass / Fail
		Chain 0		
Low	2412	-1.703	8	PASS
Middle	2437	-0.885	8	PASS
High	2462	-0.379	8	PASS

Remark:

1. At final test to get the worst-case emission at 1Mbps.
2. The cable assembly insertion loss of 10.5dB (including 10 dB pad and 0.5 dB cable) was Entered as an offset in the spectrum analyzer to allow for direct reading of power.

IEEE 802.11g Mode (Two TX)

Channel	Channel Frequency (MHz)	Final RF Power Level in 3KHz BW (dBm)		PSD Total (dBm)	Minimum Limit (dBm)	Pass / Fail
		Chain 0	Chain 1			
Low	2412	-6.404	-6.437	-3.41	7.49	PASS
Middle	2437	0.814	-0.592	3.18	7.49	PASS
High	2462	-7.058	-7.121	-4.08	7.49	PASS

Remark:

1. At final test to get the worst-case emission at 6Mbps.
2. The cable assembly insertion loss of 10.5dB (including 10 dB pad and 0.5 dB cable) was Entered as an offset in the spectrum analyzer to allow for direct reading of power.
3. The Directional gain = GANT + Array Gain = 6.51dBi which is more than 6dBi, the limit should be 7.49dBm.
4. Total power spectral density = Chain 0 + Chain 1.



IEEE 802.11gn HT20 Mode (Two TX)

Channel	Channel Frequency (MHz)	Final RF Power Level in 3KHz BW (dBm)		PSD Total (dBm)	Minimum Limit (dBm)	Pass / Fail
		Chain 0	Chain 1			
Low	2412	-6.233	-4.876	-2.49	7.49	PASS
Middle	2437	0.772	0.324	3.56	7.49	PASS
High	2462	-6.525	-4.760	-2.54	7.49	PASS

Remark:

1. At final test to get the worst-case emission at 6.5Mbps.
2. The cable assembly insertion loss of 10.5dB (including 10 dB pad and 0.5 dB cable) was Entered as an offset in the spectrum analyzer to allow for direct reading of power.
3. The Directional gain = GANT + Array Gain = 6.51dBi which is more than 6dBi, the limit should be 7.49dBm.
4. Total power spectral density = Chain 0 + Chain 1.

IEEE 802.11gn HT40 Mode (Two TX)

Channel	Channel Frequency (MHz)	Final RF Power Level in 3KHz BW (dBm)		PSD Total (dBm)	Minimum Limit (dBm)	Pass / Fail
		Chain 0	Chain 1			
Low	2422	-9.812	-11.040	-7.37	7.49	PASS
Middle	2437	-5.842	-5.679	-2.75	7.49	PASS
High	2452	-12.280	-11.150	-8.67	7.49	PASS

Remark:

1. At final test to get the worst-case emission at 13.5Mbps.
2. The cable assembly insertion loss of 10.5dB (including 10 dB pad and 0.5 dB cable) was Entered as an offset in the spectrum analyzer to allow for direct reading of power.
3. The Directional gain = GANT + Array Gain = 6.51dBi which is more than 6dBi, the limit should be 7.49dBm.
4. Total power spectral density = Chain 0 + Chain 1.



POWER SPECTRAL DENSITY

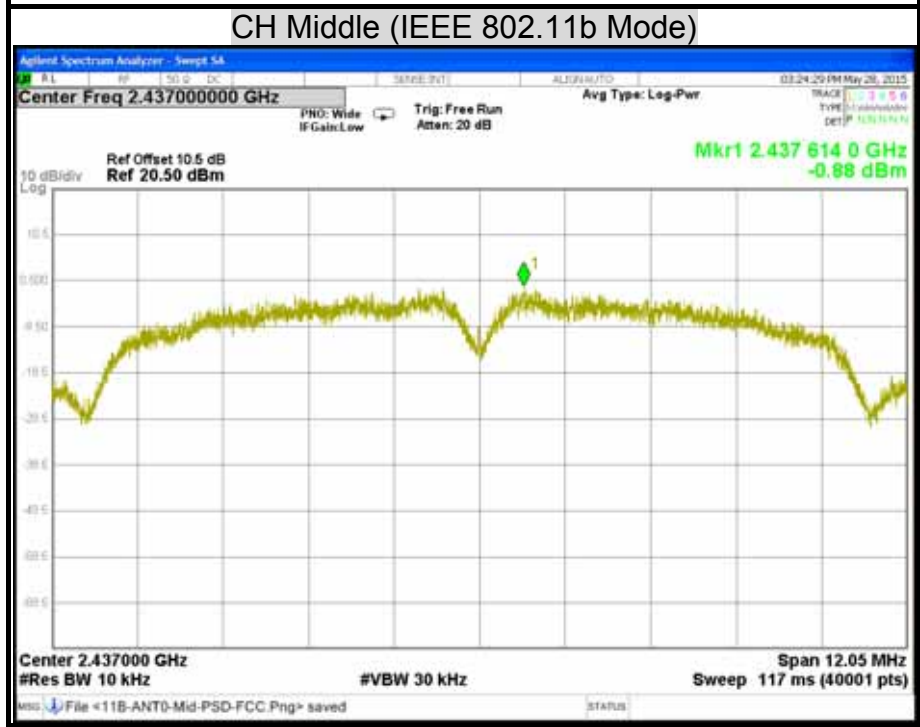
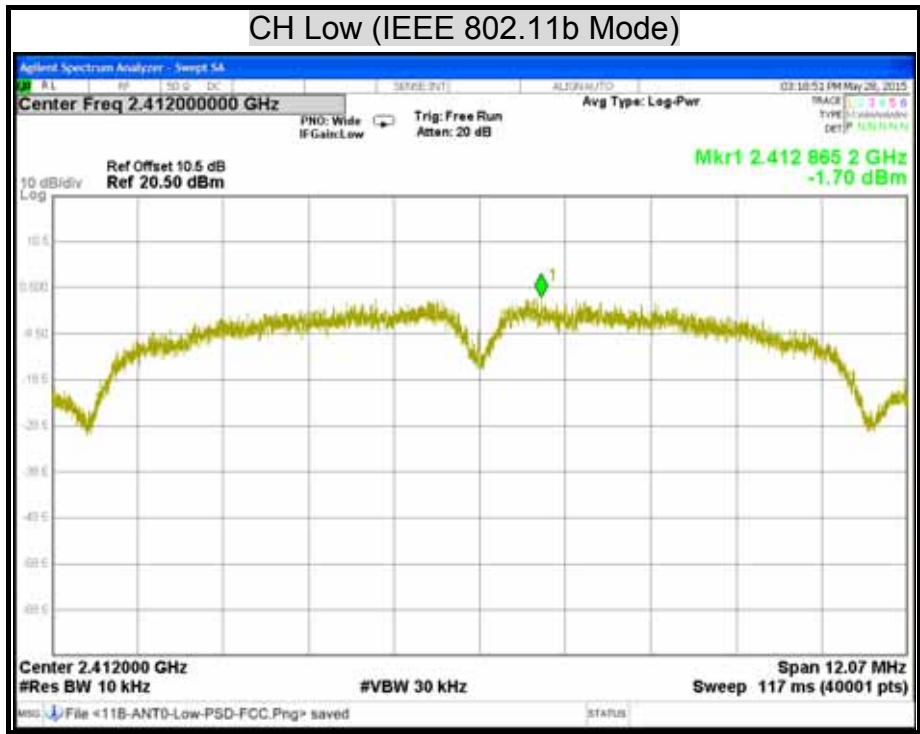

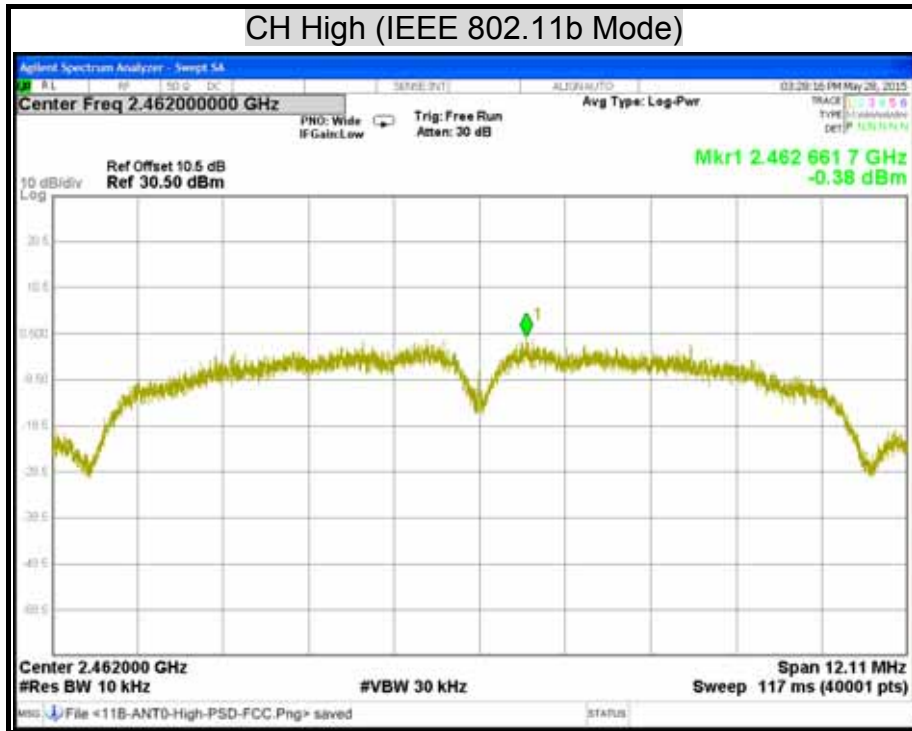

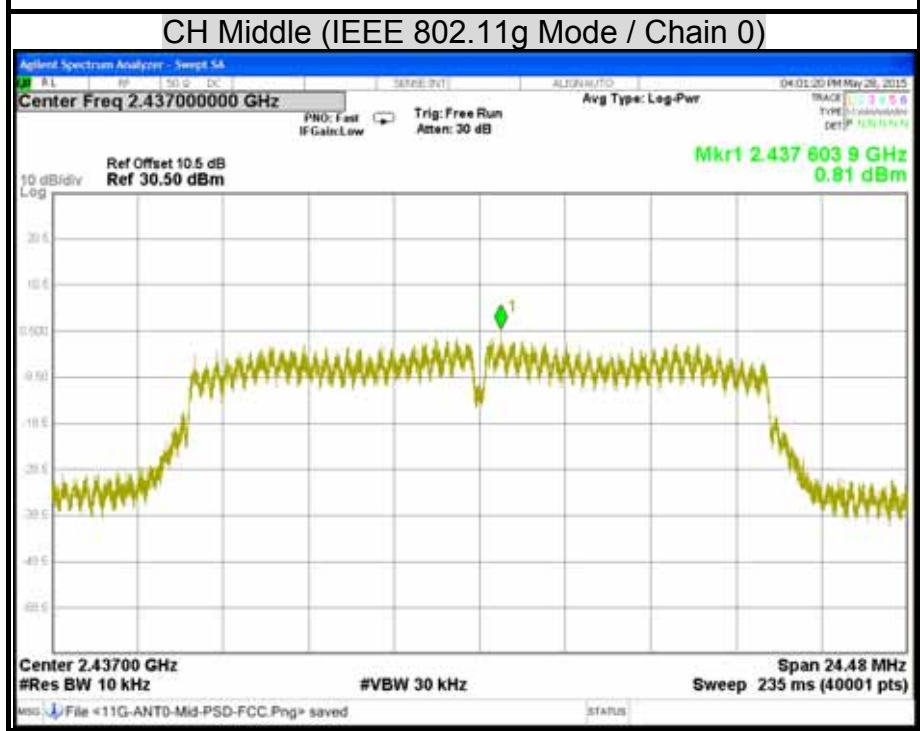
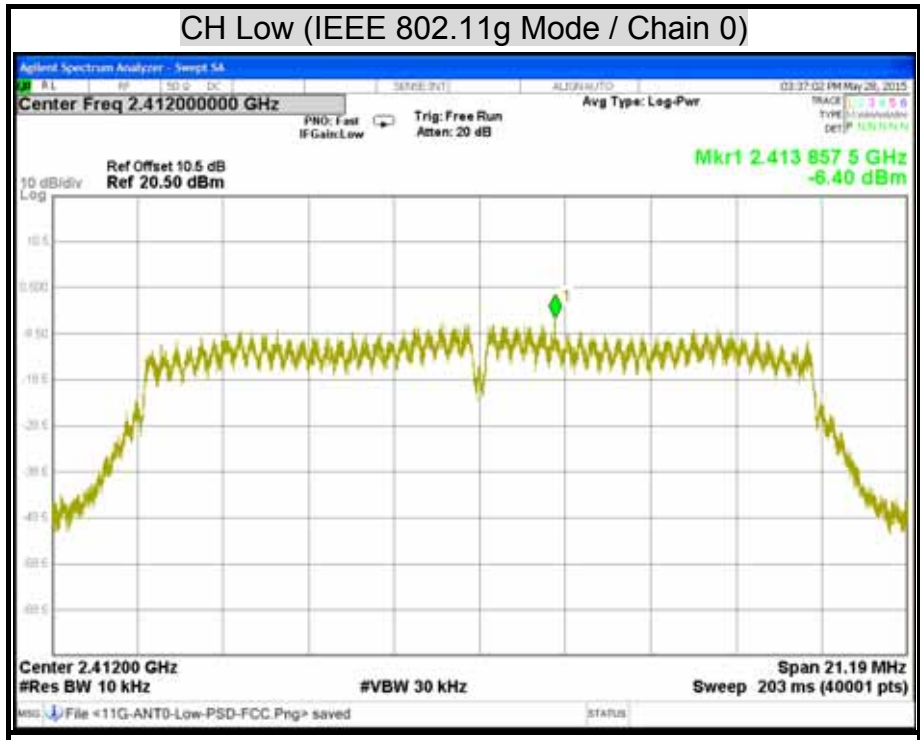

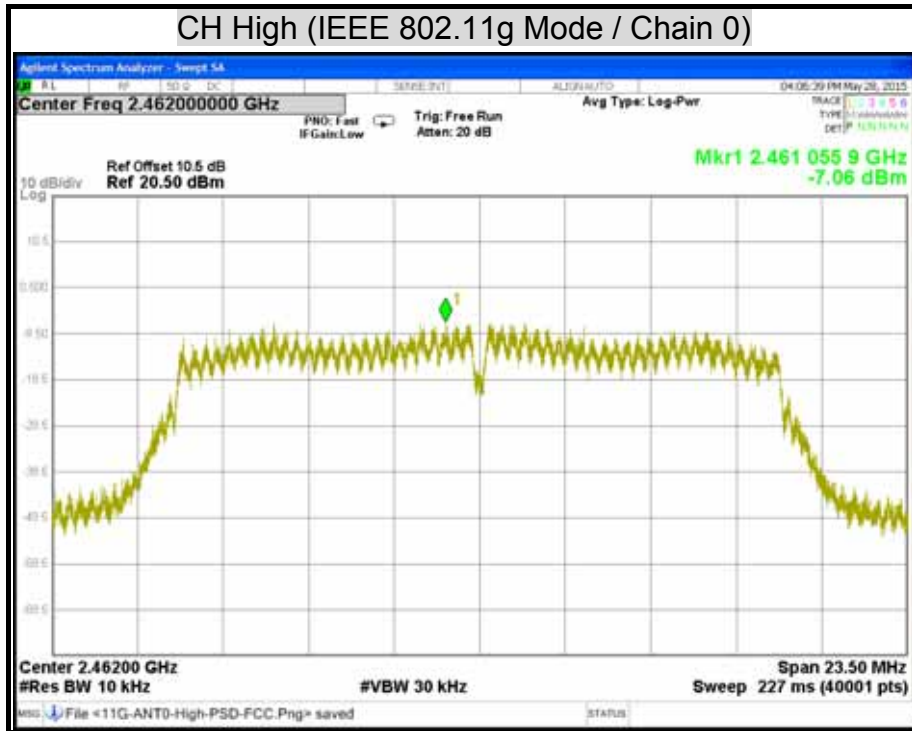

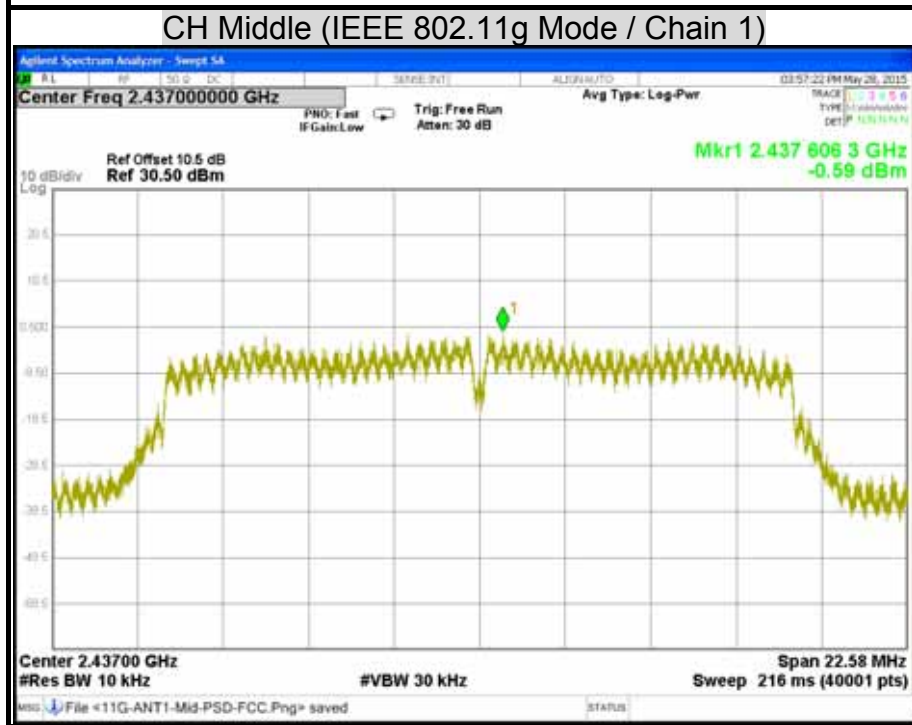
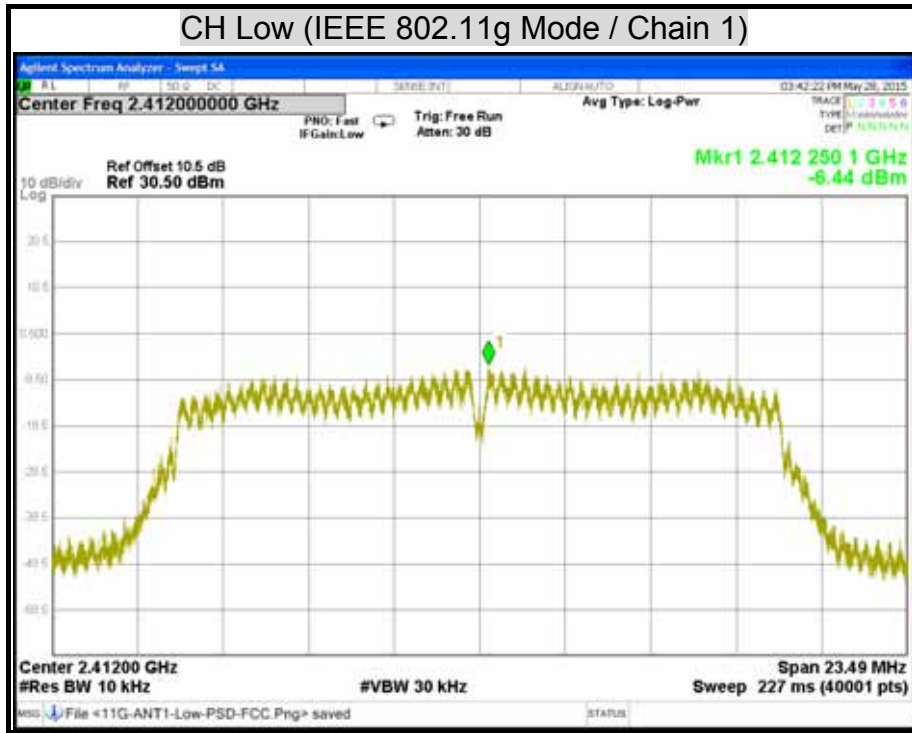

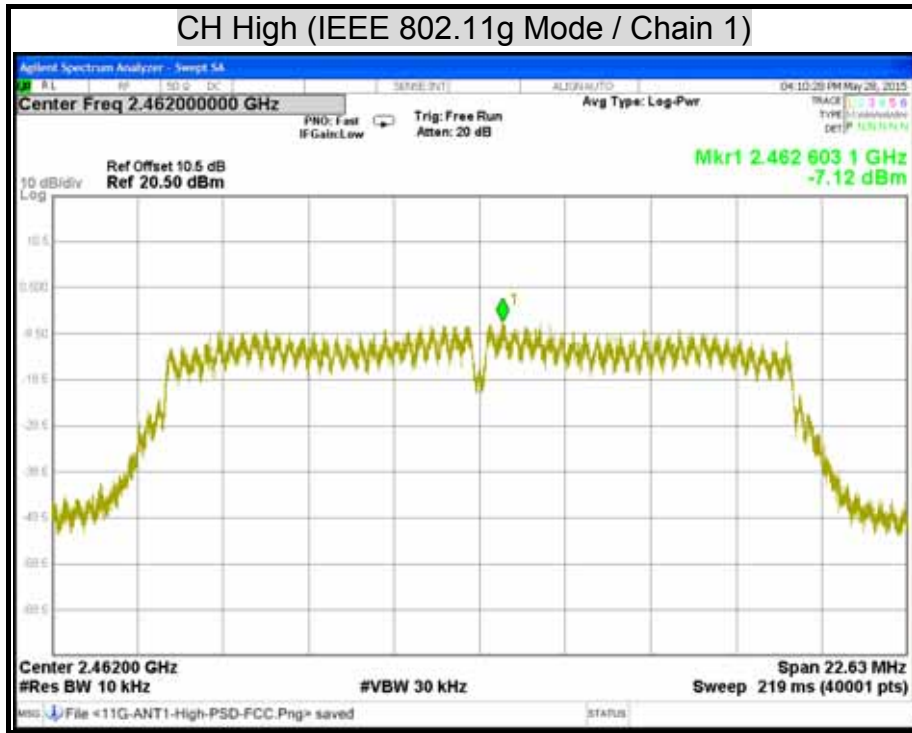

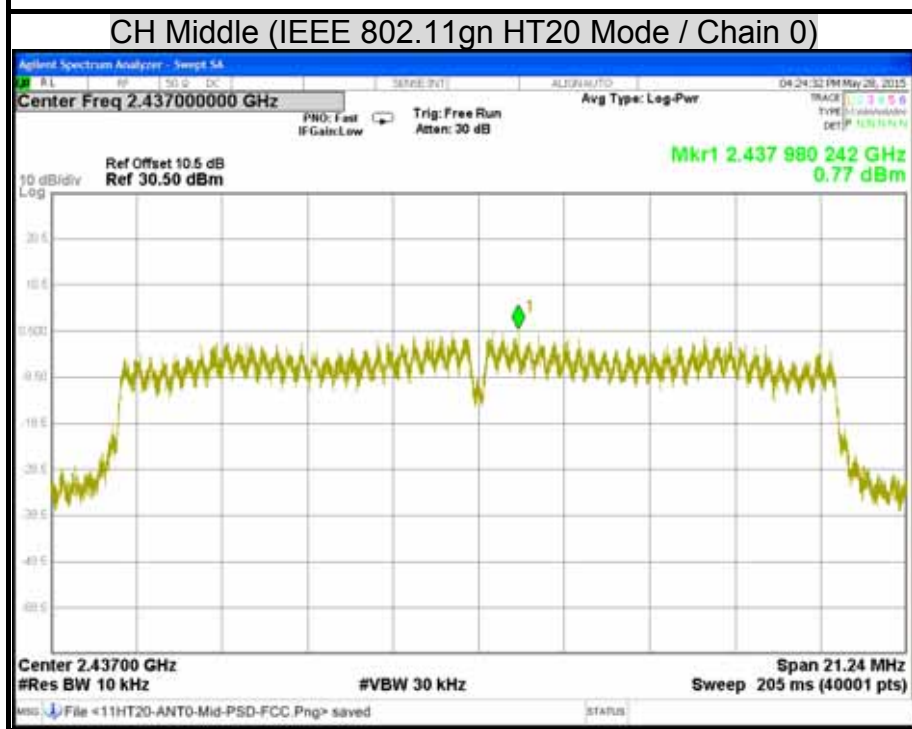
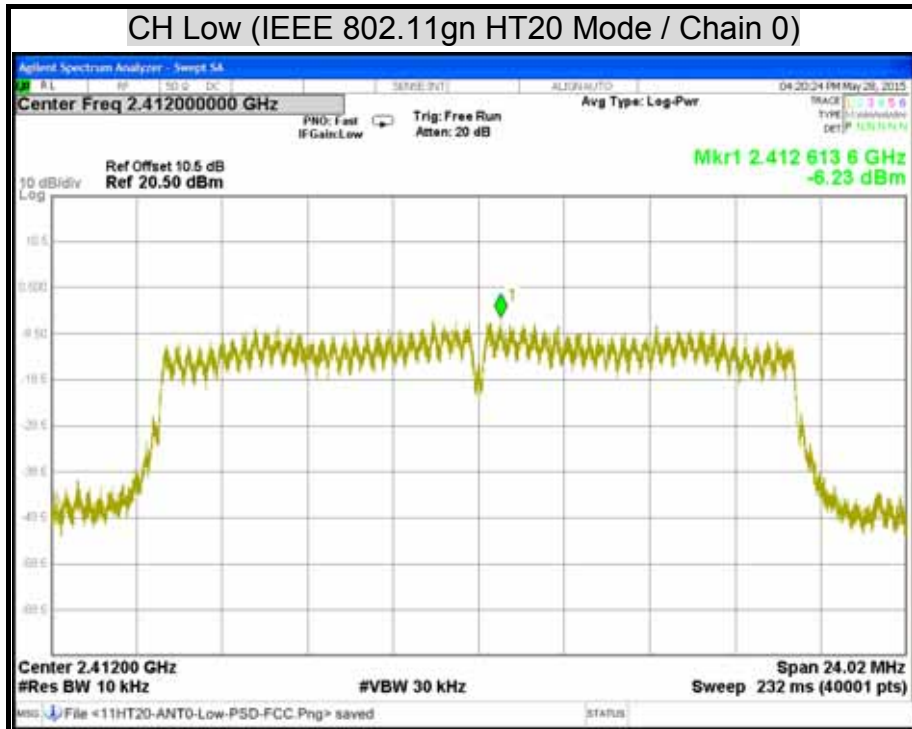

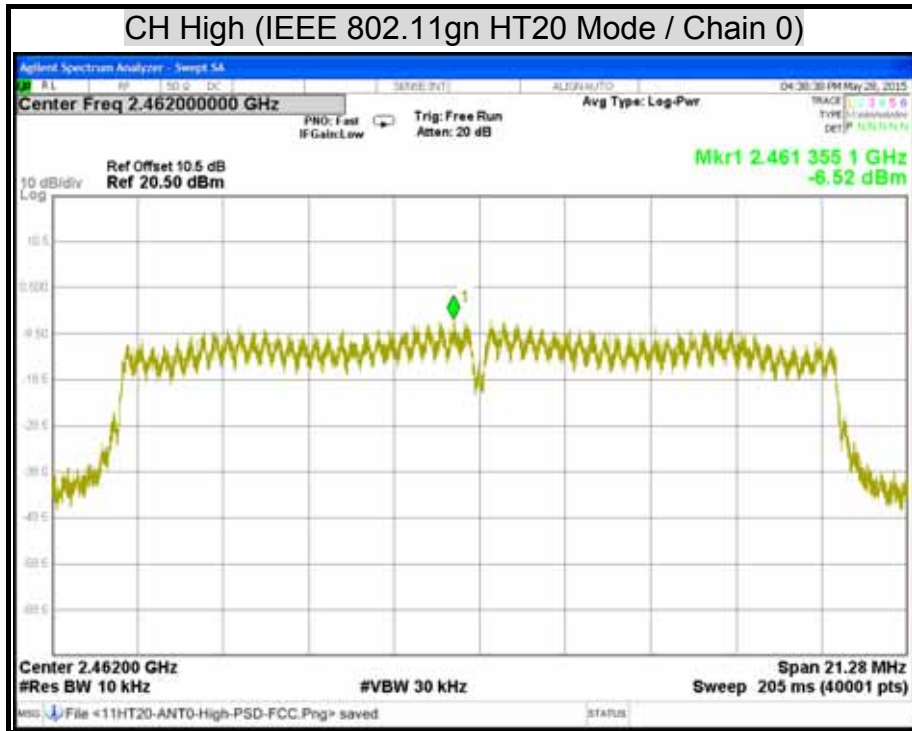

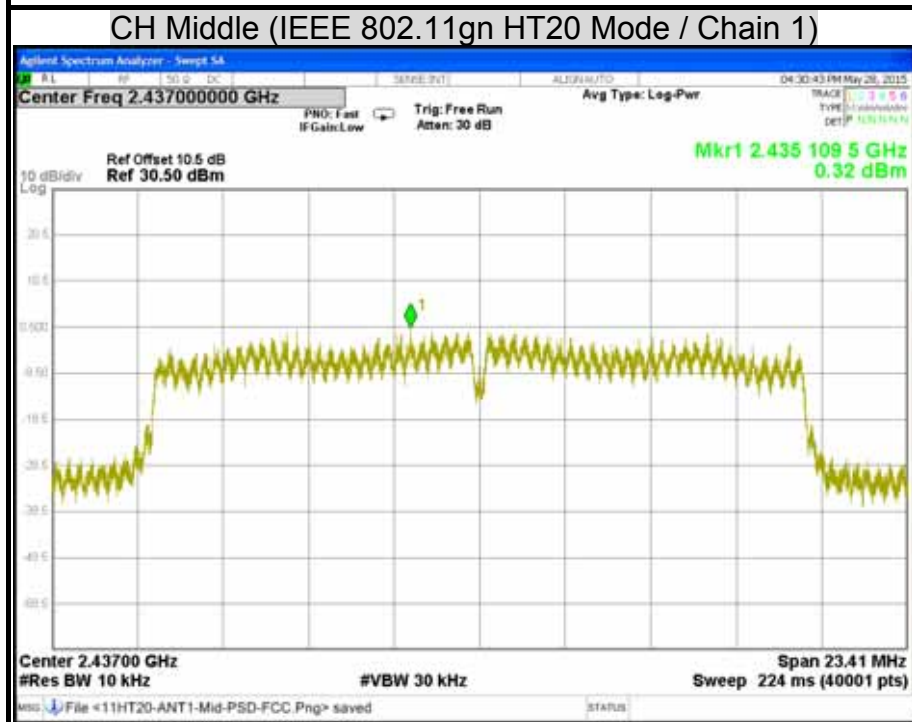
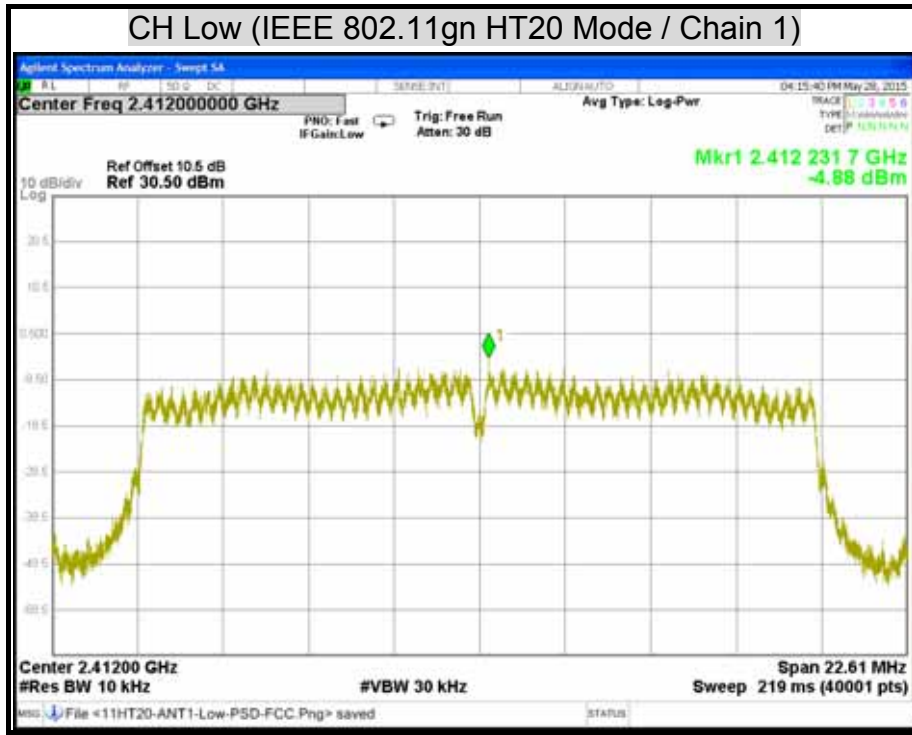

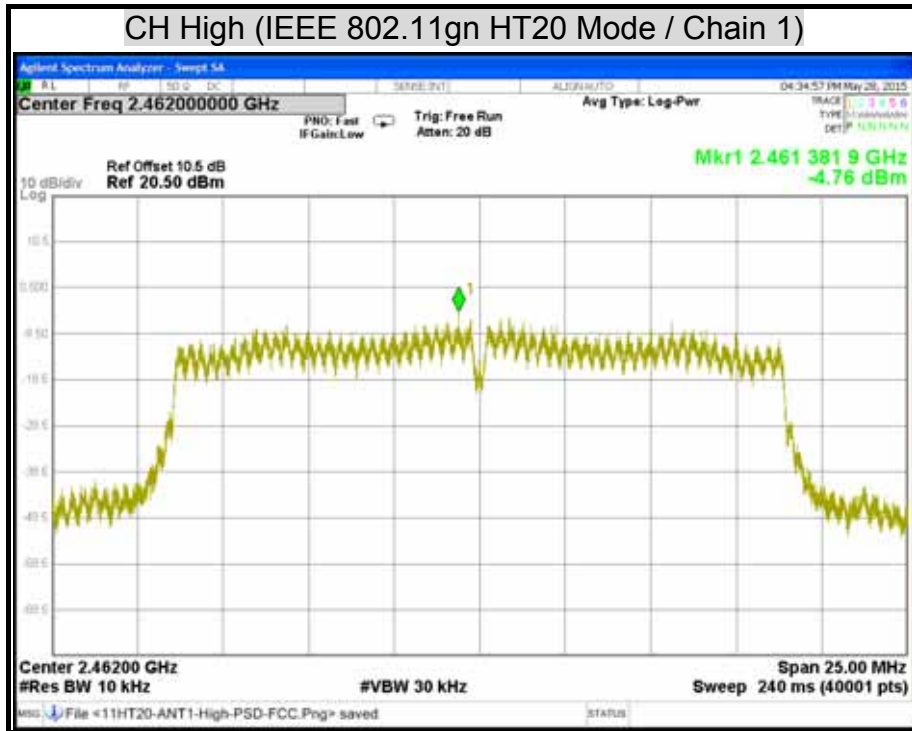

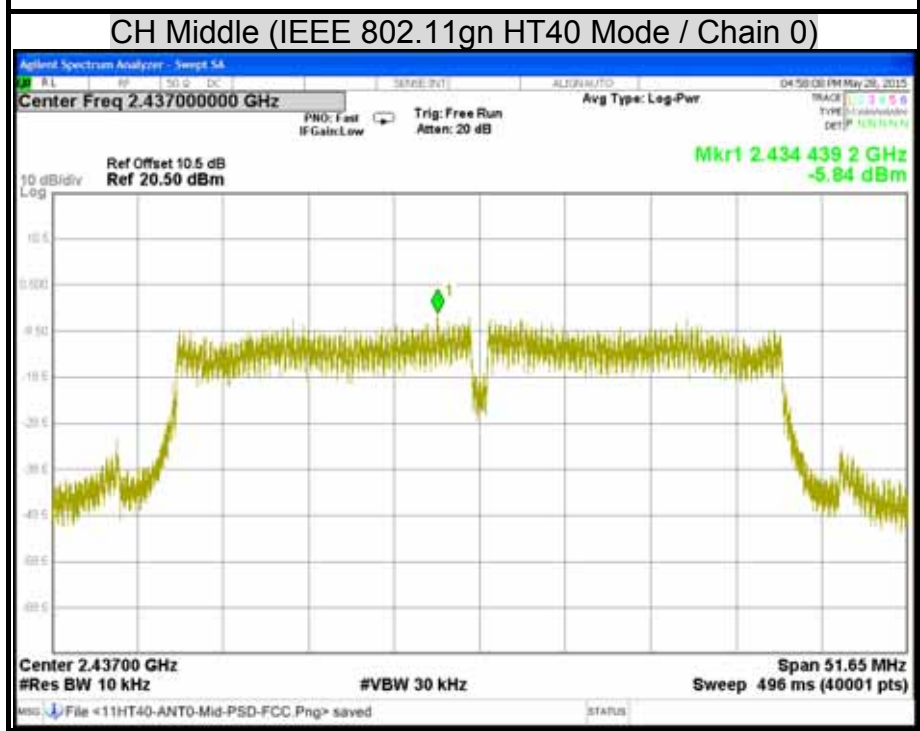
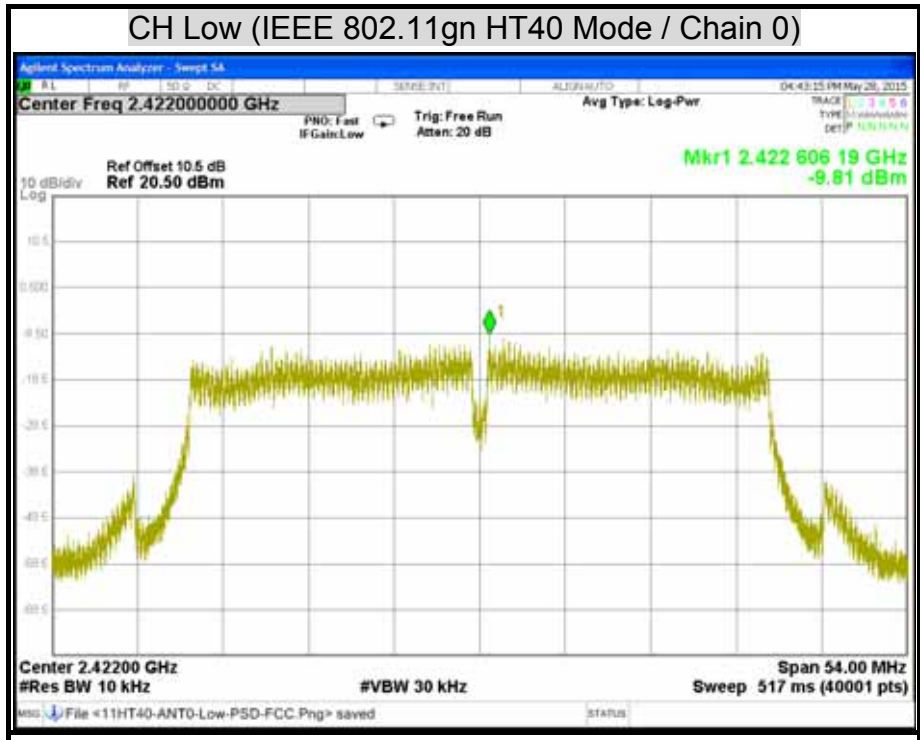

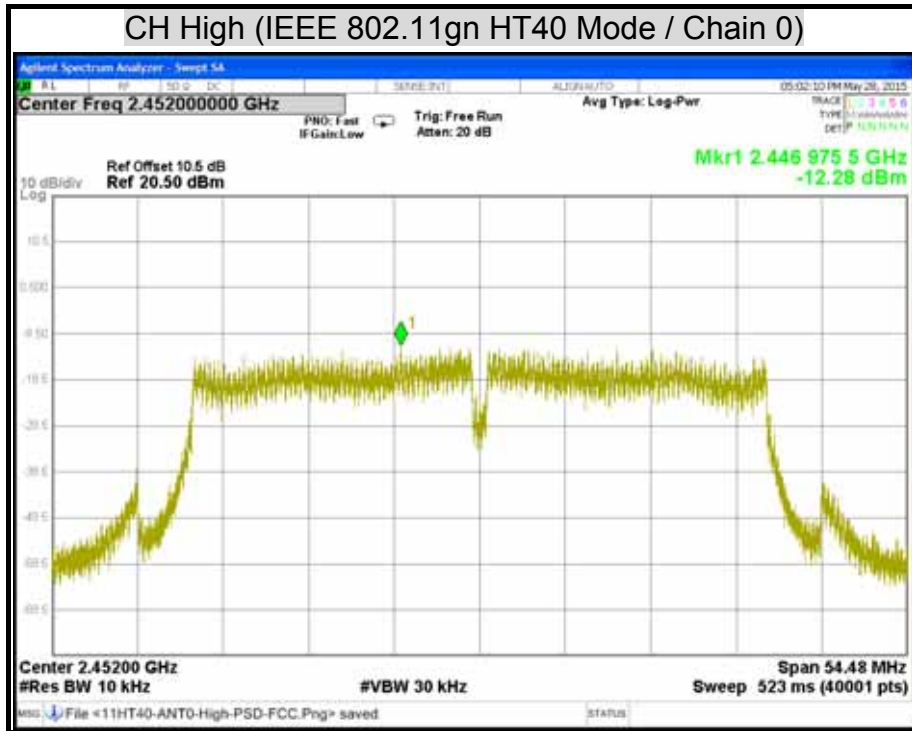

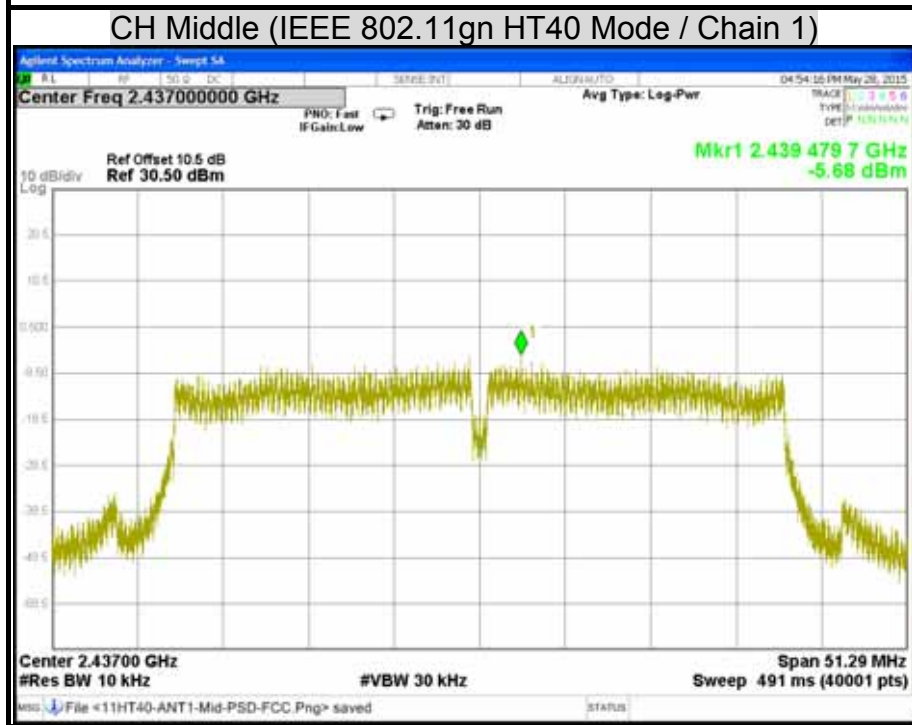
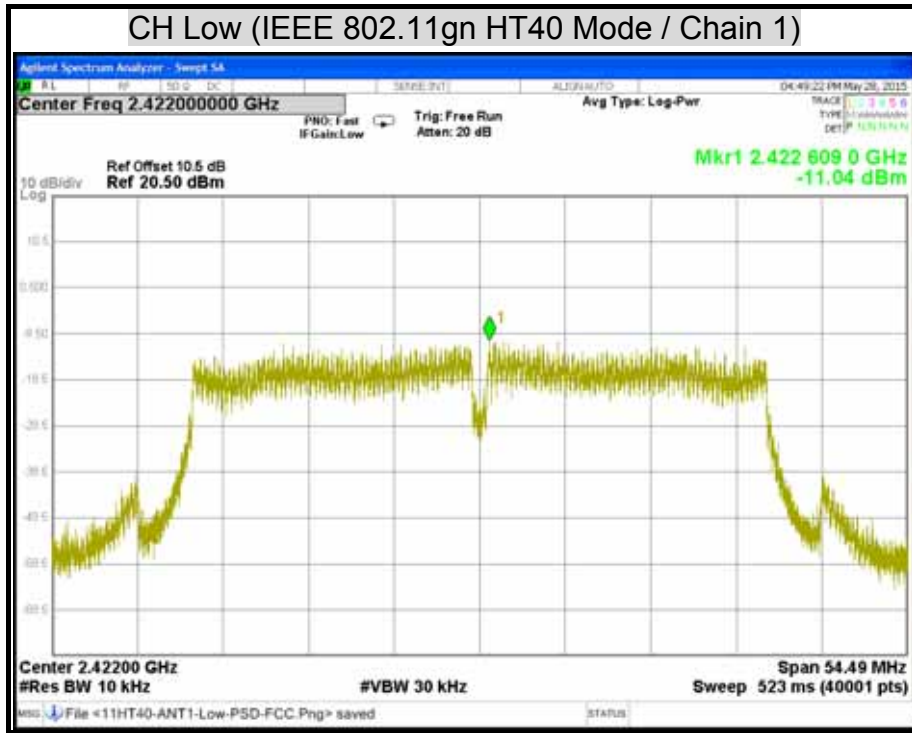

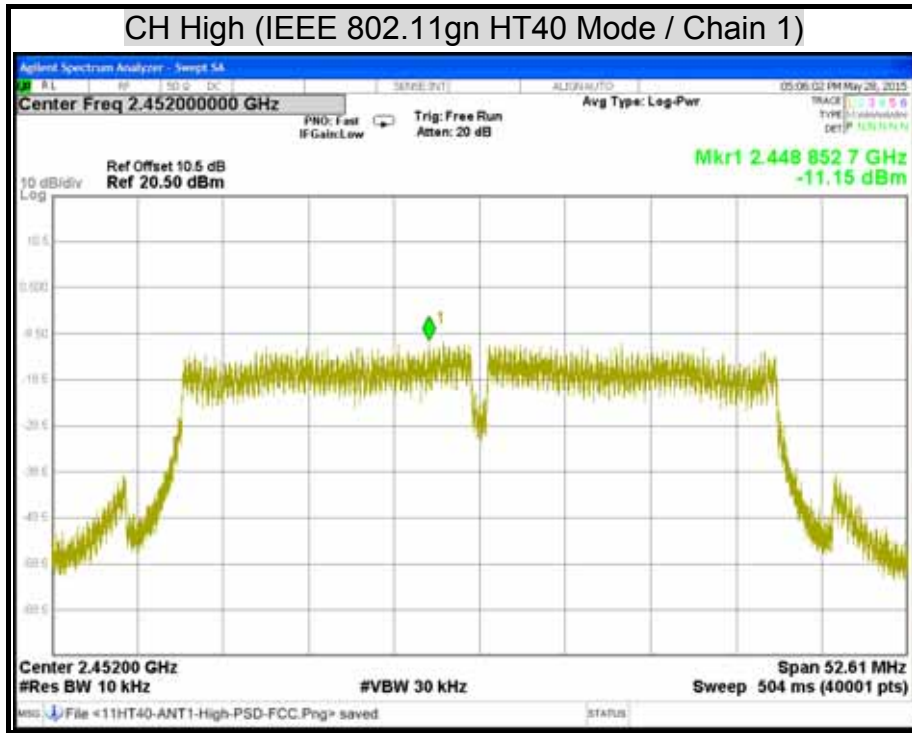



7.5 CONDUCTED SPURIOUS EMISSION

LIMITS

§ 15.247(d) In any 100 kHz bandwidth outside the frequency band in which the spread spectrum intentional radiator is operating, the radio frequency power that is produced by the intentional radiator shall be at least 20 dB below that in the 100 kHz bandwidth within the and that contains the highest level of the desired power, based on either an RF conducted or a radiated measurement. Attenuation below the general limits specified in § 15.209(a) is not required. In addition, radiated emissions which fall in the restricted bands, as defined in § 15.205(a), must also comply with the radiated emission limits specified in § 15.209(a) (see § 15.205(c)).

TEST EQUIPMENT

Name of Equipment	Manufacturer	Model	Serial Number	Calibration Due
Spectrum Analyzer	Agilent	E4446A	MY43360132	06/10/2015

Remark: Each piece of equipment is scheduled for calibration once a year.

TEST SETUP



TEST PROCEDURE

The transmitter output is connected to a spectrum analyzer. The resolution bandwidth is set to 100 kHz. The video bandwidth is set to 300 kHz.

The spectrum from 30 MHz to 26.5 GHz is investigated with the transmitter set to the lowest, middle, and highest channels in the 2.4 GHz band.



TEST RESULTS

OUT-OF-BAND SPURIOUS EMISSIONS-CONDUCTED MEASUREMENT

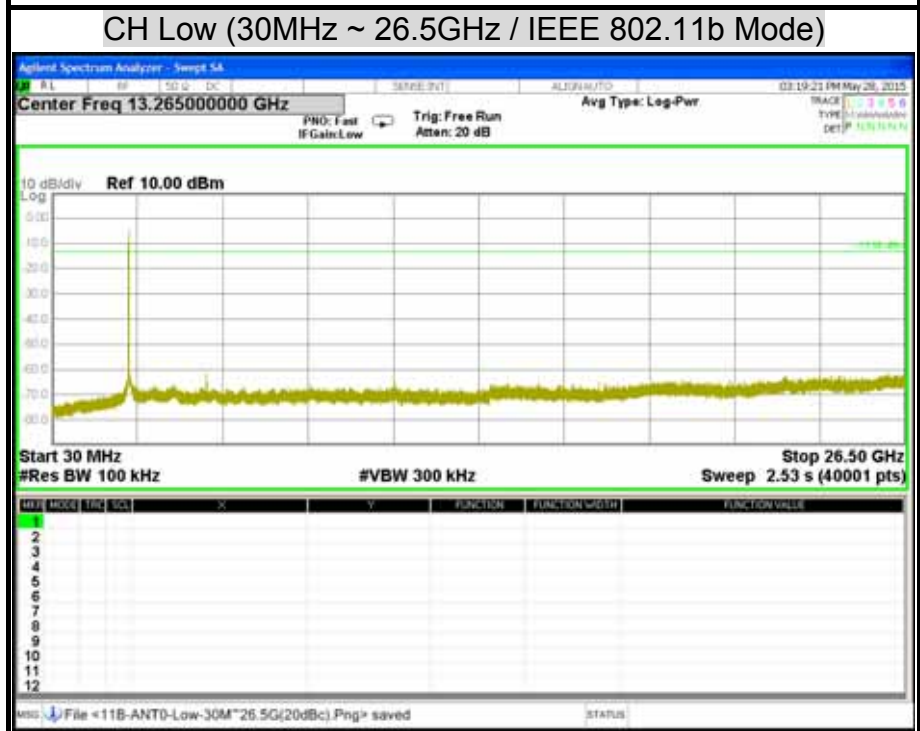
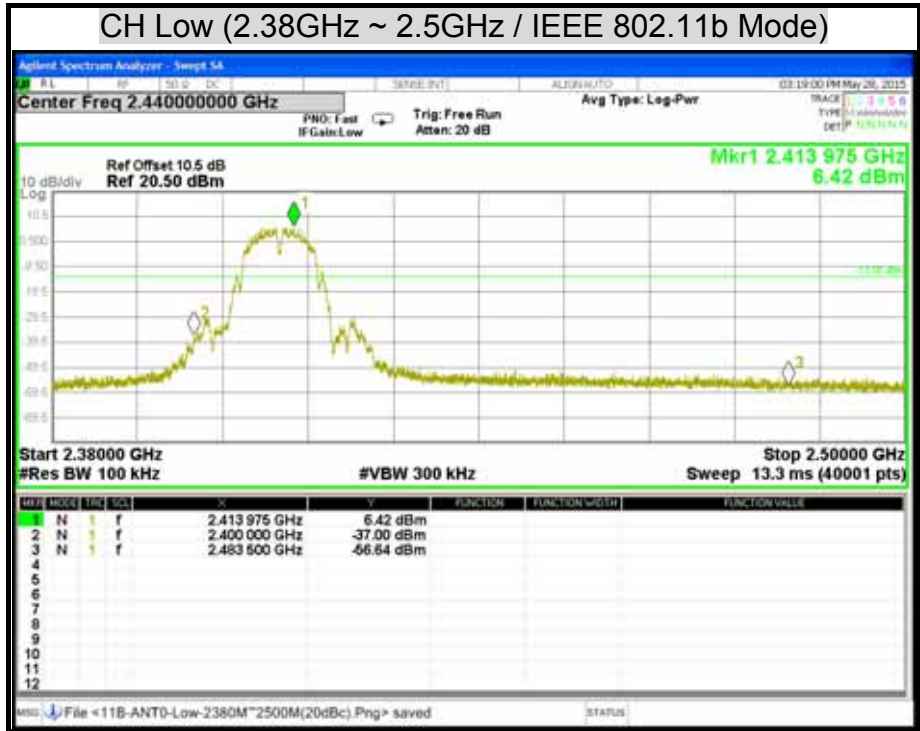



CH Middle (2.38GHz ~ 2.5GHz / IEEE 802.11b Mode)



CH Middle (30MHz ~ 26.5GHz / IEEE 802.11b Mode)

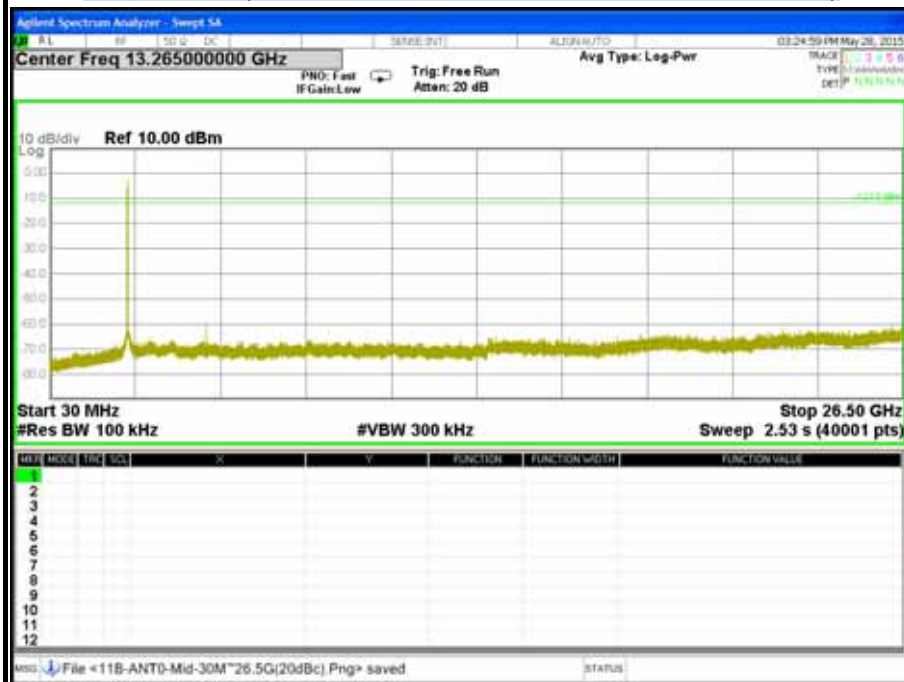

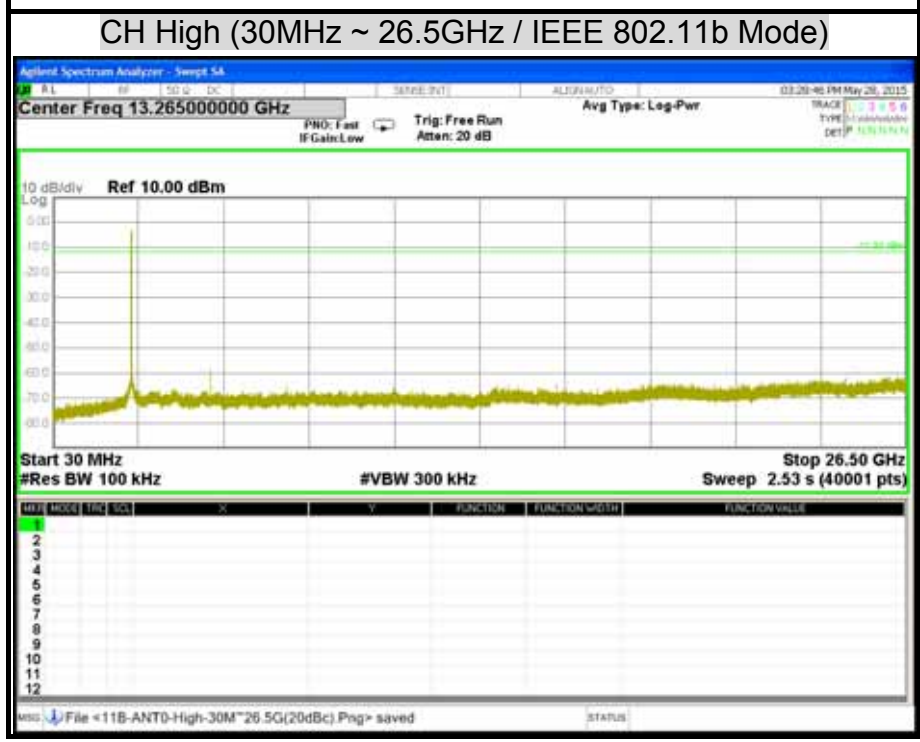
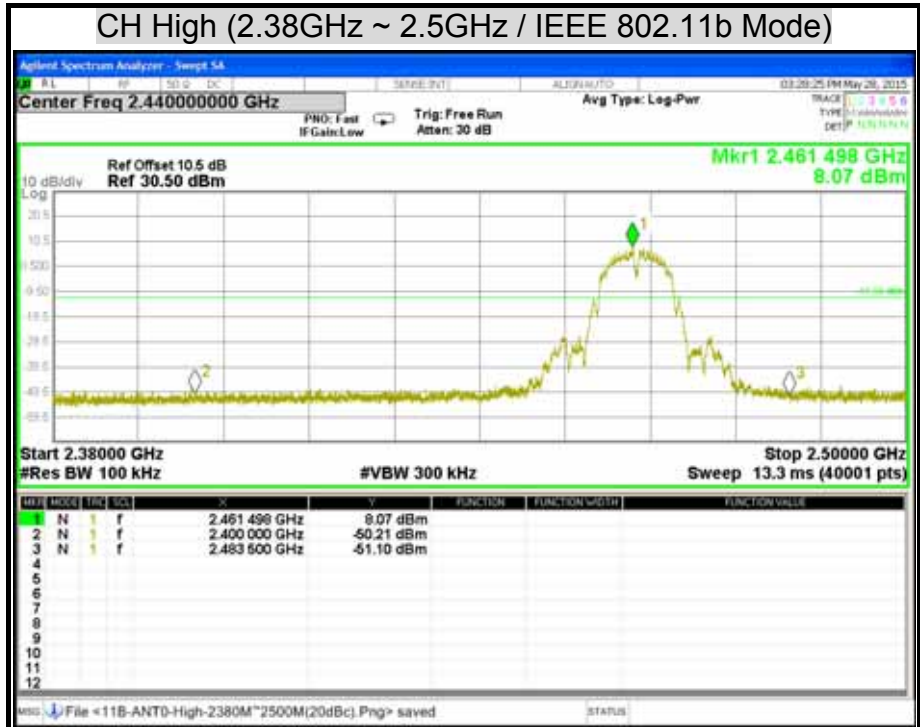



CH Low (2.38GHz ~ 2.5GHz / IEEE 802.11g Mode / Chain 0)

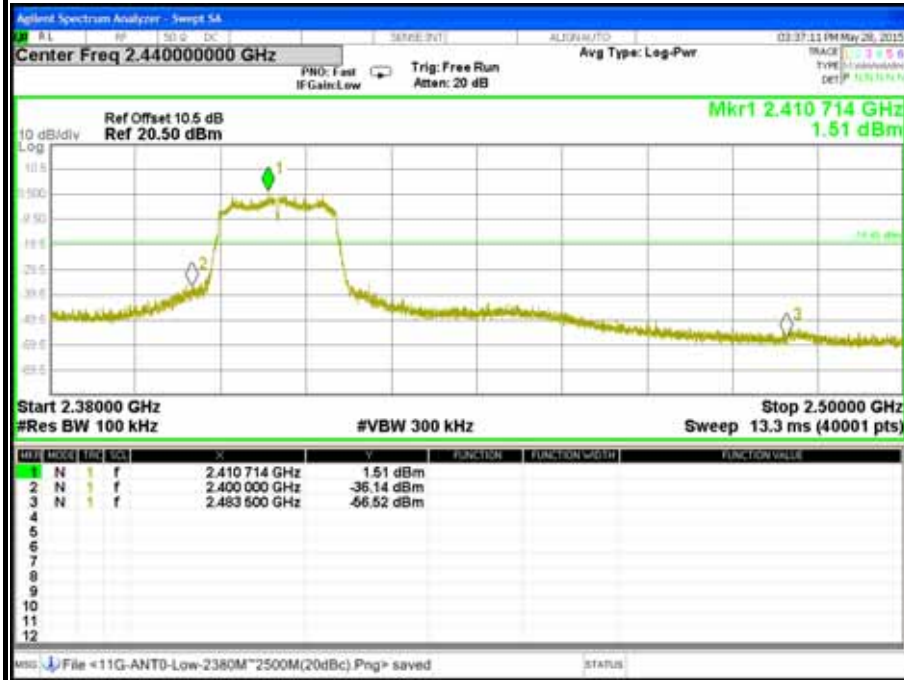

CH Low (30MHz ~ 26.5GHz / IEEE 802.11g Mode / Chain 0)

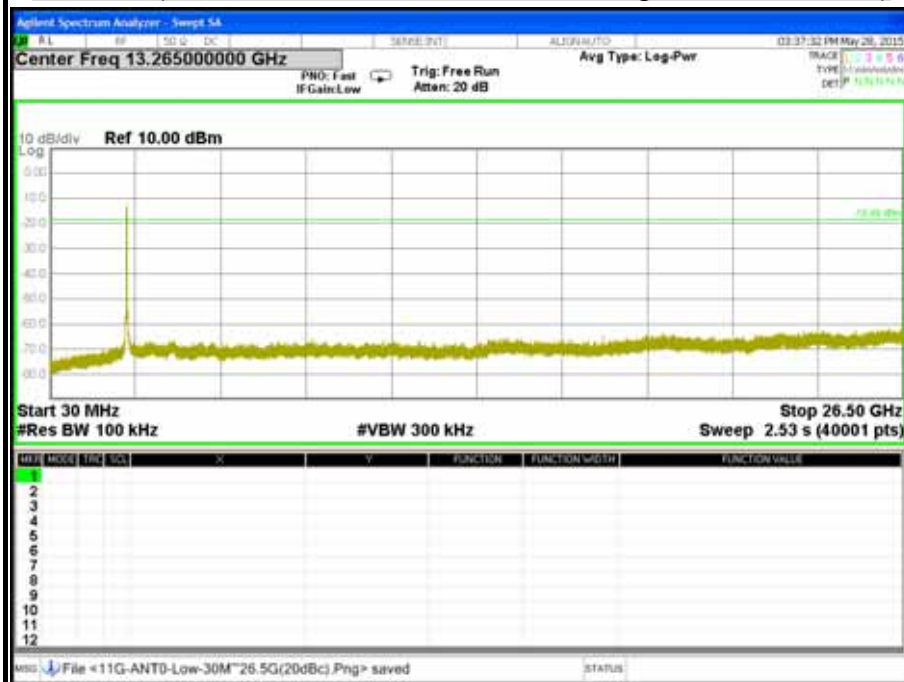



CH Middle (2.38GHz ~ 2.5GHz / IEEE 802.11g Mode / Chain 0)

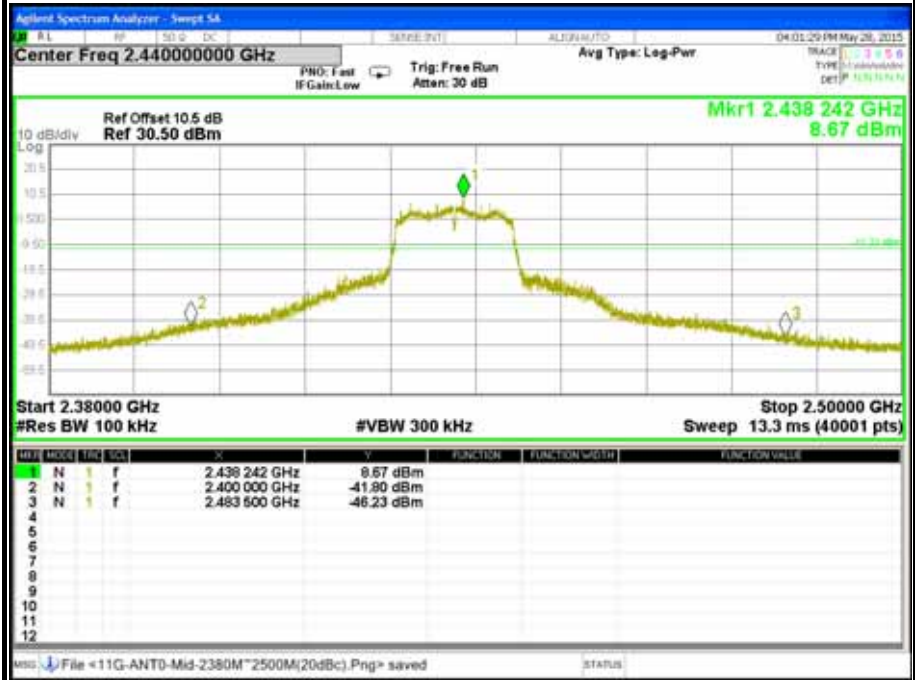

CH Middle (30MHz ~ 26.5GHz / IEEE 802.11g Mode / Chain 0)

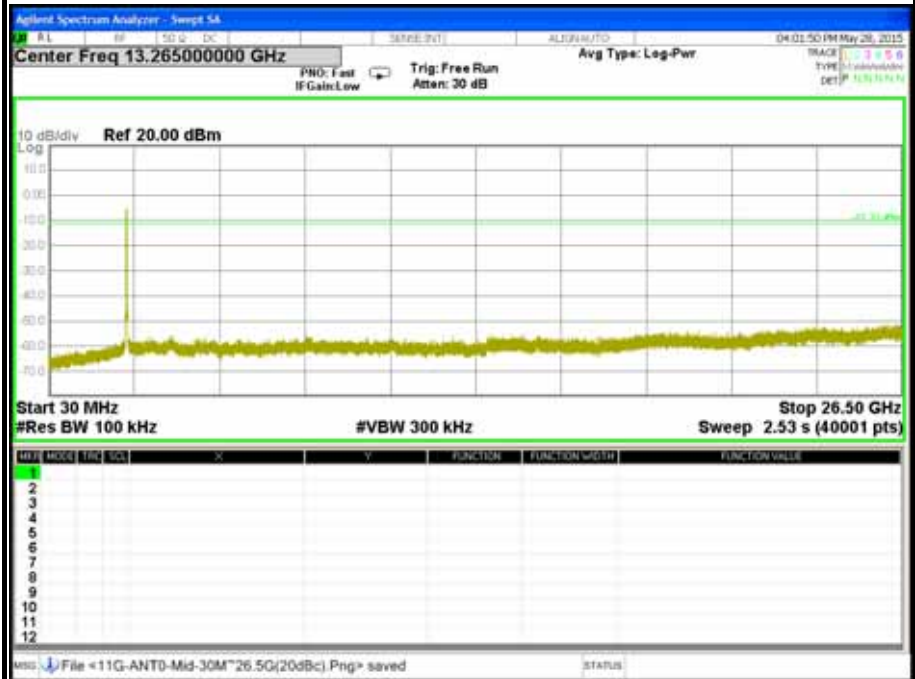



CH High (2.38GHz ~ 2.5GHz / IEEE 802.11g Mode / Chain 0)

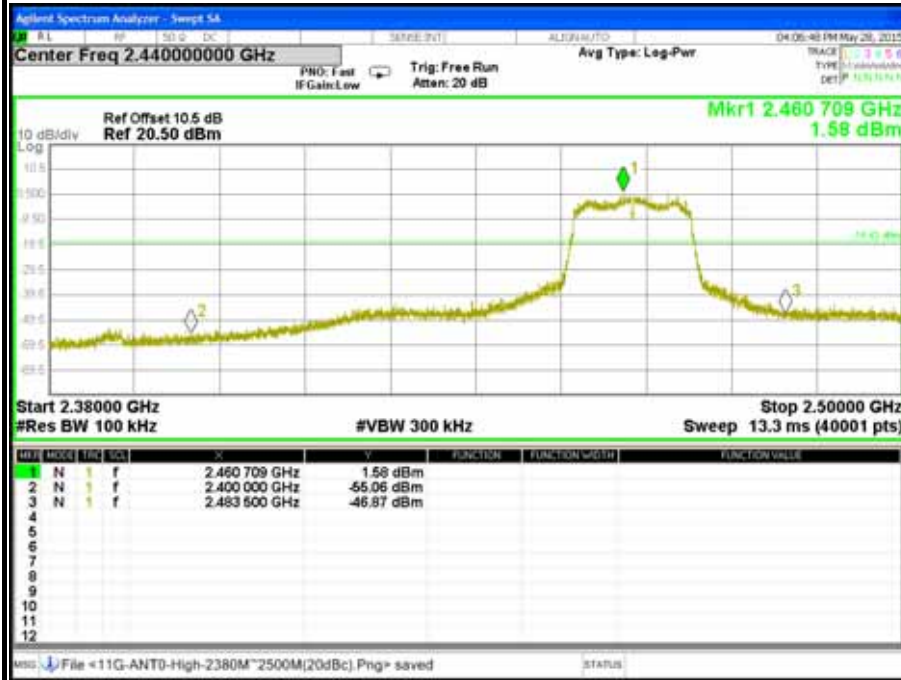

CH High (30MHz ~ 26.5GHz / IEEE 802.11g Mode / Chain 0)

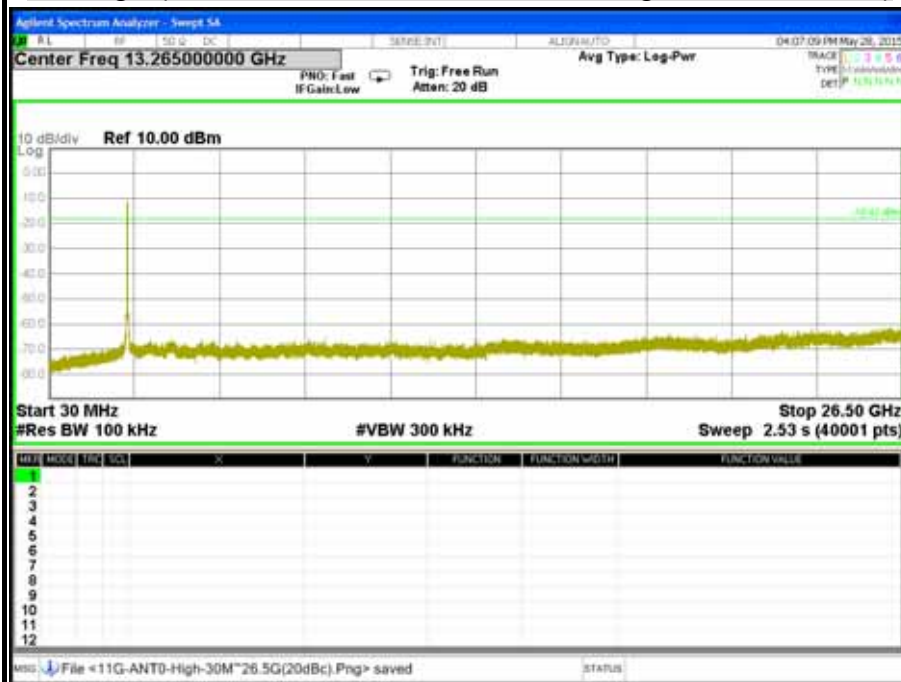



CH Low (2.38GHz ~ 2.5GHz / IEEE 802.11g Mode / Chain 0)

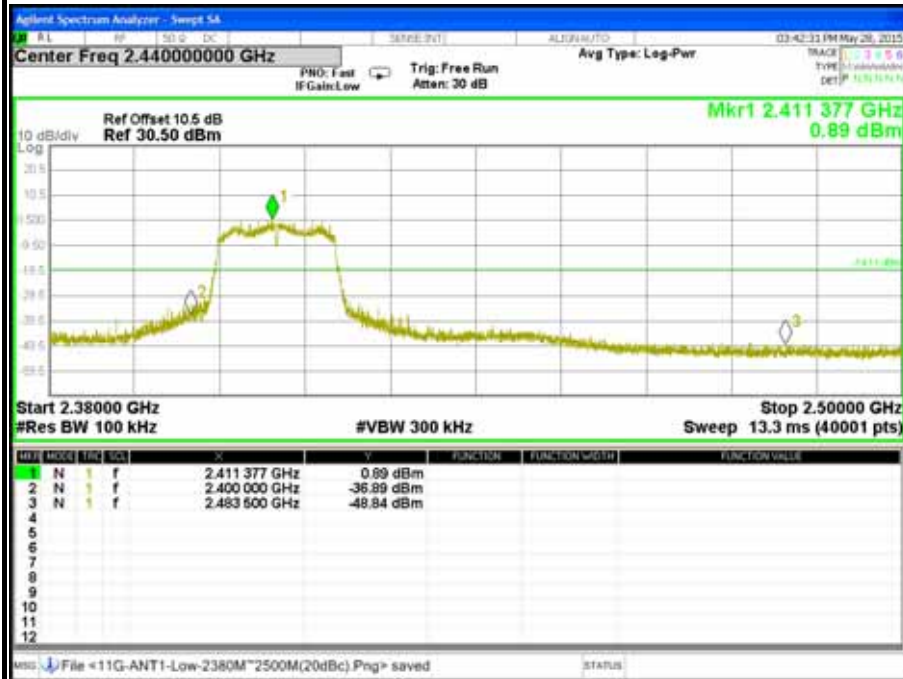

CH Low (30MHz ~ 26.5GHz / IEEE 802.11g Mode / Chain 0)

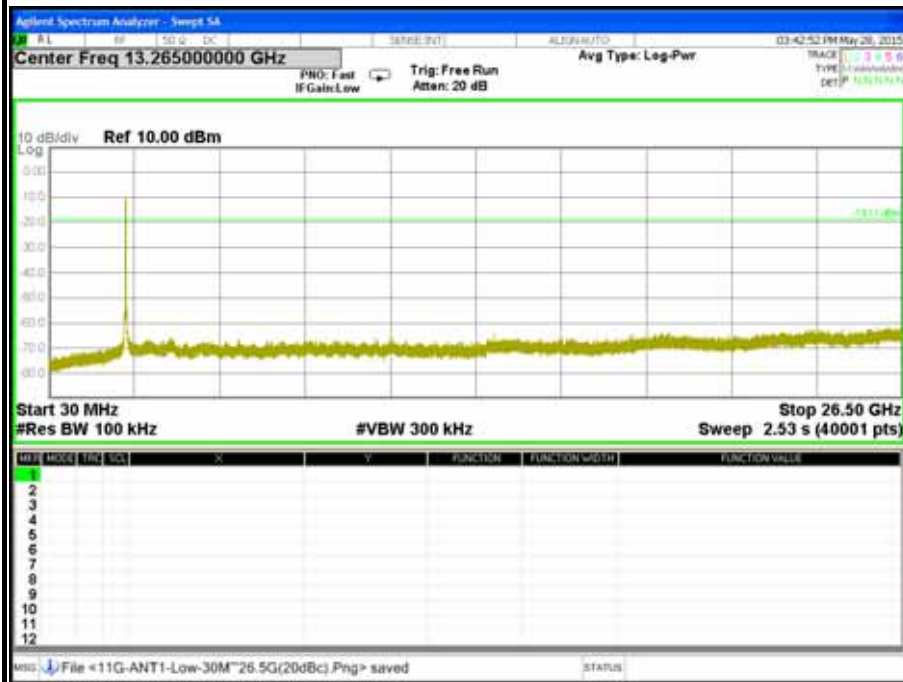



CH Middle (2.38GHz ~ 2.5GHz / IEEE 802.11g Mode / Chain 0)

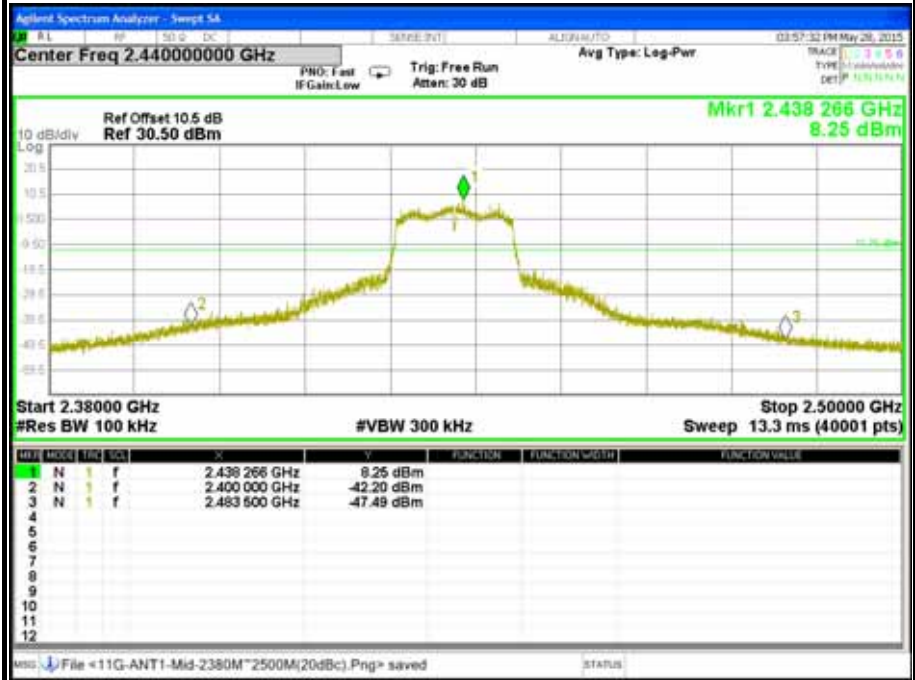

CH Middle (30MHz ~ 26.5GHz / IEEE 802.11g Mode / Chain 0)

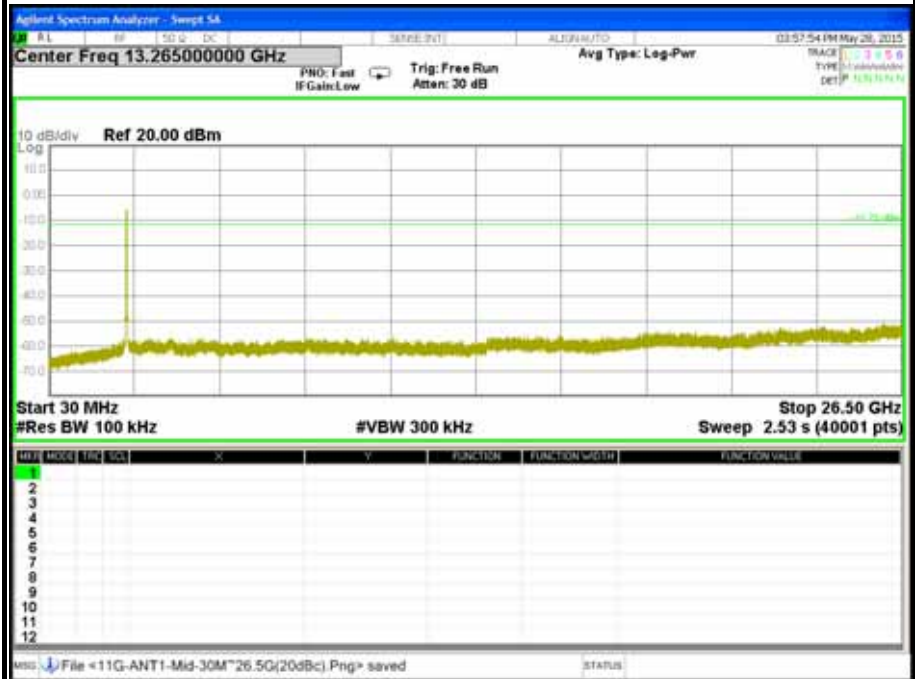



CH High (2.38GHz ~ 2.5GHz / IEEE 802.11g Mode / Chain 0)



CH High (30MHz ~ 26.5GHz / IEEE 802.11g Mode / Chain 0)

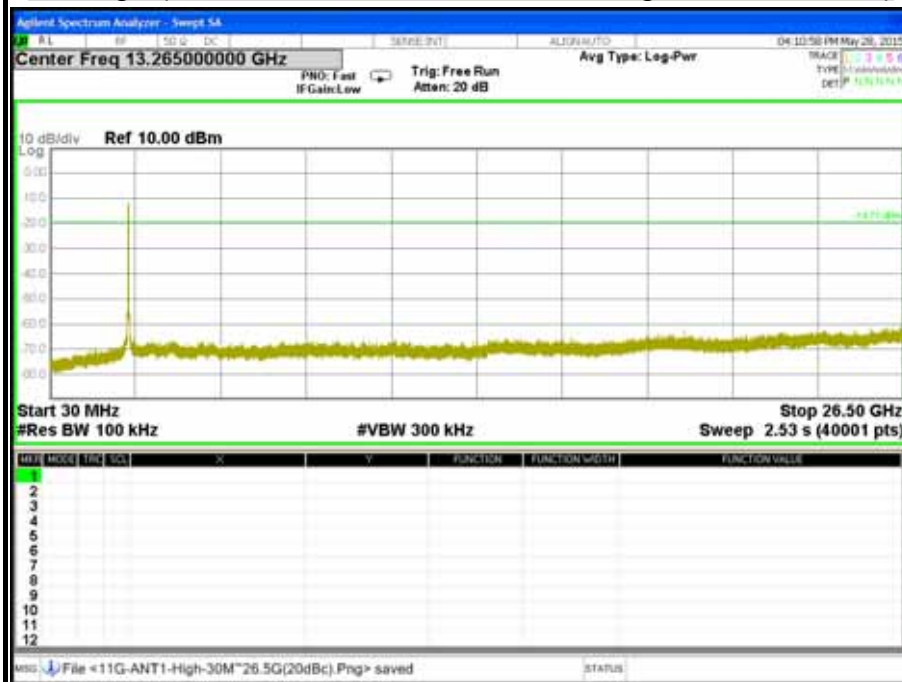



CH Low (2.38GHz ~ 2.5GHz / IEEE 802.11gn HT20 Mode / Chain 0)

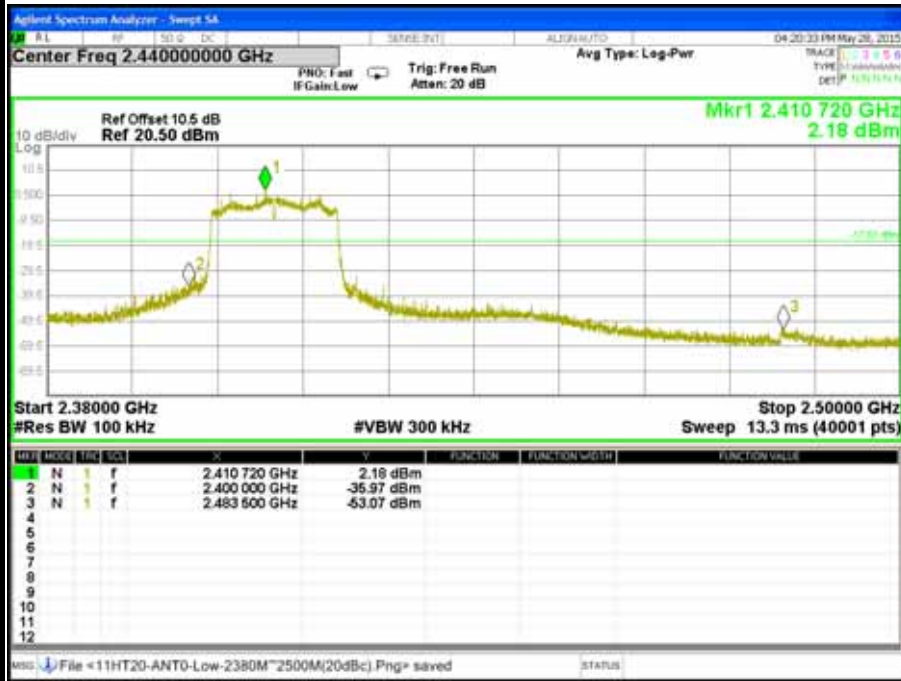

CH Low (30MHz ~ 26.5GHz / IEEE 802.11gn HT20 Mode / Chain 0)

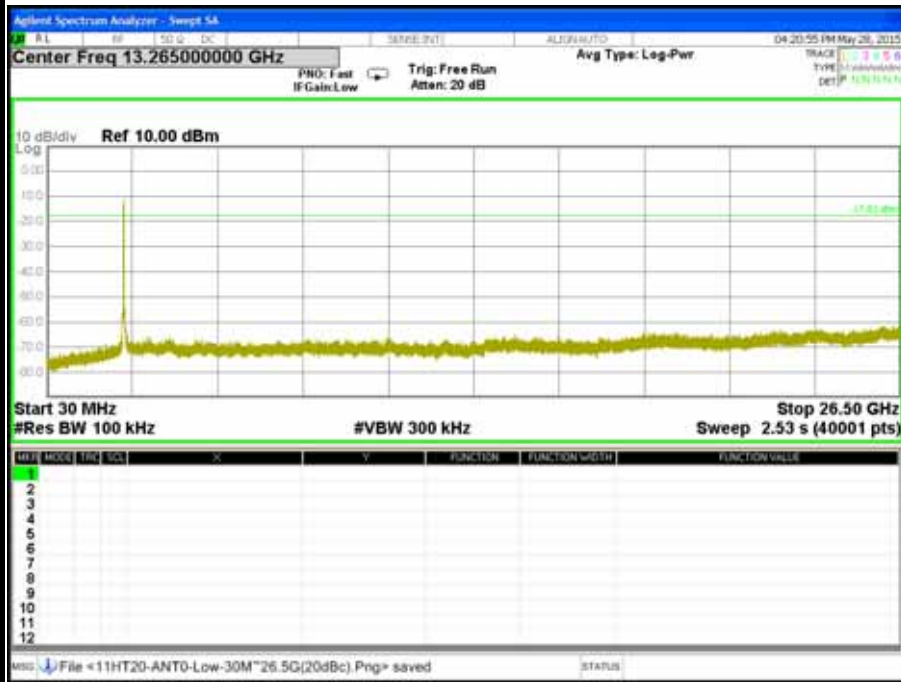



CH Middle (2.38GHz ~ 2.5GHz / IEEE 802.11gn HT20 Mode / Chain 0)

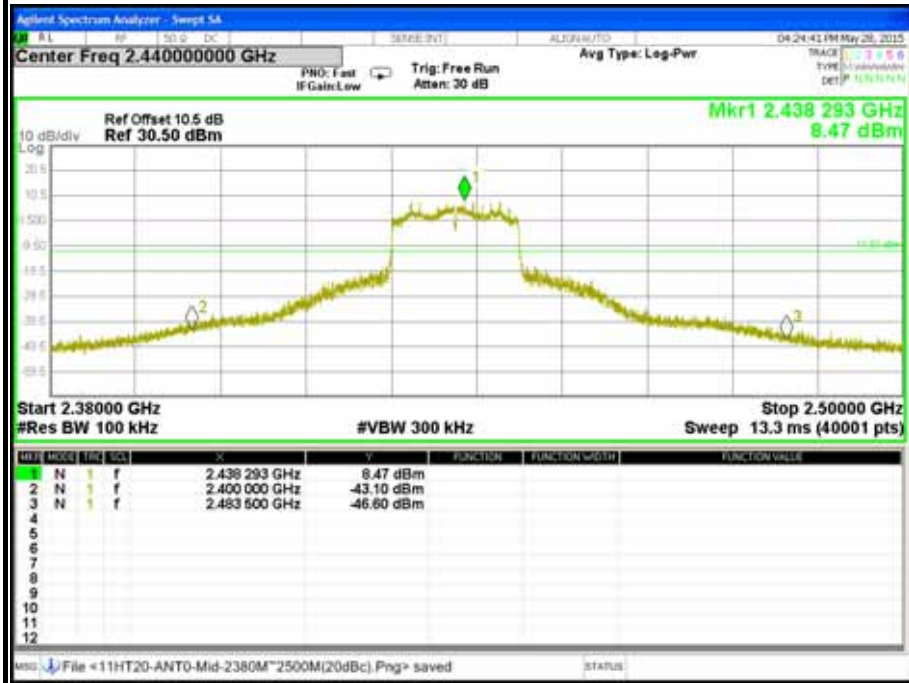

CH Middle (30MHz ~ 26.5GHz / IEEE 802.11gn HT20 Mode / Chain 0)

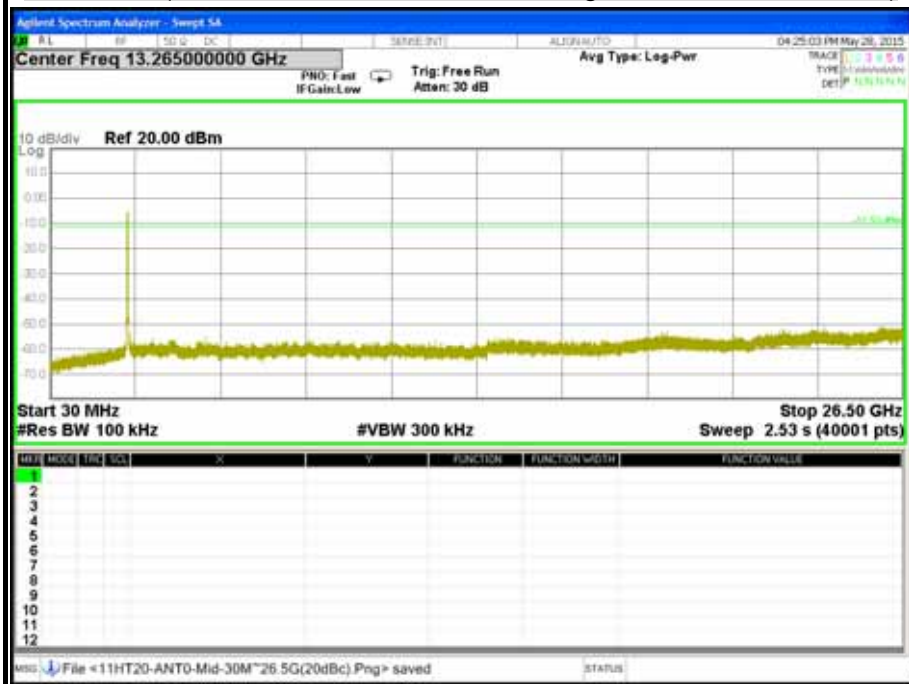



CH High (2.38GHz ~ 2.5GHz / IEEE 802.11gn HT20 Mode / Chain 0)



CH High (30MHz ~ 26.5GHz / IEEE 802.11gn HT20 Mode / Chain 0)

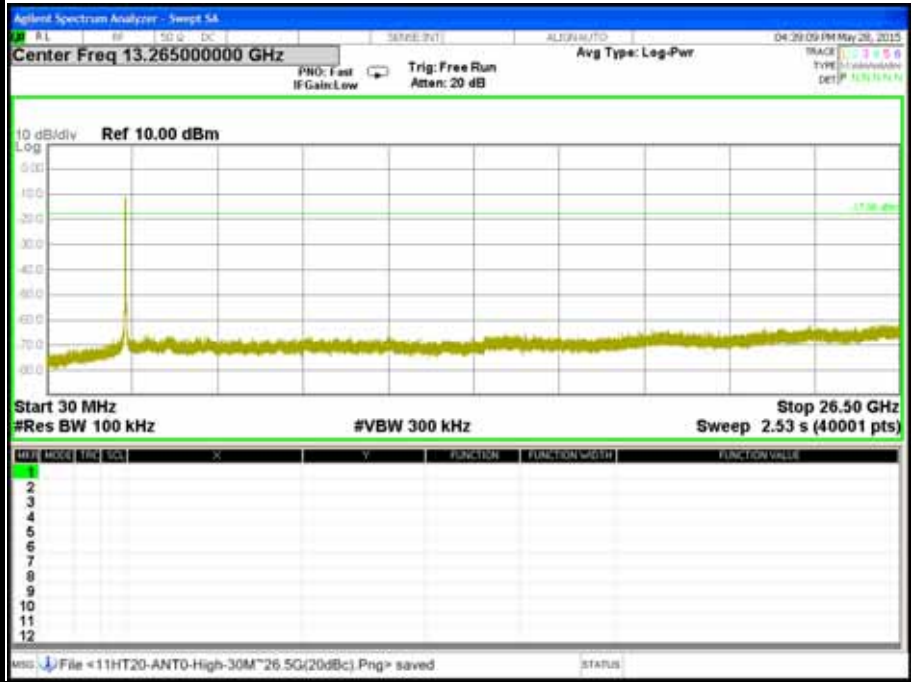



CH Low (2.38GHz ~ 2.5GHz / IEEE 802.11gn HT20 Mode / Chain 1)

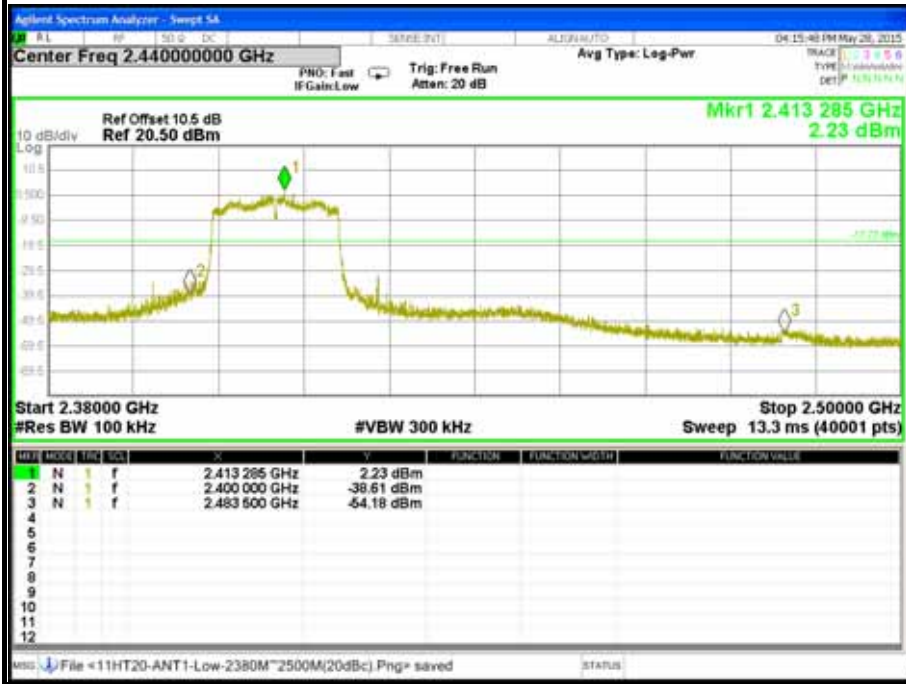

CH Low (30MHz ~ 26.5GHz / IEEE 802.11gn HT20 Mode / Chain 1)

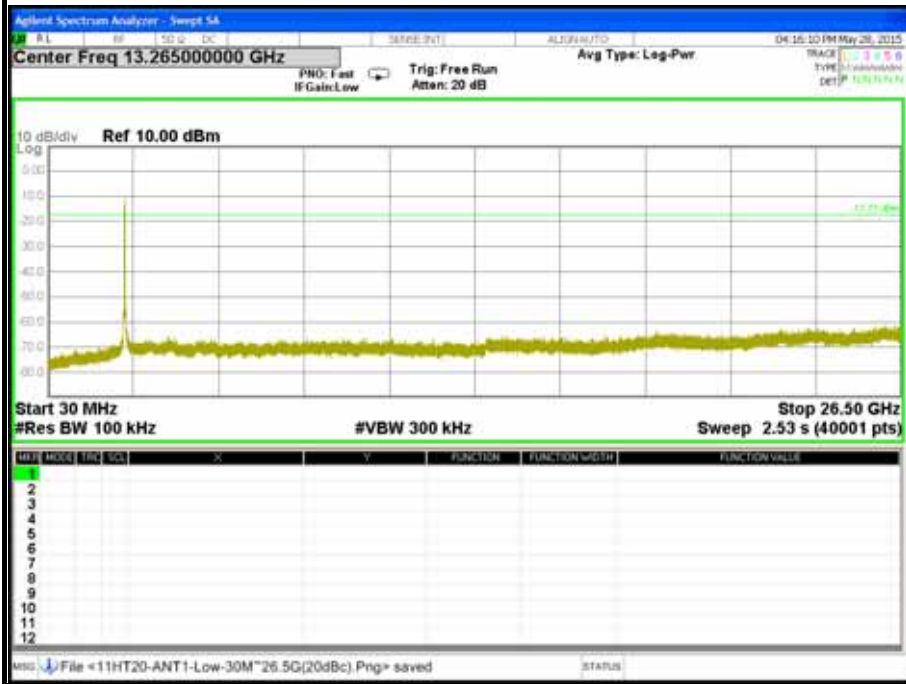



CH Middle (2.38GHz ~ 2.5GHz / IEEE 802.11gn HT20 Mode / Chain 1)

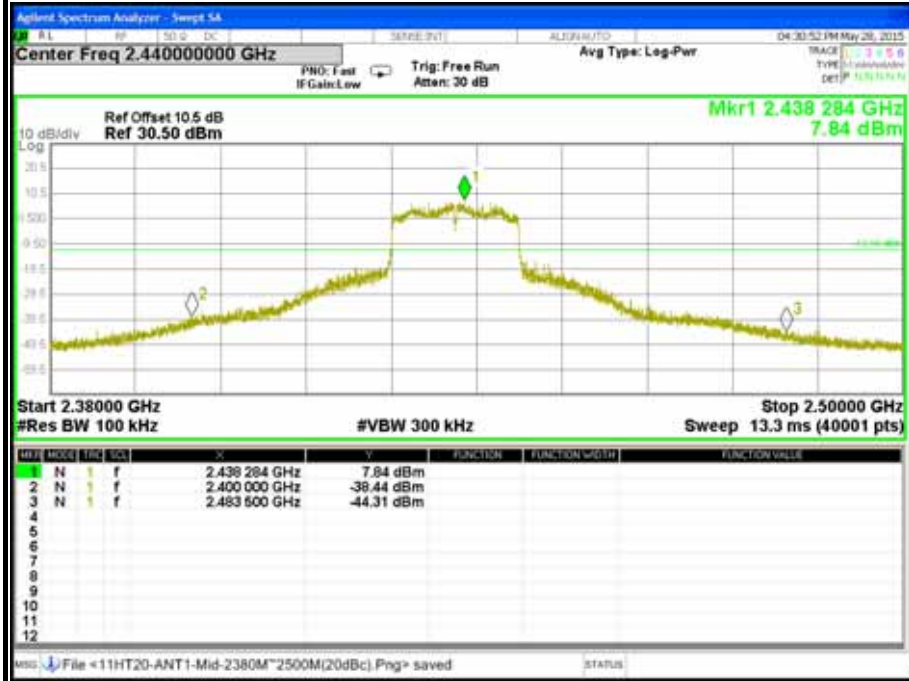

CH Middle (30MHz ~ 26.5GHz / IEEE 802.11gn HT20 Mode / Chain 1)

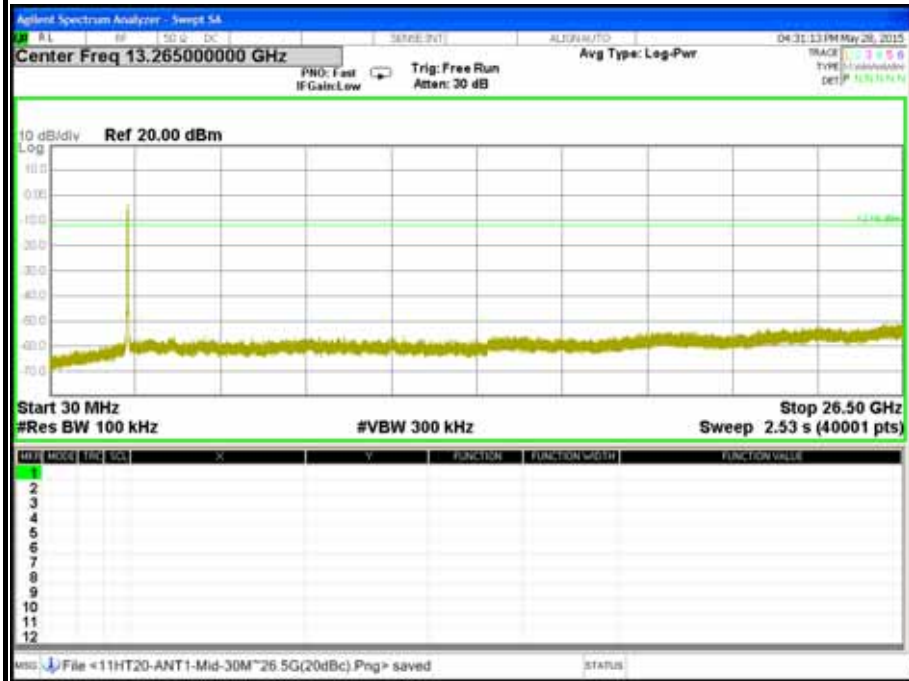



CH High (2.38GHz ~ 2.5GHz / IEEE 802.11gn HT20 Mode / Chain 1)

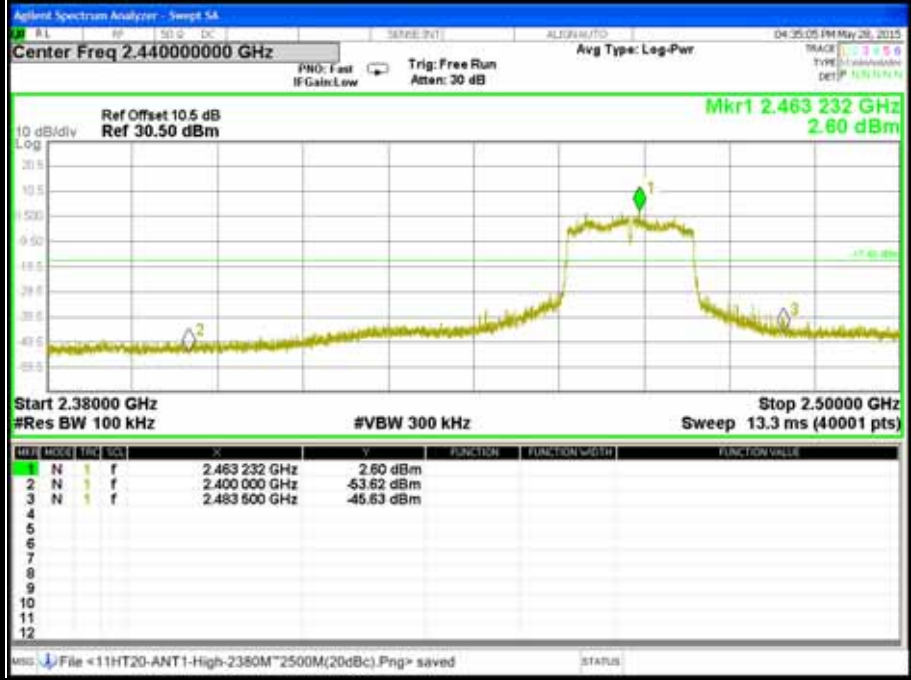

CH High (30MHz ~ 26.5GHz / IEEE 802.11gn HT20 Mode / Chain 1)

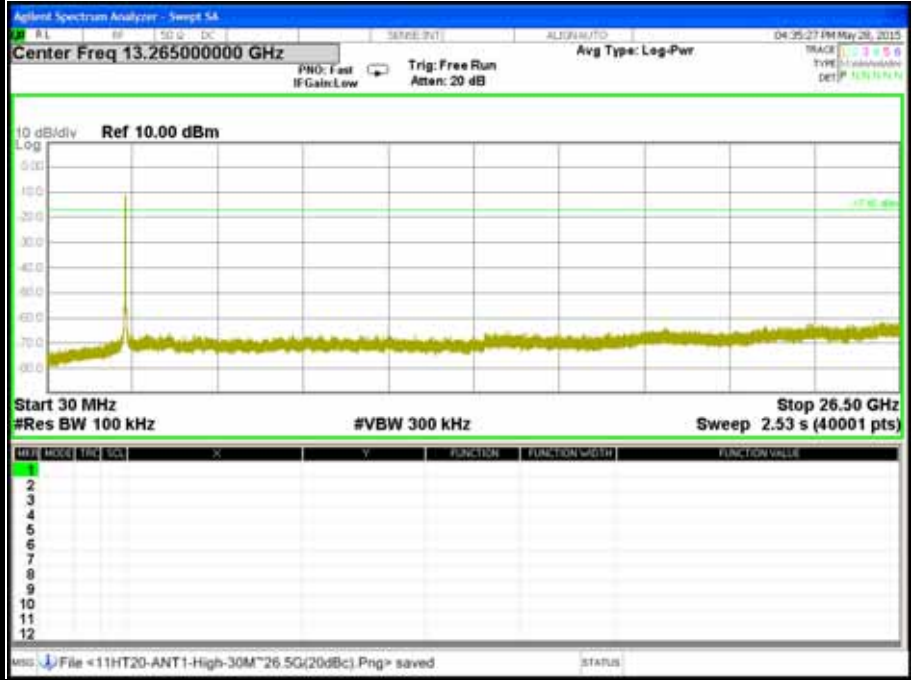



CH Low (2.38GHz ~ 2.5GHz / IEEE 802.11gn HT40 Mode / Chain 0)

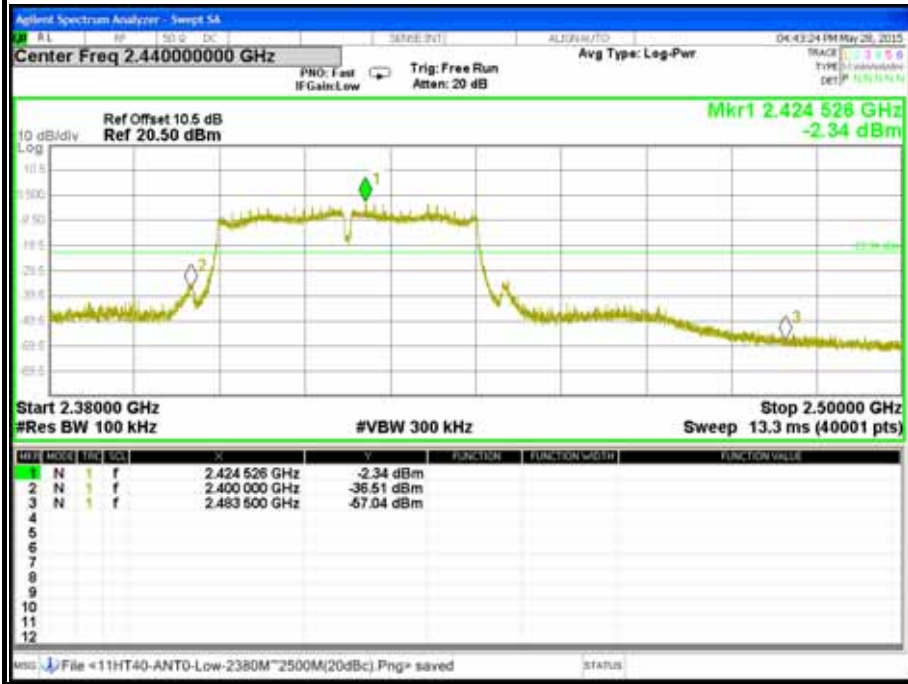

CH Low (30MHz ~ 26.5GHz / IEEE 802.11gn HT40 Mode / Chain 0)

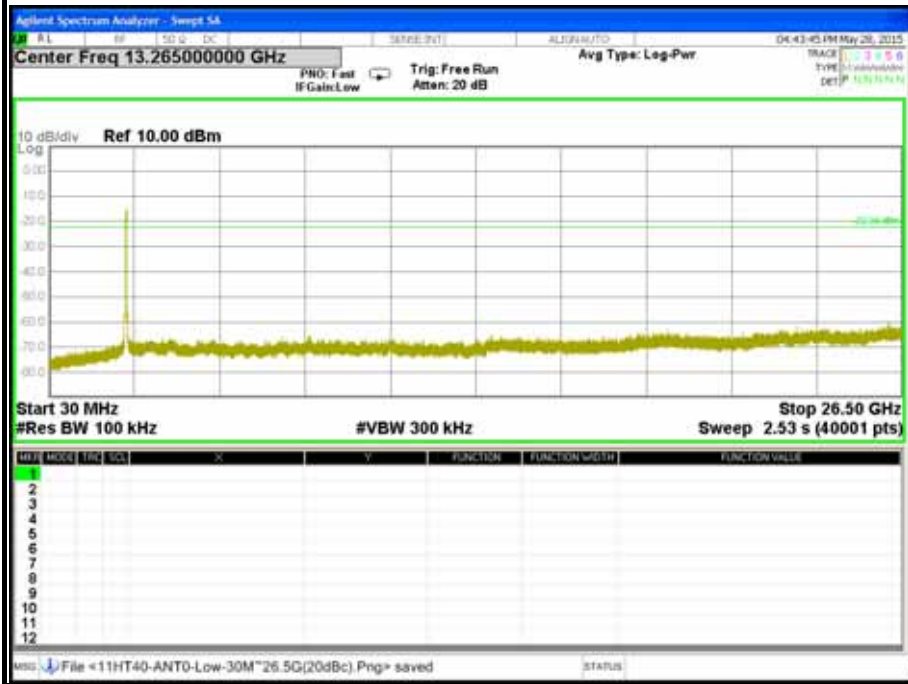



CH Middle (2.38MHz ~ 2.5GHz / IEEE 802.11gn HT40 Mode / Chain 0)

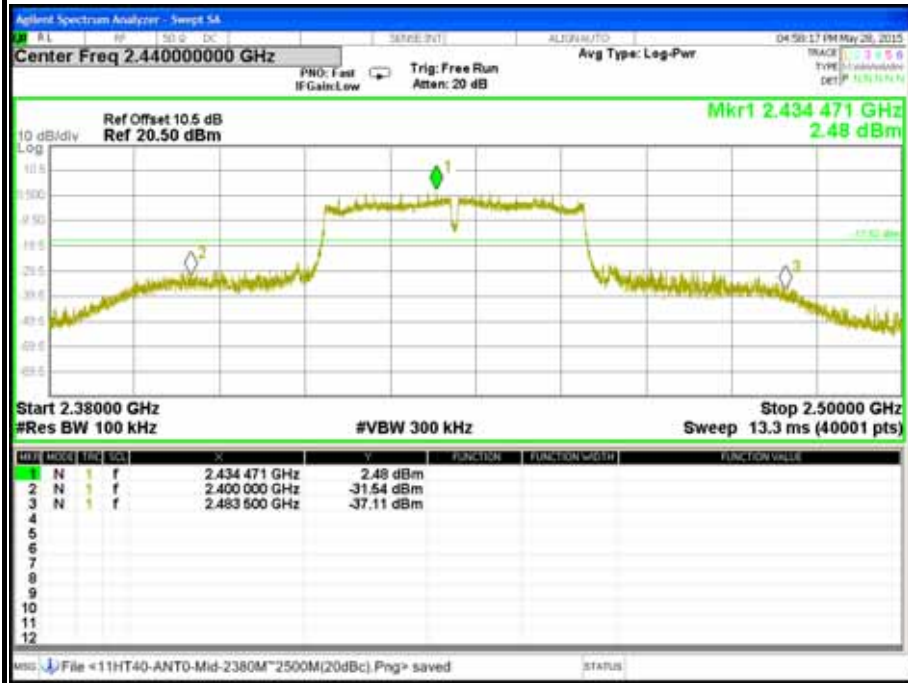

CH Middle (30MHz ~ 26.5GHz / IEEE 802.11gn HT40 Mode / Chain 0)

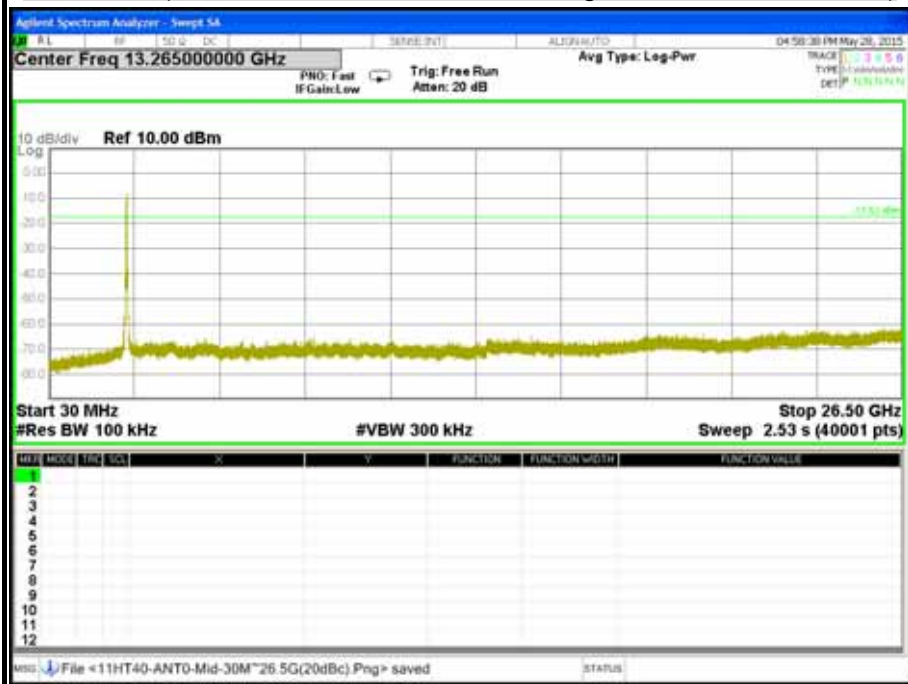



CH High (2.38GHz ~ 2.5GHz / IEEE 802.11gn HT40 Mode / Chain 0)

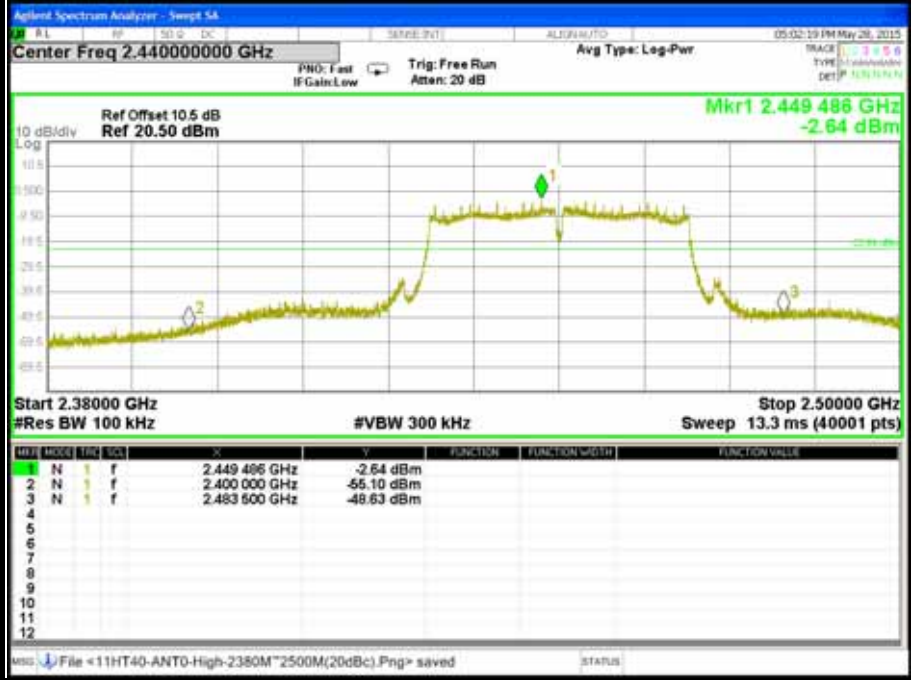

CH High (30MHz ~ 26.5GHz / IEEE 802.11gn HT40 Mode /Chain 0)

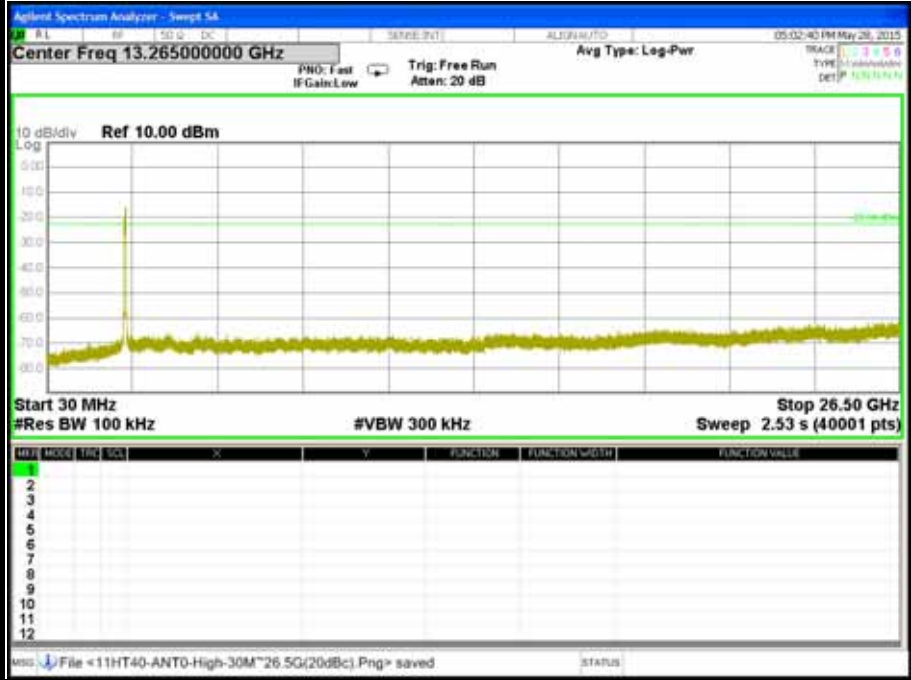



CH Low (2.38GHz ~ 2.5GHz / IEEE 802.11gn HT40 Mode / Chain 1)

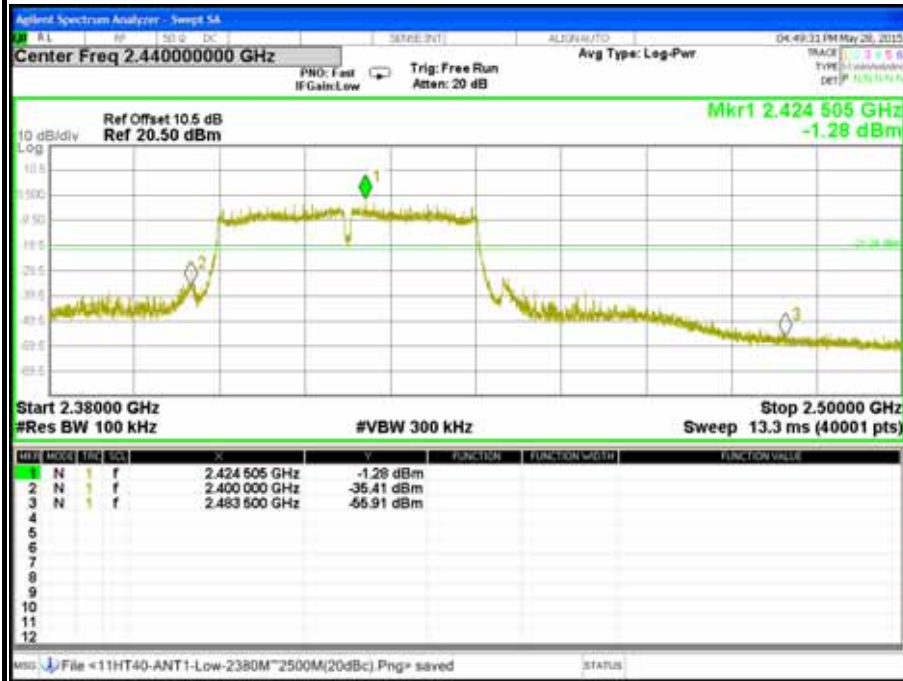

CH Low (30MHz ~ 26.5GHz / IEEE 802.11gn HT40 Mode / Chain 1)

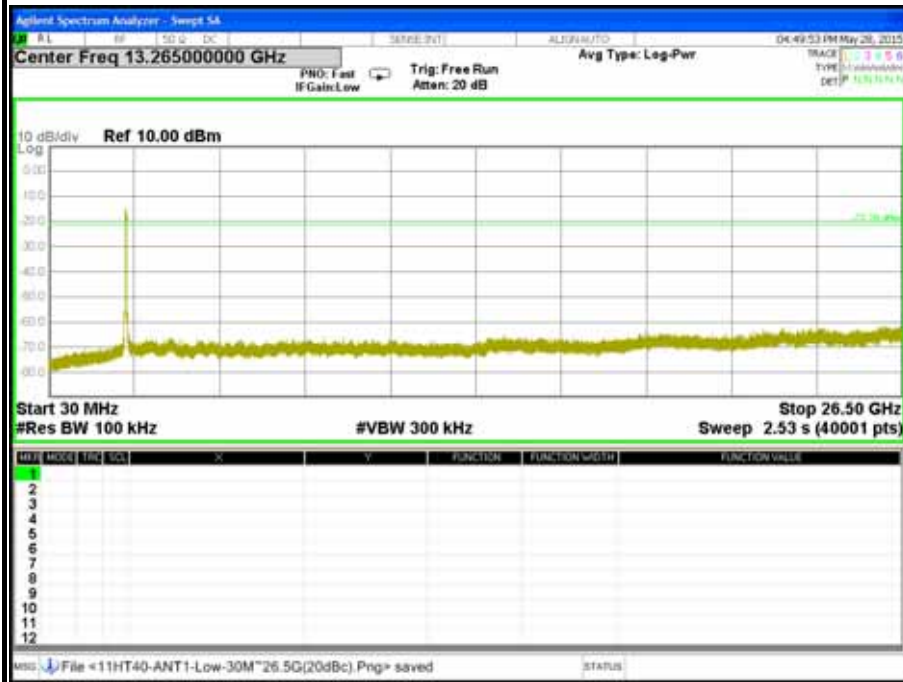



CH Middle (2.38GHz ~ 2.5GHz / IEEE 802.11gn HT40 Mode / Chain 1)



CH Middle (30MHz ~ 26.5GHz / IEEE 802.11gn HT40 Mode / Chain 1)

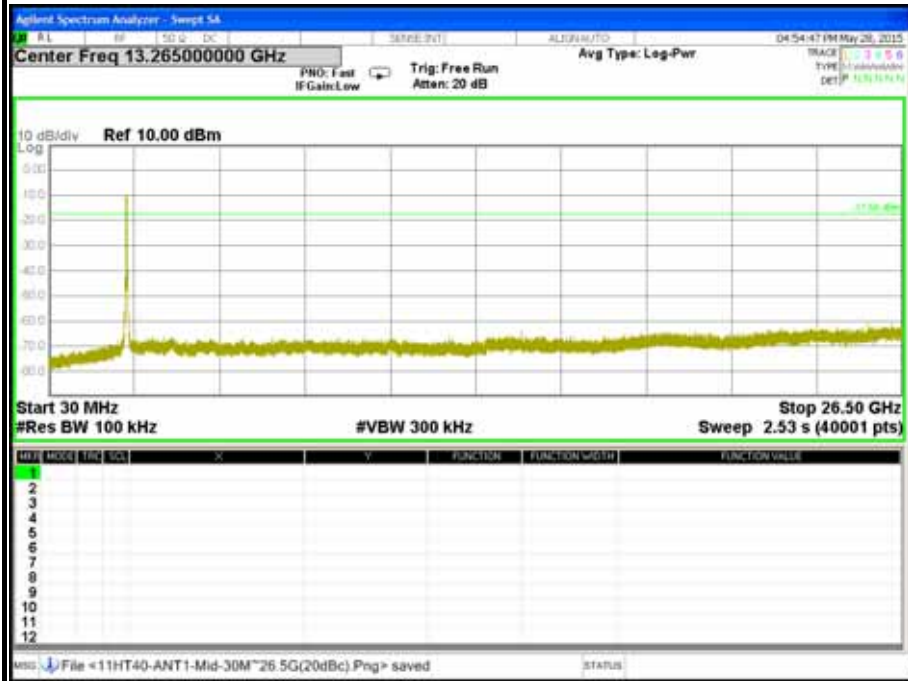



CH High (2.38GHz ~ 2.5GHz / IEEE 802.11gn HT40 Mode / Chain 1)

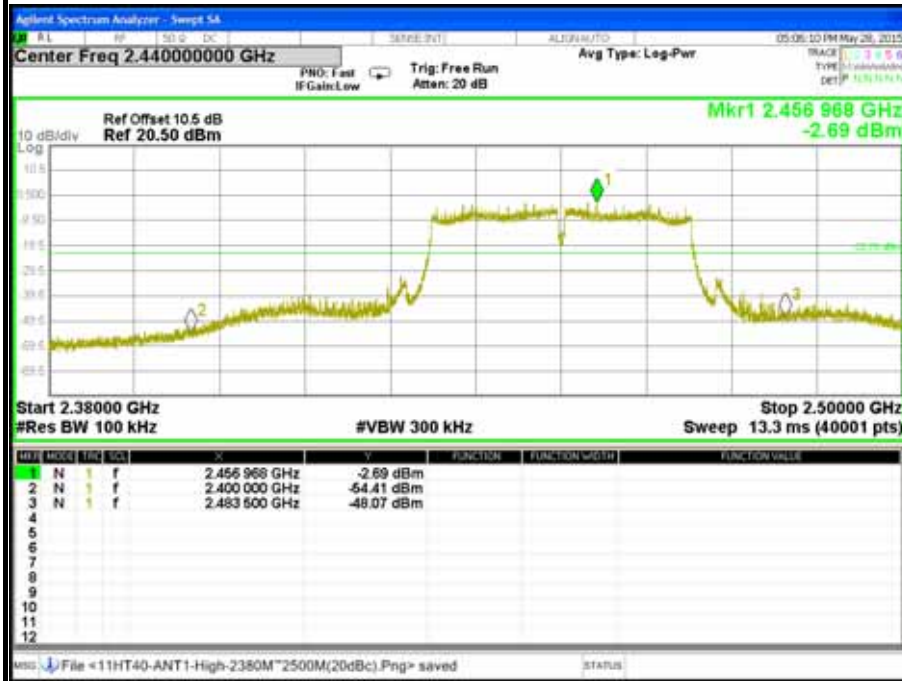

CH High (30MHz ~ 26.5GHz / IEEE 802.11gn HT40 Mode / Chain 1)

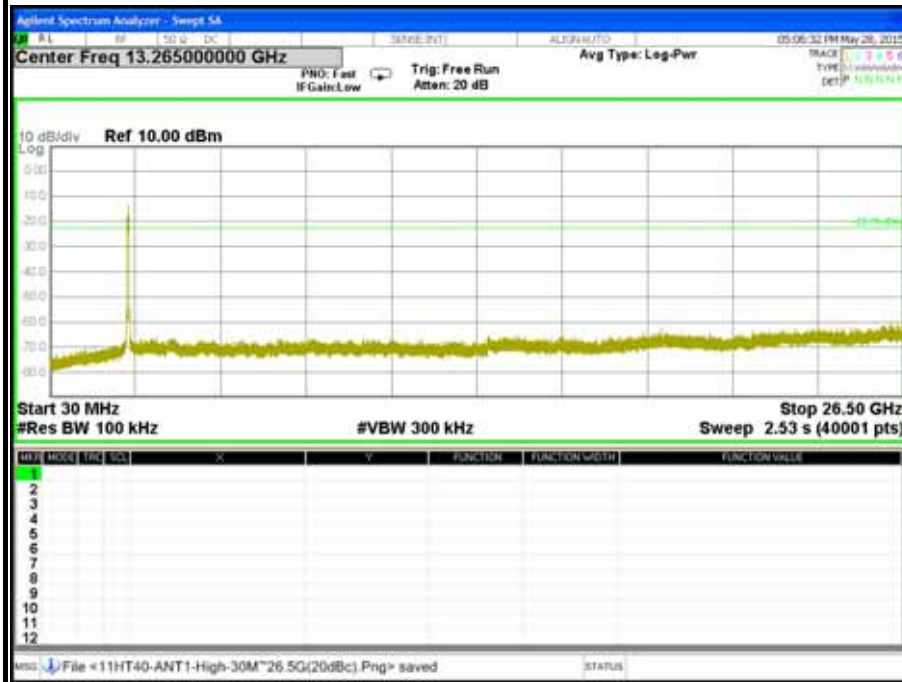



7.6 RADIATED EMISSION

LIMITS

(1) According to § 15.205 (a) Except as shown in paragraph (d) of this section, only spurious emissions are permitted in any of the frequency bands listed below:

MHz	MHz	MHz	GHz
0.090 - 0.110	16.42 - 16.423	399.9 - 410	4.5 - 5.15
¹ 0.495 - 0.505	16.69475 - 16.69525	608 - 614	5.35 - 5.46
2.1735 - 2.1905	16.80425 - 16.80475	960 - 1240	7.25 - 7.75
4.125 - 4.128	25.5 - 25.67	1300 - 1427	8.025 - 8.5
4.17725 - 4.17775	37.5 - 38.25	1435 - 1626.5	9.0 - 9.2
4.20725 - 4.20775	73 - 74.6	1645.5 - 1646.5	9.3 - 9.5
6.215 - 6.218	74.8 - 75.2	1660 - 1710	10.6 - 12.7
6.26775 - 6.26825	108 - 121.94	1718.8 - 1722.2	13.25 - 13.4
6.31175 - 6.31225	123 - 138	2200 - 2300	14.47 - 14.5
8.291 - 8.294	149.9 - 150.05	2310 - 2390	15.35 - 16.2
8.362 - 8.366	156.52475 - 156.52525	2483.5 - 2500	17.7 - 21.4
8.37625 - 8.38675	156.7 - 156.9	2655 - 2900	22.01 - 23.12
8.41425 - 8.41475	162.0125 - 167.17	3260 - 3267	23.6 - 24.0
12.29 - 12.293	167.72 - 173.2	3332 - 3339	31.2 - 31.8
12.51975 - 12.52025	240 - 285	3345.8 - 3338	36.43 - 36.5
12.57675 - 12.57725	322 - 335.4	3600 - 4400	(²)
13.36 - 13.41			

Remark:

1. ¹ Until February 1, 1999, this restricted band shall be 0.490-0.510 MHz.
2. ² Above 38.6

(2) According to § 15.205 (b) Except as provided in paragraphs (d) and (e), the field strength of emissions appearing within these frequency bands shall not exceed the limits shown in Section 15.209. At frequencies equal to or less than 1000 MHz, compliance with the limits in Section 15.209 shall be demonstrated using measurement instrumentation employing a CISPR quasi-peak detector. Above 1000 MHz, compliance with the emission limits in Section 15.209 shall be demonstrated based on the average value of the measured emissions. The provisions in Section 15.35 apply to these measurements.



(3) According to § 15.209 (a) Except as provided elsewhere in this Subpart, the emissions from an intentional radiator shall not exceed the field strength levels specified in the following table :

Frequency (MHz)	Field Strength (microvolts/meter)	Measurement Distance (meters)
0.009 – 0.490	2400/F(KHz)	300
0.490 – 1.705	24000/F(KHz)	30
1.705 – 30.0	30	30
30 - 88	100 **	3
88 - 216	150 **	3
216 - 960	200 **	3
Above 960	500	3

Remark: **Except as provided in paragraph (g), fundamental emissions from intentional radiators operating under this Section shall not be located in the frequency bands 54-72 MHz, 76-88 MHz, 174-216 MHz or 470-806 MHz. However, operation within these frequency bands is permitted under other sections of this Part, e.g., Sections 15.231 and 15.241.

(4) According to § 15.209 (b) In the emission table above, the tighter limit applies at the band edges.

TEST EQUIPMENT

Radiated Emission / 966Chamber_C

Name of Equipment	Manufacture	Model	Serial Number	Calibration Due
Spectrum Analyzer	Agilent	E4446A	MY43360132	06/10/2015
EMI Test Receiver	ROHDE & SCHWARZ	ESCI	101387	10/05/2015
Bi-log Antenna	TESEQ	CBL 6112D	35404	02/24/2016
Double-Ridged Waveguide Horn	ETS-LINDGREN	3117	00078732	07/23/2015
Horn Antenna	COM-POWER	AH-840	03077	12/17/2015
Pre-Amplifier	EMCI	EMC001625	980243	04/12/2016
Pre-Amplifier	COM-POWER	PAM-118A	551043	04/12/2016
Notch Filters Band Reject	Micro-Tronics	BRM50702-01	009	N.C.R
LOOP Antenna	EMCO	6502	8905-2356	09/23/2015

Remark: 1. Each piece of equipment is scheduled for calibration once a year.
2. N.C.R = No Calibration Request.



TEST SETUP

The diagram below shows the test setup that is utilized to make the measurements for emission below 1GHz.

9kHz ~ 30MHz

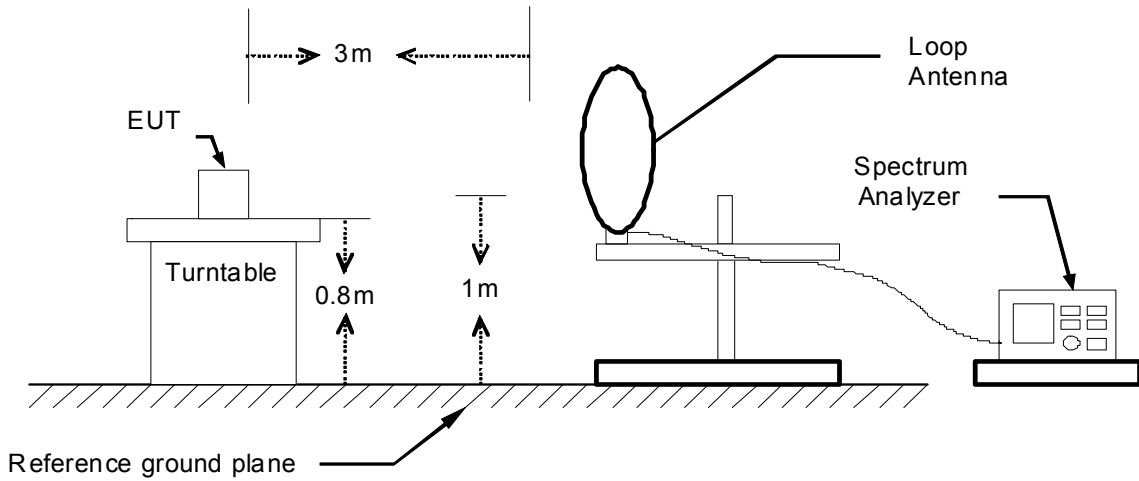

30MHz ~ 1GHz

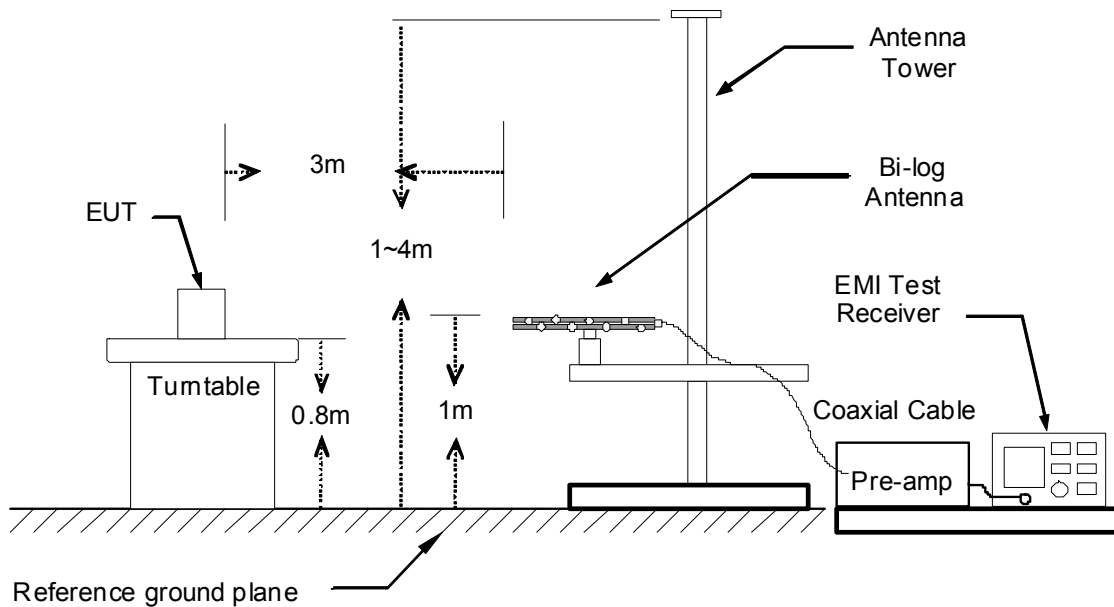



The diagram below shows the test setup that is utilized to make the measurements for emission above 1GHz.

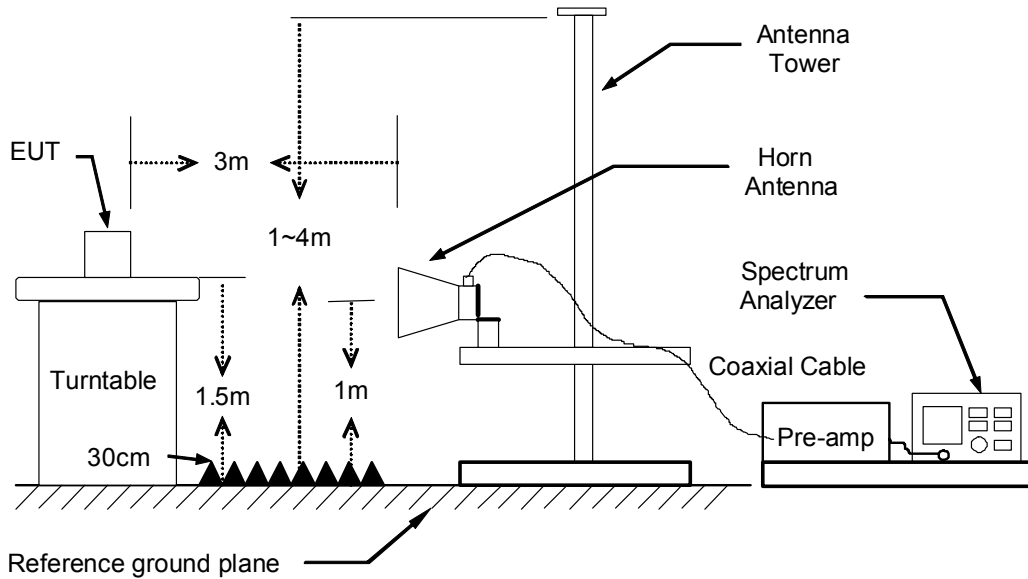

TEST PROCEDURE

1. The EUT was placed on the top of a rotating table 0.8 and 1.5 meters above the ground. The table was rotated 360 degrees to determine the position of the highest radiation.
2. While measuring the radiated emission below 1GHz, the EUT was set 3 meters away from the interference-receiving antenna, which was mounted on the top of a variable-height antenna tower. While measuring the radiated emission above 1GHz, the EUT was set 3 meters away from the interference-receiving antenna.
3. The antenna is a broadband antenna, and its height is varied from one meter to four meters above the ground to determine the maximum value of the field strength. Both horizontal and vertical polarization of the antenna are set to make the measurement.
4. For each suspected emission, the EUT was arranged to its worst case and then the antenna was tuned to heights from 1 meter to 4 meters and the table was turned from 0 degrees to 360 degrees to find the maximum reading.
5. The test-receiver system was set to Peak Detect Function and Specified Bandwidth with Maximum Hold Mode.
6. If the emission level of the EUT in peak mode was 10 dB lower than the limit specified, then testing could be stopped and the peak values of the EUT would be reported. Otherwise the emissions that did not have 10 dB margin would be re-tested one by one using peak, quasi-peak or average method as specified and then reported in a data sheet.

Remark :

1. The resolution bandwidth and video bandwidth of test receiver/spectrum analyzer is 120 KHz for Peak detection (PK) and Quasi-peak detection (QP) at frequency below 1GHz.
2. The resolution bandwidth and video bandwidth of test receiver/spectrum analyzer is 1 MHz for Peak detection and frequency above 1GHz.
3. The resolution bandwidth of test receiver/spectrum analyzer is 1 MHz and the video bandwidth is 10 Hz for Average detection (AV) at frequency above 1GHz.



TEST RESULTS

Below 1 GHz (9kHz ~ 30MHz)

No emission found between lowest internal used/generated frequency to 30MHz.

Below 1 GHz (30MHz ~ 1GHz)

Product Name	Dual-lines VDSL2/ADSL2+ Wireless-AC 3G/4G LTE VPN Firewall Router	Test By	Jey Li
Test Model	BiPAC 8920AX	Test Date	2015/05/13
Test Mode	Normal Operating	Temp. & Humidity	25°C, 50%

966 Chamber_C at 3Meter / Horizontal

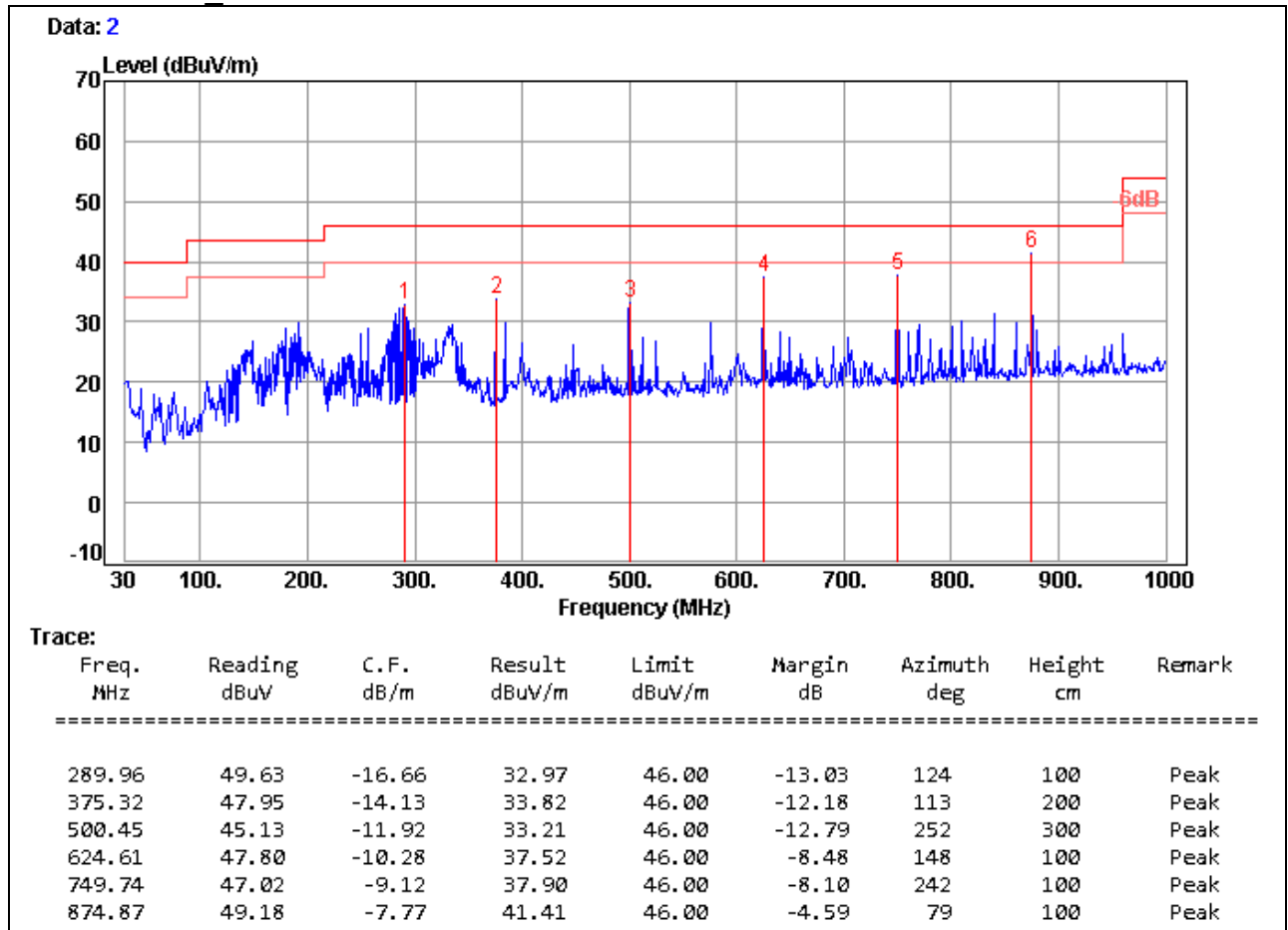

Remark:

1. Quasi-peak test would be performed if the peak result were greater than the quasi-peak limit.
2. Correction Factor (dB/m) = Antenna Factor (dB/m) + Cable Loss (dB) – PreAmp.Gain (dB)
3. Result (dBuV/m) = Reading (dBuV) + Correction Factor (dB/m)
4. Margin (dB) = Remark result (dBuV/m) - Quasi-peak limit (dBuV/m)



Product Name	Dual-lines VDSL2/ADSL2+ Wireless-AC 3G/4G LTE VPN Firewall Router	Test By	Jey Li
Test Model	BiPAC 8920AX	Test Date	2015/05/13
Test Mode	Normal Operating	Temp. & Humidity	25°C, 50%

966 Chamber_C at 3Meter / Vertical

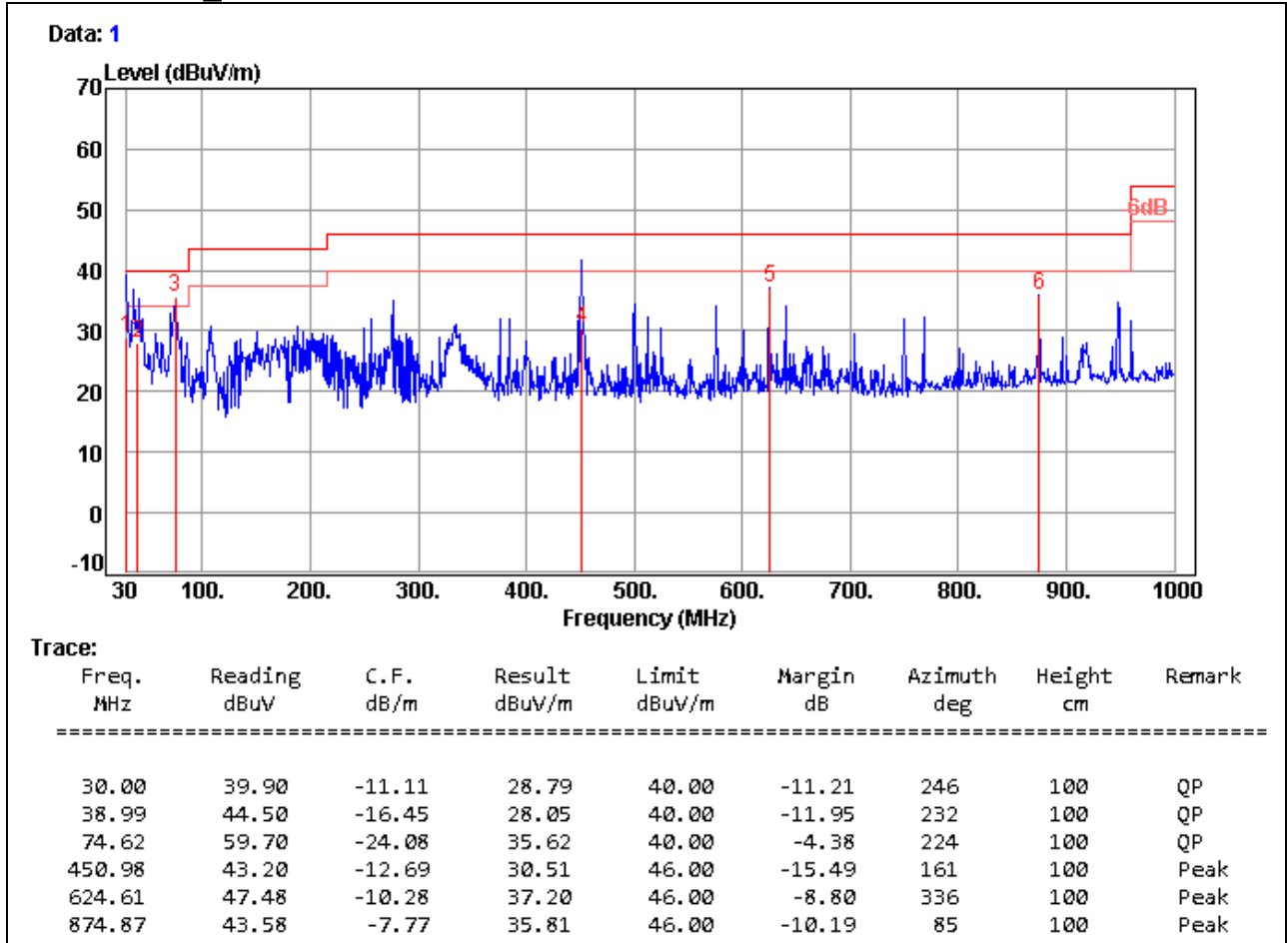

Remark:

1. Quasi-peak test would be performed if the peak result were greater than the quasi-peak limit.
2. Correction Factor (dB/m) = Antenna Factor (dB/m) + Cable Loss (dB) – PreAmp.Gain (dB)
3. Result (dBUV/m) = Reading (dBUV) + Correction Factor (dB/m)
4. Margin (dB) = Remark result (dBUV/m) - Quasi-peak limit (dBUV/m)



Above 1 GHz

Product Name	Dual-lines VDSL2/ADSL2+ Wireless-AC 3G/4G LTE VPN Firewall Router	Test By	Waternil Guan
Test Model	BiPAC 8920AX	Test Date	2015/05/14
Test Mode	IEEE 802.11b TX / CH Low	Temp. & Humidity	25°C, 53%

966 Chamber_C at 3Meter / Horizontal

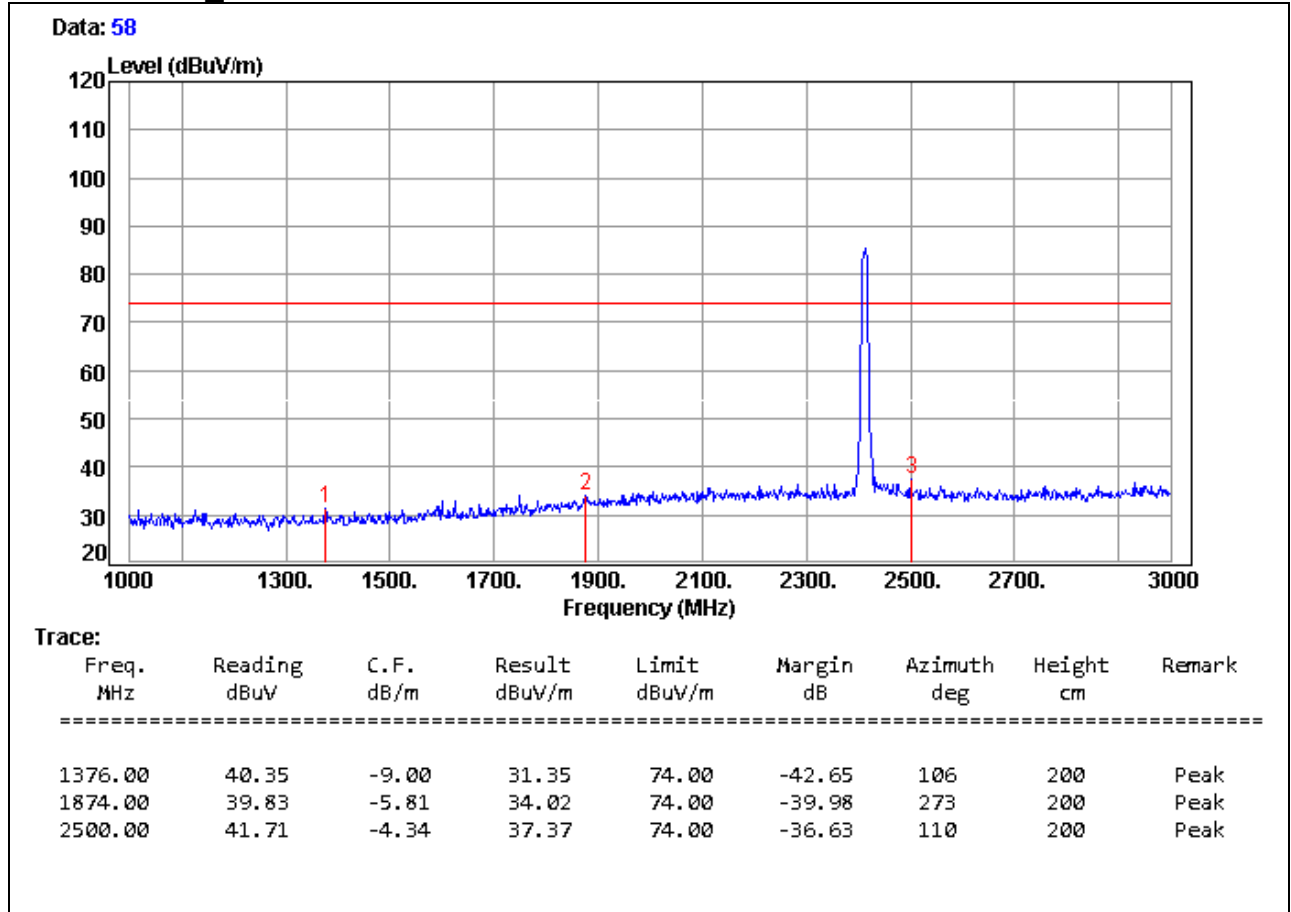

Remark:

1. Measuring frequencies from 1 GHz to the 10th harmonic of highest fundamental frequency.
2. Average test would be performed if the peak result were greater than the average limit.
3. Measurements above show only up to 6 maximum emissions noted, or would be lesser, with " N/A " remark, if no specific emissions from the EUT are recorded (ie: margin>20dB from the applicable limit) and considered that's already beyond the background noise floor.
4. Result = Reading + Correction Factor
Margin = Result - Limit
Remark Peak = Result(PK) - Limit(PK)
Remark AVG = Result(AV) - Limit(AV)



Product Name	Dual-lines VDSL2/ADSL2+ Wireless-AC 3G/4G LTE VPN Firewall Router	Test By	Waternil Guan
Test Model	BiPAC 8920AX	Test Date	2015/05/14
Test Mode	IEEE 802.11b TX / CH Low	Temp. & Humidity	25°C, 53%

966 Chamber_C at 3Meter / Horizontal

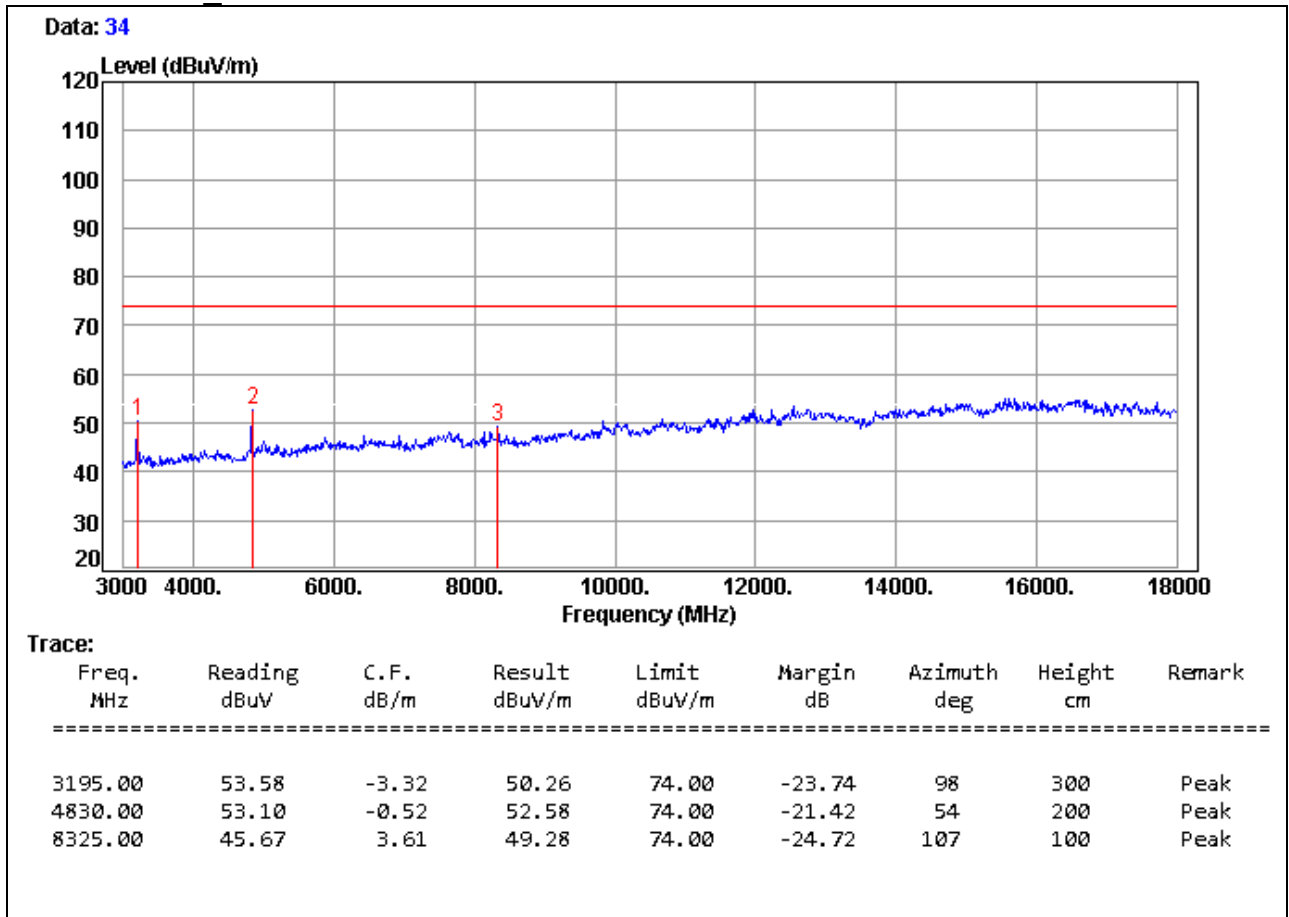

Remark:

1. Measuring frequencies from 1 GHz to the 10th harmonic of highest fundamental frequency.
2. Average test would be performed if the peak result were greater than the average limit.
3. Measurements above show only up to 6 maximum emissions noted, or would be lesser, with " N/A " remark, if no specific emissions from the EUT are recorded (ie: margin>20dB from the applicable limit) and considered that's already beyond the background noise floor.
4. Result = Reading + Correction Factor
Margin = Result - Limit
Remark Peak = Result(PK) - Limit(PK)
Remark AVG = Result(AV) - Limit(AV)
5. There is no emission in 18GHz ~ 26.5GHz.



Product Name	Dual-lines VDSL2/ADSL2+ Wireless-AC 3G/4G LTE VPN Firewall Router	Test By	Waternil Guan
Test Model	BiPAC 8920AX	Test Date	2015/05/14
Test Mode	IEEE 802.11b TX / CH Low	Temp. & Humidity	25°C, 53%

966 Chamber_C at 3Meter / Vertical

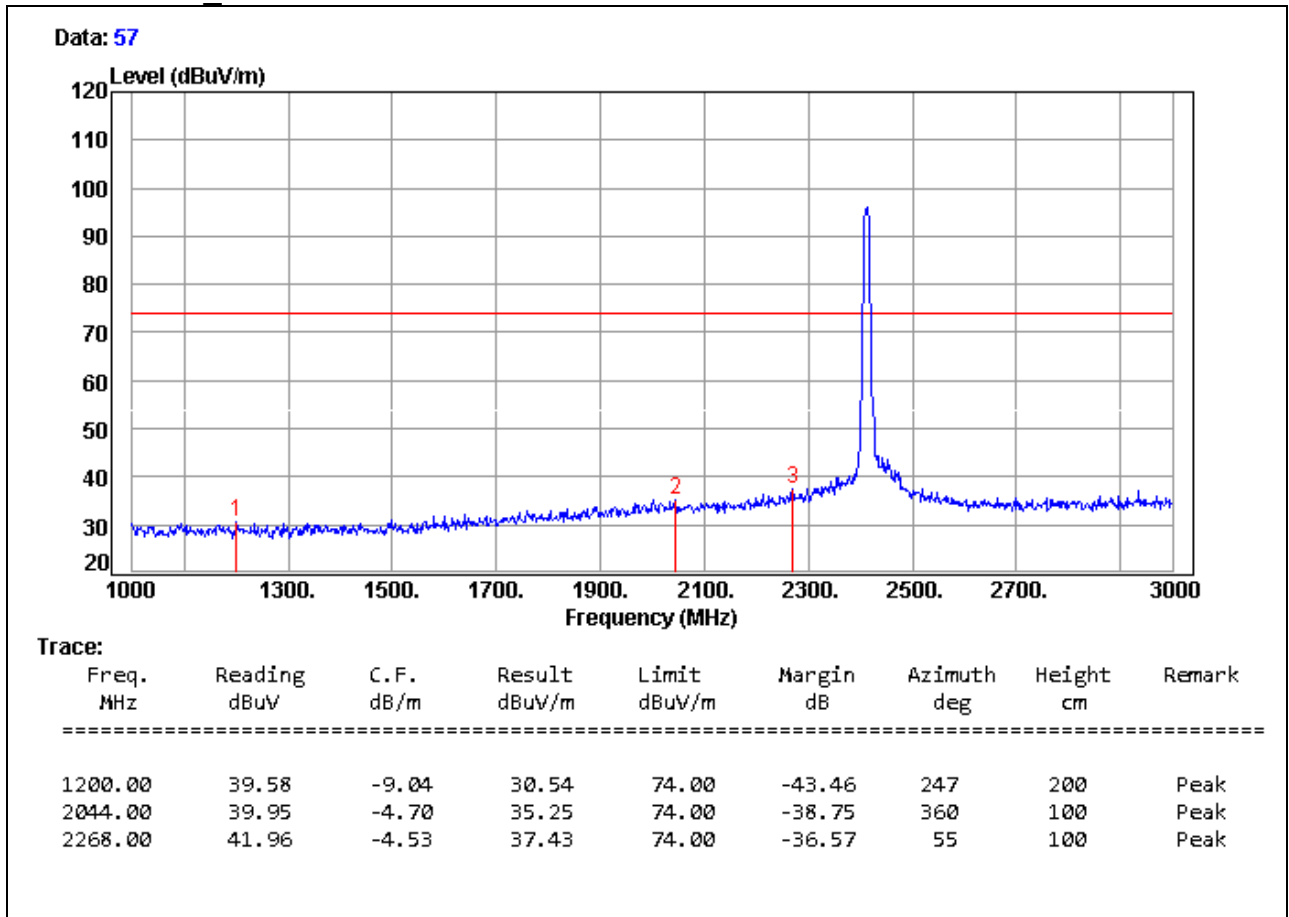

Remark:

1. Measuring frequencies from 1 GHz to the 10th harmonic of highest fundamental frequency.
2. Average test would be performed if the peak result were greater than the average limit.
3. Measurements above show only up to 6 maximum emissions noted, or would be lesser, with " N/A " remark, if no specific emissions from the EUT are recorded (ie: margin>20dB from the applicable limit) and considered that's already beyond the background noise floor.
4. Result = Reading + Correction Factor
 Margin = Result - Limit
 Remark Peak = Result(PK) - Limit(PK)
 Remark AVG = Result(AV) - Limit(AV)



Product Name	Dual-lines VDSL2/ADSL2+ Wireless-AC 3G/4G LTE VPN Firewall Router	Test By	Waternil Guan
Test Model	BiPAC 8920AX	Test Date	2015/05/14
Test Mode	IEEE 802.11b TX / CH Low	Temp. & Humidity	25°C, 53%

966 Chamber_C at 3Meter / Vertical

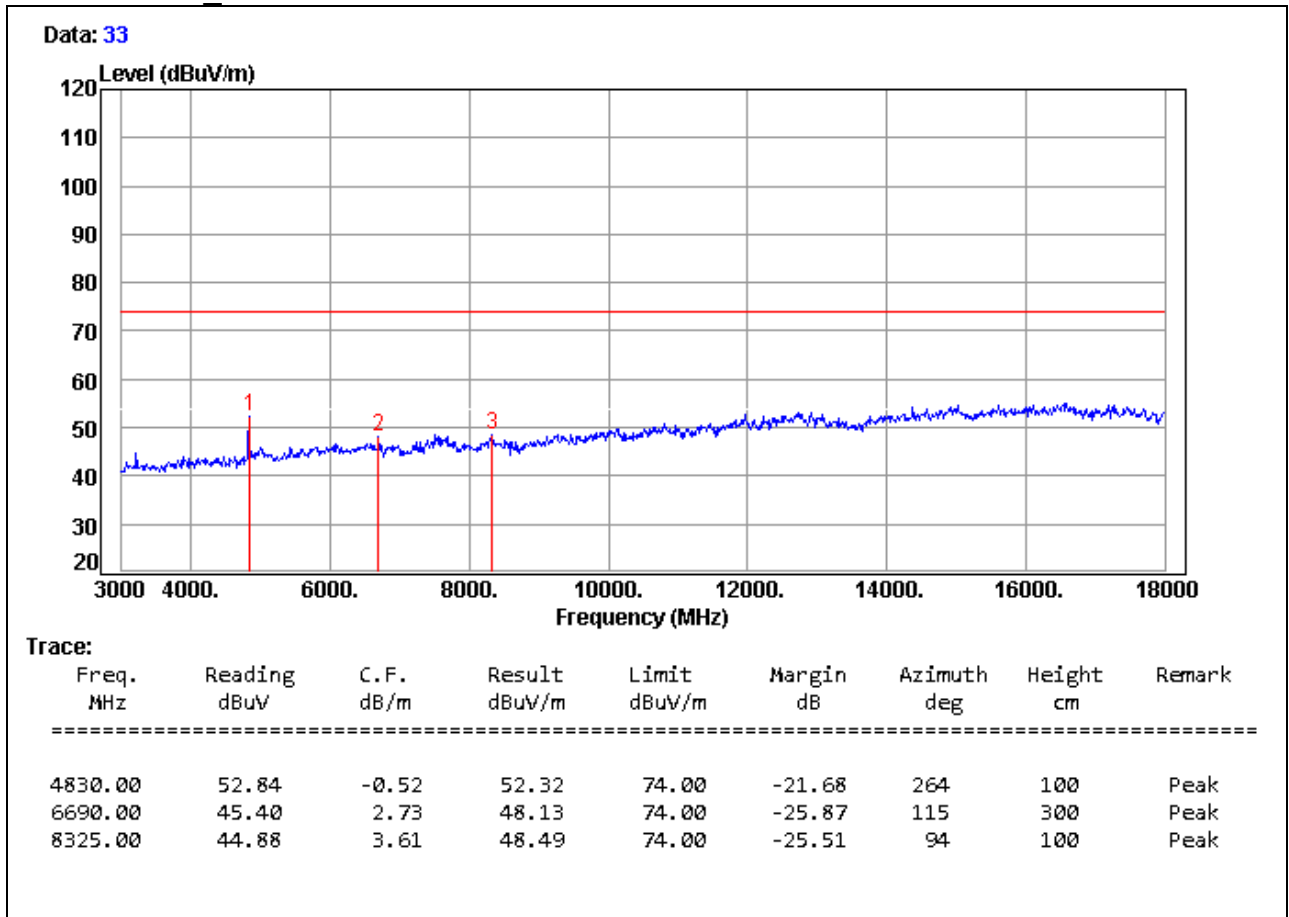

Remark:

1. Measuring frequencies from 1 GHz to the 10th harmonic of highest fundamental frequency.
2. Average test would be performed if the peak result were greater than the average limit.
3. Measurements above show only up to 6 maximum emissions noted, or would be lesser, with " N/A " remark, if no specific emissions from the EUT are recorded (ie: margin>20dB from the applicable limit) and considered that's already beyond the background noise floor.
4. Result = Reading + Correction Factor
Margin = Result - Limit
Remark Peak = Result(PK) - Limit(PK)
Remark AVG = Result(AV) - Limit(AV)
5. There is no emission in 18GHz ~ 26.5GHz.



Product Name	Dual-lines VDSL2/ADSL2+ Wireless-AC 3G/4G LTE VPN Firewall Router	Test By	Waternil Guan
Test Model	BiPAC 8920AX	Test Date	2015/05/14
Test Mode	IEEE 802.11b TX / CH Middle	Temp. & Humidity	25°C, 53%

966 Chamber_C at 3Meter / Horizontal

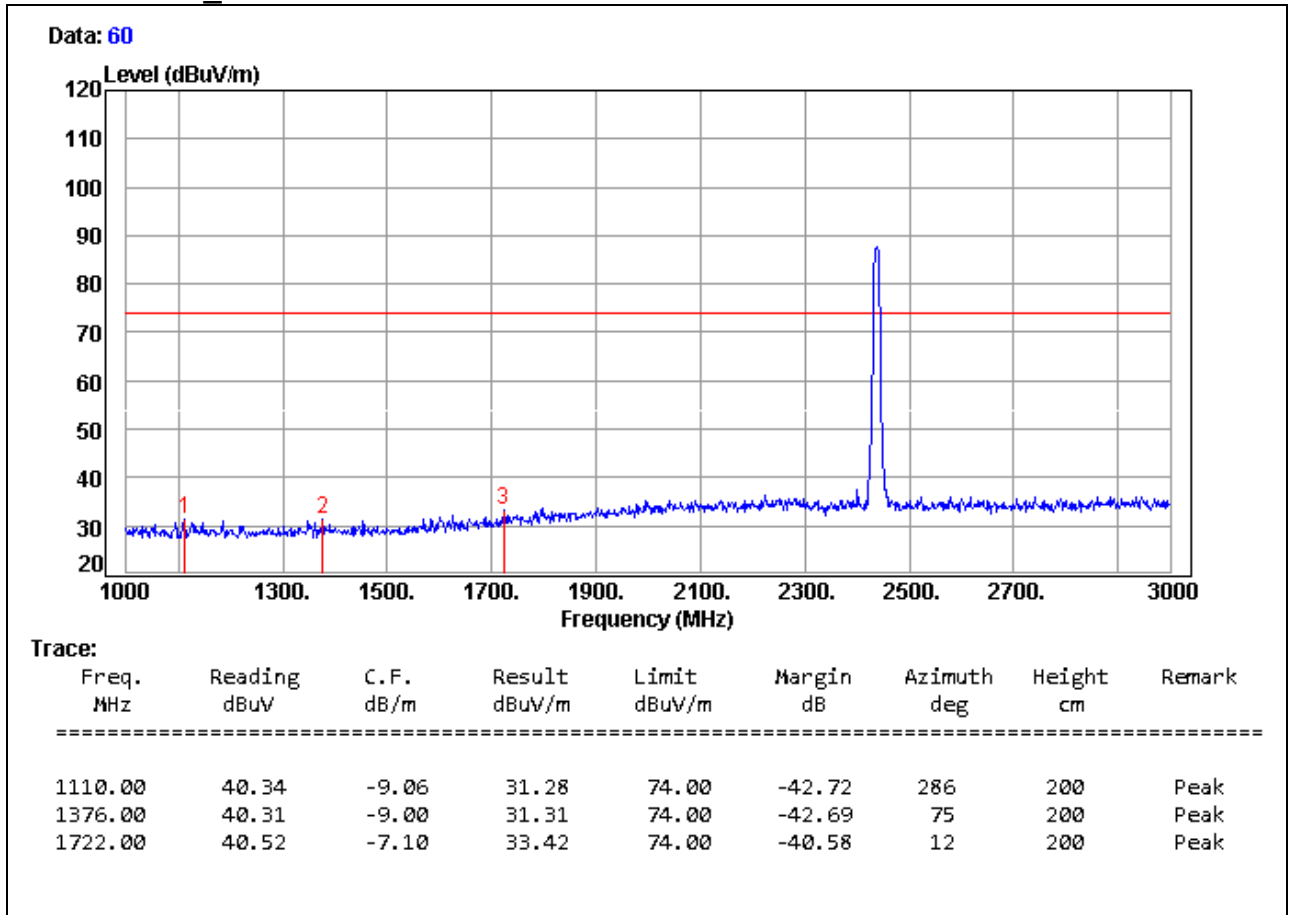

Remark:

1. Measuring frequencies from 1 GHz to the 10th harmonic of highest fundamental frequency.
2. Average test would be performed if the peak result were greater than the average limit.
3. Measurements above show only up to 6 maximum emissions noted, or would be lesser, with " N/A " remark, if no specific emissions from the EUT are recorded (ie: margin>20dB from the applicable limit) and considered that's already beyond the background noise floor.
4. Result = Reading + Correction Factor
 Margin = Result – Limit
 Remark Peak = Result(PK) – Limit(PK)
 Remark AVG = Result(AV) – Limit(AV)



Product Name	Dual-lines VDSL2/ADSL2+ Wireless-AC 3G/4G LTE VPN Firewall Router	Test By	Waternil Guan
Test Model	BiPAC 8920AX	Test Date	2015/05/14
Test Mode	IEEE 802.11b TX / CH Middle	Temp. & Humidity	25°C, 53%

966 Chamber_C at 3Meter / Horizontal

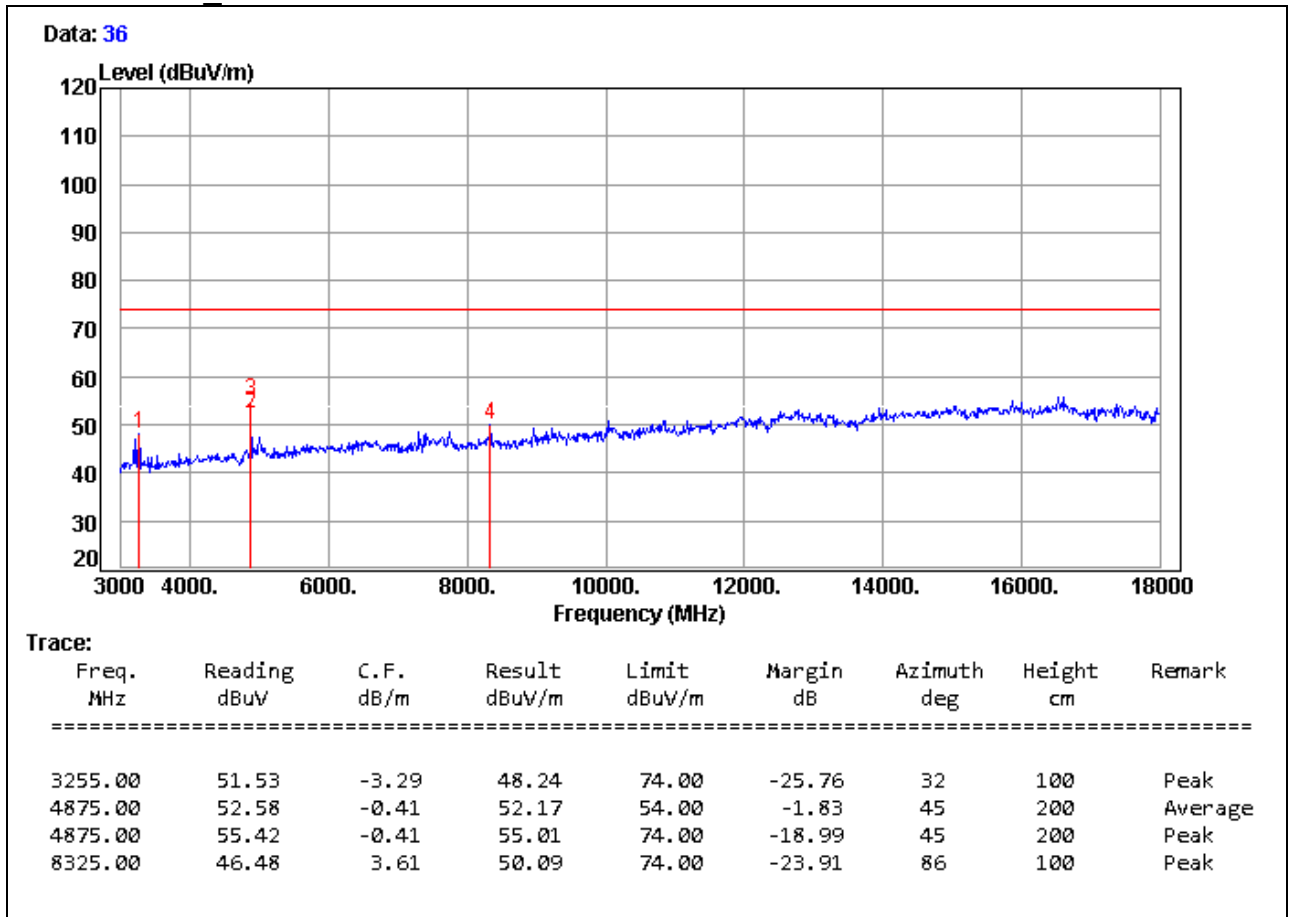

Remark:

1. Measuring frequencies from 1 GHz to the 10th harmonic of highest fundamental frequency.
2. Average test would be performed if the peak result were greater than the average limit.
3. Measurements above show only up to 6 maximum emissions noted, or would be lesser, with " N/A " remark, if no specific emissions from the EUT are recorded (ie: margin>20dB from the applicable limit) and considered that's already beyond the background noise floor.
4. Result = Reading + Correction Factor
Margin = Result - Limit
Remark Peak = Result(PK) - Limit(PK)
Remark AVG = Result(AV) - Limit(AV)
5. There is no emission in 18GHz ~ 26.5GHz.



Product Name	Dual-lines VDSL2/ADSL2+ Wireless-AC 3G/4G LTE VPN Firewall Router	Test By	Waternil Guan
Test Model	BiPAC 8920AX	Test Date	2015/05/14
Test Mode	IEEE 802.11b TX / CH Middle	Temp. & Humidity	25°C, 53%

966 Chamber_C at 3Meter / Vertical

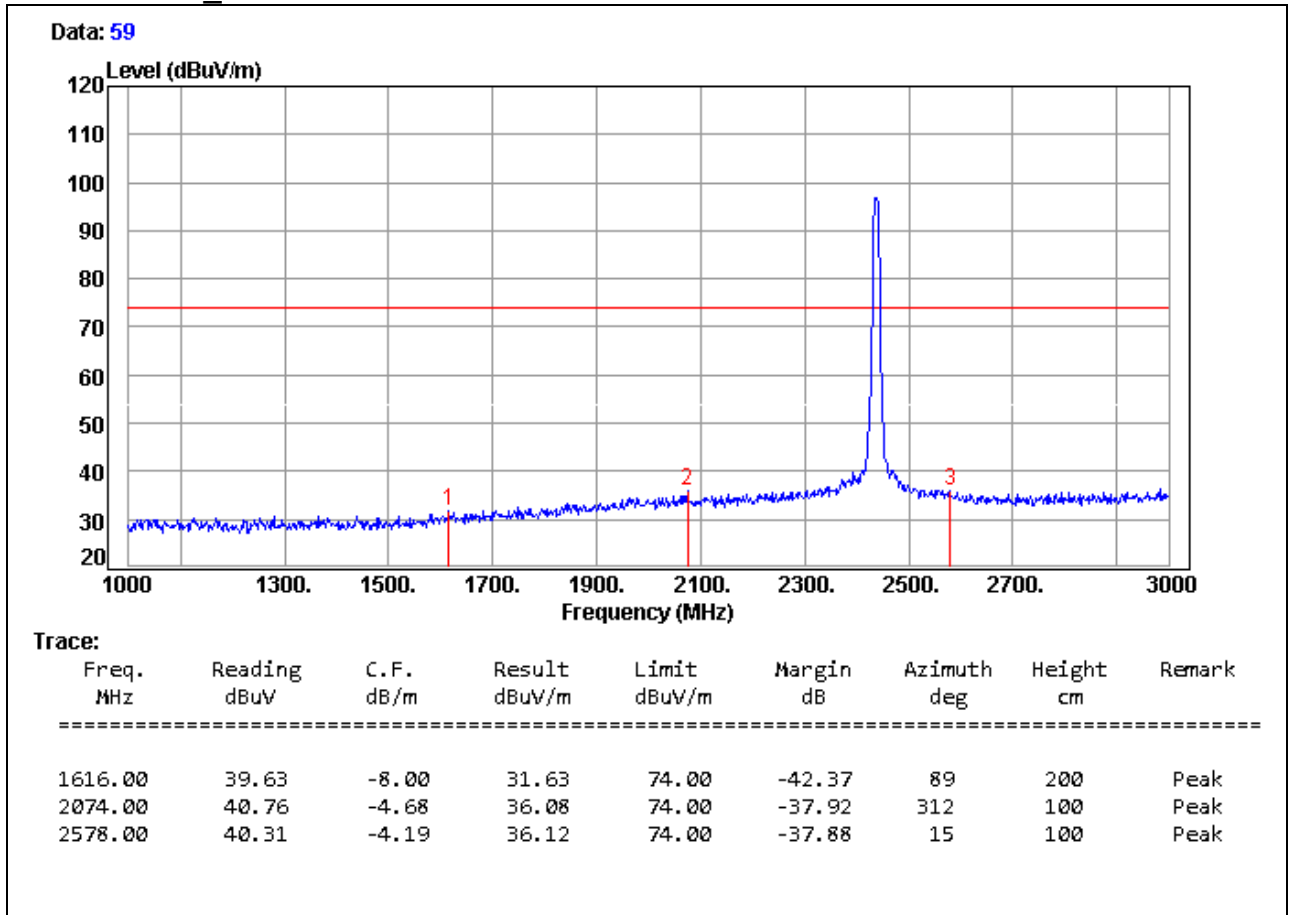

Remark:

1. Measuring frequencies from 1 GHz to the 10th harmonic of highest fundamental frequency.
2. Average test would be performed if the peak result were greater than the average limit.
3. Measurements above show only up to 6 maximum emissions noted, or would be lesser, with " N/A " remark, if no specific emissions from the EUT are recorded (ie: margin>20dB from the applicable limit) and considered that's already beyond the background noise floor.
4. Result = Reading + Correction Factor
 Margin = Result - Limit
 Remark Peak = Result(PK) - Limit(PK)
 Remark AVG = Result(AV) - Limit(AV)



Product Name	Dual-lines VDSL2/ADSL2+ Wireless-AC 3G/4G LTE VPN Firewall Router	Test By	Waternil Guan
Test Model	BiPAC 8920AX	Test Date	2015/05/14
Test Mode	IEEE 802.11b TX / CH Middle	Temp. & Humidity	25°C, 53%

966 Chamber_C at 3Meter / Vertical

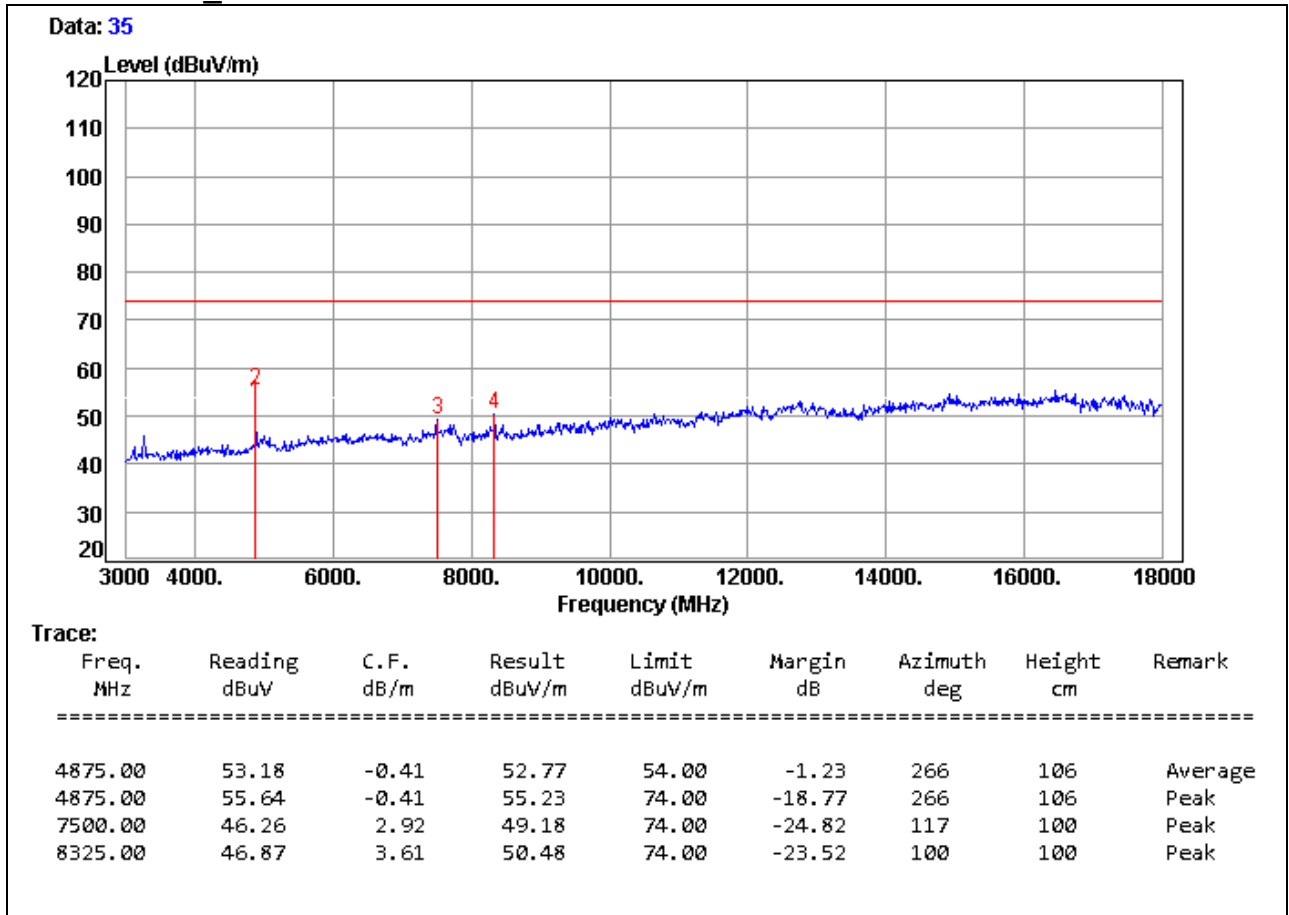

Remark:

1. Measuring frequencies from 1 GHz to the 10th harmonic of highest fundamental frequency.
2. Average test would be performed if the peak result were greater than the average limit.
3. Measurements above show only up to 6 maximum emissions noted, or would be lesser, with " N/A " remark, if no specific emissions from the EUT are recorded (ie: margin>20dB from the applicable limit) and considered that's already beyond the background noise floor.
4. Result = Reading + Correction Factor
Margin = Result - Limit
Remark Peak = Result(PK) - Limit(PK)
Remark AVG = Result(AV) - Limit(AV)
5. There is no emission in 18GHz ~ 26.5GHz.



Product Name	Dual-lines VDSL2/ADSL2+ Wireless-AC 3G/4G LTE VPN Firewall Router	Test By	Waternil Guan
Test Model	BiPAC 8920AX	Test Date	2015/05/14
Test Mode	IEEE 802.11b TX / CH High	Temp. & Humidity	25°C, 53%

966 Chamber_C at 3Meter / Horizontal

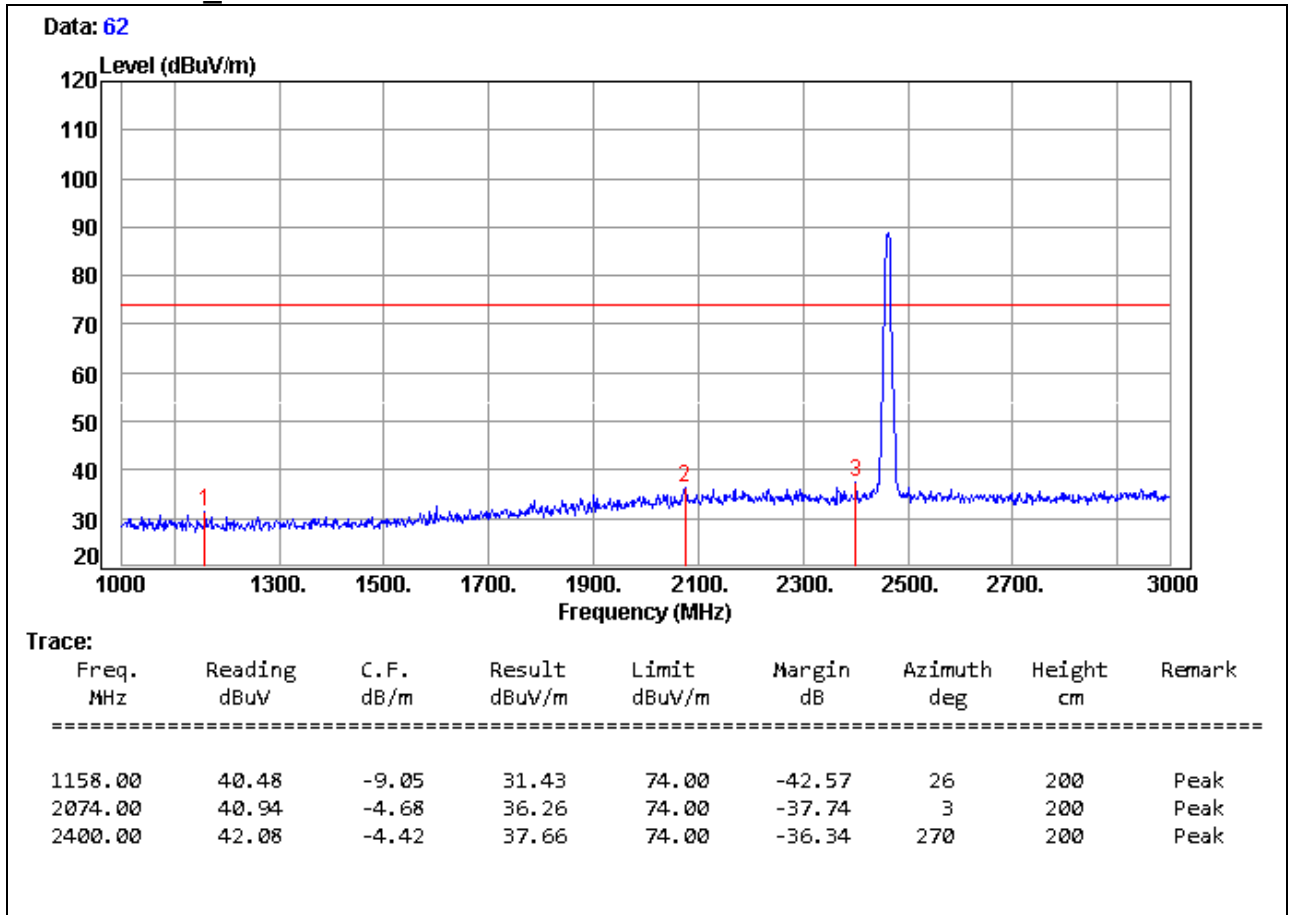

Remark:

1. Measuring frequencies from 1 GHz to the 10th harmonic of highest fundamental frequency.
2. Average test would be performed if the peak result were greater than the average limit.
3. Measurements above show only up to 6 maximum emissions noted, or would be lesser, with " N/A " remark, if no specific emissions from the EUT are recorded (ie: margin>20dB from the applicable limit) and considered that's already beyond the background noise floor.
4. Result = Reading + Correction Factor
 Margin = Result - Limit
 Remark Peak = Result(PK) - Limit(PK)
 Remark AVG = Result(AV) - Limit(AV)



Product Name	Dual-lines VDSL2/ADSL2+ Wireless-AC 3G/4G LTE VPN Firewall Router	Test By	Waternil Guan
Test Model	BiPAC 8920AX	Test Date	2015/05/14
Test Mode	IEEE 802.11b TX / CH High	Temp. & Humidity	25°C, 53%

966 Chamber_C at 3Meter / Horizontal

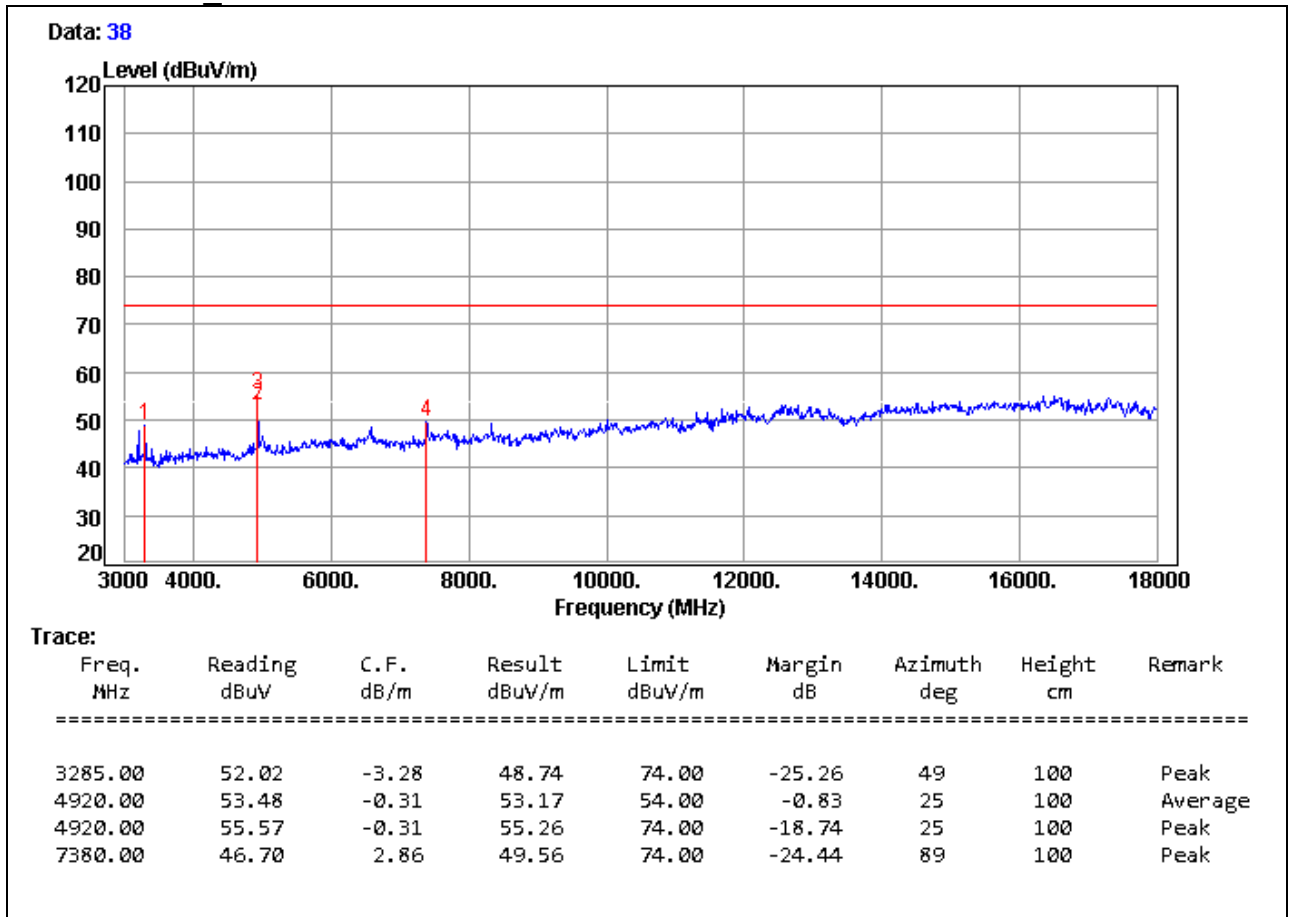

Remark:

1. Measuring frequencies from 1 GHz to the 10th harmonic of highest fundamental frequency.
2. Average test would be performed if the peak result were greater than the average limit.
3. Measurements above show only up to 6 maximum emissions noted, or would be lesser, with " N/A " remark, if no specific emissions from the EUT are recorded (ie: margin>20dB from the applicable limit) and considered that's already beyond the background noise floor.
4. Result = Reading + Correction Factor
Margin = Result - Limit
Remark Peak = Result(PK) - Limit(PK)
Remark AVG = Result(AV) - Limit(AV)
5. There is no emission in 18GHz ~ 26.5GHz.



Product Name	Dual-lines VDSL2/ADSL2+ Wireless-AC 3G/4G LTE VPN Firewall Router	Test By	Waternil Guan
Test Model	BiPAC 8920AX	Test Date	2015/05/14
Test Mode	IEEE 802.11b TX / CH High	Temp. & Humidity	25°C, 53%

966 Chamber_C at 3Meter / Vertical

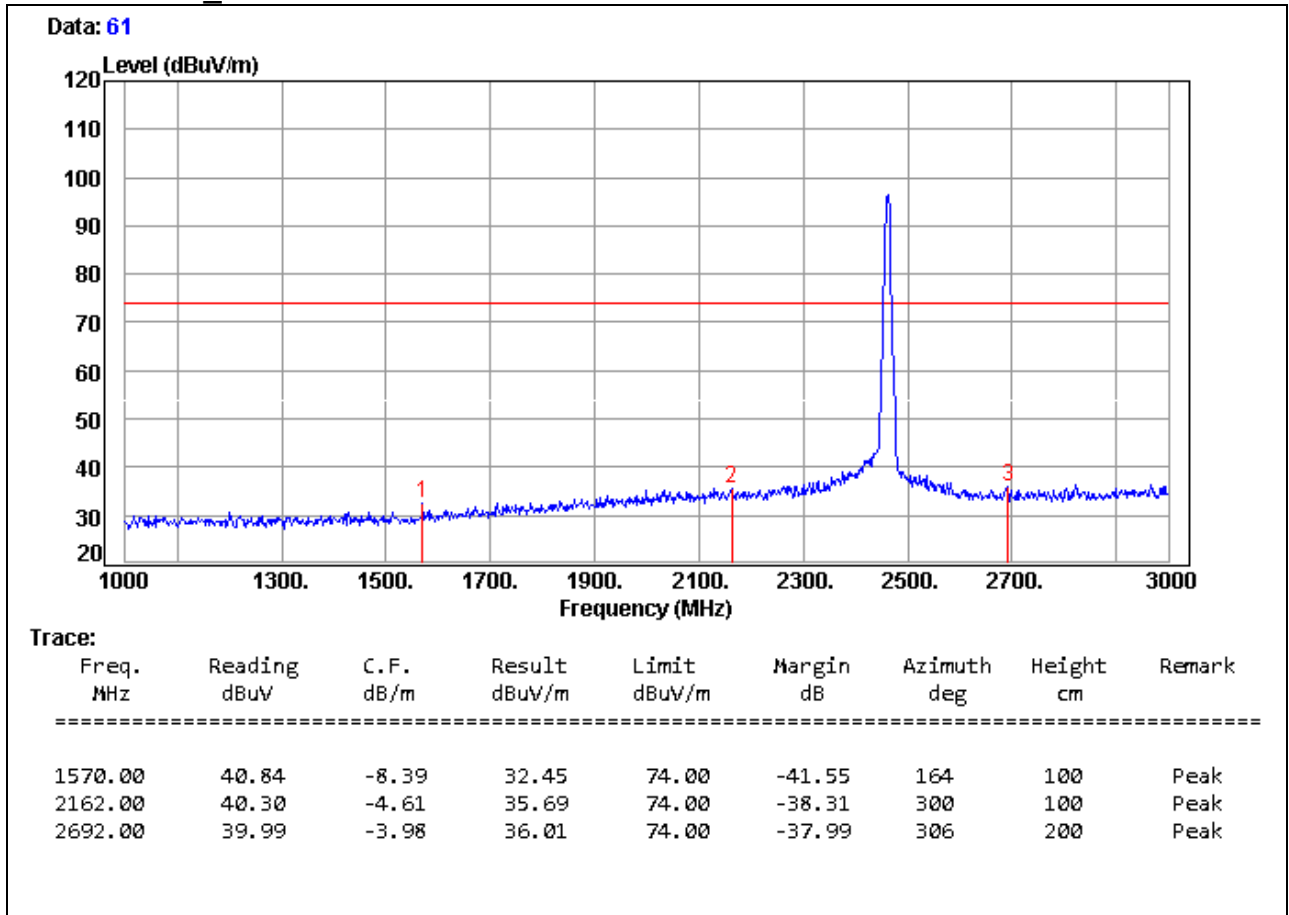

Remark:

1. Measuring frequencies from 1 GHz to the 10th harmonic of highest fundamental frequency.
2. Average test would be performed if the peak result were greater than the average limit.
3. Measurements above show only up to 6 maximum emissions noted, or would be lesser, with "N/A" remark, if no specific emissions from the EUT are recorded (ie: margin>20dB from the applicable limit) and considered that's already beyond the background noise floor.
4. Result = Reading + Correction Factor
 Margin = Result - Limit
 Remark Peak = Result(PK) - Limit(PK)
 Remark AVG = Result(AV) - Limit(AV)



Product Name	Dual-lines VDSL2/ADSL2+ Wireless-AC 3G/4G LTE VPN Firewall Router	Test By	Waternil Guan
Test Model	BiPAC 8920AX	Test Date	2015/05/14
Test Mode	IEEE 802.11b TX / CH High	Temp. & Humidity	25°C, 53%

966 Chamber_C at 3Meter / Vertical

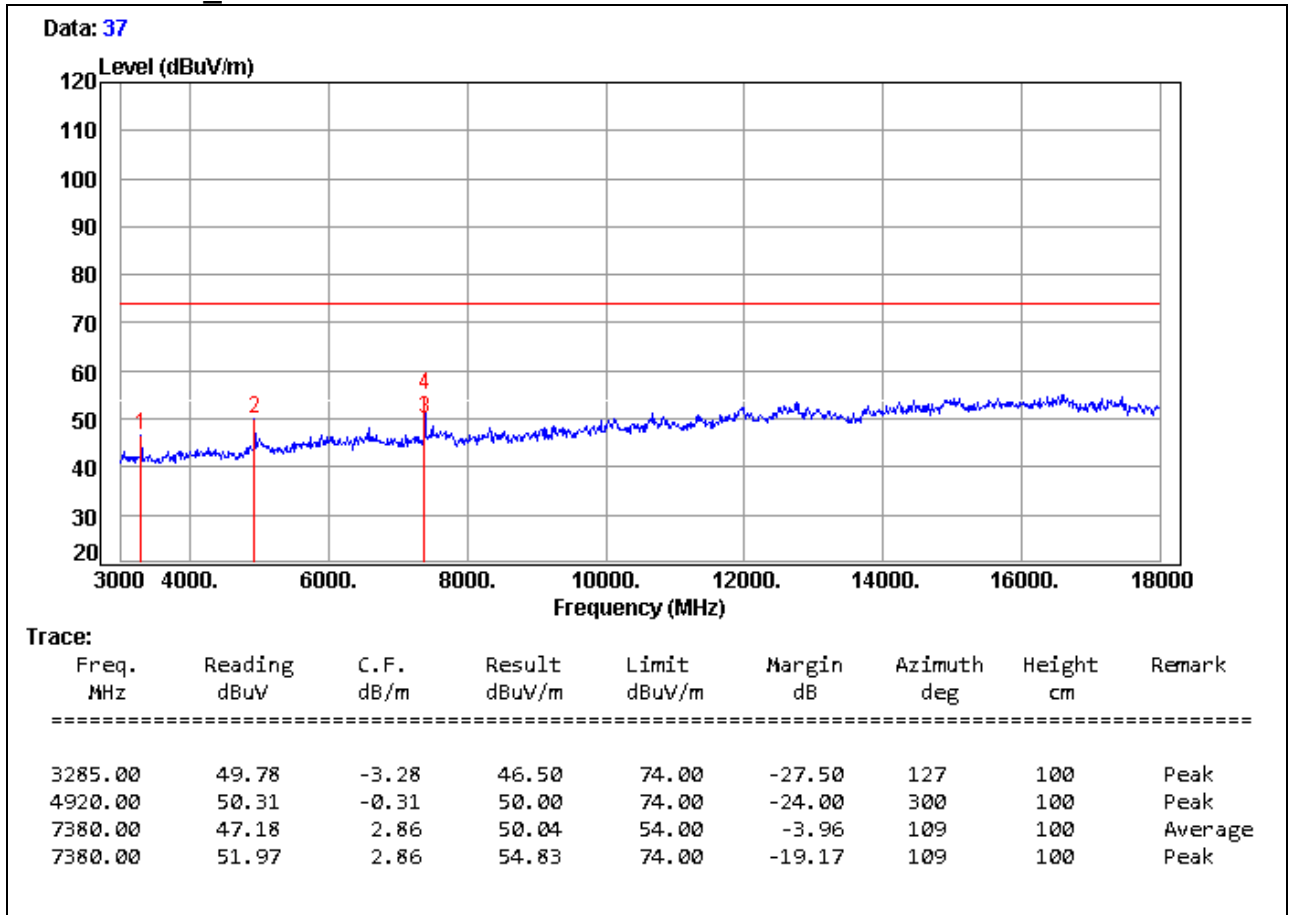

Remark:

1. Measuring frequencies from 1 GHz to the 10th harmonic of highest fundamental frequency.
2. Average test would be performed if the peak result were greater than the average limit.
3. Measurements above show only up to 6 maximum emissions noted, or would be lesser, with " N/A " remark, if no specific emissions from the EUT are recorded (ie: margin>20dB from the applicable limit) and considered that's already beyond the background noise floor.
4. Result = Reading + Correction Factor
Margin = Result - Limit
Remark Peak = Result(PK) - Limit(PK)
Remark AVG = Result(AV) - Limit(AV)
5. There is no emission in 18GHz ~ 26.5GHz.



Product Name	Dual-lines VDSL2/ADSL2+ Wireless-AC 3G/4G LTE VPN Firewall Router	Test By	Waternil Guan
Test Model	BiPAC 8920AX	Test Date	2015/05/14
Test Mode	IEEE 802.11g TX / CH Low	Temp. & Humidity	25°C, 53%

966 Chamber_C at 3Meter / Horizontal

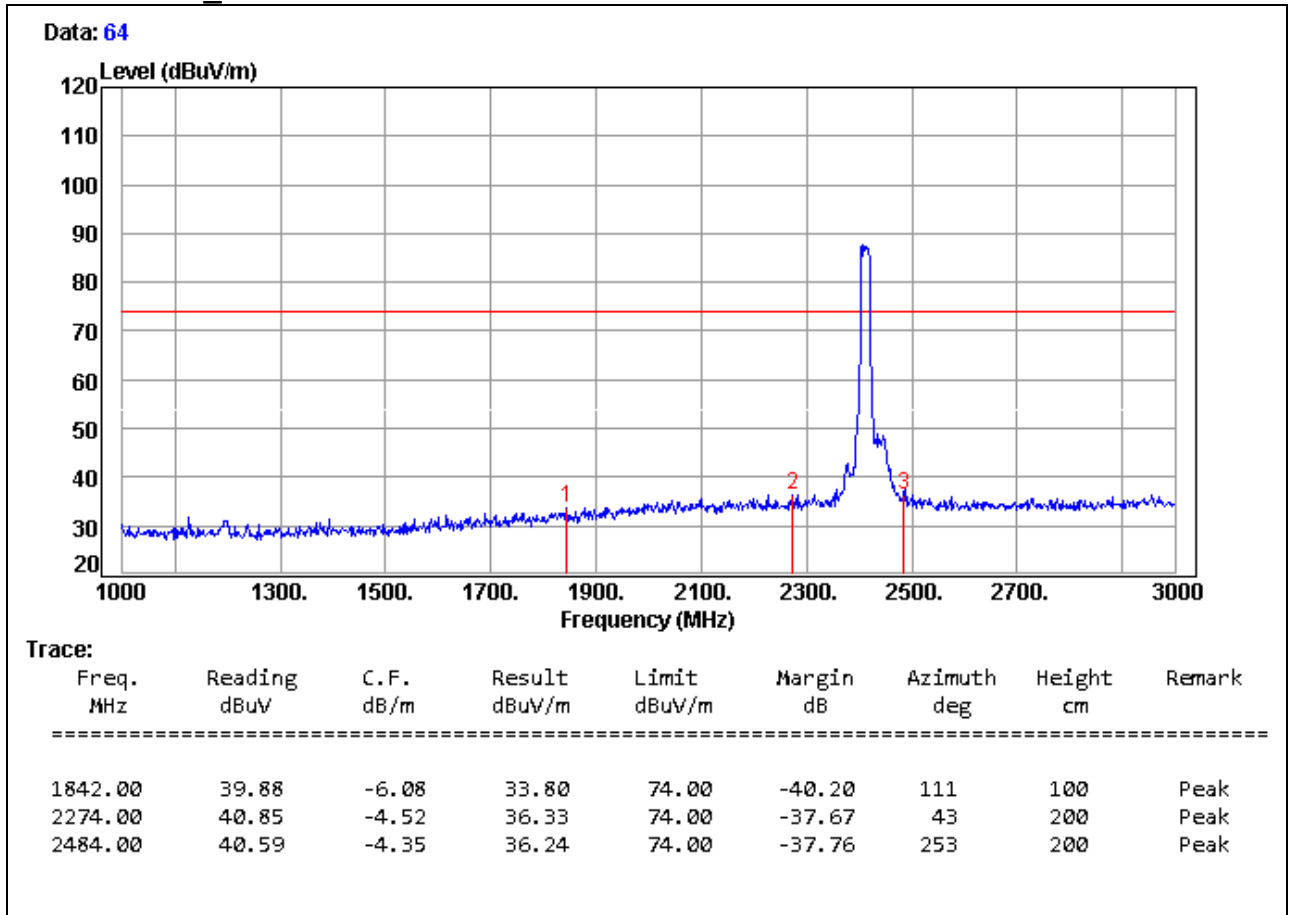

Remark:

1. Measuring frequencies from 1 GHz to the 10th harmonic of highest fundamental frequency.
2. Average test would be performed if the peak result were greater than the average limit.
3. Measurements above show only up to 6 maximum emissions noted, or would be lesser, with " N/A " remark, if no specific emissions from the EUT are recorded (ie: margin>20dB from the applicable limit) and considered that's already beyond the background noise floor.
4. Result = Reading + Correction Factor
Margin = Result - Limit
Remark Peak = Result(PK) - Limit(PK)
Remark AVG = Result(AV) - Limit(AV)



Product Name	Dual-lines VDSL2/ADSL2+ Wireless-AC 3G/4G LTE VPN Firewall Router	Test By	Waternil Guan
Test Model	BiPAC 8920AX	Test Date	2015/05/14
Test Mode	IEEE 802.11g TX / CH Low	Temp. & Humidity	25°C, 53%

966 Chamber_C at 3Meter / Horizontal

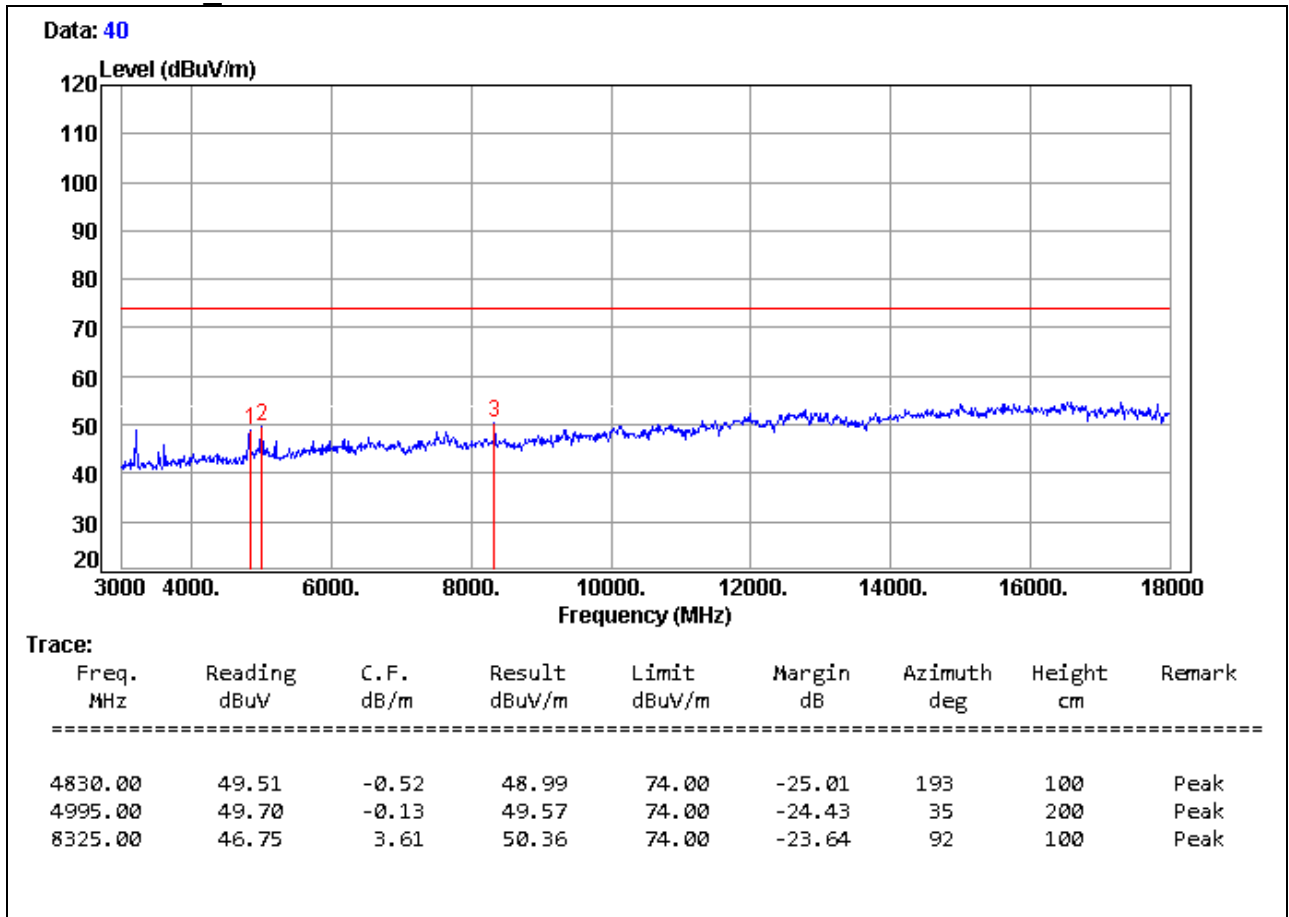

Remark:

1. Measuring frequencies from 1 GHz to the 10th harmonic of highest fundamental frequency.
2. Average test would be performed if the peak result were greater than the average limit.
3. Measurements above show only up to 6 maximum emissions noted, or would be lesser, with " N/A " remark, if no specific emissions from the EUT are recorded (ie: margin>20dB from the applicable limit) and considered that's already beyond the background noise floor.
4. Result = Reading + Correction Factor
Margin = Result - Limit
Remark Peak = Result(PK) - Limit(PK)
Remark AVG = Result(AV) - Limit(AV)
5. There is no emission in 18GHz ~ 26.5GHz.



Product Name	Dual-lines VDSL2/ADSL2+ Wireless-AC 3G/4G LTE VPN Firewall Router	Test By	Waternil Guan
Test Model	BiPAC 8920AX	Test Date	2015/05/14
Test Mode	IEEE 802.11g TX / CH Low	Temp. & Humidity	25°C, 53%

966 Chamber_C at 3Meter / Vertical

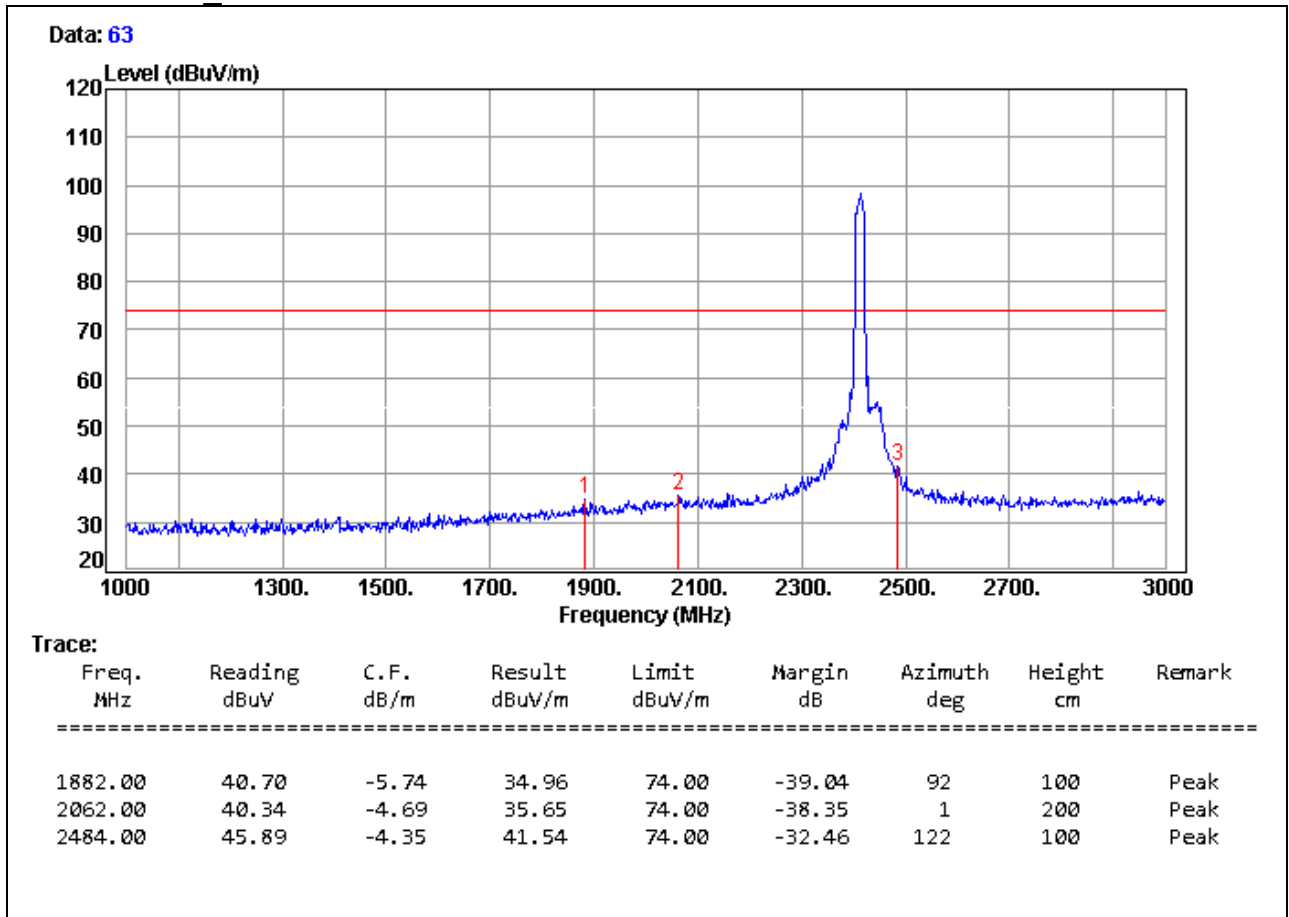

Remark:

1. Measuring frequencies from 1 GHz to the 10th harmonic of highest fundamental frequency.
2. Average test would be performed if the peak result were greater than the average limit.
3. Measurements above show only up to 6 maximum emissions noted, or would be lesser, with " N/A " remark, if no specific emissions from the EUT are recorded (ie: margin>20dB from the applicable limit) and considered that's already beyond the background noise floor.
4. Result = Reading + Correction Factor
 Margin = Result - Limit
 Remark Peak = Result(PK) - Limit(PK)
 Remark AVG = Result(AV) - Limit(AV)



Product Name	Dual-lines VDSL2/ADSL2+ Wireless-AC 3G/4G LTE VPN Firewall Router	Test By	Waternil Guan
Test Model	BiPAC 8920AX	Test Date	2015/05/14
Test Mode	IEEE 802.11g TX / CH Low	Temp. & Humidity	25°C, 53%

966 Chamber_C at 3Meter / Vertical

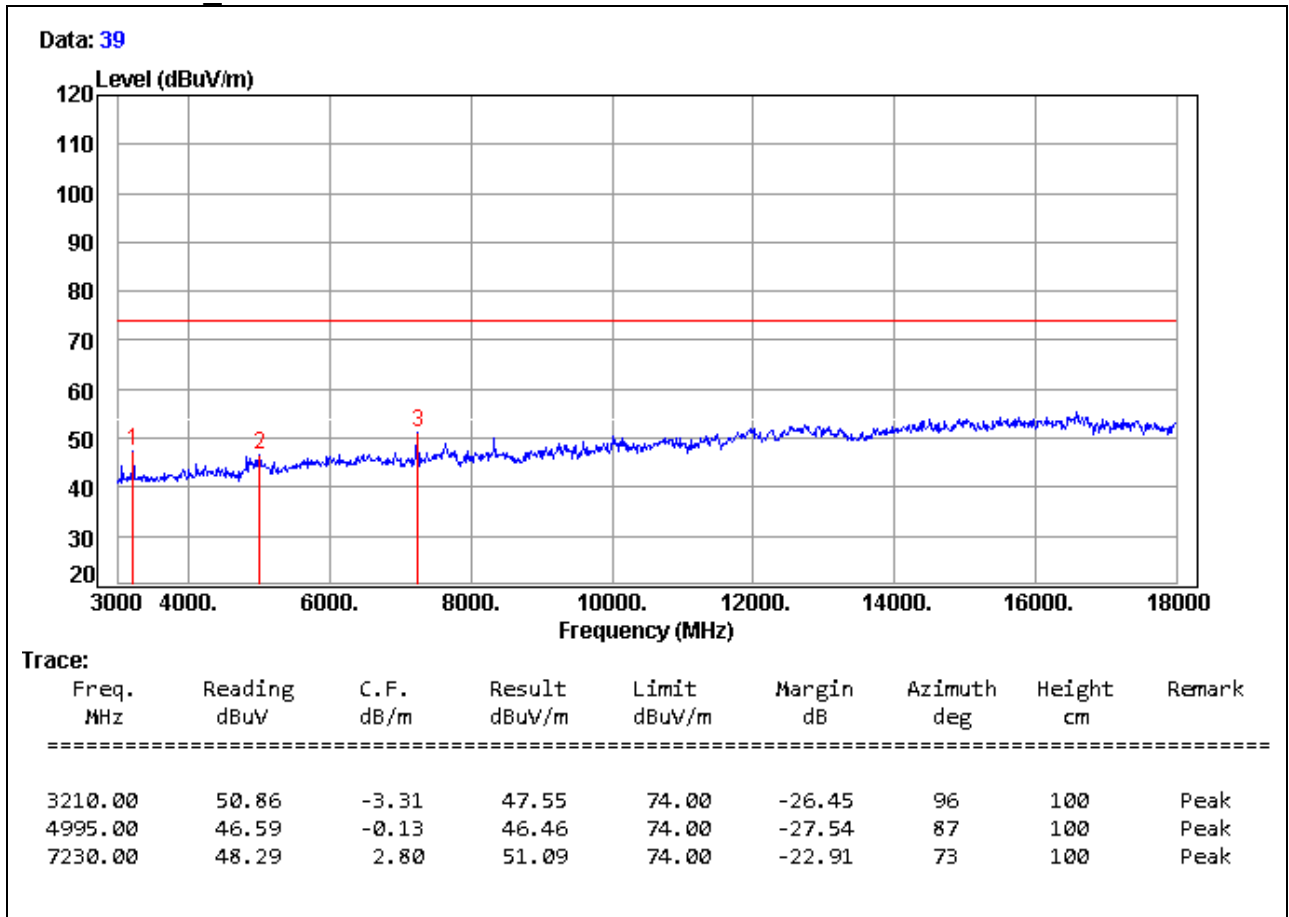

Remark:

1. Measuring frequencies from 1 GHz to the 10th harmonic of highest fundamental frequency.
2. Average test would be performed if the peak result were greater than the average limit.
3. Measurements above show only up to 6 maximum emissions noted, or would be lesser, with " N/A " remark, if no specific emissions from the EUT are recorded (ie: margin>20dB from the applicable limit) and considered that's already beyond the background noise floor.
4. Result = Reading + Correction Factor
Margin = Result - Limit
Remark Peak = Result(PK) - Limit(PK)
Remark AVG = Result(AV) - Limit(AV)
5. There is no emission in 18GHz ~ 26.5GHz.



Product Name	Dual-lines VDSL2/ADSL2+ Wireless-AC 3G/4G LTE VPN Firewall Router	Test By	Waternil Guan
Test Model	BiPAC 8920AX	Test Date	2015/05/14
Test Mode	IEEE 802.11g TX / CH Middle	Temp. & Humidity	25°C, 53%

966 Chamber_C at 3Meter / Horizontal

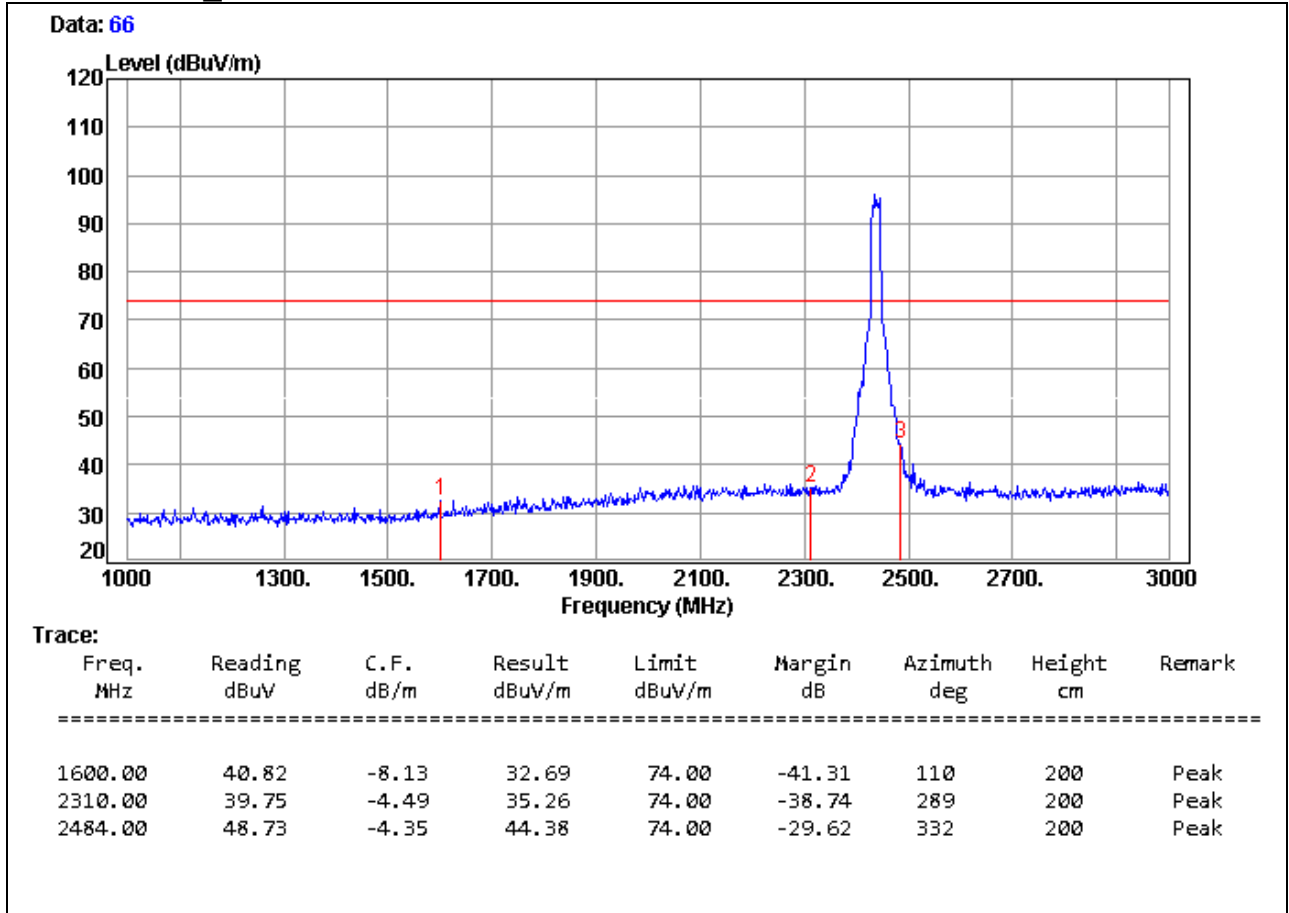

Remark:

1. Measuring frequencies from 1 GHz to the 10th harmonic of highest fundamental frequency.
2. Average test would be performed if the peak result were greater than the average limit.
3. Measurements above show only up to 6 maximum emissions noted, or would be lesser, with " N/A " remark, if no specific emissions from the EUT are recorded (ie: margin>20dB from the applicable limit) and considered that's already beyond the background noise floor.
4. Result = Reading + Correction Factor
Margin = Result - Limit
Remark Peak = Result(PK) - Limit(PK)
Remark AVG = Result(AV) - Limit(AV)



Product Name	Dual-lines VDSL2/ADSL2+ Wireless-AC 3G/4G LTE VPN Firewall Router	Test By	Waternil Guan
Test Model	BiPAC 8920AX	Test Date	2015/05/14
Test Mode	IEEE 802.11g TX / CH Middle	Temp. & Humidity	25°C, 53%

966 Chamber_C at 3Meter / Horizontal

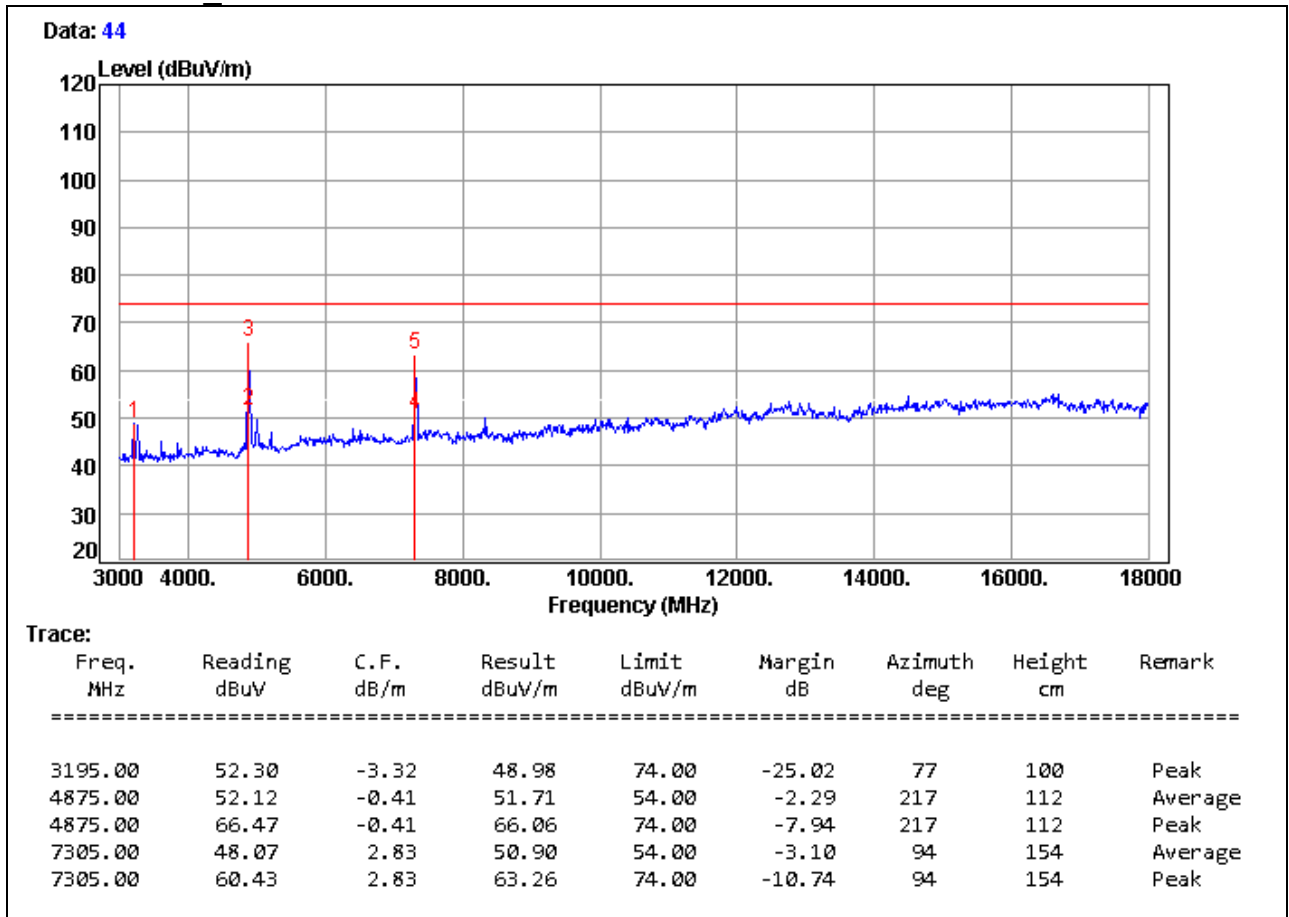

Remark:

1. Measuring frequencies from 1 GHz to the 10th harmonic of highest fundamental frequency.
2. Average test would be performed if the peak result were greater than the average limit.
3. Measurements above show only up to 6 maximum emissions noted, or would be lesser, with " N/A " remark, if no specific emissions from the EUT are recorded (ie: margin>20dB from the applicable limit) and considered that's already beyond the background noise floor.
4. Result = Reading + Correction Factor
Margin = Result - Limit
Remark Peak = Result(PK) - Limit(PK)
Remark AVG = Result(AV) - Limit(AV)
5. There is no emission in 18GHz ~ 26.5GHz.



Product Name	Dual-lines VDSL2/ADSL2+ Wireless-AC 3G/4G LTE VPN Firewall Router	Test By	Waternil Guan
Test Model	BiPAC 8920AX	Test Date	2015/05/14
Test Mode	IEEE 802.11g TX / CH Middle	Temp. & Humidity	25°C, 53%

966 Chamber_C at 3Meter / Vertical

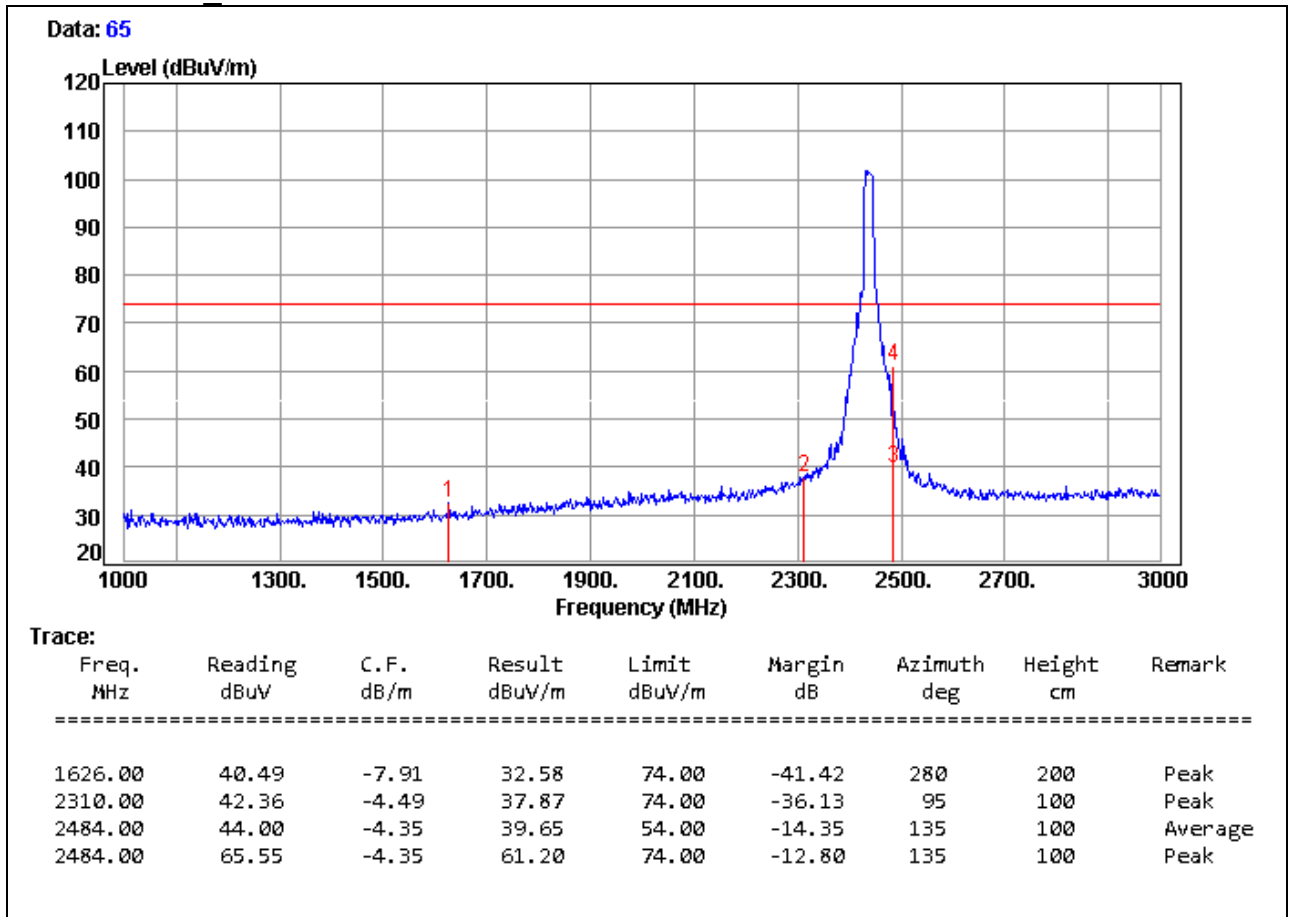

Remark:

1. Measuring frequencies from 1 GHz to the 10th harmonic of highest fundamental frequency.
2. Average test would be performed if the peak result were greater than the average limit.
3. Measurements above show only up to 6 maximum emissions noted, or would be lesser, with " N/A " remark, if no specific emissions from the EUT are recorded (ie: margin>20dB from the applicable limit) and considered that's already beyond the background noise floor.
4. Result = Reading + Correction Factor
 Margin = Result - Limit
 Remark Peak = Result(PK) - Limit(PK)
 Remark AVG = Result(AV) - Limit(AV)



Product Name	Dual-lines VDSL2/ADSL2+ Wireless-AC 3G/4G LTE VPN Firewall Router	Test By	Waternil Guan
Test Model	BiPAC 8920AX	Test Date	2015/05/14
Test Mode	IEEE 802.11g TX / CH Middle	Temp. & Humidity	25°C, 53%

966 Chamber_C at 3Meter / Vertical

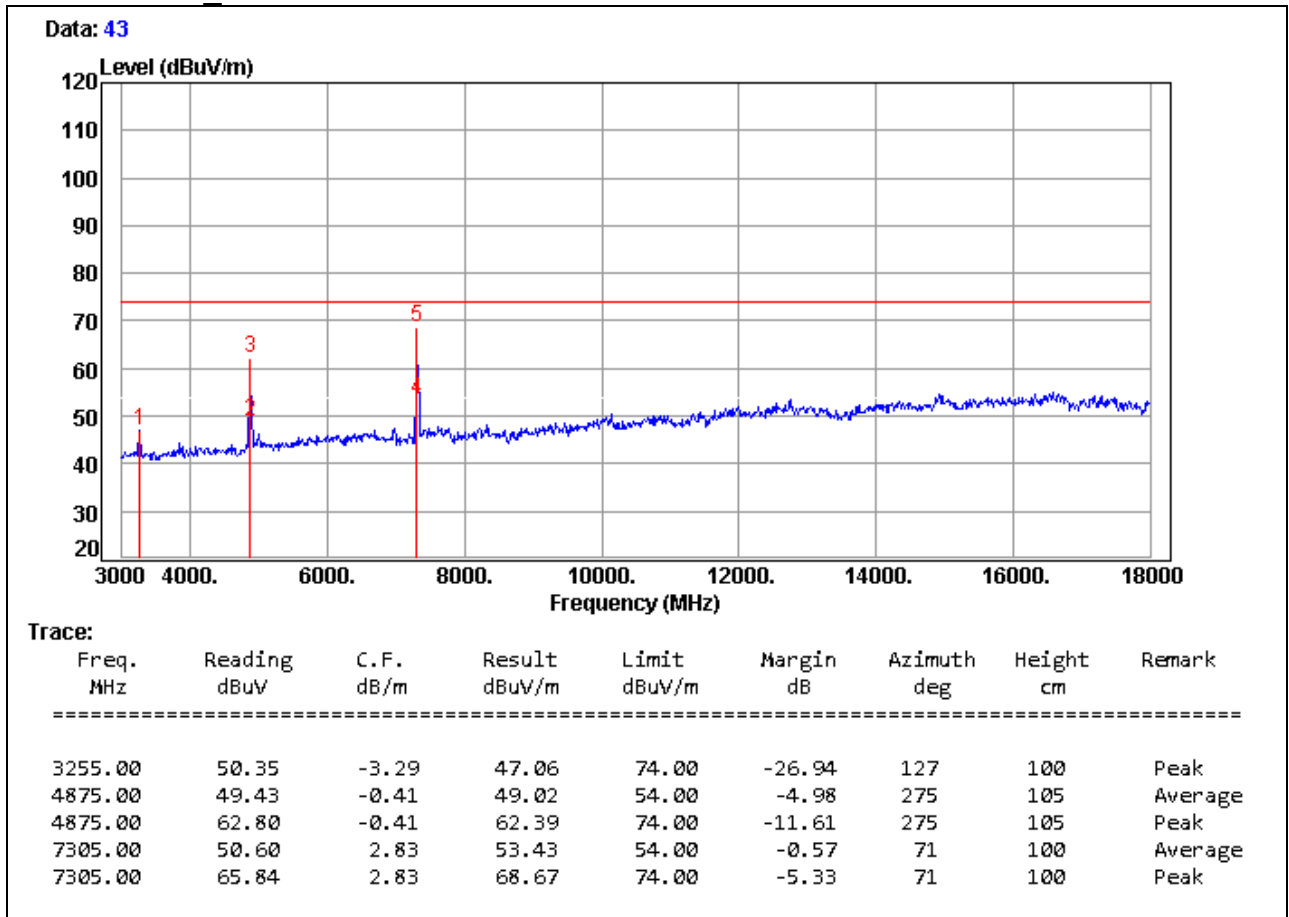

Remark:

1. Measuring frequencies from 1 GHz to the 10th harmonic of highest fundamental frequency.
2. Average test would be performed if the peak result were greater than the average limit.
3. Measurements above show only up to 6 maximum emissions noted, or would be lesser, with " N/A " remark, if no specific emissions from the EUT are recorded (ie: margin>20dB from the applicable limit) and considered that's already beyond the background noise floor.
4. Result = Reading + Correction Factor
Margin = Result - Limit
Remark Peak = Result(PK) - Limit(PK)
Remark AVG = Result(AV) - Limit(AV)
5. There is no emission in 18GHz ~ 26.5GHz.



Product Name	Dual-lines VDSL2/ADSL2+ Wireless-AC 3G/4G LTE VPN Firewall Router	Test By	Waternil Guan
Test Model	BiPAC 8920AX	Test Date	2015/05/14
Test Mode	IEEE 802.11g TX / CH High	Temp. & Humidity	25°C, 53%

966 Chamber_C at 3Meter / Horizontal

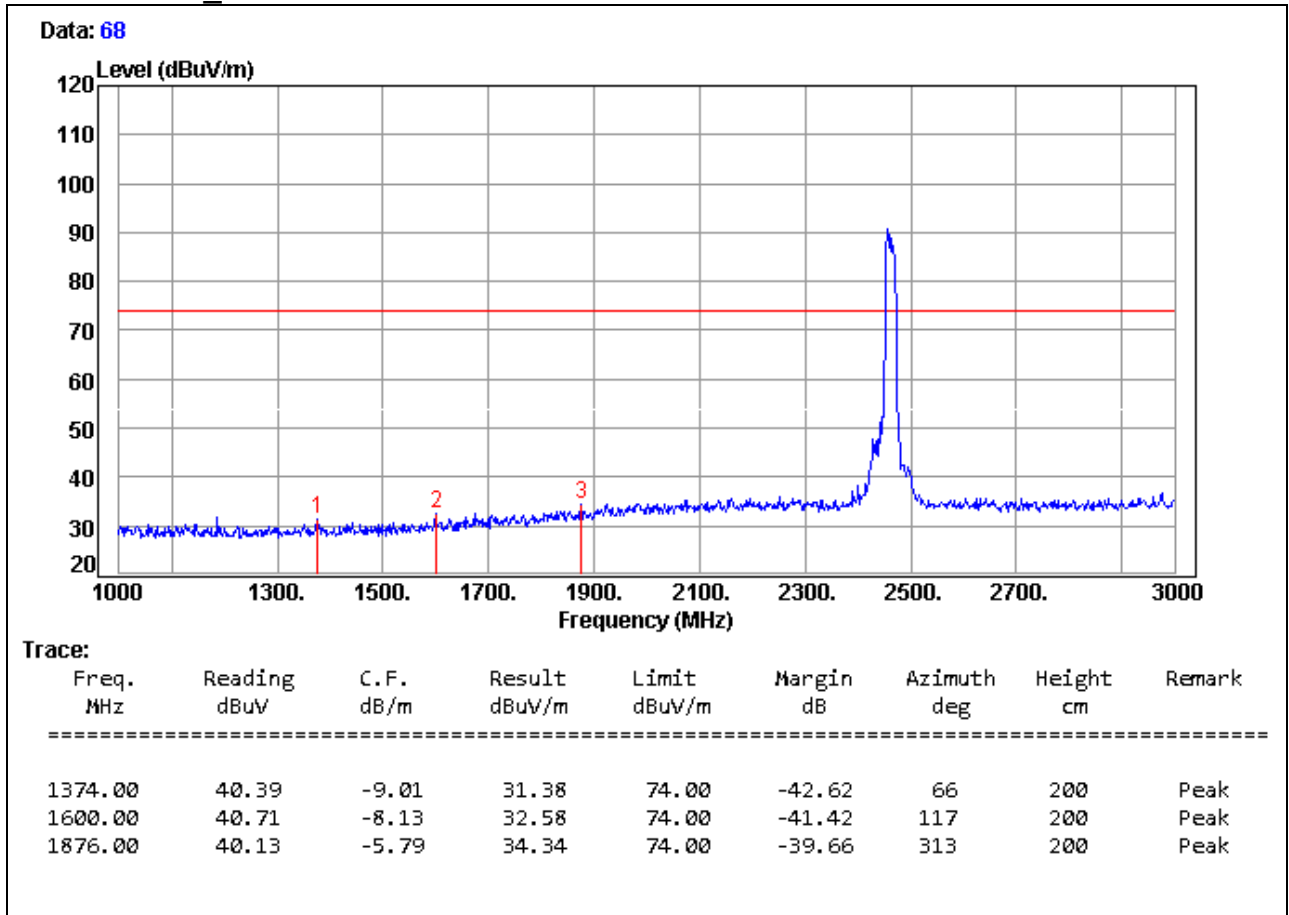

Remark:

1. Measuring frequencies from 1 GHz to the 10th harmonic of highest fundamental frequency.
2. Average test would be performed if the peak result were greater than the average limit.
3. Measurements above show only up to 6 maximum emissions noted, or would be lesser, with " N/A " remark, if no specific emissions from the EUT are recorded (ie: margin>20dB from the applicable limit) and considered that's already beyond the background noise floor.
4. Result = Reading + Correction Factor
 Margin = Result - Limit
 Remark Peak = Result(PK) - Limit(PK)
 Remark AVG = Result(AV) - Limit(AV)



Product Name	Dual-lines VDSL2/ADSL2+ Wireless-AC 3G/4G LTE VPN Firewall Router	Test By	Waternil Guan
Test Model	BiPAC 8920AX	Test Date	2015/05/14
Test Mode	IEEE 802.11g TX / CH High	Temp. & Humidity	25°C, 53%

966 Chamber_C at 3Meter / Horizontal

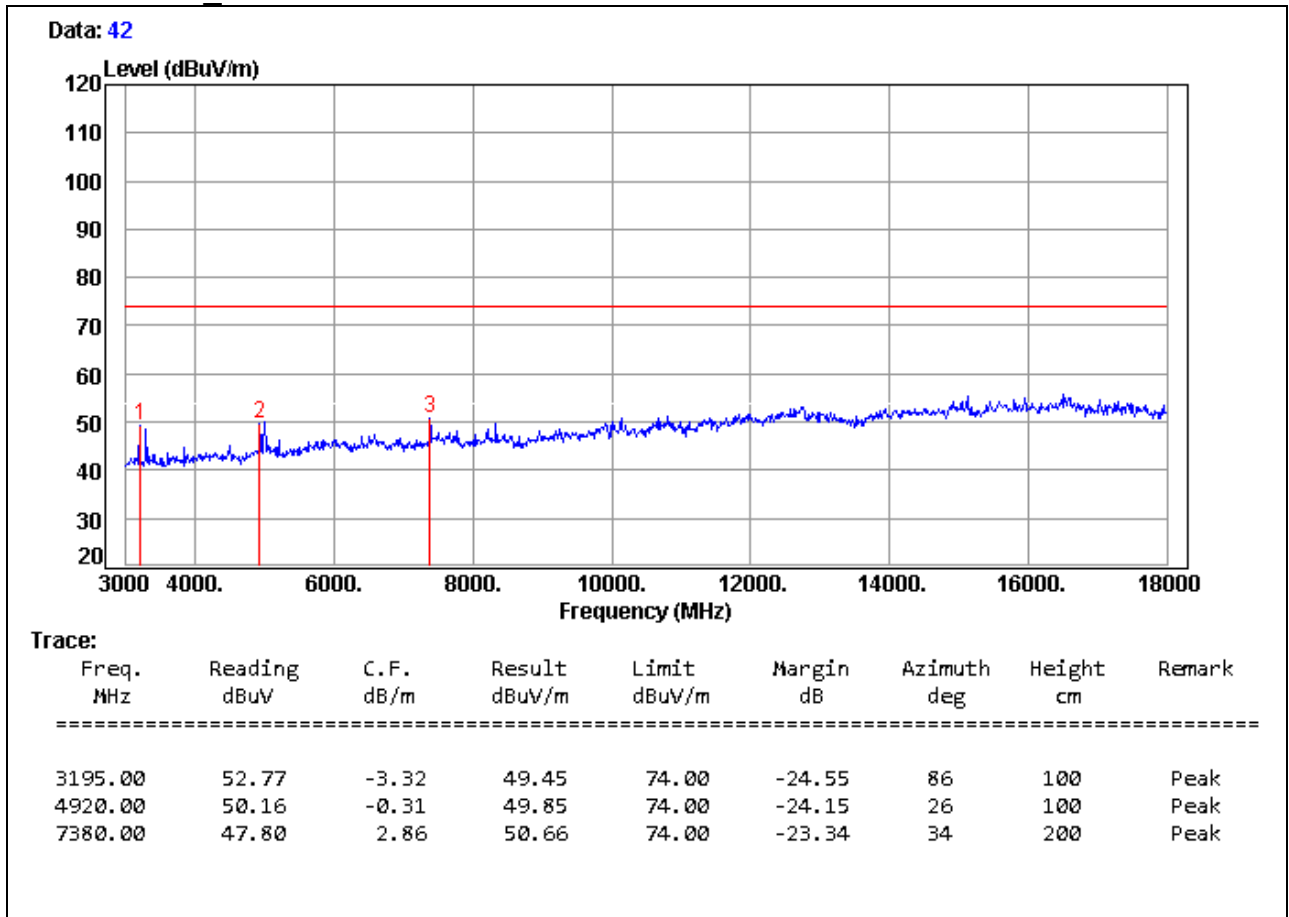

Remark:

1. Measuring frequencies from 1 GHz to the 10th harmonic of highest fundamental frequency.
2. Average test would be performed if the peak result were greater than the average limit.
3. Measurements above show only up to 6 maximum emissions noted, or would be lesser, with " N/A " remark, if no specific emissions from the EUT are recorded (ie: margin>20dB from the applicable limit) and considered that's already beyond the background noise floor.
4. Result = Reading + Correction Factor
Margin = Result - Limit
Remark Peak = Result(PK) - Limit(PK)
Remark AVG = Result(AV) - Limit(AV)
5. There is no emission in 18GHz ~ 26.5GHz.



Product Name	Dual-lines VDSL2/ADSL2+ Wireless-AC 3G/4G LTE VPN Firewall Router	Test By	Waternil Guan
Test Model	BiPAC 8920AX	Test Date	2015/05/14
Test Mode	IEEE 802.11g TX / CH High	Temp. & Humidity	25°C, 53%

966 Chamber_C at 3Meter / Vertical

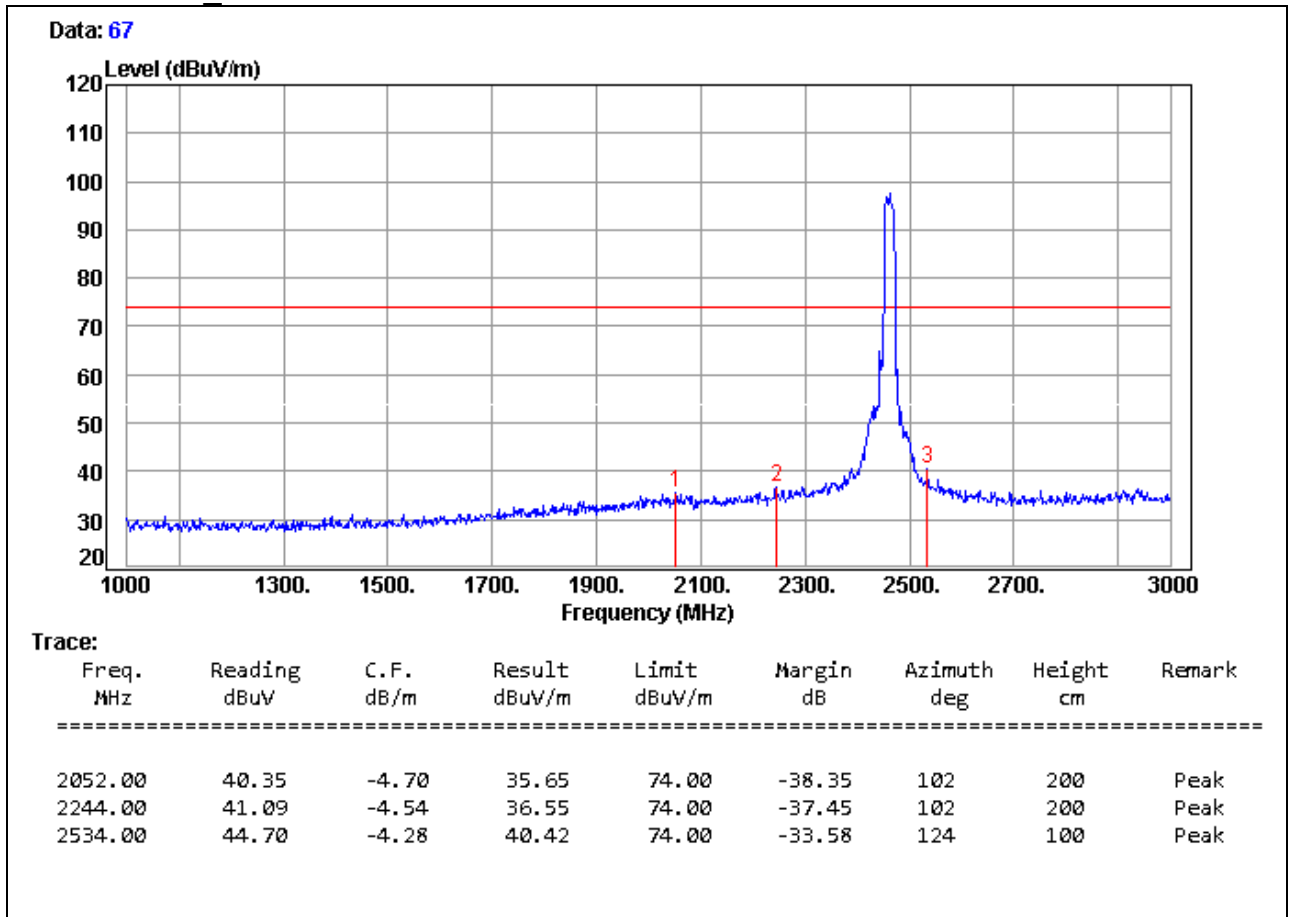

Remark:

1. Measuring frequencies from 1 GHz to the 10th harmonic of highest fundamental frequency.
2. Average test would be performed if the peak result were greater than the average limit.
3. Measurements above show only up to 6 maximum emissions noted, or would be lesser, with " N/A " remark, if no specific emissions from the EUT are recorded (ie: margin>20dB from the applicable limit) and considered that's already beyond the background noise floor.
4. Result = Reading + Correction Factor
 Margin = Result - Limit
 Remark Peak = Result(PK) - Limit(PK)
 Remark AVG = Result(AV) - Limit(AV)



Product Name	Dual-lines VDSL2/ADSL2+ Wireless-AC 3G/4G LTE VPN Firewall Router	Test By	Waternil Guan
Test Model	BiPAC 8920AX	Test Date	2015/05/14
Test Mode	IEEE 802.11g TX / CH High	Temp. & Humidity	25°C, 53%

966 Chamber_C at 3Meter / Vertical

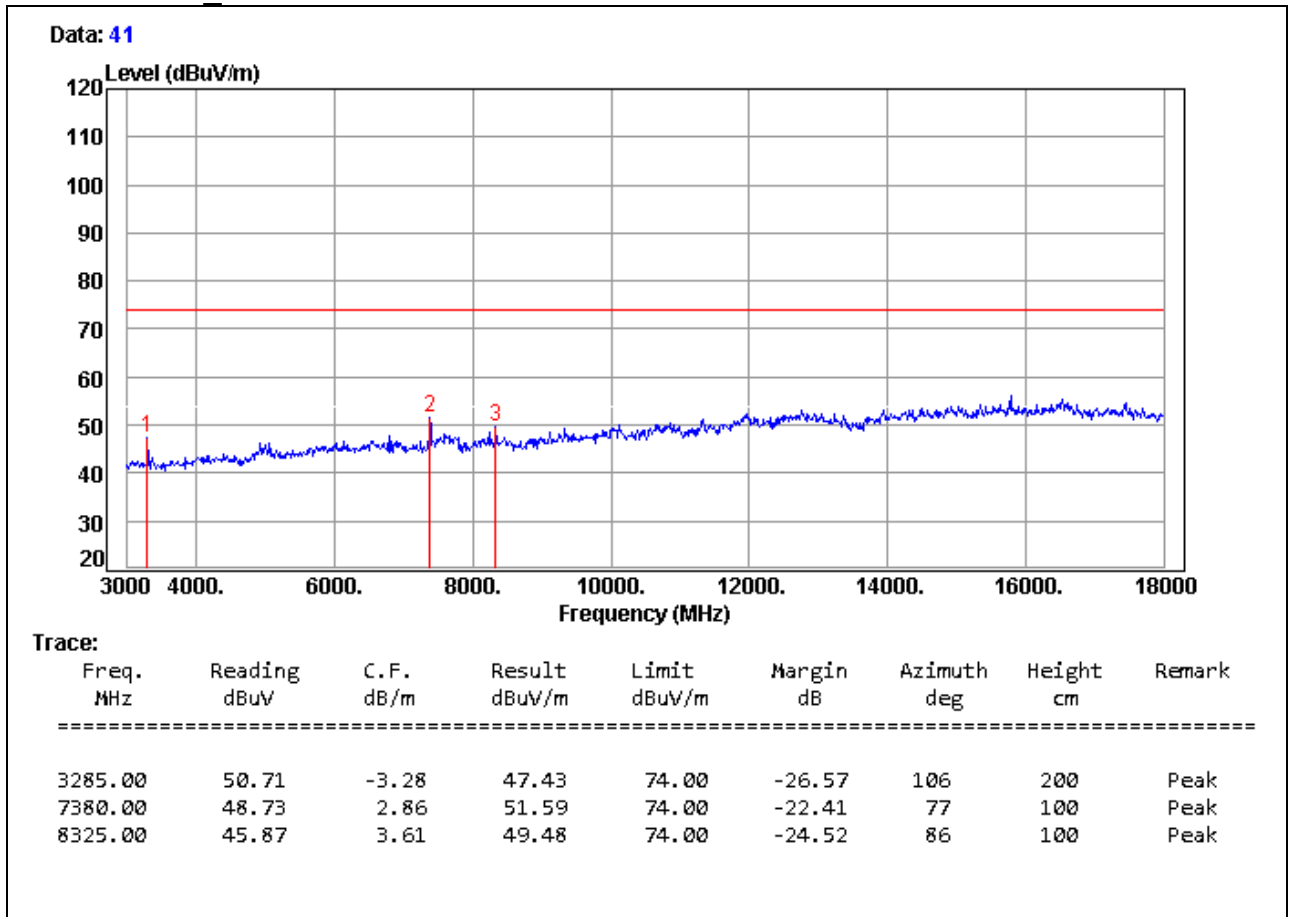

Remark:

1. Measuring frequencies from 1 GHz to the 10th harmonic of highest fundamental frequency.
2. Average test would be performed if the peak result were greater than the average limit.
3. Measurements above show only up to 6 maximum emissions noted, or would be lesser, with " N/A " remark, if no specific emissions from the EUT are recorded (ie: margin>20dB from the applicable limit) and considered that's already beyond the background noise floor.
4. Result = Reading + Correction Factor
Margin = Result - Limit
Remark Peak = Result(PK) - Limit(PK)
Remark AVG = Result(AV) - Limit(AV)
5. There is no emission in 18GHz ~ 26.5GHz.



Product Name	Dual-lines VDSL2/ADSL2+ Wireless-AC 3G/4G LTE VPN Firewall Router	Test By	Waternil Guan
Test Model	BiPAC 8920AX	Test Date	2015/05/14
Test Mode	IEEE 802.11gn HT20 TX / CH Low	Temp. & Humidity	25°C, 53%

966 Chamber_C at 3Meter / Horizontal

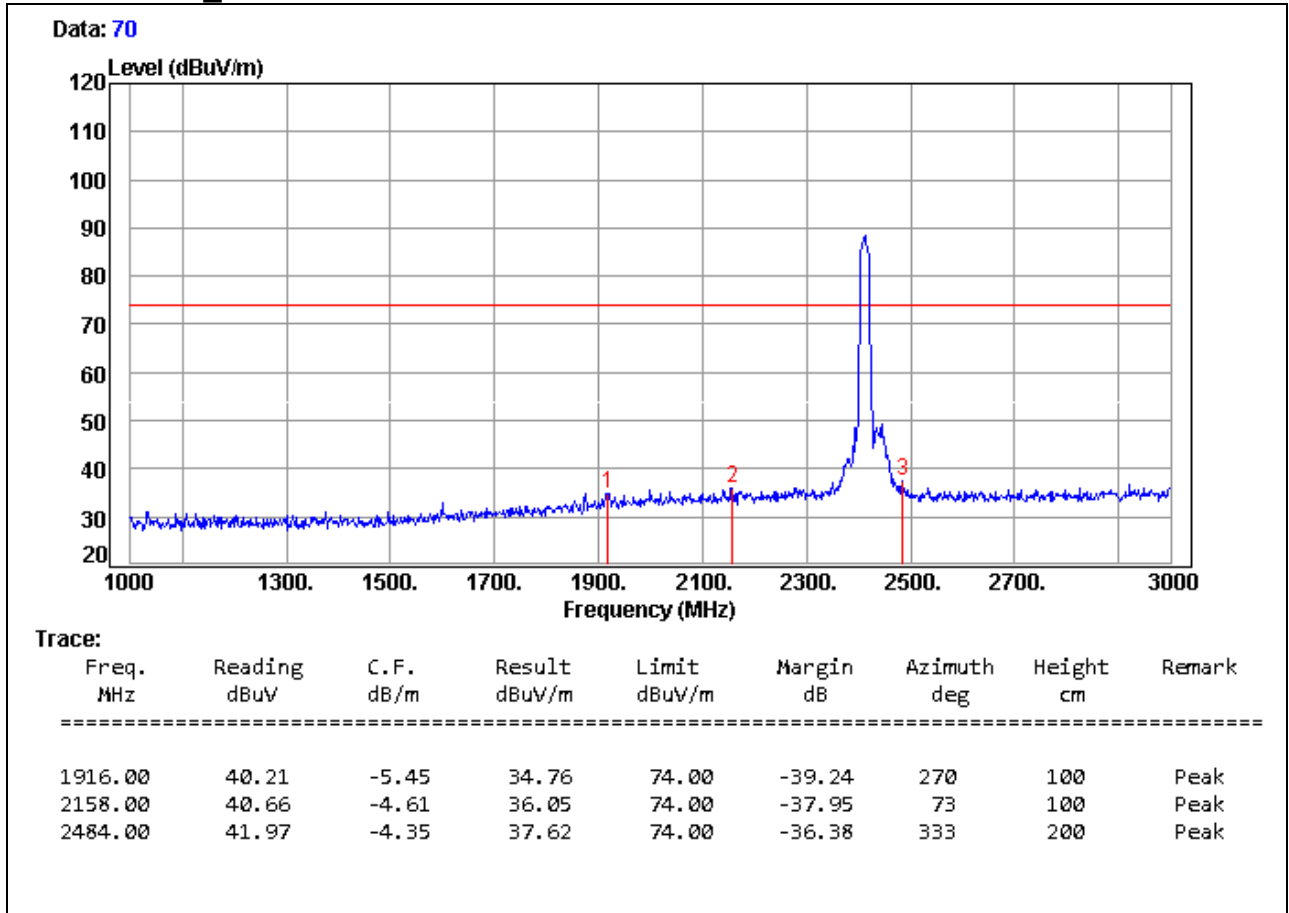

Remark:

1. Measuring frequencies from 1 GHz to the 10th harmonic of highest fundamental frequency.
2. Average test would be performed if the peak result were greater than the average limit.
3. Measurements above show only up to 6 maximum emissions noted, or would be lesser, with " N/A " remark, if no specific emissions from the EUT are recorded (ie: margin>20dB from the applicable limit) and considered that's already beyond the background noise floor.
4. Result = Reading + Correction Factor
Margin = Result - Limit
Remark Peak = Result(PK) - Limit(PK)
Remark AVG = Result(AV) - Limit(AV)



Product Name	Dual-lines VDSL2/ADSL2+ Wireless-AC 3G/4G LTE VPN Firewall Router	Test By	Waternil Guan
Test Model	BiPAC 8920AX	Test Date	2015/05/14
Test Mode	IEEE 802.11gn HT20 TX / CH Low	Temp. & Humidity	25°C, 53%

966 Chamber_C at 3Meter / Horizontal

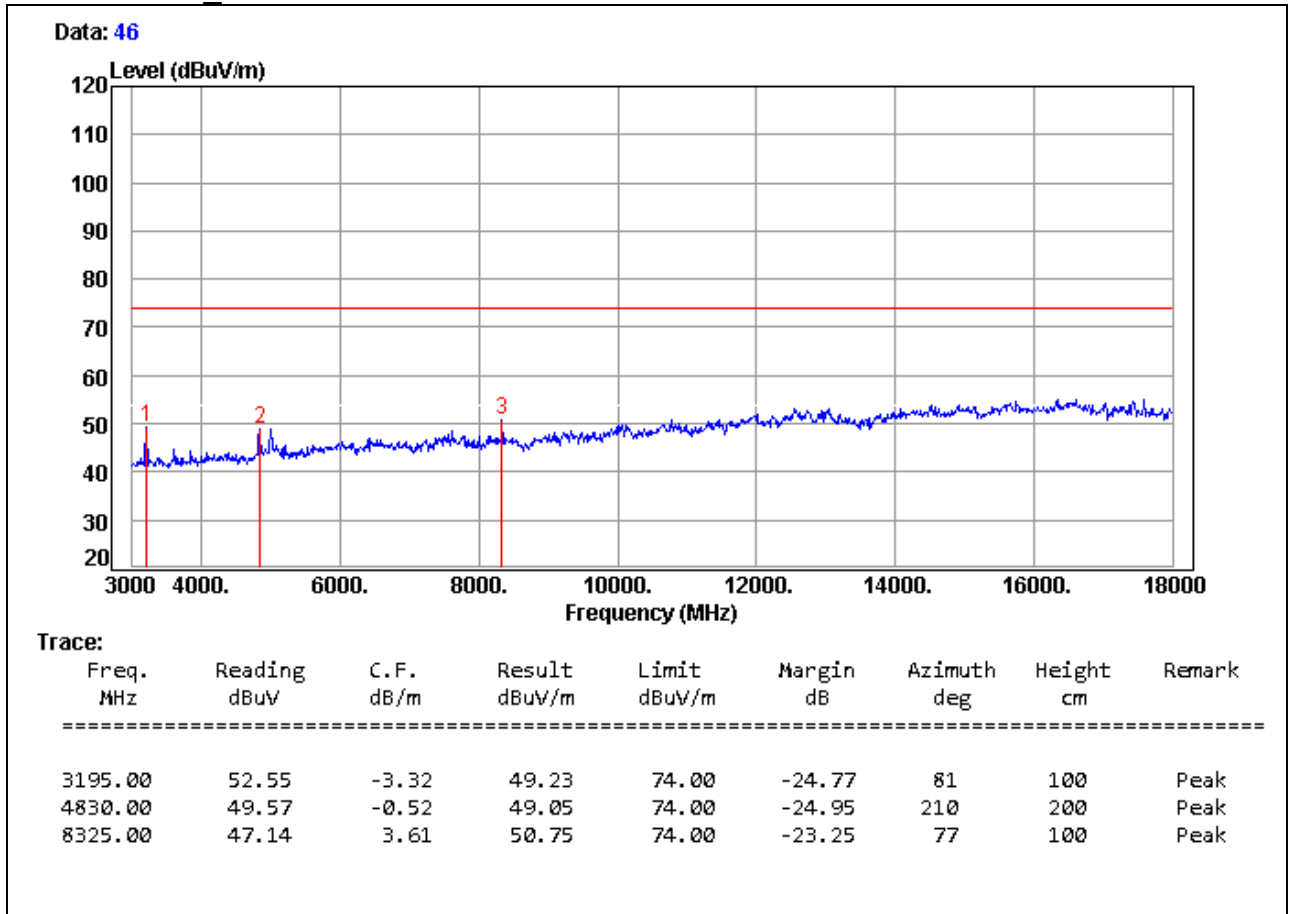

Remark:

1. Measuring frequencies from 1 GHz to the 10th harmonic of highest fundamental frequency.
2. Average test would be performed if the peak result were greater than the average limit.
3. Measurements above show only up to 6 maximum emissions noted, or would be lesser, with " N/A " remark, if no specific emissions from the EUT are recorded (ie: margin>20dB from the applicable limit) and considered that's already beyond the background noise floor.
4. Result = Reading + Correction Factor
Margin = Result - Limit
Remark Peak = Result(PK) - Limit(PK)
Remark AVG = Result(AV) - Limit(AV)
5. There is no emission in 18GHz ~ 26.5GHz.



Product Name	Dual-lines VDSL2/ADSL2+ Wireless-AC 3G/4G LTE VPN Firewall Router	Test By	Waternil Guan
Test Model	BiPAC 8920AX	Test Date	2015/05/14
Test Mode	IEEE 802.11gn HT20 TX / CH Low	Temp. & Humidity	25°C, 53%

966 Chamber_C at 3Meter / Vertical

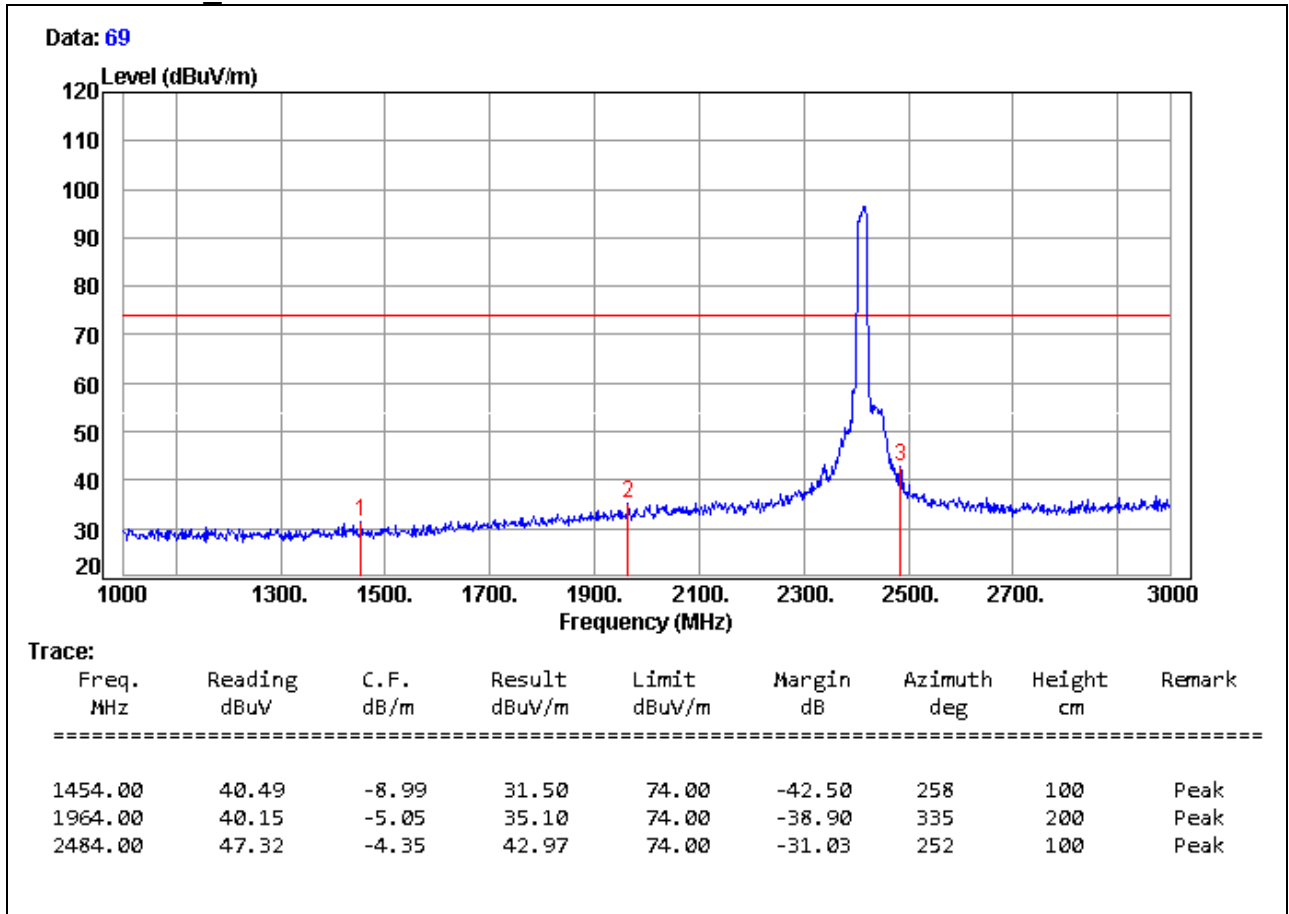

Remark:

1. Measuring frequencies from 1 GHz to the 10th harmonic of highest fundamental frequency.
2. Average test would be performed if the peak result were greater than the average limit.
3. Measurements above show only up to 6 maximum emissions noted, or would be lesser, with " N/A " remark, if no specific emissions from the EUT are recorded (ie: margin>20dB from the applicable limit) and considered that's already beyond the background noise floor.
4. Result = Reading + Correction Factor
Margin = Result - Limit
Remark Peak = Result(PK) - Limit(PK)
Remark AVG = Result(AV) - Limit(AV)



Product Name	Dual-lines VDSL2/ADSL2+ Wireless-AC 3G/4G LTE VPN Firewall Router	Test By	Waternil Guan
Test Model	BiPAC 8920AX	Test Date	2015/05/14
Test Mode	IEEE 802.11gn HT20 TX / CH Low	Temp. & Humidity	25°C, 53%

966 Chamber_C at 3Meter / Vertical

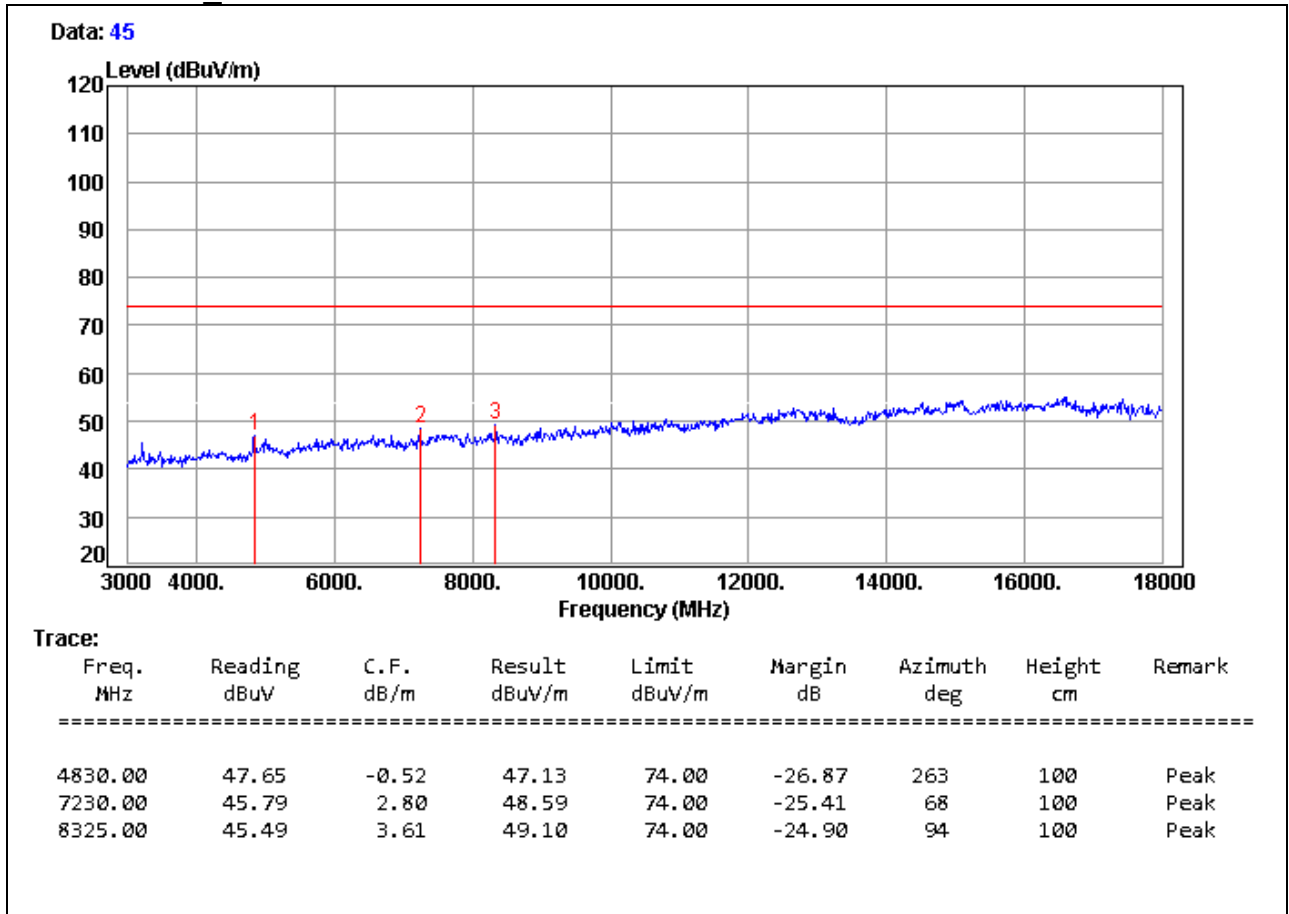

Remark:

1. Measuring frequencies from 1 GHz to the 10th harmonic of highest fundamental frequency.
2. Average test would be performed if the peak result were greater than the average limit.
3. Measurements above show only up to 6 maximum emissions noted, or would be lesser, with " N/A " remark, if no specific emissions from the EUT are recorded (ie: margin>20dB from the applicable limit) and considered that's already beyond the background noise floor.
4. Result = Reading + Correction Factor
Margin = Result - Limit
Remark Peak = Result(PK) - Limit(PK)
Remark AVG = Result(AV) - Limit(AV)
5. There is no emission in 18GHz ~ 26.5GHz.



Product Name	Dual-lines VDSL2/ADSL2+ Wireless-AC 3G/4G LTE VPN Firewall Router	Test By	Waternil Guan
Test Model	BiPAC 8920AX	Test Date	2015/05/14
Test Mode	IEEE 802.11gn HT20 TX / CH Middle	Temp. & Humidity	25°C, 53%

966 Chamber_C at 3Meter / Horizontal

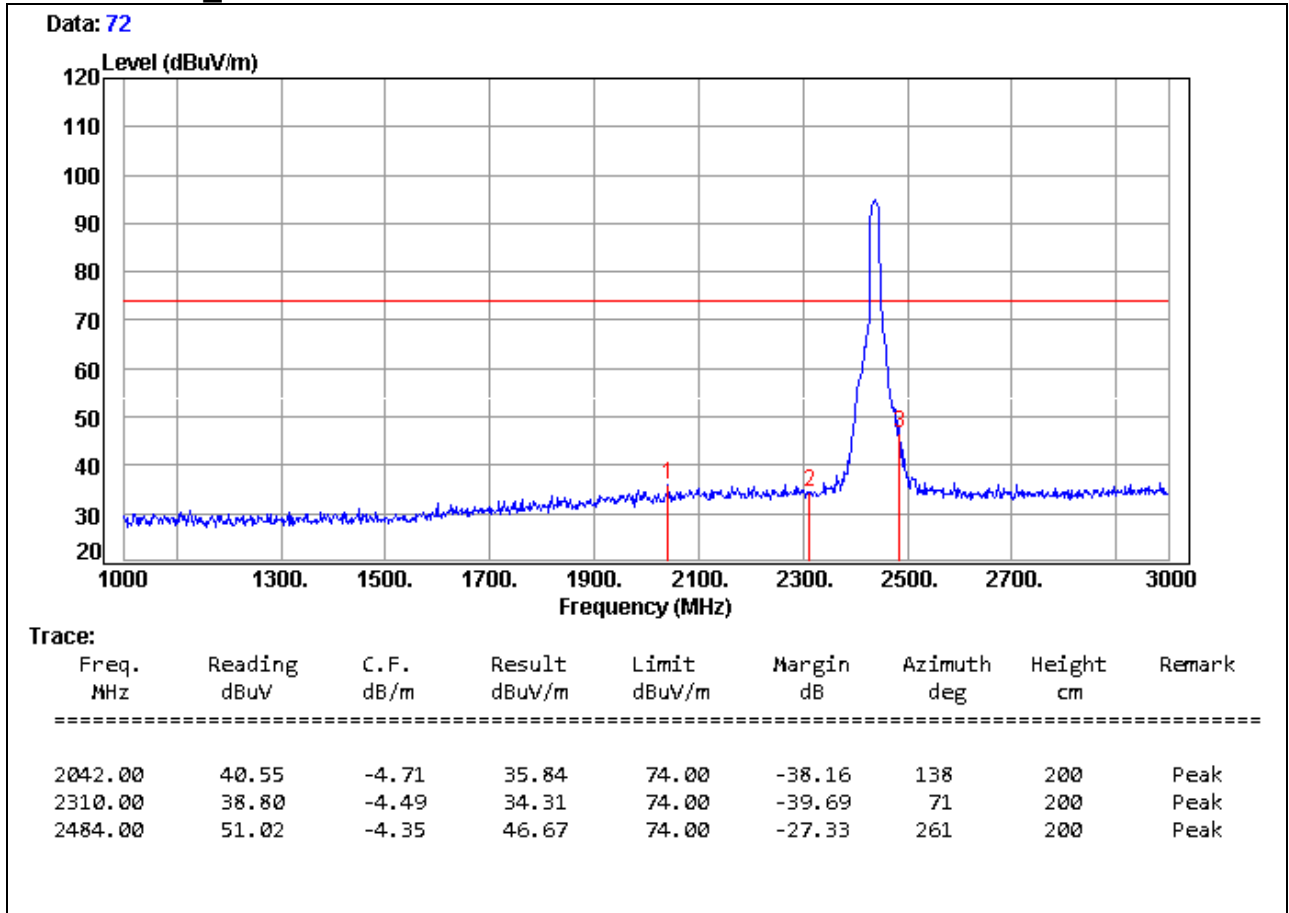

Remark:

1. Measuring frequencies from 1 GHz to the 10th harmonic of highest fundamental frequency.
2. Average test would be performed if the peak result were greater than the average limit.
3. Measurements above show only up to 6 maximum emissions noted, or would be lesser, with " N/A " remark, if no specific emissions from the EUT are recorded (ie: margin>20dB from the applicable limit) and considered that's already beyond the background noise floor.
4. Result = Reading + Correction Factor
 Margin = Result - Limit
 Remark Peak = Result(PK) - Limit(PK)
 Remark AVG = Result(AV) - Limit(AV)



Product Name	Dual-lines VDSL2/ADSL2+ Wireless-AC 3G/4G LTE VPN Firewall Router	Test By	Waternil Guan
Test Model	BiPAC 8920AX	Test Date	2015/05/14
Test Mode	IEEE 802.11gn HT20 TX / CH Middle	Temp. & Humidity	25°C, 53%

966 Chamber_C at 3Meter / Horizontal

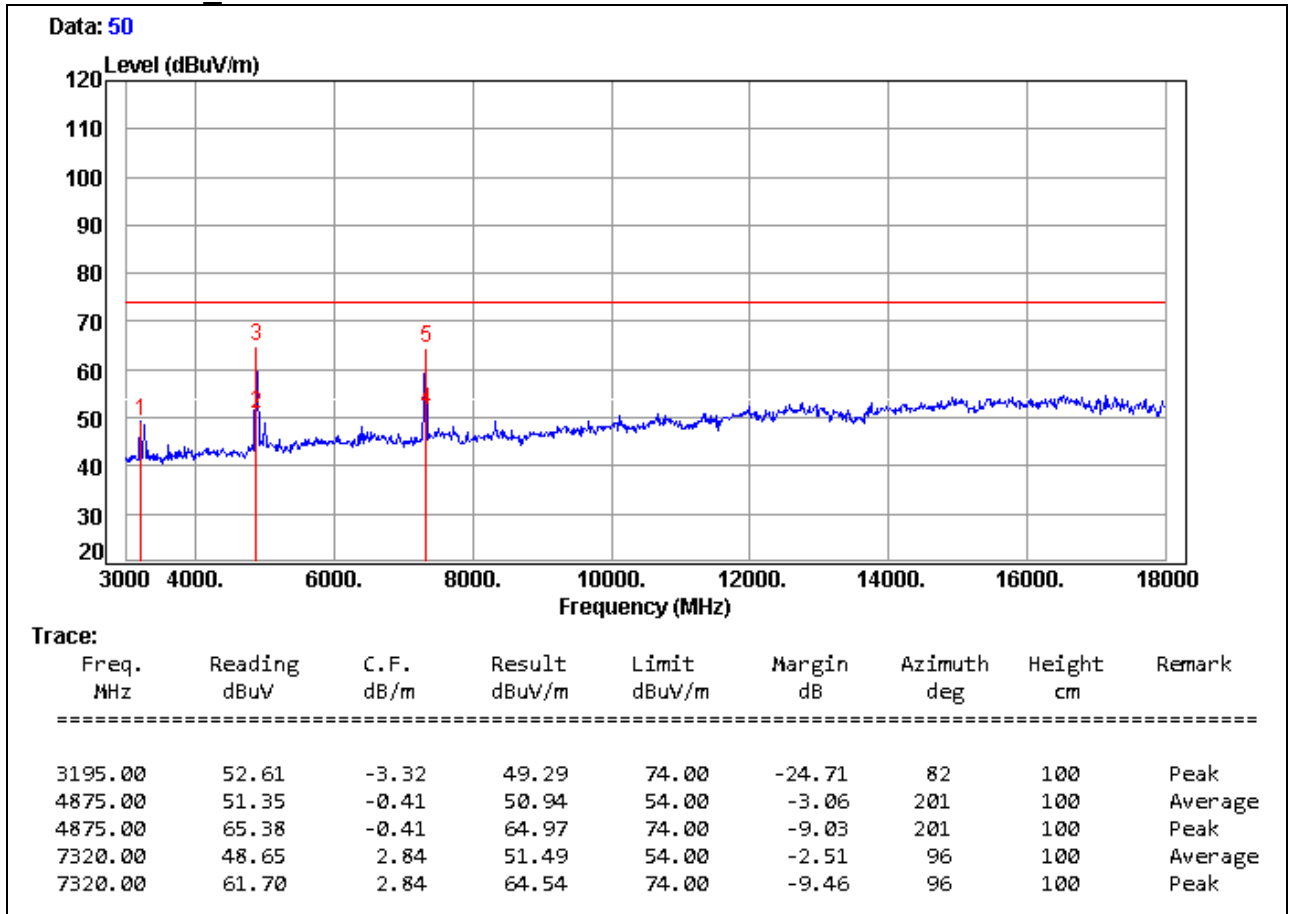

Remark:

1. Measuring frequencies from 1 GHz to the 10th harmonic of highest fundamental frequency.
2. Average test would be performed if the peak result were greater than the average limit.
3. Measurements above show only up to 6 maximum emissions noted, or would be lesser, with " N/A " remark, if no specific emissions from the EUT are recorded (ie: margin>20dB from the applicable limit) and considered that's already beyond the background noise floor.
4. Result = Reading + Correction Factor
Margin = Result - Limit
Remark Peak = Result(PK) - Limit(PK)
Remark AVG = Result(AV) - Limit(AV)
5. There is no emission in 18GHz ~ 26.5GHz.



Product Name	Dual-lines VDSL2/ADSL2+ Wireless-AC 3G/4G LTE VPN Firewall Router	Test By	Waternil Guan
Test Model	BiPAC 8920AX	Test Date	2015/05/14
Test Mode	IEEE 802.11gn HT20 TX / CH Middle	Temp. & Humidity	25°C, 53%

966 Chamber_C at 3Meter / Vertical

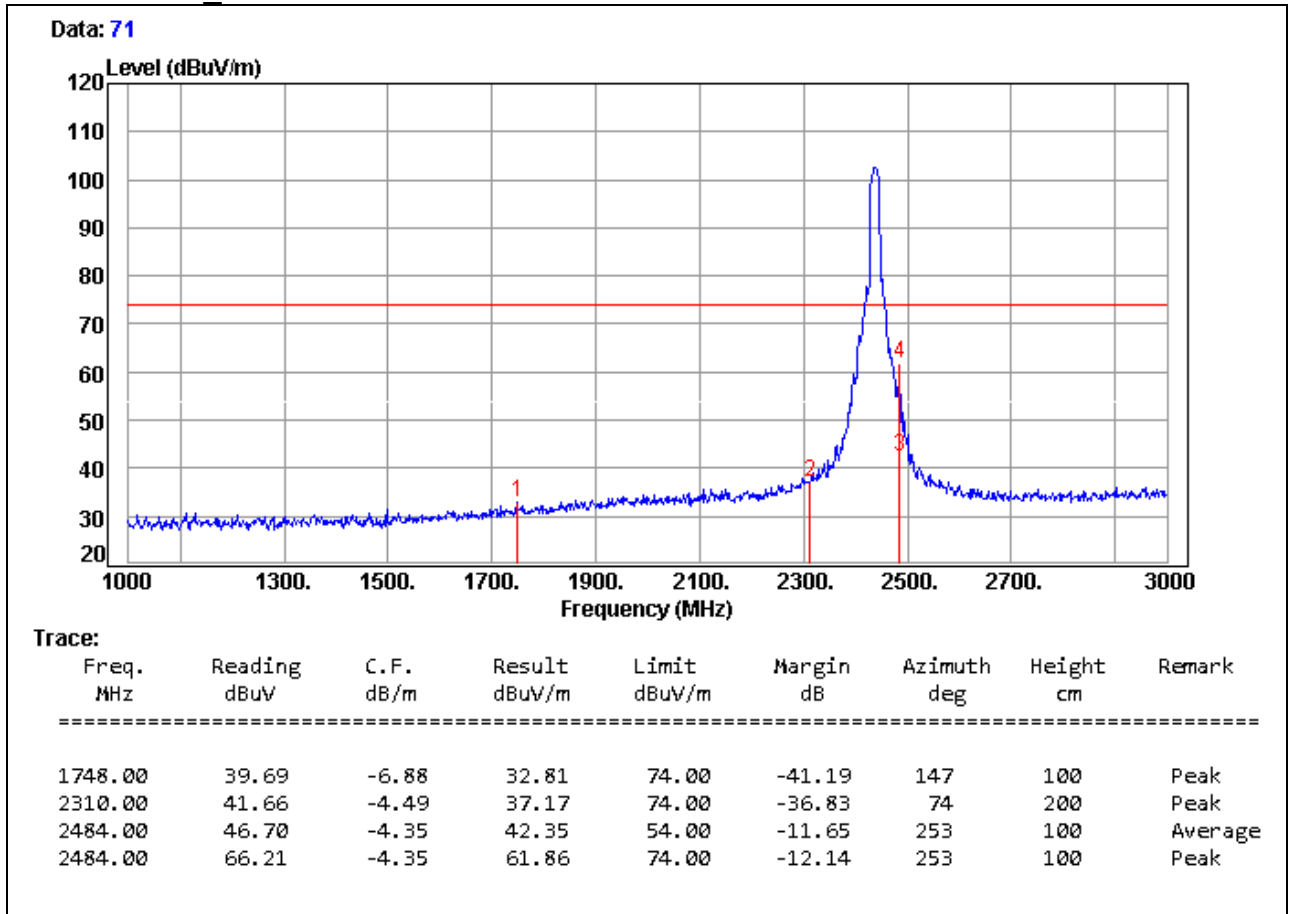

Remark:

1. Measuring frequencies from 1 GHz to the 10th harmonic of highest fundamental frequency.
2. Average test would be performed if the peak result were greater than the average limit.
3. Measurements above show only up to 6 maximum emissions noted, or would be lesser, with " N/A " remark, if no specific emissions from the EUT are recorded (ie: margin>20dB from the applicable limit) and considered that's already beyond the background noise floor.
4. Result = Reading + Correction Factor
Margin = Result - Limit
Remark Peak = Result(PK) - Limit(PK)
Remark AVG = Result(AV) - Limit(AV)



Product Name	Dual-lines VDSL2/ADSL2+ Wireless-AC 3G/4G LTE VPN Firewall Router	Test By	Waternil Guan
Test Model	BiPAC 8920AX	Test Date	2015/05/14
Test Mode	IEEE 802.11gn HT20 TX / CH Middle	Temp. & Humidity	25°C, 53%

966 Chamber_C at 3Meter / Vertical

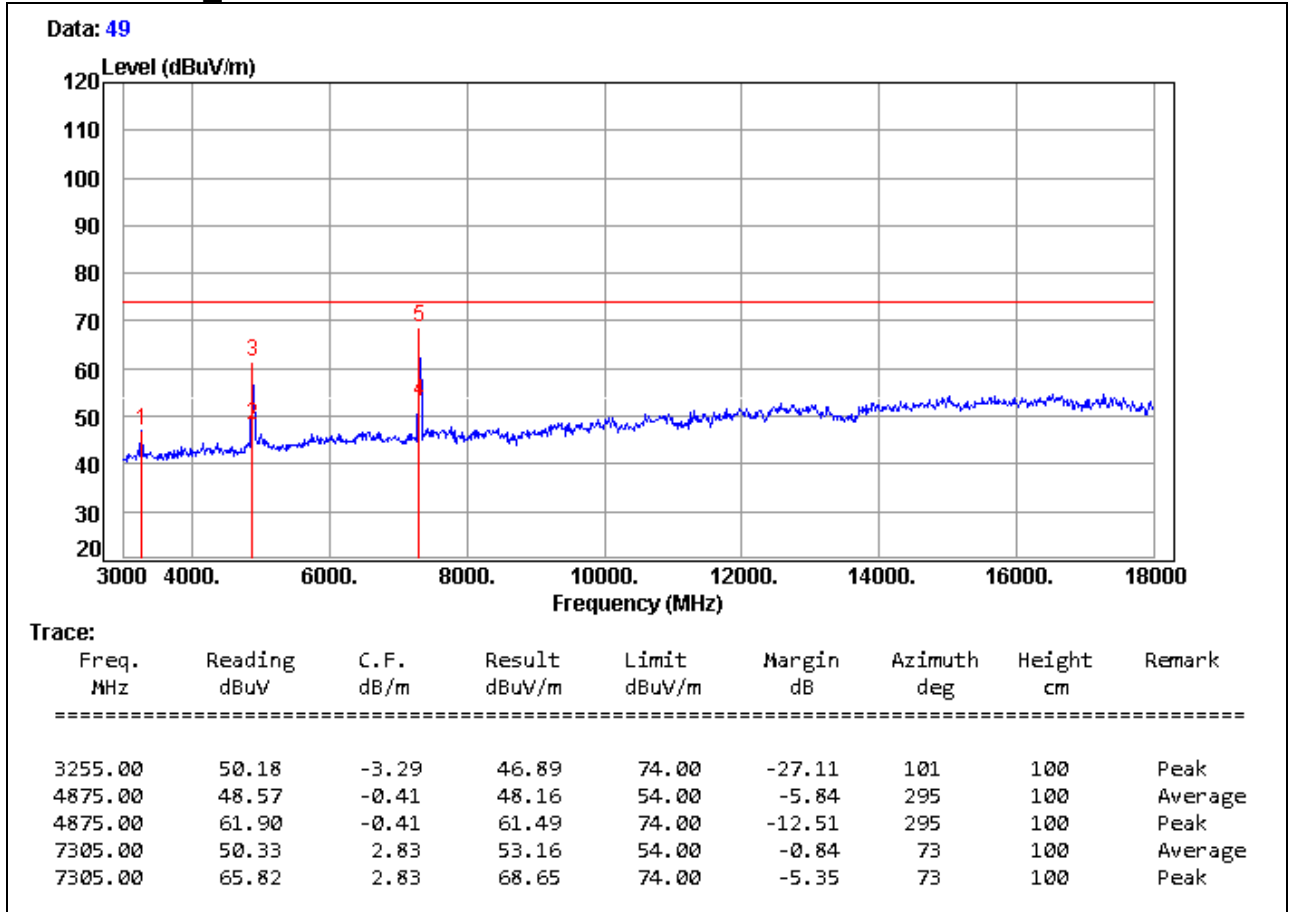

Remark:

1. Measuring frequencies from 1 GHz to the 10th harmonic of highest fundamental frequency.
2. Average test would be performed if the peak result were greater than the average limit.
3. Measurements above show only up to 6 maximum emissions noted, or would be lesser, with " N/A " remark, if no specific emissions from the EUT are recorded (ie: margin>20dB from the applicable limit) and considered that's already beyond the background noise floor.
4. Result = Reading + Correction Factor
Margin = Result - Limit
Remark Peak = Result(PK) - Limit(PK)
Remark AVG = Result(AV) - Limit(AV)
5. There is no emission in 18GHz ~ 26.5GHz.



Product Name	Dual-lines VDSL2/ADSL2+ Wireless-AC 3G/4G LTE VPN Firewall Router	Test By	Waternil Guan
Test Model	BiPAC 8920AX	Test Date	2015/05/14
Test Mode	IEEE 802.11gn HT20 TX / CH High	Temp. & Humidity	25°C, 53%

966 Chamber_C at 3Meter / Horizontal

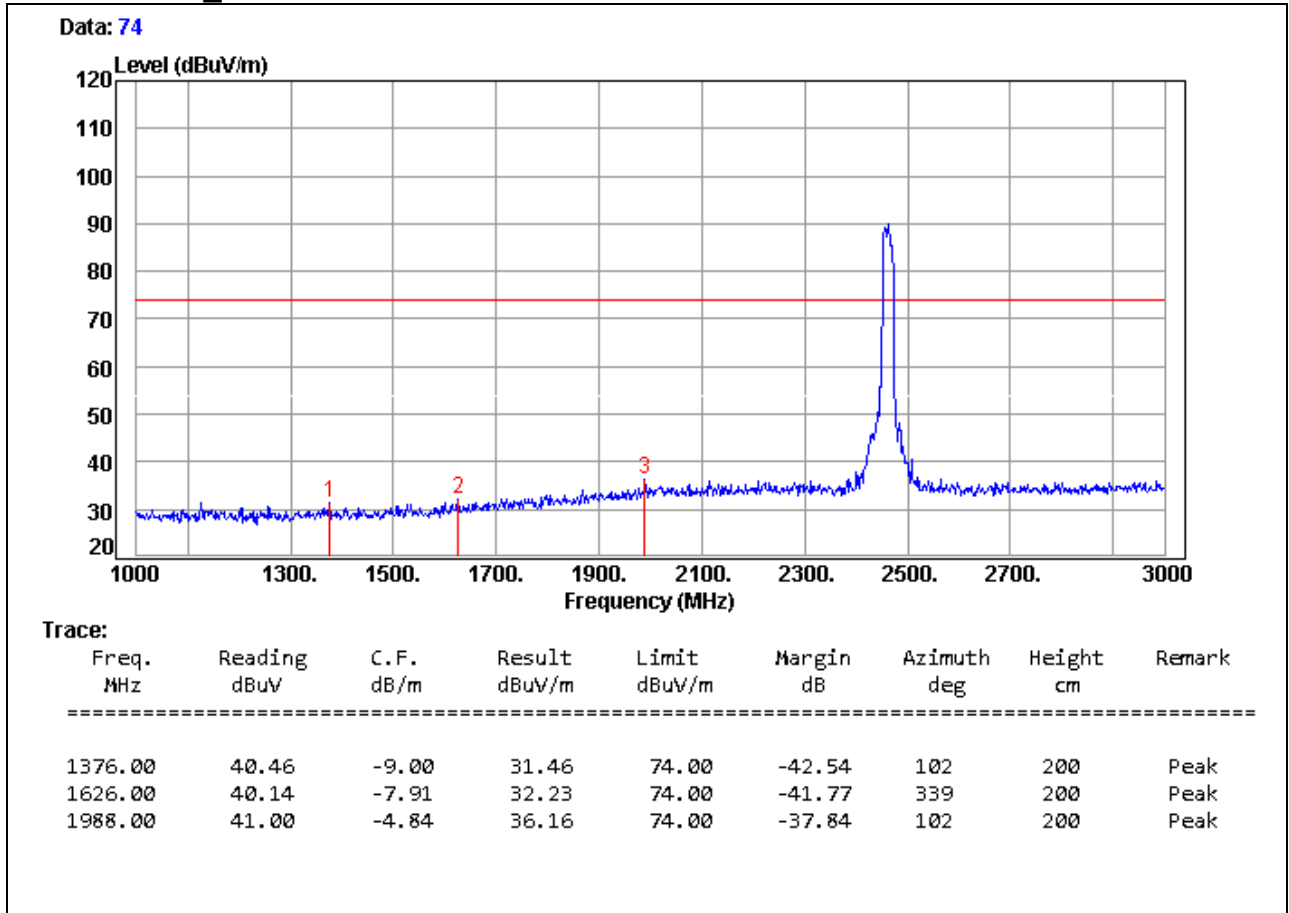

Remark:

1. Measuring frequencies from 1 GHz to the 10th harmonic of highest fundamental frequency.
2. Average test would be performed if the peak result were greater than the average limit.
3. Measurements above show only up to 6 maximum emissions noted, or would be lesser, with " N/A " remark, if no specific emissions from the EUT are recorded (ie: margin>20dB from the applicable limit) and considered that's already beyond the background noise floor.
4. Result = Reading + Correction Factor
Margin = Result - Limit
Remark Peak = Result(PK) - Limit(PK)
Remark AVG = Result(AV) - Limit(AV)



Product Name	Dual-lines VDSL2/ADSL2+ Wireless-AC 3G/4G LTE VPN Firewall Router	Test By	Waternil Guan
Test Model	BiPAC 8920AX	Test Date	2015/05/14
Test Mode	IEEE 802.11gn HT20 TX / CH High	Temp. & Humidity	25°C, 53%

966 Chamber_C at 3Meter / Horizontal

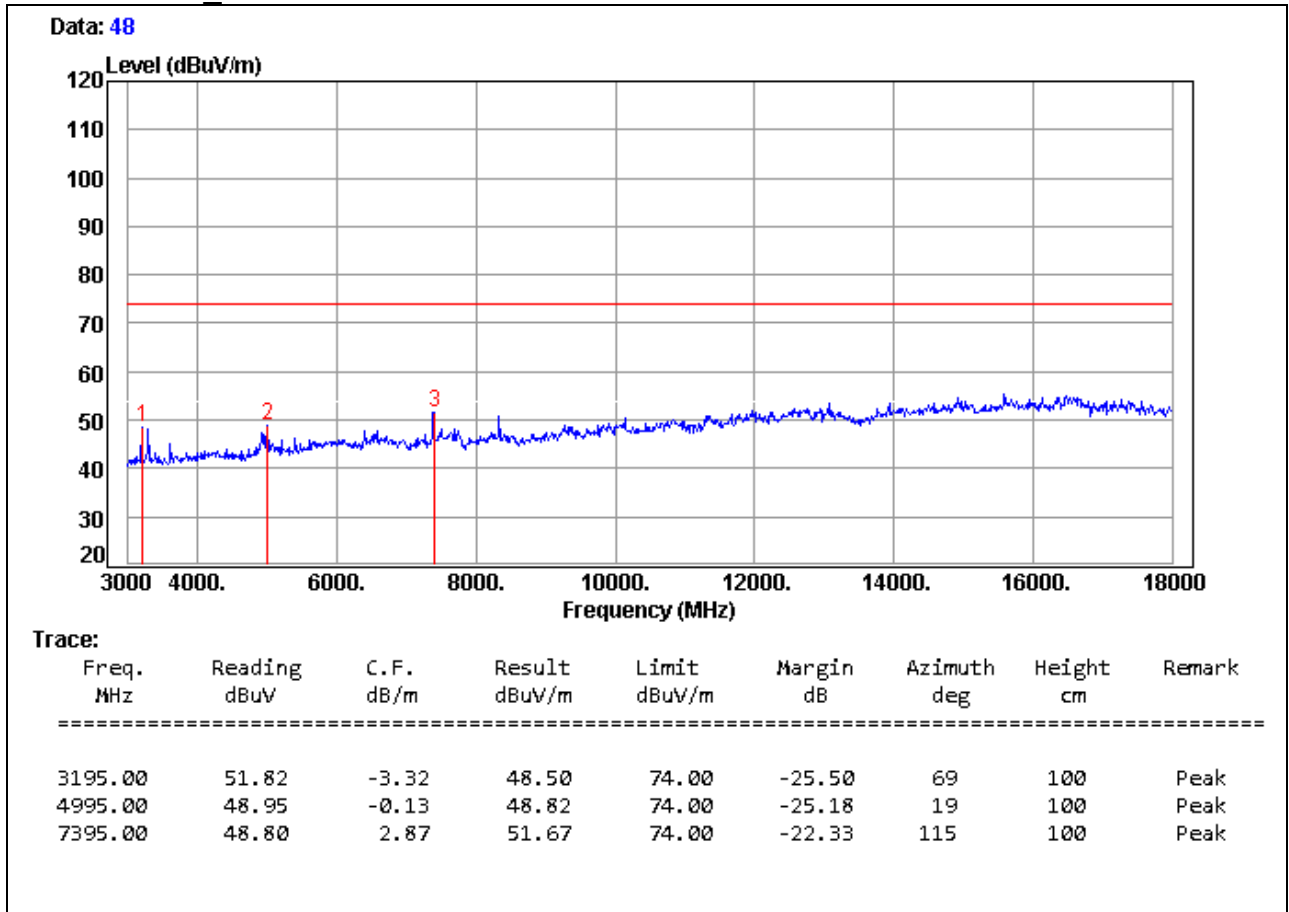

Remark:

1. Measuring frequencies from 1 GHz to the 10th harmonic of highest fundamental frequency.
2. Average test would be performed if the peak result were greater than the average limit.
3. Measurements above show only up to 6 maximum emissions noted, or would be lesser, with " N/A " remark, if no specific emissions from the EUT are recorded (ie: margin>20dB from the applicable limit) and considered that's already beyond the background noise floor.
4. Result = Reading + Correction Factor
Margin = Result - Limit
Remark Peak = Result(PK) - Limit(PK)
Remark AVG = Result(AV) - Limit(AV)
5. There is no emission in 18GHz ~ 26.5GHz.



Product Name	Dual-lines VDSL2/ADSL2+ Wireless-AC 3G/4G LTE VPN Firewall Router	Test By	Waternil Guan
Test Model	BiPAC 8920AX	Test Date	2015/05/14
Test Mode	IEEE 802.11gn HT20 TX / CH High	Temp. & Humidity	25°C, 53%

966 Chamber_C at 3Meter / Vertical

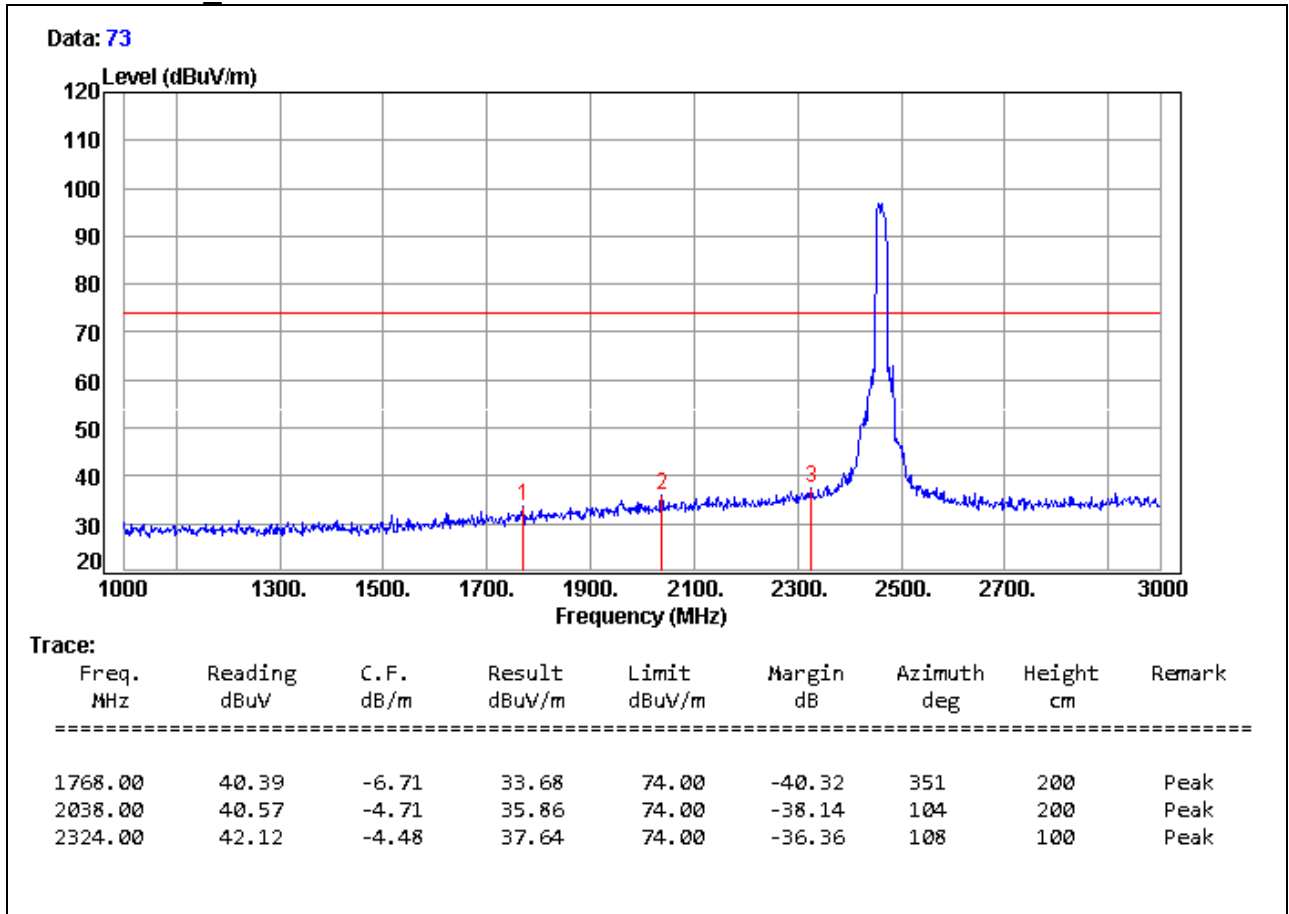

Remark:

1. Measuring frequencies from 1 GHz to the 10th harmonic of highest fundamental frequency.
2. Average test would be performed if the peak result were greater than the average limit.
3. Measurements above show only up to 6 maximum emissions noted, or would be lesser, with " N/A " remark, if no specific emissions from the EUT are recorded (ie: margin>20dB from the applicable limit) and considered that's already beyond the background noise floor.
4. Result = Reading + Correction Factor
Margin = Result - Limit
Remark Peak = Result(PK) - Limit(PK)
Remark AVG = Result(AV) - Limit(AV)



Product Name	Dual-lines VDSL2/ADSL2+ Wireless-AC 3G/4G LTE VPN Firewall Router	Test By	Waternil Guan
Test Model	BiPAC 8920AX	Test Date	2015/05/14
Test Mode	IEEE 802.11gn HT20 TX / CH High	Temp. & Humidity	25°C, 53%

966 Chamber_C at 3Meter / Vertical

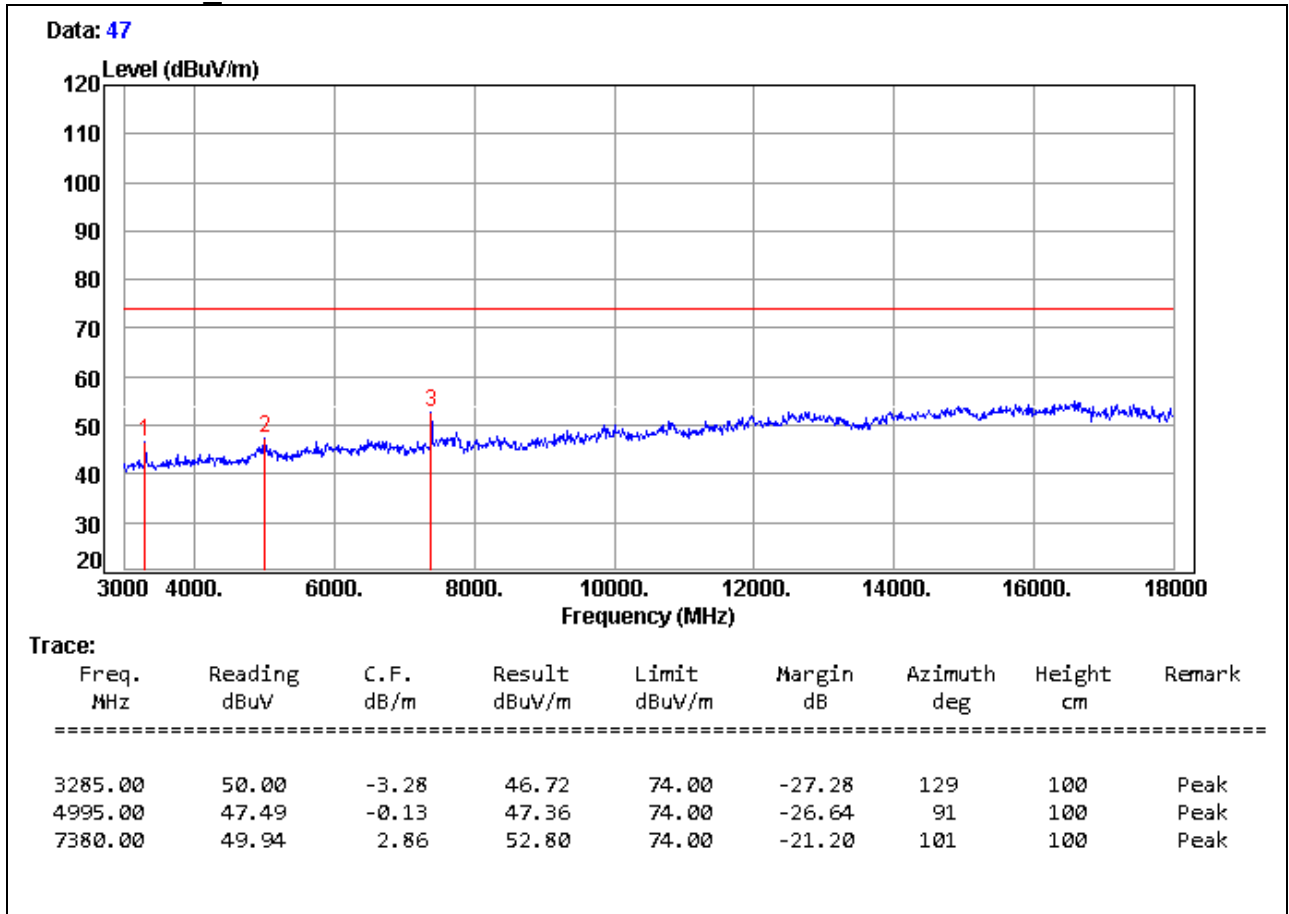

Remark:

1. Measuring frequencies from 1 GHz to the 10th harmonic of highest fundamental frequency.
2. Average test would be performed if the peak result were greater than the average limit.
3. Measurements above show only up to 6 maximum emissions noted, or would be lesser, with " N/A " remark, if no specific emissions from the EUT are recorded (ie: margin>20dB from the applicable limit) and considered that's already beyond the background noise floor.
4. Result = Reading + Correction Factor
Margin = Result - Limit
Remark Peak = Result(PK) - Limit(PK)
Remark AVG = Result(AV) - Limit(AV)
5. There is no emission in 18GHz ~ 26.5GHz.



Product Name	Dual-lines VDSL2/ADSL2+ Wireless-AC 3G/4G LTE VPN Firewall Router	Test By	Waternil Guan
Test Model	BiPAC 8920AX	Test Date	2015/05/15
Test Mode	IEEE 802.11gn HT40 TX / CH Low	Temp. & Humidity	25°C, 53%

966 Chamber_C at 3Meter / Horizontal

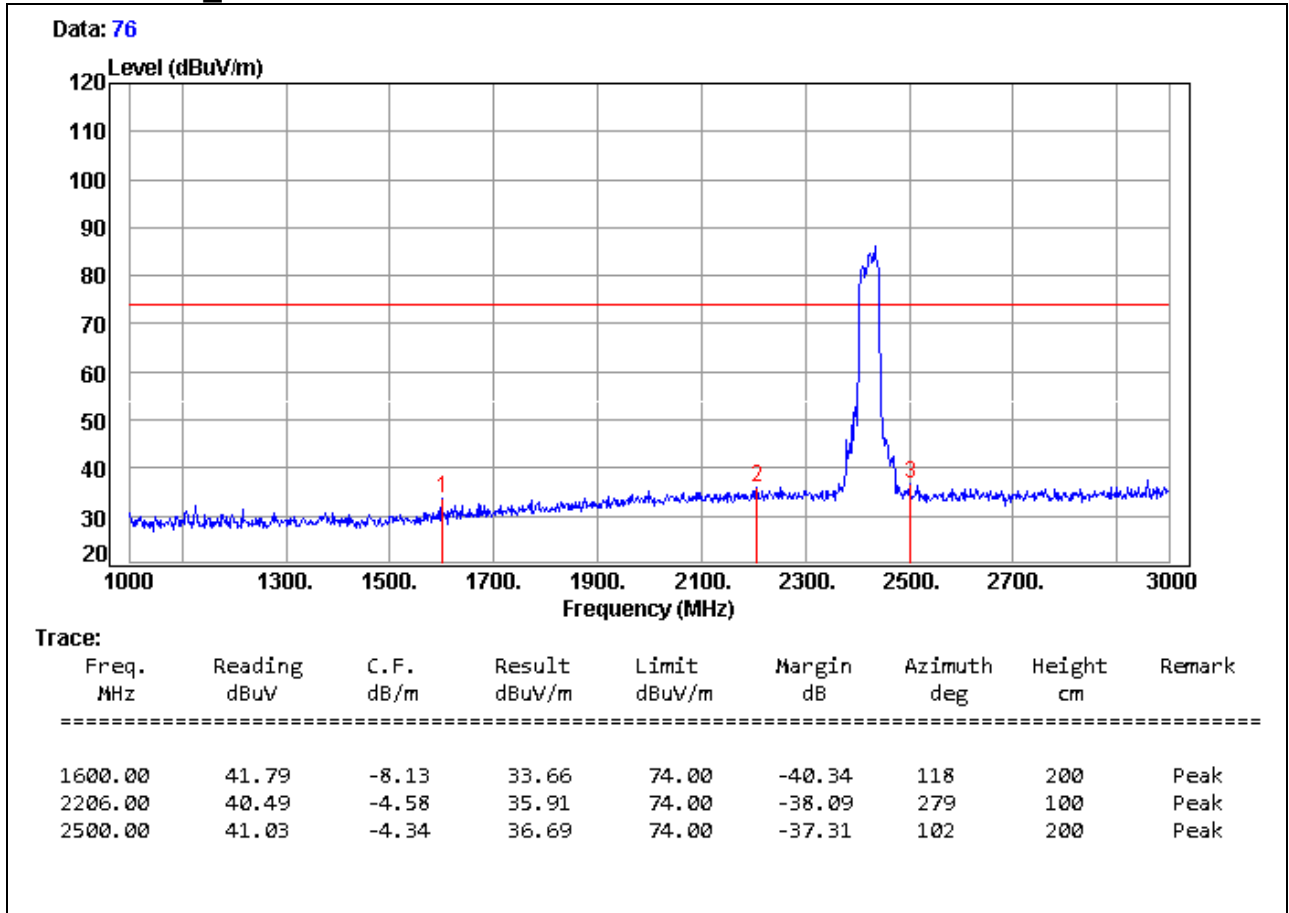

Remark:

1. Measuring frequencies from 1 GHz to the 10th harmonic of highest fundamental frequency.
2. Average test would be performed if the peak result were greater than the average limit.
3. Measurements above show only up to 6 maximum emissions noted, or would be lesser, with " N/A " remark, if no specific emissions from the EUT are recorded (ie: margin>20dB from the applicable limit) and considered that's already beyond the background noise floor.
4. Result = Reading + Correction Factor
Margin = Result - Limit
Remark Peak = Result(PK) - Limit(PK)
Remark AVG = Result(AV) - Limit(AV)



Product Name	Dual-lines VDSL2/ADSL2+ Wireless-AC 3G/4G LTE VPN Firewall Router	Test By	Waternil Guan
Test Model	BiPAC 8920AX	Test Date	2015/05/14
Test Mode	IEEE 802.11gn HT40 TX / CH Low	Temp. & Humidity	25°C, 53%

966 Chamber_C at 3Meter / Horizontal

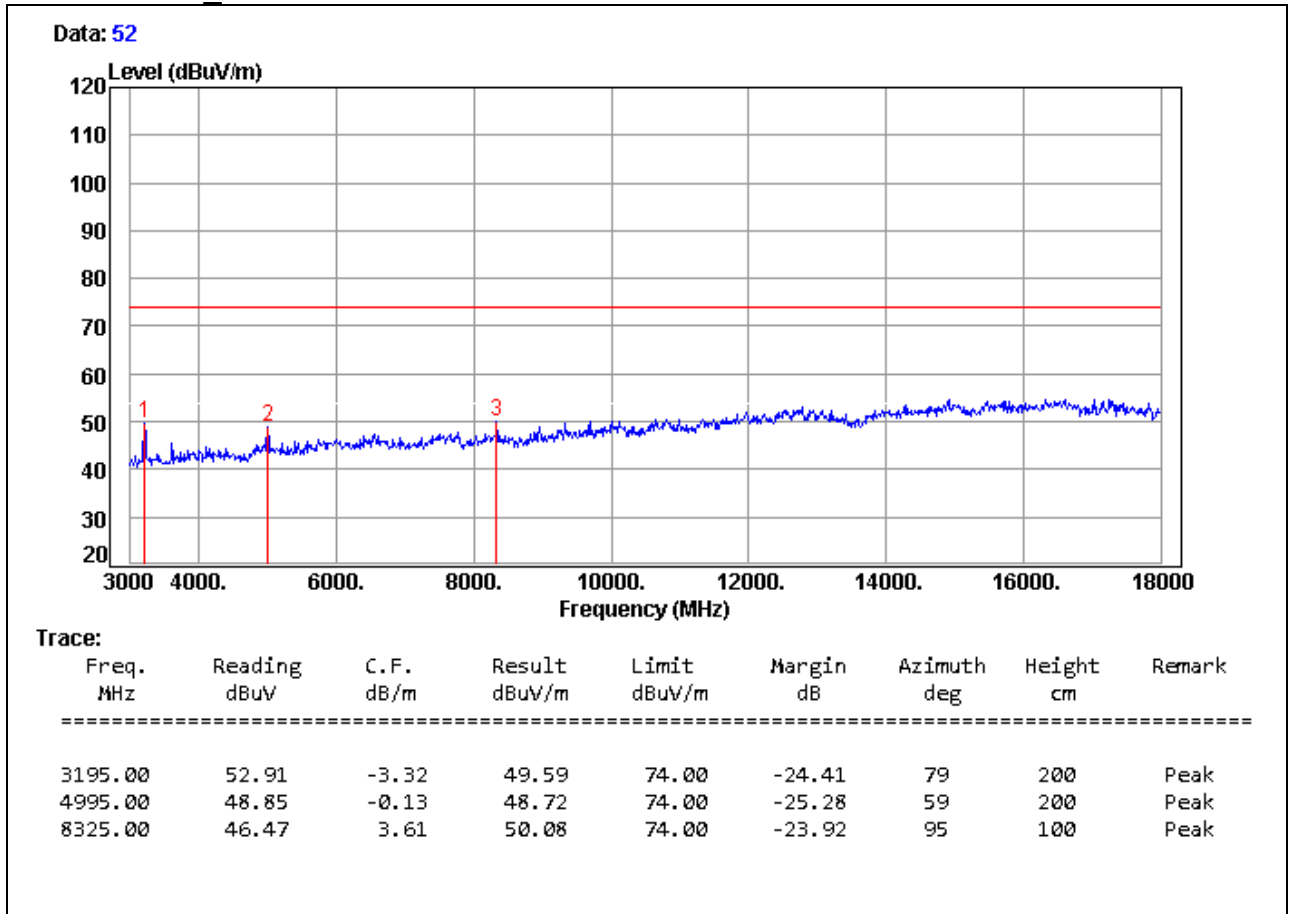

Remark:

1. Measuring frequencies from 1 GHz to the 10th harmonic of highest fundamental frequency.
2. Average test would be performed if the peak result were greater than the average limit.
3. Measurements above show only up to 6 maximum emissions noted, or would be lesser, with " N/A " remark, if no specific emissions from the EUT are recorded (ie: margin>20dB from the applicable limit) and considered that's already beyond the background noise floor.
4. Result = Reading + Correction Factor
Margin = Result - Limit
Remark Peak = Result(PK) - Limit(PK)
Remark AVG = Result(AV) - Limit(AV)
5. There is no emission in 18GHz ~ 26.5GHz.



Product Name	Dual-lines VDSL2/ADSL2+ Wireless-AC 3G/4G LTE VPN Firewall Router	Test By	Waternil Guan
Test Model	BiPAC 8920AX	Test Date	2015/05/15
Test Mode	IEEE 802.11gn HT40 TX / CH Low	Temp. & Humidity	25°C, 53%

966 Chamber_C at 3Meter / Vertical

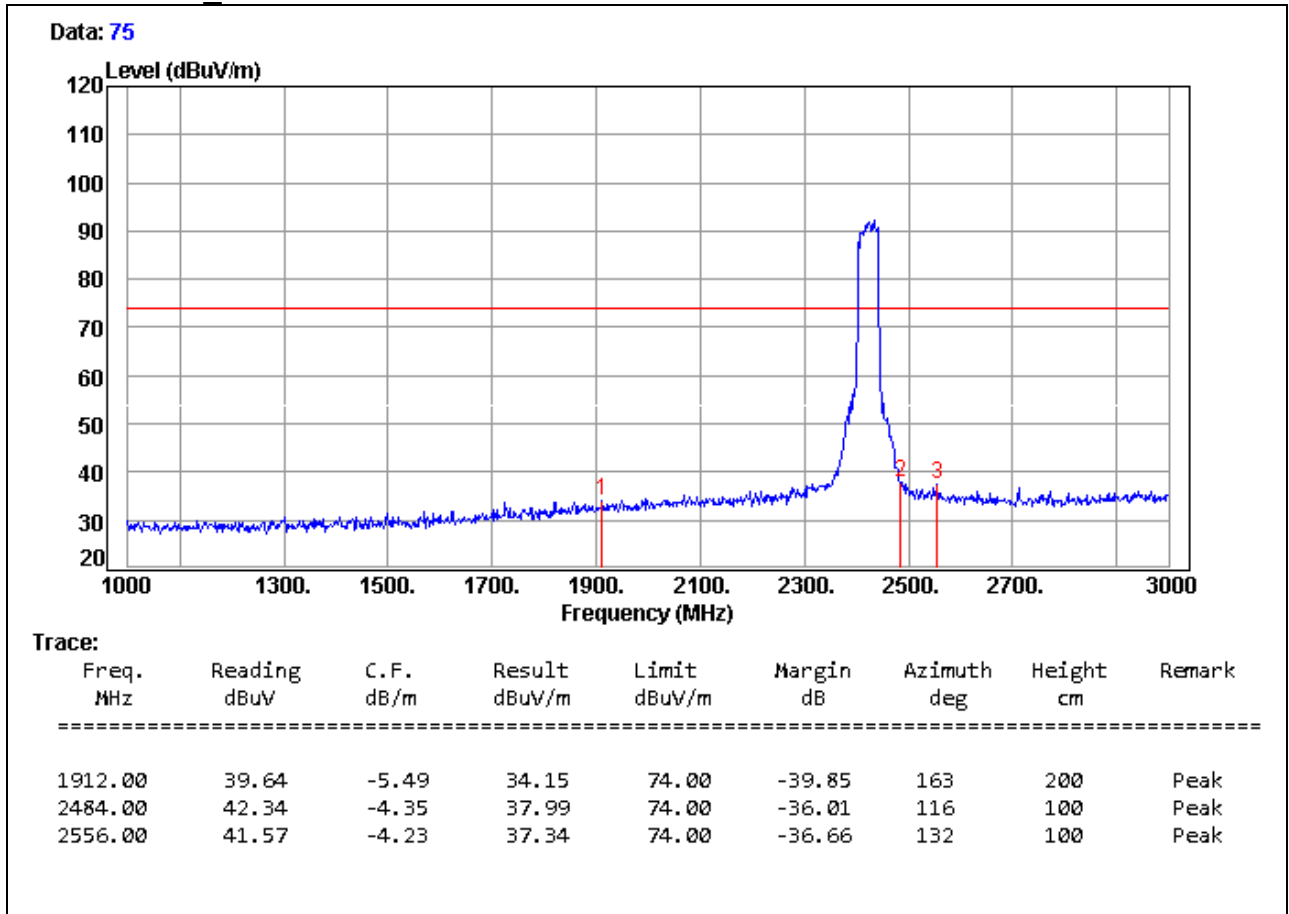

Remark:

1. Measuring frequencies from 1 GHz to the 10th harmonic of highest fundamental frequency.
2. Average test would be performed if the peak result were greater than the average limit.
3. Measurements above show only up to 6 maximum emissions noted, or would be lesser, with " N/A " remark, if no specific emissions from the EUT are recorded (ie: margin>20dB from the applicable limit) and considered that's already beyond the background noise floor.
4. Result = Reading + Correction Factor
Margin = Result - Limit
Remark Peak = Result(PK) - Limit(PK)
Remark AVG = Result(AV) - Limit(AV)



Product Name	Dual-lines VDSL2/ADSL2+ Wireless-AC 3G/4G LTE VPN Firewall Router	Test By	Waternil Guan
Test Model	BiPAC 8920AX	Test Date	2015/05/14
Test Mode	IEEE 802.11gn HT40 TX / CH Low	Temp. & Humidity	25°C, 53%

966 Chamber_C at 3Meter / Vertical

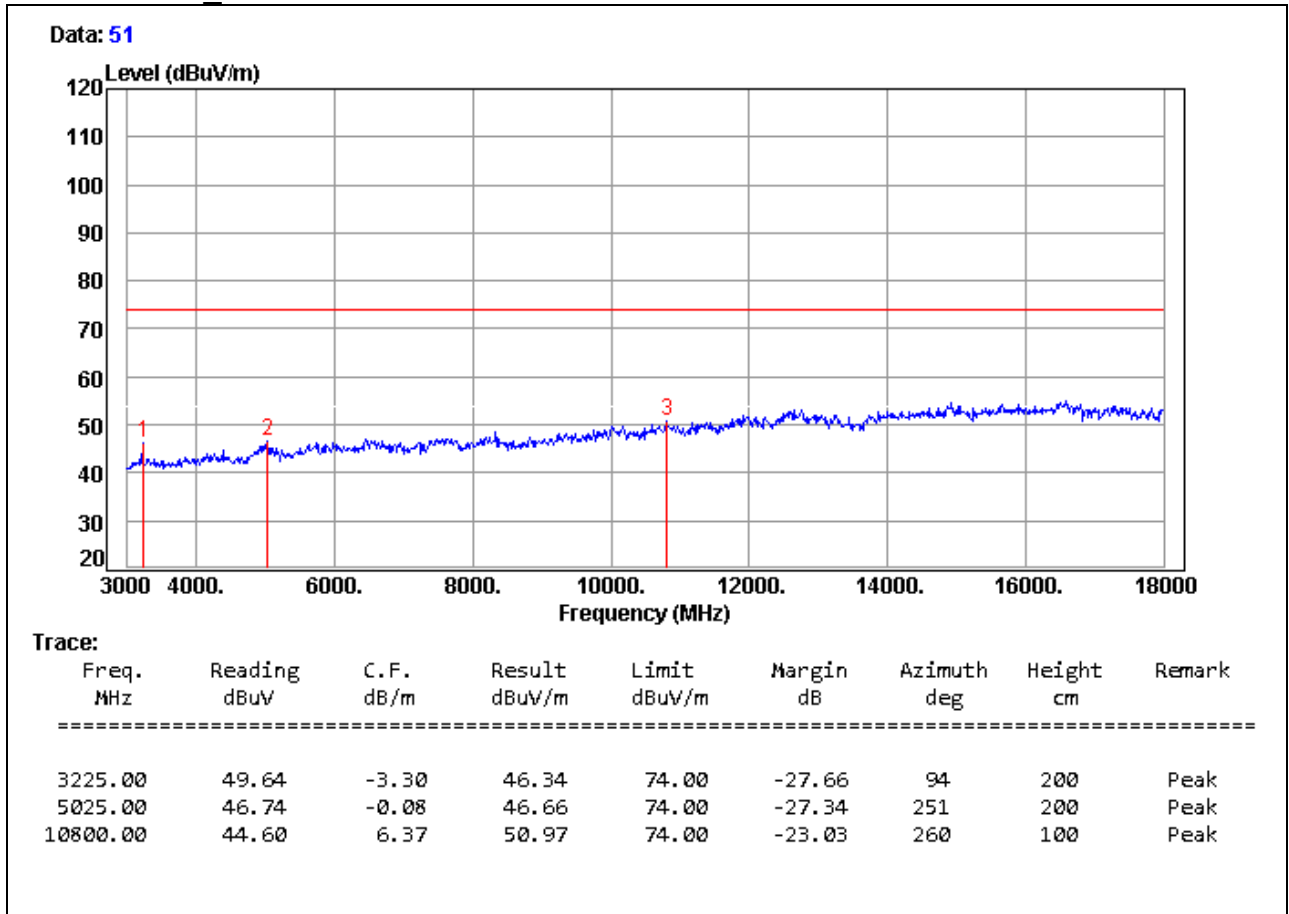

Remark:

1. Measuring frequencies from 1 GHz to the 10th harmonic of highest fundamental frequency.
2. Average test would be performed if the peak result were greater than the average limit.
3. Measurements above show only up to 6 maximum emissions noted, or would be lesser, with " N/A " remark, if no specific emissions from the EUT are recorded (ie: margin>20dB from the applicable limit) and considered that's already beyond the background noise floor.
4. Result = Reading + Correction Factor
Margin = Result - Limit
Remark Peak = Result(PK) - Limit(PK)
Remark AVG = Result(AV) - Limit(AV)
5. There is no emission in 18GHz ~ 26.5GHz.



Product Name	Dual-lines VDSL2/ADSL2+ Wireless-AC 3G/4G LTE VPN Firewall Router	Test By	Waternil Guan
Test Model	BiPAC 8920AX	Test Date	2015/05/15
Test Mode	IEEE 802.11gn HT40 TX / CH Middle	Temp. & Humidity	25°C, 53%

966 Chamber_C at 3Meter / Horizontal

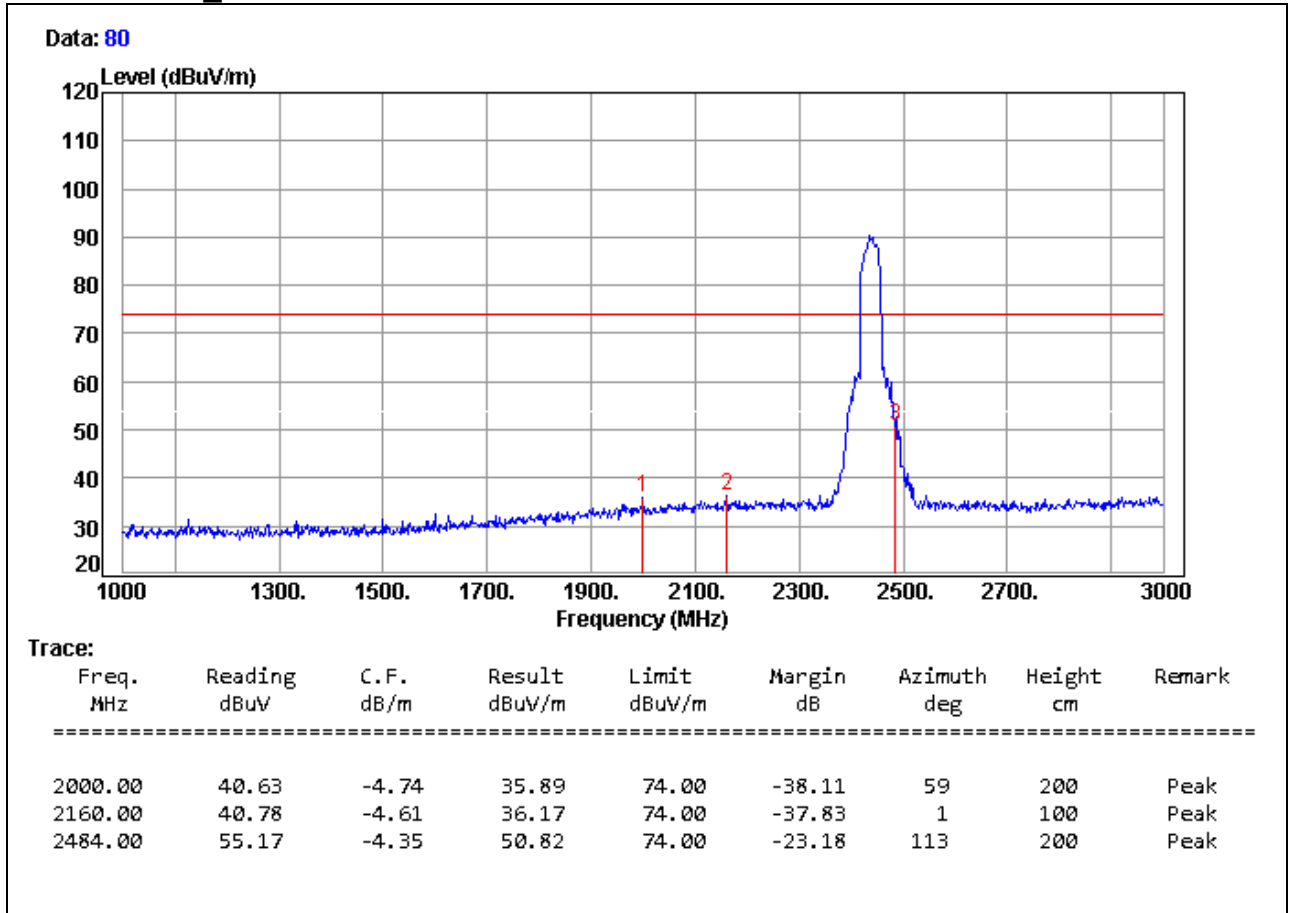

Remark:

1. Measuring frequencies from 1 GHz to the 10th harmonic of highest fundamental frequency.
2. Average test would be performed if the peak result were greater than the average limit.
3. Measurements above show only up to 6 maximum emissions noted, or would be lesser, with " N/A " remark, if no specific emissions from the EUT are recorded (ie: margin>20dB from the applicable limit) and considered that's already beyond the background noise floor.
4. Result = Reading + Correction Factor
Margin = Result - Limit
Remark Peak = Result(PK) - Limit(PK)
Remark AVG = Result(AV) - Limit(AV)



Product Name	Dual-lines VDSL2/ADSL2+ Wireless-AC 3G/4G LTE VPN Firewall Router	Test By	Waternil Guan
Test Model	BiPAC 8920AX	Test Date	2015/05/14
Test Mode	IEEE 802.11gn HT40 TX / CH Middle	Temp. & Humidity	25°C, 53%

966 Chamber_C at 3Meter / Horizontal

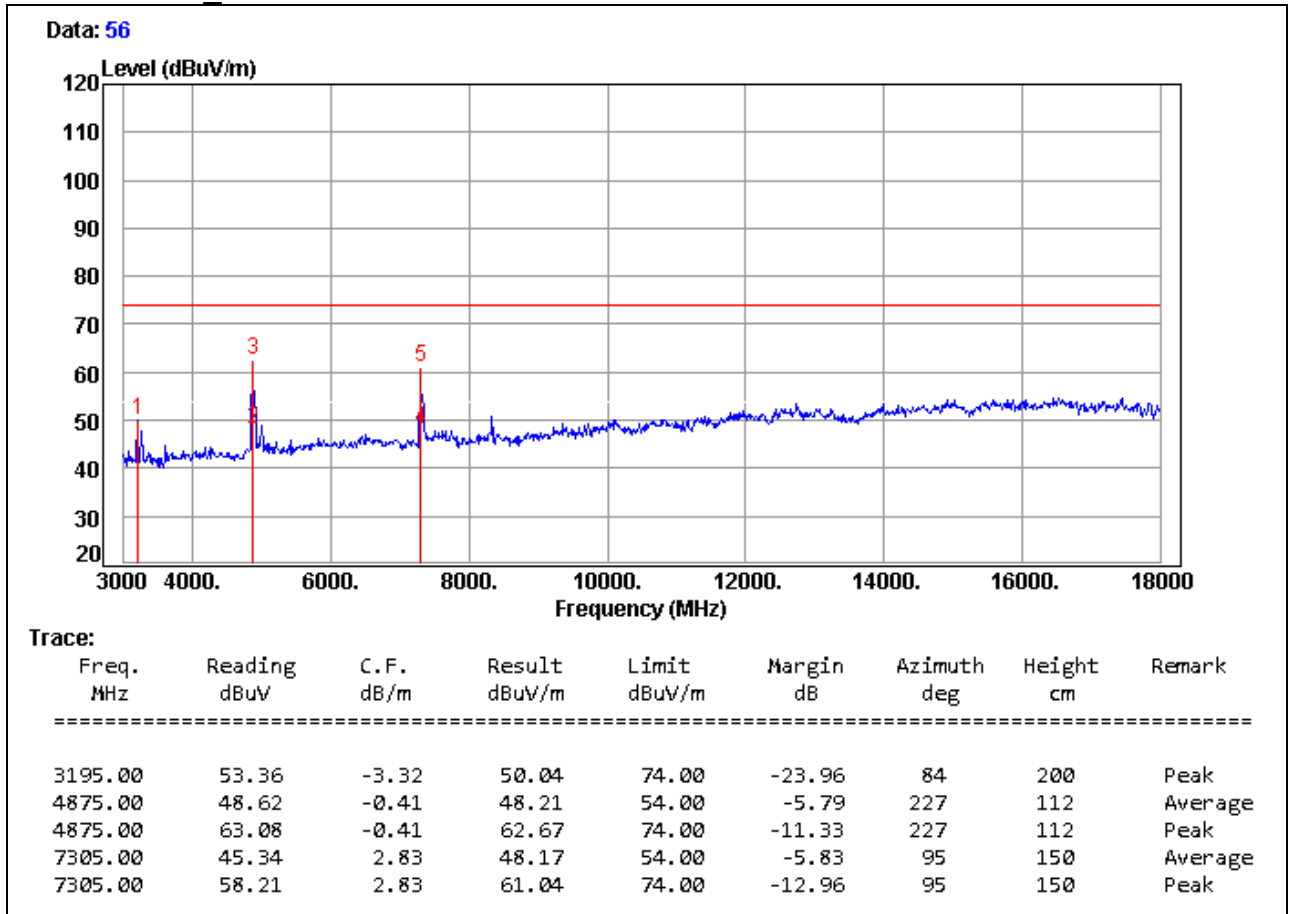

Remark:

1. Measuring frequencies from 1 GHz to the 10th harmonic of highest fundamental frequency.
2. Average test would be performed if the peak result were greater than the average limit.
3. Measurements above show only up to 6 maximum emissions noted, or would be lesser, with " N/A " remark, if no specific emissions from the EUT are recorded (ie: margin>20dB from the applicable limit) and considered that's already beyond the background noise floor.
4. Result = Reading + Correction Factor
Margin = Result - Limit
Remark Peak = Result(PK) - Limit(PK)
Remark AVG = Result(AV) - Limit(AV)
5. There is no emission in 18GHz ~ 26.5GHz.



Product Name	Dual-lines VDSL2/ADSL2+ Wireless-AC 3G/4G LTE VPN Firewall Router	Test By	Waternil Guan
Test Model	BiPAC 8920AX	Test Date	2015/05/15
Test Mode	IEEE 802.11gn HT40 TX / CH Middle	Temp. & Humidity	25°C, 53%

966 Chamber_C at 3Meter / Vertical

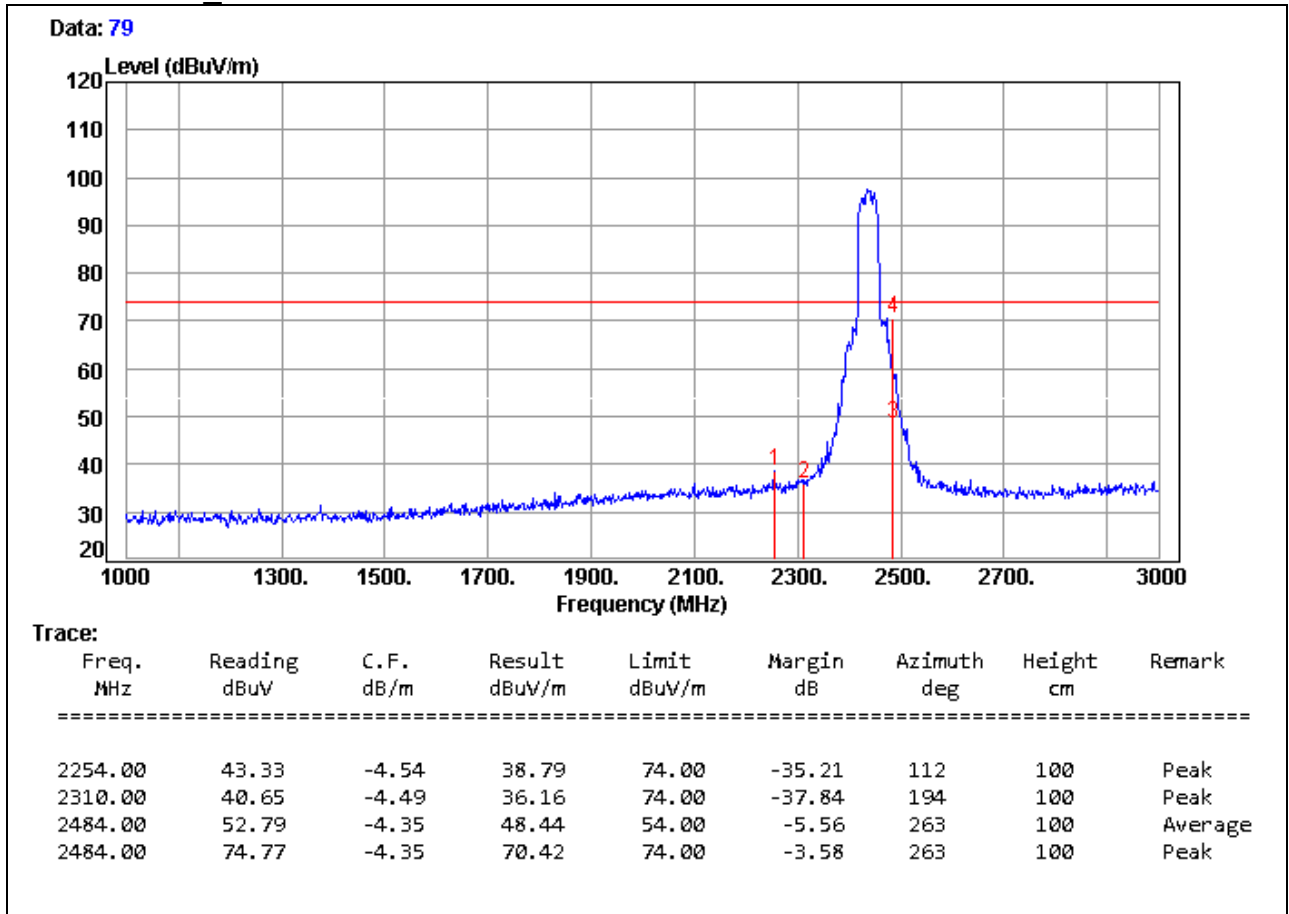

Remark:

1. Measuring frequencies from 1 GHz to the 10th harmonic of highest fundamental frequency.
2. Average test would be performed if the peak result were greater than the average limit.
3. Measurements above show only up to 6 maximum emissions noted, or would be lesser, with " N/A " remark, if no specific emissions from the EUT are recorded (ie: margin>20dB from the applicable limit) and considered that's already beyond the background noise floor.
4. Result = Reading + Correction Factor
Margin = Result - Limit
Remark Peak = Result(PK) - Limit(PK)
Remark AVG = Result(AV) - Limit(AV)



Product Name	Dual-lines VDSL2/ADSL2+ Wireless-AC 3G/4G LTE VPN Firewall Router	Test By	Waternil Guan
Test Model	BiPAC 8920AX	Test Date	2015/05/14
Test Mode	IEEE 802.11gn HT40 TX / CH Middle	Temp. & Humidity	25°C, 53%

966 Chamber_C at 3Meter / Vertical

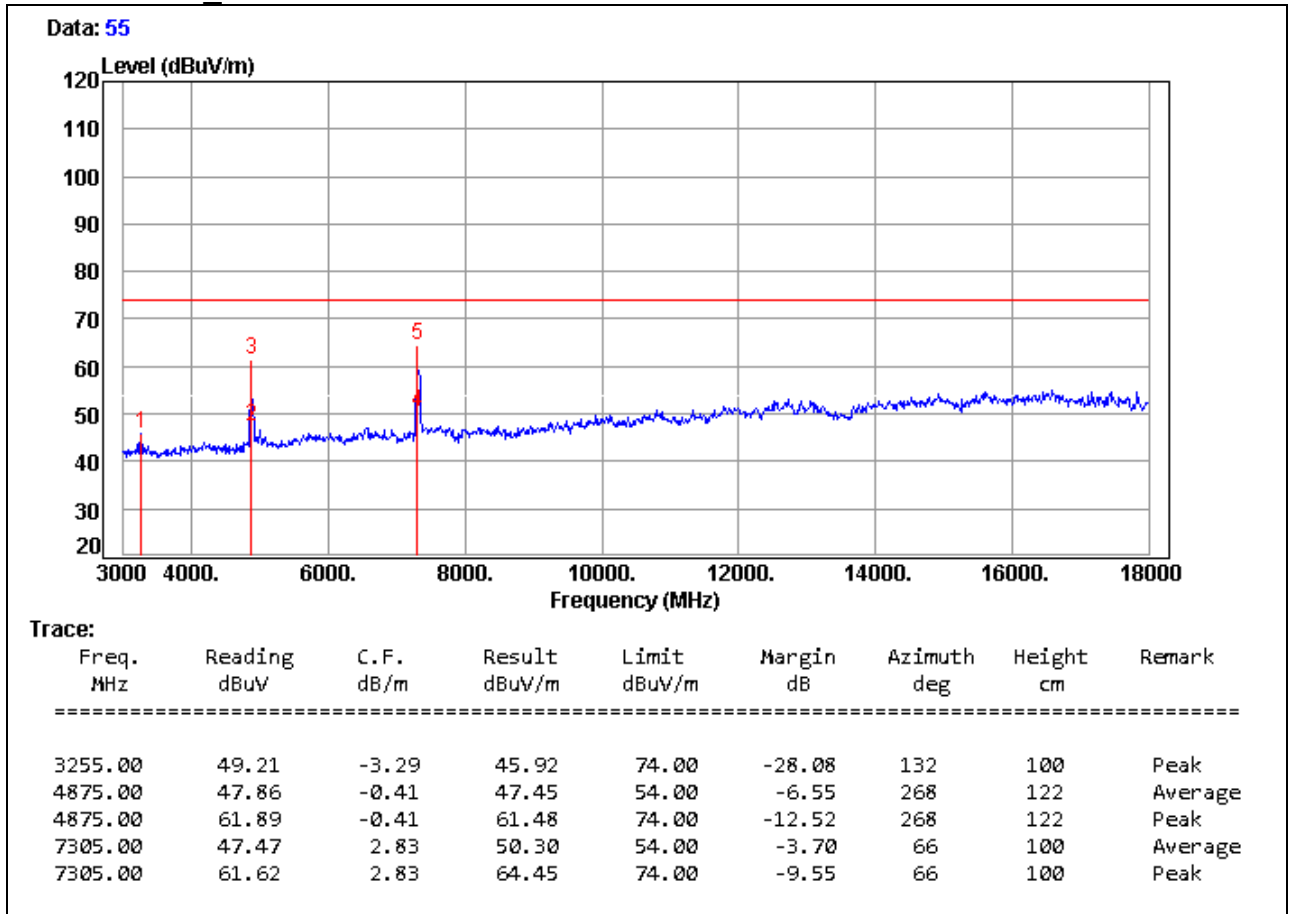

Remark:

1. Measuring frequencies from 1 GHz to the 10th harmonic of highest fundamental frequency.
2. Average test would be performed if the peak result were greater than the average limit.
3. Measurements above show only up to 6 maximum emissions noted, or would be lesser, with " N/A " remark, if no specific emissions from the EUT are recorded (ie: margin>20dB from the applicable limit) and considered that's already beyond the background noise floor.
4. Result = Reading + Correction Factor
Margin = Result - Limit
Remark Peak = Result(PK) - Limit(PK)
Remark AVG = Result(AV) - Limit(AV)
5. There is no emission in 18GHz ~ 26.5GHz.



Product Name	Dual-lines VDSL2/ADSL2+ Wireless-AC 3G/4G LTE VPN Firewall Router	Test By	Waternil Guan
Test Model	BiPAC 8920AX	Test Date	2015/05/15
Test Mode	IEEE 802.11gn HT40 TX / CH High	Temp. & Humidity	25°C, 53%

966 Chamber_C at 3Meter / Horizontal

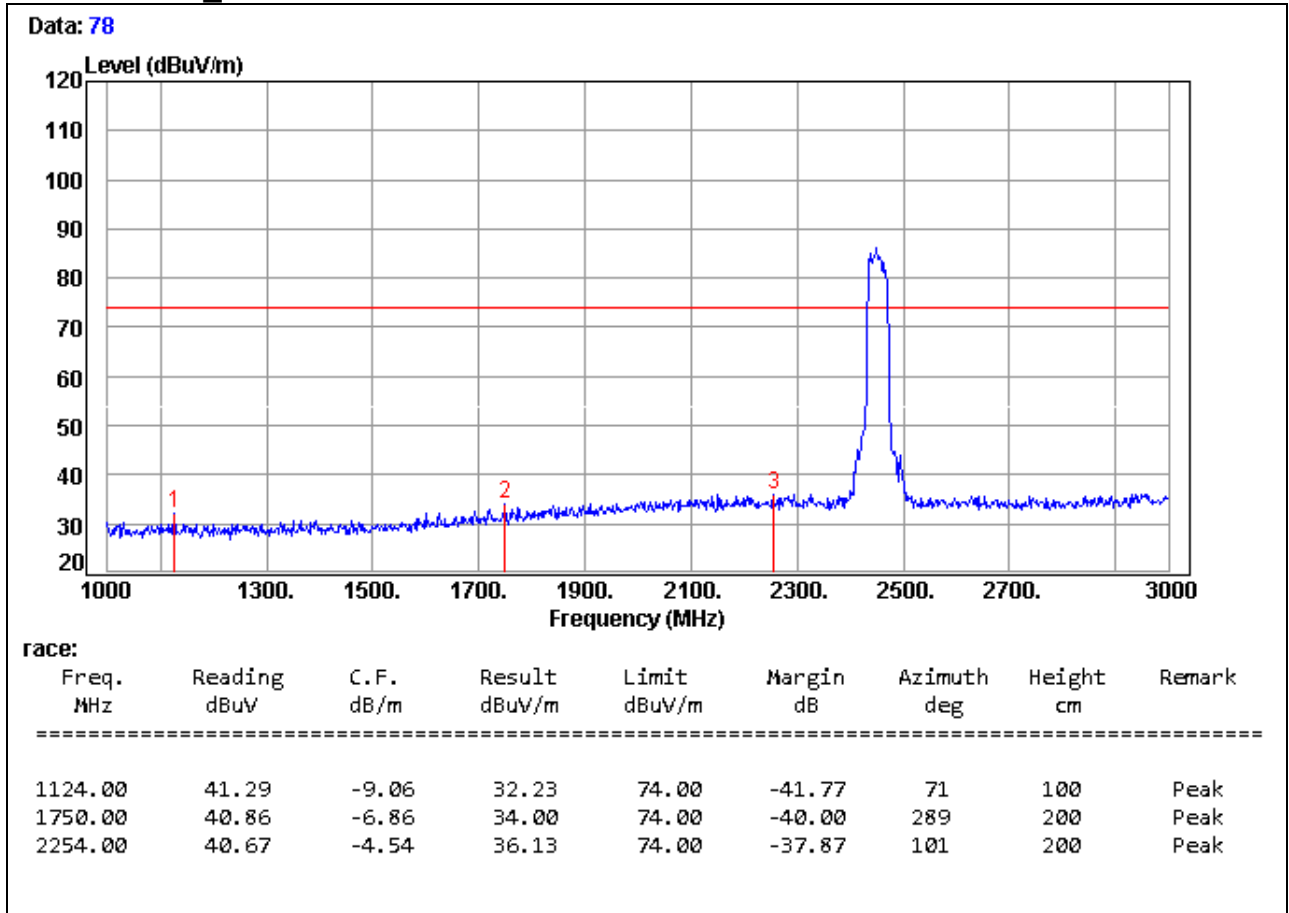

Remark:

1. Measuring frequencies from 1 GHz to the 10th harmonic of highest fundamental frequency.
2. Average test would be performed if the peak result were greater than the average limit.
3. Measurements above show only up to 6 maximum emissions noted, or would be lesser, with " N/A " remark, if no specific emissions from the EUT are recorded (ie: margin>20dB from the applicable limit) and considered that's already beyond the background noise floor.
4. Result = Reading + Correction Factor
 Margin = Result - Limit
 Remark Peak = Result(PK) - Limit(PK)
 Remark AVG = Result(AV) - Limit(AV)



Product Name	Dual-lines VDSL2/ADSL2+ Wireless-AC 3G/4G LTE VPN Firewall Router	Test By	Waternil Guan
Test Model	BiPAC 8920AX	Test Date	2015/05/14
Test Mode	IEEE 802.11gn HT40 TX / CH High	Temp. & Humidity	25°C, 53%

966 Chamber_C at 3Meter / Horizontal

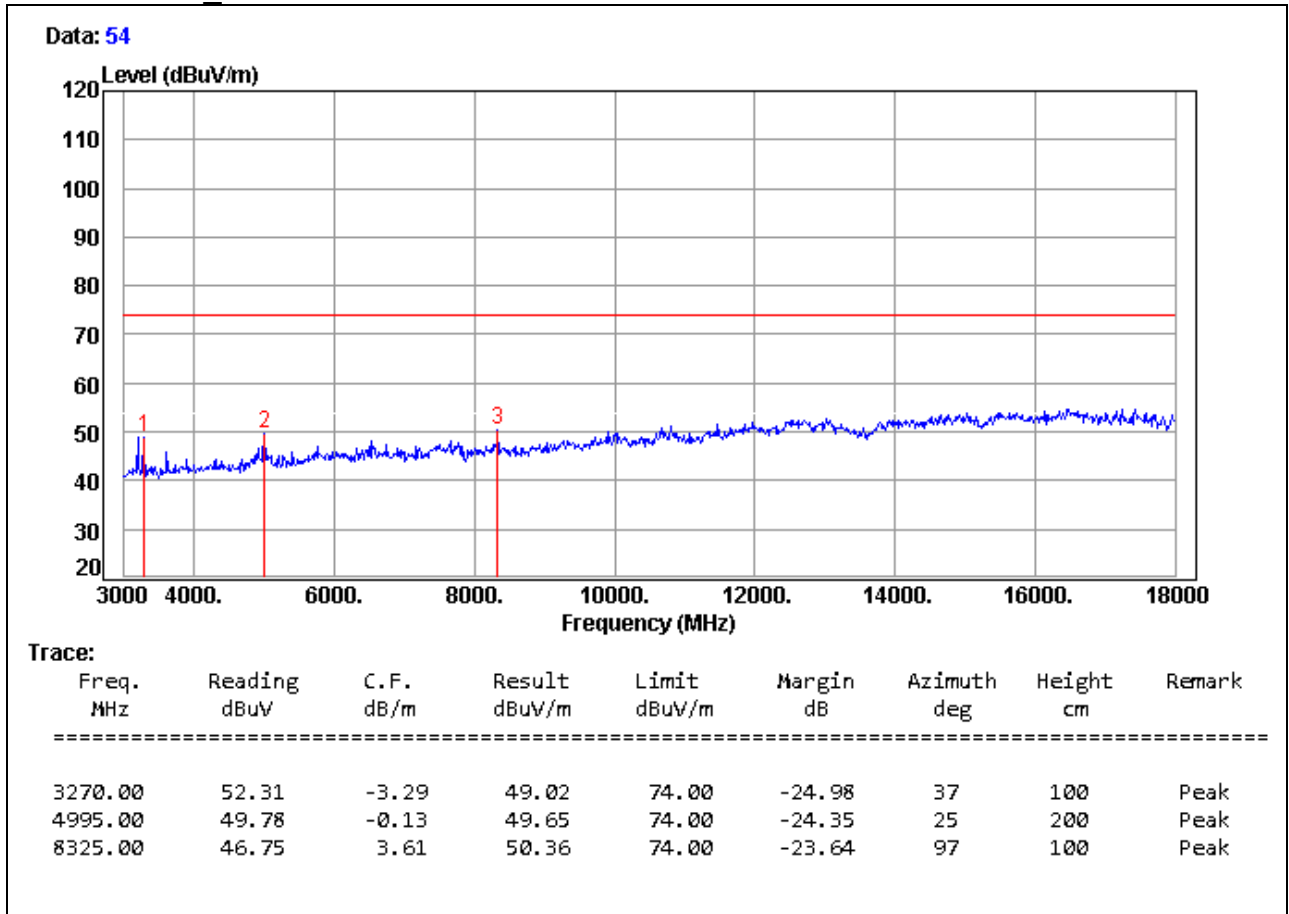

Remark:

1. Measuring frequencies from 1 GHz to the 10th harmonic of highest fundamental frequency.
2. Average test would be performed if the peak result were greater than the average limit.
3. Measurements above show only up to 6 maximum emissions noted, or would be lesser, with " N/A " remark, if no specific emissions from the EUT are recorded (ie: margin>20dB from the applicable limit) and considered that's already beyond the background noise floor.
4. Result = Reading + Correction Factor
Margin = Result - Limit
Remark Peak = Result(PK) - Limit(PK)
Remark AVG = Result(AV) - Limit(AV)
5. There is no emission in 18GHz ~ 26.5GHz.



Product Name	Dual-lines VDSL2/ADSL2+ Wireless-AC 3G/4G LTE VPN Firewall Router	Test By	Waternil Guan
Test Model	BiPAC 8920AX	Test Date	2015/05/15
Test Mode	IEEE 802.11gn HT40 TX / CH High	Temp. & Humidity	25°C, 53%

966 Chamber_C at 3Meter / Vertical

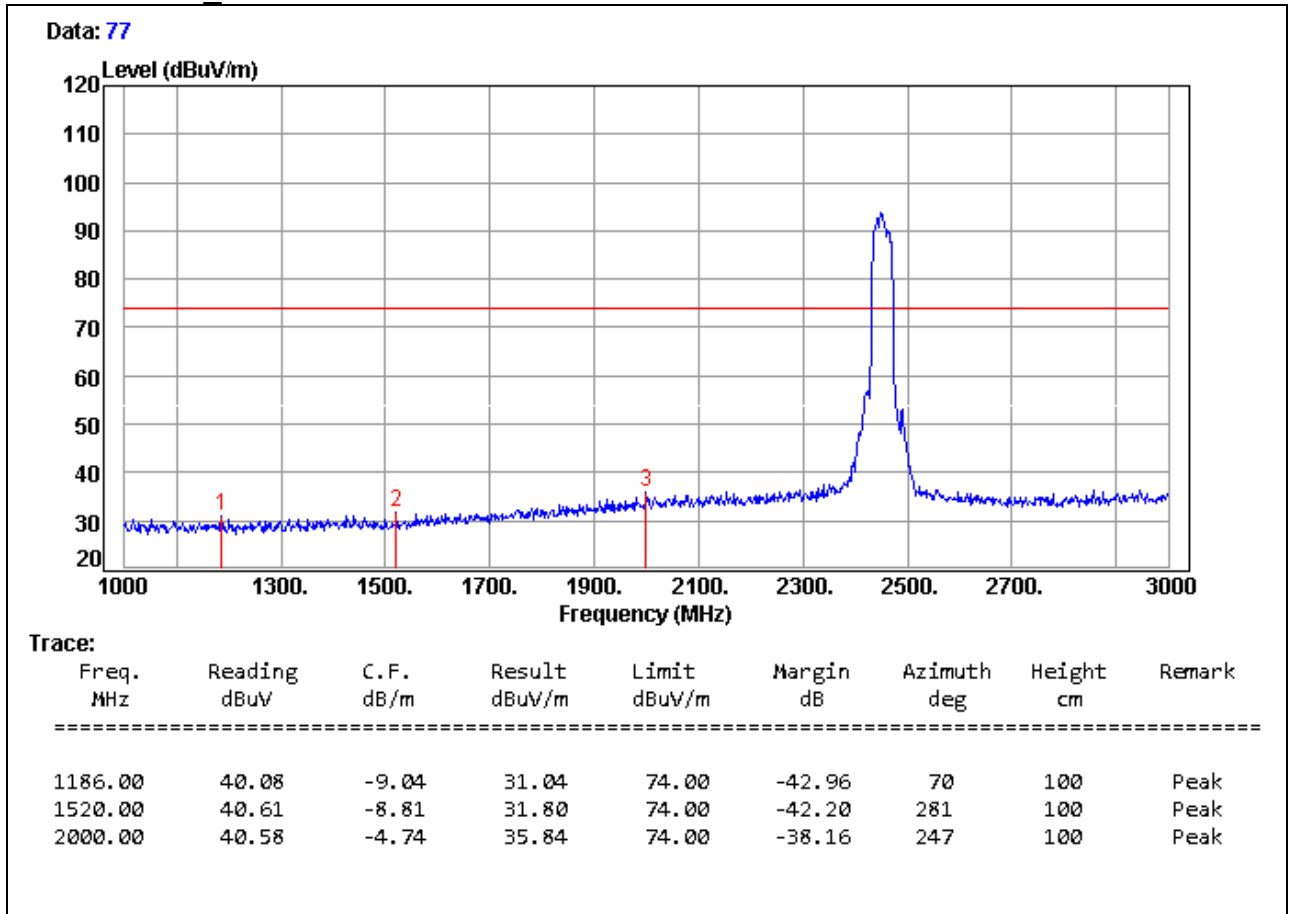

Remark:

1. Measuring frequencies from 1 GHz to the 10th harmonic of highest fundamental frequency.
2. Average test would be performed if the peak result were greater than the average limit.
3. Measurements above show only up to 6 maximum emissions noted, or would be lesser, with " N/A " remark, if no specific emissions from the EUT are recorded (ie: margin>20dB from the applicable limit) and considered that's already beyond the background noise floor.
4. Result = Reading + Correction Factor
Margin = Result - Limit
Remark Peak = Result(PK) - Limit(PK)
Remark AVG = Result(AV) - Limit(AV)



Product Name	Dual-lines VDSL2/ADSL2+ Wireless-AC 3G/4G LTE VPN Firewall Router	Test By	Waternil Guan
Test Model	BiPAC 8920AX	Test Date	2015/05/14
Test Mode	IEEE 802.11gn HT40 TX / CH High	Temp. & Humidity	25°C, 53%

966 Chamber_C at 3Meter / Vertical

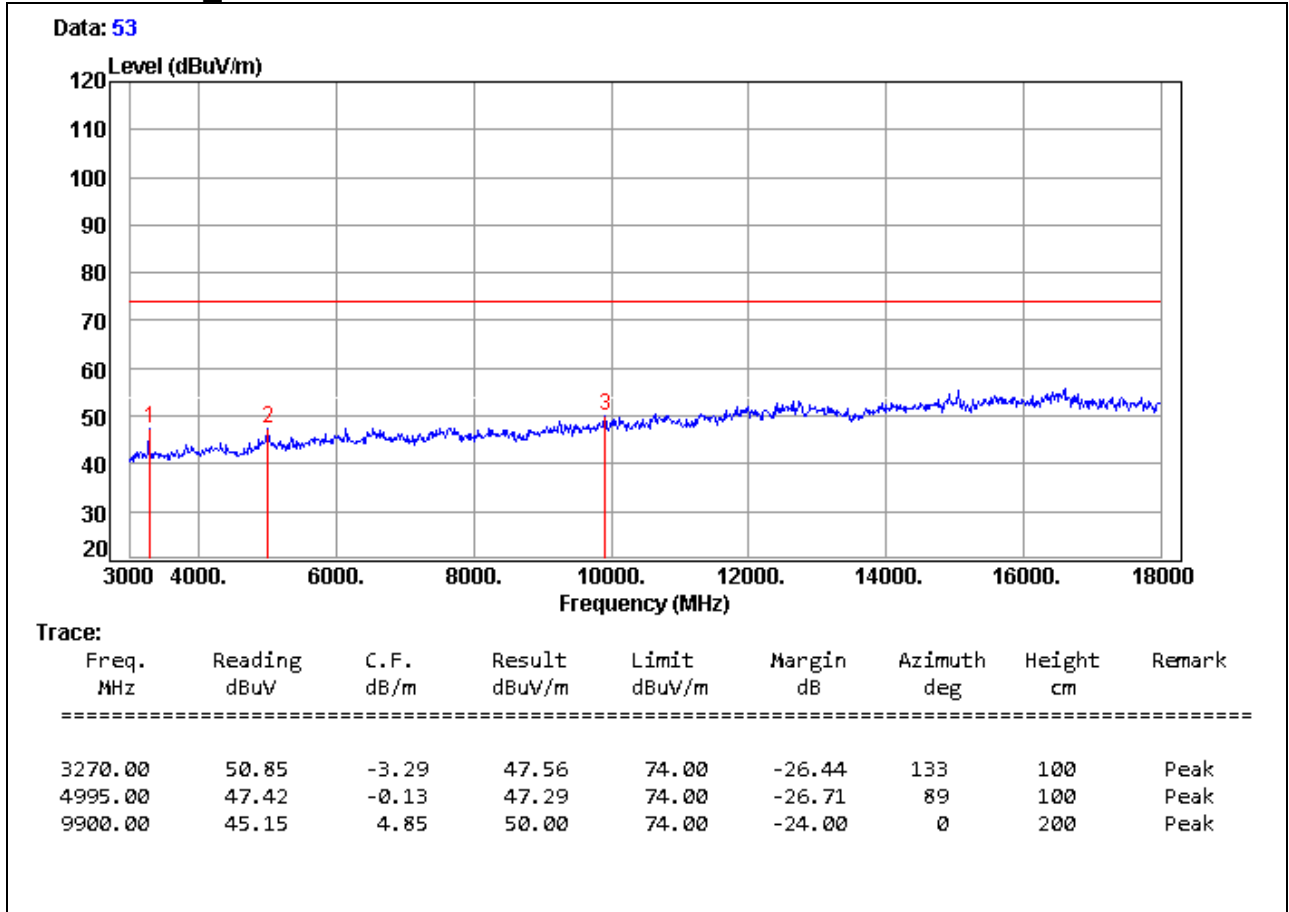

Remark:

1. Measuring frequencies from 1 GHz to the 10th harmonic of highest fundamental frequency.
2. Average test would be performed if the peak result were greater than the average limit.
3. Measurements above show only up to 6 maximum emissions noted, or would be lesser, with " N/A " remark, if no specific emissions from the EUT are recorded (ie: margin>20dB from the applicable limit) and considered that's already beyond the background noise floor.
4. Result = Reading + Correction Factor
Margin = Result - Limit
Remark Peak = Result(PK) - Limit(PK)
Remark AVG = Result(AV) - Limit(AV)
5. There is no emission in 18GHz ~ 26.5GHz.



Restricted Band Edges

Detector Mode : Peak Polarity : Horizontal

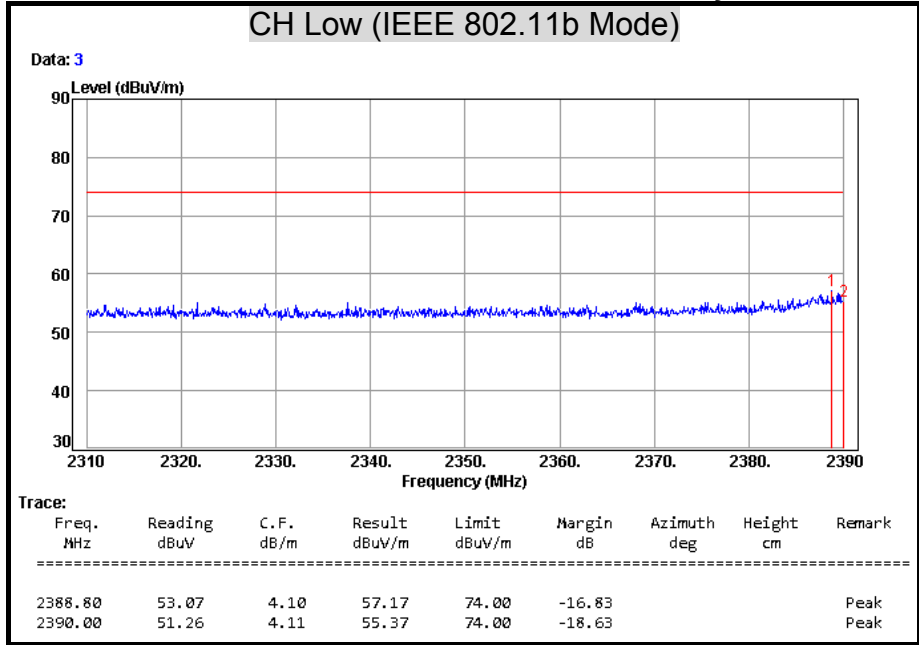

Detector Mode : Average Polarity : Horizontal

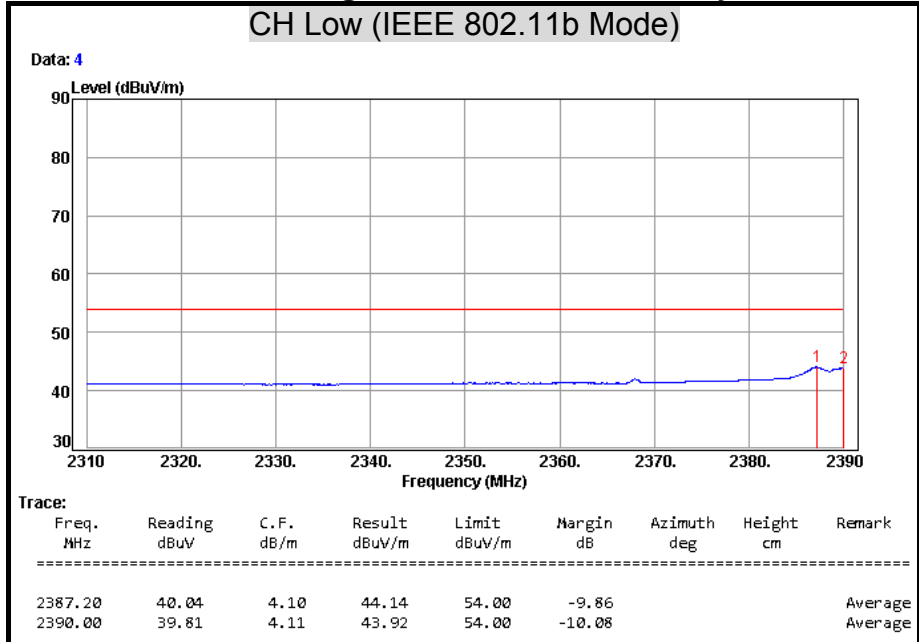



Detector Mode : Peak

Polarity : Vertical

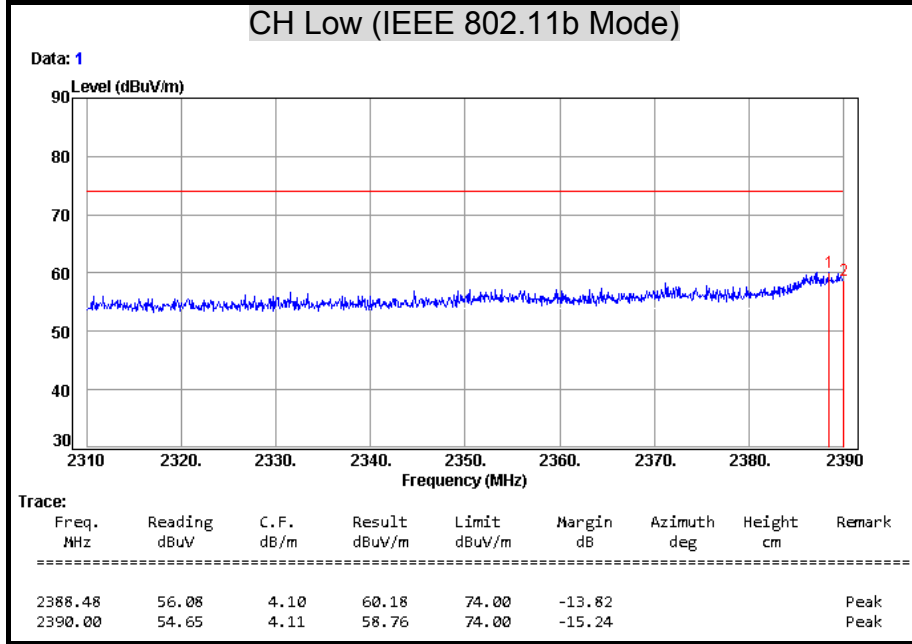

Detector Mode : Average

Polarity : Vertical

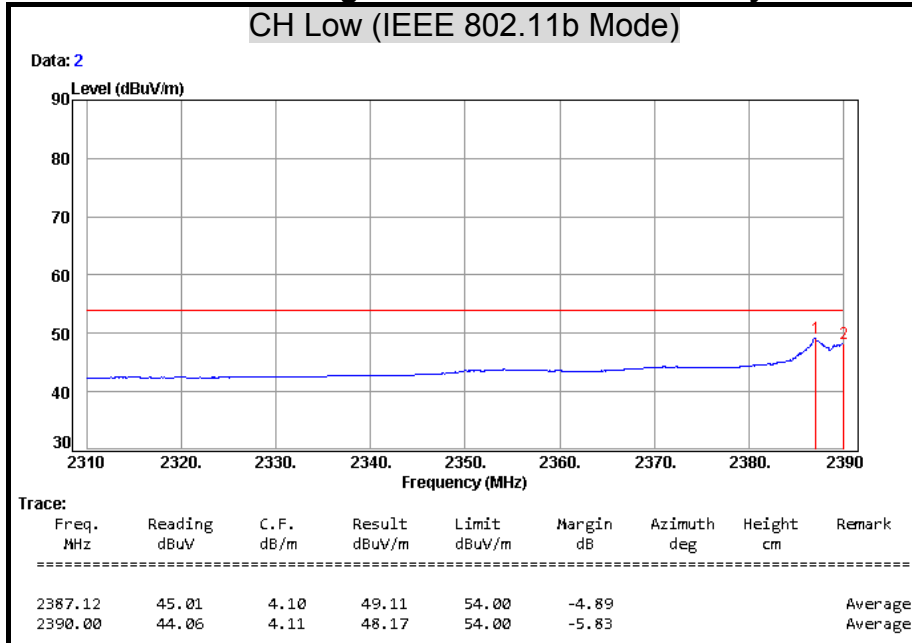



Detector Mode : Peak

Polarity : Horizontal

CH High (IEEE 802.11b Mode)

Data: 19

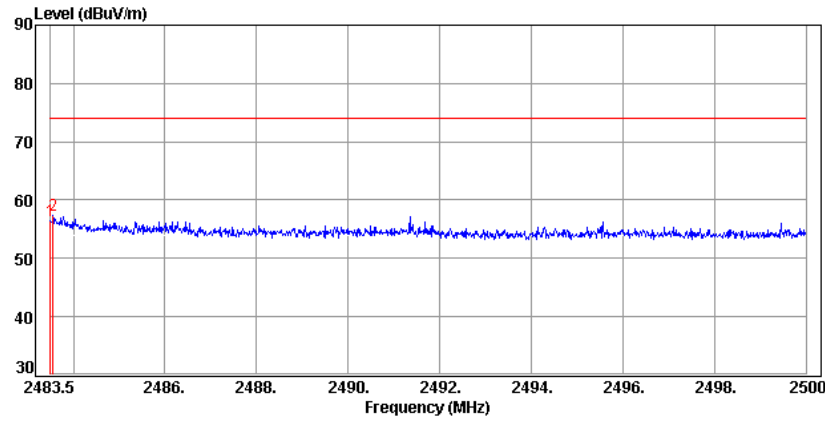

Trace:	Freq. MHz	Reading dBuV	C.F. dB/m	Result dBuV/m	Limit dBuV/m	Margin dB	Azimuth deg	Height cm	Remark
	2483.50	52.06	4.29	56.35	74.00	-17.65			Peak
	2483.55	53.02	4.29	57.31	74.00	-16.69			Peak

Detector Mode : Average

Polarity : Horizontal

CH High (IEEE 802.11b Mode)

Data: 20

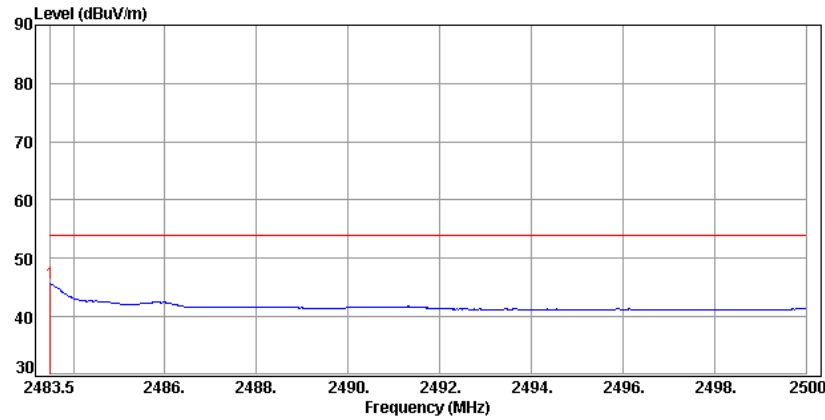

Trace:	Freq. MHz	Reading dBuV	C.F. dB/m	Result dBuV/m	Limit dBuV/m	Margin dB	Azimuth deg	Height cm	Remark
	2483.50	41.46	4.29	45.75	54.00	-8.25			Average



Detector Mode : Peak Polarity : Vertical

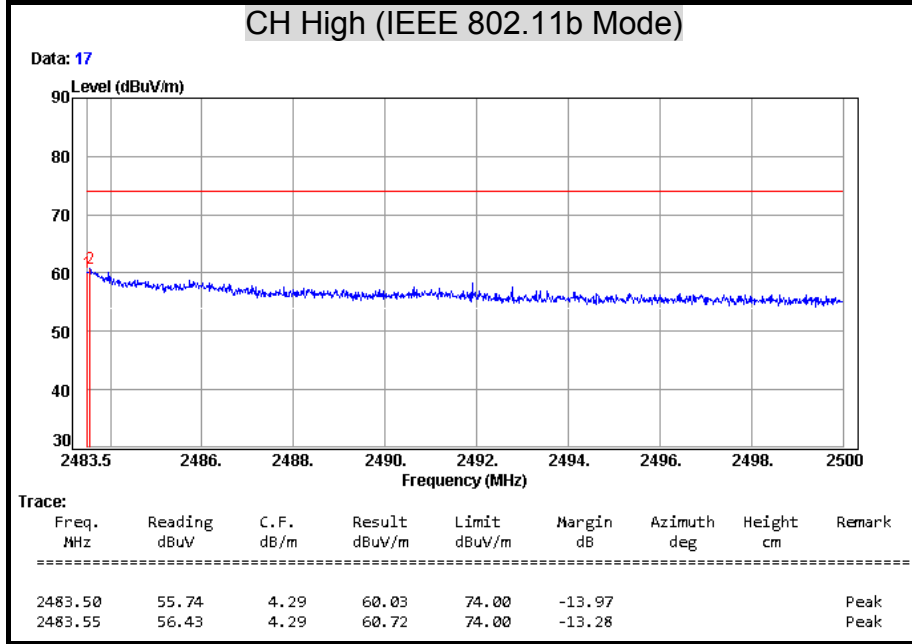

Detector Mode : Average Polarity : Vertical

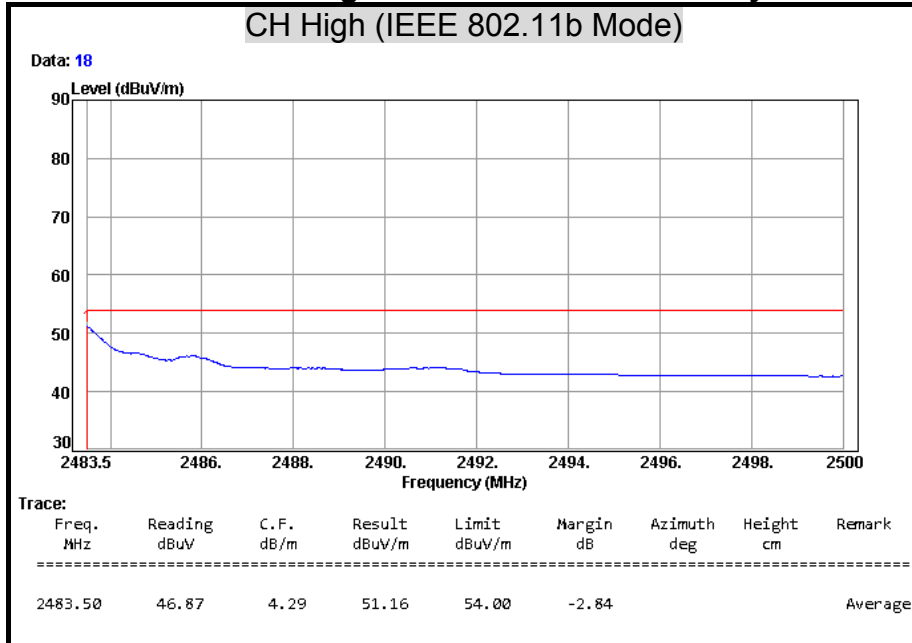



Detector Mode : Peak Polarity : Horizontal

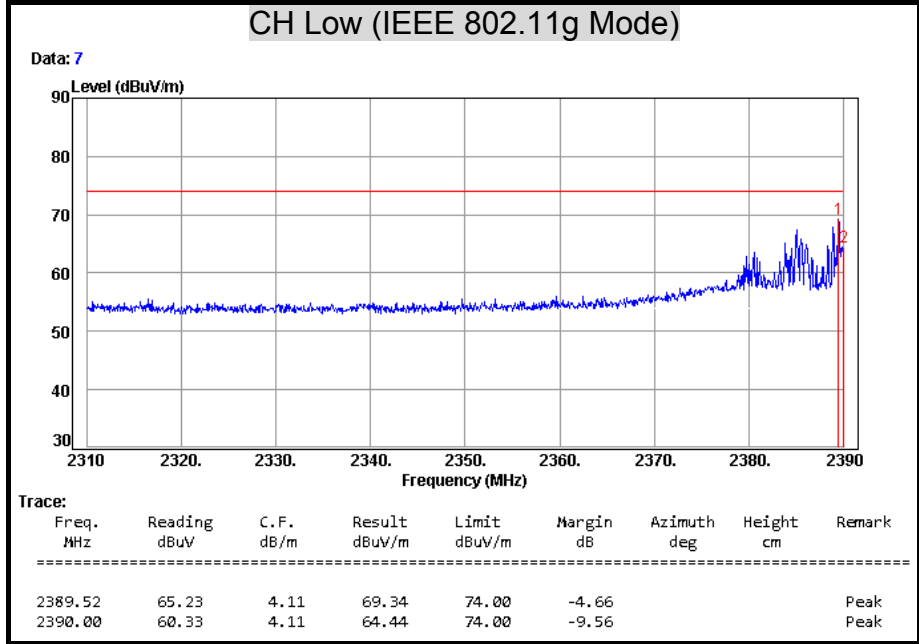

Detector Mode : Average Polarity : Horizontal

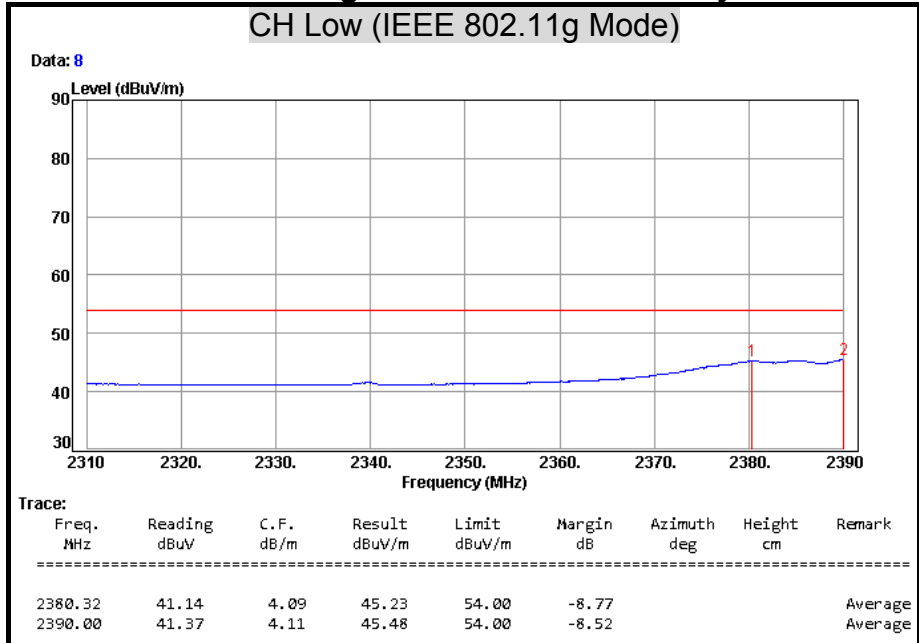



Detector Mode : Peak Polarity : Vertical

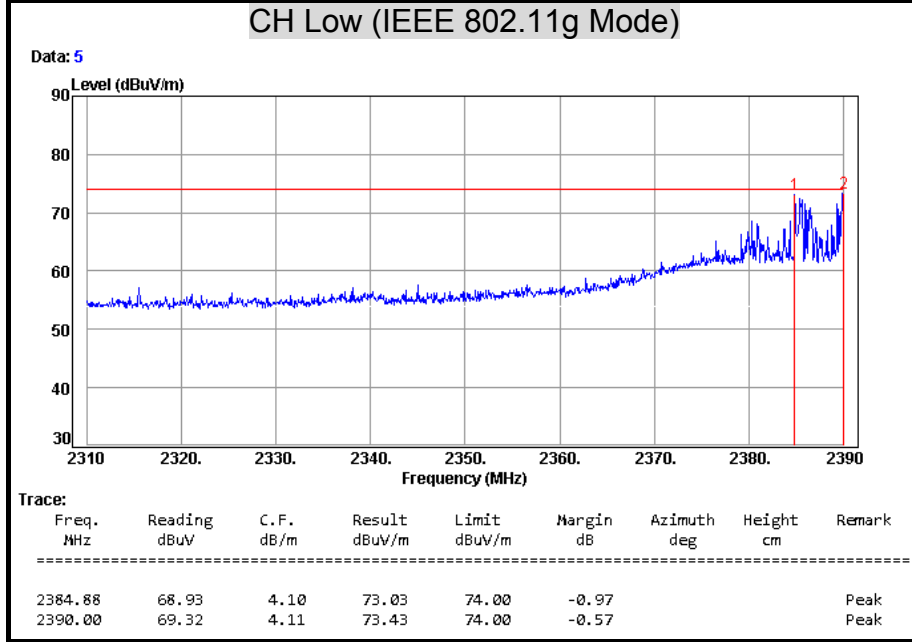

Detector Mode : Average Polarity : Vertical

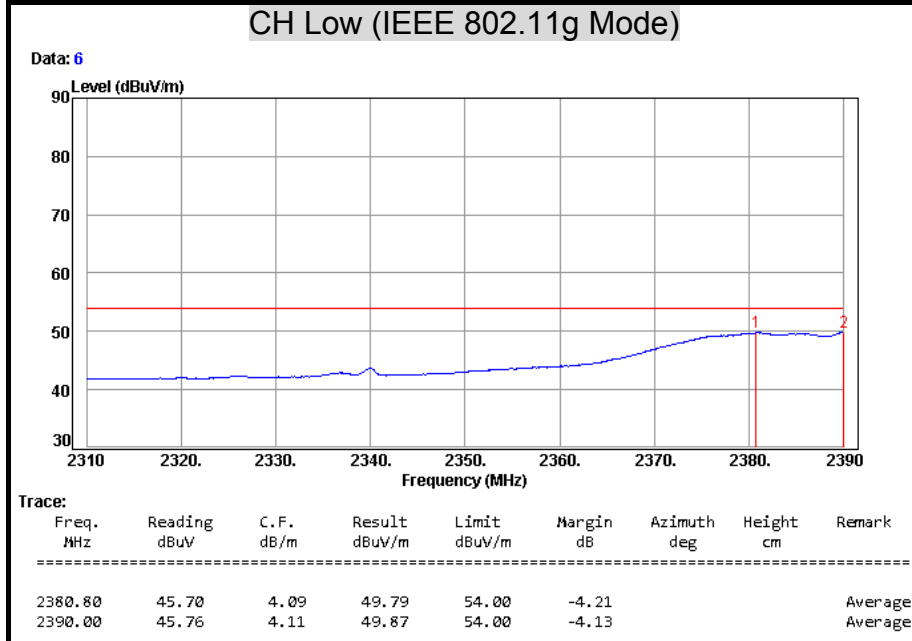



Detector Mode : Peak Polarity : Horizontal

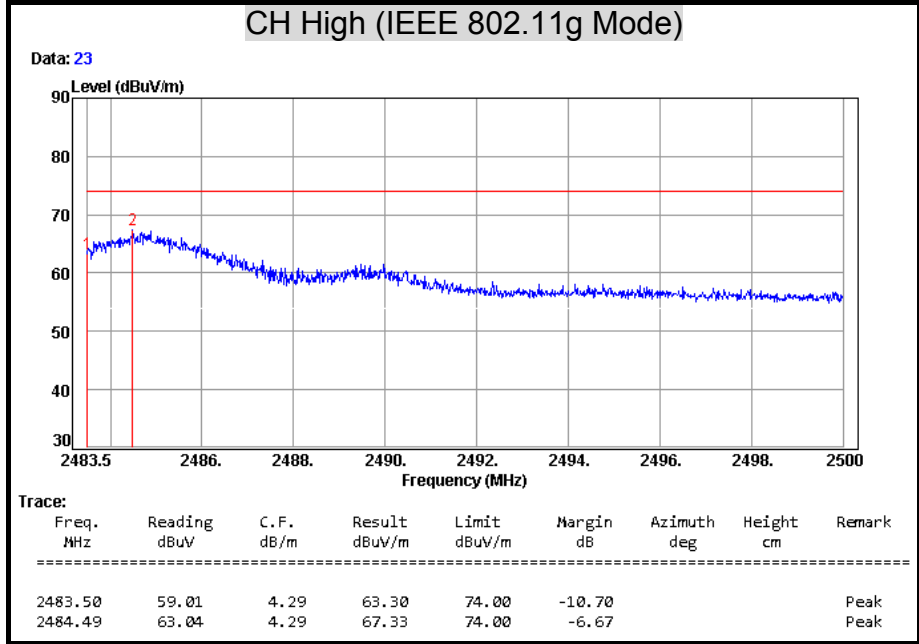

Detector Mode : Average Polarity : Horizontal

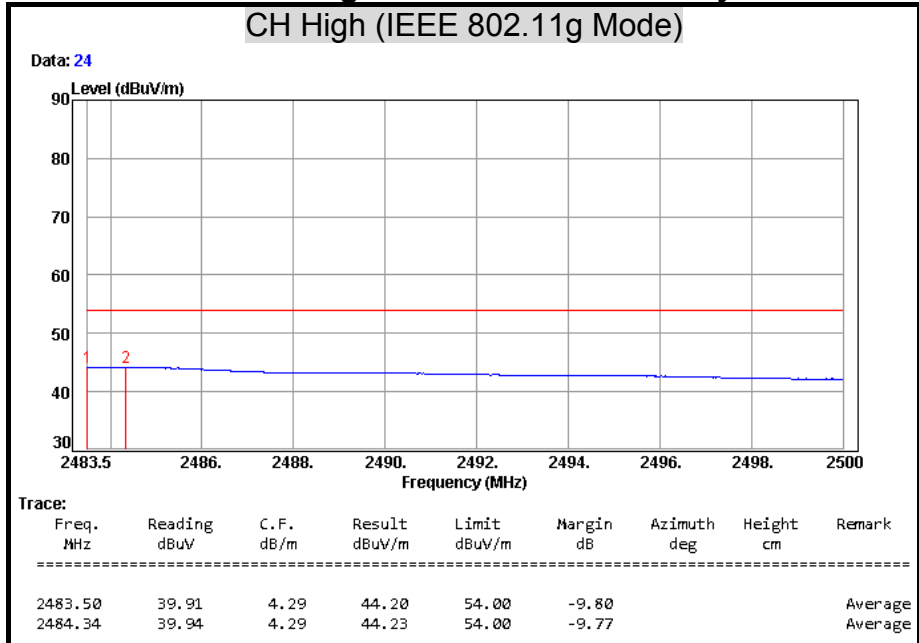



Detector Mode : Peak

Polarity : Vertical

CH High (IEEE 802.11g Mode)

Data: 21

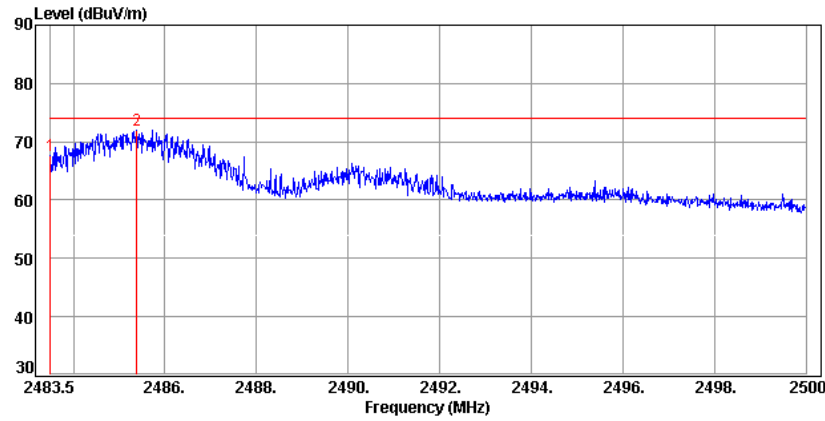

Trace:

Freq. MHz	Reading dBuV	C.F. dB/m	Result dBuV/m	Limit dBuV/m	Margin dB	Azimuth deg	Height cm	Remark
2483.50	63.42	4.29	67.71	74.00	-6.29			Peak
2485.37	67.76	4.29	72.05	74.00	-1.95			Peak

Detector Mode : Average

Polarity : Vertical

CH High (IEEE 802.11g Mode)

Data: 22

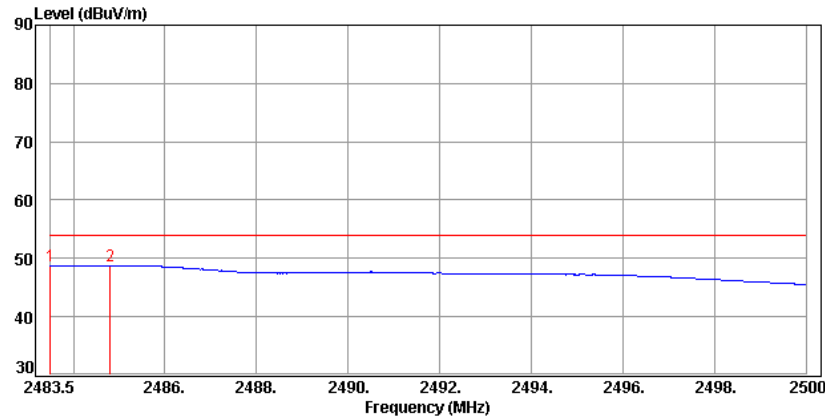

Trace:

Freq. MHz	Reading dBuV	C.F. dB/m	Result dBuV/m	Limit dBuV/m	Margin dB	Azimuth deg	Height cm	Remark
2483.50	44.36	4.29	48.65	54.00	-5.35			Average
2484.80	44.52	4.29	48.81	54.00	-5.19			Average



Detector Mode : Peak Polarity : Horizontal

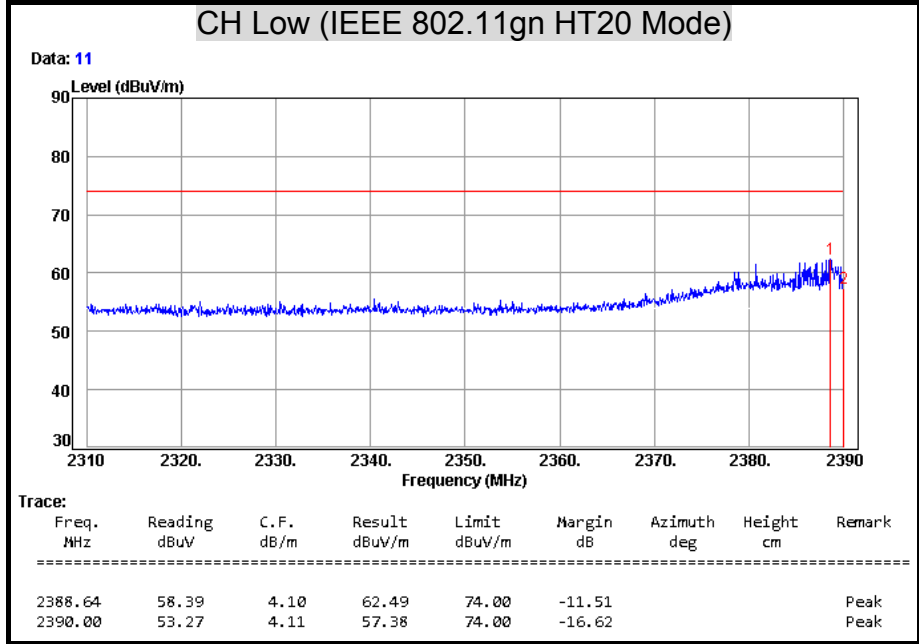

Detector Mode : Average Polarity : Horizontal

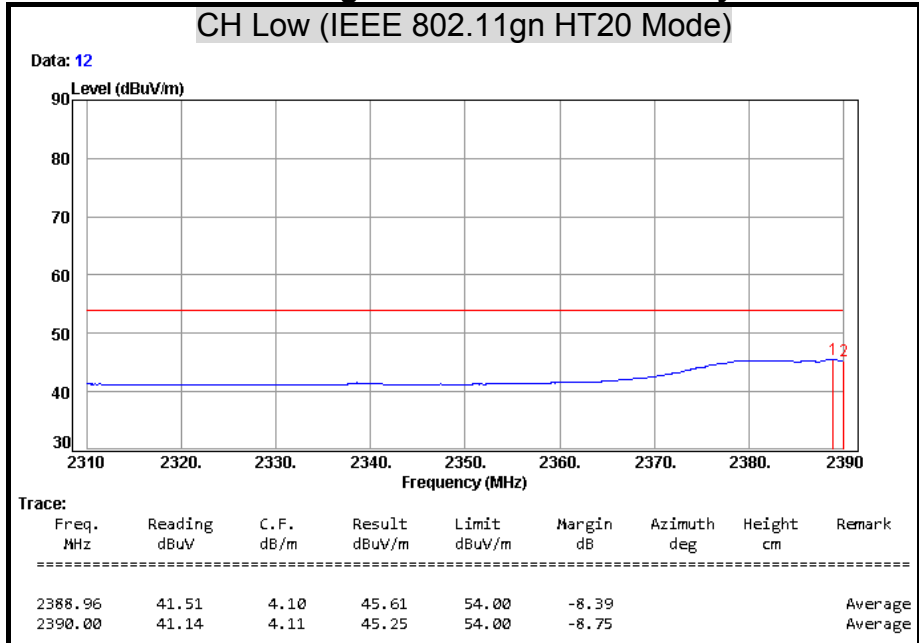



Detector Mode : Peak Polarity : Vertical

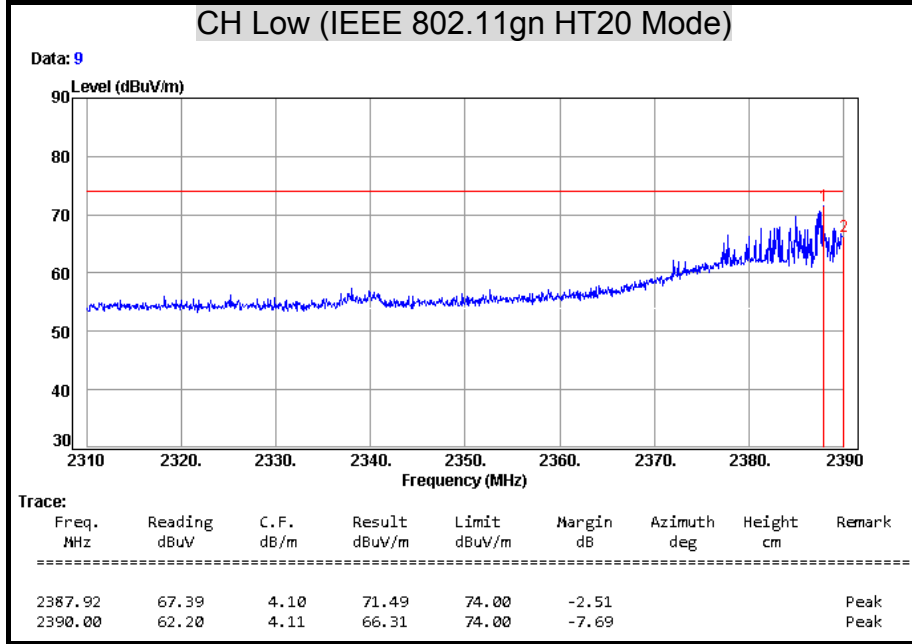

Detector Mode : Average Polarity : Vertical

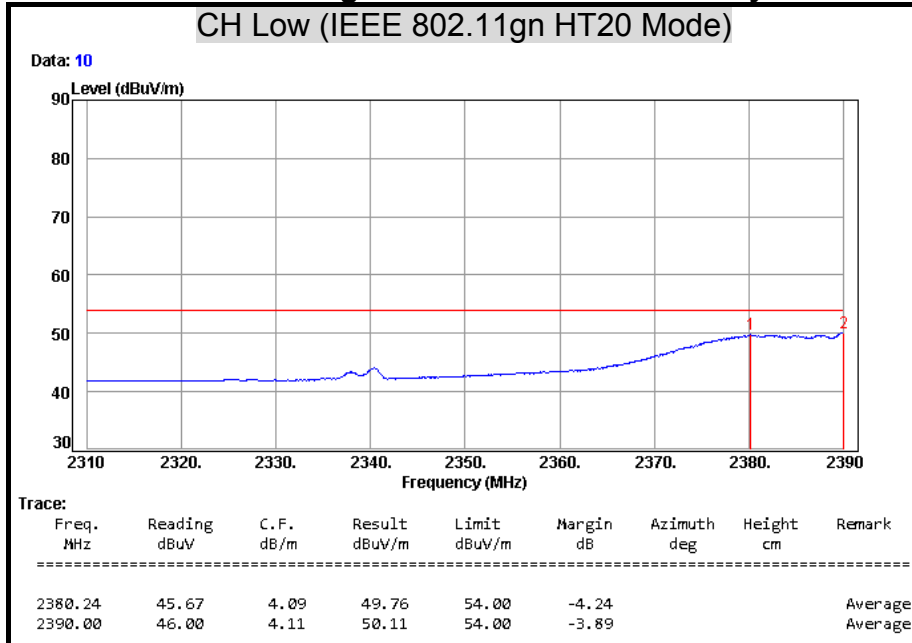



Detector Mode : Peak Polarity : Horizontal

CH High (IEEE 802.11gn HT20 Mode)

Data: 27

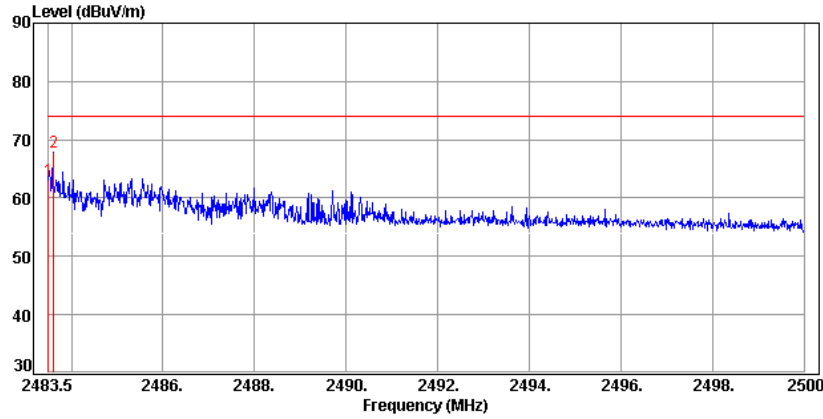

Trace:	Freq. MHz	Reading dBuV	C.F. dB/m	Result dBuV/m	Limit dBuV/m	Margin dB	Azimuth deg	Height cm	Remark
	2483.50	58.79	4.29	63.08	74.00	-10.92			Peak
	2483.60	63.64	4.29	67.93	74.00	-6.07			Peak

Detector Mode : Average Polarity : Horizontal

CH High (IEEE 802.11gn HT20 Mode)

Data: 28

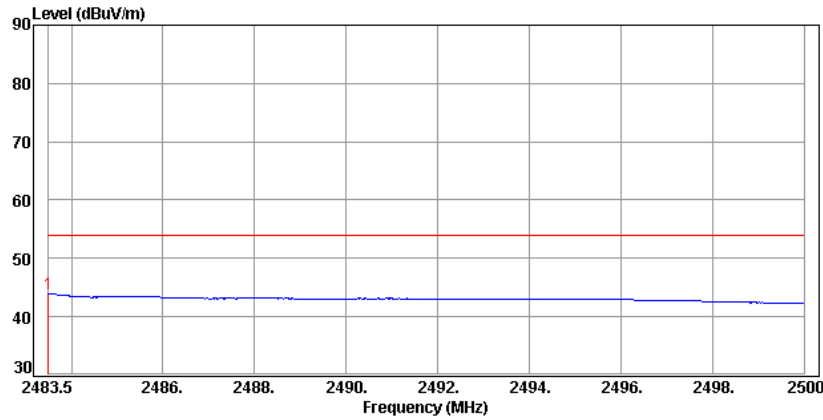

Trace:	Freq. MHz	Reading dBuV	C.F. dB/m	Result dBuV/m	Limit dBuV/m	Margin dB	Azimuth deg	Height cm	Remark
	2483.50	39.63	4.29	43.92	54.00	-10.08			Average



Detector Mode : Peak Polarity : Vertical

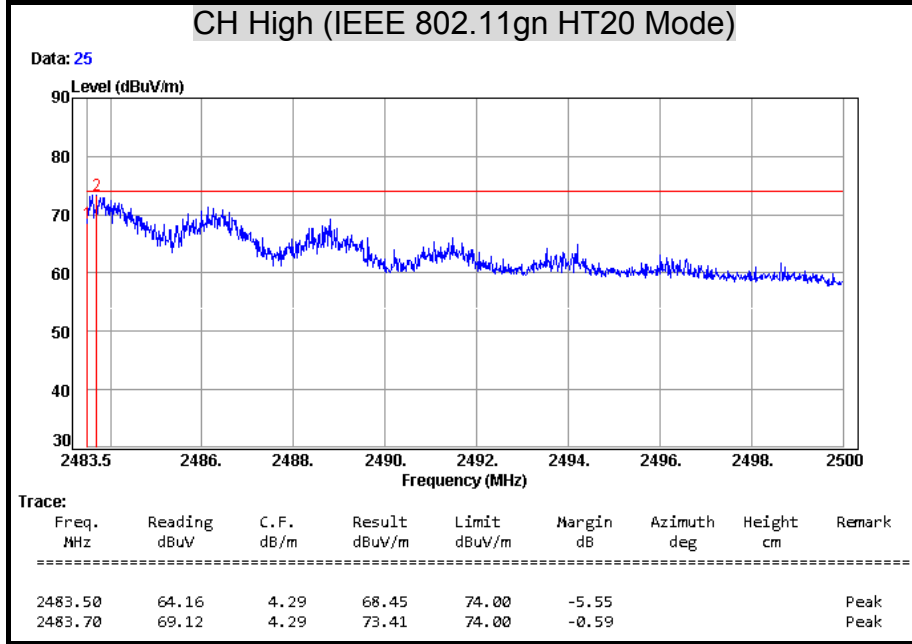

Detector Mode : Average Polarity : Vertical

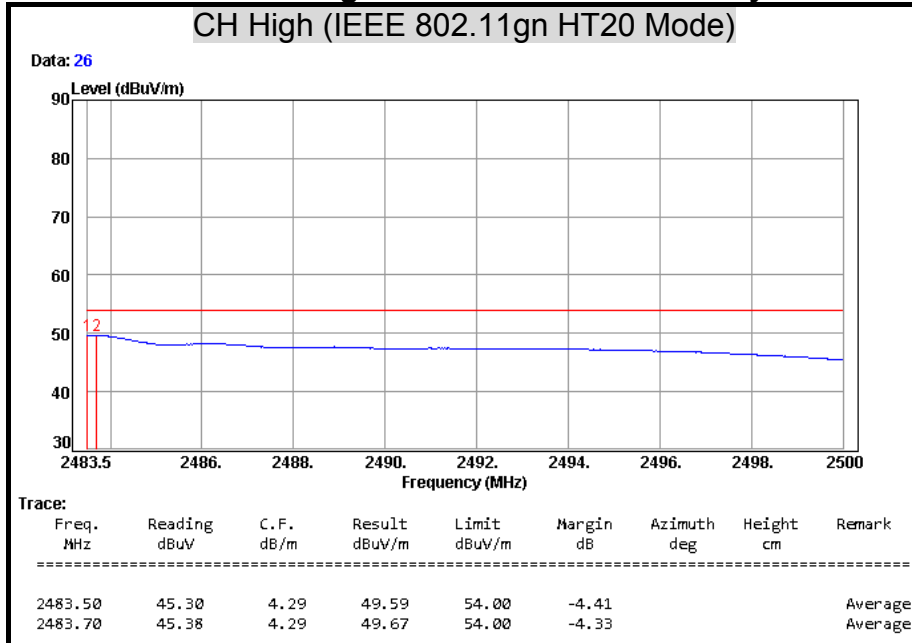



Detector Mode : Peak Polarity : Horizontal

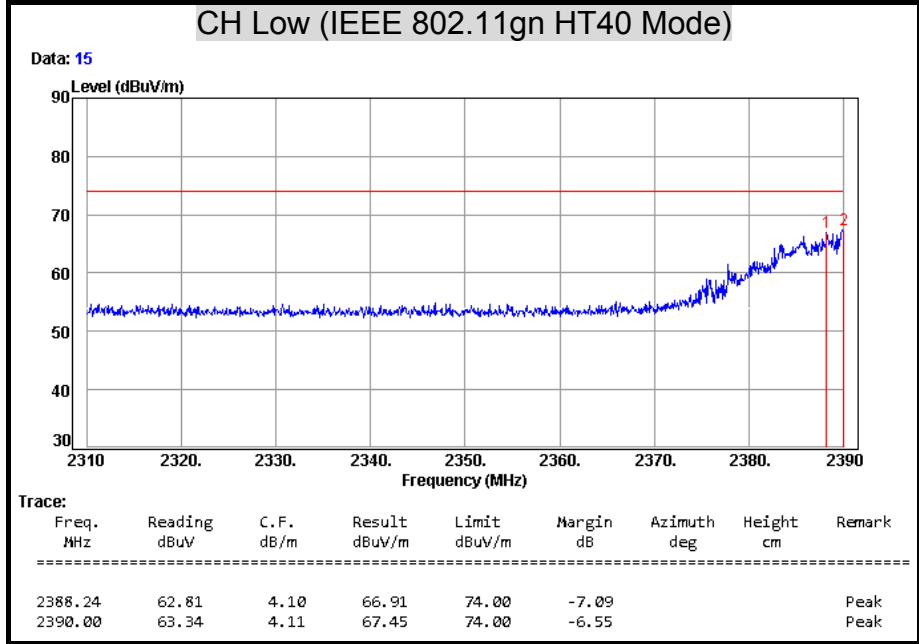

Detector Mode : Average Polarity : Horizontal

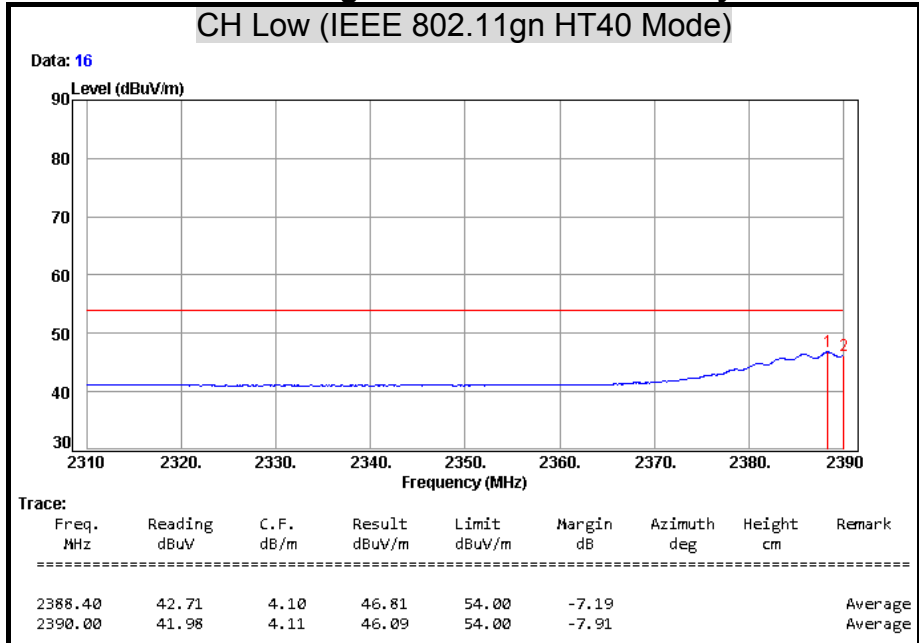



Detector Mode : Peak Polarity : Vertical

CH Low (IEEE 802.11gn HT40 Mode)

Data: 13

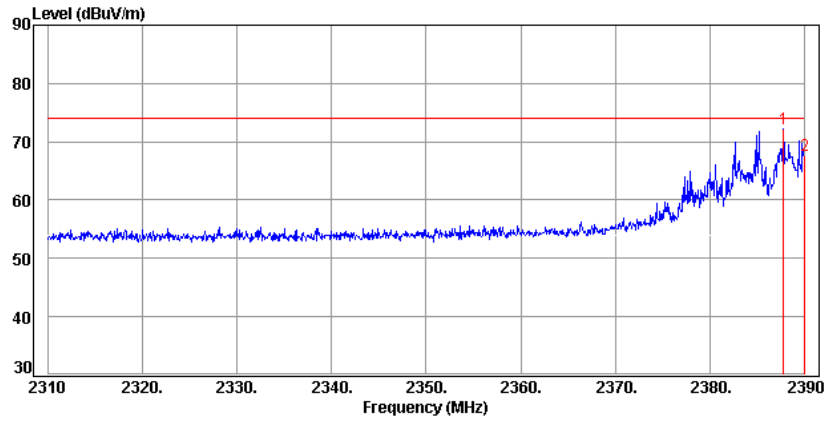

Trace:

Freq. MHz	Reading dBuV	C.F. dB/m	Result dBuV/m	Limit dBuV/m	Margin dB	Azimuth deg	Height cm	Remark
2387.84	68.20	4.10	72.30	74.00	-1.70			Peak
2390.00	63.59	4.11	67.70	74.00	-6.30			Peak

Detector Mode : Average Polarity : Vertical

CH Low (IEEE 802.11gn HT40 Mode)

Data: 14

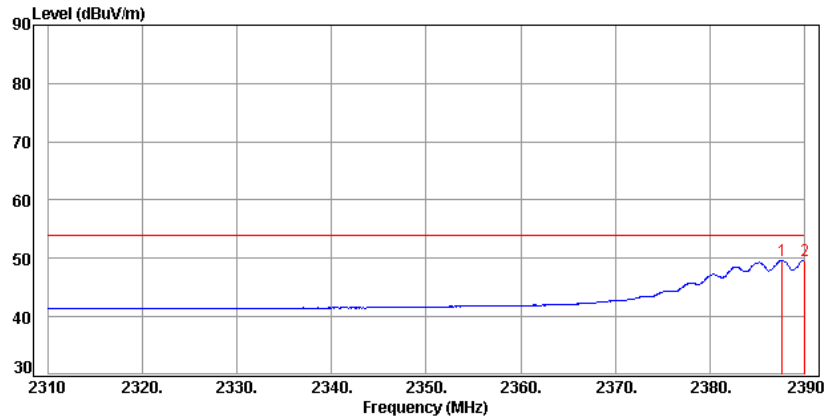

Trace:

Freq. MHz	Reading dBuV	C.F. dB/m	Result dBuV/m	Limit dBuV/m	Margin dB	Azimuth deg	Height cm	Remark
2387.68	45.53	4.10	49.63	54.00	-4.37			Average
2390.00	45.56	4.11	49.67	54.00	-4.33			Average



Detector Mode : Peak Polarity : Horizontal

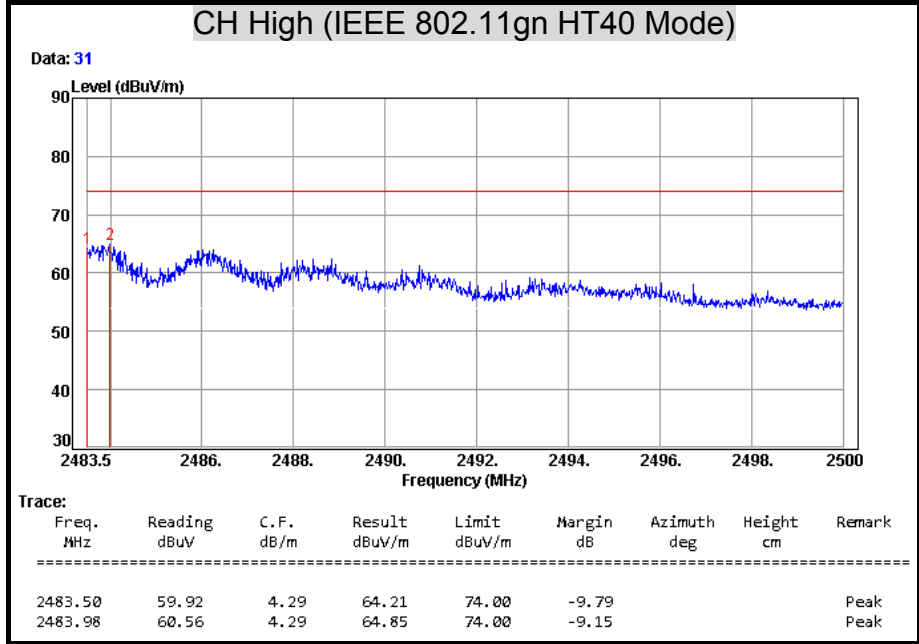

Detector Mode : Average Polarity : Horizontal

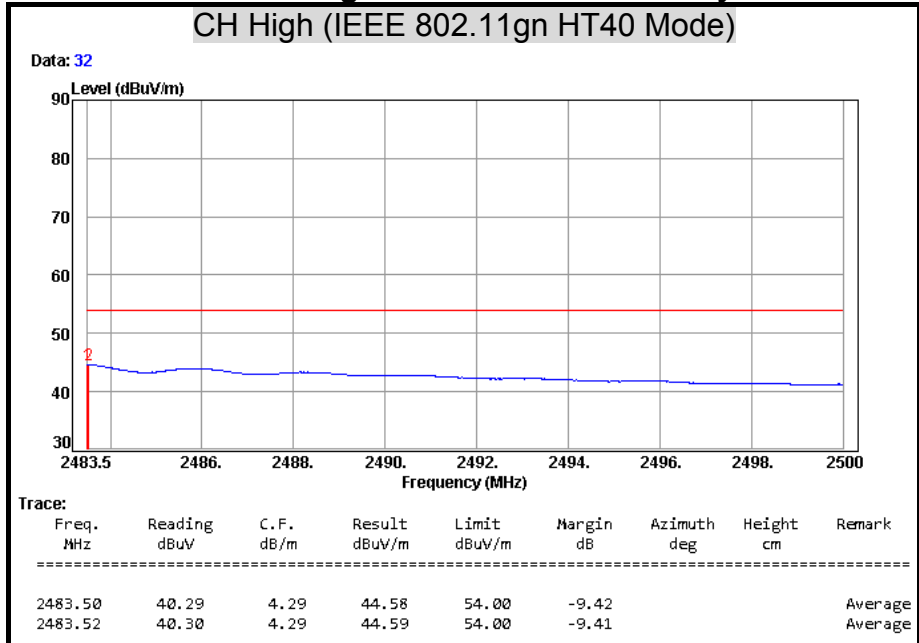



Detector Mode : Peak Polarity : Vertical

CH High (IEEE 802.11gn HT40 Mode)

Data: 29

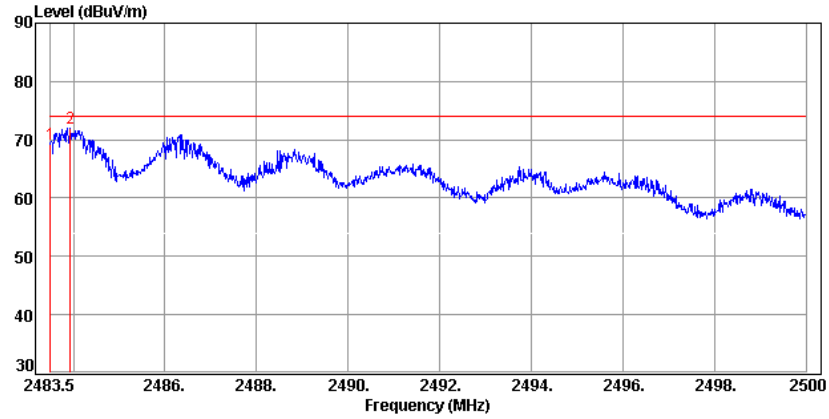

Trace:

Freq. MHz	Reading dBuV	C.F. dB/m	Result dBuV/m	Limit dBuV/m	Margin dB	Azimuth deg	Height cm	Remark
2483.50	64.92	4.29	69.21	74.00	-4.79			Peak
2483.93	67.72	4.29	72.01	74.00	-1.99			Peak

Detector Mode : Average Polarity : Vertical

CH High (IEEE 802.11gn HT40 Mode)

Data: 30

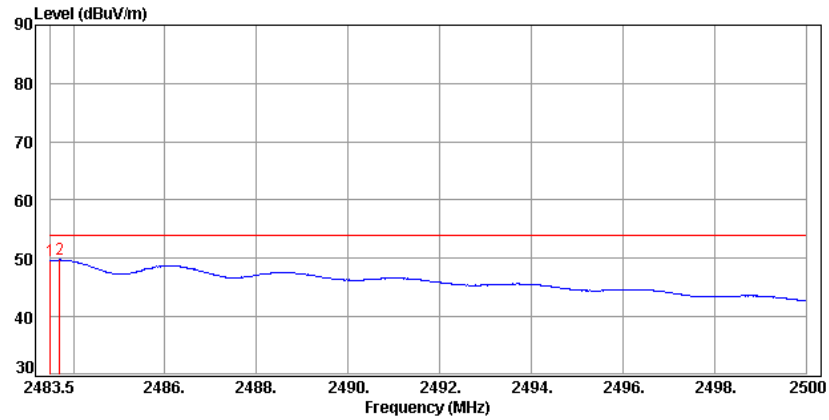

Trace:

Freq. MHz	Reading dBuV	C.F. dB/m	Result dBuV/m	Limit dBuV/m	Margin dB	Azimuth deg	Height cm	Remark
2483.50	45.40	4.29	49.69	54.00	-4.31			Average
2483.70	45.50	4.29	49.79	54.00	-4.21			Average



7.7 CONDUCTED EMISSION

LIMITS

§ 15.207 (a) Except as shown in paragraph (b) and (c) this section, for an intentional radiator that is designed to be connected to the public utility (AC) power line, the radio frequency voltage that is conducted back onto the AC power line on any frequency or frequencies within the band 150 kHz to 30 MHz shall not exceed the limits in the following table, as measured using a 50 μ H/50 ohms line impedance stabilization network (LISN). Compliance with the provisions of this paragraph shall be based on the measurement of the radio frequency voltage between each power line and ground at the power terminal. The lower limit applies at the boundary between the frequency ranges.

Frequency Range (MHz)	Conducted Limit (dB μ v)	
	Quasi-peak	Average
0.15 - 0.50	66 - 56*	56 - 46*
0.50 - 5.00	56	46
5.00 - 30.0	60	50

Remark: * Decreasing linearly with the logarithm of the frequency.

TEST EQUIPMENT

Name of Equipment	Manufacturer	Model	Serial Number	Calibration Due
L.I.S.N	SCHWARZBECK	NSLK 8127	8127465	08/06/2015
L.I.S.N	SCHWARZBECK	NSLK 8127	8127473	03/09/2016
EMI Test Receiver	ROHDE & SCHWARZ	ESHS 30	838550/003	11/02/2015
Pulse Limiter	ROHDE & SCHWARZ	ESH3-Z2	100111	06/30/2015

Remark: Each piece of equipment is scheduled for calibration once a year.



TEST SETUP

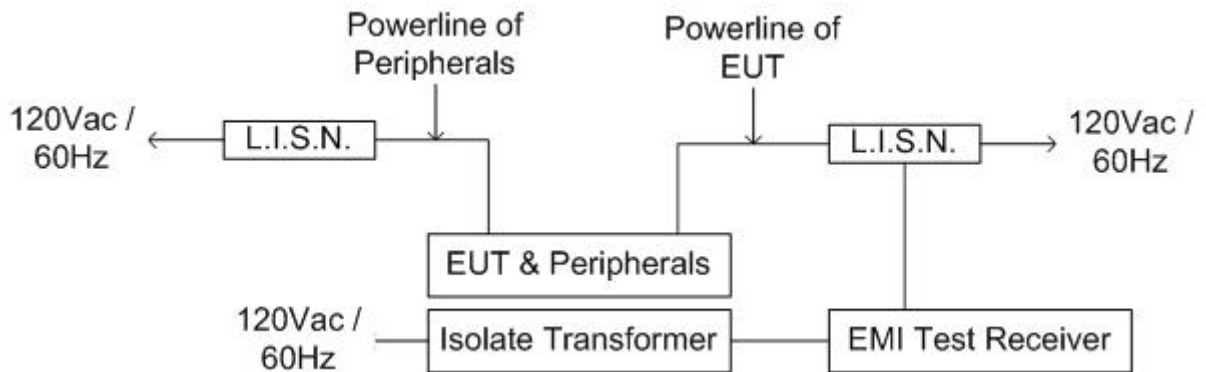
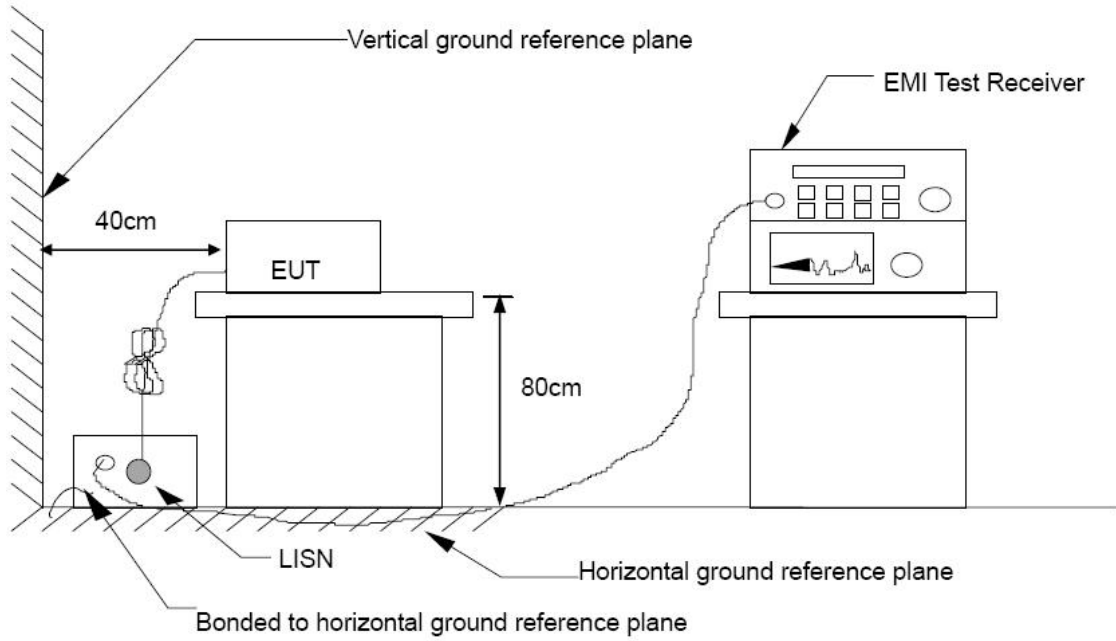



TEST PROCEDURE

The basic test procedure was in accordance with ANSI C63.10:2013.

The test procedure is performed in a 4m × 3m × 2.4m (L×W×H) shielded room.

The EUT along with its peripherals were placed on a 1.0m (W) × 1.5m (L) and 0.8m in height wooden table and the EUT was adjusted to maintain a 0.4 meter space from a vertical reference plane.

The EUT was connected to power mains through a line impedance stabilization network (LISN) which provides 50 ohm coupling impedance for measuring instrument and the chassis ground was bounded to the horizontal ground plane of shielded room. All peripherals were connected to the second LISN and the chassis ground also bounded to the horizontal ground plane of shielded room.

The EUT was located so that the distance between the boundary of the EUT and the closest surface of the LISN is 0.8 m. Where a mains flexible cord was provided by the manufacturer shall be 1 m long, or if in excess of 1 m, the excess cable was folded back and forth as far as possible so as to form a bundle not exceeding 0.4 m in length.



TEST RESULTS

Product Name	Dual-lines VDSL2/ADSL2+ Wireless-AC 3G/4G LTE VPN Firewall Router	Test By	Jey Li
Test Model	BiPAC 8920AX	Test Date	2015/05/13
Test Mode	Normal Operating	Temp. & Humidity	21.6°C, 48%

LINE

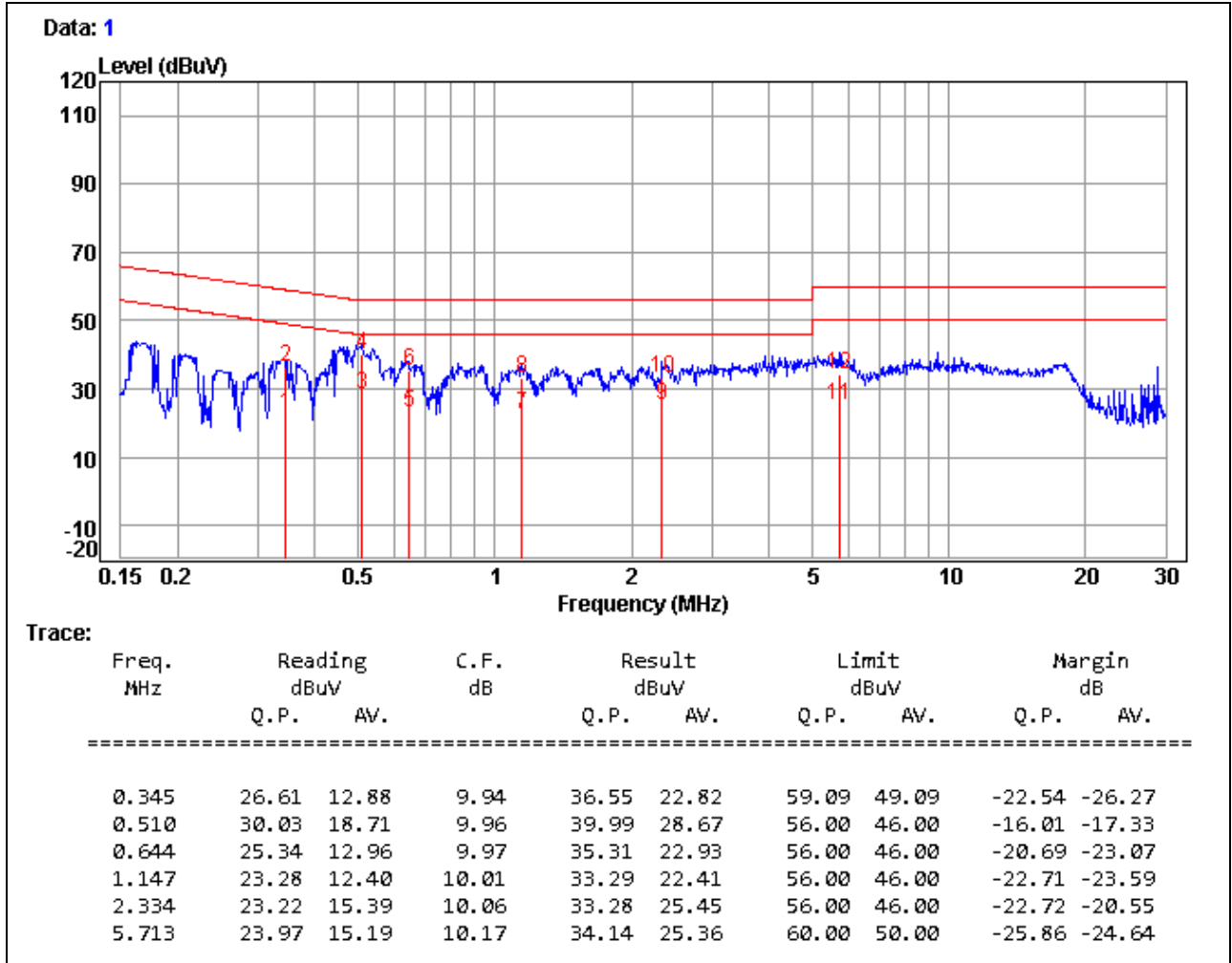

Remark:

1. Correction Factor = Insertion loss + Cable loss
2. Emission level = Reading Value + Correction factor
3. Margin value = Emission level – Limit value



Product Name	Dual-lines VDSL2/ADSL2+ Wireless-AC 3G/4G LTE VPN Firewall Router	Test By	Jey Li
Test Model	BiPAC 8920AX	Test Date	2015/05/13
Test Mode	Normal Operating	Temp. & Humidity	21.6°C, 48%

NEUTRAL

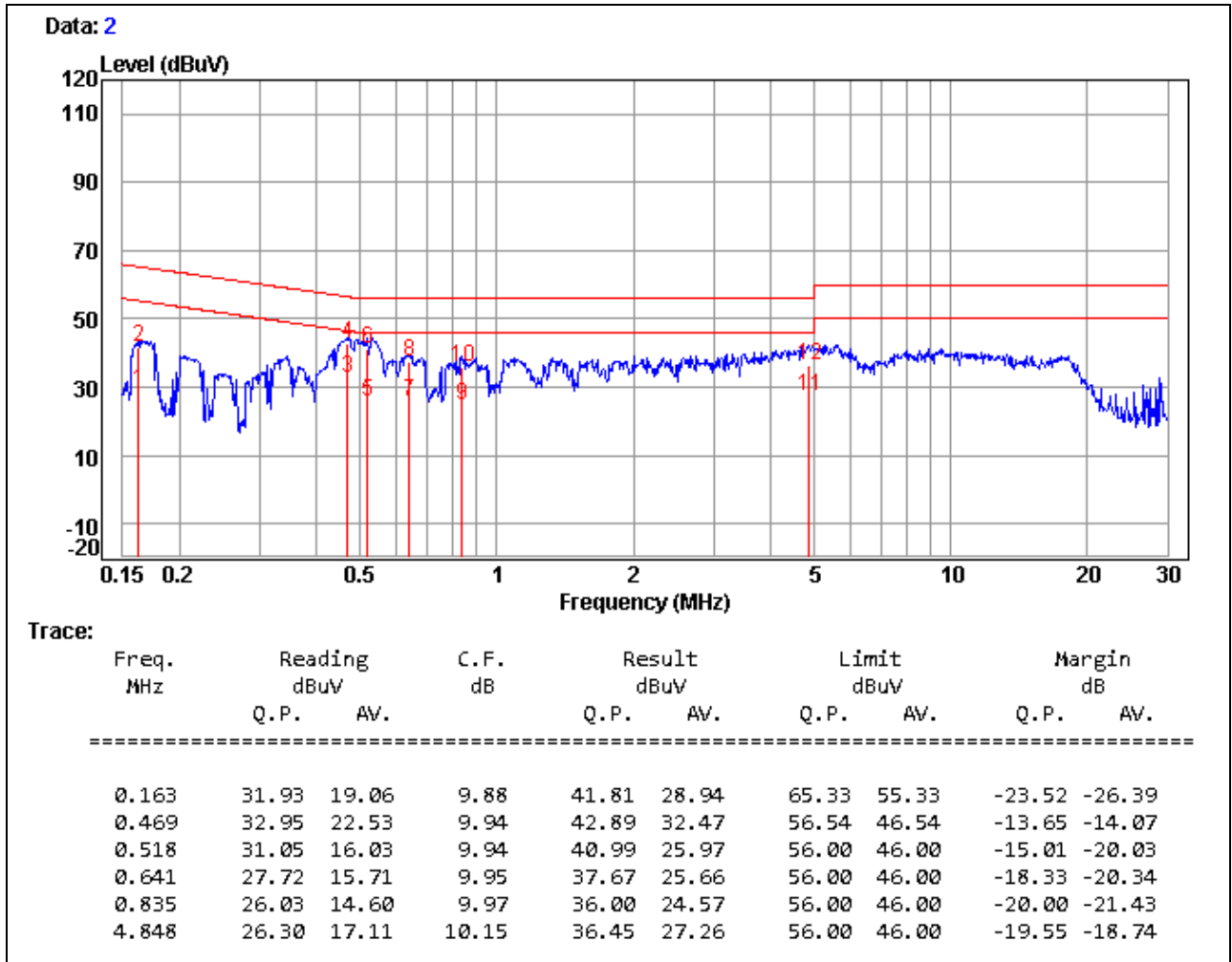

Remark:

1. Correction Factor = Insertion loss + Cable loss
2. Emission level = Reading Value + Correction factor
3. Margin value = Emission level – Limit value



APPENDIX I CO-LOCATION

Above 1 GHz

Product Name	Dual-lines VDSL2/ADSL2+ Wireless-AC 3G/4G LTE VPN Firewall Router	Test By	Jey Li
Test Model	BiPAC 8920AX	Test Date	2015/05/13
Test Mode	Normal Operating	Temp. & Humidity	25°C, 50%

966 Chamber_C at 3Meter / Horizontal

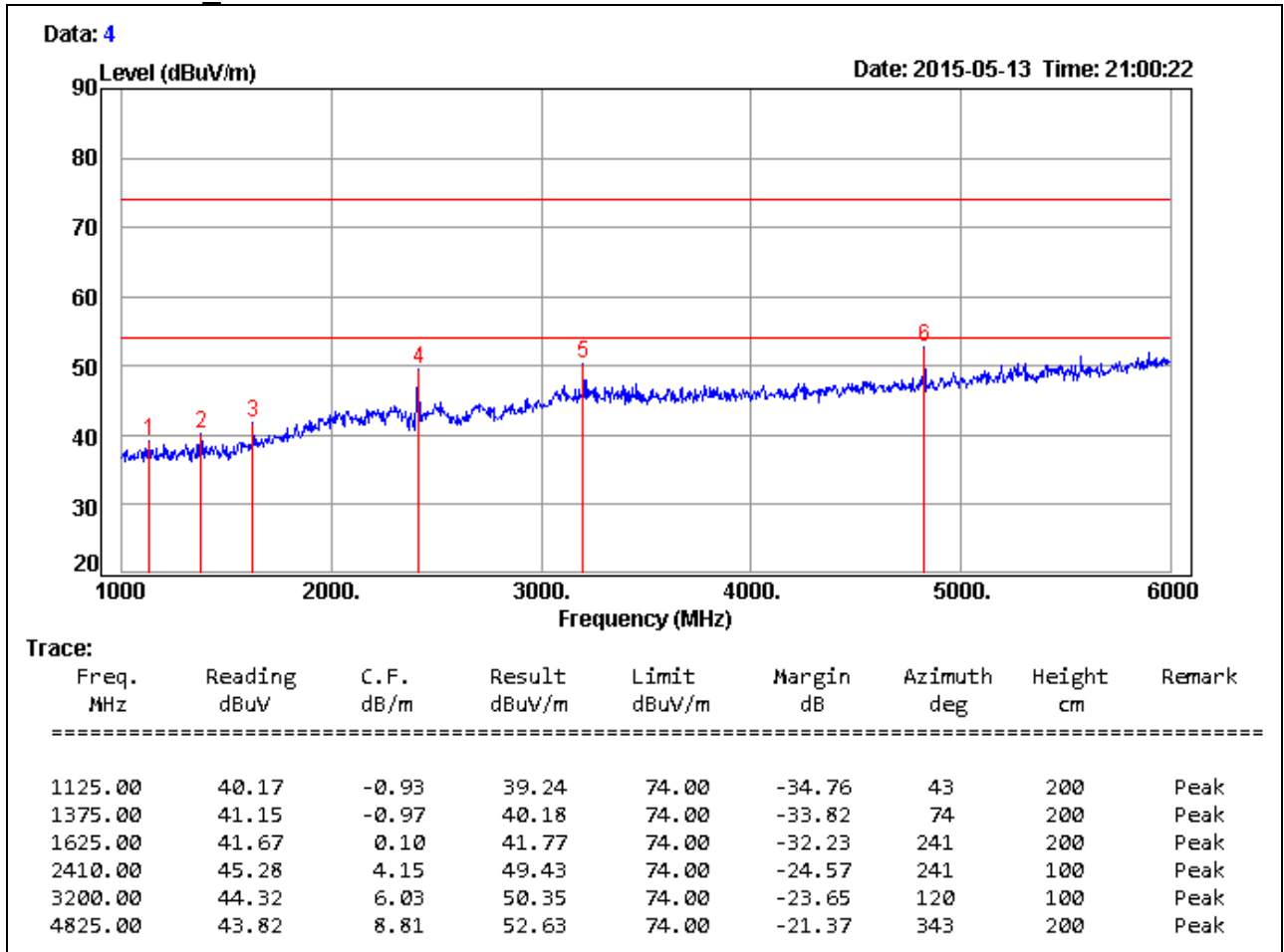

Remark:

1. Average test would be performed if the peak result were greater than the average limit.
2. Measurements above show only up to 6 maximum emissions noted, or would be lesser, with " N/A " remark, if no specific emissions from the EUT are recorded (ie: margin>20dB from the applicable limit) and considered that's already beyond the background noise floor.
3. Result = Reading + Correction Factor
 Margin = Result - Limit
 Remark Peak = Result(PK) - Limit(PK)
 Remark AVG = Result(AV) - Limit(AV)



Product Name	Dual-lines VDSL2/ADSL2+ Wireless-AC 3G/4G LTE VPN Firewall Router	Test By	Jey Li
Test Model	BiPAC 8920AX	Test Date	2015/05/13
Test Mode	Normal Operating	Temp. & Humidity	25°C, 50%

966 Chamber_C at 3Meter / Horizontal

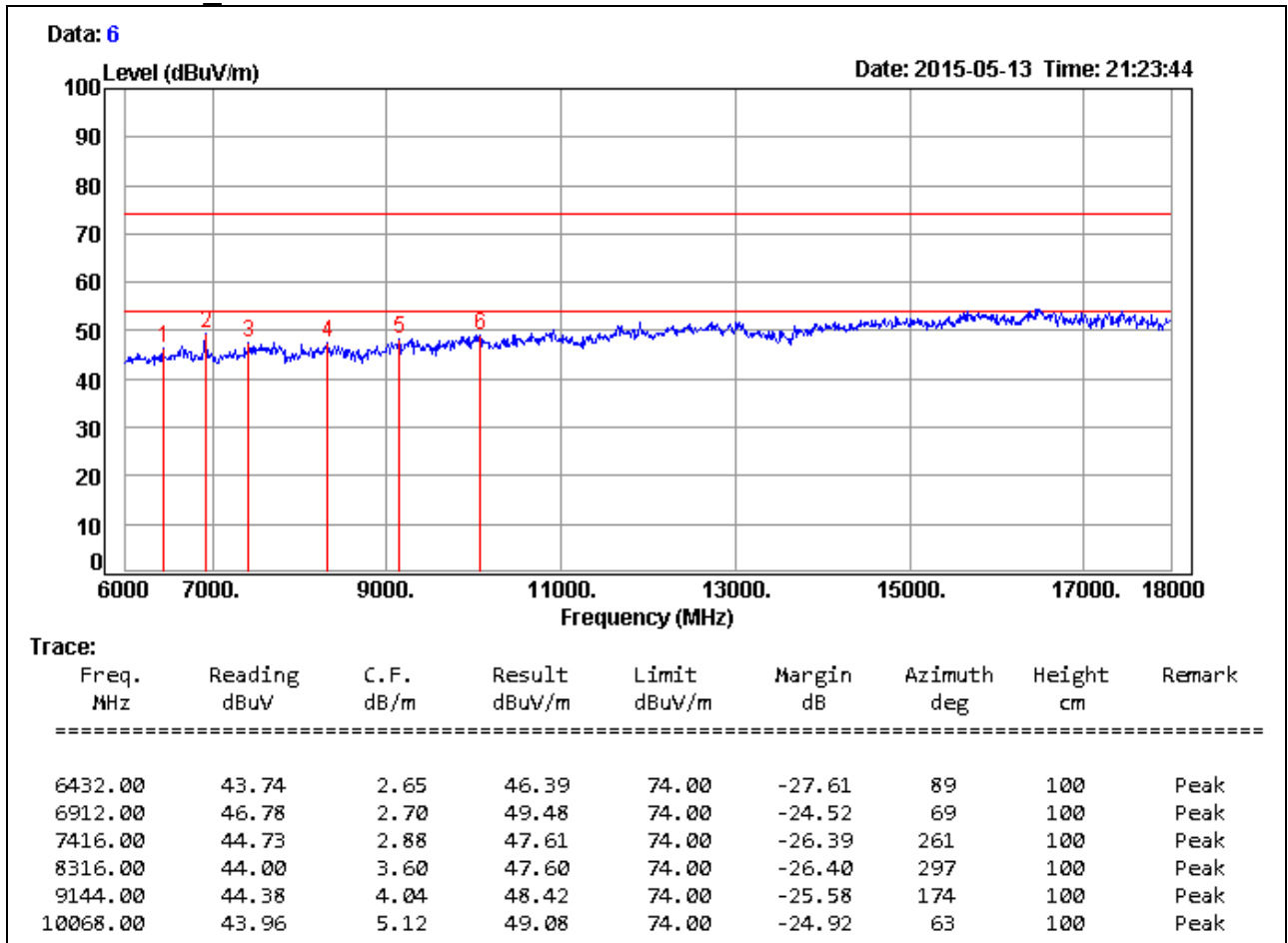

Remark:

- Average test would be performed if the peak result were greater than the average limit.
- Measurements above show only up to 6 maximum emissions noted, or would be lesser, with " N/A " remark, if no specific emissions from the EUT are recorded (ie: margin>20dB from the applicable limit) and considered that's already beyond the background noise floor.
- Result = Reading + Correction Factor
Margin = Result - Limit
Remark Peak = Result(PK) - Limit(PK)
Remark AVG = Result(AV) - Limit(AV)



Product Name	Dual-lines VDSL2/ADSL2+ Wireless-AC 3G/4G LTE VPN Firewall Router	Test By	Jey Li
Test Model	BiPAC 8920AX	Test Date	2015/05/13
Test Mode	Normal Operating	Temp. & Humidity	25°C, 50%

966 Chamber_C at 3Meter / Vertical

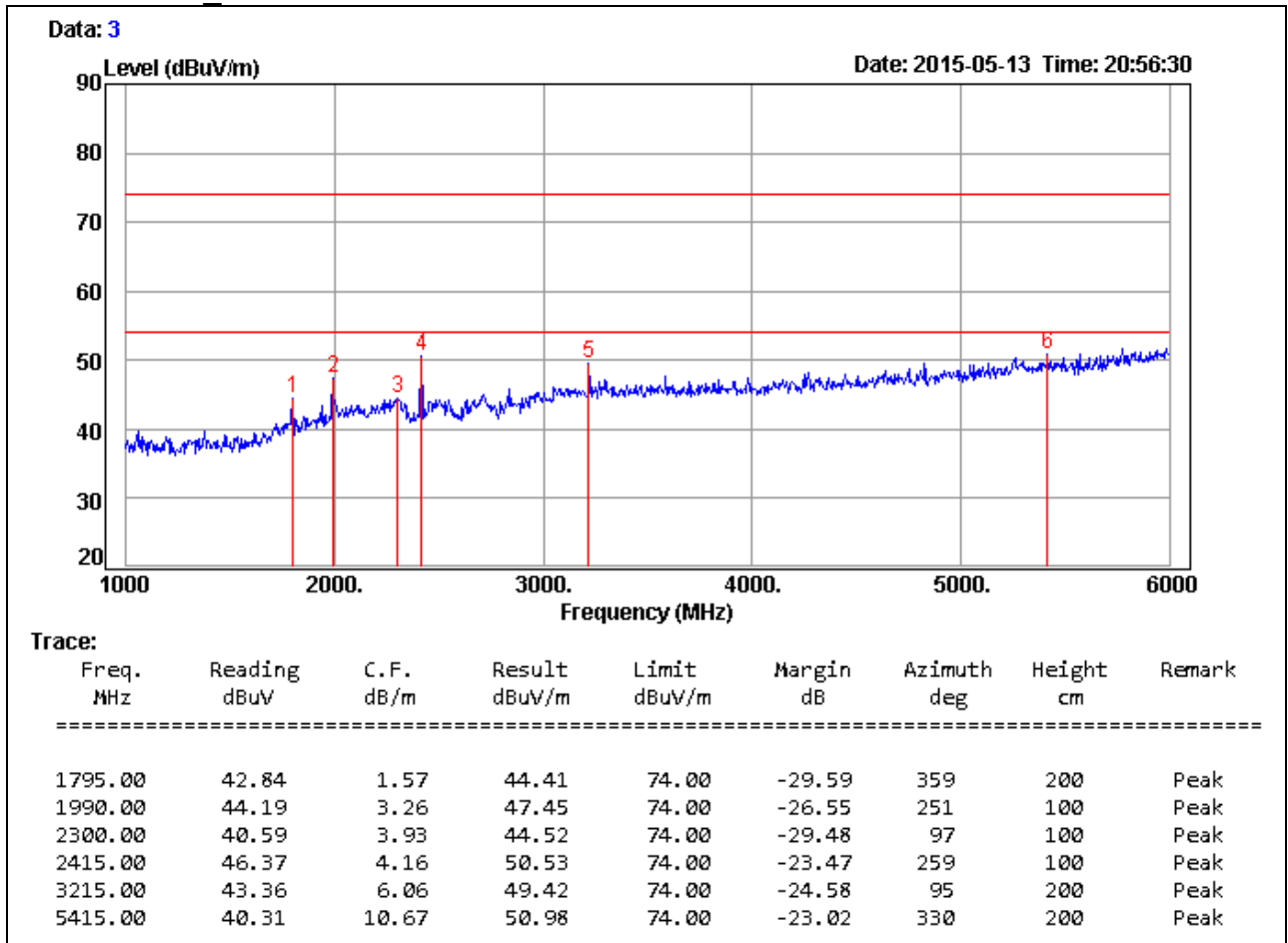

Remark:

- Average test would be performed if the peak result were greater than the average limit.
- Measurements above show only up to 6 maximum emissions noted, or would be lesser, with " N/A " remark, if no specific emissions from the EUT are recorded (ie: margin>20dB from the applicable limit) and considered that's already beyond the background noise floor.
- Result = Reading + Correction Factor
Margin = Result - Limit
Remark Peak = Result(PK) - Limit(PK)
Remark AVG = Result(AV) - Limit(AV)



Product Name	Dual-lines VDSL2/ADSL2+ Wireless-AC 3G/4G LTE VPN Firewall Router	Test By	Jey Li
Test Model	BiPAC 8920AX	Test Date	2015/05/13
Test Mode	Normal Operating	Temp. & Humidity	25°C, 50%

966 Chamber_C at 3Meter / Vertical

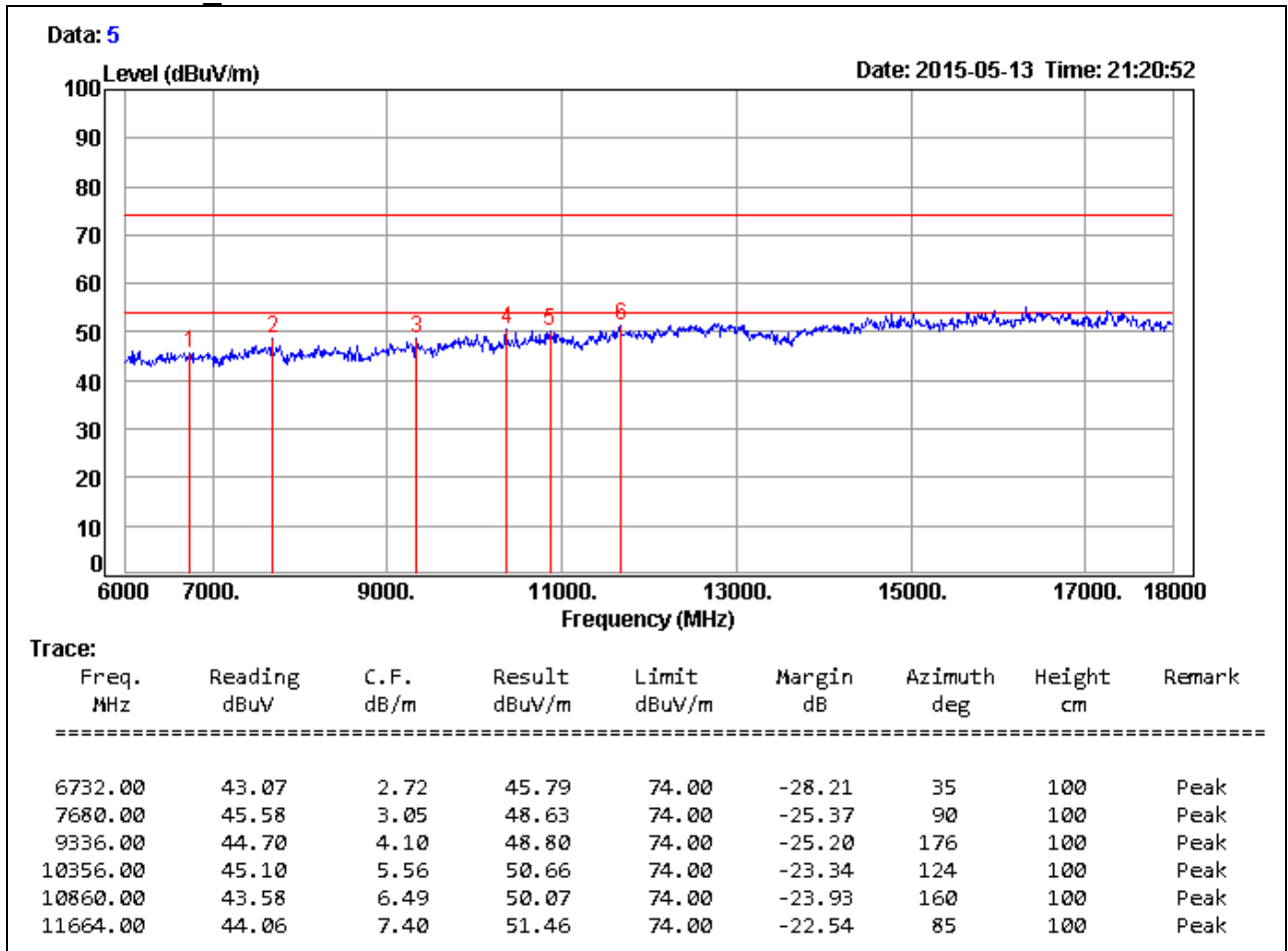

Remark:

1. Average test would be performed if the peak result were greater than the average limit.
2. Measurements above show only up to 6 maximum emissions noted, or would be lesser, with " N/A " remark, if no specific emissions from the EUT are recorded (ie: margin>20dB from the applicable limit) and considered that's already beyond the background noise floor.
3. Result = Reading + Correction Factor
Margin = Result - Limit
Remark Peak = Result(PK) - Limit(PK)
Remark AVG = Result(AV) - Limit(AV)