



PARTS NUMBER REQUEST & APPROVAL SHEET

Powering Communications

1. Part Number:

AAZANF2X202C2H0701

申請單：新增料件
新增經銷商
變更單

2. 製造商：
(Manufacturer)

亞驪

製造商料號：

(Manufacturer P/N)

RFA-02-C2H0-70B-85C

3. 經銷商：
(Supplier)

亞驪

經銷商料號：

(Supplier P/N)

RFA-02-C2H0-70B-85C

4. 種類名稱：
(分群碼)

Antenna

5A. 品名描述(Part Description) :

ANT-F 亞驪 RFA-02-C2H0-70B-85C

5B. 規格描述(Spec.Description) :

2.4GHz 剝鍍 2dBi 85/1.13 HSF



6. 變更原因說明(Change Reason) :

(申請或變更料號請附上規格說明書) 如有任何變更, 須事前聯絡, 取得承認後, 始能變更

7. Series Approval 請勾選(規格請參照 _____ 系列承認書)

8. 樣品發行: BILLION EG-B None

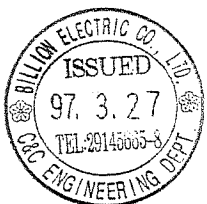
9. 備註(Remark) : 已於5200GR4測試過OK。

DCC 文管中心發行章	主管核准 Manager Signature		審查 Engineer Signature		承辦
	M.E.	E.E.	M.E.	E.E.	
	N/A	<i>Taylor</i> 3/24	N/A	<i>Vincent</i> 2008/3/25	 2008.3.24
	*無須審核者以"N/A"表示 *簽名時應註明日期				

申請日: 2008/3/24

① (Request Date)

楊勝凱

申請者 (Request)

台北實驗室

申請單位(Department)



鍵入者 (Key-in)

由零件工程師填寫

料號申請/零件承認單: 第 1 頁

F-BEC0105-03

亞 驪 企 業 股 份 有 限 公 司
ARISTOTLE ENTERPRISES

承 認 申 請 書

ROHS COMPLIANCE

客戶名稱: 盛達電業股份有限公司
Customer
廠商料號: RFA-02-C2H0-70B-85C
Part No.
品名: WLAN ANTENNA
Description 2.4GHz,BLACK
圖號: RFA-02-C2H0-70B-85C .DWG
Drawing No.
客戶料號:
Drawing No.

出廠簽章:

檢 查 TEST BY	核 對 CHECK BY	承 認 APPROVE BY
周沂珮	黃秋芳	廖煥文

承認簽章:

檢 查 TEST BY	核 對 CHECK BY	承 認 APPROVE BY

地址:台北縣中和市莒光路 63 號 8 樓
電話:02-2225-8209
傳真:02-2225-7523

NO.	NAME	FINISH	MAT'L	Q'TY	MEMO
1.	Hinge	BLACK	ABS	1	
2.	Housing	BLACK	ABS	1	
3.	Cable	BLACK	TEFLON	1	ø1.13
4.	Heat Shrink Tube	BLACK	PE	1	
5.	Core	BLACK	IRON	1	D3.5Xd1.3XL9.0

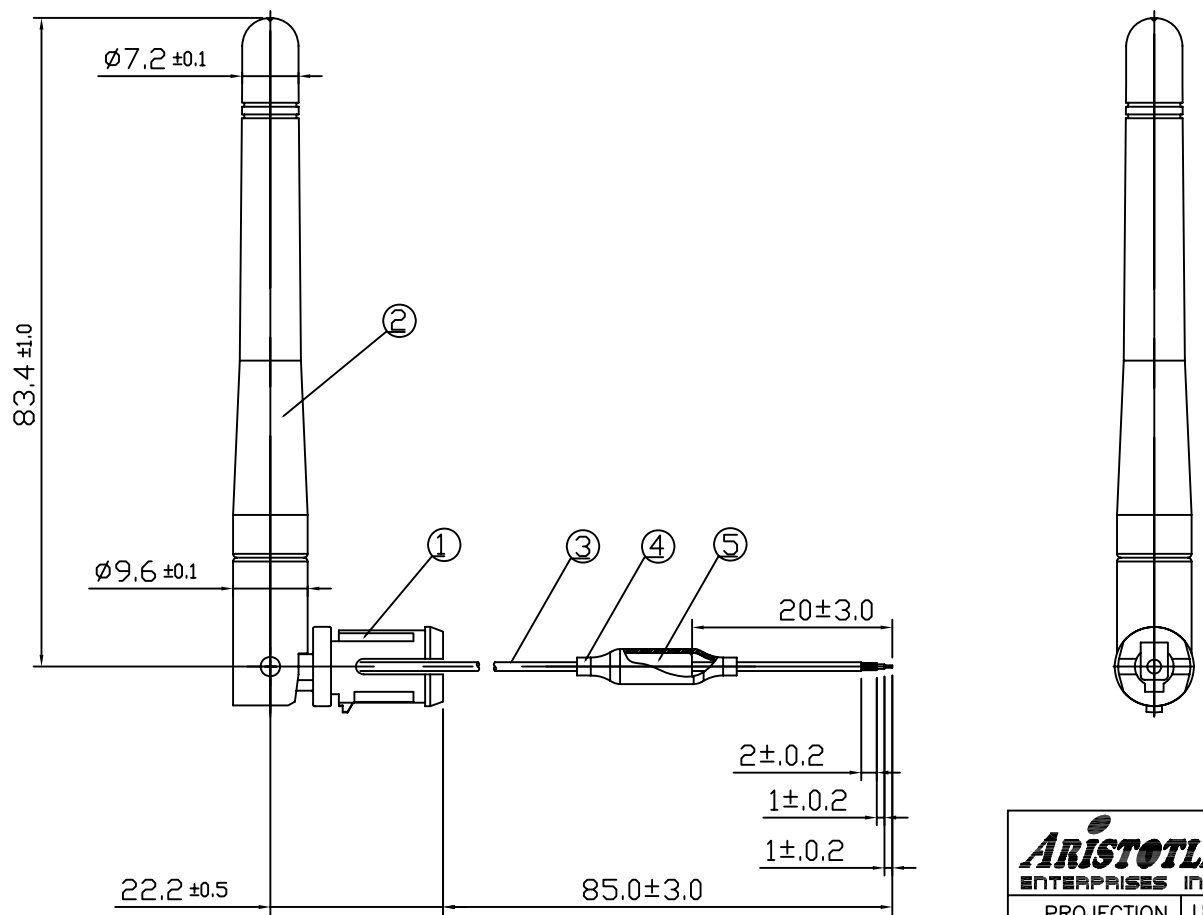

ARISTOTLE 亞驥企業股份有限公司
ENTERPRISES INC.

4.										
3.										
2.										
1.	修改為平轉軸	J.W.Lee	18/03/05	DESIGN						
REV	ECN	NAME	DATE	DRAW	J.W.Lee	94/10/11				

PROJECTION	UNITS	mm	TITLE
	SCALE	1/1	RFA-02-C2H0-70B-85C
	PAPER	A4	
APPD.			DWG NO.
CHKD			RFA-02-C2H0-70B-85C.DWG
			REV.
			A

DESCRIPTION : Swivel Access Point Antenna

MODEL NO : RFA-02-C2H0-70B-85C

1.1 ELECTRICAL

Frequency Range: 2400~2500 MHZ

Gain: 2.0dBi (min.)

VSWR: ≤ 2

Polarization: Linear, Vertical

Impedance : 50Ω

Connector: IPEX MHF

Cable: ϕ 1.13mm

1.2 MECHANICAL

Condition : Non operating during test.

Material : PCABS(UL94V-0)

Endurance

Number of 90° rotation of the connector : 1000 cycles (min.)

Mandatory : Guaranty of functionalities after test.

Bending: Number of 90° at the hinge parts and bending on one direction with 1 kg force : 1000 cycles

Mandatory : No mechanical damage tolerated. Guaranty of functionalities after test.

Antenna resistance

Tests are applicable to all parts and both sides.

Traction: Traction force applied 3 times on plugs during 15 second : 5 kg

Mandatory : No mechanical damage tolerated. Guaranty of functionalities after test.

1.3 ENVIROMENTAL

Storage

Condition : Non operating during test.

Cold: -40°C during 72h (IEC 68-2-1 standard Ab/Ad test)

Dry heat: +80°C during 96h (IEC 68-2-2 standard Bb/Bd test)

Humidity: +40°C at 95%R.H. during 4 days (IEC 68-2-56 standard Cb test)

Mandatory : No mechanical or visible damage tolerated. Guaranty of functionalities after test.

Operation

Condition : Operating during test.

Cold: -10°C during 48h (IEC 68-2-1 standard Ab/Ad test)

Dry heat: +55°C during 48h (IEC 68-2-2 standard Bb/Bd test)

Composite: -10°C to +55°C 95%R.H 4 cycles(IEC 68-2-30 standard Nb test)

Mandatory : No mechanical or visible damage tolerated. Guaranty of functionalities during and after test.

ANTENNA RADIATION PATTERN

11b dipole Antenna Radiation pattern : E-Plane

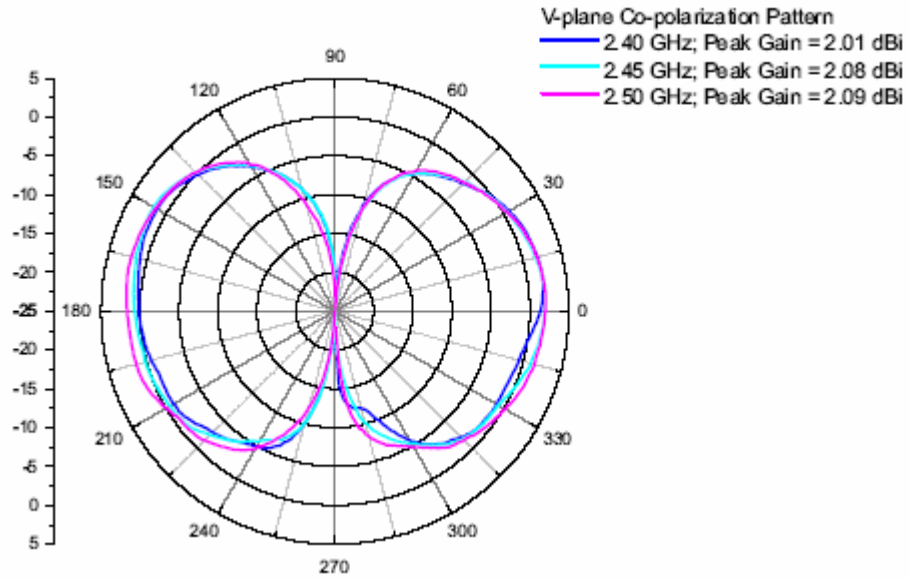

11b dipole Antenna Radiation pattern : H-Plane

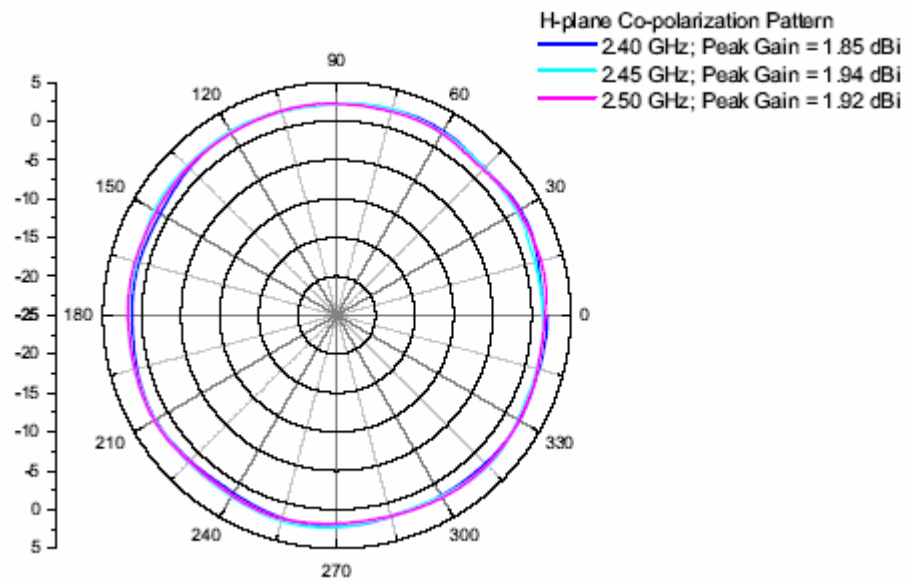

S11 FORWARD REFLECTION
CHN1

TRANSMISSION/REFLECTION

LOG MAGNITUDE

REF=-10.000 dB

10.000 dB/DIV

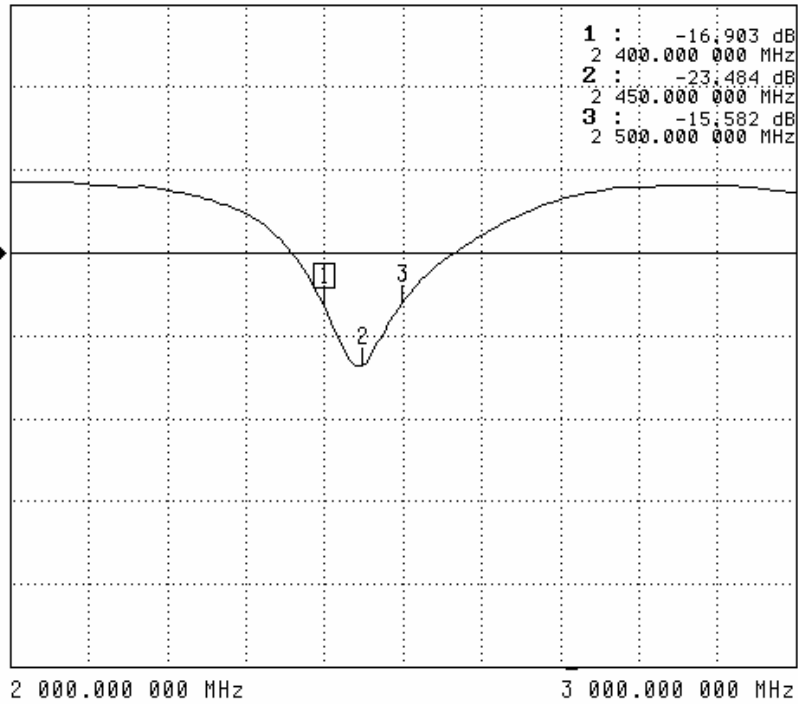

TRACE MEMORY
CHANNEL 1

VIEW
DATA

MEMORY

DATA AND MEMORY

DATA (/) MEMORY

SELECT TRACE MATH

STORE DATA TO
MEMORY
(STORED)

DISK
OPERATIONS

RETURN

STORED DATA
IS INVALID



CHI MEI CORPORATION

59-1 SAN CHIA, JEN TE, TAINAN COUNTY, TAIWAN R.O.C. TEL: 886-6-266-5000, FAX: 886-6-266-5555-7

泛用級 ABS, POLYLAC[®] PA-757

V1W

材料特性

特性(Properties)	測試方法(Test Method)	測試條件(Test Condition)	單位(Unit)	PA-757
引張強度 Tensile Strength	ASTM D638	1/8", 6 mm/min	Kg/cm ² (lb/in ²)	480(6800)
延伸率 Tensile Elongation	ASTM D638	1/8", 6 mm/min	%	20
彎曲強度 Flexural Strength	ASTM D790	1/4", 2.8 mm/min	Kg/cm ² (lb/in ²)	820(11660)
彎曲彈性率 Flexural Modulus	ASTM D790	1/4", 2.8 mm/min	Kg/cm ² (lb/in ²)	27000(380000)
IZOD 衝擊強度 Izod Impact Strength	ASTM D256(Notched)	1/4", 23°C 1/8", 23°C	Kg-cm/cm(ft-lb/in) Kg-cm/cm(ft-lb/in)	18(3.3) 20(3.7)
流動係數 Melt Flow Index	ASTM D1238	200°C, 5Kg	g/10min	1.8
硬度 Hardness	ASTM D785	1/2"	R Scale	116
比重 Specific Gravity	ASTM D792	23°C	-	1.05
軟化點 Vicat Softening Temp	ASTM D1525	1/8", 50°C/hr	°C (°F)	105(221)
熱變形溫度 H.D.T Annealed(85°C, 8hr) Unannealed	ASTM D648	1/4", 120°C/hr	°C (°F)	99(210) 88(190)
燃燒率 Flammability	UL 94	-	-	1/16"HB

以上數據僅代表一般通用數據，不代表每一產品的規格值

若有任何疑問請洽產品推廣課 06-2665000, 06-2663000



奇美實業股份有限公司

台灣省台南縣仁德鄉三甲村59-1號。電話：886-6-266-5000，傳真：886-6-266-5555~7

1/2(A-GHE)

物質安全資料表

VIW

1. 物品及廠商資料

產品名稱	Polylac ®	PA-707	PA-757	PA-757N	PA-717C	PA-727	PA-747	PA-709
製造商	奇美實業股份有限公司							
地址	台灣省台南縣仁德鄉三甲村 59-1 號							
電話	886-6-2663000		Ext. 1361 (產品推廣課)					
緊急電話	886-6-2663000		Ext. 1361 (產品推廣課)					
傳真電話	886-6-2667981							

2. 成品辨識資料

單一產品或混合物	單一產品
化學名稱	Acrylonitrile-Butadiene-Styrene Copolymer
含量	>98% (添加劑≤2%)
化學式	(C ₃ H ₃ N, C ₄ H ₆ , C ₈ H ₈) _x
CAS No.	9003-56-9
危害性不純物	無

3. 危害性分類

健康危害效應	無
環境影響	無
物理性及化學性危害	無
特殊危害	無

4. 急救措施

吸入	若吸入熔融樹脂逸出之氣體，將患者移至通風處，立即送醫。
皮膚接觸	若接觸到塑膠粒或塑膠粉末，以清水沖洗。 若接觸到熔膠，以大量(肥皂)水沖洗患部及衣物，立即送醫。
眼睛接觸	若接觸到塑膠粒或塑膠粉末，以大量清水至少沖洗 15 分鐘。 若有不適，立即送醫。 若接觸到高溫熔融樹脂逸出之氣體，以大量清水至少沖洗 15 分鐘。 若有不適，立即送醫。
吞食	催吐，以清水漱口，若有不適，立即送醫。

5. 消防措施

適用滅火劑	水、泡沫、乾粉
滅火時可能遭遇之特殊危害	無
特殊滅火程序	移除可燃物
消防人員之特殊防護設備	使用供氧式呼吸防護具

6. 洩漏處理方法

個人應注意事項	若塑膠粒或塑膠粉末殘留於地面上，可能會導致人員滑倒。
環境注意事項	為防止鳥類或魚類由排水系統中攝食，須徹底回收
清理方法	回收或廢棄

7. 安全處置與儲存方法

處置	操作處所須嚴禁煙火，做好整理整頓以避免粉塵累積。為防止塵爆，空氣輸送管路、袋濾器及儲槽須加裝靜電消除裝置，並確實接地。袋濾器之濾材採導電性材質。
儲存	存放於陰涼處所，避免直射陽光、雨淋及急速之溫差。儲存處嚴禁煙火



奇美實業股份有限公司

台灣省台南縣仁德鄉三甲村59-1號. 電話: 886-6-266-5000, 傳真: 886-6-266-5555~7 2/2(A-GHE)

8. 暴露預防措施

容許濃度(TLV)	未定
通風設備	排除粉塵、煙及氣體時使用
個人防護設備	呼吸防護 清洗成型機時使用防毒面具。 手部防護 接觸熔膠時使用皮手套。 眼睛防護 平時使用安全眼鏡，清洗成型機時使用護目鏡

9. 物理及化學性質

物質狀態	米白色膠粒
形狀	粒狀
顏色	米白色
氣味	無
閃火點	404 °C
自燃溫度	466 °C
爆炸界限	45 g/m ³
最小著火能量	3.6 mJ
最大爆炸壓力	7 × 10 ⁵ Pa
最大壓力上升速度	3.2 × 10 ⁷ Pa/S
比重	1.03-1.10
溶解度	無

10. 安定性及反應性

安定性	依一般操作及儲存程序時，安定性佳。
危害性分解物	CO, HCN, AN, SM and NO
燃燒能量	3.53 × 10 ⁷ J/kg (8424 Kcal/kg)

11. 毒性資料

刺激性	分解後之塑膠所產生的煙及蒸氣會刺激眼睛。
-----	----------------------

12. 生態資料

為防止被海洋生物或鳥類攝食，嚴禁丟棄至海洋或水域。

13. 廢棄物處理

適當之焚化爐燃燒或掩埋法。不適當之焚化爐可能會產生有毒氣體如 CO, HCN, AN and SM.

14. 運送資料

未分類

15. 法規資料

無

16. 其他資料

無

CHI MEI CORPORATION

59-1 SAN CHIA JEN TE TAINAN HSIEN TAIWAN

Material Designation: PA-757 (+)

Product Description: Acrylonitrile Butadiene Styrene (ABS), designated "Polylac" furnished as pellets.

Color	Min. Thick. (mm)	Flame Class	HWI	HAI	RTI Elec	RTI Imp	RTI Str	IEC GWIT	IEC GWFI
ALL	1.5	HB	4	0	85	80	85	-	-
	3.0	HB	3	0	85	80	85	-	-
CTI: 0	IEC CTI: -	HVTR: 1			D495: 1			IEC Ball Pressure (°C): -	
Dielectric Strength (kV/mm): -		Volume Resistivity (10⁹ohm-cm): -			Dimensional Stability(%): -		ISO Heat Deflection (°C): -		
ISO Tensile Strength (MPa): -		ISO Flexural Strength (MPa): -			ISO Izod Impact (kJ/m²): -		ISO Charpy Impact (kJ/m²): -		
ISO Tensile Impact (kJ/m²): -									

(+) Optional prefix or suffix may be used to denote 0-0.5% acid scavengers.

Report Date: 6/23/1983

Underwriters Laboratories Inc®

UL94 small-scale test data does not pertain to building materials, furnishings and related contents. UL 94 small-scale test data is intended solely for determining the flammability of plastic materials used in components and parts of end-product devices and appliances, where the acceptability of the combination is determined by ULI.



CHI MEI CORPORATION

59-1 SAN CHIA, JEN TE, TAINAN COUNTY, TAIWAN R.O.C.

TEL: 886-6-266-5000,

FAX: 886-6-266-5617

Data issued: May 25, 2005

We hereby certify that the follow Polylac ABS resin (list as follow) produced by Chi Mei Corporation

GP-Grade	PA-707, PA-757, PA-717C, PA-727, PA-747, PA-709,
HF-Grade	PA-756, PA-756S, PA-756H, PA-756B, PA-716, PA-746, PA-746H, PA-737
Extrusion Grade	PA-747F, PA-747R, PA-747S, PA-709S
HH-Grade	PA-777B, PA-777D, PA-777E
Transparent Grade	PA-758

conforms to the requirement that no chemicals as following are added.

1. PBBEs (Poly Bromo Bisphenyl Ethers)
2. PBBs (Poly Bromo Bisphenyls)
3. Ozone Depleting Chemicals(CFC's&HCFC'S)
4. Chlorinated Paraffin (C10-C13)
5. Polyvinyl Chloride (PVC)
6. Mercury(Hg) and its compounds,
7. Lead(Pb) and its compounds,
8. Cadmium(Cd) and its compounds,
9. Chromium(Cr) and its compounds,
10. Arsenic(As) and its compounds,
11. Antimony(Sb) and its compounds,
12. Selenium(Se) and its compounds,
13. Barium(Ba) and its compounds,
14. Chromium(Cr) VI and its compounds
15. Organic tin compounds
16. Polychlorinated Biphenyls(PCB's) and Terphenyls(PCT's)
17. Poly naphthalenes
18. Azo compounds
19. Polychlorinated biphenyl
20. Polychlorinated naphthalene
21. Asbestos
22. Phthalates

With regard to composition of above grade, they can comply with the Directives of RoHS (2002/95/EC), 2003/11/EC , TCO'99, Blue Angel and SONY (SS-00259)

Sincerely Yours,

Eric Chou

Manager

Department of Product Strategy & Service

This statement is based on our current level of knowledge and covers the above resins as supplied by CHI MEI CORPORATION at the date of issue. Since conditions of use are outside CHI MEI CORPORATION's control, CHI MEI CORPORATION makes no warranties, express or implied, and assumes no liability in connection with any use of this information.

Date :

Our Spec. No. WS03-M051

MESSRS.

SPECIFICATION
FOR
HIGH FREQUENCY COAXIAL CABLE
" KHCX - 32AWG - SB - TA "

SHOWA ELECTRIC WIRE & CABLE CO., LTD.

TORANOMON

TOKYO JAPAN

James Huang

LANTRRA INDUSTRIAL CO., LTD.
F.14, NO. 92, SHING TEH ROAD,
SAN CHUNG, TAIPEI, TAIWAN
TEL:886-2-8511-1178
FAX:886-2-8511-1179
Email:sales@lanterra.com.tw
www.lanterra.com.tw
www.terraview.com.tw

T. Mori

T. Mori
Manager, Engineering Section
Engineering Dept.
Electronic Wire Business Unit

1. 適用(SCOPE)

本仕様書は電子機器などの内部配線に使用される細径同軸“KHCX-32AWG-SB-TA”の構造と特性について定める。

This specification covers the construction and characteristics of coaxial cable “KHCX-32AWG-SB-TA” for internal wiring of electronic equipment.

2. ケーブル型名の説明 (EXPLANATION OF CABLE TYPE)

KHCX-32AWG-SB-TA

(1) (2) (3)

- (1) ケーブル略称 (Cable Abbreviation)
- (2) 導体サイズ (Conductor Size)
- (3) 外部導体タイプ (Outer Conductor Type)

3. 構造(CONSTRUCTION)

項目 Item		要求特性 Requirement
内部導体 Inner conductor	材質 Material	銀めつき軟銅線 Silver coated annealed copper wire
	構成 Stranding	7/0.08mm
	外径 Diameter	標準 0.24mm Nom. 0.24mm
絶縁体 Insulation	材質 Material	FEP
	色別 Color	自然色 Natural
	厚さ Thickness	標準 0.22mm Nom. 0.22mm
	外径 Diameter	標準 0.68mm Nom. 0.68mm
外部導体 Outer conductor	材質 Material	錫めつき軟銅線 Tinned annealed copper wire braid shield
	構成 Stranding	16/4/0.05 mm
シース Sheath	材質 Material	FEP
	色別 Color	灰・白・黒 Gray・White・Black
	厚さ Thickness	標準 0.10mm Nom. 0.10mm
仕上外径 Overall diameter		標準 1.13mm Nom. 1.13mm
概算質量 Approximate mass		3 kg/km

4. 電気特性(20℃) (ELECTRICAL CHARACTERISTICS at 20 degree)

項目 Item	単位 Unit	要求特性 Requirements
導体抵抗 Conductor Resistance	Ω/km	520 以下 Max. 520
絶縁抵抗 Insulation Resistance	MΩ km	1,500 以上 (DC 500V 1 分間充電後) Min. 1,500 (After charge DC 500V for 1 min.)
耐電圧 Dielectric Strength	V/1min.	AC 1,000
静電容量 Capacitance	pF/m	標準 97 (at 1kHz) Nom. 97 (at 1kHz)
特性インピーダンス Characteristic Impedance	Ω	標準 50 (TDR にて測定) Nom. 50 (at TDR)



図 1. ケーブル構造図

Fig.1. Cable Cross-Section

5. 梱包及び荷札の表示 (PACKING AND MARKING ON TAG)

完成品は運送中及び保管中に損傷を生じぬ荷造りをする。

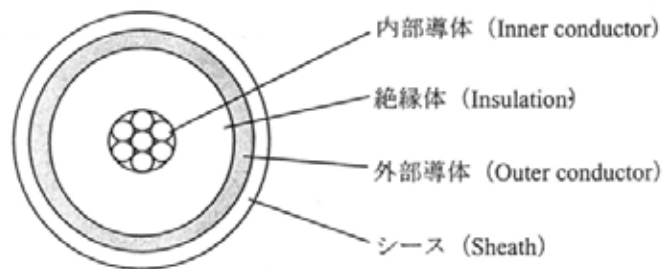
また、荷札の表示は以下の通りとする。

The completed cables shall be coiled and packing in such a manner as to be adequately protected from damage during packing, shipping, and normal handling.

The following items shall be marked in the Tag which is attached to the products.

- 1) 品名 (Type of Cable)
- 2) 導体サイズ (Conductor size)
- 3) 条長 (Length)
- 4) 製造者名または略称 (Manufacturer's name or trade mark)
- 5) 製造年月 (The year and month of manufacture)

なお、完成品にはジョイントを有する場合がある。その場合は条長明細を記載する。

Note : The spool may contain joints. In that case, the detail of length is indicated.

SPECIFICATION

Customer : 亞 驪	Item : B15 RH 3.5x9x1.3	Date : 1,OCT.05
----------------	-------------------------	-----------------

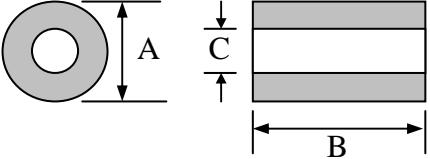
<p>Mechanical Assembly</p> 	<p>Ref. No : K5B RH 3.5x9x1.3</p> <table border="1" style="width: 100%; border-collapse: collapse;"> <tr><td style="width: 10%;">A</td><td style="width: 20%;">3.50</td><td style="width: 70%;">±0.15mm</td></tr> <tr><td>B</td><td>9.00</td><td>±0.30mm</td></tr> <tr><td>C</td><td>1.30</td><td>±0.15mm</td></tr> <tr><td>D</td><td></td><td></td></tr> <tr><td>E</td><td></td><td></td></tr> <tr><td>F</td><td></td><td></td></tr> <tr><td>G</td><td></td><td></td></tr> <tr><td>H</td><td></td><td></td></tr> </table>	A	3.50	±0.15mm	B	9.00	±0.30mm	C	1.30	±0.15mm	D			E			F			G			H		
A	3.50	±0.15mm																							
B	9.00	±0.30mm																							
C	1.30	±0.15mm																							
D																									
E																									
F																									
G																									
H																									

Electrical Requirement			
Impedance	MIN 46	Test Frequency	25 MHz
Impedance	MIN 72	Test Frequency	100 MHz
Impedance		Test Frequency	
Impedance		Test Frequency	

Test equipment : HP E4991A

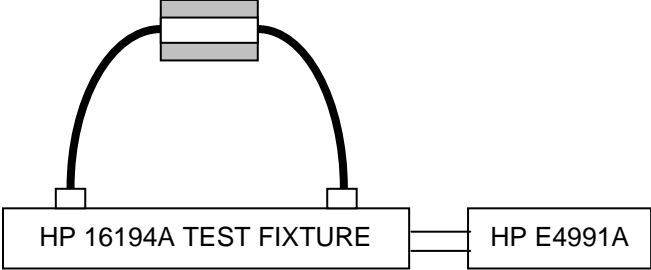
	<p>Wire : TCWφ0.65x63mm</p> <p>Winding : 1 Turn</p> <p>Material : B15 Nickel/Zinc</p>
---	---

REMARK :

Approved by	Checked by	Reported by	Approved by Customer



B & F ELECTRONICS CO., LTD.

INSPECTION DATA

Customer	亞 驪		Date	1-Nov-05		
Item	B15 RH 3.5x9x1.3		Ref. No.	K5B RH 3.5x9x1.3		
Part No.			Test Frequency	1~1000 MHz		
Test equipment	HPE4991A/16194A		Coil Spec.	TCWφ 0.65x63mm at 1 turn		
	Impedance			Dimension (Unit : mm)		
FREQ.		25 MHz	100 MHz	A OD	B HT	C ID
SPEC.		MIN 46Ω	MIN 72Ω	±0.15 3.50	±0.30 9.00	±0.15 1.30
1		82.5	116.4	3.54	9.11	1.39
2		82.9	116.8	3.56	9.05	1.37
3		83.2	117.5	3.55	9.08	1.40
4		82.6	116.9	3.53	9.09	1.36
5		82.2	116.5	3.56	9.03	1.38
6						
7						
8						
9						
10						
X						
R						

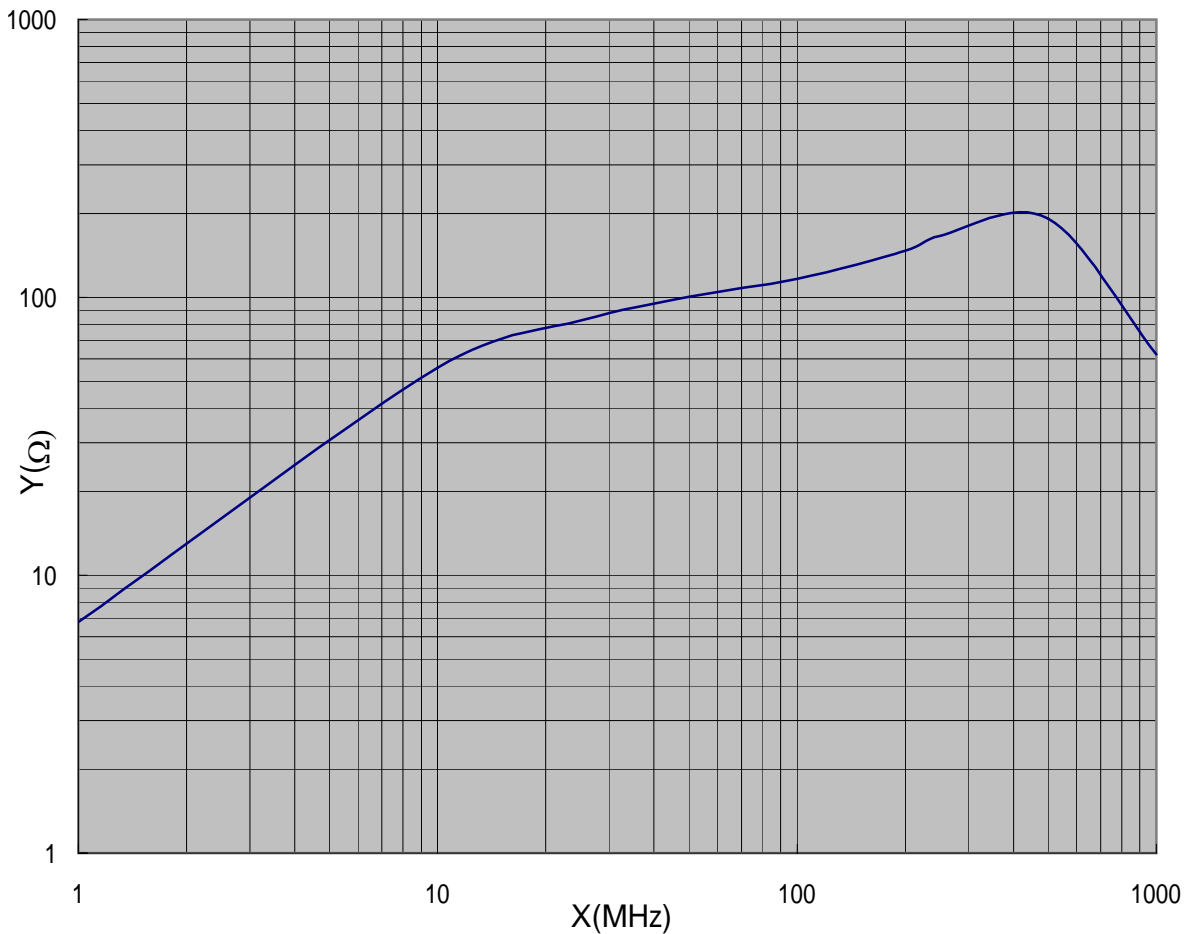

CHARIOT TECHNOLOGY CORP

9F,No7, Lane48, Hsin Ho St, Hsin Tien City,
231Taipei Hsien, Taiwan, ROC
TEL(886)2-2941-9818 FAX(886)2-2941-9722

PRODUCT SPECIFICATION

FEBULARY 16, 2001
1st Edition

1. APPLICABLE SPECIFICATION

- (1) This specification covers the requirements for Flexible Heat-Shrinkable Polyolefin Cross-Link Tubing Class I
- (2) Voltage 150V Temperature 125°C Rating

2. REFERENCE STANDARD

- (1) UL224 : Extruded Insulating Tubing
- (2) CSA C22.2 NO.198.1-99 : Extruded Insulating Tubing

3. SHRIKABLE PROPERTIES

- (1) Radial shrinkage : 50% min.
- (2) Longitudinal shrinkage : -10% max.
- (3) Minimum shrink temperature : 90°C

4. Product Name

- (1) Heat-Shrinkable Tubing LHS-125FR-4

5. STANDARD SIZE

Nominal Size (mm)	Size as supplies (mm)		Size as recovered (mm)		Standard Length (M)
	Inside Diameter	Wall Thickness	Maximum Inside Dimeter	Minimum Wall Thickness	
0.8 X 0.1	1.25 ± 0.15	0.10	0.40	0.20	200
1.0 X 0.1	1.4 ± 0.2	0.10	0.50	0.20	200
1.5 X 0.1	1.9 ± 0.2	0.10	0.75	0.20	200
2.0 X .01	2.4 ± 0.2	0.10	1.00	0.20	200
2.5 X 0.15	2.9 ± 0.2	0.15	1.25	0.25	200
3.0 X 0.15	3.4 ± 0.2	0.15	1.50	0.25	200
3.5 X 0.15	3.9 ± 0.3	0.15	1.75	0.25	200
4.0 X 0.15	4.4 ± 0.3	0.15	2.00	0.25	200
5.0 X 0.15	5.4 ± 0.3	0.15	2.50	0.25	100
6.0 X 0.15	6.5 ± 0.4	0.15	3.00	0.28	100
7.0 X 0.15	7.5 ± 0.4	0.15	3.50	0.28	100
8.0 X 0.15	8.5 ± 0.4	0.15	4.00	0.28	100
9.0 X 0.15	9.5 ± 0.4	0.15	4.50	0.28	100
10.0 X 0.15	10.5 ± 0.4	0.15	5.00	0.28	100

6. CHARACTERISTICS

Property	Test Condition	Values
Specific gravity		1.31
Tensile strength		1.05kg/mm ²
Elongation		200% min.
Tensile strength after aging	158°C x 7days	Retains min.70% of original value
Elongation after aging	and	
Flexibility	134°C x 60days	No crack
Deformation	125°C x 1hr	50% max.
Heat shock	136°C x 1hr	No crack
Cold bend	-30°C x 1hr	No crack
Corrosion of bare copper	Aging at 158°C x 7days after humidity conditioned for 1day	No discoloration or corrosion of copper
Copper stability		100% min. elongation
Flammability		Self-extinguish satisfied VW-1
Dielectric withstand		No breakdown for 60 sec. At 2.5kV (AC)
Breakdown voltage		2.5kV (AC) min.
Dielectric withstand after aging	158°C x 7days and 134°C x 60days	No breakdown for 60 sec. At 2.5kV (AC)
breakdown voltage after aging		2.5kV (AC) min. and retains min. 40% of original value
Volumn resistivity		10 ¹⁴ Ω-CM min.

7. MARKING

The following information shall be legible cleanly by durably ink-printed on the surface of the tubing.

- (1) UL FILE NO.
- (2) Manufactue's name
- (3) Flame retardant test class
- (4) Temperature Rating
- (5) Nominal Size of the tubing
- (6) Maximum recovered inside diameter
- (7) Type designnation

(Example)

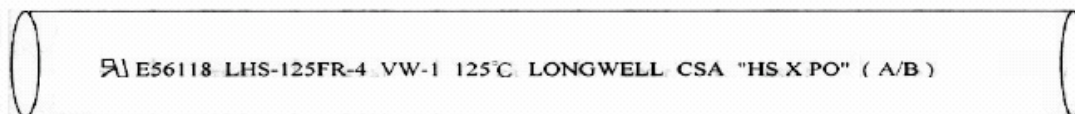

8.PACKING

This standard length given in the Construction table. Other length are available upon special need not to be damaged during transporting and storage.



PT. NEW CROWN METAL WORKS

JL. INDUSTRI 52 (MASUK JL. SUKID CIRACAS - JAKARTA TIMUR 13750) - INDONESIA
 TELP. : 8400374 (HUNTING), 8401589 - 8402531 - 8403604
 FAX : (62-21) 8400895 - 87791167

Report of goods analyzed Internal

2006_002

customer : **SHIN TAY LONG FIVE Metal Product Co., Ltd**

date : 16 September 2002.

kind of goods : BRASS TUBE
 size : 25 mm x 1.5 mm
 product standard : JIS H3300 - C2700 T-O
 net weight : 20,000 Kgs.

Chemical composition	Standard (%)	Tested (%)
<i>62</i> <i>0.01</i> <i>0.02</i> <i>2%</i> Cu	63.0 - 67.0	65.18
Fo	0.05	0.01
Pb	0.05	0.02
Zn	residual	residual
Tensile strength	295	388
Outer diameter	25 mm	25.06 mm
Wall thickness	1.5 mm	1.55 mm



台灣塑膠工業股份有限公司

台北市敦化北路 201 號

FORMOSA PLASTIC CORPORATION

201, TUNG-HWA NORTH ROAD, TAIPEI

TAIWAN, REPUBLIC OF CHINA

TEL: (02)2712-2211 FAX: (02)2718-1230

林園廠：高雄縣林園鄉石化一路一之一號

TEL: (07)641-9911 FAX: (07)642-5581

CERTIFICATION

This is to certify that, according to Yungsox Additive Package and Company laboratory test result,

YUNGSOX 1040F

grade(s) POLYPROPYLENE meet(s) the specification promulgated by the Food and Drug Administration of United States of America (FDA) for olefin polymers in 21 code of Federal Regulation Section 177.1520, and may be safely used in articles or compounds of articles intended for use in contact with food.

Very Truly Yours

H. C. Chang

Polypropylene Division
Technic Dept.



台灣塑膠工業股份有限公司 林園廠
中華民國臺灣省高雄縣林園鄉石化一路一號
FORMOSA PLASTICS CORPORATION
LIN-YUAN PLANT: 1, HSIH-HWA 1ST ROAD,
LIN-YUAN HSIAN, KAOHSIUNG COUNTY,
TAIWAN, R.O.C.

TO WHOM IT MAY CONCERN

Our Ref:TC85003

HEALTH CERTIFICATION

This is to certify that, according to TaisoxTM Additive Package and Company laboratory test result, Taisox 9001, Taisox 9002, Taisox 9003, Taisox 8003, Taisox 8010, Taisox 8050, and Taisox 7200 grades Polyethylene meet the specifications promulgated by the Food and Drug Administration of United States of America (F D A) for olefin polymers in 21 code of Federal Regulation Section 177. 1520, and may be safely used in articles or compounds of articles intended for use in contact with food.

Very Truly Yours

Polyolefin Division
Manager Technical Dept.
Tong Kuen Wu