



**FCC 47 CFR PART 15 SUBPART C AND ANSI C63.10:2009
TEST REPORT**

For

4G/LTE VoIP Wireless-N VPN Broadband Router

Model : BiPAC 6300VNOZ

**Data Applies To : Please refer to section 2
(altogether 11 series models)**

Trade Name : Billion

Issued for

Billion Electric Co., Ltd.

**8F, No.192, Sec. 2, Zhongxing Rd., Xindian Dist.,
New Taipei City 231, Taiwan (R.O.C.)**

Issued by

**Compliance Certification Services Inc.
Hsinchu Lab.**

**NO. 989-1 Wen Shan Rd., Shang Shan Village,
Qionglin Shiang Hsinchu County 30741, Taiwan, R.O.C**

TEL: +886-3-5921698

FAX: +886-3-5921108

<http://www.ccsrf.com>

E-Mail : service@ccsrf.com

Issued Date: April 15, 2015



Note: This report shall not be reproduced except in full, without the written approval of Compliance Certification Services Inc. This document may be altered or revised by Compliance Certification Services Inc. personnel only, and shall be noted in the revision section of the document. The client should not use it to claim product endorsement by TAF or any government agencies. The test results of this report relate only to the tested sample identified in this report.



Revision History

Rev.	Issue Date	Revisions	Effect Page	Revised By
00	04/02/2015	Initial Issue	All Page 121	Michelle Chiu
02	04/15/2015	Revised	All Page 120	Michelle Chiu



TABLE OF CONTENTS

TITLE	PAGE NO.
1. TEST REPORT CERTIFICATION	4
2. EUT DESCRIPTION	5
3. DESCRIPTION OF TEST MODES	7
4. TEST METHODOLOGY	8
5. FACILITIES AND ACCREDITATION	8
5.1 FACILITIES	8
5.2 ACCREDITATIONS.....	8
5.3 MEASUREMENT UNCERTAINTY	9
6. SETUP OF EQUIPMENT UNDER TEST.....	10
7. FCC PART 15.247 REQUIREMENTS	12
7.1 6dB BANDWIDTH	12
7.2 MAXIMUM PEAK OUTPUT POWER	30
7.3 POWER SPECTRAL DENSITY	33
7.4 CONDUCTED SPURIOUS EMISSION	52
7.5 RADIATED EMISSION.....	77
7.6 CONDUCTED EMISSION.....	111
APPENDIX SETUP PHOTOS	118



1. TEST REPORT CERTIFICATION

Applicant : Billion Electric Co., Ltd.
Address : 8F, No.192, Sec. 2, Zhongxing Rd., Xindian Dist.,
 New Taipei City 231, Taiwan (R.O.C.)
Equipment Under Test : 4G/LTE VoIP Wireless-N VPN Broadband Router
Model : BiPAC 6300VNOZ
Data Applies To : Please refer to section 2 (altogether 11 series models)
Trade Name : Billion
Tested Date : December 23, 2014 ~ January 12, 2015

APPLICABLE STANDARD	
Standard	Test Result
FCC Part 15 Subpart C AND ANSI C63.10:2009	PASS

WE HEREBY CERTIFY THAT: The above equipment has been tested by Compliance Certification Services Inc., and found compliance with the requirements set forth in the technical standards mentioned above. The results of testing in this report apply only to the product/system, which was tested. Other similar equipment will not necessarily produce the same results due to production tolerance and measurement uncertainties.

Approved by:

Sb. Lu
Sr. Engineer

Reviewed by:

Gundam Lin
Sr. Engineer

**2. EUT DESCRIPTION**

Product Name	4G/LTE VoIP Wireless-N VPN Broadband Router
Model Number	BiPAC 6300VNOZ
Data Applies To	Please refer to section 2 (altogether 11 series models)
Identify Number	T141023S01
Received Date	October 23, 2014
Frequency Range	IEEE 802.11b/g, 802.11n HT20 : 2412MHz ~ 2462MHz IEEE 802.11n HT40 : 2422MHz ~ 2452MHz
Transmit Power	IEEE 802.11b : 20.45dBm (0.1109W) IEEE 802.11g : 25.61dBm (0.3639W) IEEE 802.11n HT20 : 23.76dBm (0.2374W) IEEE 802.11n HT40 : 25.46dBm (0.3516W)
Channel Spacing	IEEE 802.11b/g, 802.11n HT20/HT40 : 5MHz
Channel Number	IEEE 802.11b/g, 802.11n HT20: 11 Channels IEEE 802.11n HT40 : 7 Channels
Transmit Data Rate	IEEE 802.11b : 11, 5.5, 2, 1 Mbps IEEE 802.11g : 54, 48, 36, 24, 18, 12, 9, 6 Mbps IEEE 802.11n HT20 : 144.4, 130, 117, 115.6, 104, 86.7, 78, 72.2, 65, 58.5, 57.8, 52, 43.3, 39, 28.9, 26, 21.7, 19.5, 14.4, 13, 7.2, 6.5 Mbps IEEE 802.11n HT40 : 300, 270, 243, 240, 216, 180, 162, 150, 135, 121.5, 120, 108, 90, 81, 60, 54, 45, 40.5, 30, 27, 15, 13.5 Mbps
Type of Modulation	IEEE 802.11b : DSSS (CCK, DQPSK, DBPSK) IEEE 802.11g : OFDM (64QAM, 16QAM, QPSK, BPSK) IEEE 802.11n HT20/40 : OFDM (64QAM, 16QAM, QPSK, BPSK)
Antenna Type	PCB Antenna × 2 : Antenna 0 (Chain 0), Antenna Gain 2.36 dBi Antenna 1 (Chain 1), Antenna Gain 2.36 dBi
Power Rating	15Vdc
Test Voltage	120Vac, 60Hz
DC Power Cable Type	Non-shielded cable 1.5m × 1 (Non-detachable)
I/O Port	RJ-45 Port × 4, RJ-11 Port × 2, USB Port × 1, UPS Port × 1, SIM Card Port × 1, Power Port × 1

Power Adapter :

No.	Manufacturer	Model No.	Power Input	Power Output
1	EGB	PAW024A15US	100-240Vac, 0.7A, 50/60Hz	15Vdc, 1.6 A



The difference of the model :

Model Difference Item	BiPAC 6300VNOZ	BiPAC 4500VNOZ	BiPAC 6300VNPZ	BiPAC 4500VNPZ	BEC 6300VNL	RidgeWave 6300VNL
LAN	3	3	3	3	3	3
EWAN	1	1	1	1	1	1
UPS	1	1	1	1	1	1
USB	1	1	1	1	1	1
FXS	2	2	2	2	2	2
SIM	1	1	1	1	1	1
Note	For the marketing purpose.					
Power Adapter	15V/ 1.6A					

Model Difference Item	BiPAC 6300NZ	BiPAC 4500NZ	BiPAC 6300NZL	BiPAC 4500NZL	BEC 6300NEL	RidgeWave 6300NEL
LAN	4	4	4	4	4	4
EWAN	1	1	1	1	1	1
UPS	0	0	0	0	0	0
USB	1	1	1	1	1	1
FXS	0	0	0	0	0	0
SIM	1	1	1	1	1	1
Note	For the marketing purpose.					
Power Adapter	15V/ 1.6A					

Remark :

1. The sample selected for test was engineering sample that approximated to production product and was provided by manufacturer.
2. For more details, please refer to the User's manual of the EUT.
3. The models BiPAC 6300VNOZ was considered the main model for testing.
4. This submittal(s) (test report) is intended for FCC ID:QI3BIL-4500VNOZ filing to comply with Section 15.207, 15.209 and 15.247 of the FCC Part 15, Subpart C Rules.
5. This report is modified from T130814S01-RP1.



3. DESCRIPTION OF TEST MODES

The EUT is an 802.11n MIMO transceiver in 4G/LTE VoIP Wireless-N VPN Broadband Router form factor.

For IEEE 802.11b/g, 802.11n HT20/HT40 mode (2TX / 2RX) :
Chain 0 & Chain 1 transmit/receive.

Conducted Emission / Radiated Emission Test (Below 1 GHz)

1. The following test modes were scanned during the preliminary test:

No.	Pre-Test Mode
1	TX Mode / Power Port
2	TX Mode / UPS Port

2. After the preliminary scan, the following test mode was found to produce the highest emission level.

Final Test Mode		
Emission	Radiated Emission	TX Mode / Power Port
	Conducted Emission	TX Mode / Power Port TX Mode / UPS Port

Remark : Then, the above highest emission mode of the configuration of the EUT and cable was chosen for all final test items.

Conducted / Radiated Emission Test (Above 1 GHz)

IEEE 802.11b, 802.11g, 802.11n HT20 mode

The EUT had been tested under operating condition.

There are three channels have been tested as following :

Channel	Frequency (MHz)
Low	2412
Middle	2437
High	2462

IEEE 802.11b mode : 1Mbps data rate (worst case) were chosen for full testing.

IEEE 802.11g mode : 6Mbps data rate (worst case) were chosen for full testing.

IEEE 802.11n HT20 mode : 13Mbps data rate (worst case) were chosen for full testing.

IEEE 802.11n HT40 mode

The EUT had been tested under operating condition.

There are three channels have been tested as following :

Channel	Frequency (MHz)
Low	2422
Middle	2437
High	2452

IEEE 802.11n HT40 mode : 27Mbps data rate (worst case) were chosen for full testing.



4. TEST METHODOLOGY

The tests documented in this report were performed in accordance with ANSI C63.10:2009 and FCC CFR 47, 15.207, 15.209, 15.247 .

5. FACILITIES AND ACCREDITATION

5.1 FACILITIES

All measurement facilities used to collect the measurement data are located at

NO. 989-1 Wen Shan Rd., Shang Shan Village,
Qionglin Shiang Hsinchu County 30741, Taiwan, R.O.C

The sites are constructed in conformance with the requirements of ANSI C63.10:2009 and CISPR 22. All receiving equipment conforms to CISPR 16-1-1, CISPR 16-1-2, CISPR 16-1-3, CISPR 16-1-4, CISPR 16-1-5.

5.2 ACCREDITATIONS

Our laboratories are accredited and approved by the following approval agencies according to ISO/IEC 17025.

Taiwan	TAF
---------------	-----

The measuring facility of laboratories has been authorized or registered by the following approval agencies.

Canada	INDUSTRY CANADA
Japan	VCCI
Taiwan	BSMI
USA	FCC MRA

Copies of granted accreditation certificates are available for downloading from our web site, <http://www.ccsrf.com>

Remark: FCC Designation Number TW1027.



5.3 MEASUREMENT UNCERTAINTY

The following table is for the measurement uncertainty, which is calculated as per the document CISPR 16-4-2.

PARAMETER	UNCERTAINTY
Semi Anechoic Chamber (966 Chamber_A) / Radiated Emission, 30 to 1000 MHz	+/- 3.59
Semi Anechoic Chamber (966 Chamber_A) / Radiated Emission, 1 to 18GHz	+/- 3.59
Semi Anechoic Chamber (966 Chamber_A) / Radiated Emission, 18 to 26 GHz	+/- 3.59
Semi Anechoic Chamber (966 Chamber_A) / Radiated Emission, 26 to 40 GHz	+/- 3.82
Semi Anechoic Chamber (966 Chamber_B) / Radiated Emission, 30 to 1000 MHz	+/- 3.97
Semi Anechoic Chamber (966 Chamber_B) / Radiated Emission, 1 to 18GHz	+/- 3.58
Semi Anechoic Chamber (966 Chamber_B) / Radiated Emission, 18 to 26 GHz	+/- 3.59
Semi Anechoic Chamber (966 Chamber_B) / Radiated Emission, 26 to 40 GHz	+/- 3.81
Conducted Emission (Mains Terminals), 9kHz to 30MHz	+/- 2.48

This uncertainty represents an expanded uncertainty expressed at approximately the 95% confidence level using a coverage factor of k=2.

Consistent with industry standard (e.g. CISPR 22, clause 11, Measurement Uncertainty) determining compliance with the limits shall be base on the results of the compliance measurement. Consequently the measure emissions being less than the maximum allowed emission result in this be a compliant test or passing test.

The acceptable measurement uncertainty value without requiring revision of the compliance statement is base on conducted and radiated emissions being less than U_{CISPR} which is 3.6dB and 5.2dB respectively. CCS values (called U_{Lab} in CISPR 16-4-2) is less than U_{CISPR} as shown in the table above. Therefore, MU need not be considered for compliance.



6. SETUP OF EQUIPMENT UNDER TEST

SUPPORT EQUIPMENT

No.	Product	Manufacturer	Model No.	Serial No.	FCC ID
1	PC	IBM (Lenovo)	ThinkCentre AG5	L3C8189	DoC

No.	Power & Signal Cable Description
1	Non-shielded RJ-45 cable, 10m × 1

SETUP DIAGRAM FOR TESTS

EUT & peripherals setup diagram is shown in appendix setup photos.

EUT OPERATING CONDITION

RF Mode :

1. EUT & peripherals setup diagram is shown in appendix setup photos.
2. NB set fixed ip, 192.168.1.x
3. In MS-DOS : telnet 192.168.1.254
4. Username : gongdaowuRd
5. Password : 5753268
6. key in brctl delif br0 ra0
7. key in ated
8. Run“Ralink QA Test Program for RT5x9x V1.0.7.3” software was used for testing.

TX Mode:

- ⇒ **Tx Data Rate:** MCS=0; 1Mbps Bandwidth 20 (IEEE 802.11b mode)
MCS=0; 6Mbps Bandwidth 20 (IEEE 802.11g mode)
MCS=8; 13Mbps Bandwidth 20 (IEEE 802.11n HT20 mode)
MCS=8; 27Mbps Bandwidth 40 (IEEE 802.11n HT40 mode)

⇒ **Power control**

- IEEE 802.11b Channel Low (2412MHz) TX Power0/1 14/10
- IEEE 802.11b Channel Mid (2437MHz) TX Power0/1 17/14
- IEEE 802.11b Channel High (2462MHz) TX Power0/1 18/15
- IEEE 802.11g Channel Low (2412MHz) TX Power0/1 16/12
- IEEE 802.11g Channel Mid (2437MHz) TX Power0/1 17/14
- IEEE 802.11g Channel High (2462MHz) TX Power0/1 18/15
- IEEE 802.11n HT20 Channel Low (2412MHz) TX Power0/1 15/11



IEEE 802.11n HT20 Channel Mid (2437MHz) TX Power0/1 14/11
IEEE 802.11n HT20 Channel High (2462MHz) TX Power0/1 17/14
IEEE 802.11n HT40 Channel Low (2422MHz) TX Power0/1 13/0F
IEEE 802.11n HT40 Channel Mid (2437MHz) TX Power0/1 1A/17
IEEE 802.11n HT40 Channel High (2452MHz) TX Power0/1 15/12

9. All of the functions are under run.

10. Start test.



7. FCC PART 15.247 REQUIREMENTS

7.1 6dB BANDWIDTH

LIMITS

§ 15.247(a) (2) For direct sequence systems, the minimum 6dB bandwidth shall be at least 500kHz.

TEST EQUIPMENT

Name of Equipment	Manufacturer	Model	Serial Number	Calibration Due
Spectrum Analyzer	Agilent	E4446A	MY43360132	06/10/2015

Remark: Each piece of equipment is scheduled for calibration once a year.

TEST SETUP



TEST PROCEDURE

1. The transmitter output was connected to a spectrum analyzer.
2. Set RBW = 100 kHz.
3. Set the video bandwidth (VBW) $\geq 3 \times$ RBW.
4. Detector = Peak.
5. Trace mode = max hold.
6. Sweep = auto couple.
7. Allow the trace to stabilize.
8. Measure the maximum width of the emission that is constrained by the frequencies associated with the two outermost amplitude points (upper and lower frequencies) that are attenuated by 6 dB relative to the maximum level measured in the fundamental emission.



TEST RESULTS

IEEE 802.11b Mode (Two TX)

Channel	Channel Frequency (MHz)	6dB Bandwidth (MHz)		Minimum Limit (kHz)	Pass / Fail
		Chain 0	Chain 1		
Low	2412	12.13	12.20	500	PASS
Middle	2437	12.20	12.13	500	PASS
High	2462	12.07	12.20	500	PASS

IEEE 802.11g Mode (Two TX)

Channel	Channel Frequency (MHz)	6dB Bandwidth (MHz)		Minimum Limit (kHz)	Pass / Fail
		Chain 0	Chain 1		
Low	2412	16.60	16.60	500	PASS
Middle	2437	16.67	16.60	500	PASS
High	2462	16.60	16.60	500	PASS

IEEE 802.11n HT20 Mode (Two TX)

Channel	Channel Frequency (MHz)	6dB Bandwidth (MHz)		Minimum Limit (kHz)	Pass / Fail
		Chain 0	Chain 1		
Low	2412	17.73	17.73	500	PASS
Middle	2437	17.73	17.73	500	PASS
High	2462	17.67	17.73	500	PASS

IEEE 802.11n HT40 Mode (Two TX)

Channel	Channel Frequency (MHz)	6dB Bandwidth (MHz)		Minimum Limit (kHz)	Pass / Fail
		Chain 0	Chain 1		
Low	2422	36.58	36.50	500	PASS
Middle	2437	36.58	36.50	500	PASS
High	2452	36.58	36.42	500	PASS



6dB BANDWIDTH

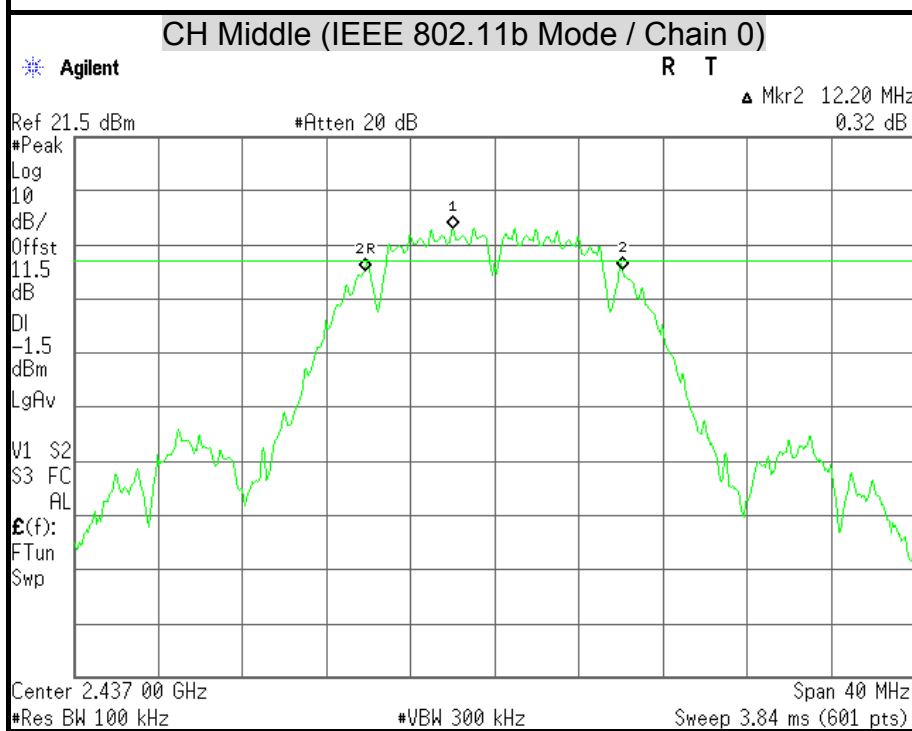
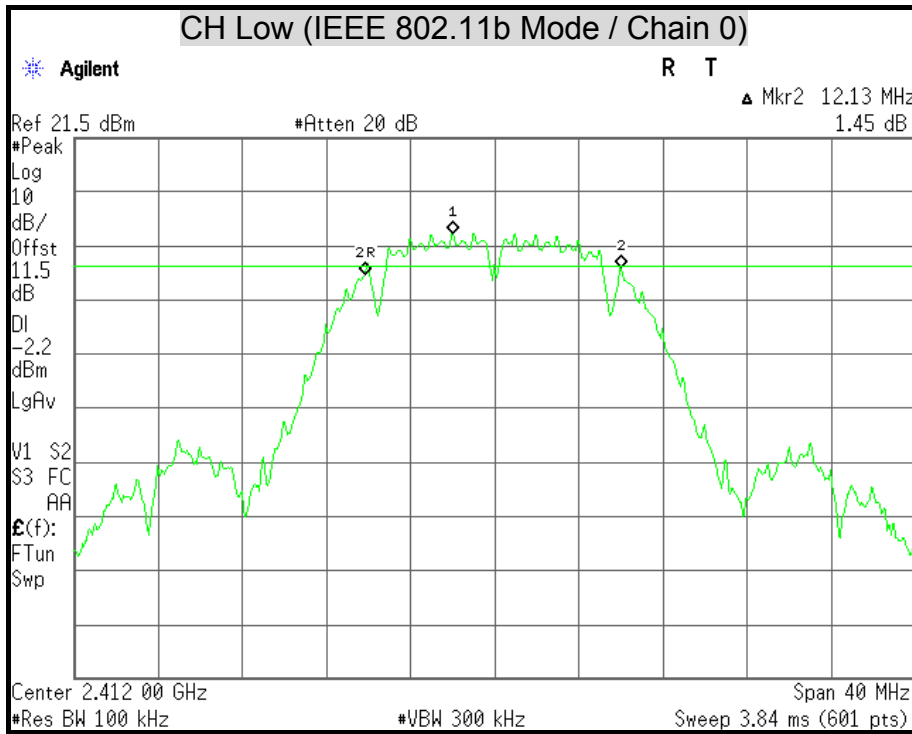

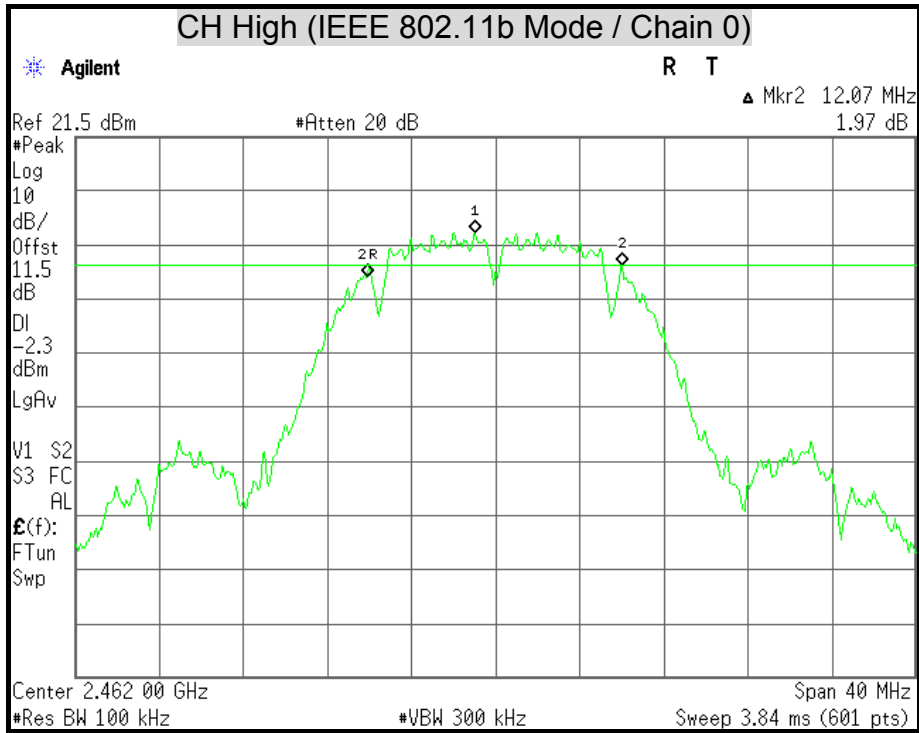

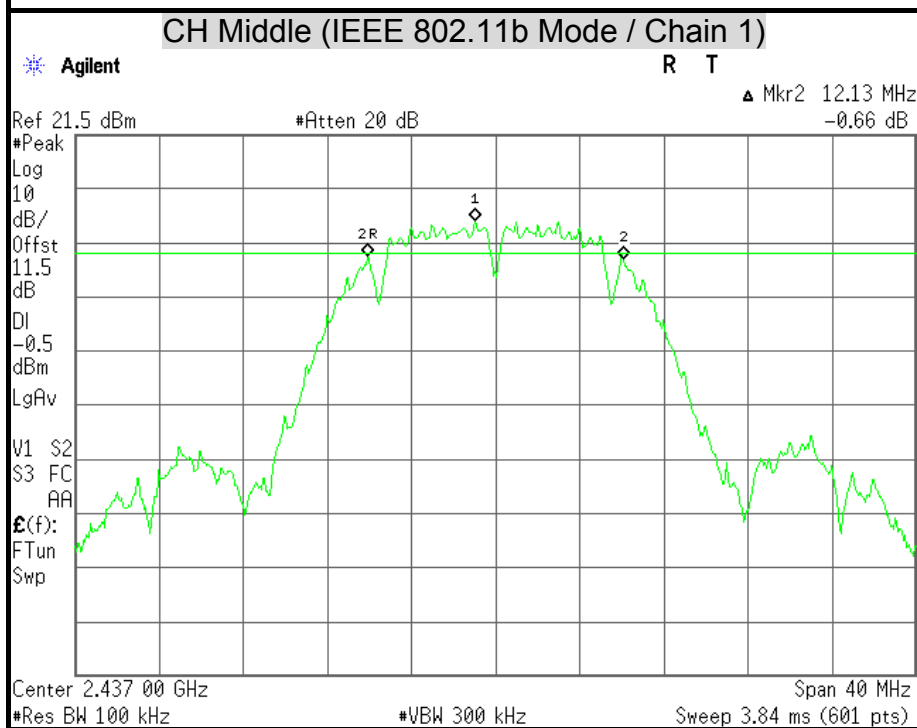
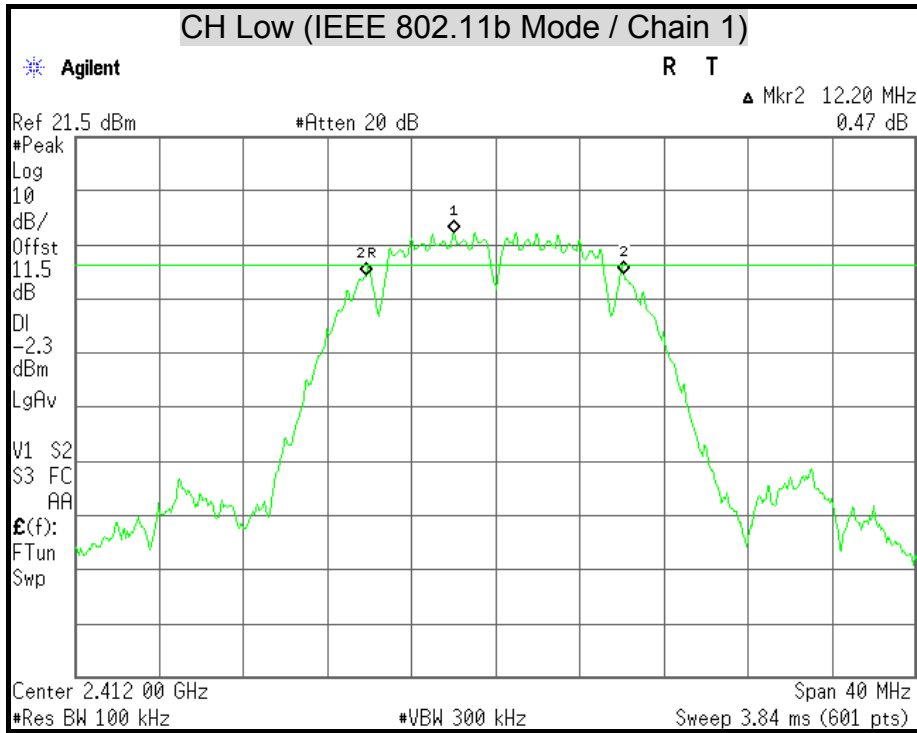

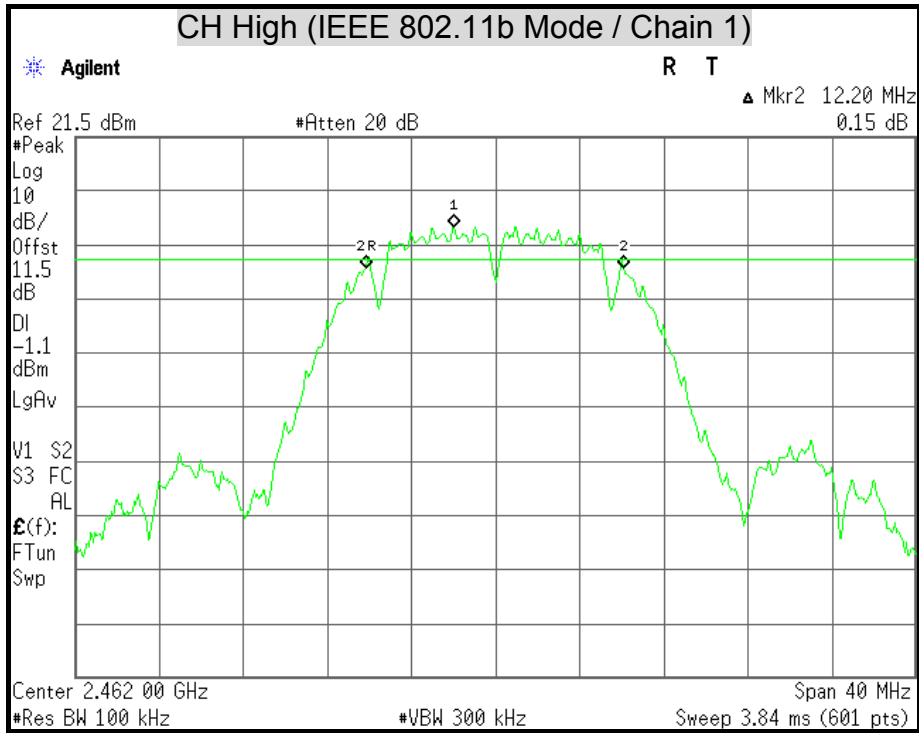

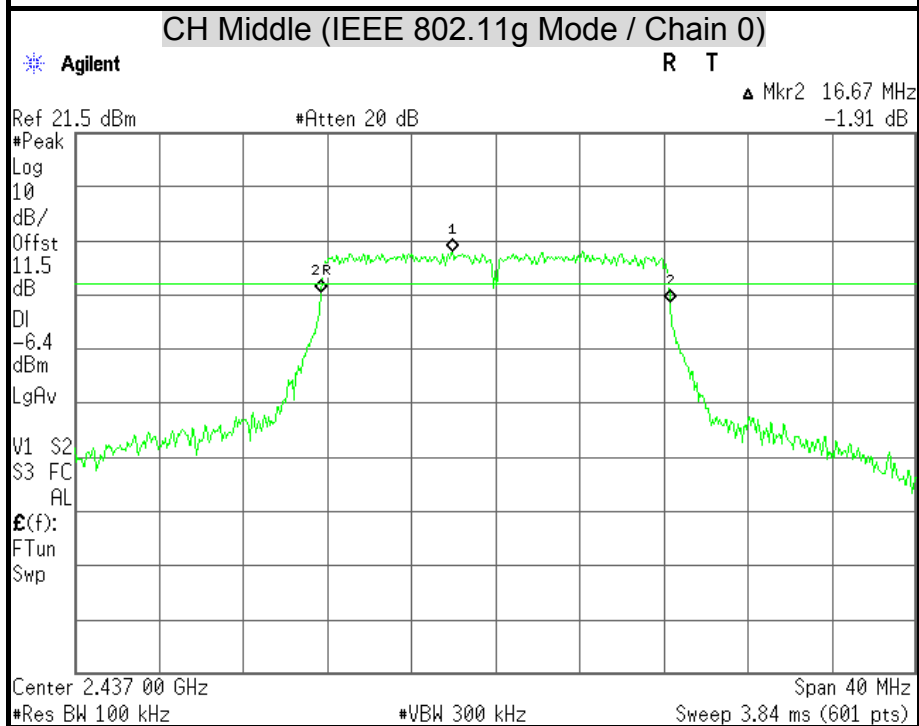
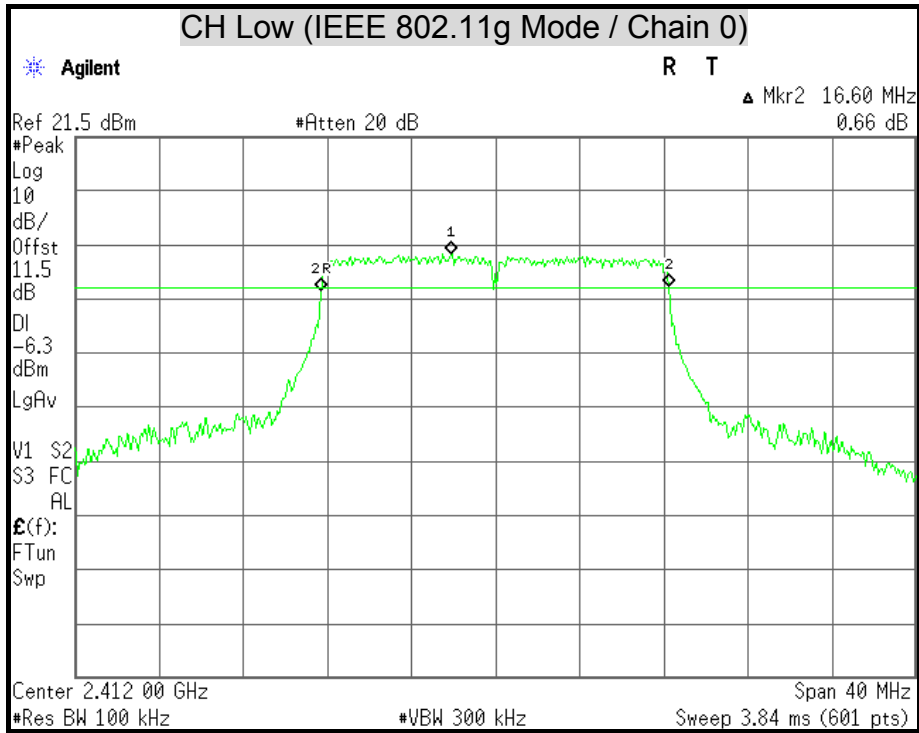

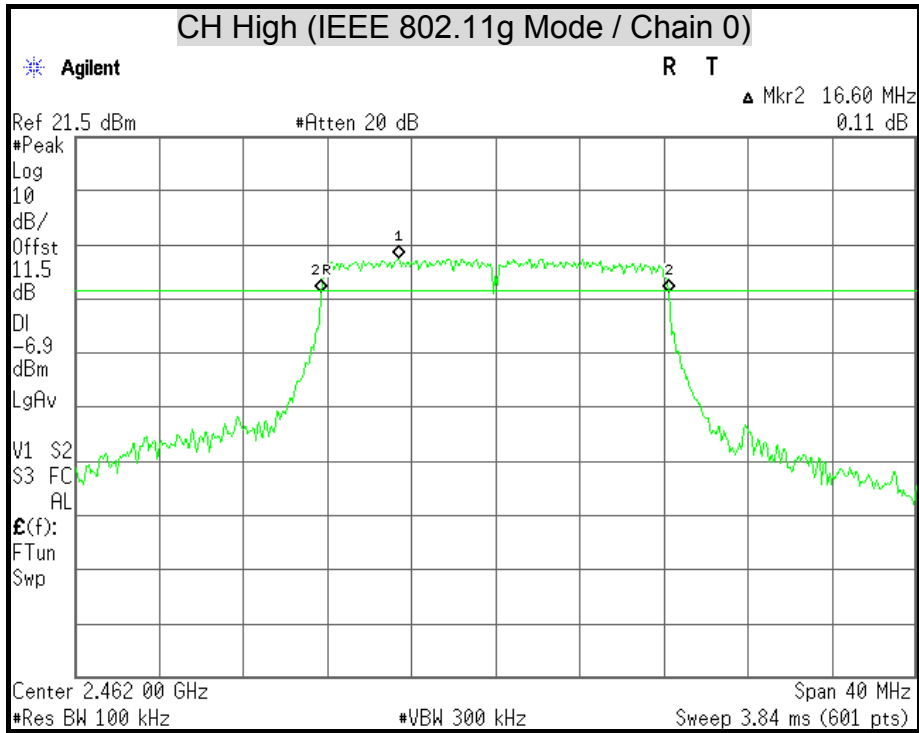

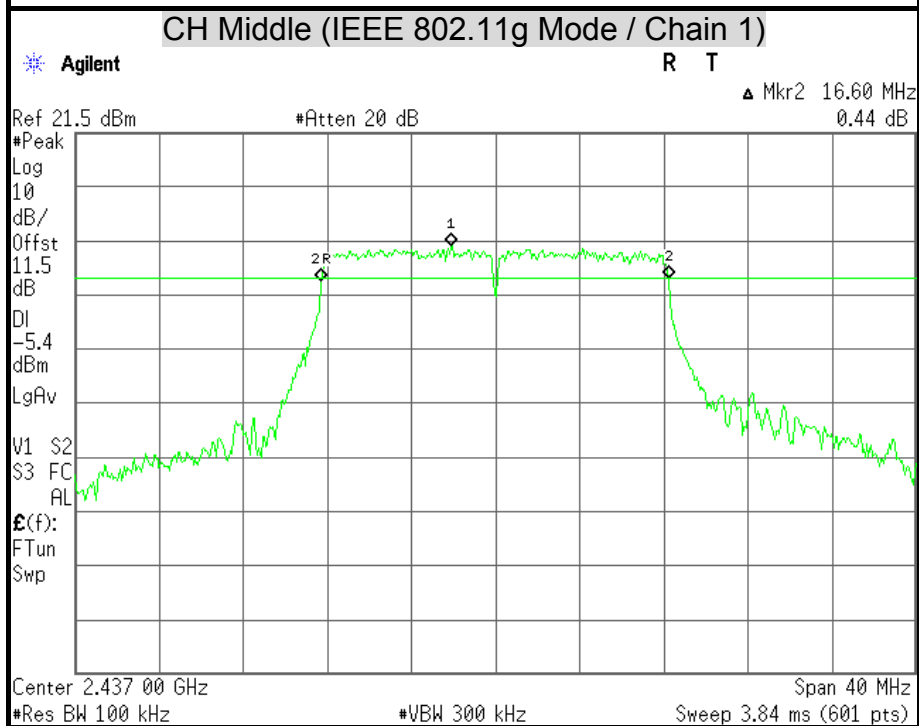
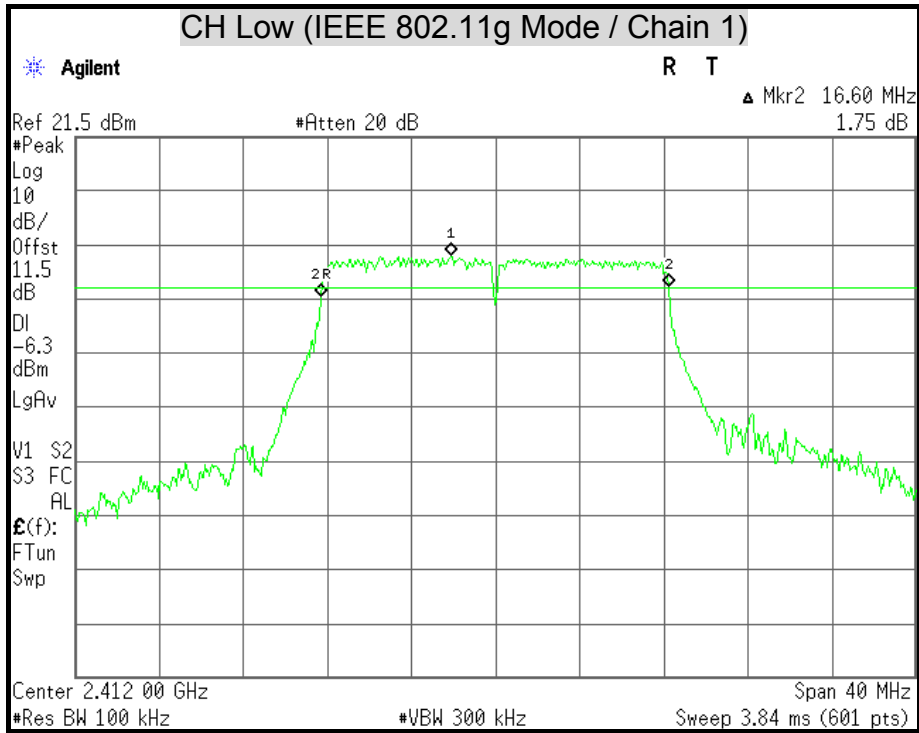

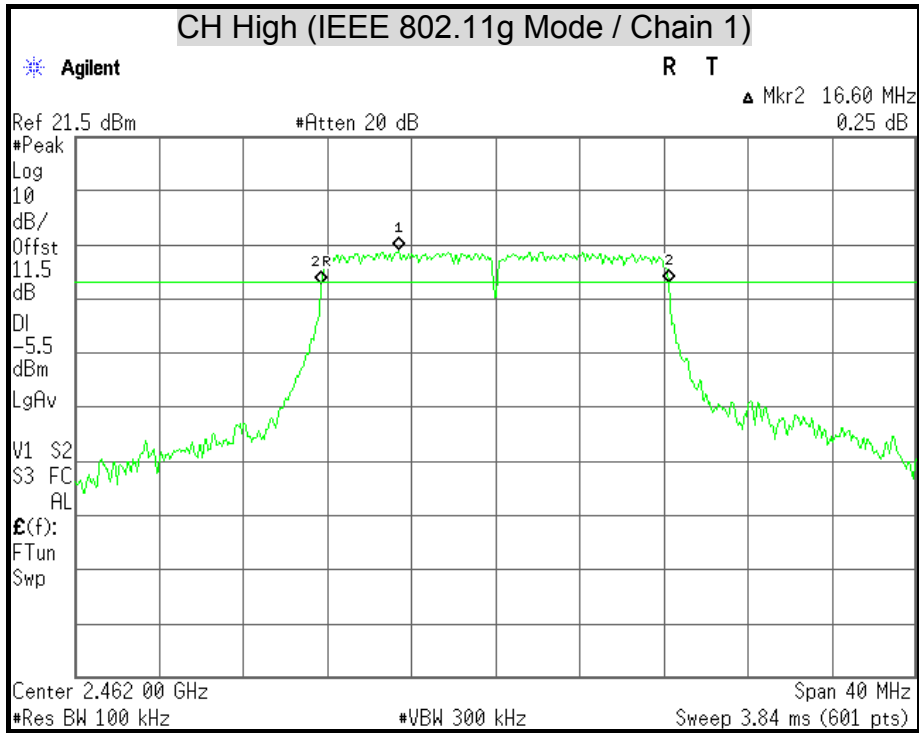

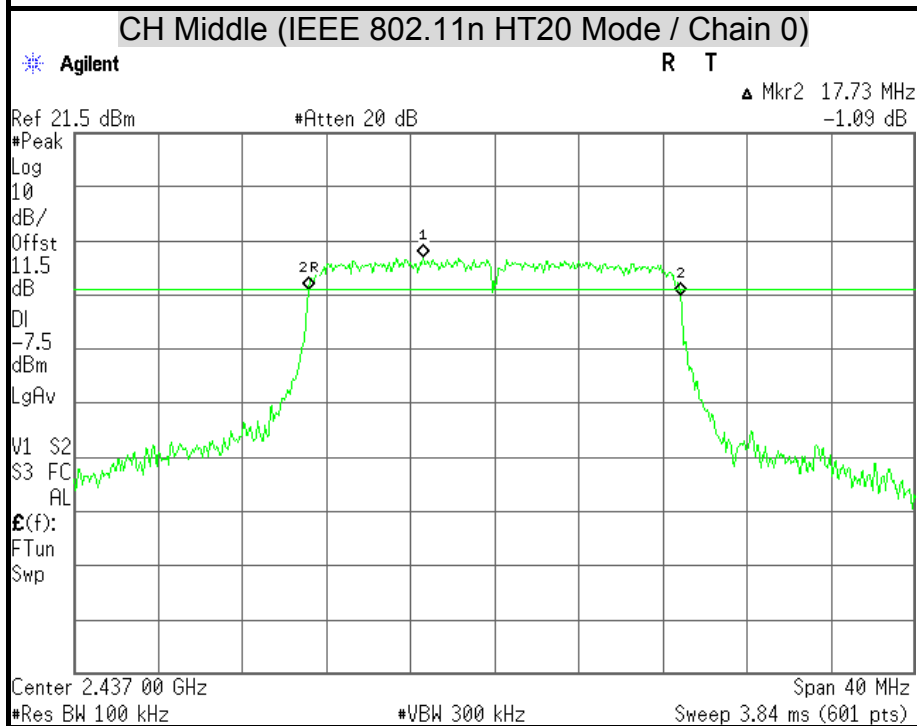
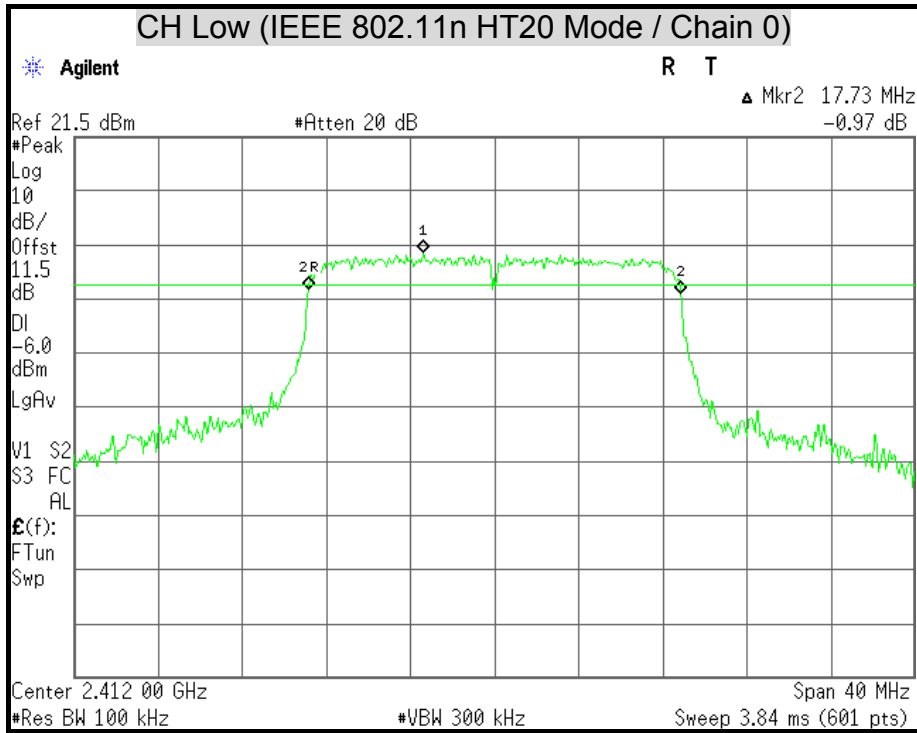

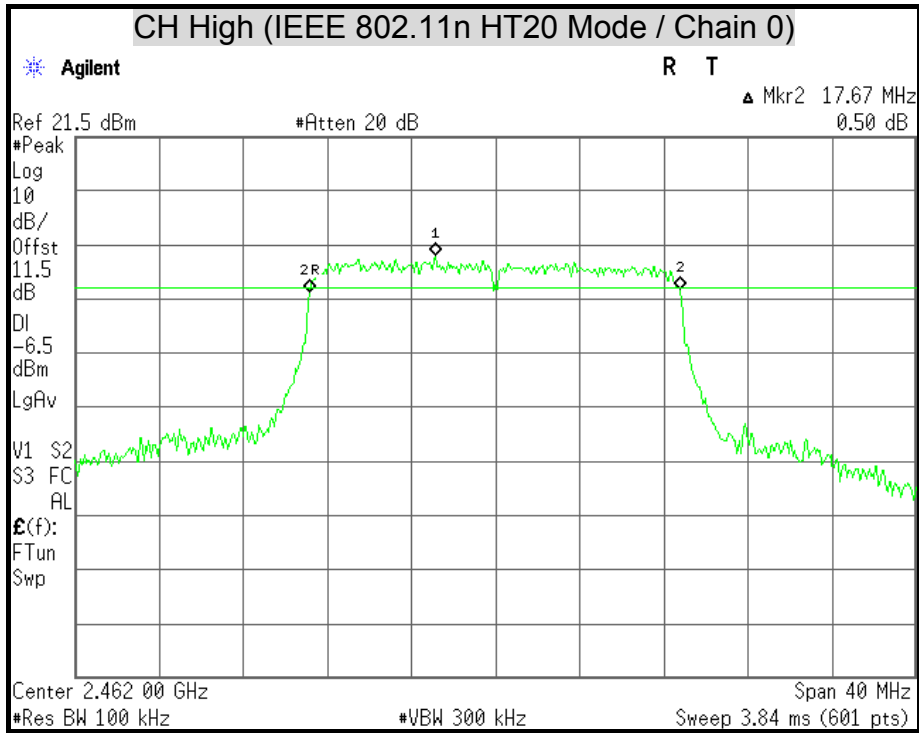

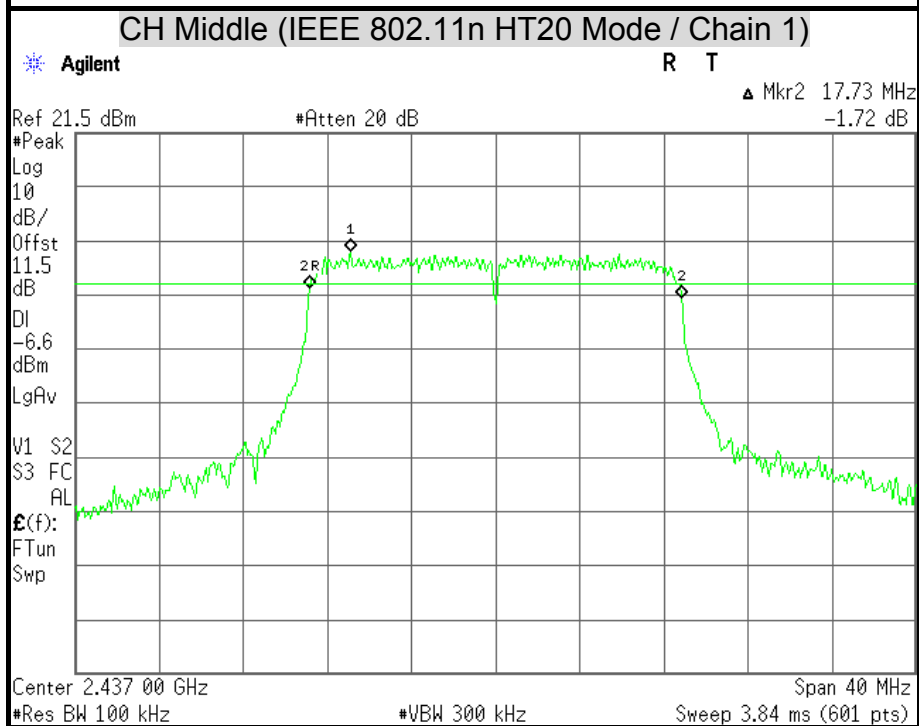
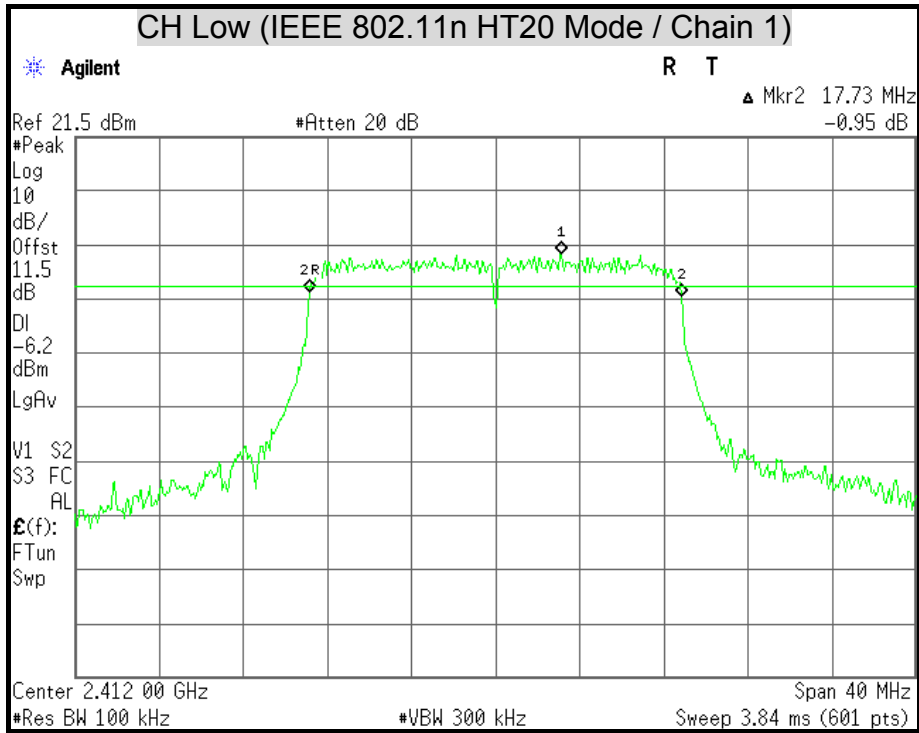

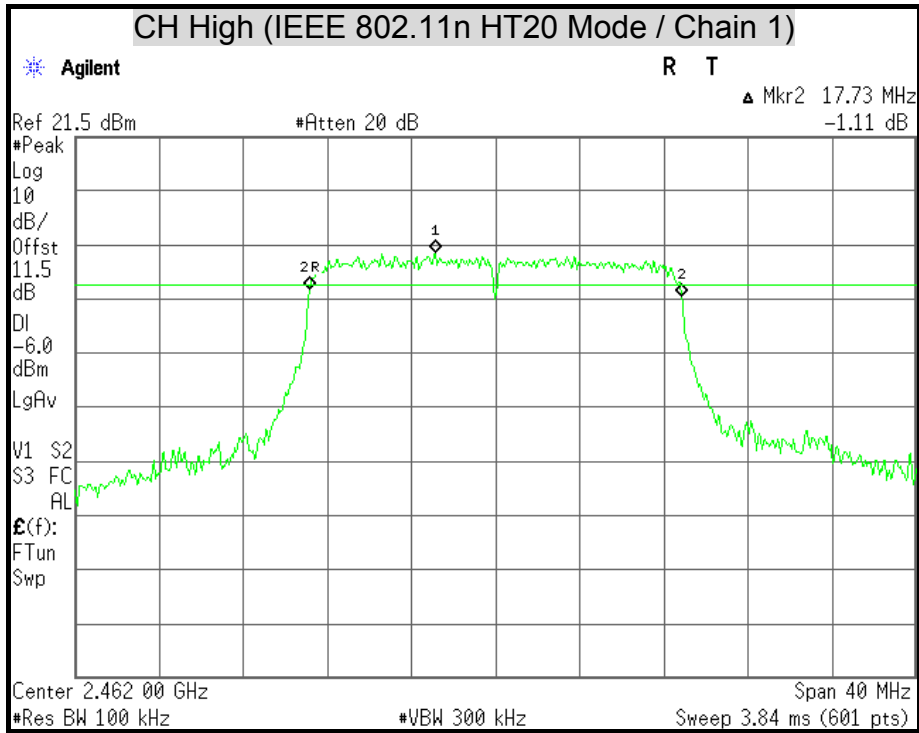

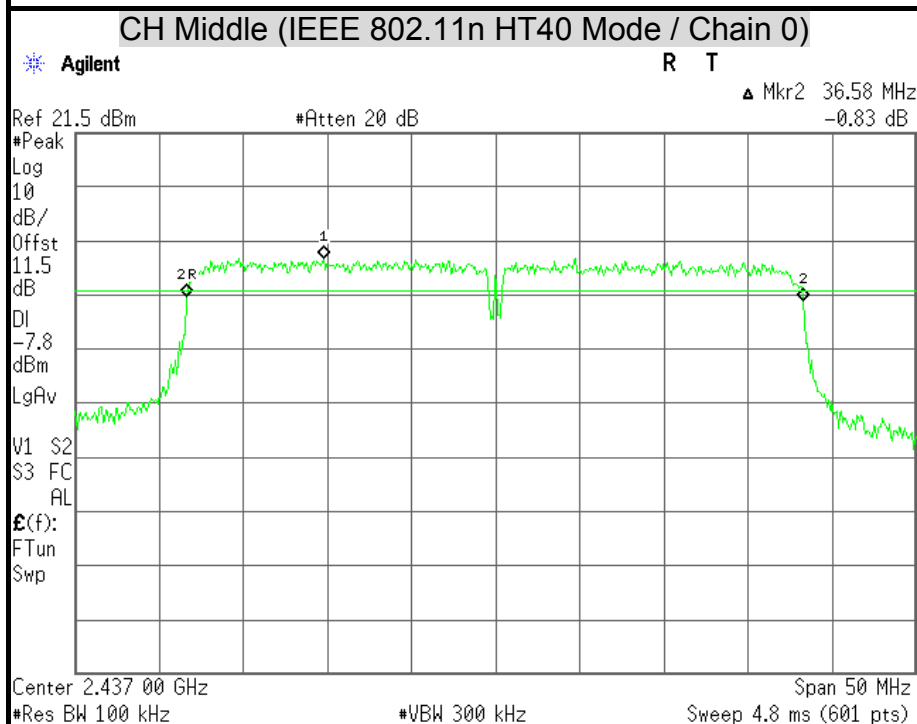
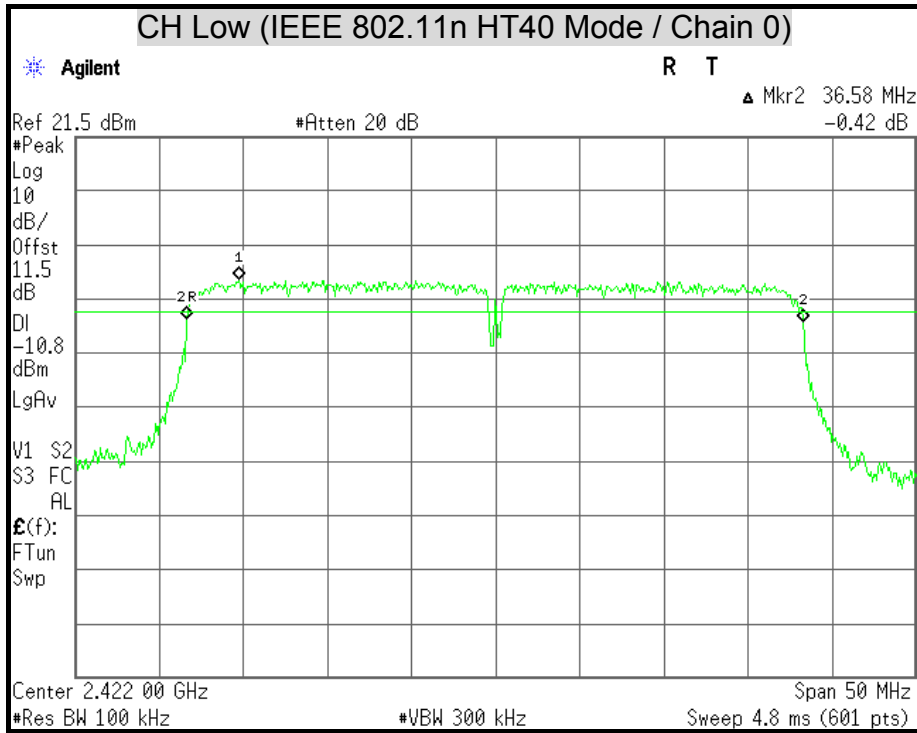

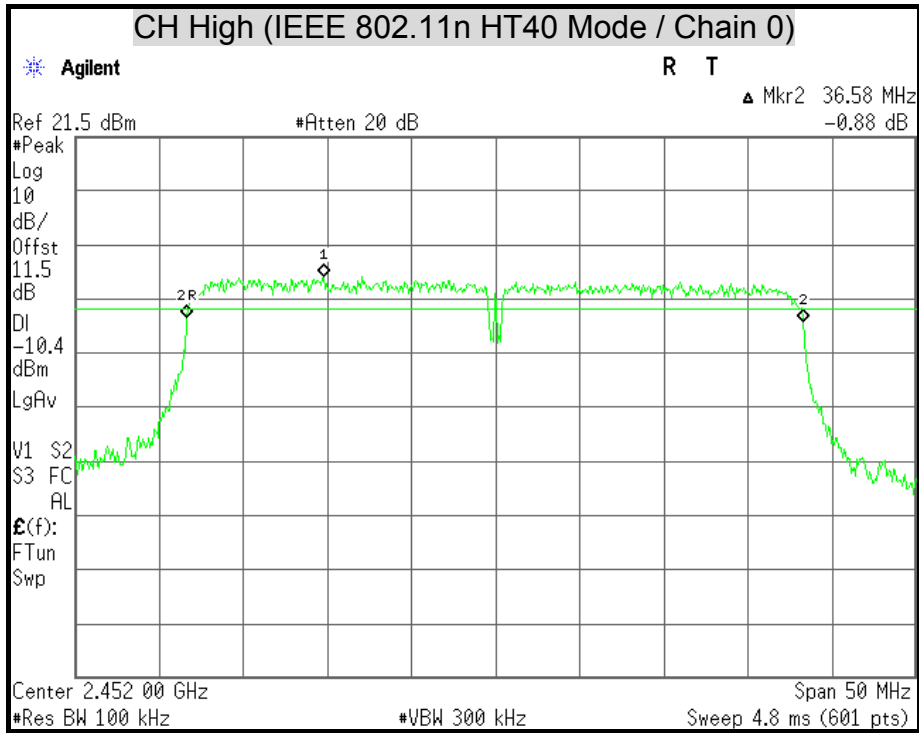

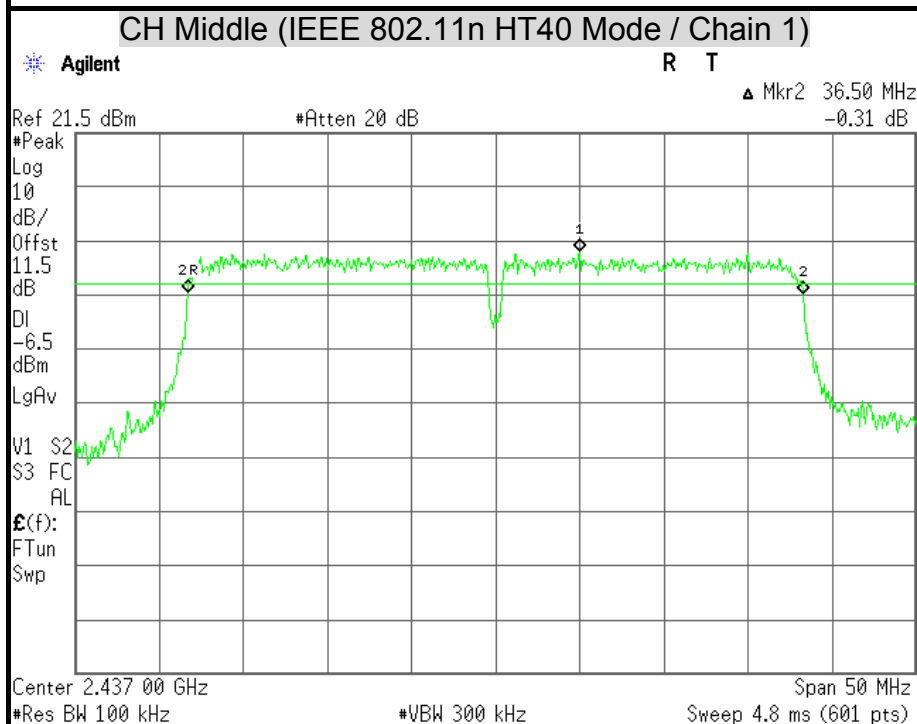
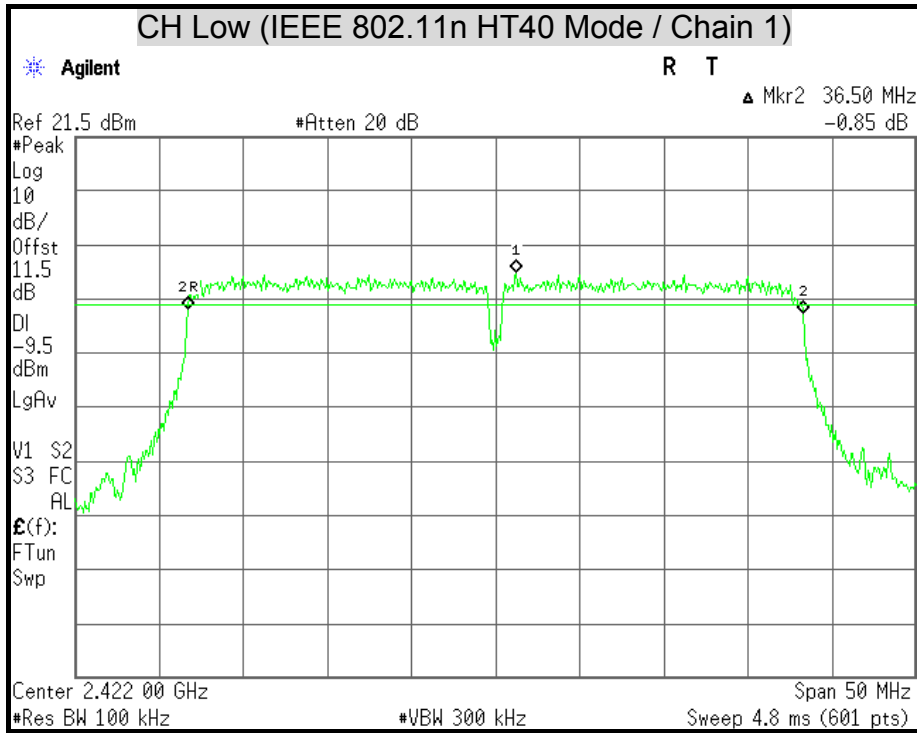

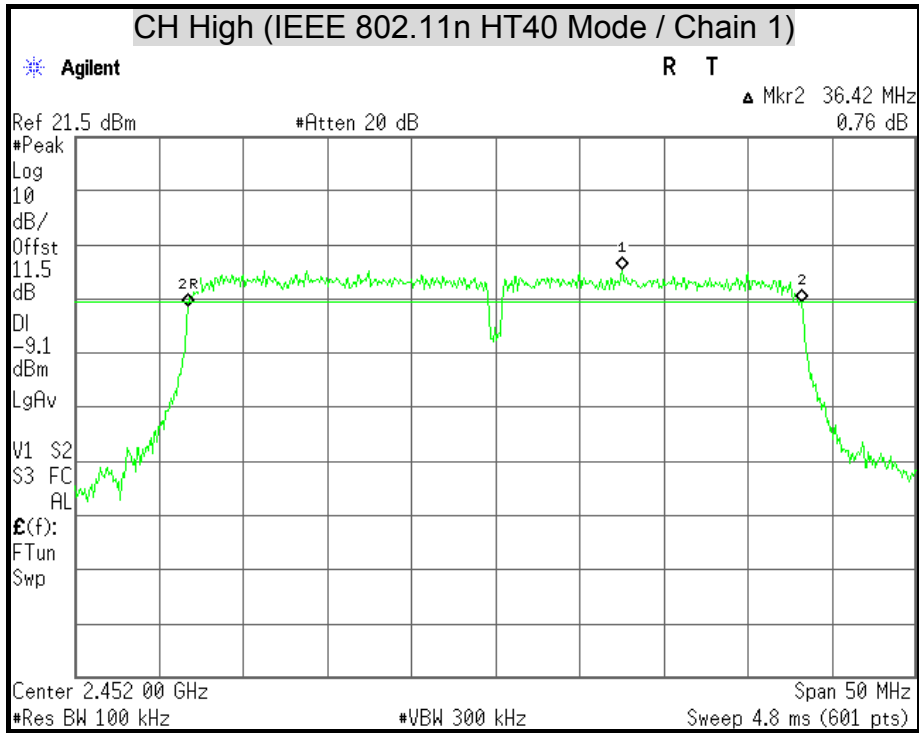



7.2 MAXIMUM PEAK OUTPUT POWER

LIMITS

§ 15.247(b) The maximum peak output power of the intentional radiator shall not exceed the following :

§ 15.247(b) (3) For systems using digital modulation in the 902-928 MHz, 2400-2483.5 MHz, and 5725-5850 MHz bands : 1 watt.

§ 15.247(b) (4) Except as shown in paragraphs (c) of this section, if transmitting antennas of directional gain greater than 6 dBi are used the peak output power from the intentional radiator shall be reduced below the stated values in paragraphs (b)(1) or (b)(2), and (b)(3) of this section, as appropriate, by the amount in dB that the directional gain of the antenna exceeds 6 dBi.

TEST EQUIPMENT

Name of Equipment	Manufacturer	Model	Serial Number	Calibration Due
Power Meter	Anritsu	ML2495A	1149001	12/11/2015
Power Sensor	Anritsu	MA2411B	1126148	12/11/2015

Remark: Each piece of equipment is scheduled for calibration once a year.

TEST SETUP

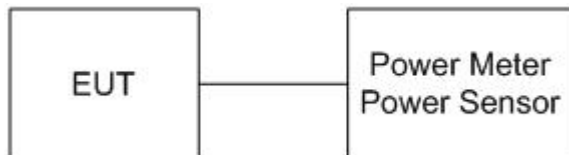

TEST PROCEDURE

The transmitter output is connected to the Power Meter. The Power Meter is set to the peak power detection.



TEST RESULTS

IEEE 802.11b Mode (Two TX)

Channel	Channel Frequency (MHz)	Peak Power (dBm)		Peak Power Total		Peak Power Limit		Pass / Fail
		Chain 0	Chain 1	(dBm)	(W)	(dBm)	(W)	
Low	2412	16.82	16.36	19.61	0.0913	30	1	PASS
Middle	2437	17.00	17.84	20.45	0.1109	30	1	PASS
High	2462	16.41	17.39	19.94	0.0986	30	1	PASS

Remark:

1. At final test to get the worst-case emission at 1Mbps.
2. The cable assembly insertion loss of 11.5dB (including 10 dB pad and 1.5 dB cable) was Entered as an offset in the power meter to allow for direct reading of power.
3. The maximum antenna gain for the MIMO mode is 5.37dBi which is less than 6dBi, the limit should be 1W.
4. Total peak power = Chain 0 + Chain 1.

IEEE 802.11g Mode (Two TX)

Channel	Channel Frequency (MHz)	Peak Power (dBm)		Peak Power Total		Peak Power Limit		Pass / Fail
		Chain 0	Chain 1	(dBm)	(W)	(dBm)	(W)	
Low	2412	22.27	22.55	25.42	0.3485	30	1	PASS
Middle	2437	22.06	23.08	25.61	0.3639	30	1	PASS
High	2462	21.81	22.85	25.37	0.3445	30	1	PASS

Remark:

1. At final test to get the worst-case emission at 6Mbps.
2. The cable assembly insertion loss of 11.5dB (including 10 dB pad and 1.5 dB cable) was Entered as an offset in the power meter to allow for direct reading of power.
3. The maximum antenna gain for the MIMO mode is 5.37dBi which is less than 6dBi, the limit should be 1W.
4. Total peak power = Chain 0 + Chain 1.



IEEE 802.11n HT20 Mode (Two TX)

Channel	Channel Frequency (MHz)	Peak Power (dBm)		Peak Power Total		Peak Power Limit		Pass / Fail
		Chain 0	Chain 1	(dBm)	(W)	(dBm)	(W)	
Low	2412	20.77	20.32	23.56	0.2270	30	1	PASS
Middle	2437	19.86	19.93	22.91	0.1952	30	1	PASS
High	2462	20.31	21.14	23.76	0.2374	30	1	PASS

Remark:

1. At final test to get the worst-case emission at 13Mbps.
2. The cable assembly insertion loss of 11.5dB (including 10 dB pad and 1.5 dB cable) was Entered as an offset in the power meter to allow for direct reading of power.
3. The maximum antenna gain for the MIMO mode is 5.37dBi which is less than 6dBi, the limit should be 1W.
4. Total peak power = Chain 0 + Chain 1.

IEEE 802.11n HT40 Mode (Two TX)

Channel	Channel Frequency (MHz)	Peak Power (dBm)		Peak Power Total		Peak Power Limit		Pass / Fail
		Chain 0	Chain 1	(dBm)	(W)	(dBm)	(W)	
Low	2422	19.34	19.43	22.40	0.1736	30	1	PASS
Middle	2437	22.01	22.85	25.46	0.3516	30	1	PASS
High	2452	19.55	20.06	22.82	0.1915	30	1	PASS

Remark:

1. At final test to get the worst-case emission at 27Mbps.
2. The cable assembly insertion loss of 11.5dB (including 10 dB pad and 1.5 dB cable) was Entered as an offset in the power meter to allow for direct reading of power.
3. The maximum antenna gain for the MIMO mode is 5.37dBi which is less than 6dBi, the limit should be 1W.
4. Total peak power = Chain 0 + Chain 1.



7.3 POWER SPECTRAL DENSITY

LIMITS

§ 15.247(e) For digitally modulated systems, the power spectral density conducted from the intentional radiator to the antenna shall not greater than 8 dBm in any 3 kHz band during any time interval of continuous transmission.

TEST EQUIPMENT

Name of Equipment	Manufacturer	Model	Serial Number	Calibration Due
Spectrum Analyzer	Agilent	E4446A	MY43360132	06/10/2015

Remark: Each piece of equipment is scheduled for calibration once a year.

TEST SETUP



TEST PROCEDURE

1. The transmitter output was connected to the spectrum analyzer.
2. Set analyzer center frequency to DTS channel center frequency.
3. Set the span to 1.5 times the DTS channel bandwidth.
4. Set the RBW to: $3 \text{ kHz} \leq \text{RBW} \leq 100 \text{ kHz}$.
5. Set the VBW $\geq 3 \times \text{RBW}$.
6. Detector = peak.
7. Sweep time = auto couple.
8. Trace mode = max hold.
9. Allow trace to fully stabilize.
10. Use the peak marker function to determine the maximum amplitude level within the RBW.
11. If measured value exceeds limit, reduce RBW (no less than 3 kHz) and repeat.



TEST RESULTS

IEEE 802.11b Mode (Two TX)

Channel	Channel Frequency (MHz)	Final RF Power Level in 3KHz BW (dBm)		PSD Total (dBm)	Minimum Limit (dBm)	Pass / Fail
		Chain 0	Chain 1			
Low	2412	-9.85	-14.73	-8.63	8	PASS
Middle	2437	-10.89	-13.23	-8.89	8	PASS
High	2462	-10.27	-13.50	-8.58	8	PASS

Remark:

1. At final test to get the worst-case emission at 1Mbps.
2. The cable assembly insertion loss of 11.5dB (including 10 dB pad and 1.5 dB cable) was Entered as an offset in the spectrum analyzer to allow for direct reading of power.
3. Total power spectral density = Chain 0 + Chain 1.

IEEE 802.11g Mode (Two TX)

Channel	Channel Frequency (MHz)	Final RF Power Level in 3KHz BW (dBm)		PSD Total (dBm)	Minimum Limit (dBm)	Pass / Fail
		Chain 0	Chain 1			
Low	2412	-8.85	-14.79	-7.86	8	PASS
Middle	2437	-9.29	-13.78	-7.97	8	PASS
High	2462	-8.37	-14.10	-7.34	8	PASS

Remark:

1. At final test to get the worst-case emission at 13Mbps.
2. The cable assembly insertion loss of 11.5dB (including 10 dB pad and 1.5 dB cable) was Entered as an offset in the spectrum analyzer to allow for direct reading of power.
3. Total power spectral density = Chain 0 + Chain 1.



IEEE 802.11n HT20 Mode (Two TX)

Channel	Channel Frequency (MHz)	Final RF Power Level in 3KHz BW (dBm)		PSD Total (dBm)	Minimum Limit (dBm)	Pass / Fail
		Chain 0	Chain 1			
Low	2412	-8.74	-14.78	-7.77	8	PASS
Middle	2437	-9.06	-13.77	-7.80	8	PASS
High	2462	-10.41	-13.69	-8.74	8	PASS

Remark:

1. At final test to get the worst-case emission at 13Mbps.
2. The cable assembly insertion loss of 11.5dB (including 10 dB pad and 1.5 dB cable) was Entered as an offset in the spectrum analyzer to allow for direct reading of power.
3. Total power spectral density = Chain 0 + Chain 1.

IEEE 802.11n HT40 Mode (Two TX)

Channel	Channel Frequency (MHz)	Final RF Power Level in 3KHz BW (dBm)		PSD Total (dBm)	Minimum Limit (dBm)	Pass / Fail
		Chain 0	Chain 1			
Low	2422	-11.04	-19.06	-10.40	8	PASS
Middle	2437	-7.96	-14.25	-7.04	8	PASS
High	2452	-10.08	-17.66	-9.38	8	PASS

Remark:

1. At final test to get the worst-case emission at 27Mbps.
2. The cable assembly insertion loss of 11.5dB (including 10 dB pad and 1.5 dB cable) was Entered as an offset in the spectrum analyzer to allow for direct reading of power.
3. Total power spectral density = Chain 0 + Chain 1.



POWER SPECTRAL DENSITY

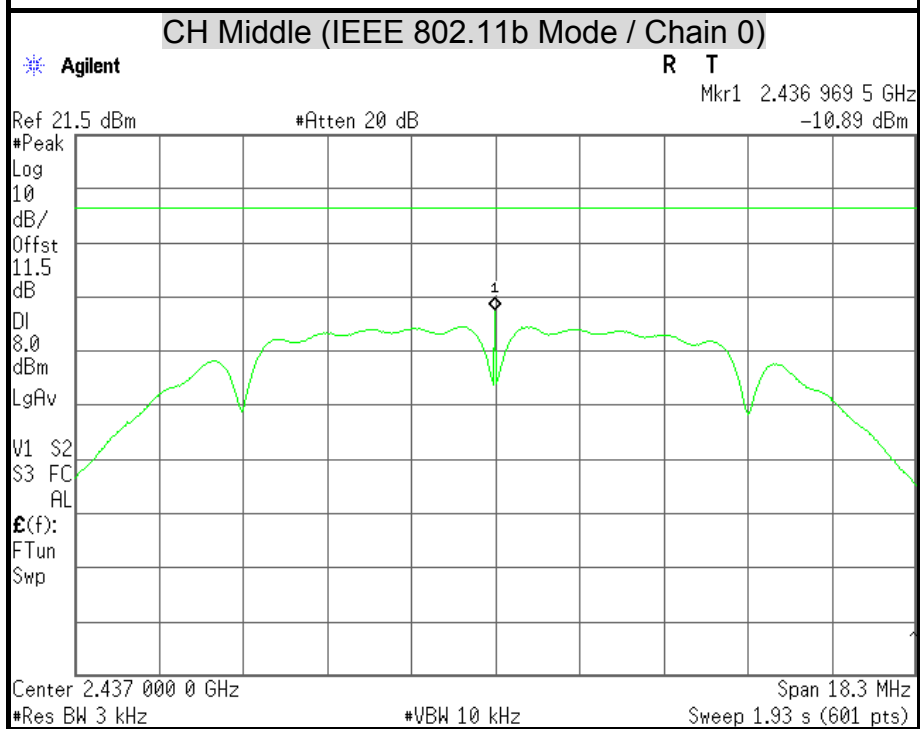
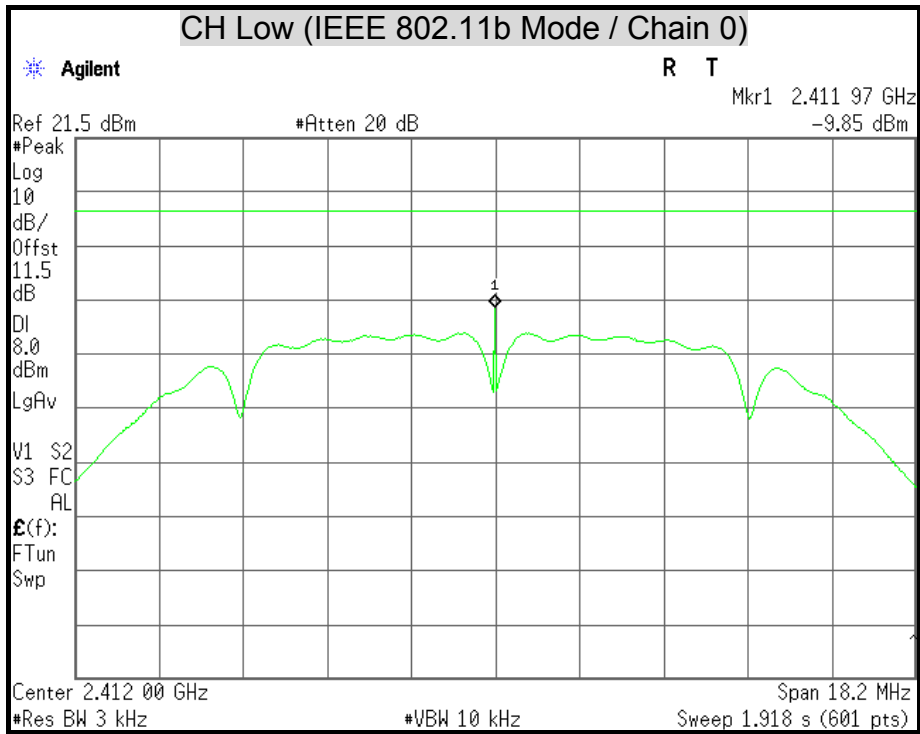

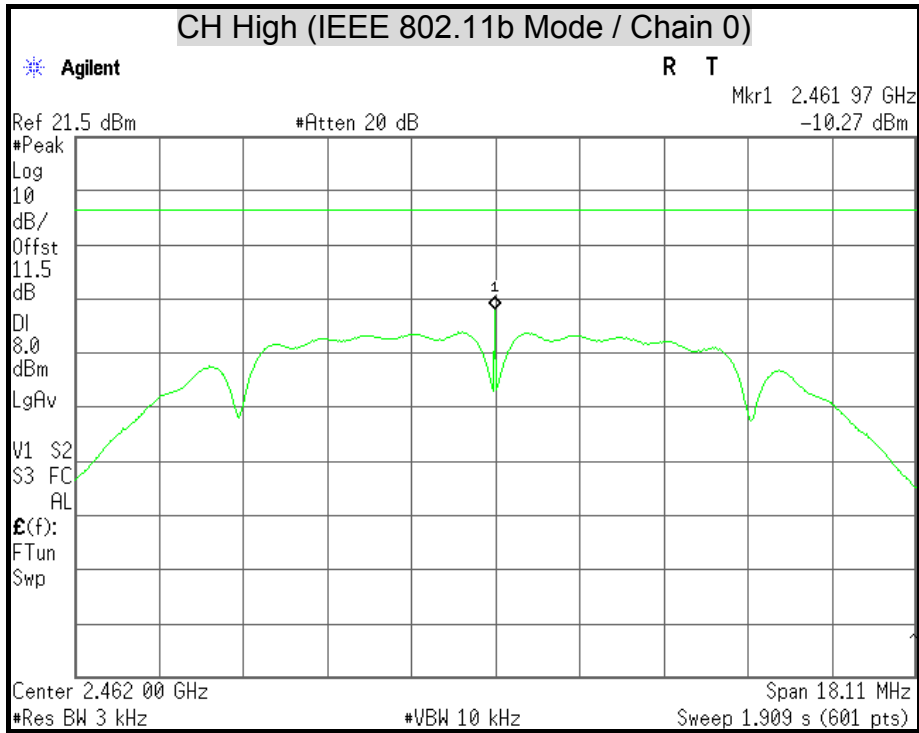

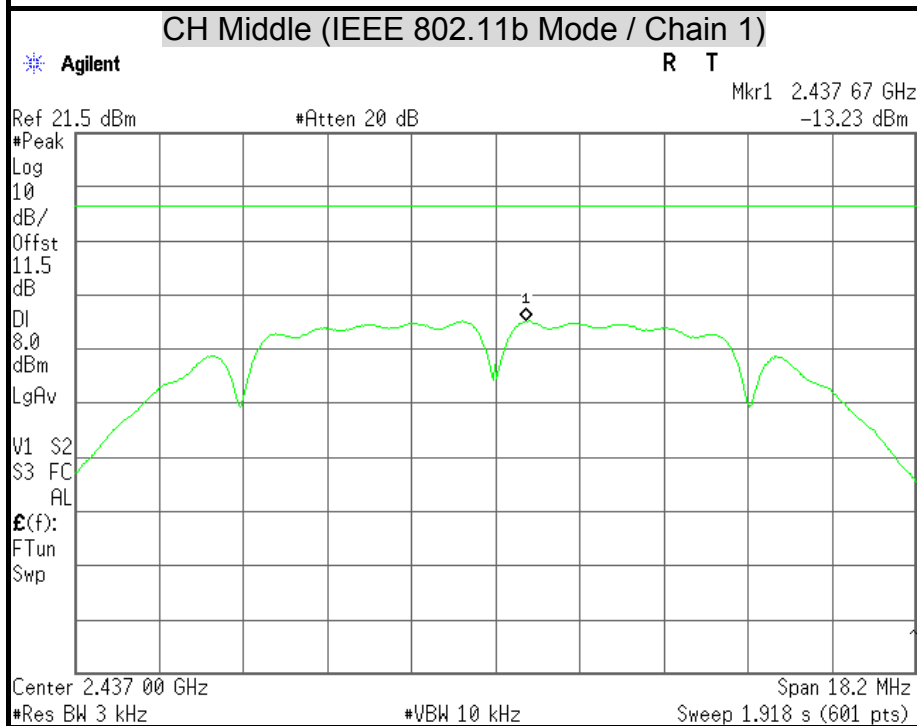
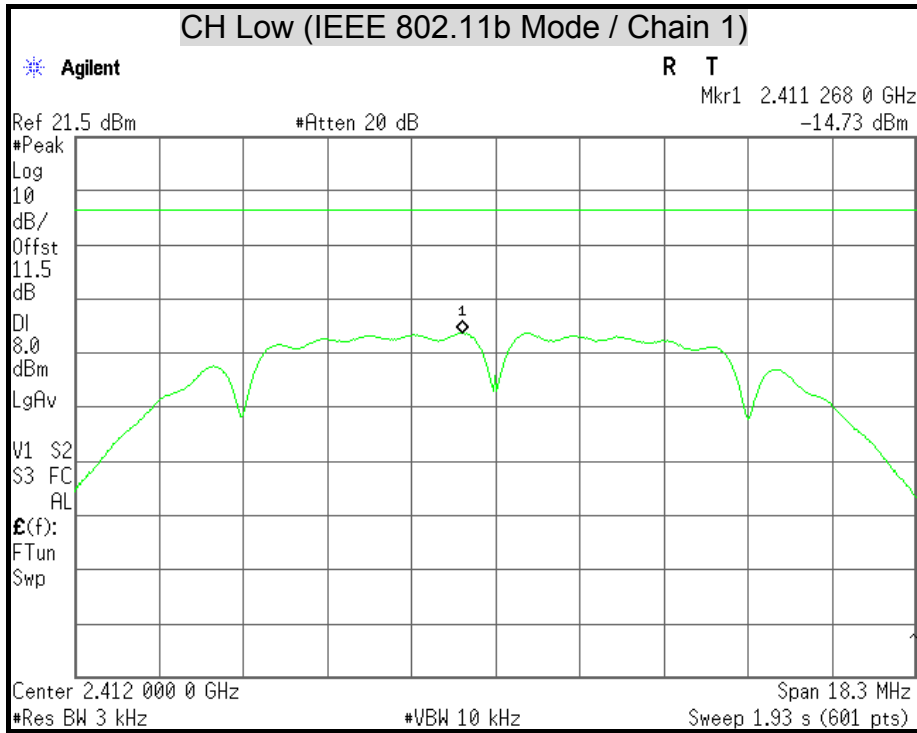

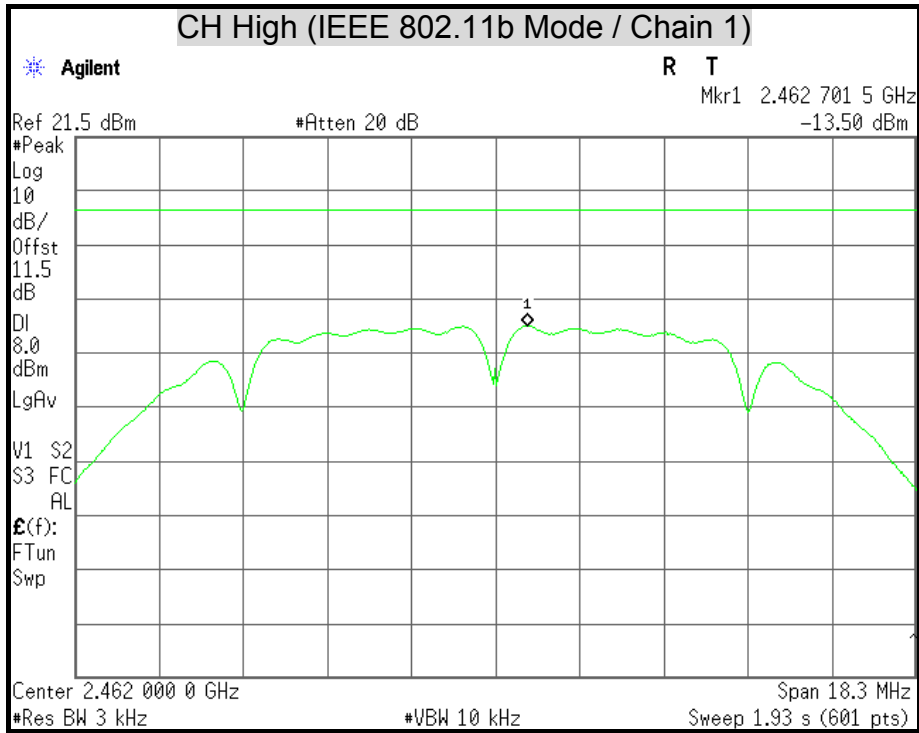

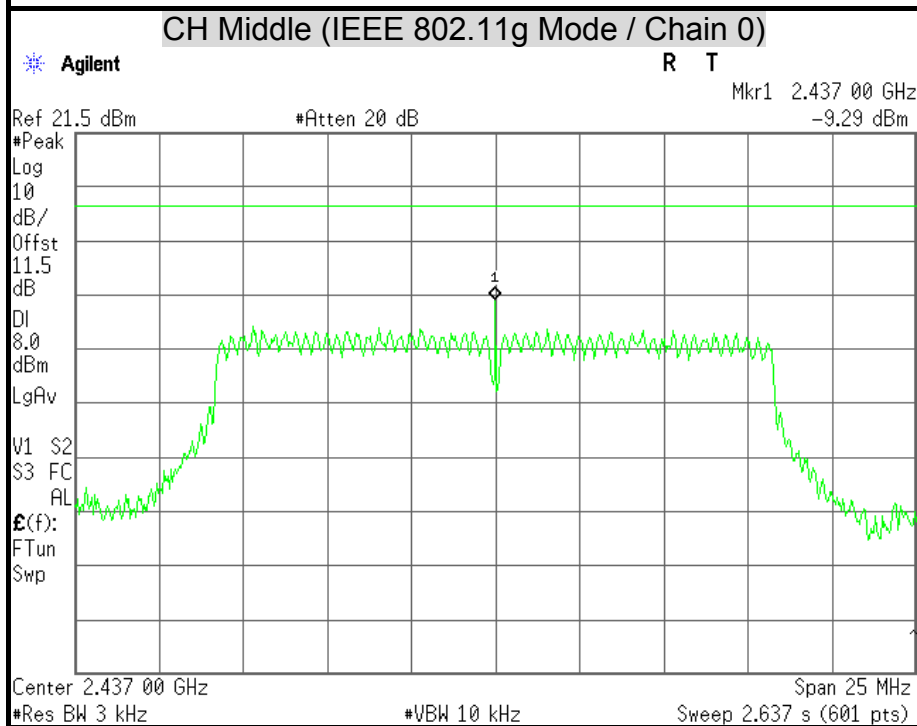
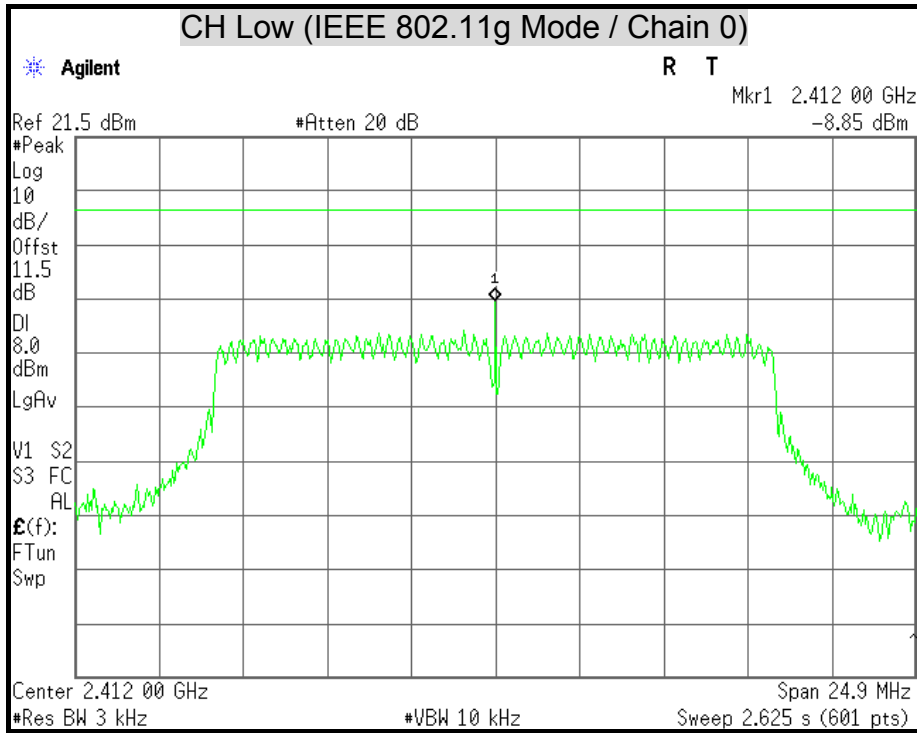

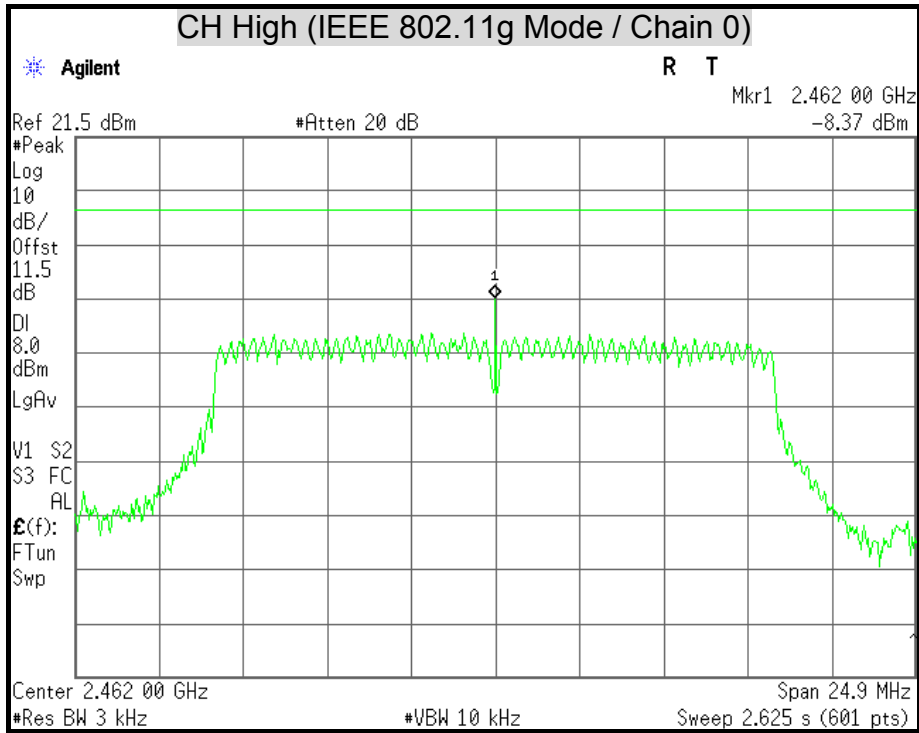

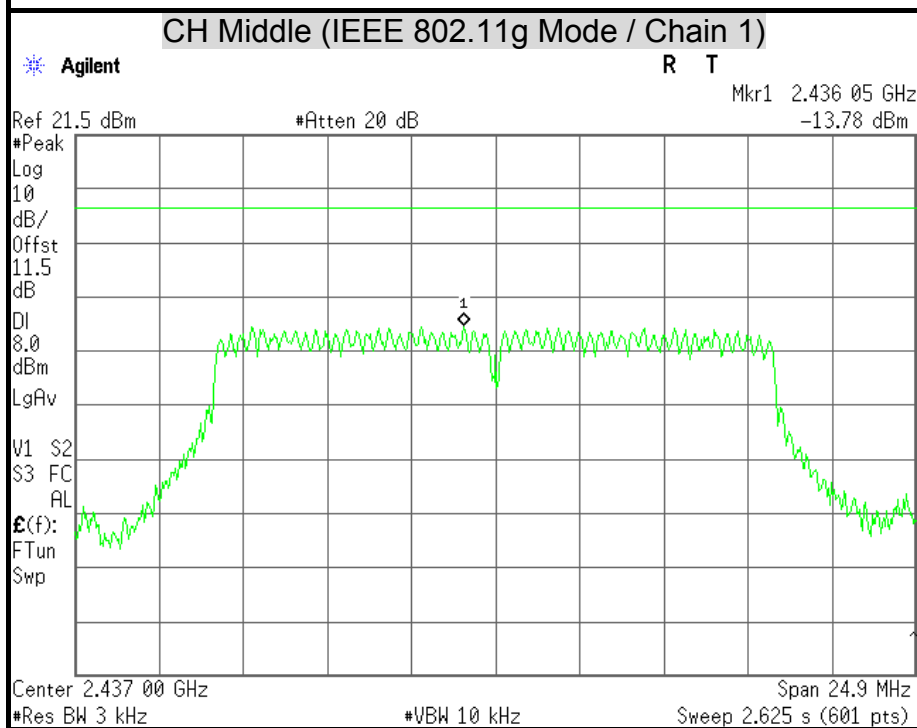
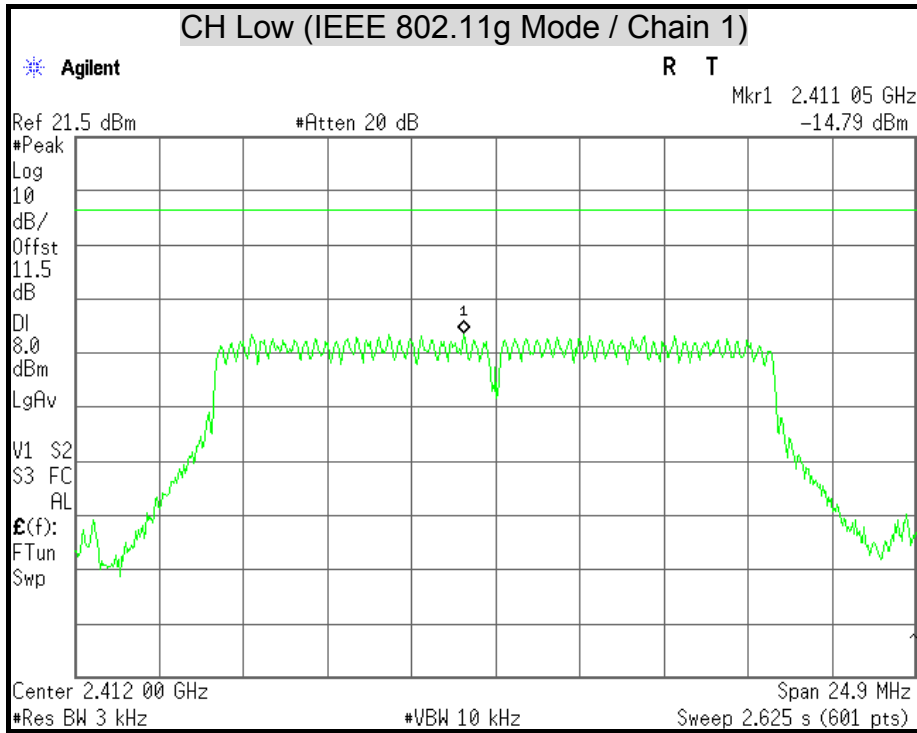

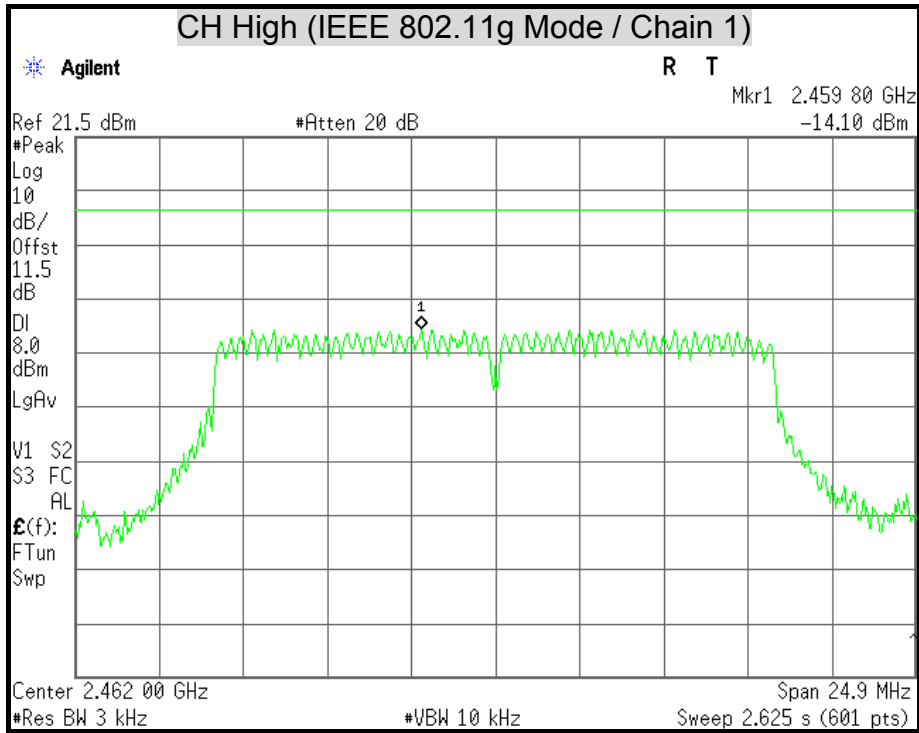

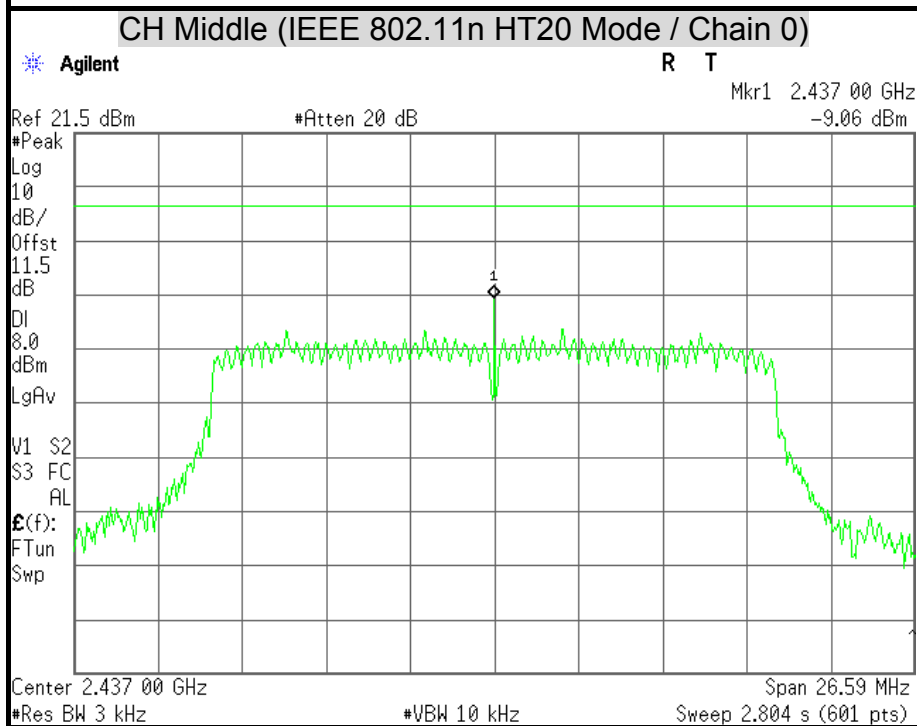
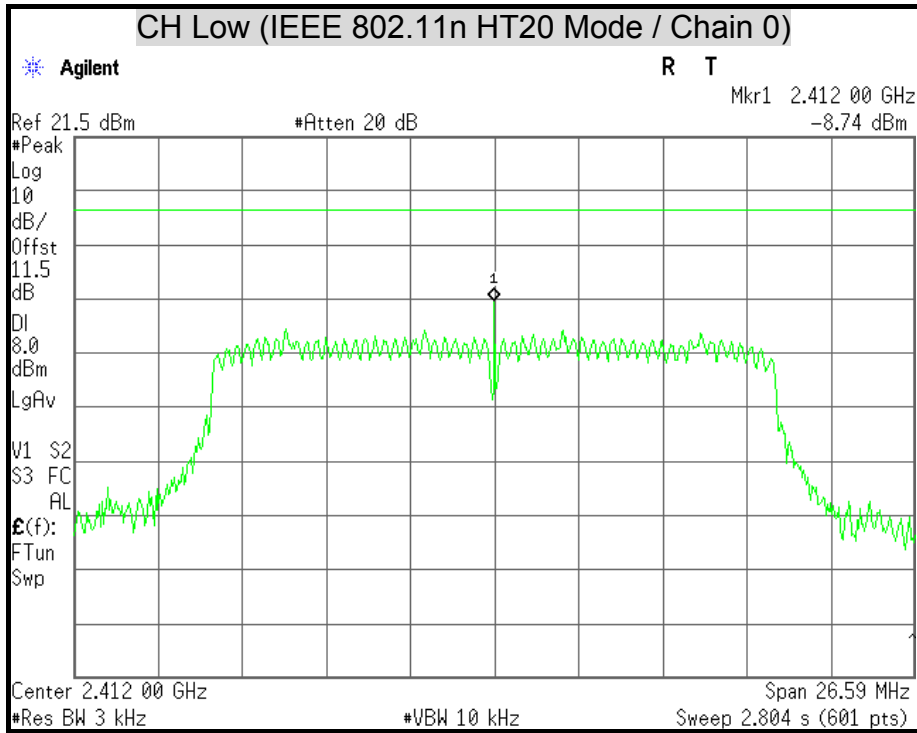

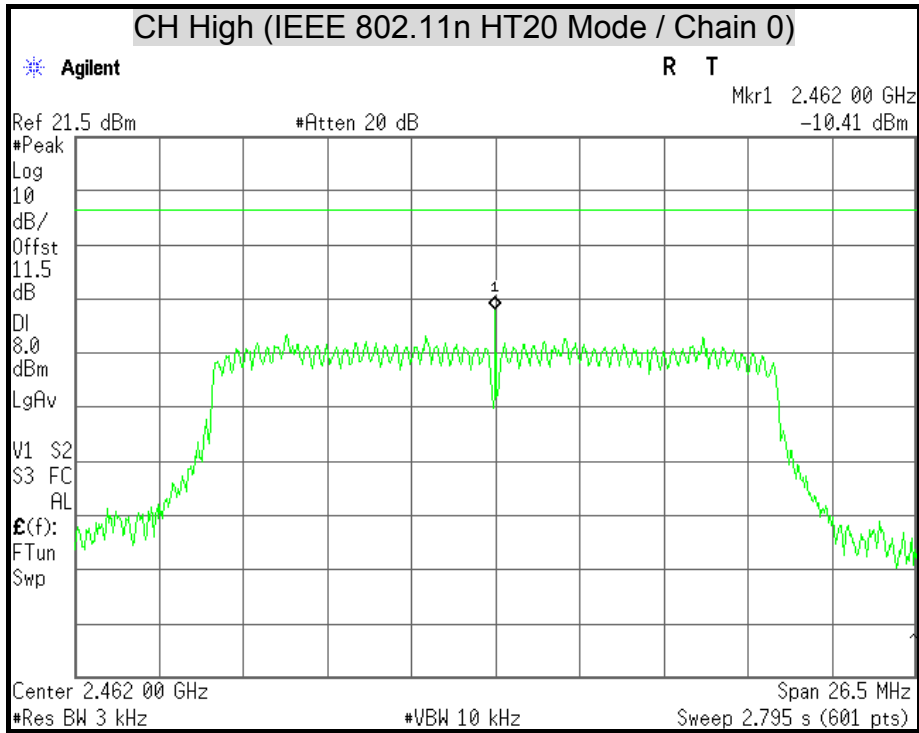

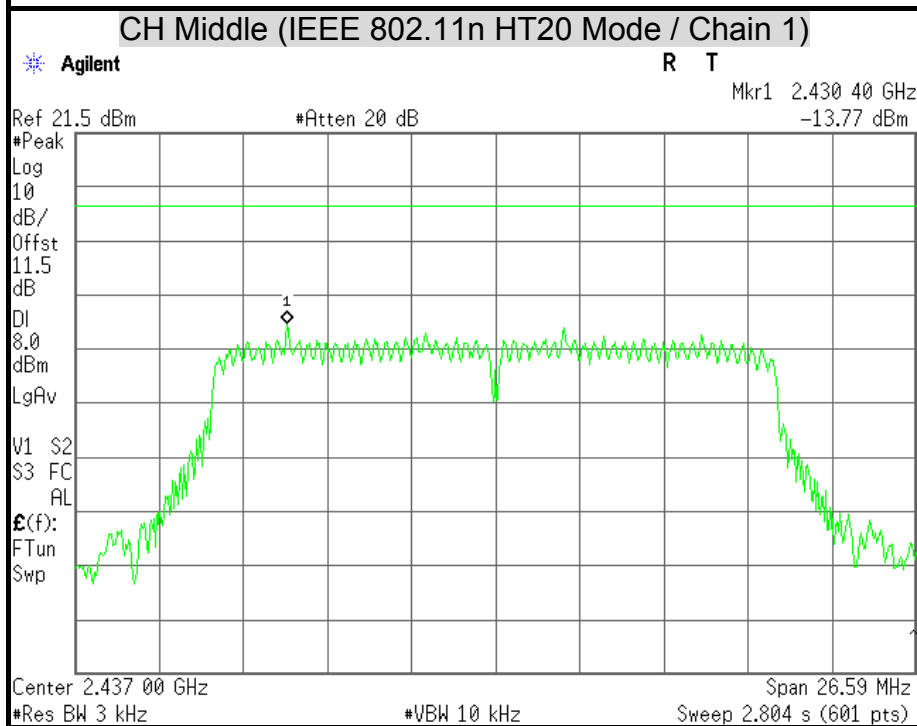
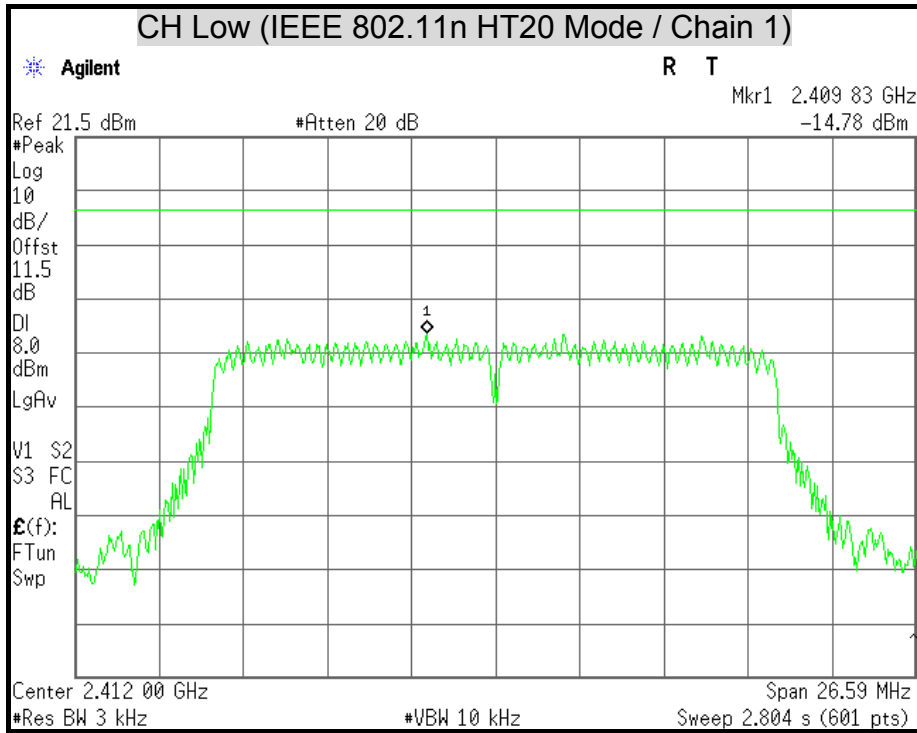

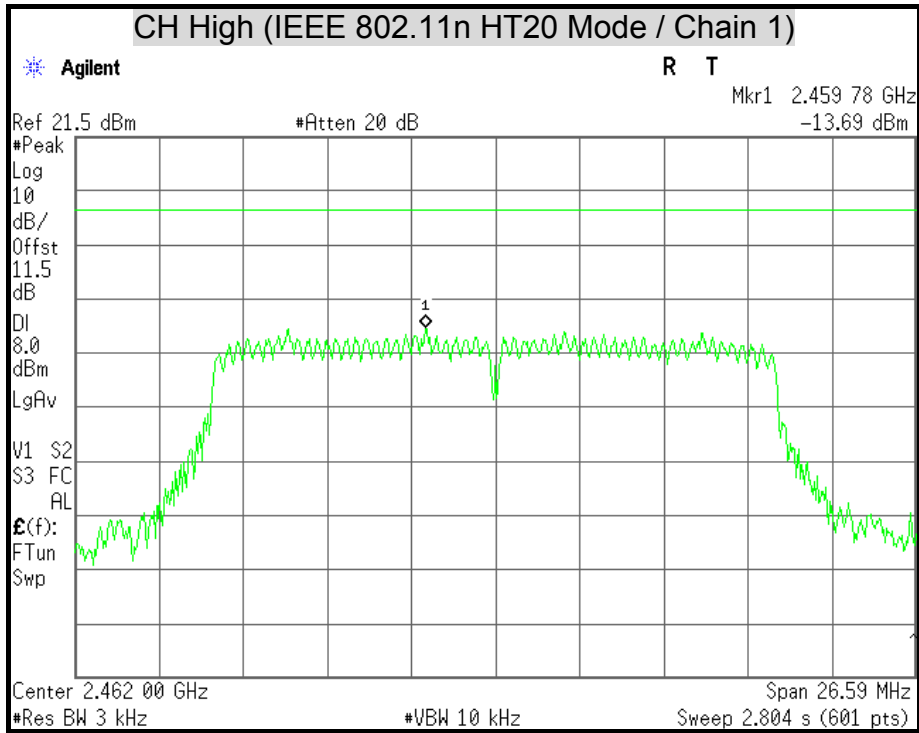

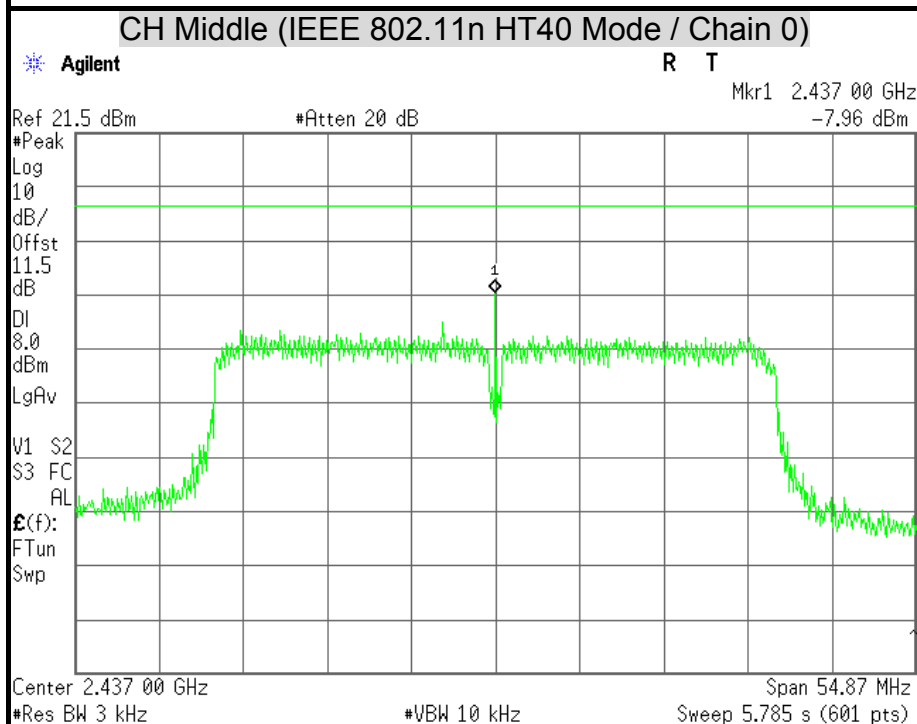
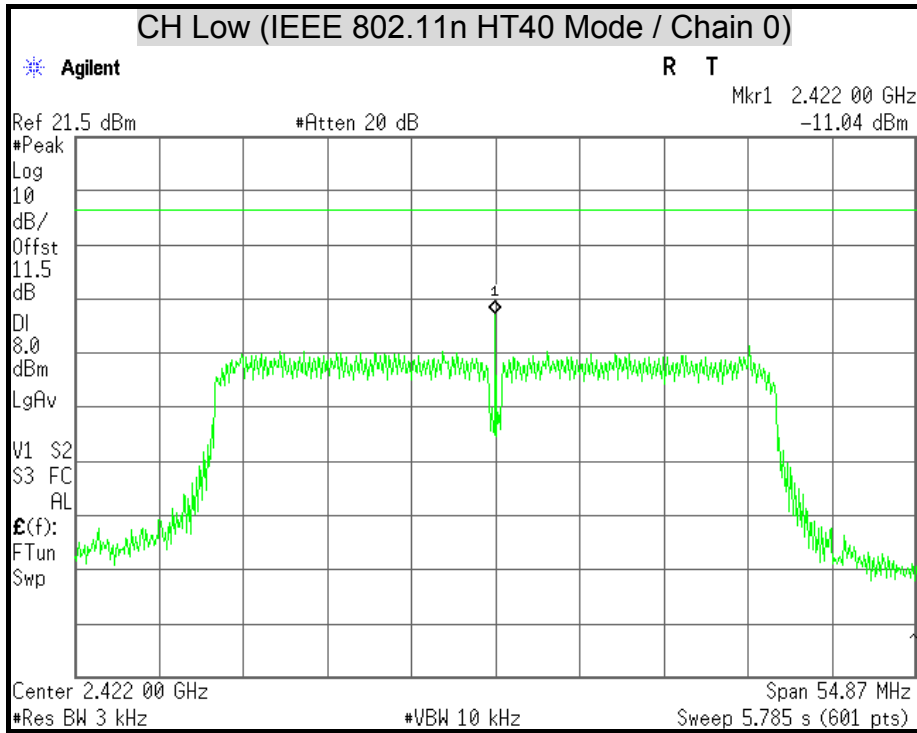

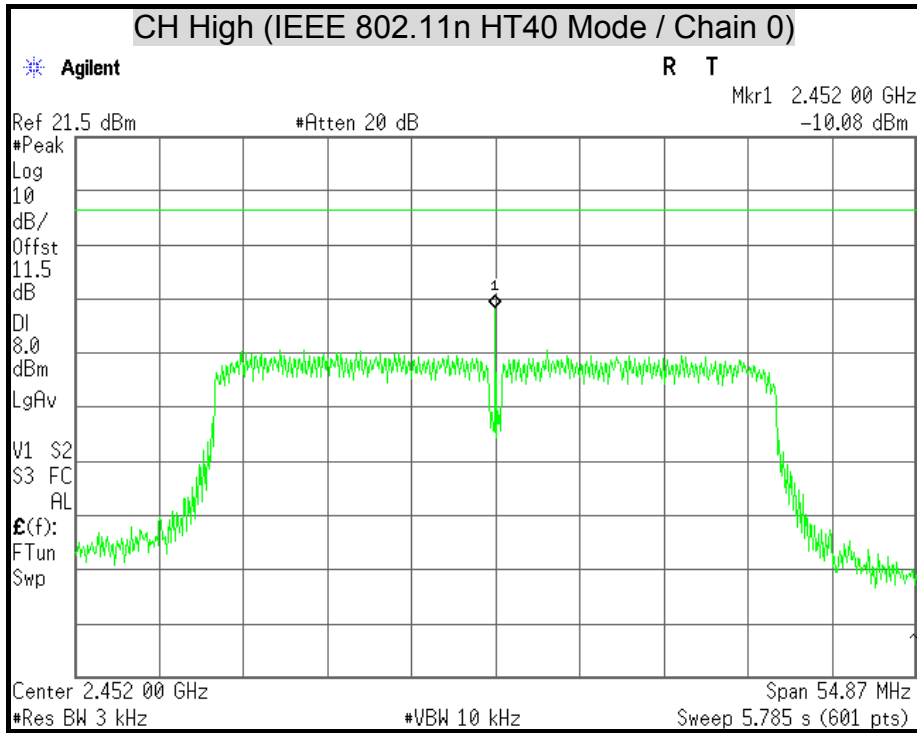

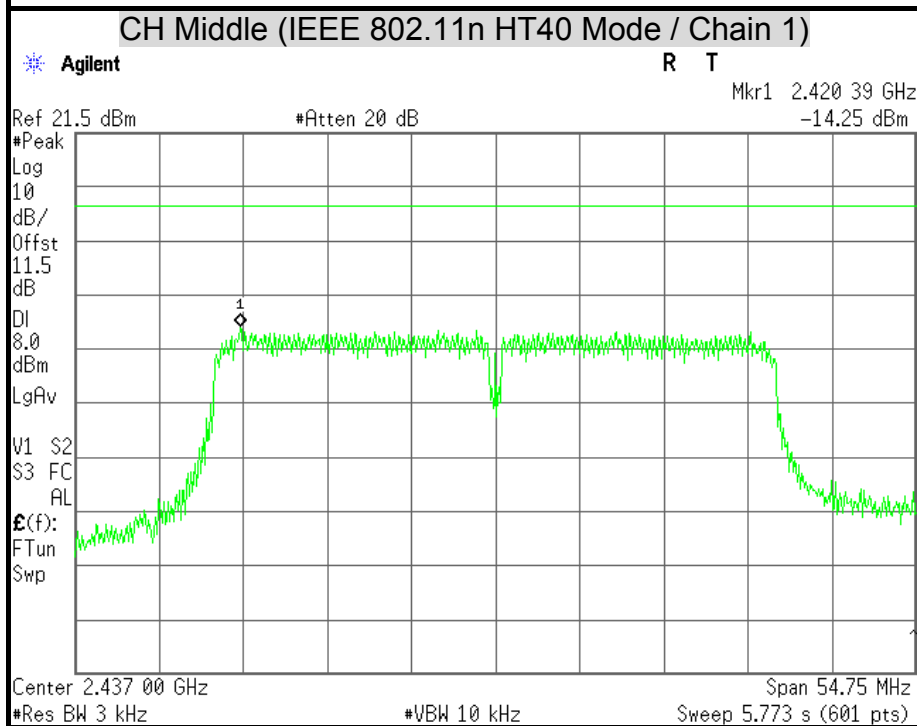
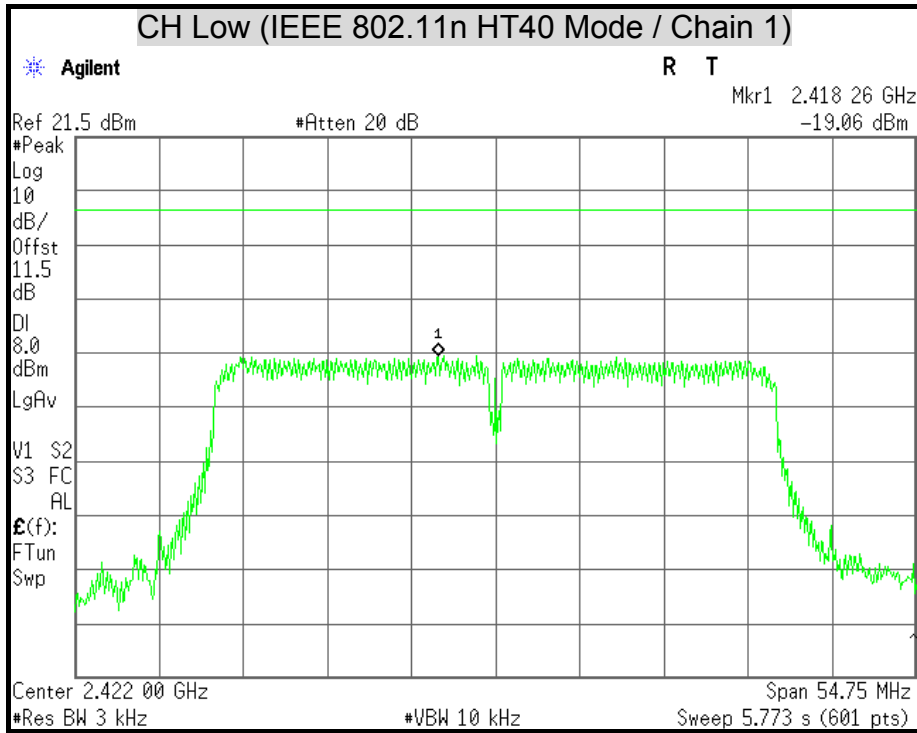

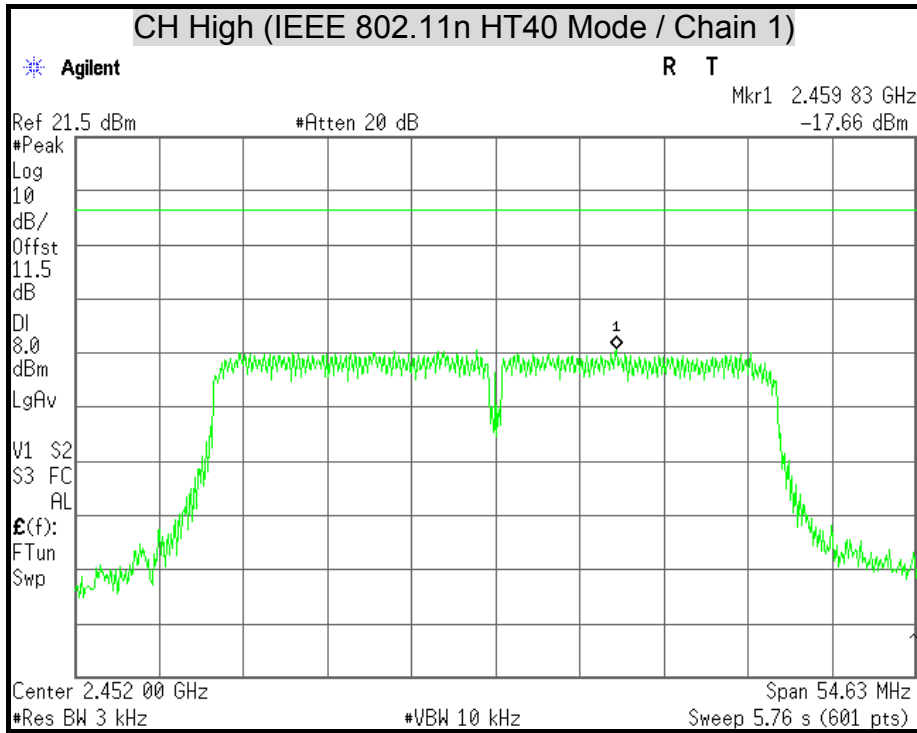



7.4 CONDUCTED SPURIOUS EMISSION

LIMITS

§ 15.247(d) In any 100 kHz bandwidth outside the frequency band in which the spread spectrum intentional radiator is operating, the radio frequency power that is produced by the intentional radiator shall be at least 20 dB below that in the 100 kHz bandwidth within the and that contains the highest level of the desired power, based on either an RF conducted or a radiated measurement. Attenuation below the general limits specified in § 15.209(a) is not required. In addition, radiated emissions which fall in the restricted bands, as defined in § 15.205(a), must also comply with the radiated emission limits specified in § 15.209(a) (see § 15.205(c)).

TEST EQUIPMENT

Name of Equipment	Manufacturer	Model	Serial Number	Calibration Due
Spectrum Analyzer	Agilent	E4446A	MY43360132	06/10/2015

Remark: Each piece of equipment is scheduled for calibration once a year.

TEST SETUP



TEST PROCEDURE

The transmitter output is connected to a spectrum analyzer. The resolution bandwidth is set to 100 kHz. The video bandwidth is set to 300 kHz.

The spectrum from 30 MHz to 26.5 GHz is investigated with the transmitter set to the lowest, middle, and highest channels in the 2.4 GHz band.



TEST RESULTS

OUT-OF-BAND SPURIOUS EMISSIONS-CONDUCTED MEASUREMENT

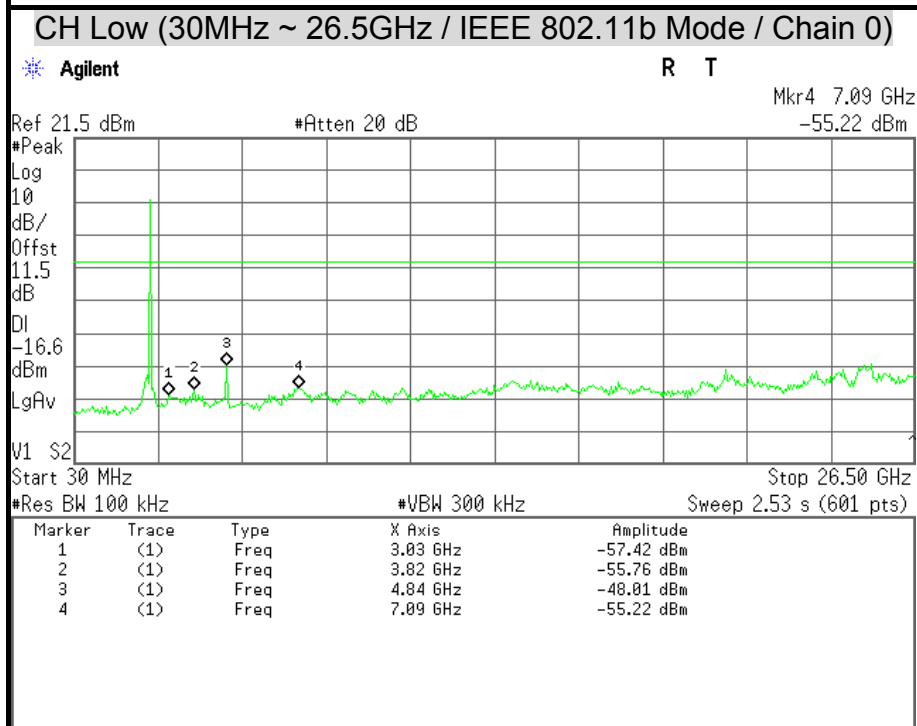
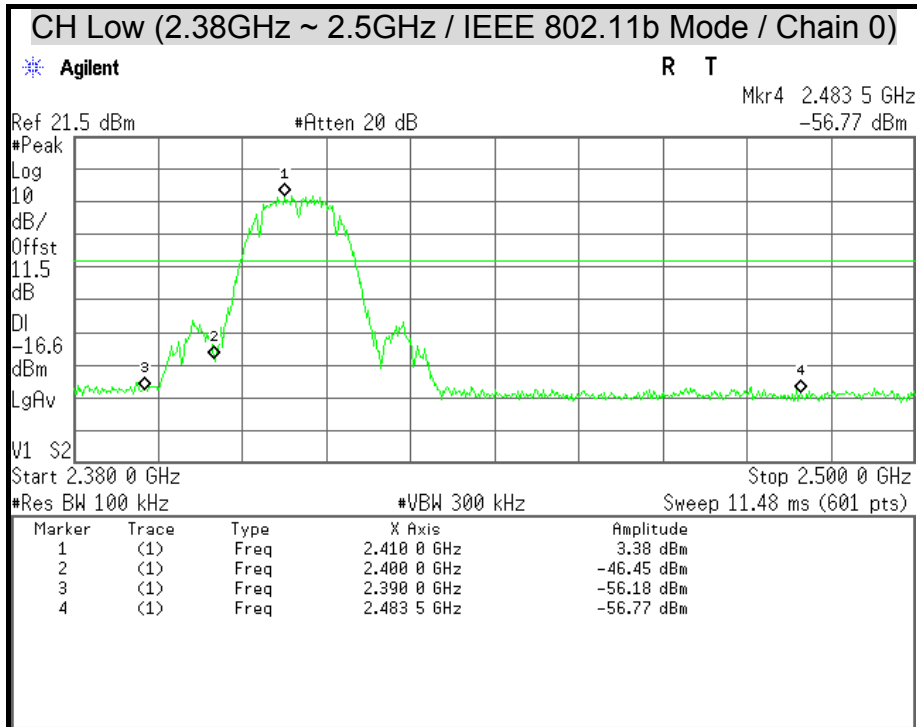

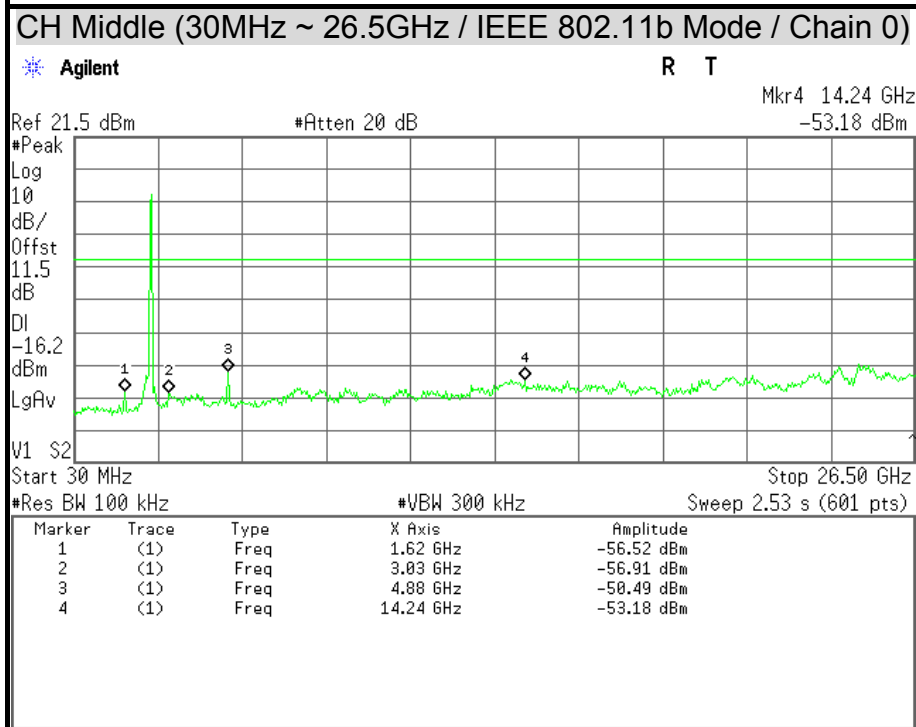
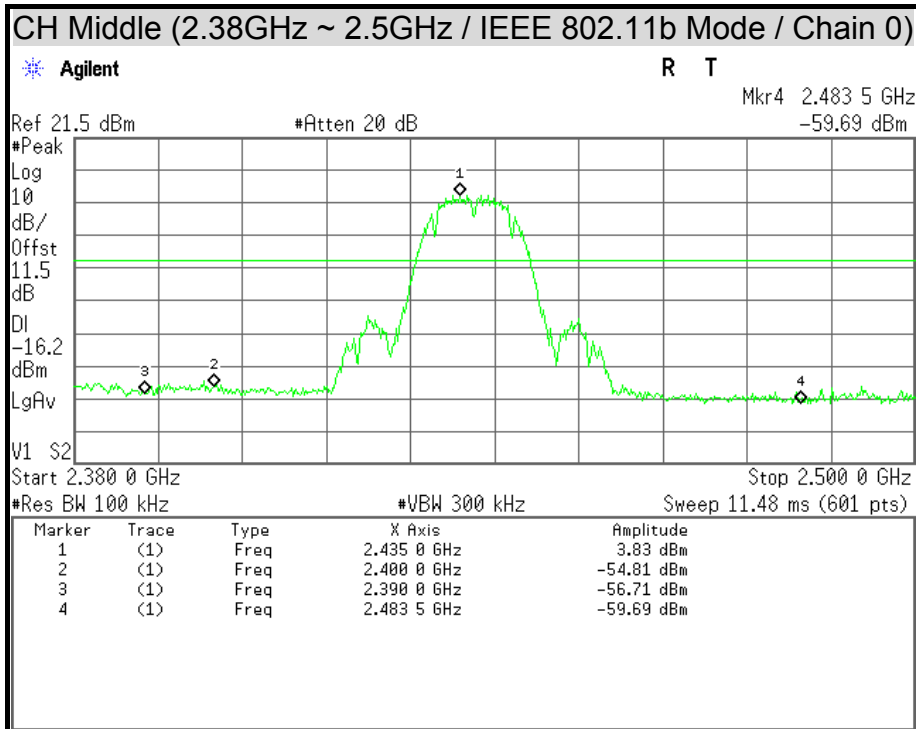

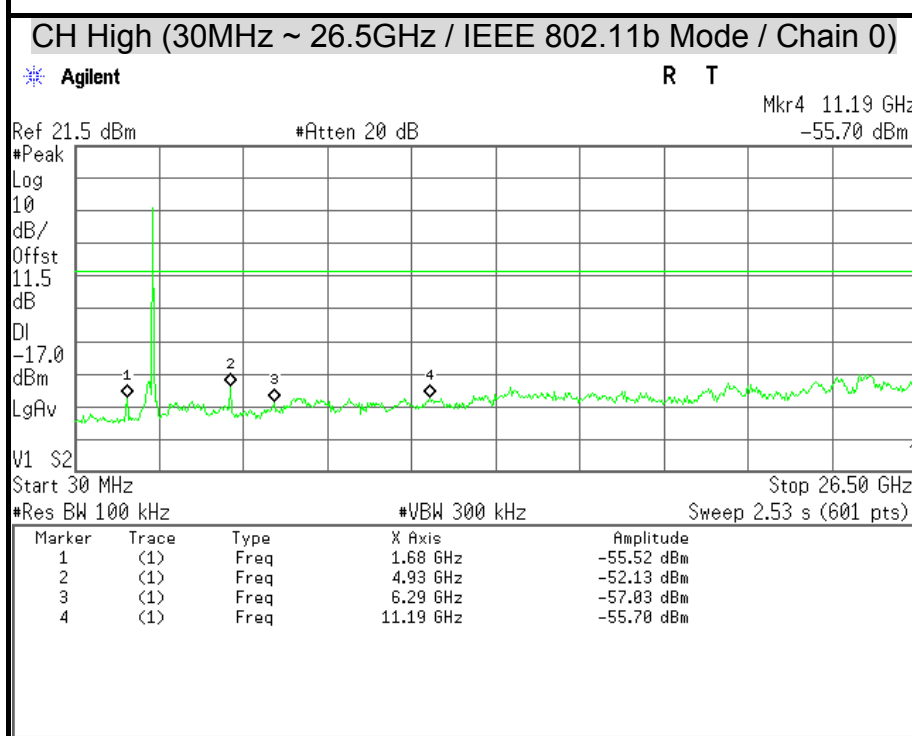
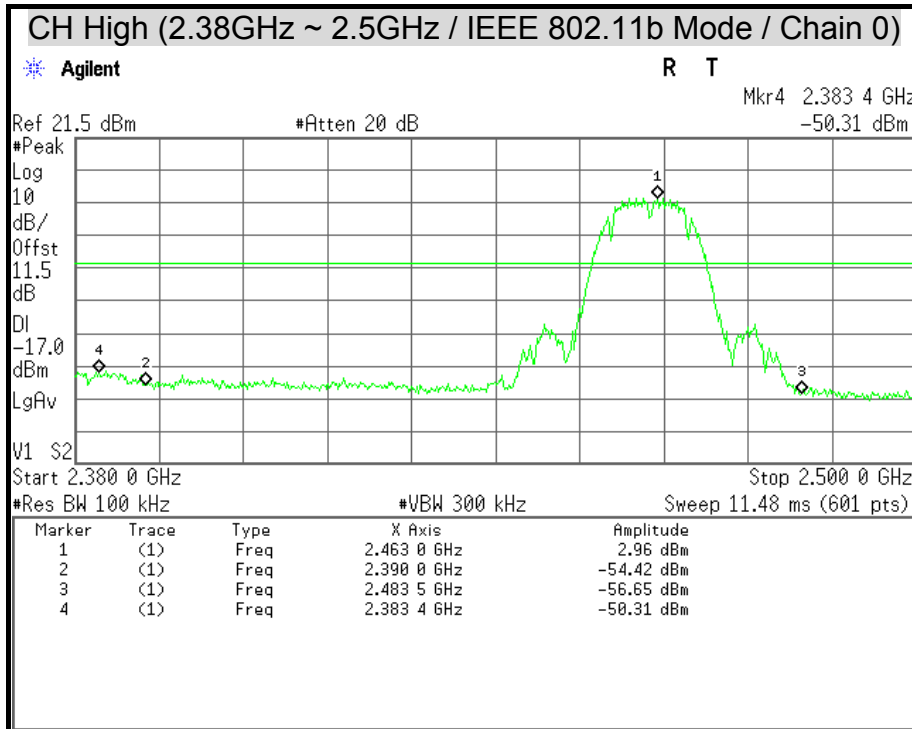

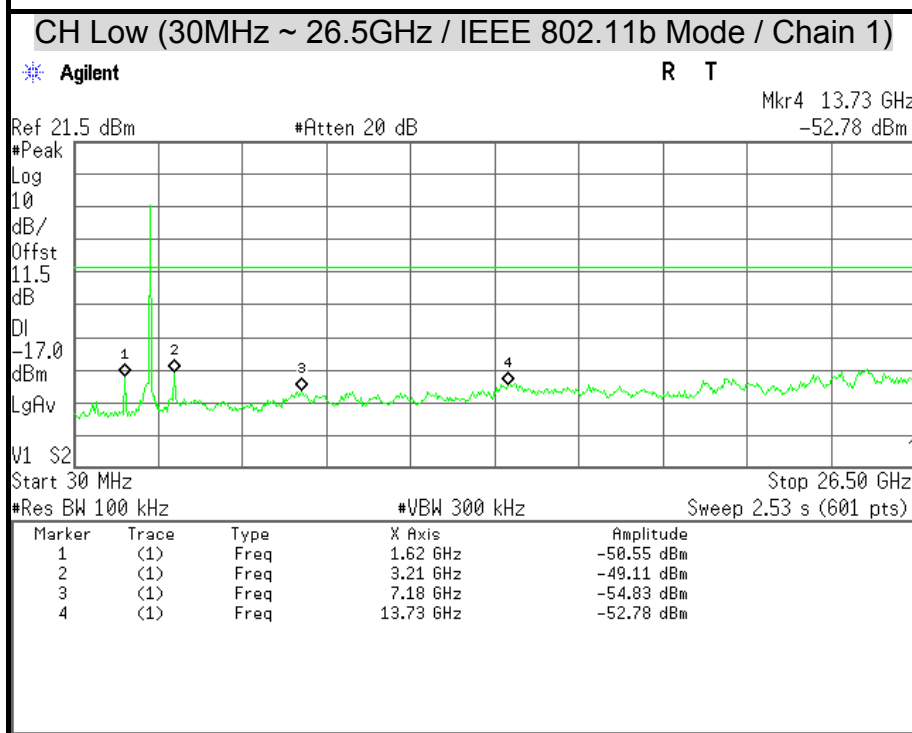
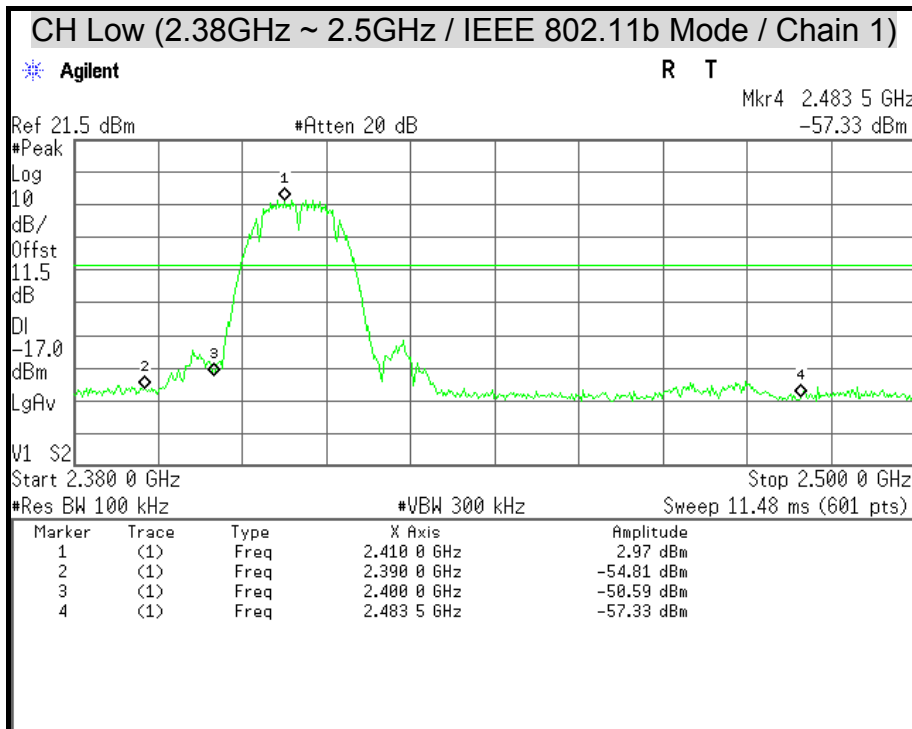

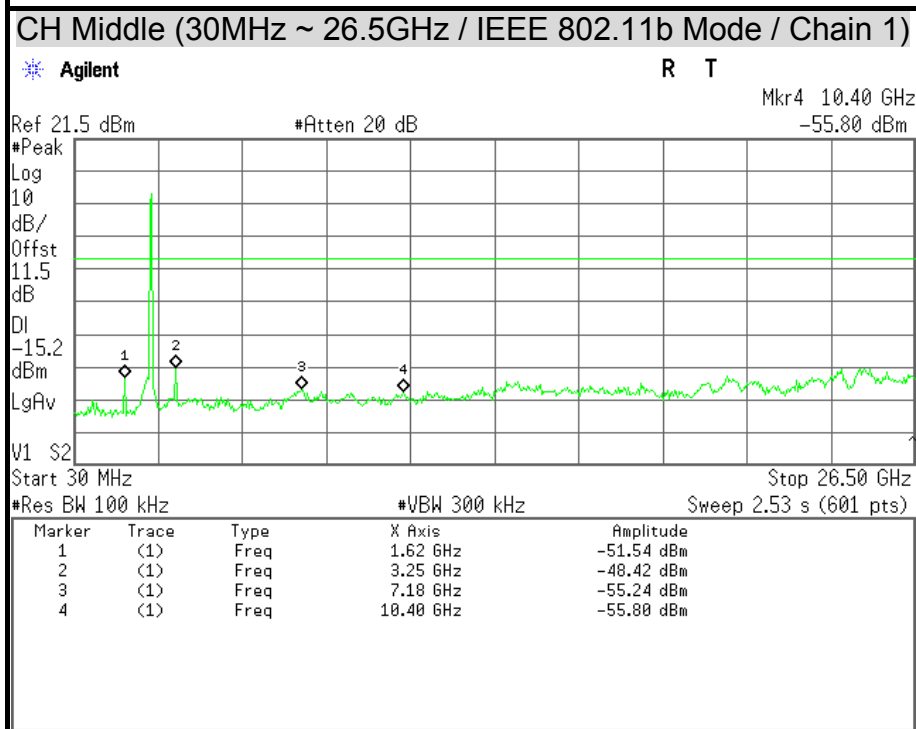
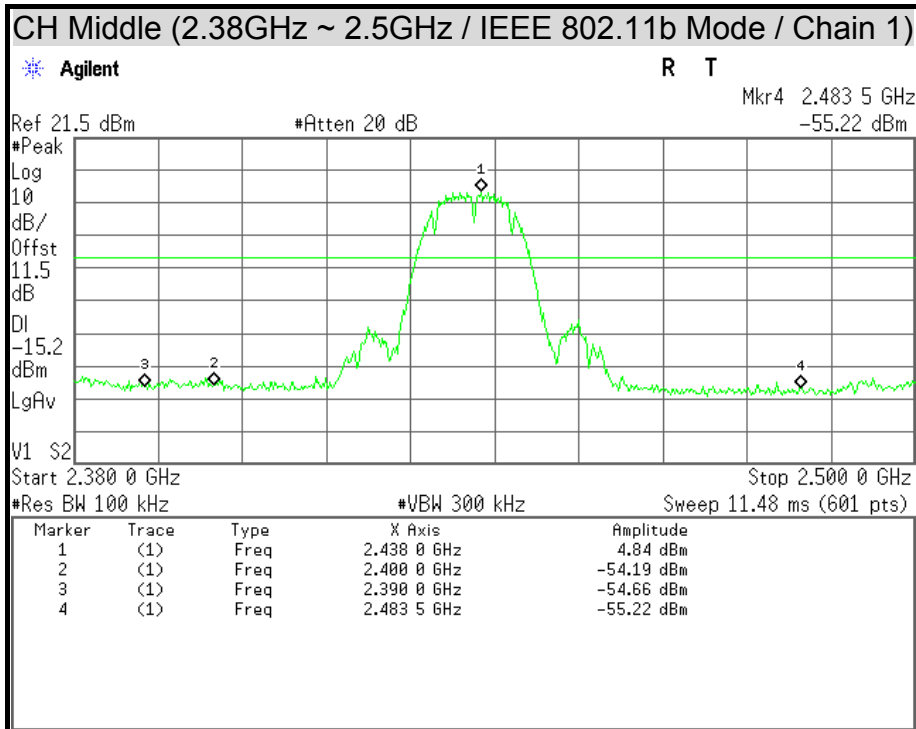

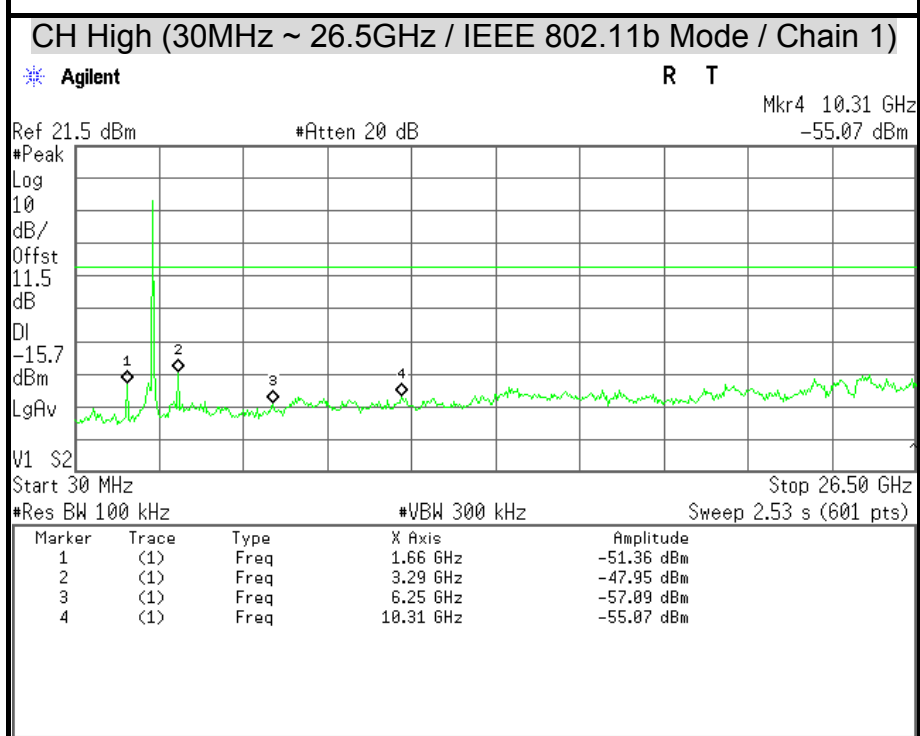
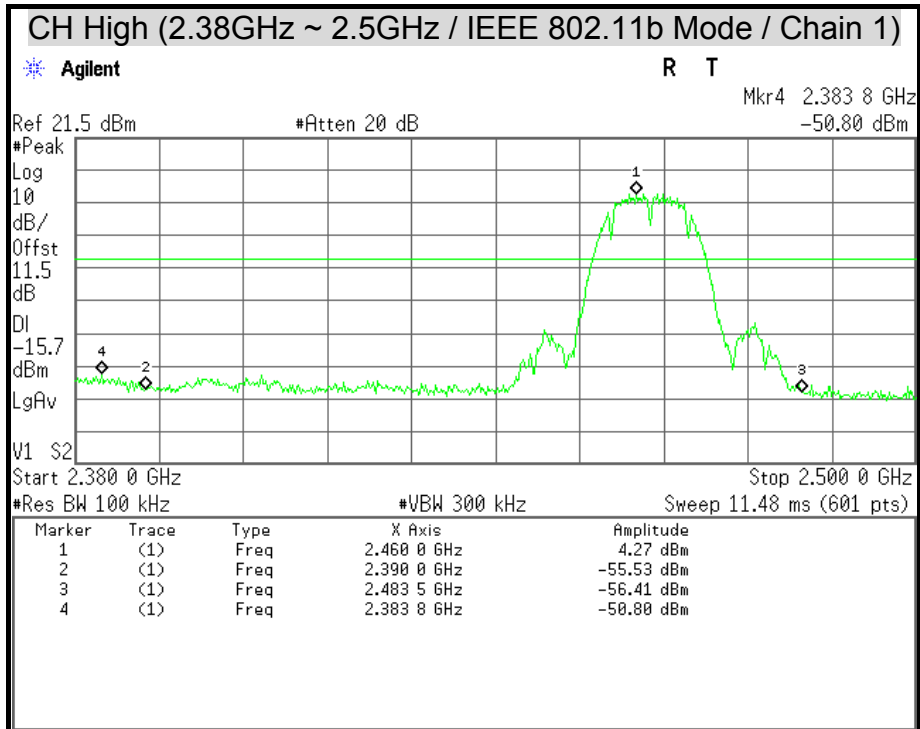

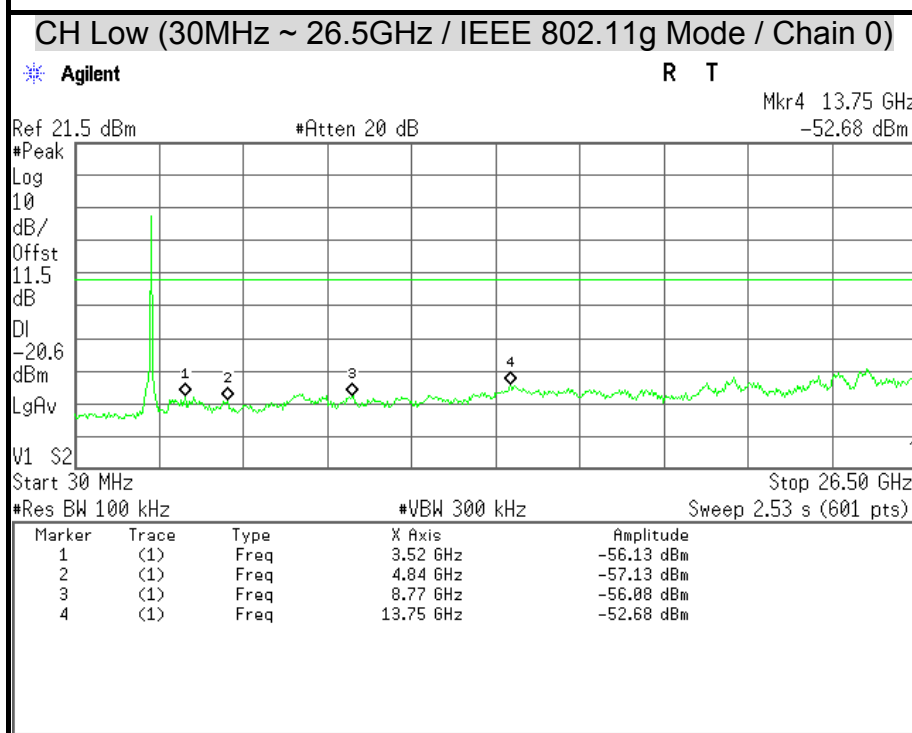
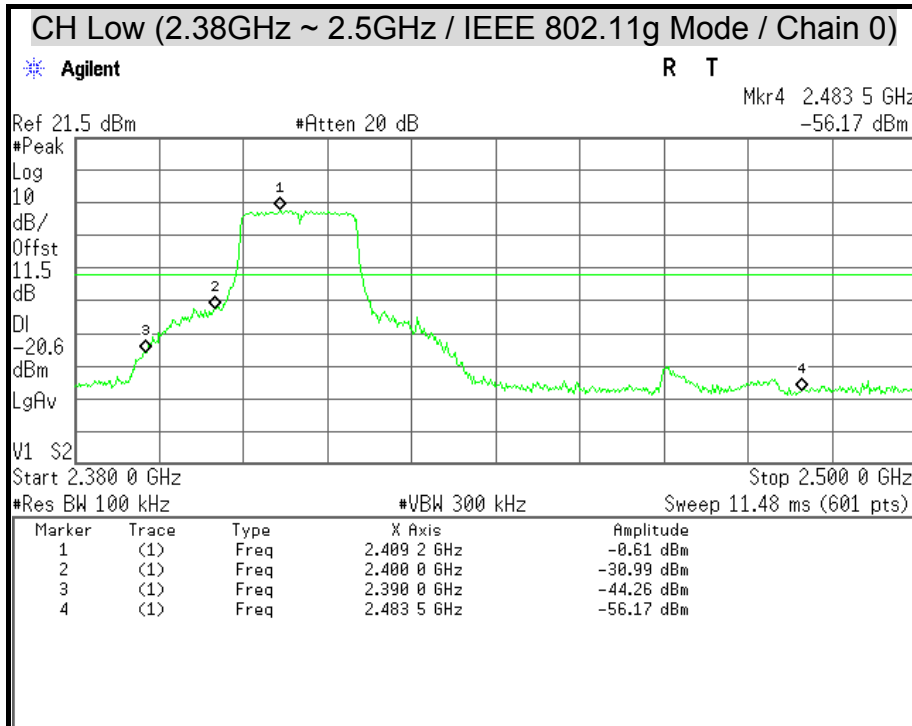

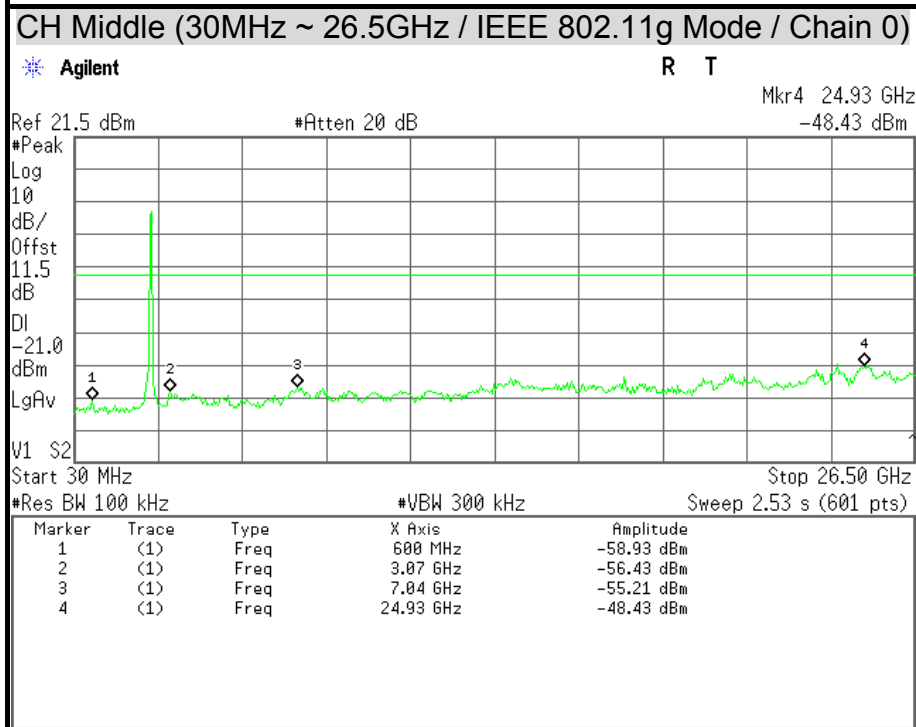
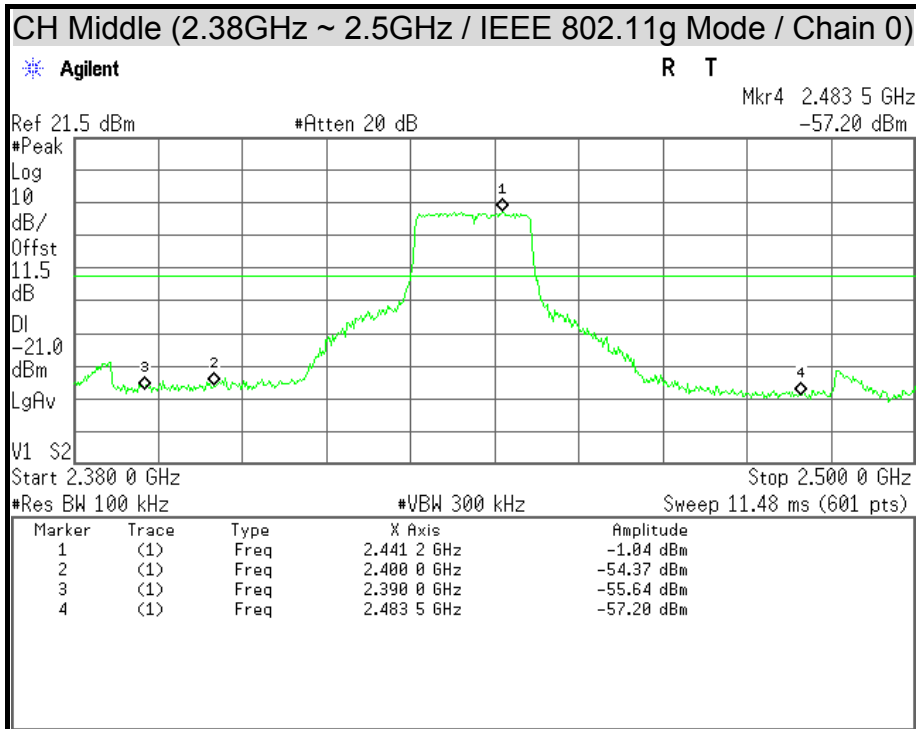

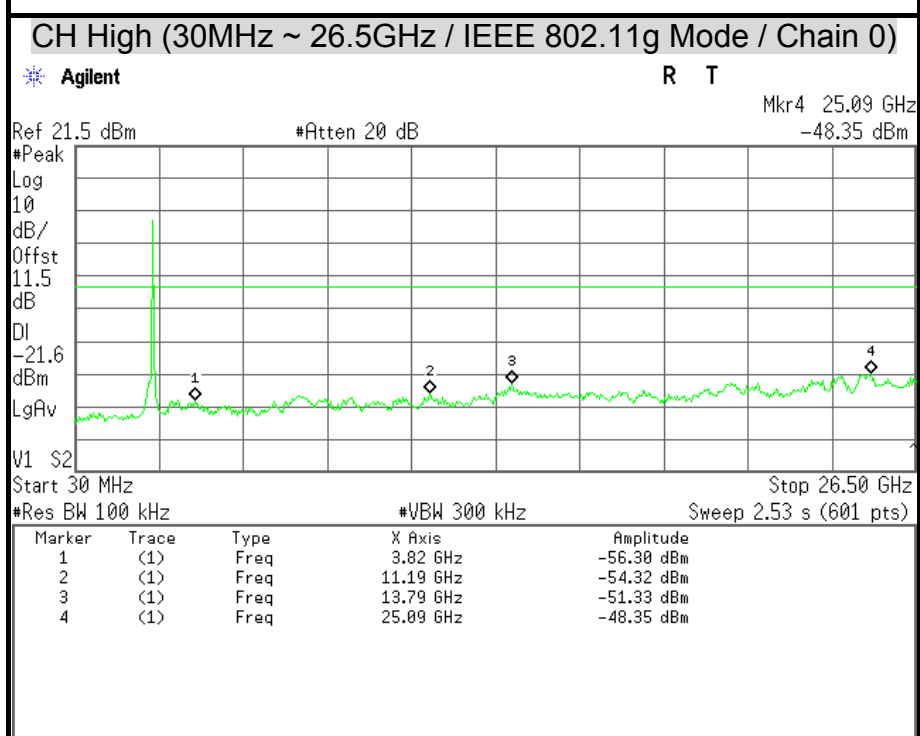
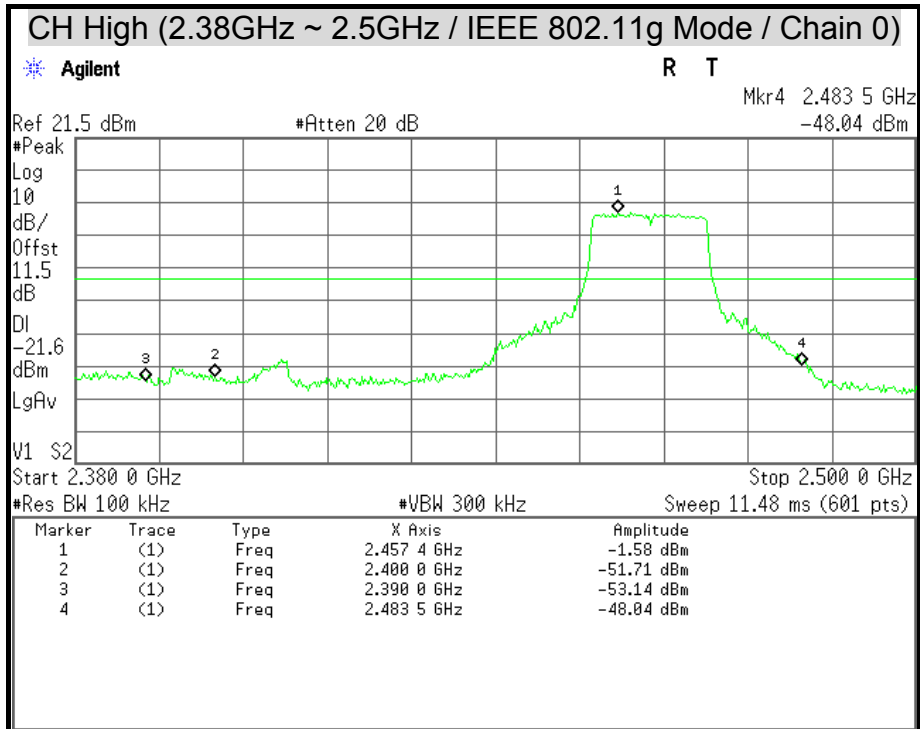

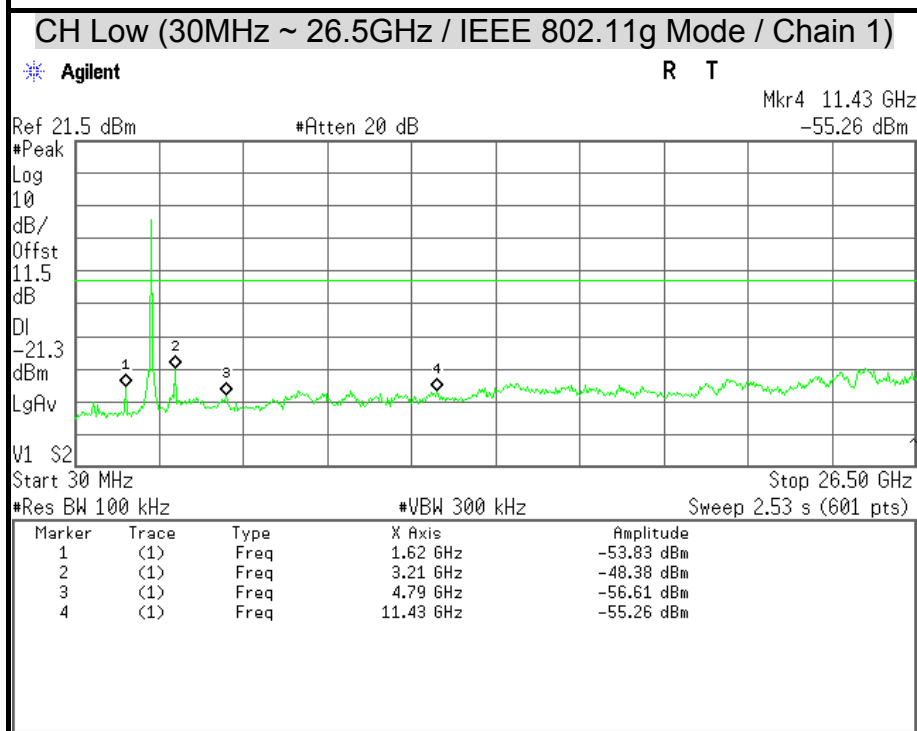
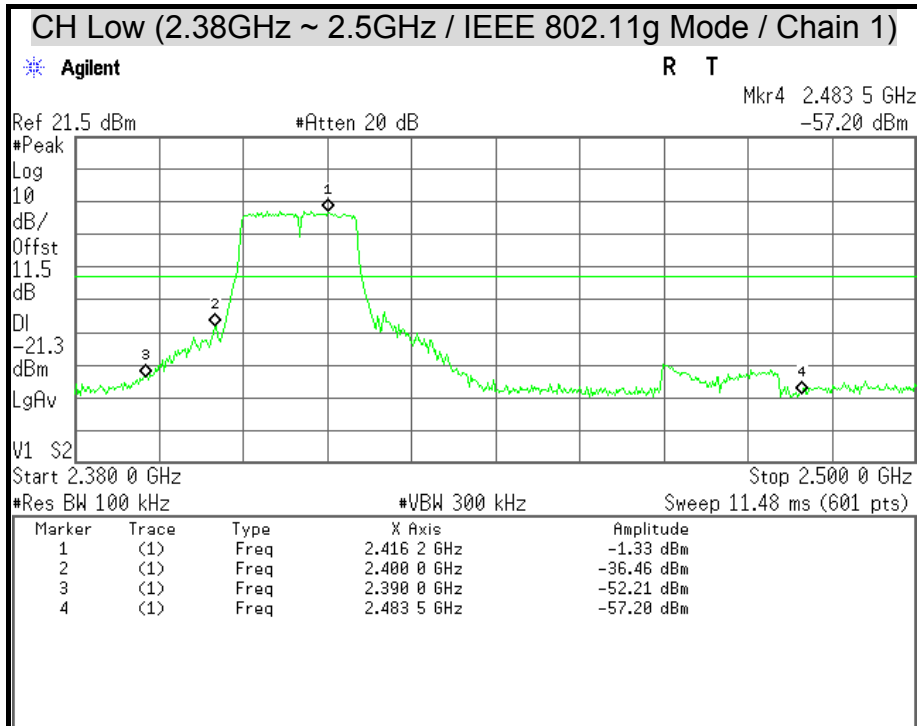

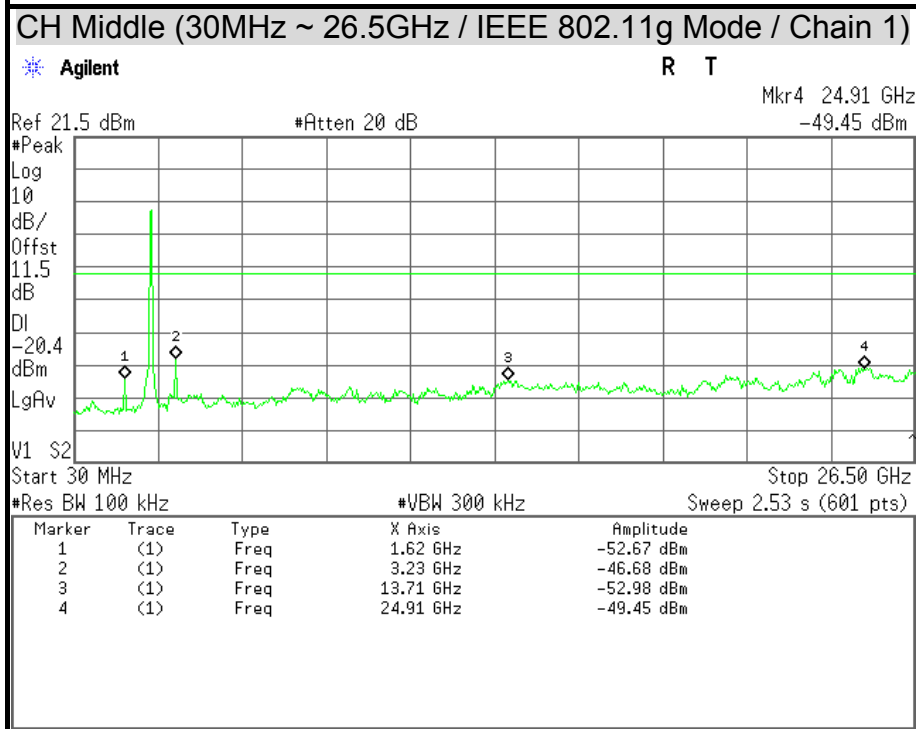
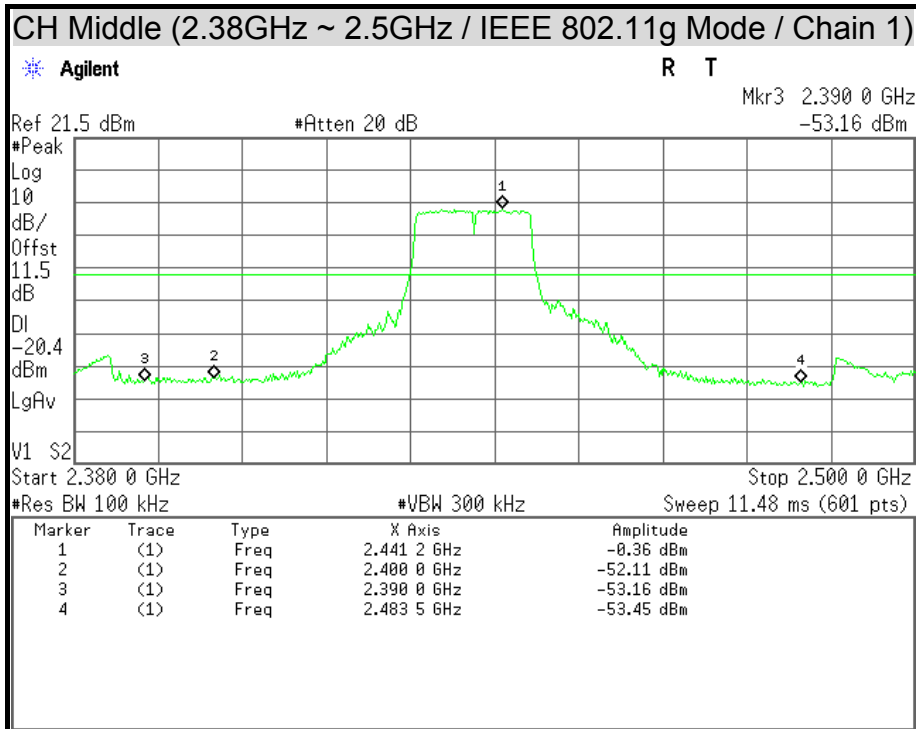

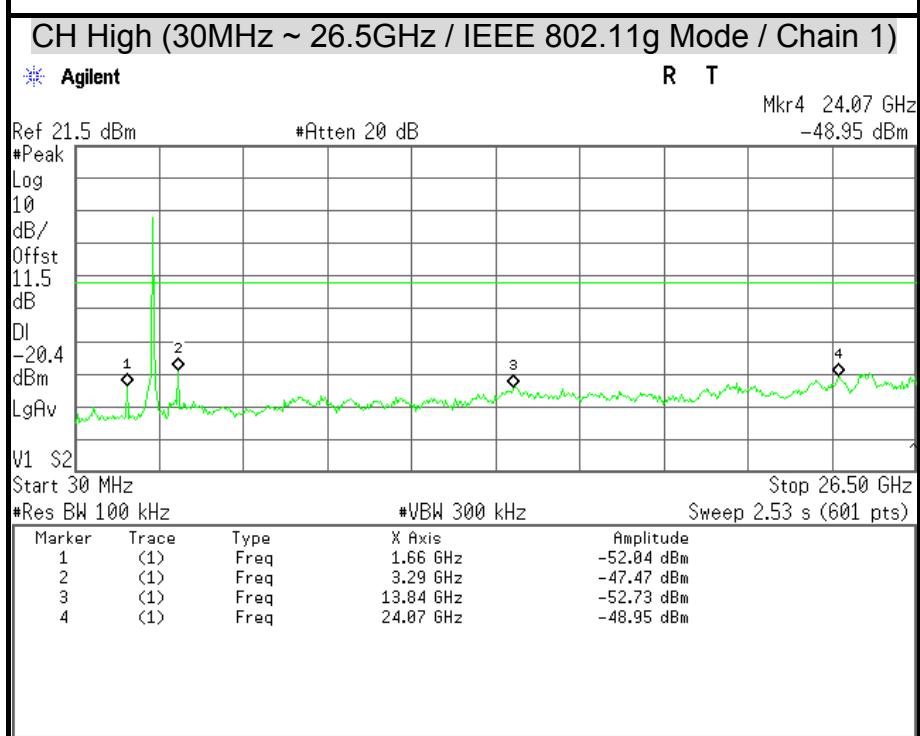
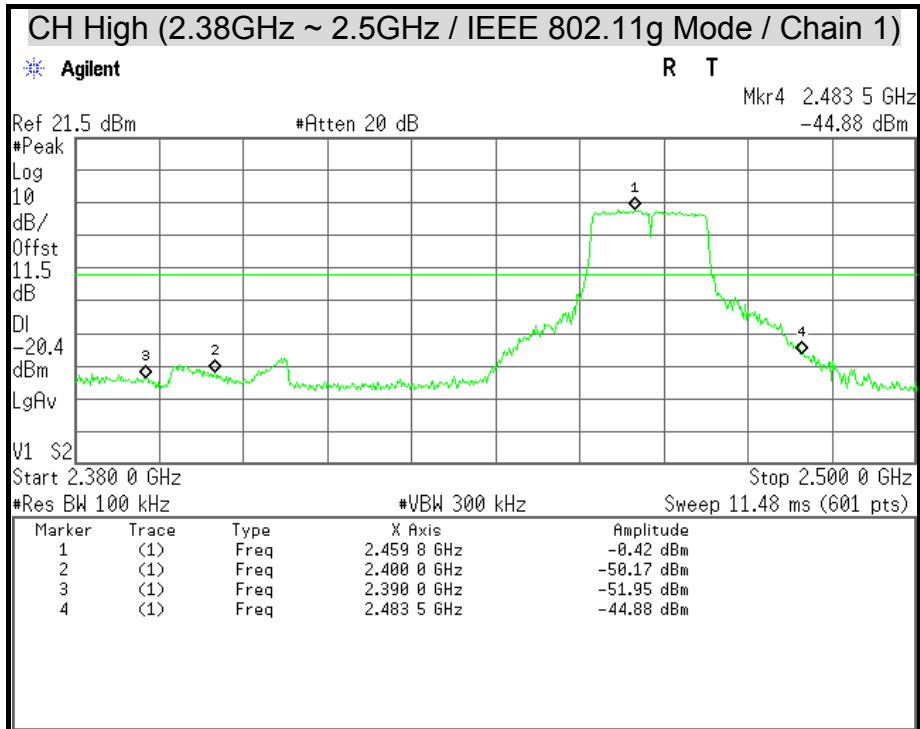

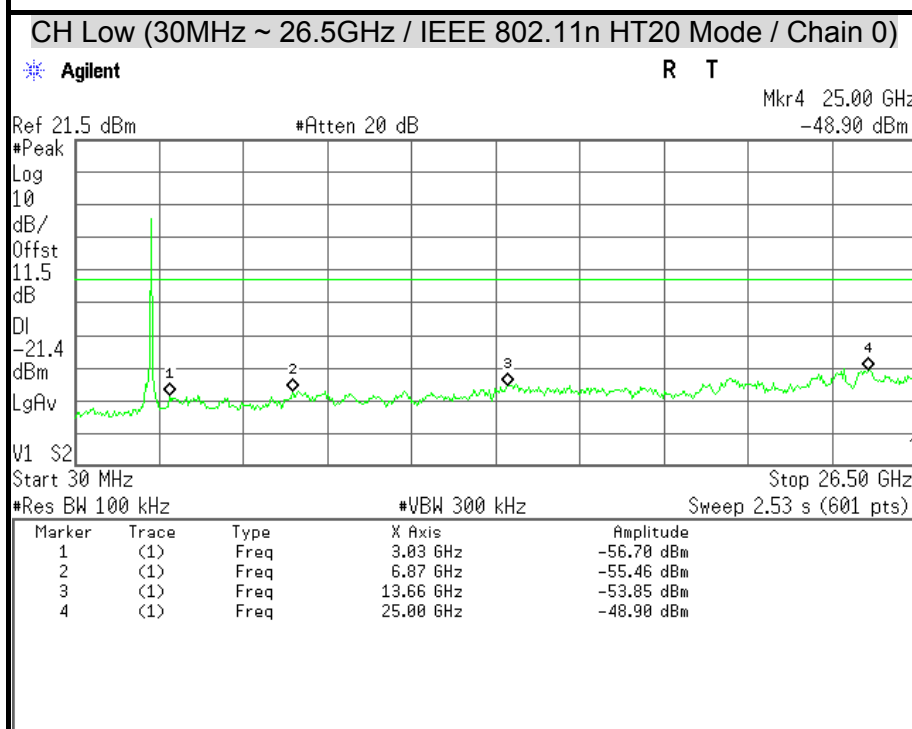
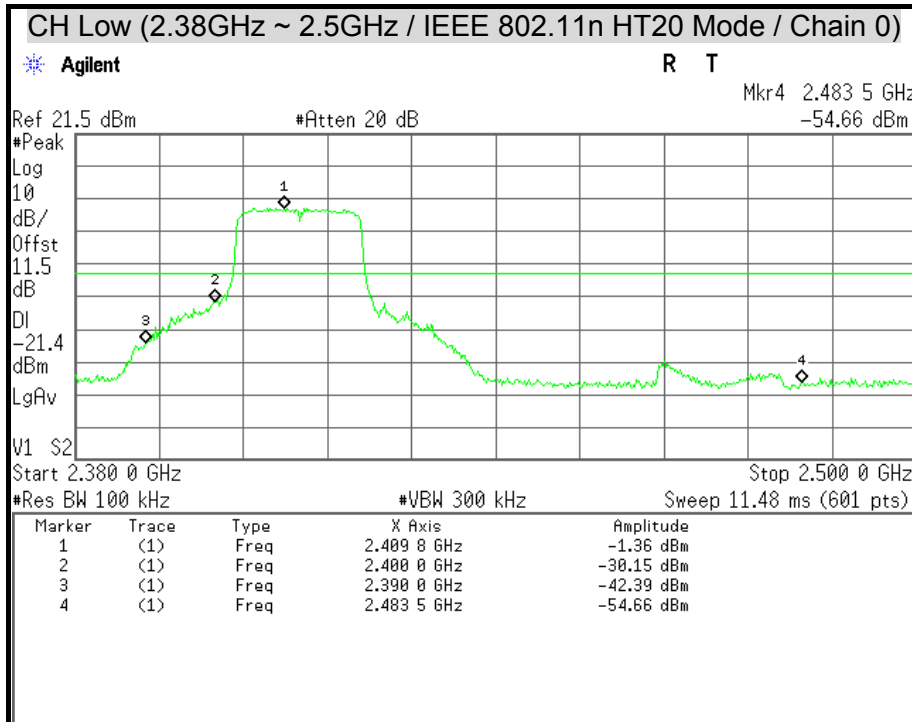

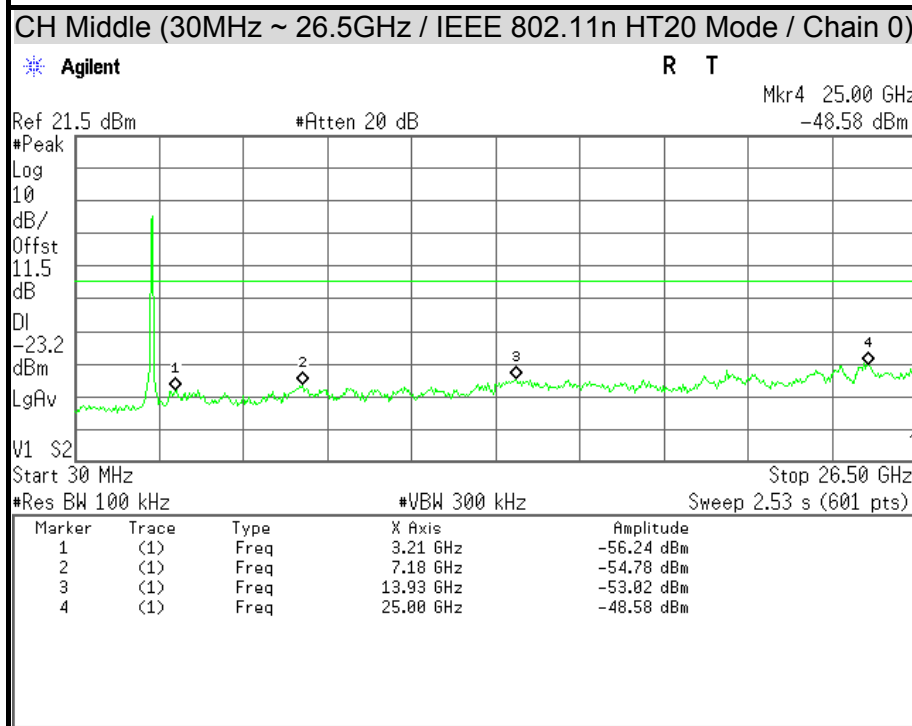
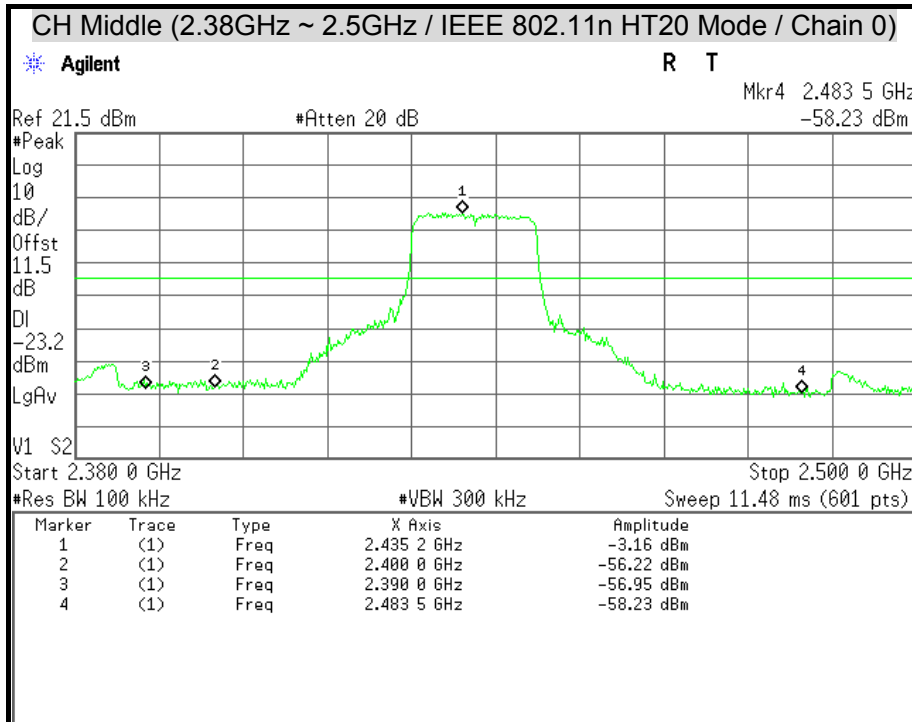

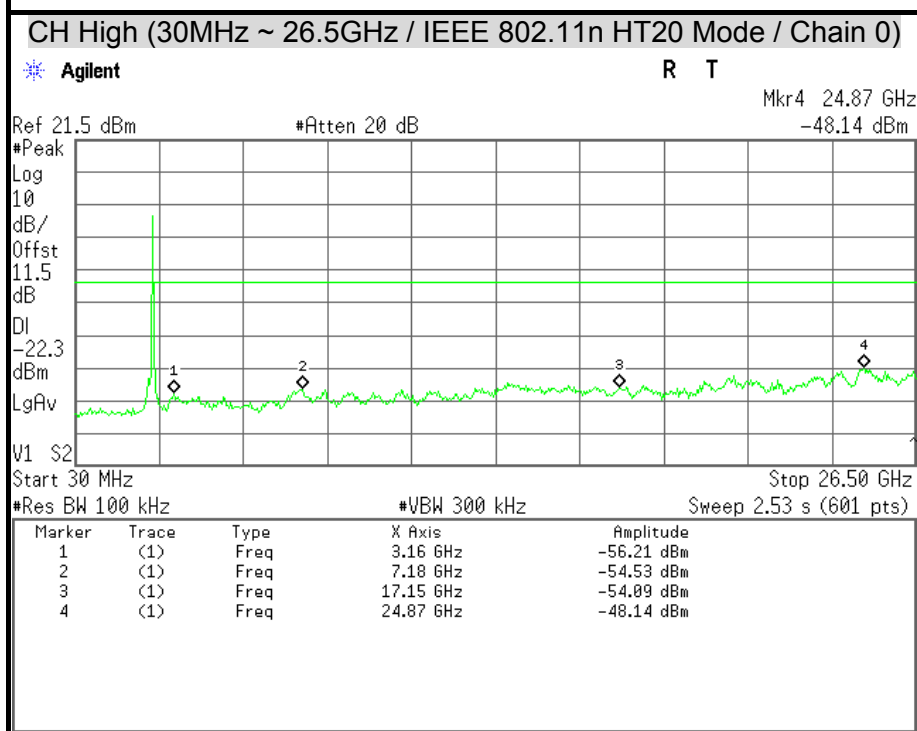
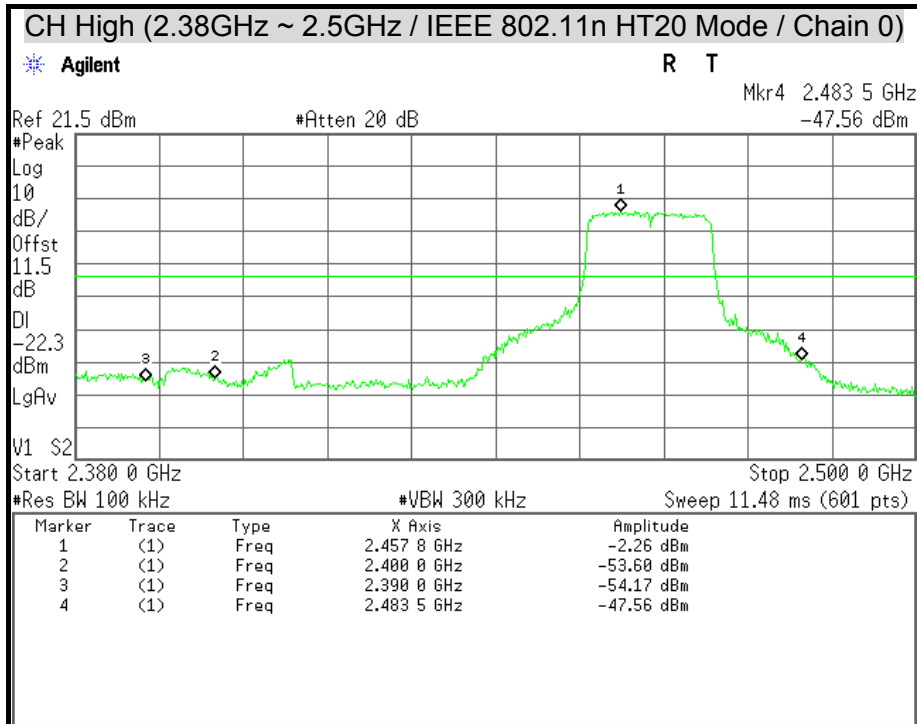

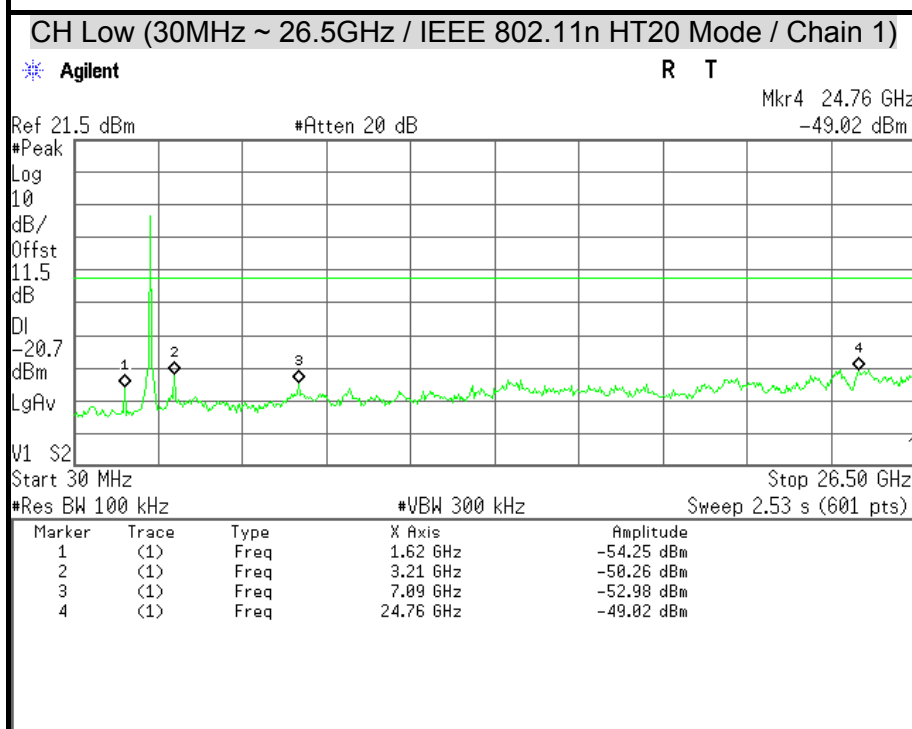
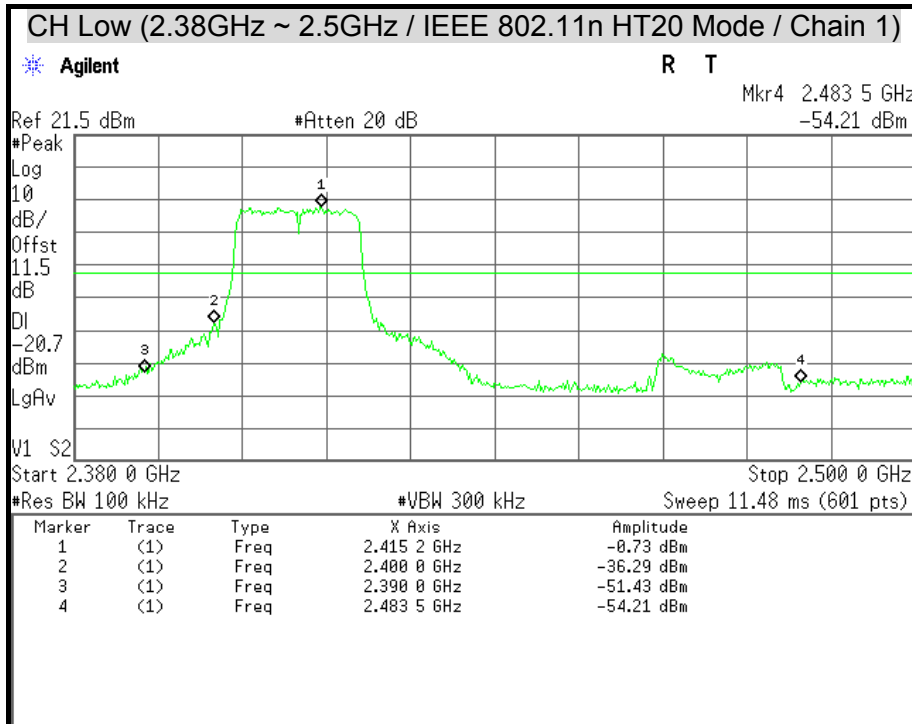

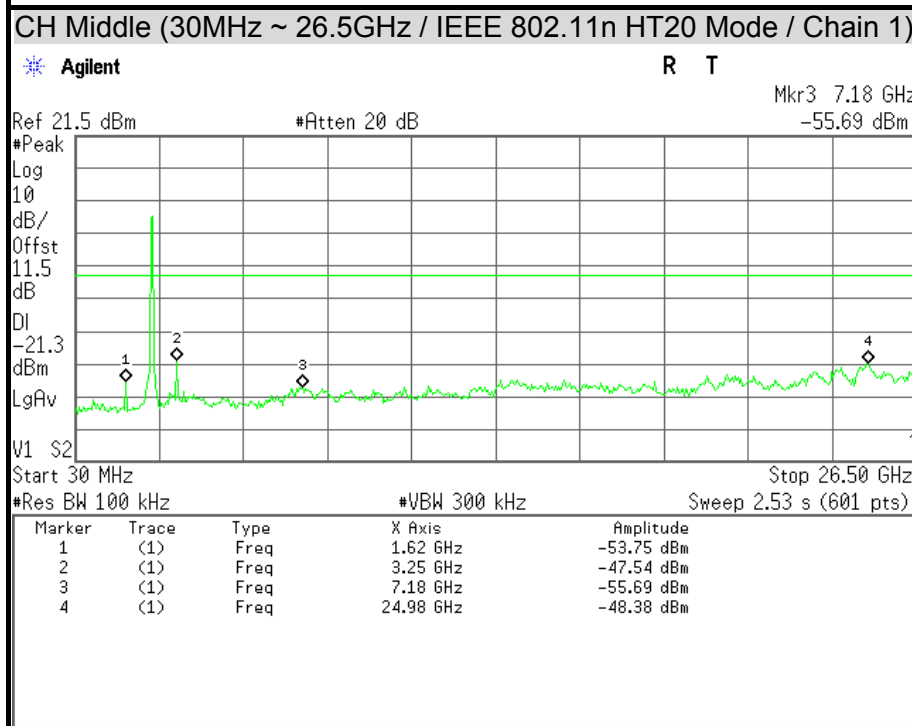
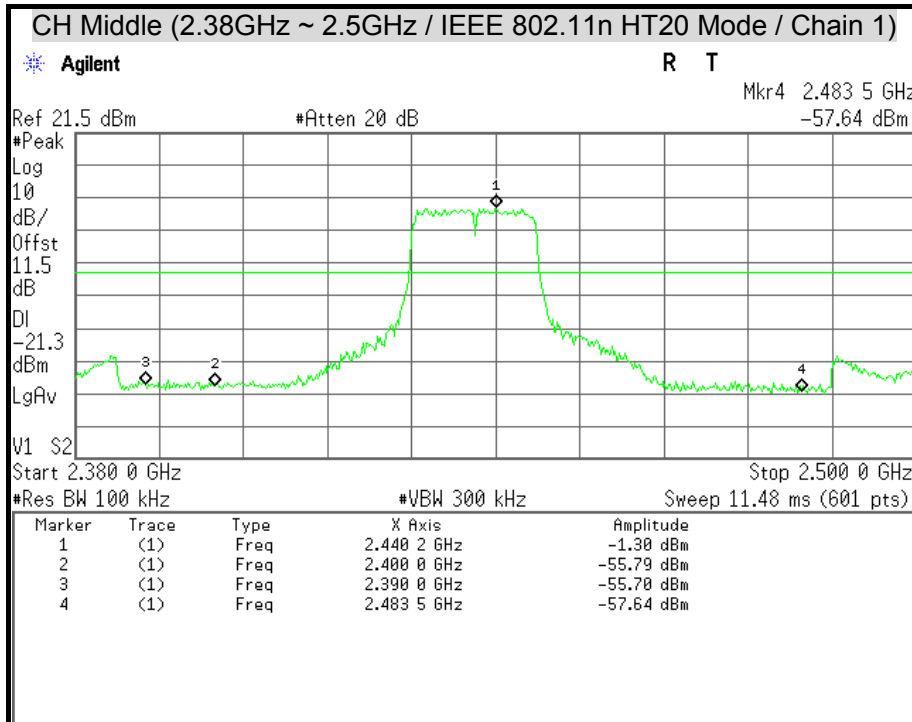

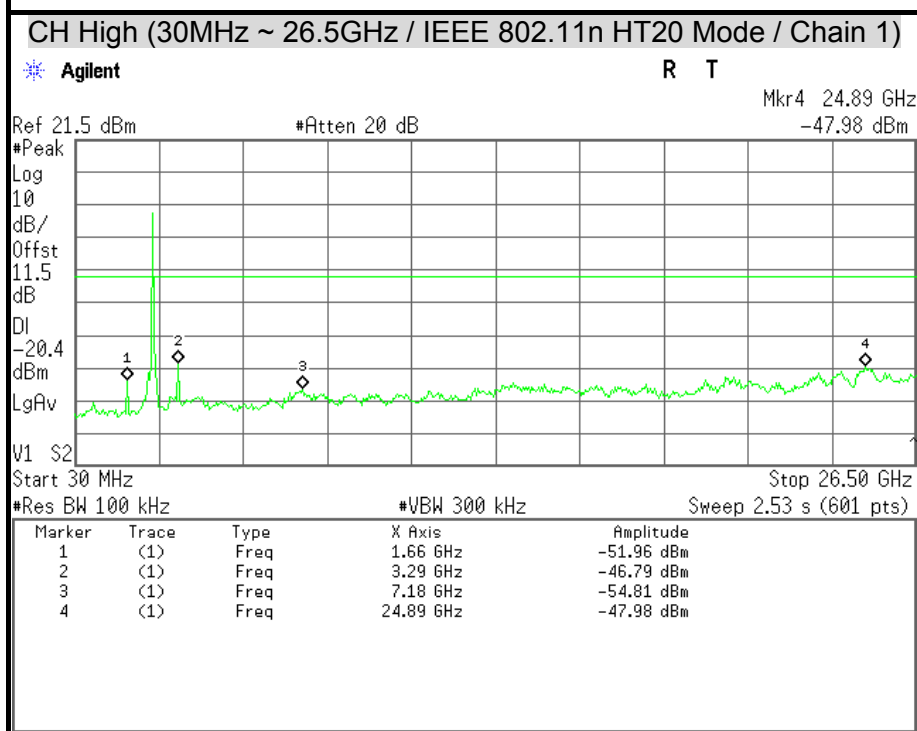
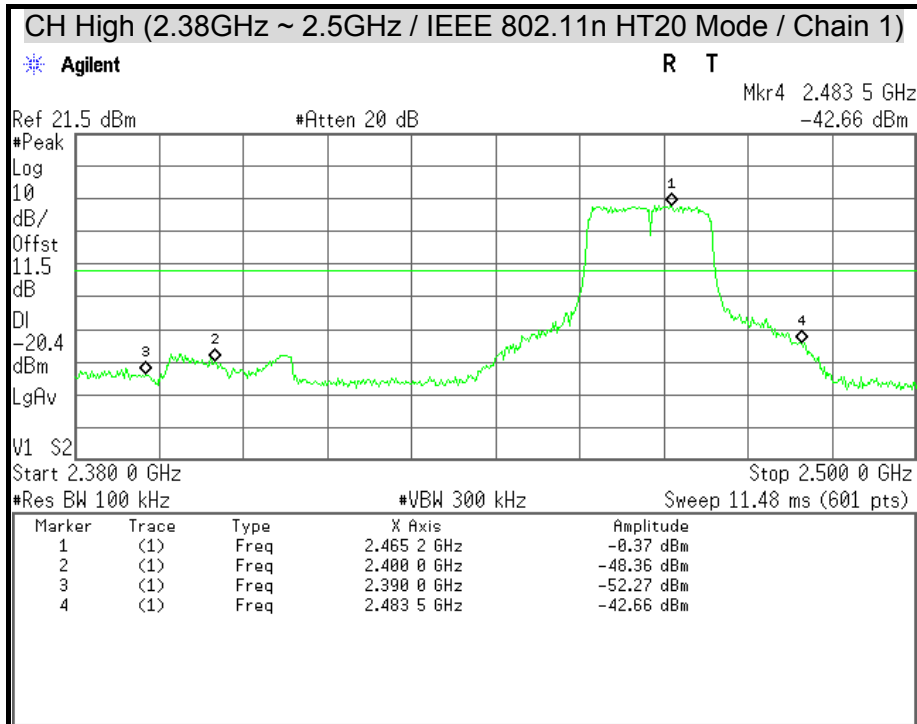

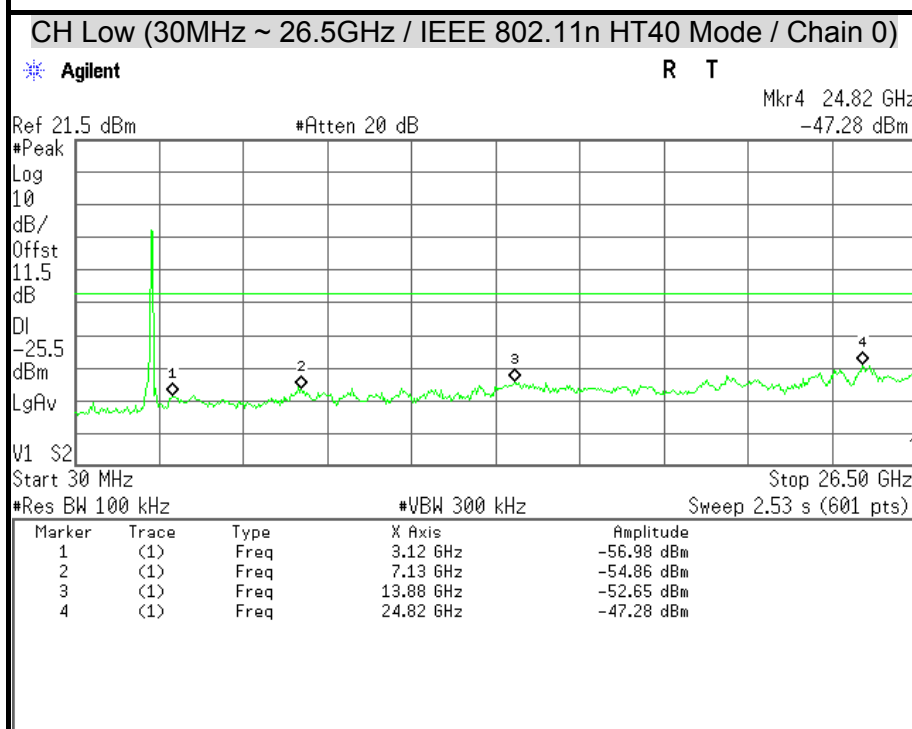
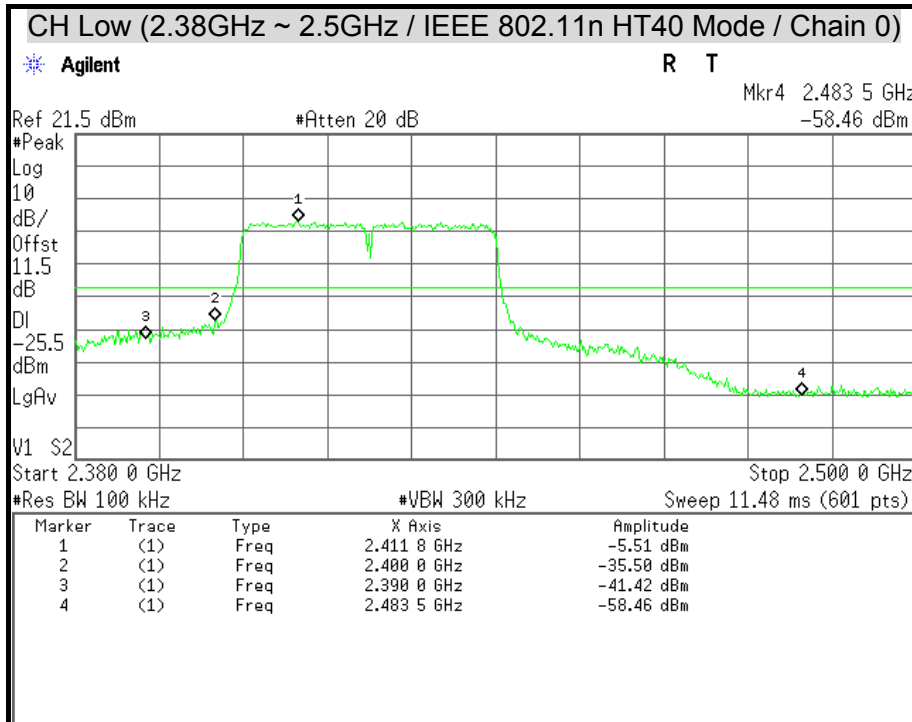

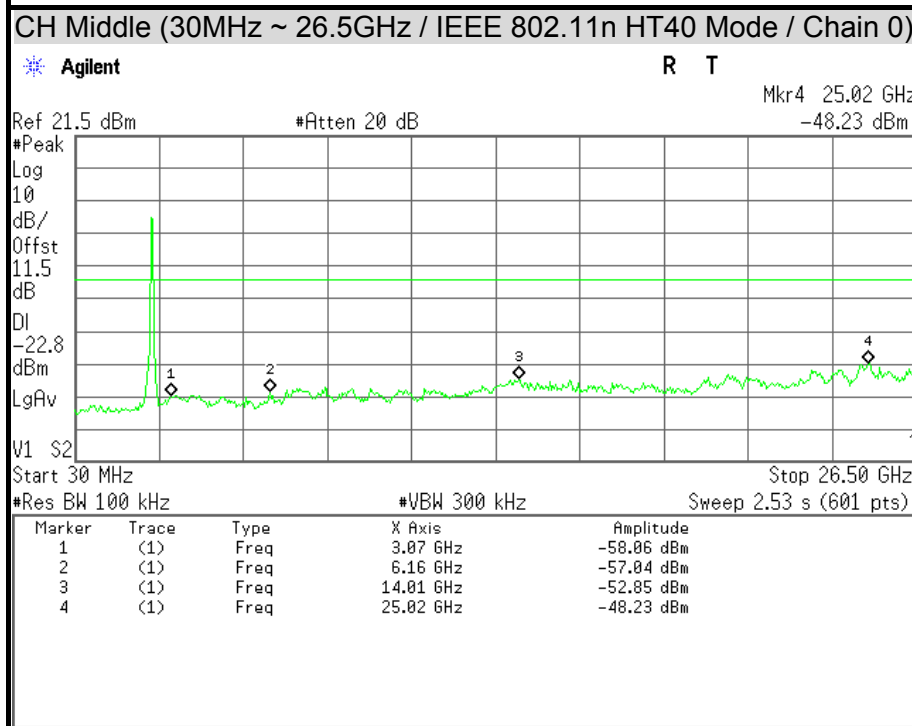
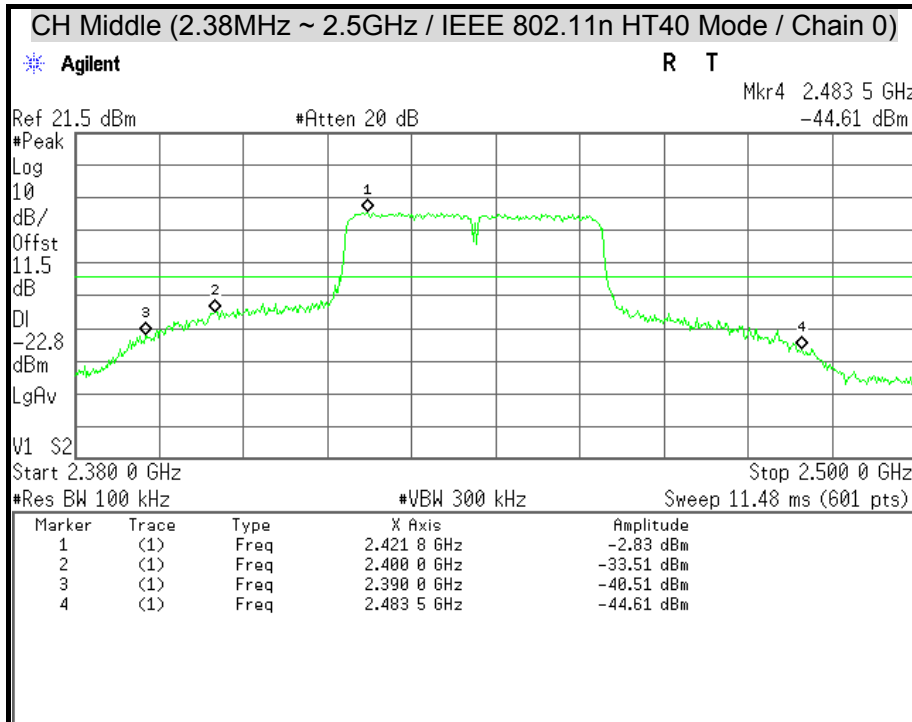

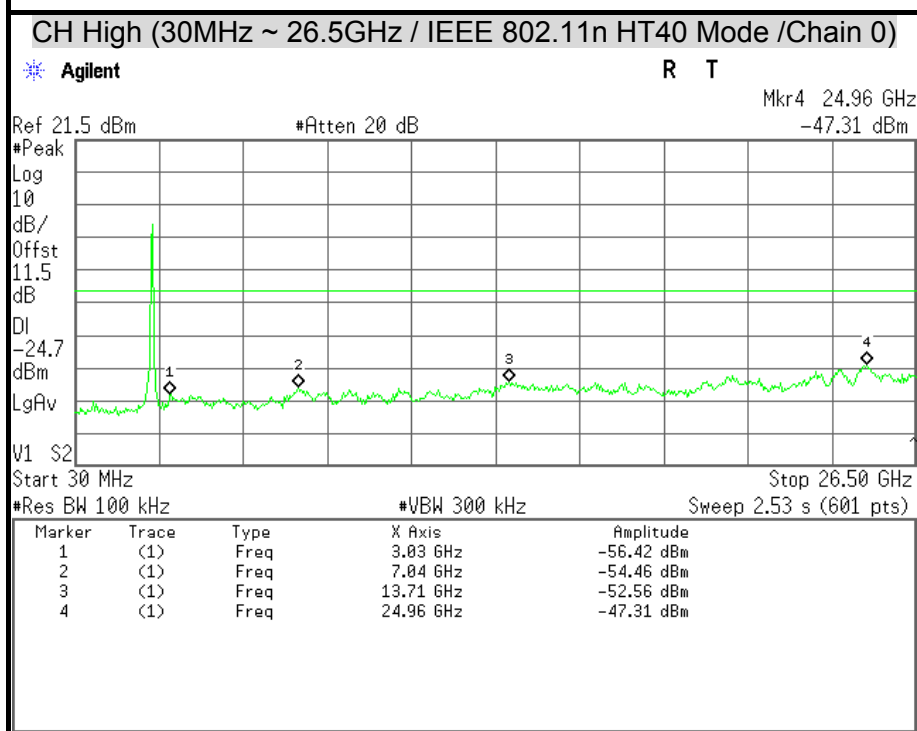
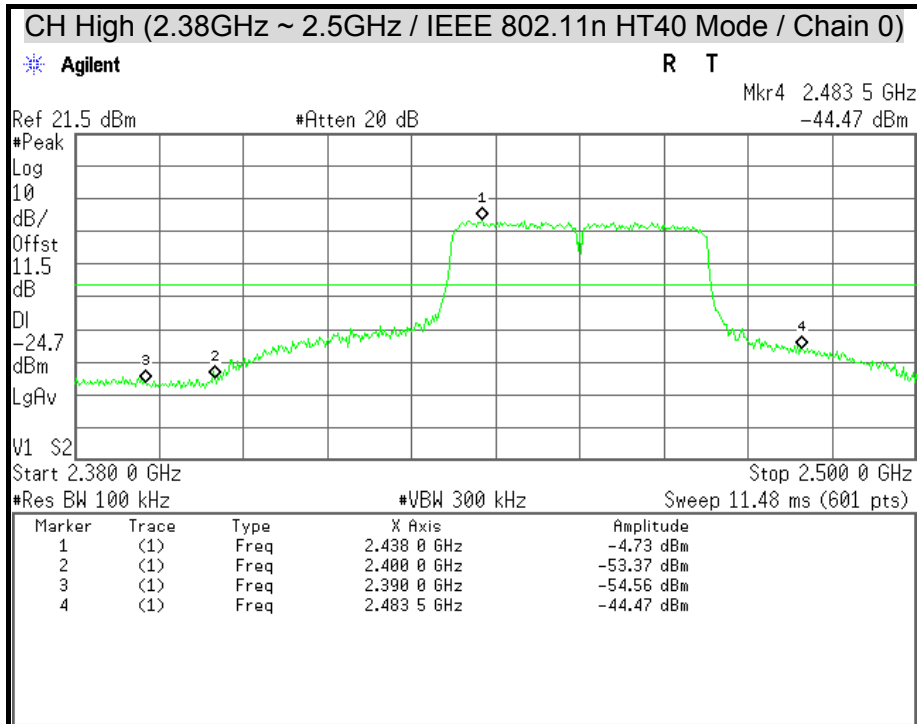

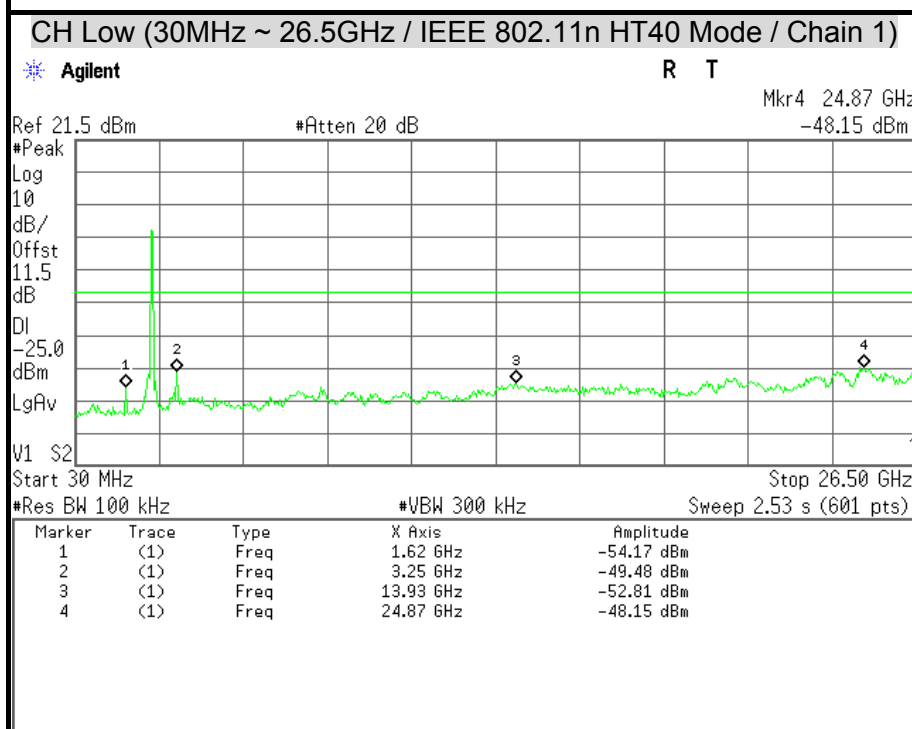
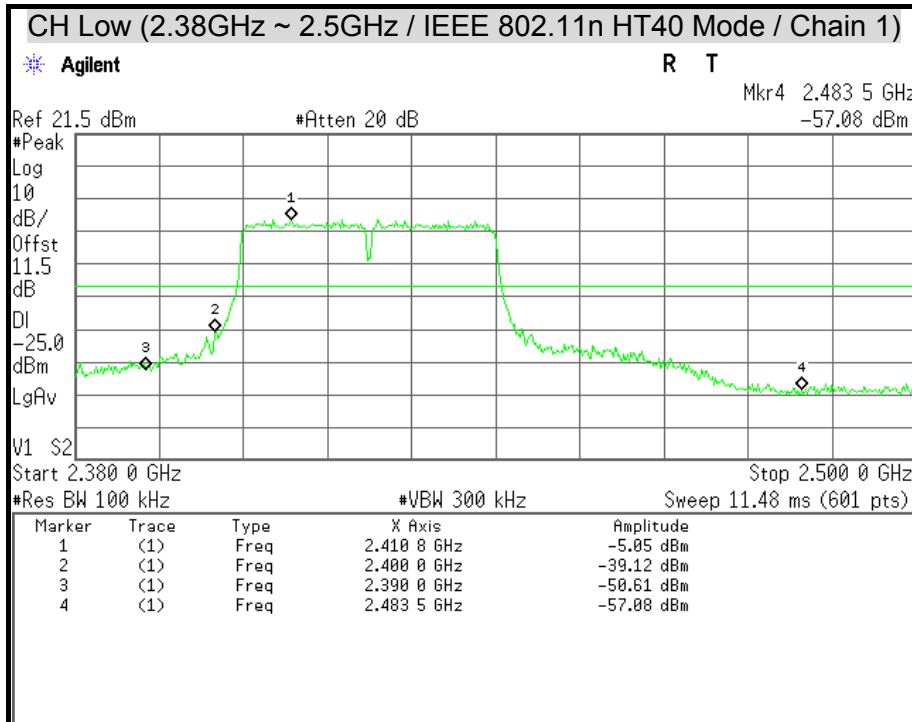

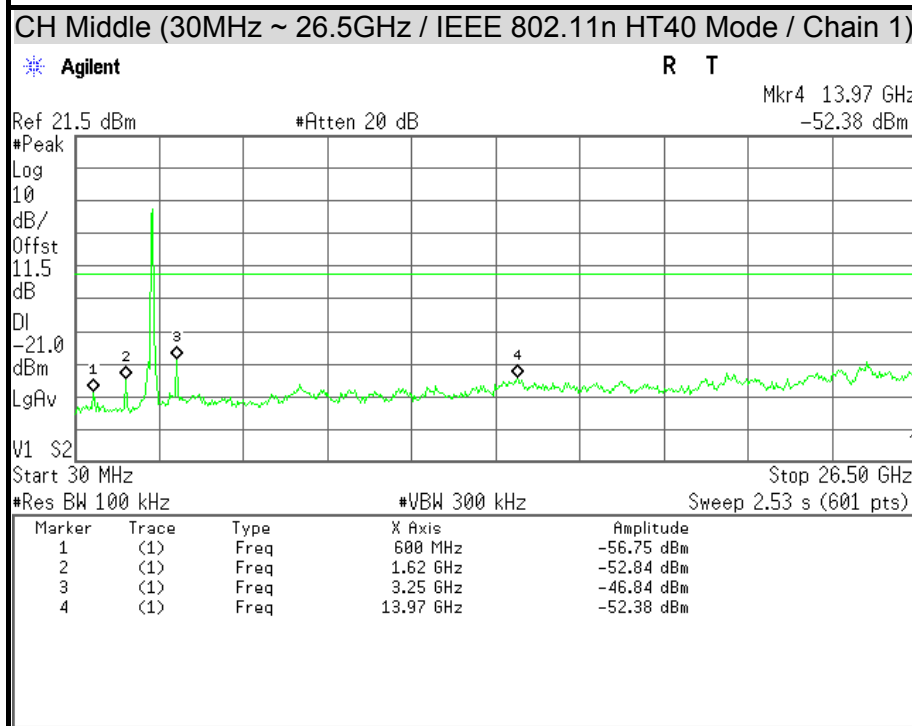
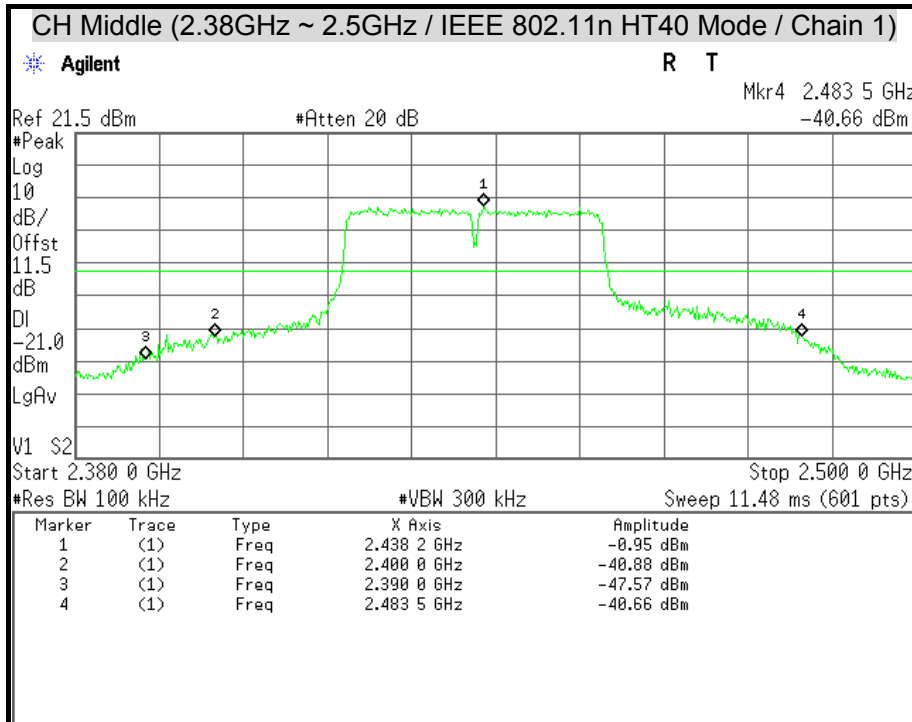

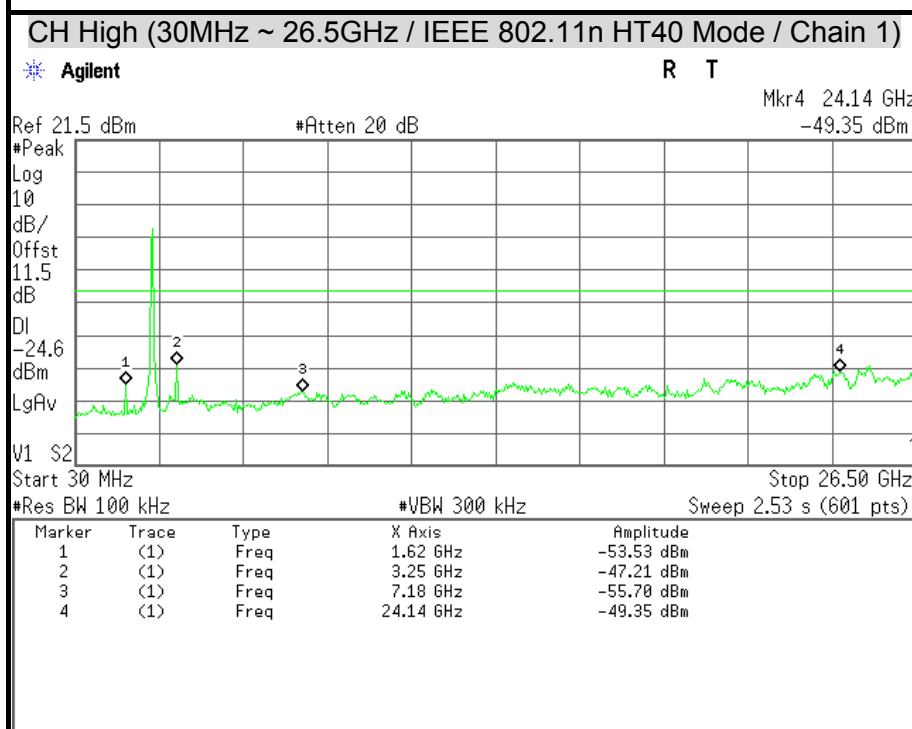
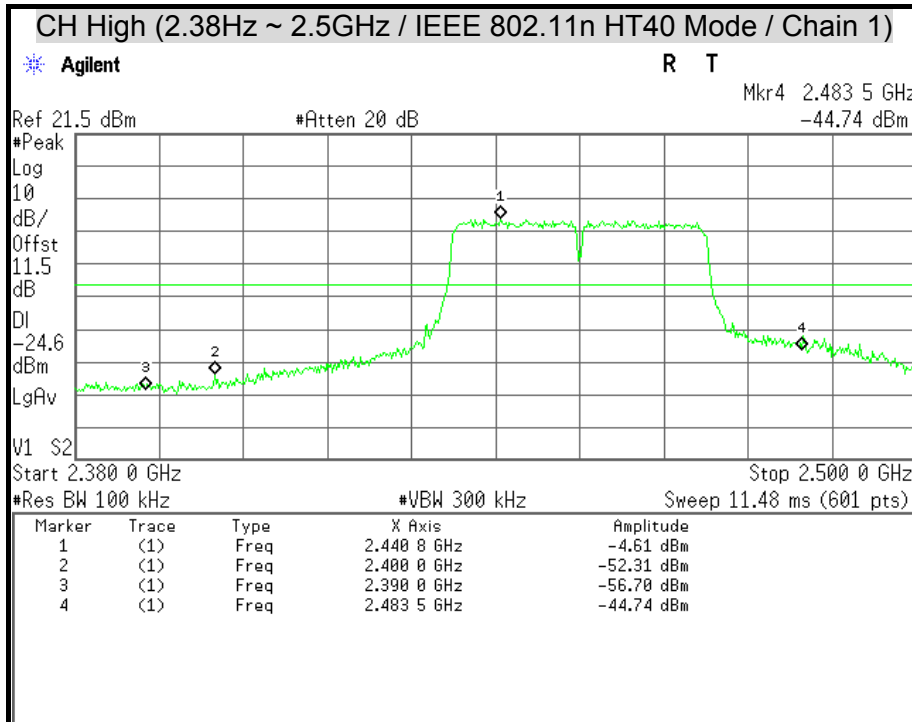



7.5 RADIATED EMISSION

LIMITS

(1) According to § 15.205 (a) Except as shown in paragraph (d) of this section, only spurious emissions are permitted in any of the frequency bands listed below:

MHz	MHz	MHz	GHz
0.090 - 0.110	16.42 - 16.423	399.9 - 410	4.5 - 5.15
¹ 0.495 - 0.505	16.69475 - 16.69525	608 - 614	5.35 - 5.46
2.1735 - 2.1905	16.80425 - 16.80475	960 - 1240	7.25 - 7.75
4.125 - 4.128	25.5 - 25.67	1300 - 1427	8.025 - 8.5
4.17725 - 4.17775	37.5 - 38.25	1435 - 1626.5	9.0 - 9.2
4.20725 - 4.20775	73 - 74.6	1645.5 - 1646.5	9.3 - 9.5
6.215 - 6.218	74.8 - 75.2	1660 -1710	10.6 -12.7
6.26775 - 6.26825	108 -121.94	1718.8 - 1722.2	13.25 -13.4
6.31175 - 6.31225	123 - 138	2200 - 2300	14.47 – 14.5
8.291 - 8.294	149.9 - 150.05	2310 - 2390	15.35 -16.2
8.362 - 8.366	156.52475 - 156.52525	2483.5 - 2500	17.7 - 21.4
8.37625 - 8.38675	156.7 - 156.9	2655 - 2900	22.01 - 23.12
8.41425 - 8.41475	162.0125 - 167.17	3260 - 3267	23.6 - 24.0
12.29 - 12.293	167.72 - 173.2	3332 - 3339	31.2 - 31.8
12.51975 - 12.52025	240 - 285	3345.8 - 3338	36.43 - 36.5
12.57675 - 12.57725	322 -335.4	3600 - 4400	(²)
13.36 - 13.41			

Remark:

1. ¹ Until February 1, 1999, this restricted band shall be 0.490-0.510 MHz.
2. ² Above 38.6

(2) According to § 15.205 (b) Except as provided in paragraphs (d) and (e), the field strength of emissions appearing within these frequency bands shall not exceed the limits shown in Section 15.209. At frequencies equal to or less than 1000 MHz, compliance with the limits in Section 15.209 shall be demonstrated using measurement instrumentation employing a CISPR quasi-peak detector. Above 1000 MHz, compliance with the emission limits in Section 15.209 shall be demonstrated based on the average value of the measured emissions. The provisions in Section 15.35 apply to these measurements.



(3) According to § 15.209 (a) Except as provided elsewhere in this Subpart, the emissions from an intentional radiator shall not exceed the field strength levels specified in the following table :

Frequency (MHz)	Field Strength (microvolts/meter)	Measurement Distance (meters)
0.009 – 0.490	2400/F(KHz)	300
0.490 – 1.705	24000/F(KHz)	30
1.705 – 30.0	30	30
30 - 88	100 **	3
88 - 216	150 **	3
216 - 960	200 **	3
Above 960	500	3

Remark: **Except as provided in paragraph (g), fundamental emissions from intentional radiators operating under this Section shall not be located in the frequency bands 54-72 MHz, 76-88 MHz, 174-216 MHz or 470-806 MHz. However, operation within these frequency bands is permitted under other sections of this Part, e.g., Sections 15.231 and 15.241.

(4) According to § 15.209 (b) In the emission table above, the tighter limit applies at the band edges.

TEST EQUIPMENT

Radiated Emission / 966Chamber_A

Name of Equipment	Manufacturer	Model	Serial Number	Calibration Due
Spectrum Analyzer	Agilent	E4446A	MY43360132	06/10/2015
EMI Test Receiver	ROHDE & SCHWARZ	ESCI	100221	04/28/2015
Bi-log Antenna	SCHWARZBECK	VULB 9168	9168-249	08/21/2015
Broad-Band Horn Antenna	SCHWARZBECK	BBHA 9120 D	9120D-778	08/19/2015
Pre-Amplifier	Agilent	8449B	3008A01471	07/15/2015
Pre-Amplifier	HP	8447F	2944A03748	07/15/2015
Band Reject Notch Filter	Micro-Tronics	BRM05702-01	009	N.C.R

Remark: 1. Each piece of equipment is scheduled for calibration once a year.
2. N.C.R = No Calibration Request.



Radiated Emission / 966Chamber_B

Name of Equipment	Manufacture	Model	Serial Number	Calibration Due
Spectrum Analyzer	Agilent	E4446A	MY46180323	04/15/2015
EMI Test Receiver	ROHDE & SCHWARZ	ESCS 30	835418/008	10/14/2015
Bi-log Antenna	SCHWARZBECK	VULB 9168	9168-250	08/21/2015
Double-Ridged Waveguide Horn	ETS-LINDGREN	3117	00078733	12/02/2015
Horn Antenna	COM-POWER	AH-840	03077	12/17/2015
Pre-Amplifier	Agilent	8447D	2944A10052	07/15/2015
Pre-Amplifier	Agilent	8449B	3008A01916	07/15/2015
LOOP Antenna	EMCO	6502	8905-2356	09/23/2015
Notch Filters Band Reject	Micro-Tronics	BRM05702-01	026	N.C.R

Remark: 1. Each piece of equipment is scheduled for calibration once a year.
 2. N.C.R = No Calibration Request.

TEST SETUP

The diagram below shows the test setup that is utilized to make the measurements for emission from below 1GHz.

9kHz ~ 30MHz

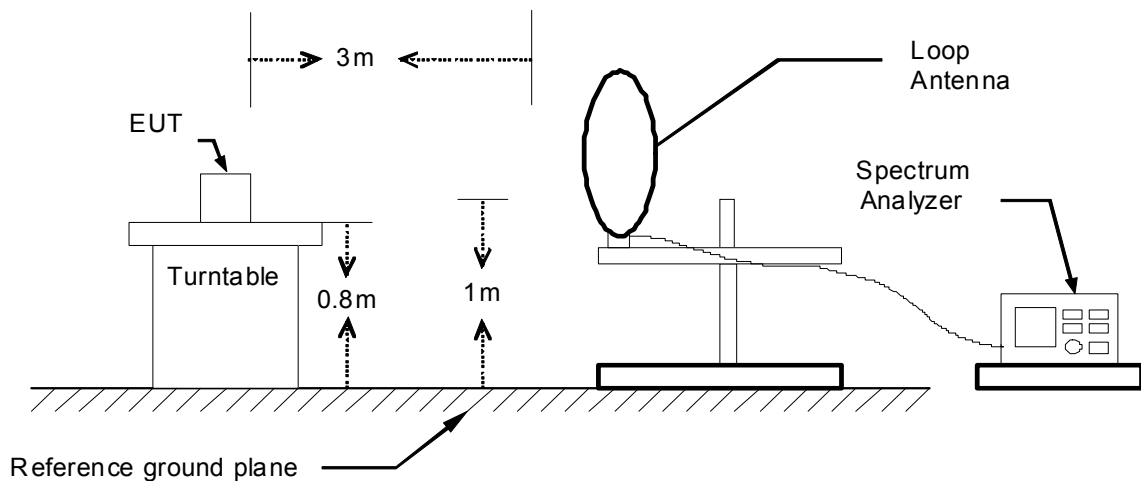



30MHz ~ 1GHz

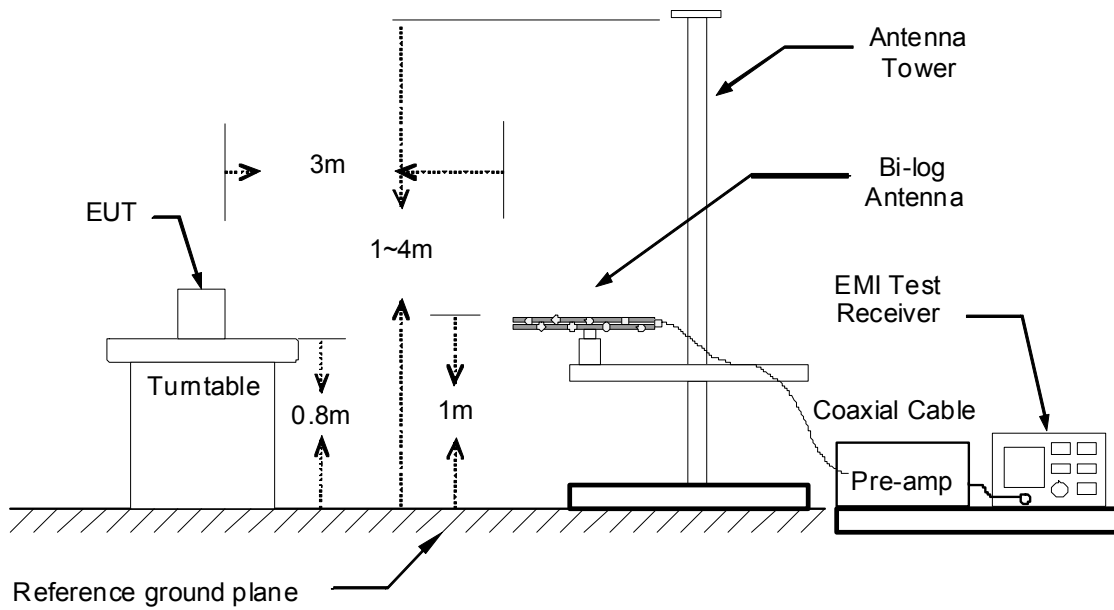

The diagram below shows the test setup that is utilized to make the measurements for emission above 1GHz.

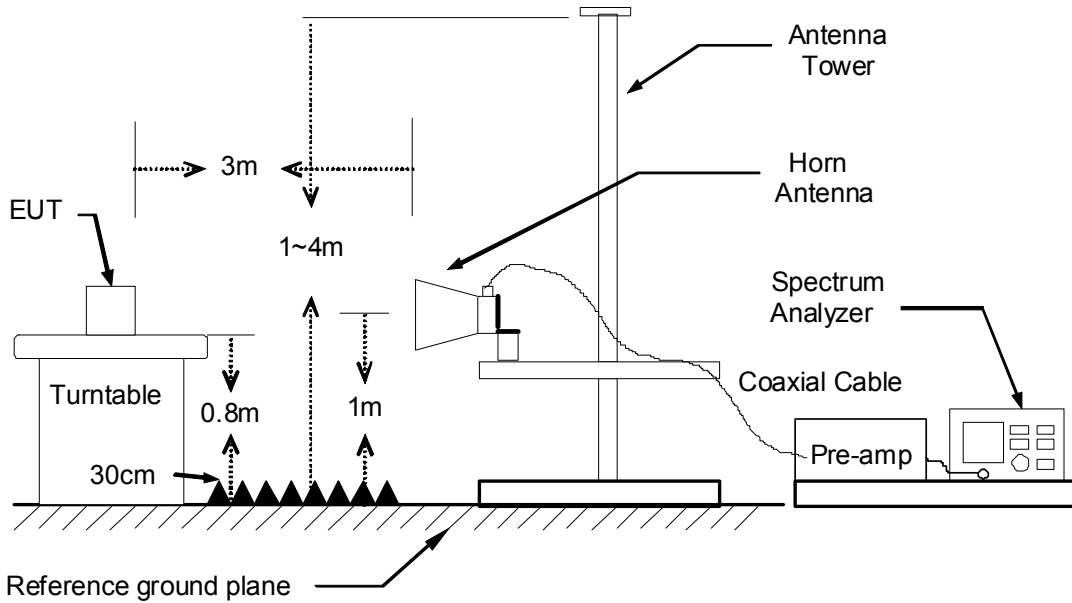



TEST PROCEDURE

1. The EUT was placed on the top of a rotating table 0.8 meters above the ground. The table was rotated 360 degrees to determine the position of the highest radiation.
2. While measuring the radiated emission below 1GHz, the EUT was set 3 meters away from the interference-receiving antenna, which was mounted on the top of a variable-height antenna tower. While measuring the radiated emission above 1GHz, the EUT was set 3 meters away from the interference-receiving antenna.
3. The antenna is a broadband antenna, and its height is varied from one meter to four meters above the ground to determine the maximum value of the field strength. Both horizontal and vertical polarization of the antenna are set to make the measurement.
4. For each suspected emission, the EUT was arranged to its worst case and then the antenna was tuned to heights from 1 meter to 4 meters and the table was turned from 0 degrees to 360 degrees to find the maximum reading.
5. The test-receiver system was set to Peak Detect Function and Specified Bandwidth with Maximum Hold Mode.
6. If the emission level of the EUT in peak mode was 10 dB lower than the limit specified, then testing could be stopped and the peak values of the EUT would be reported. Otherwise the emissions that did not have 10 dB margin would be re-tested one by one using peak, quasi-peak or average method as specified and then reported in a data sheet.

Remark :

1. *The resolution bandwidth and video bandwidth of test receiver/spectrum analyzer is 120 KHz for Peak detection (PK) and Quasi-peak detection (QP) at frequency below 1GHz.*
2. *The resolution bandwidth and video bandwidth of test receiver/spectrum analyzer is 1 MHz for Peak detection and frequency above 1GHz.*
3. *The resolution bandwidth of test receiver/spectrum analyzer is 1 MHz and the video bandwidth is 10 Hz for Average detection (AV) at frequency above 1GHz.*



TEST RESULTS

Below 1 GHz (9kHz ~ 30MHz)

No emission found between lowest internal used/generated frequency to 30MHz.

Below 1 GHz (30MHz ~ 1GHz)

Product Name	4G/LTE VoIP Wireless-N VPN Broadband Router	Test By	Rueyyan Lin
Test Model	BiPAC 6300VNOZ	Temp. & Humidity	20°C, 49%
Test Mode	TX Mode / Power Port		

966 Chamber_A at 3Meter / Horizontal						
Frequency (MHz)	Reading (dBµV)	Correction Factor (dB/m)	Result (dBµV/m)	Limit (dBµV/m)	Margin (dB)	Remark
55.22	38.87	-9.86	29.01	40.00	-10.99	Peak
94.02	44.26	-15.66	28.60	43.50	-14.90	Peak
167.74	40.71	-10.44	30.27	43.50	-13.23	Peak
249.22	50.98	-10.78	40.21	46.00	-5.79	Peak
375.32	51.42	-6.97	44.45	46.00	-1.55	QP
600.36	36.65	-1.83	34.82	46.00	-11.18	Peak
749.74	38.14	1.18	39.32	46.00	-6.68	Peak
875.84	36.30	2.84	39.15	46.00	-6.85	Peak

966 Chamber_A at 3Meter / Vertical						
Frequency (MHz)	Reading (dBµV)	Correction Factor (dB/m)	Result (dBµV/m)	Limit (dBµV/m)	Margin (dB)	Remark
39.70	45.17	-10.38	34.79	40.00	-5.21	Peak
115.36	42.51	-12.85	29.66	43.50	-13.84	Peak
165.80	42.71	-10.30	32.41	43.50	-11.09	Peak
249.22	49.70	-10.78	38.92	46.00	-7.08	Peak
375.32	46.68	-6.97	39.71	46.00	-6.29	Peak
582.90	38.57	-2.23	36.35	46.00	-9.65	Peak
625.58	41.57	-1.49	40.08	46.00	-5.92	Peak
749.74	36.78	1.18	37.96	46.00	-8.04	Peak
875.84	39.98	2.84	42.83	46.00	-3.17	Peak

Remark:

1. Quasi-peak test would be performed if the peak result were greater than the quasi-peak limit.
2. Data of measurement within this frequency range shown " --- " in the table above means the reading of emissions are attenuated more than 20dB below the permissible limits or the field strength is too small to be measured.
3. Correction Factor (dB/m) = Antenna Factor (dB/m) + Cable Loss (dB) – PreAmp.Gain (dB)
4. Result (dBuV/m) = Reading (dBuV) + Correction Factor (dB/m)
5. Margin (dB) = Remark result (dBuV/m) - Quasi-peak limit (dBuV/m)



Above 1 GHz

Product Name	4G/LTE VoIP Wireless-N VPN Broadband Router	Test By	Rueyyan Lin
Test Model	BiPAC 6300VNOZ	Temp. & Humidity	25°C, 54%
Test Mode	IEEE 802.11b TX / CH Low		

966 Chamber_B at 3Meter / Horizontal									
Frequency (MHz)	Reading-PK (dBuV)	Reading-AV (dBuV)	Correction Factor (dB/m)	Result-PK (dBuV/m)	Result-AV (dBuV/m)	Limit-PK (dBuV/m)	Limit-AV (dBuV/m)	Margin (dB)	Remark
1060.00	55.21	---	-3.79	51.42	---	74.00	54.00	-2.58	Peak
1252.00	55.81	---	-3.12	52.69	---	74.00	54.00	-1.31	Peak
1476.00	55.56	---	-2.33	53.23	---	74.00	54.00	-0.77	Peak
3247.50	43.48	---	5.50	48.98	---	74.00	54.00	-5.02	Peak
3855.00	41.63	---	6.84	48.47	---	74.00	54.00	-5.53	Peak
4822.50	47.75	44.19	9.22	56.97	53.41	74.00	54.00	-0.59	AVG
5557.50	40.52	---	10.51	51.03	---	74.00	54.00	-2.97	Peak

966 Chamber_B at 3Meter / Vertical									
Frequency (MHz)	Reading-PK (dBuV)	Reading-AV (dBuV)	Correction Factor (dB/m)	Result-PK (dBuV/m)	Result-AV (dBuV/m)	Limit-PK (dBuV/m)	Limit-AV (dBuV/m)	Margin (dB)	Remark
1066.00	55.32	---	-3.77	51.55	---	74.00	54.00	-2.45	Peak
1266.00	54.93	---	-3.07	51.86	---	74.00	54.00	-2.14	Peak
1500.00	54.75	---	-2.25	52.50	---	74.00	54.00	-1.50	Peak
3217.50	43.12	---	5.44	48.56	---	74.00	54.00	-5.44	Peak
4822.50	47.86	44.65	9.22	57.08	53.87	74.00	54.00	-0.13	AVG
7965.00	37.57	---	14.46	52.03	---	74.00	54.00	-1.97	Peak

Remark:

1. Measuring frequencies from 1 GHz to the 10th harmonic of highest fundamental frequency.
2. Average test would be performed if the peak result were greater than the average limit.
3. Data of measurement within this frequency range shown " --- " in the table above means the reading of emissions are attenuated more than 20dB below the permissible limits or the field strength is too small to be measured.
4. Measurements above show only up to 6 maximum emissions noted, or would be lesser, with " N/A " remark, if no specific emissions from the EUT are recorded (ie: margin>20dB from the applicable limit) and considered that's already beyond the background noise floor.
5. Result = Reading + Correction Factor
 Margin = Result - Limit
 Remark Peak = Result(PK) - Limit(AV)
 Remark AVG = Result(AV) - Limit(AV)



Product Name	4G/LTE VoIP Wireless-N VPN Broadband Router	Test By	Rueyyan Lin
Test Model	BiPAC 6300VNOZ	Temp. & Humidity	25°C, 54%
Test Mode	IEEE 802.11b TX / CH Middle		

966 Chamber_B at 3Meter / Horizontal									
Frequency (MHz)	Reading-PK (dBuV)	Reading-AV (dBuV)	Correction Factor (dB/m)	Result-PK (dBuV/m)	Result-AV (dBuV/m)	Limit-PK (dBuV/m)	Limit-AV (dBuV/m)	Margin (dB)	Remark
1084.00	54.94	---	-3.71	51.23	---	74.00	54.00	-2.77	Peak
1350.00	53.92	---	-2.78	51.14	---	74.00	54.00	-2.86	Peak
1492.00	54.23	---	-2.28	51.95	---	74.00	54.00	-2.05	Peak
2342.00	56.63	44.98	3.41	60.04	48.39	74.00	54.00	-5.61	AVG
3247.50	42.47	---	5.50	47.97	---	74.00	54.00	-6.03	Peak
4875.00	46.44	41.70	9.36	55.80	51.06	74.00	54.00	-2.94	AVG
5595.00	39.19	---	10.60	49.79	---	74.00	54.00	-4.21	Peak

966 Chamber_B at 3Meter / Vertical									
Frequency (MHz)	Reading-PK (dBuV)	Reading-AV (dBuV)	Correction Factor (dB/m)	Result-PK (dBuV/m)	Result-AV (dBuV/m)	Limit-PK (dBuV/m)	Limit-AV (dBuV/m)	Margin (dB)	Remark
1048.00	55.02	---	-3.83	51.19	---	74.00	54.00	-2.81	Peak
1180.00	54.53	---	-3.37	51.16	---	74.00	54.00	-2.84	Peak
1420.00	54.84	---	-2.53	52.31	---	74.00	54.00	-1.69	Peak
3247.50	42.04	---	5.50	47.54	---	74.00	54.00	-6.46	Peak
4875.00	47.69	44.39	9.36	57.05	53.75	74.00	54.00	-0.25	AVG
6247.50	38.71	---	12.09	50.80	---	74.00	54.00	-3.20	Peak

Remark:

1. Measuring frequencies from 1 GHz to the 10th harmonic of highest fundamental frequency.
2. Average test would be performed if the peak result were greater than the average limit.
3. Data of measurement within this frequency range shown " --- " in the table above means the reading of emissions are attenuated more than 20dB below the permissible limits or the field strength is too small to be measured.
4. Measurements above show only up to 6 maximum emissions noted, or would be lesser, with " N/A " remark, if no specific emissions from the EUT are recorded (ie: margin>20dB from the applicable limit) and considered that's already beyond the background noise floor.
5. Result = Reading + Correction Factor
Margin = Result - Limit
Remark Peak = Result(PK) - Limit(AV)
Remark AVG = Result(AV) - Limit(AV)



Product Name	4G/LTE VoIP Wireless-N VPN Broadband Router	Test By	Rueyyan Lin
Test Model	BiPAC 6300VNOZ	Temp. & Humidity	25°C, 54%
Test Mode	IEEE 802.11b TX / CH High		

966 Chamber_B at 3Meter / Horizontal									
Frequency (MHz)	Reading-PK (dBuV)	Reading-AV (dBuV)	Correction Factor (dB/m)	Result-PK (dBuV/m)	Result-AV (dBuV/m)	Limit-PK (dBuV/m)	Limit-AV (dBuV/m)	Margin (dB)	Remark
1066.00	55.16	---	-3.77	51.39	---	74.00	54.00	-2.61	Peak
1328.00	53.96	---	-2.85	51.11	---	74.00	54.00	-2.89	Peak
1548.00	54.59	---	-1.82	52.77	---	74.00	54.00	-1.23	Peak
2328.00	57.02	45.66	3.37	60.39	49.03	74.00	54.00	-4.97	AVG
3285.00	42.27	---	5.58	47.85	---	74.00	54.00	-6.15	Peak
4927.50	46.49	41.98	9.50	55.99	51.48	74.00	54.00	-2.52	AVG
6442.50	38.42	---	12.49	50.91	---	74.00	54.00	-3.09	Peak

966 Chamber_B at 3Meter / Vertical									
Frequency (MHz)	Reading-PK (dBuV)	Reading-AV (dBuV)	Correction Factor (dB/m)	Result-PK (dBuV/m)	Result-AV (dBuV/m)	Limit-PK (dBuV/m)	Limit-AV (dBuV/m)	Margin (dB)	Remark
1038.00	55.99	---	-3.87	52.12	---	74.00	54.00	-1.88	Peak
1196.00	54.88	---	-3.31	51.57	---	74.00	54.00	-2.43	Peak
1358.00	54.11	---	-2.75	51.36	---	74.00	54.00	-2.64	Peak
2382.00	56.41	44.69	3.55	59.96	48.24	74.00	54.00	-5.76	AVG
3285.00	41.70	---	5.58	47.28	---	74.00	54.00	-6.72	Peak
4927.50	47.42	43.79	9.50	56.92	53.29	74.00	54.00	-0.71	AVG
6442.50	39.68	---	12.49	52.17	---	74.00	54.00	-1.83	Peak

Remark:

1. Measuring frequencies from 1 GHz to the 10th harmonic of highest fundamental frequency.
2. Average test would be performed if the peak result were greater than the average limit.
3. Data of measurement within this frequency range shown " --- " in the table above means the reading of emissions are attenuated more than 20dB below the permissible limits or the field strength is too small to be measured.
4. Measurements above show only up to 6 maximum emissions noted, or would be lesser, with " N/A " remark, if no specific emissions from the EUT are recorded (ie: margin>20dB from the applicable limit) and considered that's already beyond the background noise floor.
5. Result = Reading + Correction Factor
Margin = Result - Limit
Remark Peak = Result(PK) - Limit(AV)
Remark AVG = Result(AV) - Limit(AV)



Product Name	4G/LTE VoIP Wireless-N VPN Broadband Router	Test By	Rueyyan Lin
Test Model	BiPAC 6300VNOZ	Temp. & Humidity	25°C, 54%
Test Mode	IEEE 802.11g TX / CH Low		

966 Chamber_B at 3Meter / Horizontal									
Frequency (MHz)	Reading-PK (dBuV)	Reading-AV (dBuV)	Correction Factor (dB/m)	Result-PK (dBuV/m)	Result-AV (dBuV/m)	Limit-PK (dBuV/m)	Limit-AV (dBuV/m)	Margin (dB)	Remark
1080.00	54.85	---	-3.72	51.13	---	74.00	54.00	-2.87	Peak
1364.00	55.09	---	-2.73	52.37	---	74.00	54.00	-1.63	Peak
1562.00	53.15	---	-1.69	51.45	---	74.00	54.00	-2.55	Peak
2360.00	60.84	50.16	3.47	64.31	53.63	74.00	54.00	-0.37	AVG
3217.50	42.75	---	5.44	48.19	---	74.00	54.00	-5.81	Peak
4822.50	39.87	---	9.22	49.09	---	74.00	54.00	-4.91	Peak
5617.50	39.36	---	10.65	50.02	---	74.00	54.00	-3.98	Peak

966 Chamber_B at 3Meter / Vertical									
Frequency (MHz)	Reading-PK (dBuV)	Reading-AV (dBuV)	Correction Factor (dB/m)	Result-PK (dBuV/m)	Result-AV (dBuV/m)	Limit-PK (dBuV/m)	Limit-AV (dBuV/m)	Margin (dB)	Remark
1032.00	55.91	---	-3.89	52.02	---	74.00	54.00	-1.98	Peak
1244.00	54.27	---	-3.15	51.12	---	74.00	54.00	-2.88	Peak
1522.00	53.03	---	-2.05	50.97	---	74.00	54.00	-3.03	Peak
2358.00	60.59	50.04	3.47	64.06	53.51	74.00	54.00	-0.49	AVG
3217.50	44.03	---	5.44	49.47	---	74.00	54.00	-4.53	Peak
4830.00	40.58	---	9.24	49.82	---	74.00	54.00	-4.18	Peak
6195.00	38.63	---	11.98	50.61	---	74.00	54.00	-3.39	Peak

Remark:

1. Measuring frequencies from 1 GHz to the 10th harmonic of highest fundamental frequency.
2. Average test would be performed if the peak result were greater than the average limit.
3. Data of measurement within this frequency range shown " --- " in the table above means the reading of emissions are attenuated more than 20dB below the permissible limits or the field strength is too small to be measured.
4. Measurements above show only up to 6 maximum emissions noted, or would be lesser, with " N/A " remark, if no specific emissions from the EUT are recorded (ie: margin>20dB from the applicable limit) and considered that's already beyond the background noise floor.
5. Result = Reading + Correction Factor
Margin = Result - Limit
Remark Peak = Result(PK) - Limit(AV)
Remark AVG = Result(AV) - Limit(AV)



Product Name	4G/LTE VoIP Wireless-N VPN Broadband Router	Test By	Rueyya Lin
Test Model	BiPAC 6300VNOZ	Temp. & Humidity	25°C, 54%
Test Mode	IEEE 802.11g TX / CH Middle		

966 Chamber_B at 3Meter / Horizontal									
Frequency (MHz)	Reading-PK (dBuV)	Reading-AV (dBuV)	Correction Factor (dB/m)	Result-PK (dBuV/m)	Result-AV (dBuV/m)	Limit-PK (dBuV/m)	Limit-AV (dBuV/m)	Margin (dB)	Remark
1162.00	54.62	---	-3.43	51.18	---	74.00	54.00	-2.82	Peak
1452.00	53.34	---	-2.42	50.92	---	74.00	54.00	-3.08	Peak
2384.00	59.72	49.67	3.56	63.28	53.23	74.00	54.00	-0.77	AVG
2490.00	60.92	49.95	3.92	64.84	53.87	74.00	54.00	-0.13	AVG
3247.50	43.80	---	5.50	49.30	---	74.00	54.00	-4.70	Peak
4882.50	45.19	34.98	9.38	54.57	44.36	74.00	54.00	-9.64	AVG
6480.00	38.80	---	12.57	51.37	---	74.00	54.00	-2.63	Peak

966 Chamber_B at 3Meter / Vertical									
Frequency (MHz)	Reading-PK (dBuV)	Reading-AV (dBuV)	Correction Factor (dB/m)	Result-PK (dBuV/m)	Result-AV (dBuV/m)	Limit-PK (dBuV/m)	Limit-AV (dBuV/m)	Margin (dB)	Remark
1110.00	55.57	---	-3.62	51.95	---	74.00	54.00	-2.05	Peak
1392.00	54.61	---	-2.63	51.98	---	74.00	54.00	-2.02	Peak
2384.00	60.49	49.56	3.56	64.05	53.12	74.00	54.00	-0.88	AVG
2490.00	58.66	47.66	3.92	62.58	51.58	74.00	54.00	-2.42	AVG
3247.50	44.33	---	5.50	49.83	---	74.00	54.00	-4.17	Peak
4867.50	46.40	35.24	9.34	55.74	44.58	74.00	54.00	-9.42	AVG
6150.00	39.01	---	11.89	50.90	---	74.00	54.00	-3.10	Peak

Remark:

1. Measuring frequencies from 1 GHz to the 10th harmonic of highest fundamental frequency.
2. Average test would be performed if the peak result were greater than the average limit.
3. Data of measurement within this frequency range shown " --- " in the table above means the reading of emissions are attenuated more than 20dB below the permissible limits or the field strength is too small to be measured.
4. Measurements above show only up to 6 maximum emissions noted, or would be lesser, with " N/A " remark, if no specific emissions from the EUT are recorded (ie: margin>20dB from the applicable limit) and considered that's already beyond the background noise floor.
5. Result = Reading + Correction Factor
Margin = Result - Limit
Remark Peak = Result(PK) - Limit(AV)
Remark AVG = Result(AV) - Limit(AV)



Product Name	4G/LTE VoIP Wireless-N VPN Broadband Router	Test By	Rueyyan Lin
Test Model	BiPAC 6300VNOZ	Temp. & Humidity	25°C, 54%
Test Mode	IEEE 802.11g TX / CH High		

966 Chamber_B at 3Meter / Horizontal									
Frequency (MHz)	Reading-PK (dBuV)	Reading-AV (dBuV)	Correction Factor (dB/m)	Result-PK (dBuV/m)	Result-AV (dBuV/m)	Limit-PK (dBuV/m)	Limit-AV (dBuV/m)	Margin (dB)	Remark
1062.00	54.71	---	-3.78	50.92	---	74.00	54.00	-3.08	Peak
1462.00	54.06	---	-2.38	51.68	---	74.00	54.00	-2.32	Peak
2394.00	58.60	47.71	3.59	62.19	51.30	74.00	54.00	-2.70	AVG
2516.00	61.10	49.98	3.98	65.08	53.96	74.00	54.00	-0.04	AVG
3285.00	43.55	---	5.58	49.13	---	74.00	54.00	-4.87	Peak
4927.50	40.77	---	9.50	50.27	---	74.00	54.00	-3.73	Peak
6052.50	39.16	---	11.69	50.85	---	74.00	54.00	-3.15	Peak

966 Chamber_B at 3Meter / Vertical									
Frequency (MHz)	Reading-PK (dBuV)	Reading-AV (dBuV)	Correction Factor (dB/m)	Result-PK (dBuV/m)	Result-AV (dBuV/m)	Limit-PK (dBuV/m)	Limit-AV (dBuV/m)	Margin (dB)	Remark
1098.00	54.78	---	-3.66	51.13	---	74.00	54.00	-2.87	Peak
1344.00	53.96	---	-2.80	51.17	---	74.00	54.00	-2.83	Peak
2398.00	58.60	46.97	3.60	62.20	50.57	74.00	54.00	-3.43	AVG
2524.00	56.99	45.50	4.00	60.99	49.50	74.00	54.00	-4.50	AVG
3285.00	44.43	---	5.58	50.01	---	74.00	54.00	-3.99	Peak
4927.50	40.37	---	9.50	49.87	---	74.00	54.00	-4.13	Peak
6225.00	39.03	---	12.04	51.07	---	74.00	54.00	-2.93	Peak

Remark:

1. Measuring frequencies from 1 GHz to the 10th harmonic of highest fundamental frequency.
2. Average test would be performed if the peak result were greater than the average limit.
3. Data of measurement within this frequency range shown " --- " in the table above means the reading of emissions are attenuated more than 20dB below the permissible limits or the field strength is too small to be measured.
4. Measurements above show only up to 6 maximum emissions noted, or would be lesser, with " N/A " remark, if no specific emissions from the EUT are recorded (ie: margin>20dB from the applicable limit) and considered that's already beyond the background noise floor.
5. Result = Reading + Correction Factor
Margin = Result - Limit
Remark Peak = Result(PK) - Limit(AV)
Remark AVG = Result(AV) - Limit(AV)



Product Name	4G/LTE VoIP Wireless-N VPN Broadband Router	Test By	Rueyyan Lin
Test Model	BiPAC 6300VNOZ	Temp. & Humidity	25.3°C, 46%
Test Mode	IEEE 802.11n HT20 TX / CH Low		

966 Chamber_B at 3Meter / Horizontal									
Frequency (MHz)	Reading-PK (dBuV)	Reading-AV (dBuV)	Correction Factor (dB/m)	Result-PK (dBuV/m)	Result-AV (dBuV/m)	Limit-PK (dBuV/m)	Limit-AV (dBuV/m)	Margin (dB)	Remark
1158.00	54.77	---	-3.45	51.32	---	74.00	54.00	-2.68	Peak
1350.00	53.69	---	-2.78	50.92	---	74.00	54.00	-3.08	Peak
1570.00	53.59	---	-1.62	51.97	---	74.00	54.00	-2.03	Peak
2360.00	61.62	50.07	3.47	65.09	53.54	74.00	54.00	-0.46	AVG
3217.50	42.74	---	5.44	48.19	---	74.00	54.00	-5.81	Peak
4815.00	39.20	---	9.20	48.40	---	74.00	54.00	-5.60	Peak
5692.50	39.29	---	10.84	50.13	---	74.00	54.00	-3.87	Peak

966 Chamber_B at 3Meter / Vertical									
Frequency (MHz)	Reading-PK (dBuV)	Reading-AV (dBuV)	Correction Factor (dB/m)	Result-PK (dBuV/m)	Result-AV (dBuV/m)	Limit-PK (dBuV/m)	Limit-AV (dBuV/m)	Margin (dB)	Remark
1088.00	55.28	---	-3.69	51.58	---	74.00	54.00	-2.42	Peak
1382.00	53.38	---	-2.66	50.72	---	74.00	54.00	-3.28	Peak
1586.00	53.12	---	-1.48	51.64	---	74.00	54.00	-2.36	Peak
2360.00	59.61	48.56	3.47	63.08	52.03	74.00	54.00	-1.97	AVG
3217.50	42.49	---	5.44	47.93	---	74.00	54.00	-6.07	Peak
4815.00	39.98	---	9.20	49.19	---	74.00	54.00	-4.81	Peak
6292.50	38.96	---	12.18	51.14	---	74.00	54.00	-2.86	Peak

Remark:

1. Measuring frequencies from 1 GHz to the 10th harmonic of highest fundamental frequency.
2. Average test would be performed if the peak result were greater than the average limit.
3. Data of measurement within this frequency range shown " --- " in the table above means the reading of emissions are attenuated more than 20dB below the permissible limits or the field strength is too small to be measured.
4. Measurements above show only up to 6 maximum emissions noted, or would be lesser, with " N/A " remark, if no specific emissions from the EUT are recorded (ie: margin>20dB from the applicable limit) and considered that's already beyond the background noise floor.
5. Result = Reading + Correction Factor
Margin = Result - Limit
Remark Peak = Result(PK) - Limit(AV)
Remark AVG = Result(AV) - Limit(AV)



Product Name	4G/LTE VoIP Wireless-N VPN Broadband Router	Test By	Rueyyan Lin
Test Model	BiPAC 6300VNOZ	Temp. & Humidity	25.3°C, 46%
Test Mode	IEEE 802.11n HT20 TX / CH Middle		

966 Chamber_B at 3Meter / Horizontal									
Frequency (MHz)	Reading-PK (dBuV)	Reading-AV (dBuV)	Correction Factor (dB/m)	Result-PK (dBuV/m)	Result-AV (dBuV/m)	Limit-PK (dBuV/m)	Limit-AV (dBuV/m)	Margin (dB)	Remark
1098.00	54.52	---	-3.66	50.86	---	74.00	54.00	-3.14	Peak
1390.00	54.38	---	-2.63	51.74	---	74.00	54.00	-2.26	Peak
2384.00	61.23	50.10	3.56	64.79	53.66	74.00	54.00	-0.34	AVG
2488.00	59.85	48.85	3.91	63.76	52.76	74.00	54.00	-1.24	AVG
3247.50	43.89	---	5.50	49.40	---	74.00	54.00	-4.60	Peak
4875.00	39.82	---	9.36	49.18	---	74.00	54.00	-4.82	Peak
5550.00	40.31	---	10.49	50.80	---	74.00	54.00	-3.20	Peak

966 Chamber_B at 3Meter / Vertical									
Frequency (MHz)	Reading-PK (dBuV)	Reading-AV (dBuV)	Correction Factor (dB/m)	Result-PK (dBuV/m)	Result-AV (dBuV/m)	Limit-PK (dBuV/m)	Limit-AV (dBuV/m)	Margin (dB)	Remark
1324.00	54.02	---	-2.87	51.15	---	74.00	54.00	-2.85	Peak
1530.00	54.14	---	-1.98	52.16	---	74.00	54.00	-1.84	Peak
2384.00	59.58	47.02	3.56	63.14	50.58	74.00	54.00	-3.42	AVG
2488.00	57.47	45.48	3.91	61.38	49.39	74.00	54.00	-4.61	AVG
3247.50	42.95	---	5.50	48.46	---	74.00	54.00	-5.54	Peak
4875.00	40.49	---	9.36	49.85	---	74.00	54.00	-4.15	Peak
5557.50	40.04	---	10.51	50.55	---	74.00	54.00	-3.45	Peak

Remark:

1. Measuring frequencies from 1 GHz to the 10th harmonic of highest fundamental frequency.
2. Average test would be performed if the peak result were greater than the average limit.
3. Data of measurement within this frequency range shown " --- " in the table above means the reading of emissions are attenuated more than 20dB below the permissible limits or the field strength is too small to be measured.
4. Measurements above show only up to 6 maximum emissions noted, or would be lesser, with " N/A " remark, if no specific emissions from the EUT are recorded (ie: margin>20dB from the applicable limit) and considered that's already beyond the background noise floor.
5. Result = Reading + Correction Factor
Margin = Result - Limit
Remark Peak = Result(PK) - Limit(AV)
Remark AVG = Result(AV) - Limit(AV)



Product Name	4G/LTE VoIP Wireless-N VPN Broadband Router	Test By	Rueyyan Lin
Test Model	BiPAC 6300VNOZ	Temp. & Humidity	25.3°C, 46%
Test Mode	IEEE 802.11n HT20 TX / CH High		

966 Chamber_B at 3Meter / Horizontal									
Frequency (MHz)	Reading-PK (dBuV)	Reading-AV (dBuV)	Correction Factor (dB/m)	Result-PK (dBuV/m)	Result-AV (dBuV/m)	Limit-PK (dBuV/m)	Limit-AV (dBuV/m)	Margin (dB)	Remark
1110.00	54.78	---	-3.62	51.17	---	74.00	54.00	-2.83	Peak
1454.00	54.17	---	-2.41	51.76	---	74.00	54.00	-2.24	Peak
2396.00	61.18	49.26	3.60	64.78	52.86	74.00	54.00	-1.14	AVG
2514.00	59.07	47.96	3.98	63.05	51.94	74.00	54.00	-2.06	AVG
3285.00	44.24	---	5.58	49.82	---	74.00	54.00	-4.18	Peak
4927.50	38.85	---	9.50	48.35	---	74.00	54.00	-5.65	Peak
5910.00	39.65	---	11.36	51.02	---	74.00	54.00	-2.98	Peak

966 Chamber_B at 3Meter / Vertical									
Frequency (MHz)	Reading-PK (dBuV)	Reading-AV (dBuV)	Correction Factor (dB/m)	Result-PK (dBuV/m)	Result-AV (dBuV/m)	Limit-PK (dBuV/m)	Limit-AV (dBuV/m)	Margin (dB)	Remark
1080.00	54.54	---	-3.72	50.82	---	74.00	54.00	-3.18	Peak
1452.00	53.57	---	-2.42	51.15	---	74.00	54.00	-2.85	Peak
2396.00	57.61	45.71	3.60	61.21	49.31	74.00	54.00	-4.69	AVG
3870.00	41.61	---	6.88	48.49	---	74.00	54.00	-5.51	Peak
4927.50	39.99	---	9.50	49.49	---	74.00	54.00	-4.51	Peak
6150.00	38.08	---	11.89	49.97	---	74.00	54.00	-4.03	Peak

Remark:

1. Measuring frequencies from 1 GHz to the 10th harmonic of highest fundamental frequency.
2. Average test would be performed if the peak result were greater than the average limit.
3. Data of measurement within this frequency range shown " --- " in the table above means the reading of emissions are attenuated more than 20dB below the permissible limits or the field strength is too small to be measured.
4. Measurements above show only up to 6 maximum emissions noted, or would be lesser, with " N/A " remark, if no specific emissions from the EUT are recorded (ie: margin>20dB from the applicable limit) and considered that's already beyond the background noise floor.
5. Result = Reading + Correction Factor
Margin = Result - Limit
Remark Peak = Result(PK) - Limit(AV)
Remark AVG = Result(AV) - Limit(AV)



Product Name	4G/LTE VoIP Wireless-N VPN Broadband Router	Test By	Rueyyan Lin
Test Model	BiPAC 6300VNOZ	Temp. & Humidity	25.3°C, 46%
Test Mode	IEEE 802.11n HT40 TX / CH Low		

966 Chamber_B at 3Meter / Horizontal									
Frequency (MHz)	Reading-PK (dBuV)	Reading-AV (dBuV)	Correction Factor (dB/m)	Result-PK (dBuV/m)	Result-AV (dBuV/m)	Limit-PK (dBuV/m)	Limit-AV (dBuV/m)	Margin (dB)	Remark
1064.00	54.55	---	-3.78	50.77	---	74.00	54.00	-3.23	Peak
1288.00	54.12	---	-2.99	51.13	---	74.00	54.00	-2.87	Peak
1492.00	53.97	---	-2.28	51.69	---	74.00	54.00	-2.31	Peak
2318.00	58.65	47.28	3.33	61.98	50.61	74.00	54.00	-3.39	AVG
3225.00	43.46	---	5.46	48.92	---	74.00	54.00	-5.08	Peak
4875.00	39.30	---	9.36	48.66	---	74.00	54.00	-5.34	Peak
6015.00	38.10	---	11.61	49.71	---	74.00	54.00	-4.29	Peak

966 Chamber_B at 3Meter / Vertical									
Frequency (MHz)	Reading-PK (dBuV)	Reading-AV (dBuV)	Correction Factor (dB/m)	Result-PK (dBuV/m)	Result-AV (dBuV/m)	Limit-PK (dBuV/m)	Limit-AV (dBuV/m)	Margin (dB)	Remark
1064.00	55.17	---	-3.78	51.39	---	74.00	54.00	-2.61	Peak
1304.00	54.17	---	-2.94	51.24	---	74.00	54.00	-2.76	Peak
1476.00	54.14	---	-2.33	51.80	---	74.00	54.00	-2.20	Peak
2320.00	56.65	44.15	3.34	59.99	47.49	74.00	54.00	-6.51	AVG
3225.00	42.70	---	5.46	48.16	---	74.00	54.00	-5.84	Peak
4815.00	39.64	---	9.20	48.84	---	74.00	54.00	-5.16	Peak
6390.00	38.97	---	12.38	51.35	---	74.00	54.00	-2.65	Peak

Remark:

1. Measuring frequencies from 1 GHz to the 10th harmonic of highest fundamental frequency.
2. Average test would be performed if the peak result were greater than the average limit.
3. Data of measurement within this frequency range shown " --- " in the table above means the reading of emissions are attenuated more than 20dB below the permissible limits or the field strength is too small to be measured.
4. Measurements above show only up to 6 maximum emissions noted, or would be lesser, with " N/A " remark, if no specific emissions from the EUT are recorded (ie: margin>20dB from the applicable limit) and considered that's already beyond the background noise floor.
5. Result = Reading + Correction Factor
Margin = Result - Limit
Remark Peak = Result(PK) - Limit(AV)
Remark AVG = Result(AV) - Limit(AV)



Product Name	4G/LTE VoIP Wireless-N VPN Broadband Router	Test By	Rueyyan Lin
Test Model	BiPAC 6300VNOZ	Temp. & Humidity	25.3°C, 46%
Test Mode	IEEE 802.11n HT40 TX / CH Middle		

966 Chamber_B at 3Meter / Horizontal									
Frequency (MHz)	Reading-PK (dBuV)	Reading-AV (dBuV)	Correction Factor (dB/m)	Result-PK (dBuV/m)	Result-AV (dBuV/m)	Limit-PK (dBuV/m)	Limit-AV (dBuV/m)	Margin (dB)	Remark
1098.00	54.38	---	-3.66	50.72	---	74.00	54.00	-3.28	Peak
1388.00	54.18	---	-2.64	51.53	---	74.00	54.00	-2.47	Peak
1680.00	52.97	---	-0.63	52.34	---	74.00	54.00	-1.66	Peak
2334.00	61.27	49.02	3.39	64.66	52.41	74.00	54.00	-1.59	AVG
3255.00	42.86	---	5.52	48.38	---	74.00	54.00	-5.62	Peak
4860.00	39.77	---	9.32	49.09	---	74.00	54.00	-4.91	Peak
6525.00	38.21	---	12.64	50.85	---	74.00	54.00	-3.15	Peak

966 Chamber_B at 3Meter / Vertical									
Frequency (MHz)	Reading-PK (dBuV)	Reading-AV (dBuV)	Correction Factor (dB/m)	Result-PK (dBuV/m)	Result-AV (dBuV/m)	Limit-PK (dBuV/m)	Limit-AV (dBuV/m)	Margin (dB)	Remark
1222.00	55.32	---	-3.22	52.09	---	74.00	54.00	-1.91	Peak
1488.00	53.39	---	-2.29	51.10	---	74.00	54.00	-2.90	Peak
2330.00	59.31	48.16	3.37	62.68	51.53	74.00	54.00	-2.47	AVG
2544.00	56.14	44.67	4.04	60.18	48.71	74.00	54.00	-5.29	AVG
3247.50	43.55	---	5.50	49.06	---	74.00	54.00	-4.94	Peak
4860.00	39.61	---	9.32	48.94	---	74.00	54.00	-5.06	Peak
5092.50	41.13	---	9.82	50.94	---	74.00	54.00	-3.06	Peak
6517.50	38.57	---	12.63	51.20	---	74.00	54.00	-2.80	Peak

Remark:

1. Measuring frequencies from 1 GHz to the 10th harmonic of highest fundamental frequency.
2. Average test would be performed if the peak result were greater than the average limit.
3. Data of measurement within this frequency range shown " --- " in the table above means the reading of emissions are attenuated more than 20dB below the permissible limits or the field strength is too small to be measured.
4. Measurements above show only up to 6 maximum emissions noted, or would be lesser, with " N/A " remark, if no specific emissions from the EUT are recorded (ie: margin>20dB from the applicable limit) and considered that's already beyond the background noise floor.
5. Result = Reading + Correction Factor
Margin = Result - Limit
Remark Peak = Result(PK) - Limit(AV)
Remark AVG = Result(AV) - Limit(AV)



Product Name	4G/LTE VoIP Wireless-N VPN Broadband Router	Test By	Rueyyan Lin
Test Model	BiPAC 6300VNOZ	Temp. & Humidity	25.3°C, 46%
Test Mode	IEEE 802.11n HT40 TX / CH High		

966 Chamber_B at 3Meter / Horizontal									
Frequency (MHz)	Reading-PK (dBuV)	Reading-AV (dBuV)	Correction Factor (dB/m)	Result-PK (dBuV/m)	Result-AV (dBuV/m)	Limit-PK (dBuV/m)	Limit-AV (dBuV/m)	Margin (dB)	Remark
1124.00	54.67	---	-3.57	51.11	---	74.00	54.00	-2.89	Peak
1390.00	54.24	---	-2.63	51.61	---	74.00	54.00	-2.39	Peak
2350.00	57.89	45.69	3.44	61.33	49.13	74.00	54.00	-4.87	AVG
2834.00	52.69	40.82	4.65	57.34	45.47	74.00	54.00	-8.53	AVG
3270.00	43.52	---	5.55	49.07	---	74.00	54.00	-4.93	Peak
4905.00	39.48	---	9.44	48.92	---	74.00	54.00	-5.08	Peak
5677.50	39.22	---	10.80	50.02	---	74.00	54.00	-3.98	Peak

966 Chamber_B at 3Meter / Vertical									
Frequency (MHz)	Reading-PK (dBuV)	Reading-AV (dBuV)	Correction Factor (dB/m)	Result-PK (dBuV/m)	Result-AV (dBuV/m)	Limit-PK (dBuV/m)	Limit-AV (dBuV/m)	Margin (dB)	Remark
1142.00	54.34	---	-3.50	50.84	---	74.00	54.00	-3.16	Peak
1326.00	54.16	---	-2.86	51.30	---	74.00	54.00	-2.70	Peak
1532.00	53.96	---	-1.96	51.99	---	74.00	54.00	-2.01	Peak
2350.00	57.61	46.00	3.44	61.05	49.44	74.00	54.00	-4.56	AVG
3292.50	42.75	---	5.60	48.35	---	74.00	54.00	-5.65	Peak
4635.00	41.15	---	8.73	49.87	---	74.00	54.00	-4.13	Peak
4938.61	0.00	---	0.00	49.41	---	74.00	54.00	-4.59	Peak
6037.50	38.52	---	11.66	50.18	---	74.00	54.00	-3.82	Peak

Remark:

1. Measuring frequencies from 1 GHz to the 10th harmonic of highest fundamental frequency.
2. Average test would be performed if the peak result were greater than the average limit.
3. Data of measurement within this frequency range shown " --- " in the table above means the reading of emissions are attenuated more than 20dB below the permissible limits or the field strength is too small to be measured.
4. Measurements above show only up to 6 maximum emissions noted, or would be lesser, with " N/A " remark, if no specific emissions from the EUT are recorded (ie: margin>20dB from the applicable limit) and considered that's already beyond the background noise floor.
5. Result = Reading + Correction Factor
Margin = Result - Limit
Remark Peak = Result(PK) - Limit(AV)
Remark AVG = Result(AV) - Limit(AV)



Restricted Band Edges

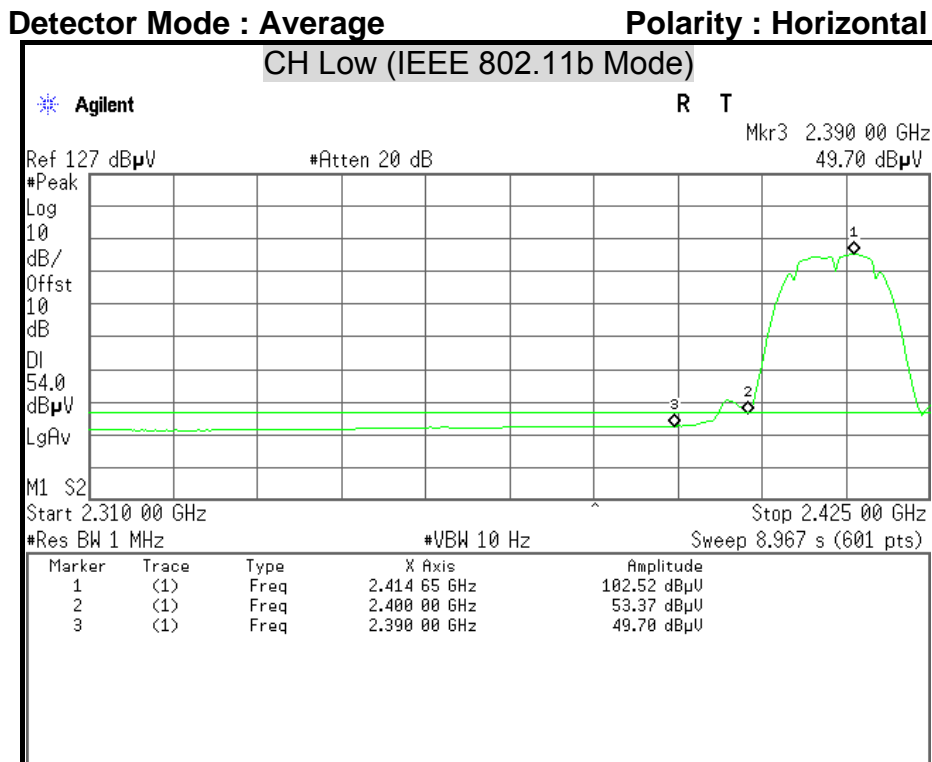
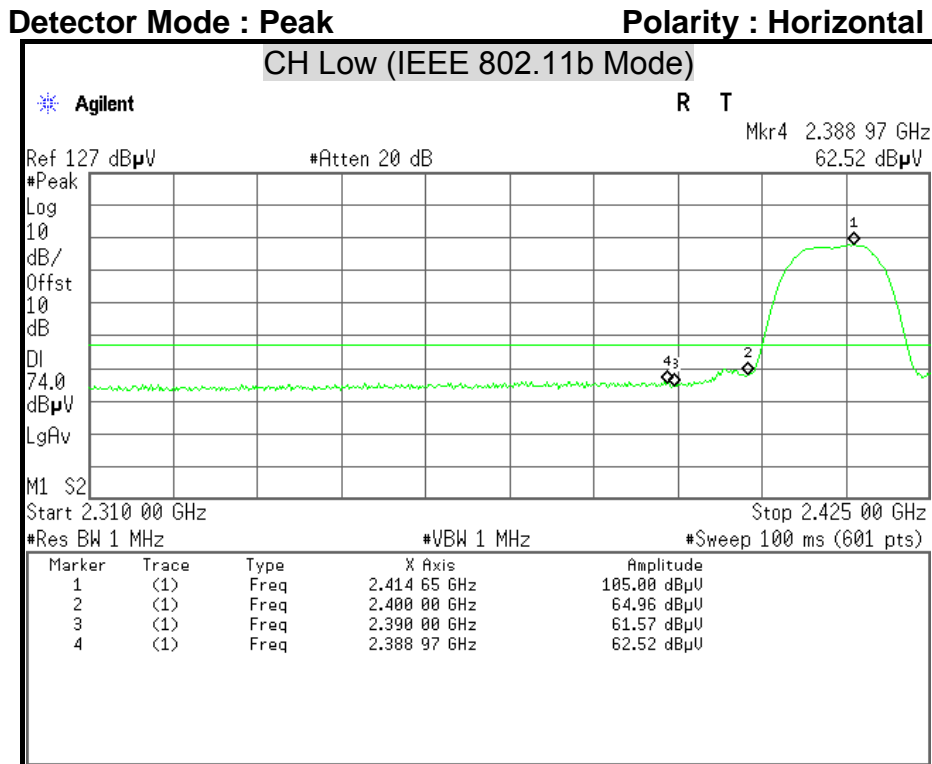



Detector Mode : Peak

Polarity : Vertical

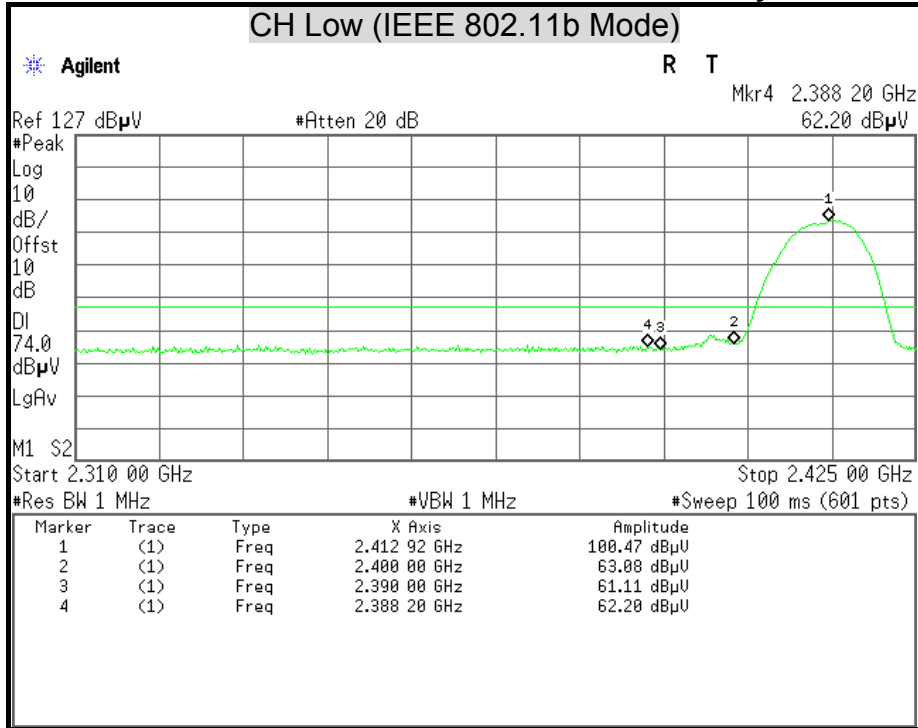

Detector Mode : Average

Polarity : Vertical

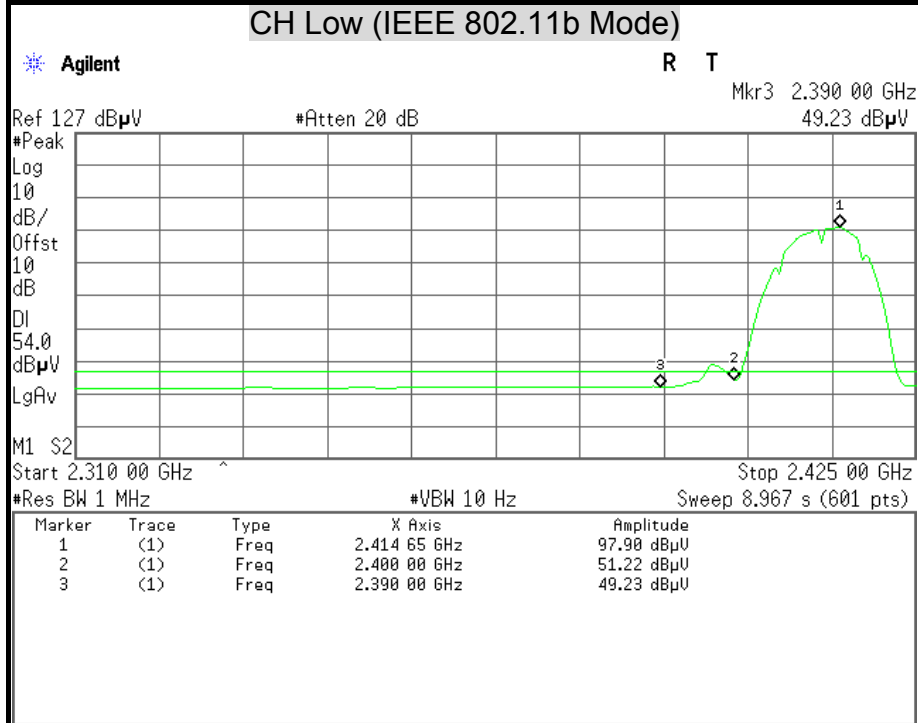



Detector Mode : Peak

Polarity : Horizontal

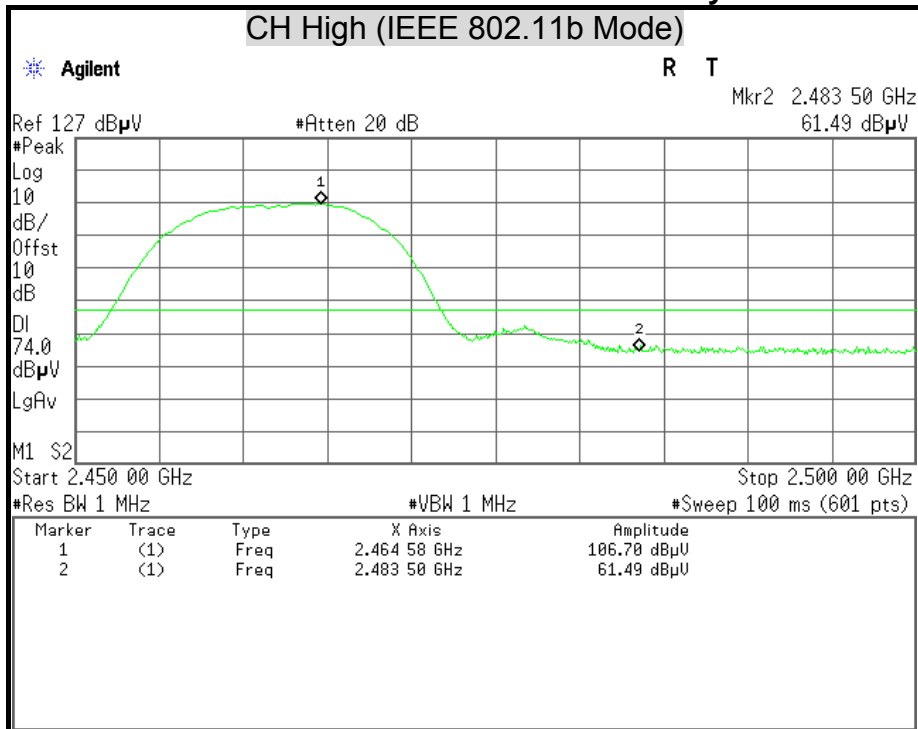

Detector Mode : Average

Polarity : Horizontal

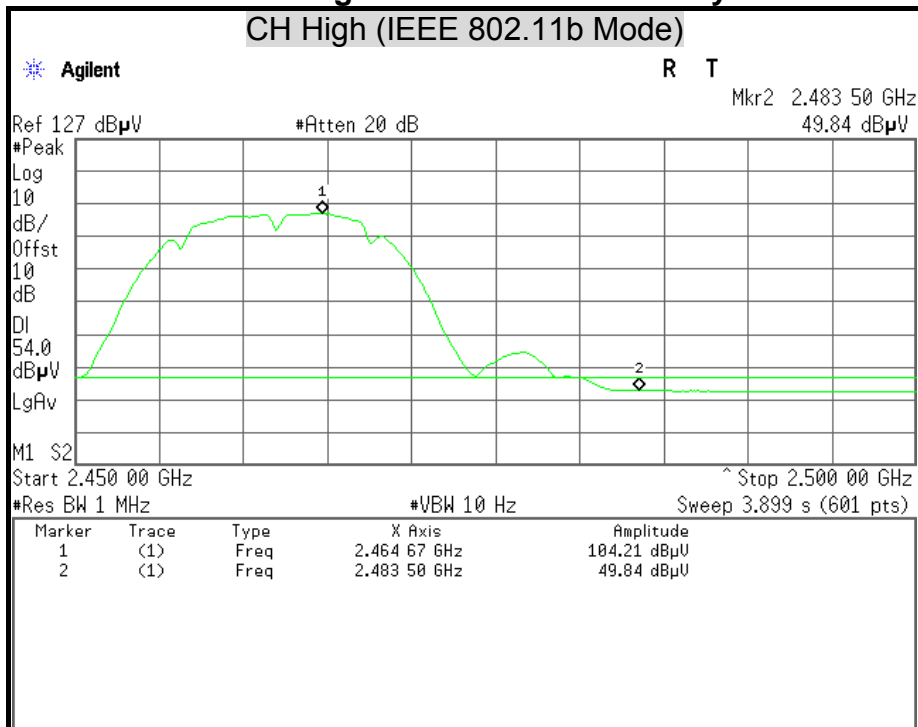



Detector Mode : Peak

Polarity : Vertical

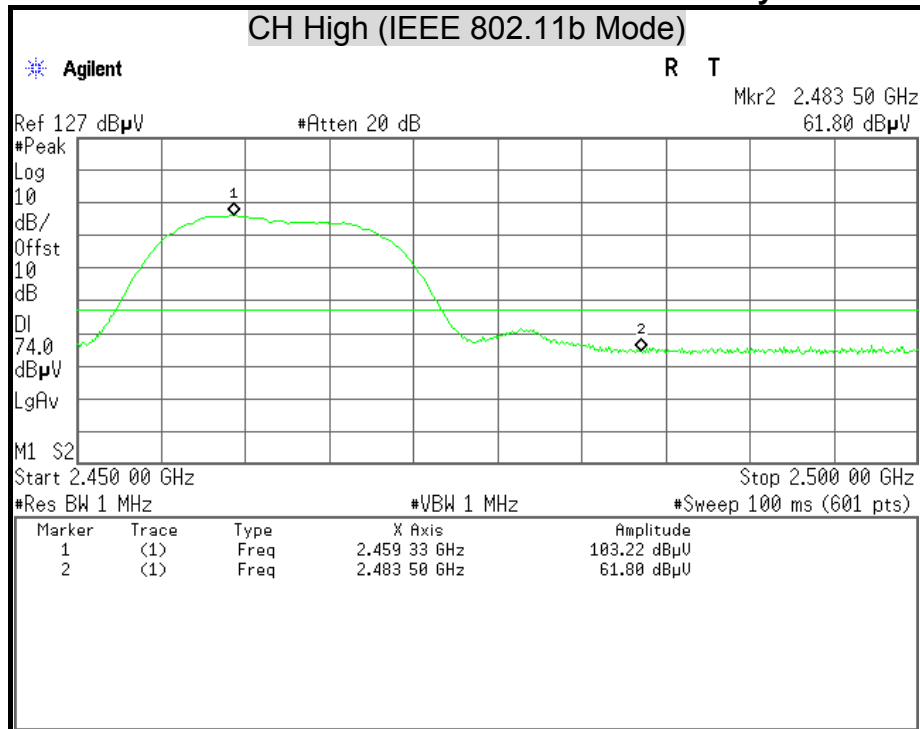

Detector Mode : Average

Polarity : Vertical

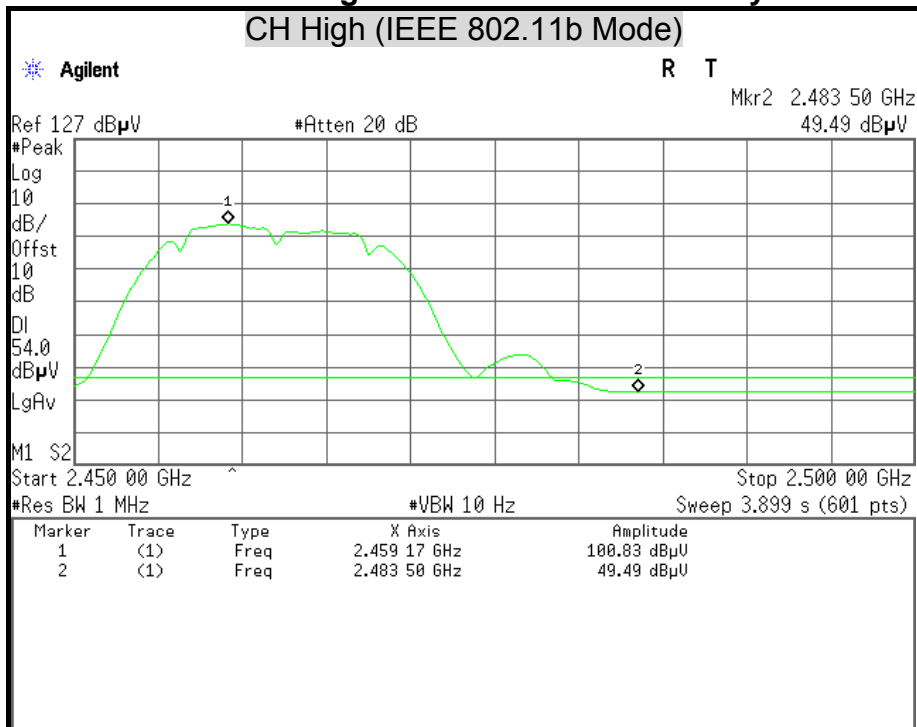



Detector Mode : Peak

Polarity : Horizontal

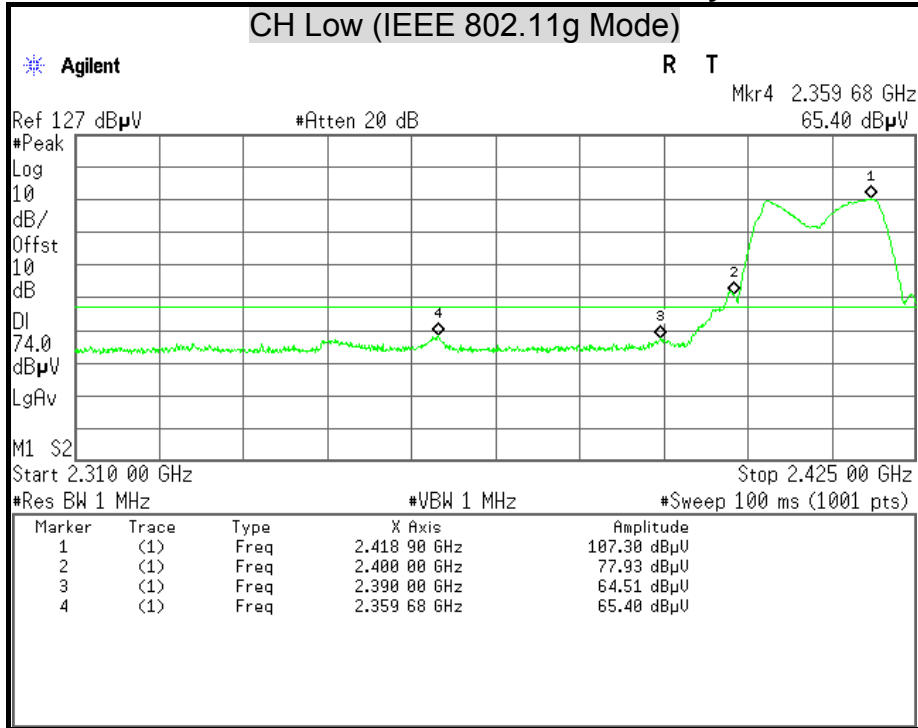

Detector Mode : Average

Polarity : Horizontal

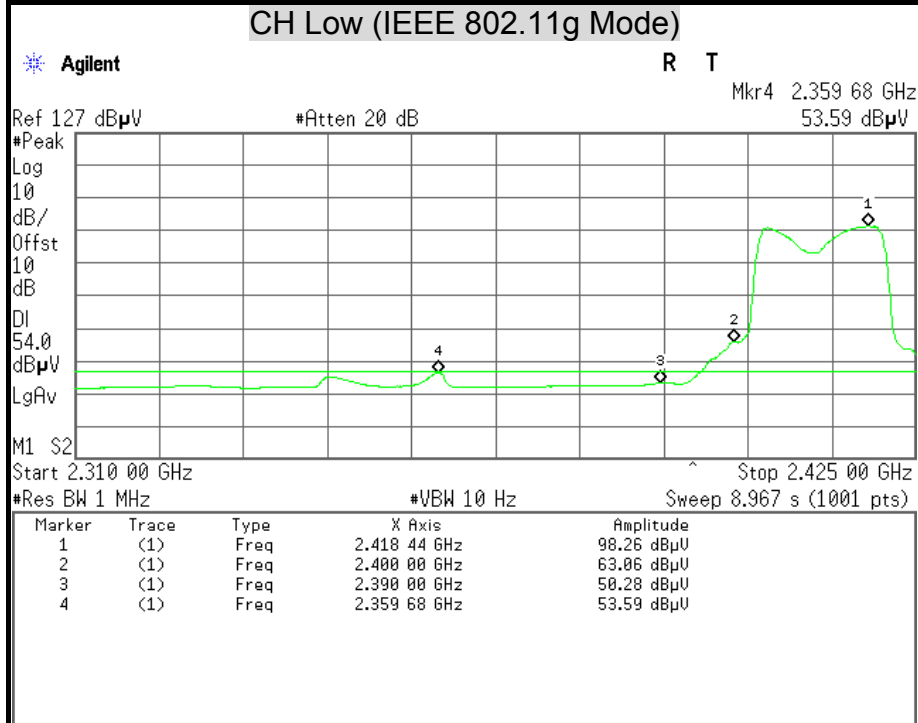



Detector Mode : Peak

Polarity : Vertical

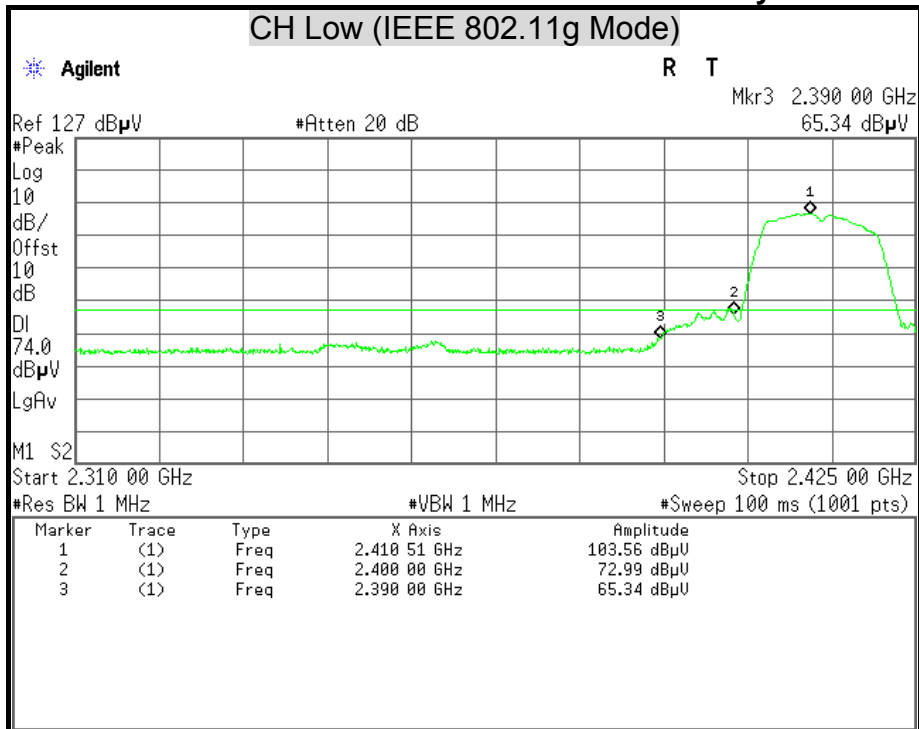

Detector Mode : Average

Polarity : Vertical

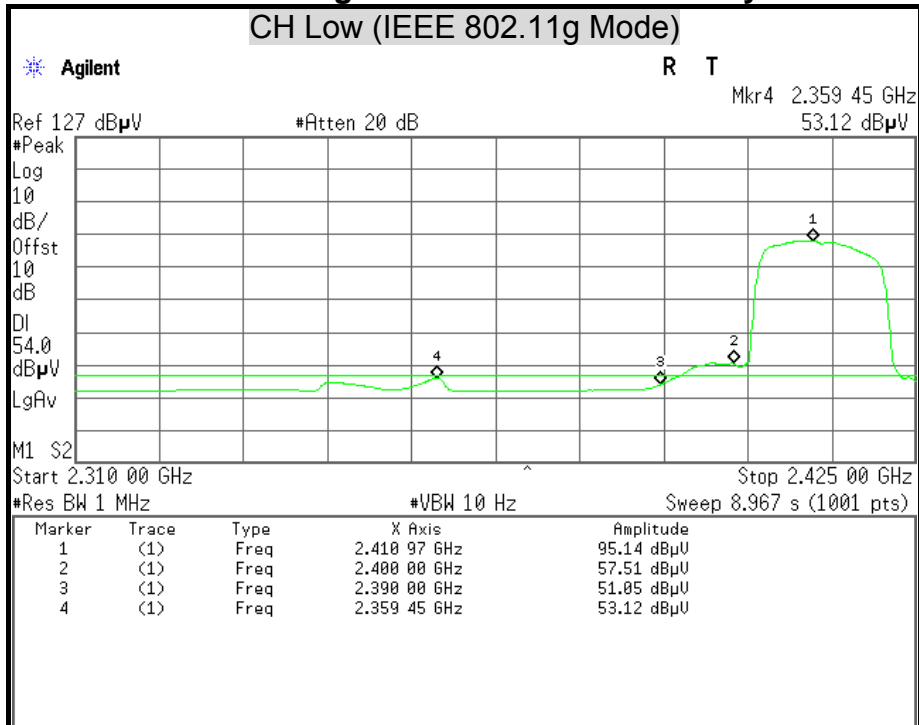



Detector Mode : Peak

Polarity : Horizontal

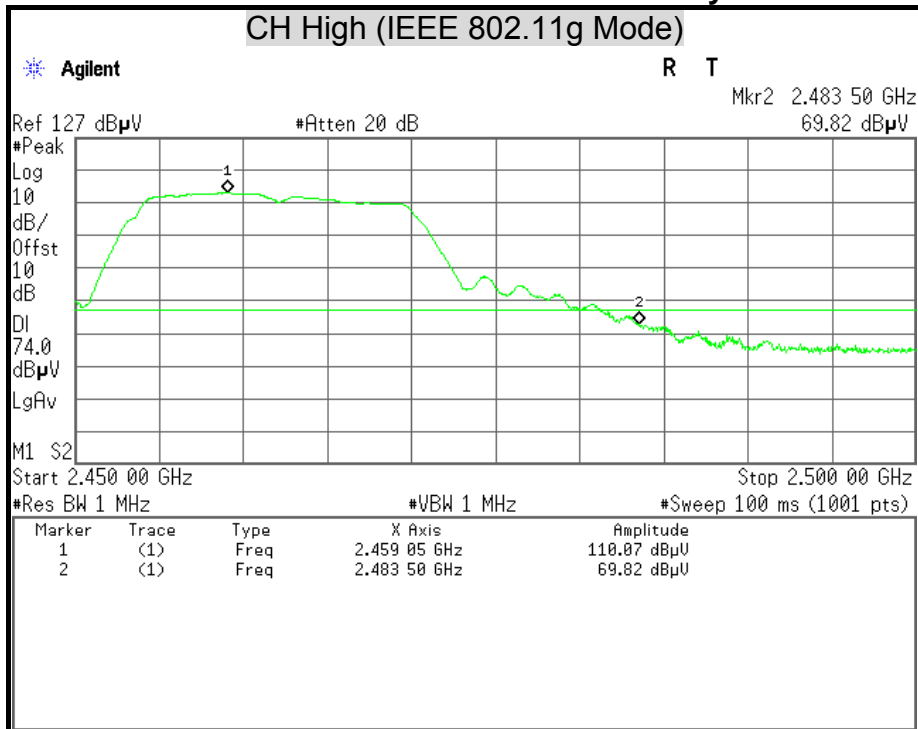

Detector Mode : Average

Polarity : Horizontal

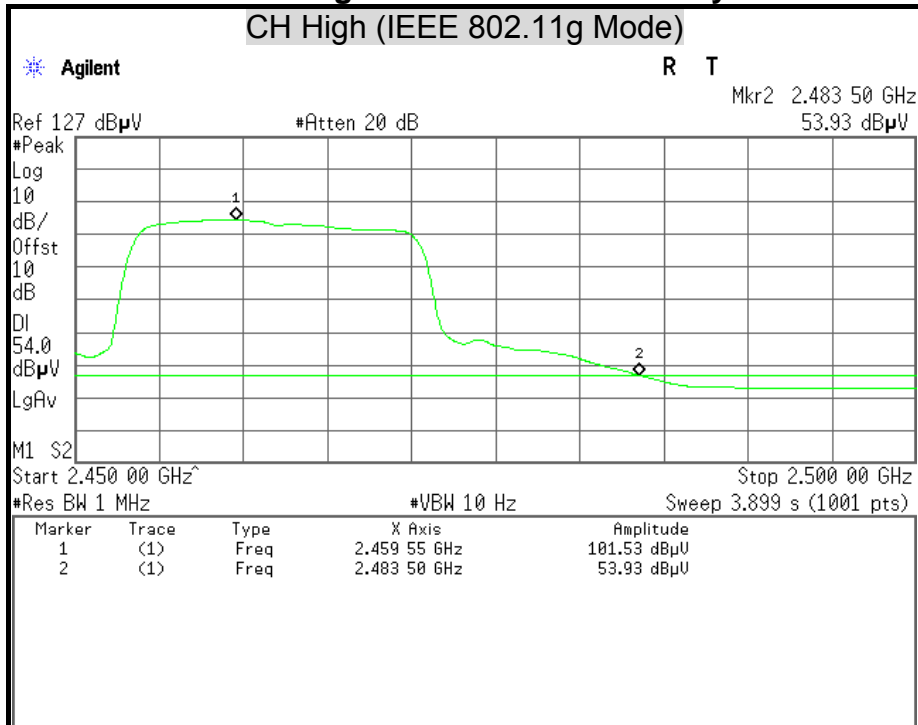



Detector Mode : Peak

Polarity : Vertical

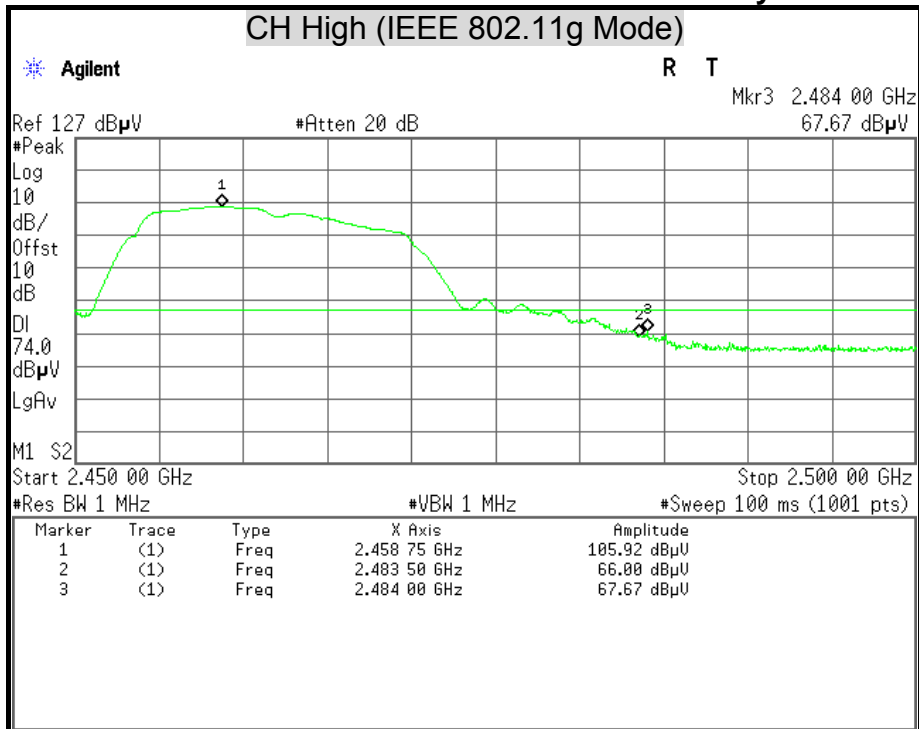

Detector Mode : Average

Polarity : Vertical

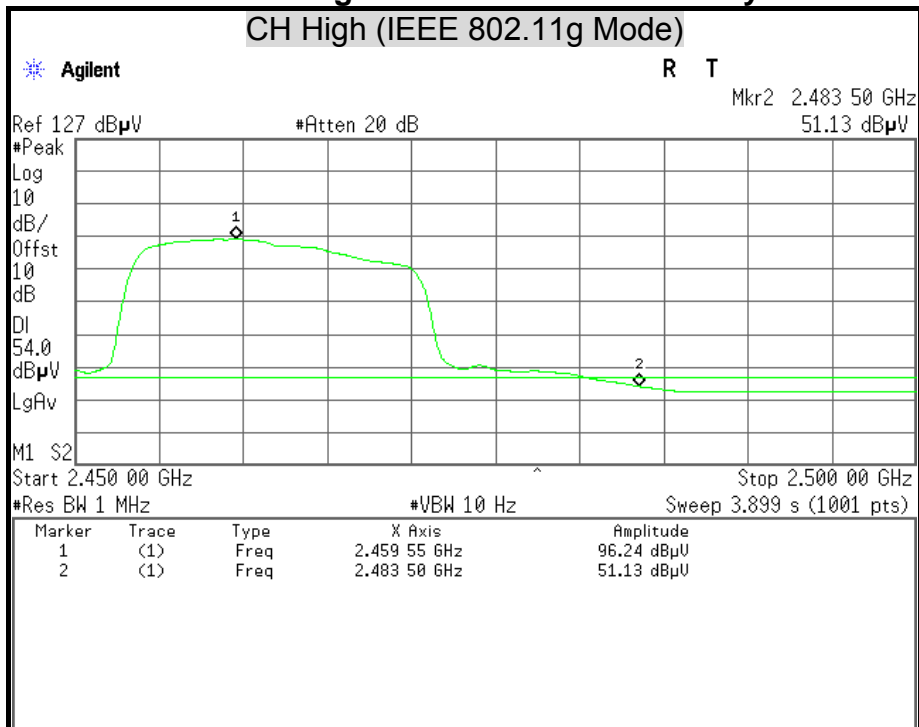



Detector Mode : Peak

Polarity : Horizontal

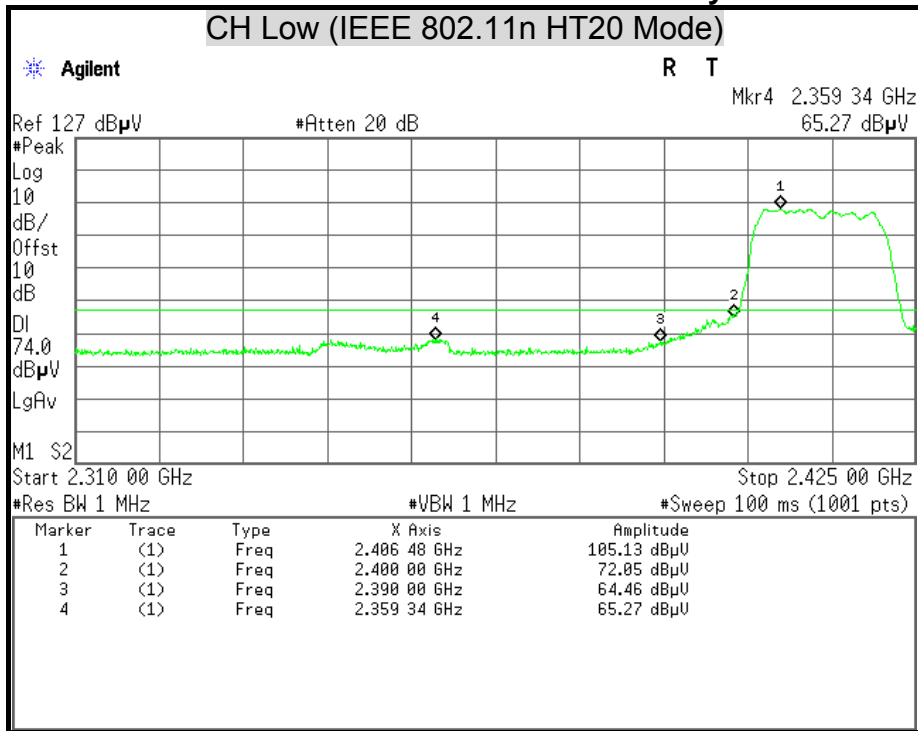

Detector Mode : Average

Polarity : Horizontal

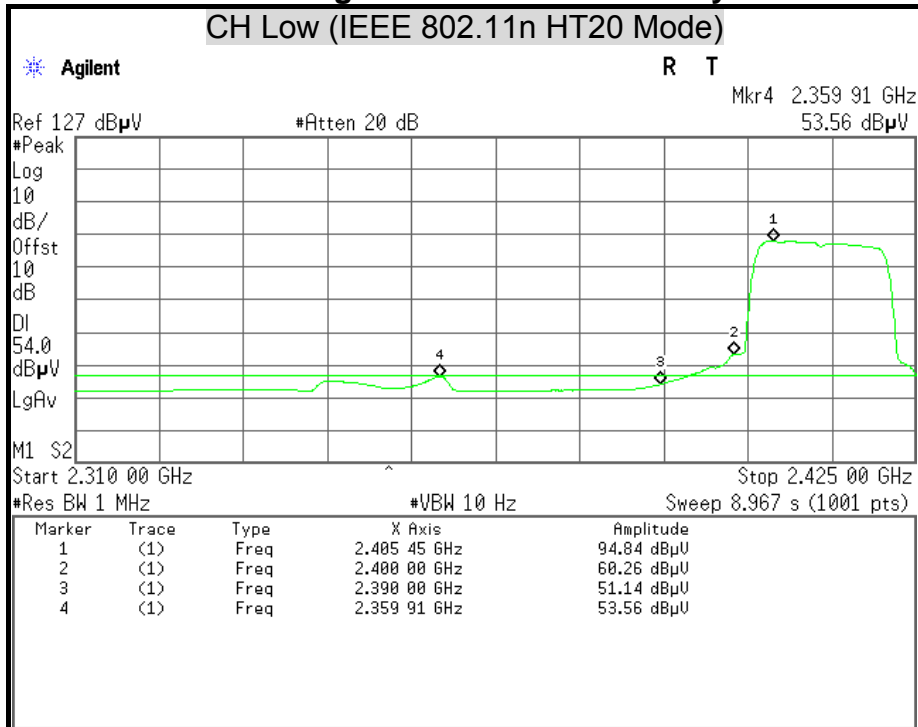



Detector Mode : Peak

Polarity : Vertical

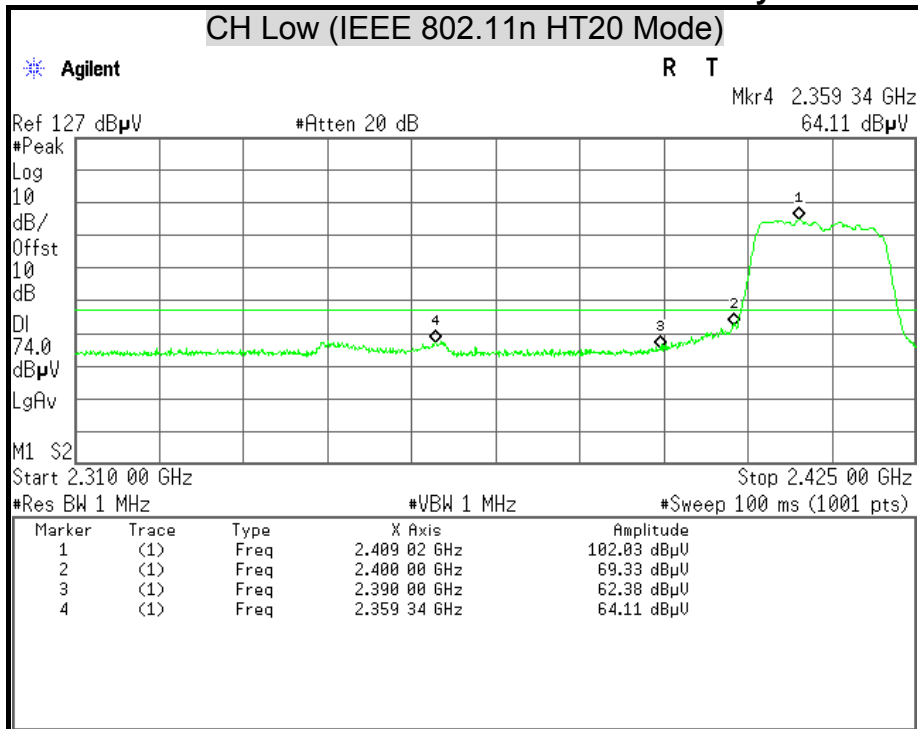

Detector Mode : Average

Polarity : Vertical

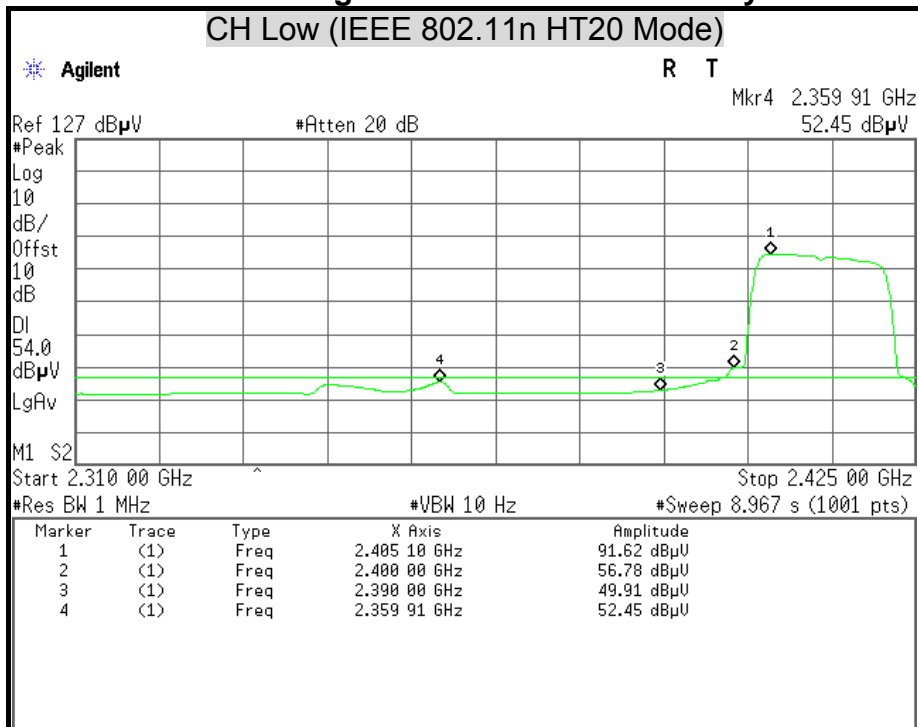



Detector Mode : Peak

Polarity : Horizontal

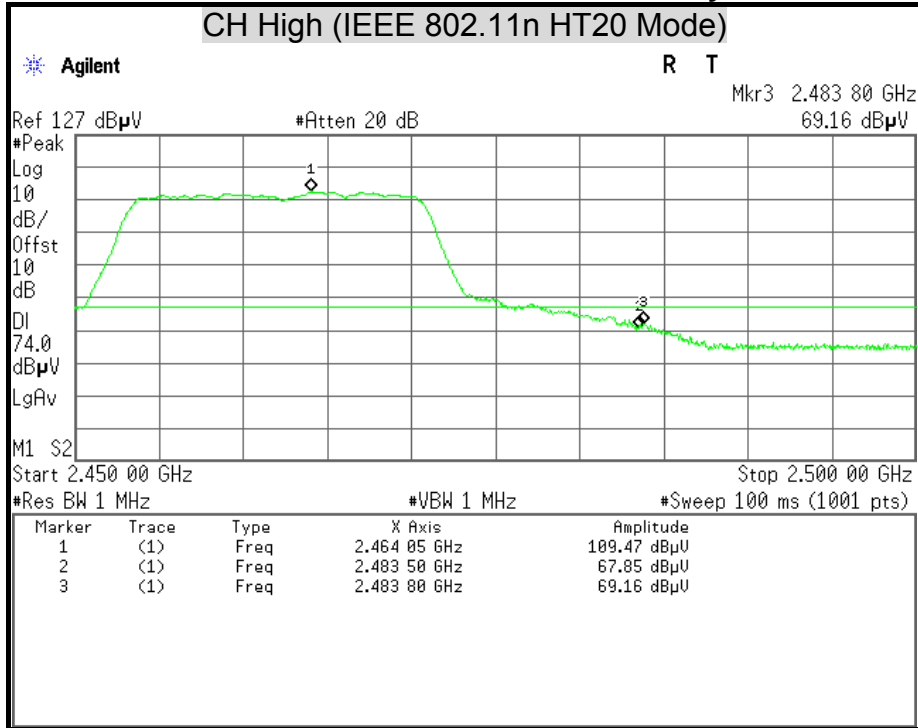

Detector Mode : Average

Polarity : Horizontal

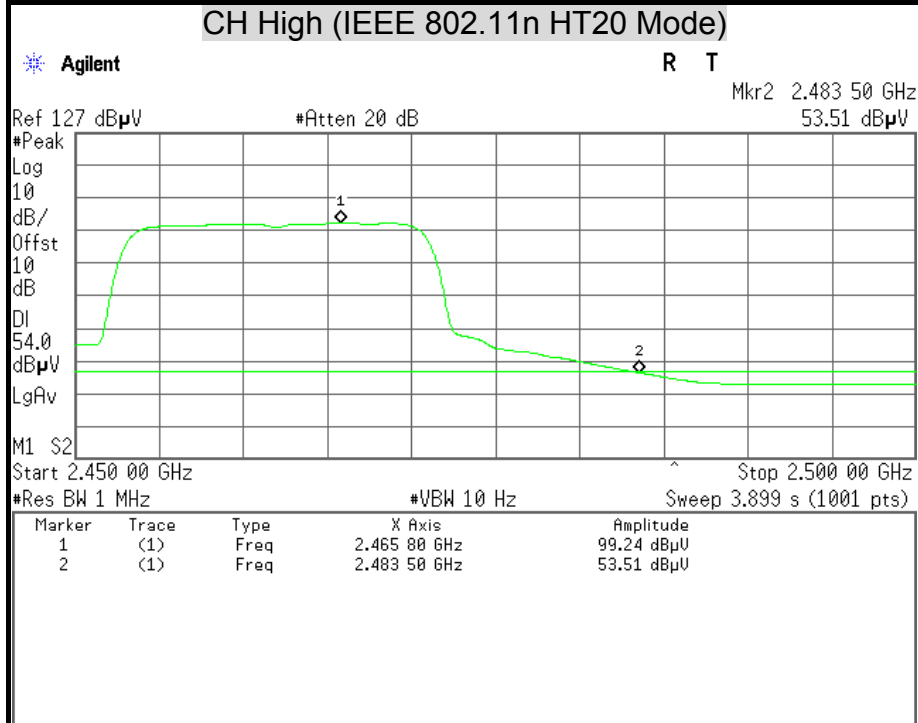



Detector Mode : Peak

Polarity : Vertical

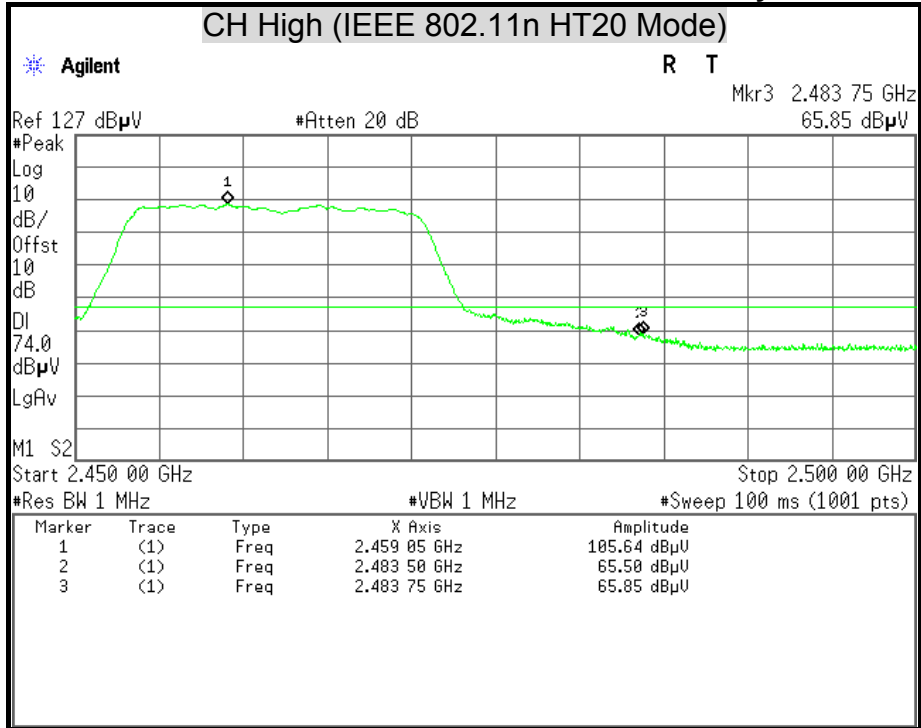

Detector Mode : Average

Polarity : Vertical

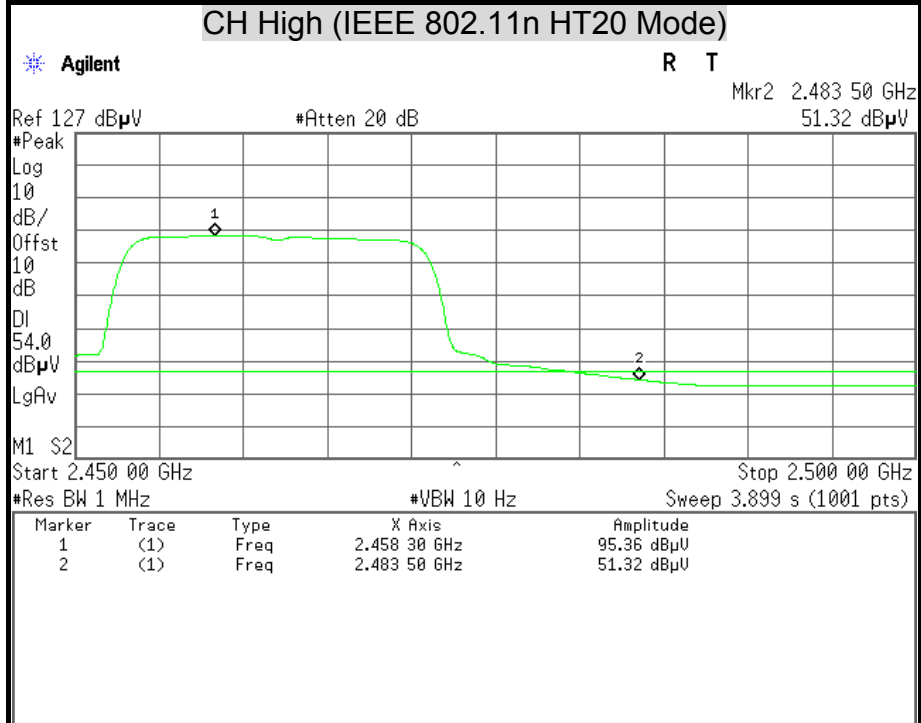



Detector Mode : Peak

Polarity : Horizontal

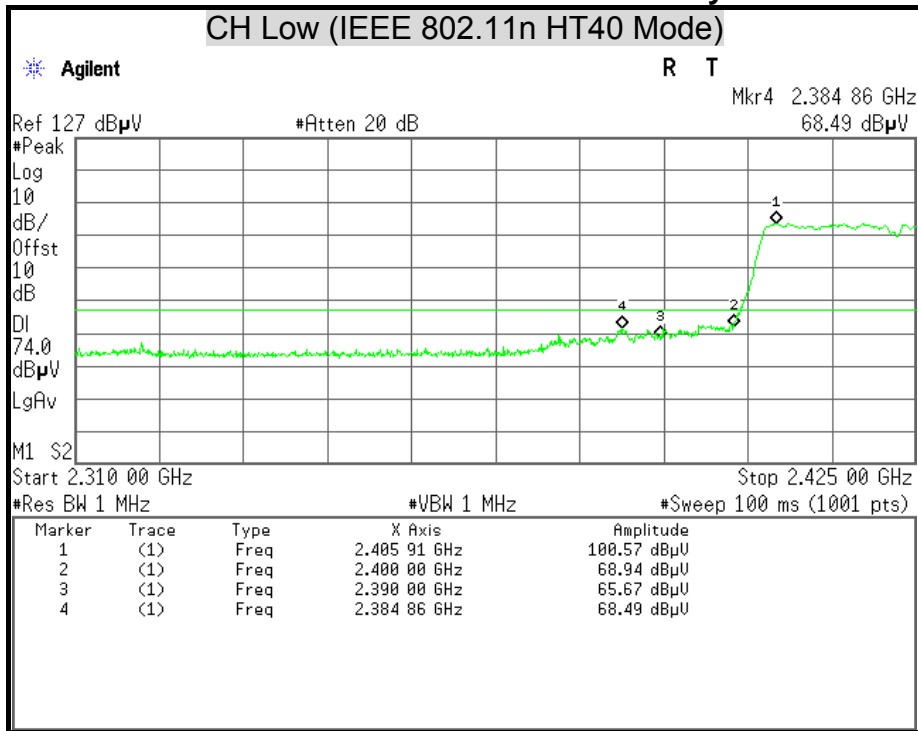

Detector Mode : Average

Polarity : Horizontal

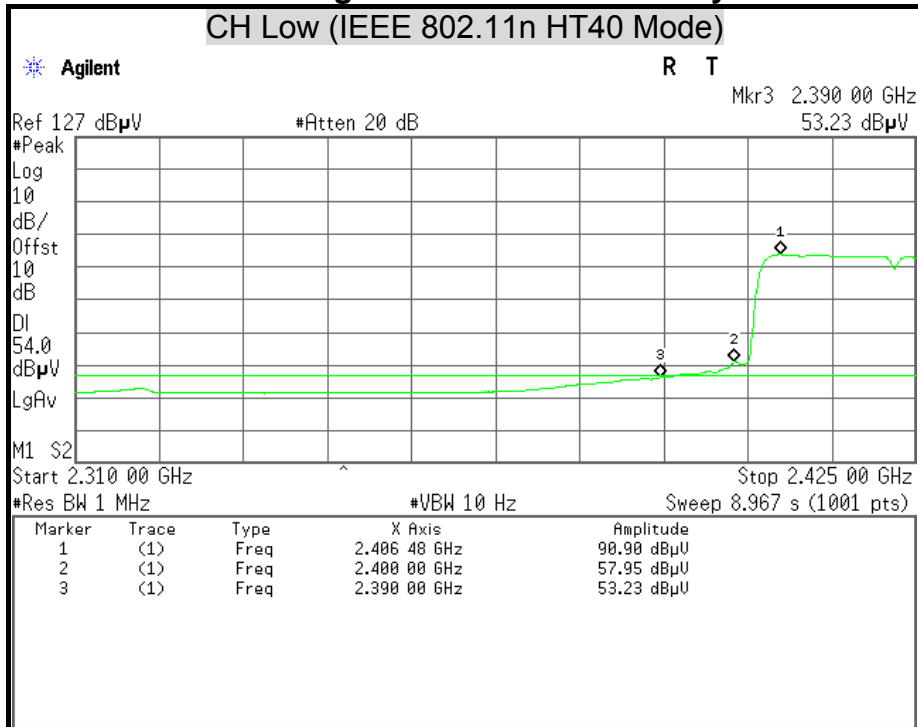



Detector Mode : Peak

Polarity : Vertical

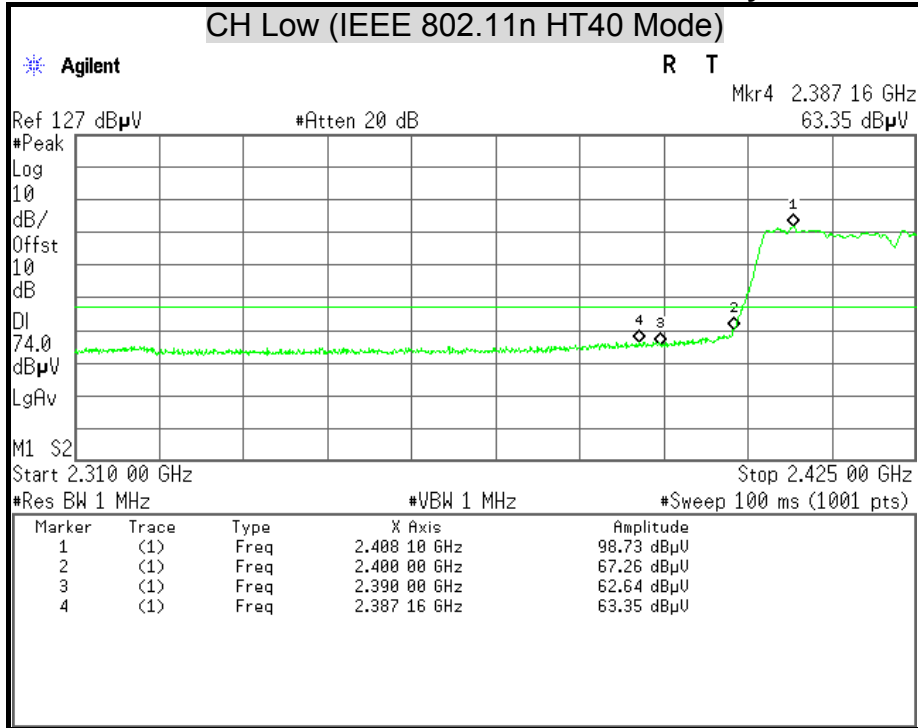

Detector Mode : Average

Polarity : Vertical

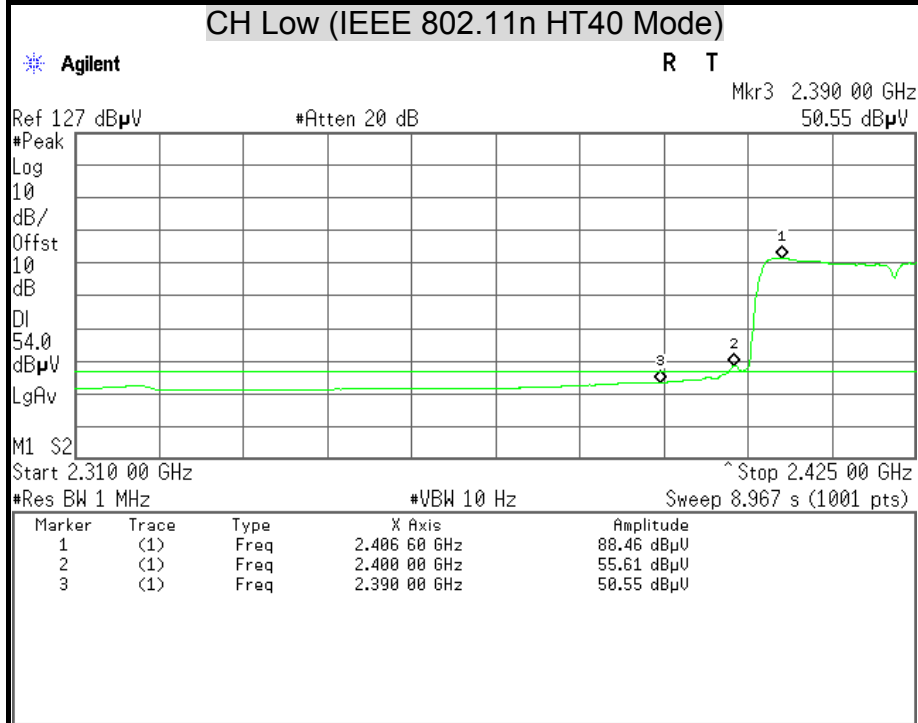



Detector Mode : Peak

Polarity : Horizontal

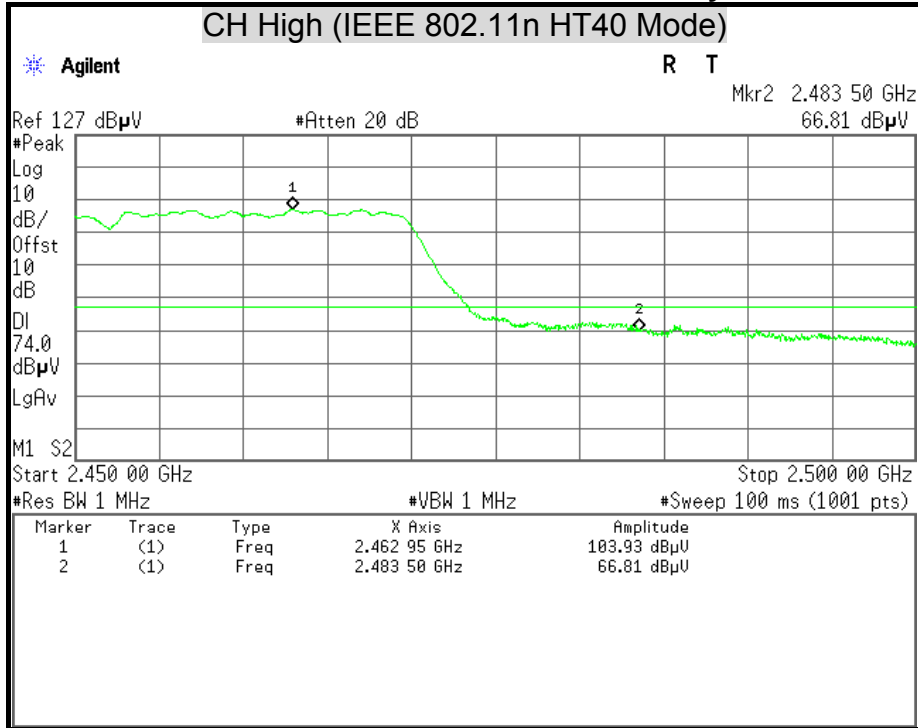

Detector Mode : Average

Polarity : Horizontal

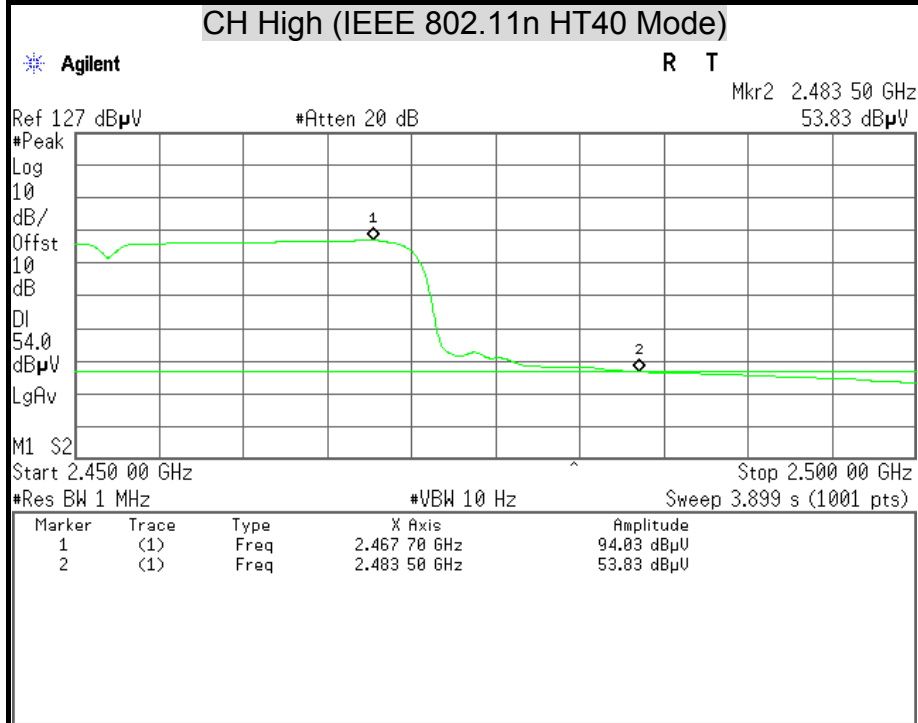



Detector Mode : Peak

Polarity : Vertical

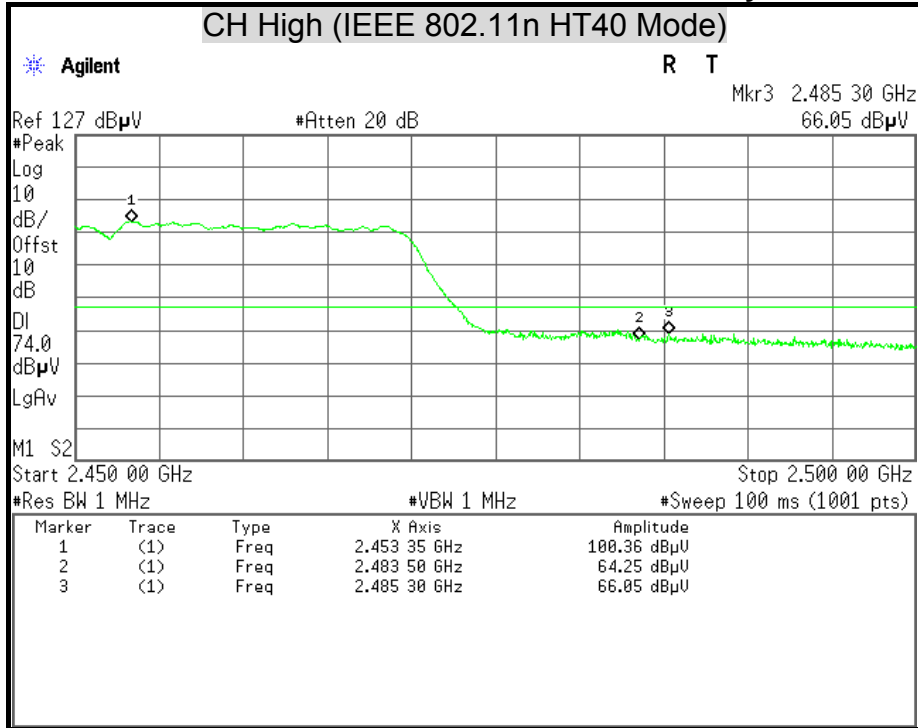

Detector Mode : Average

Polarity : Vertical

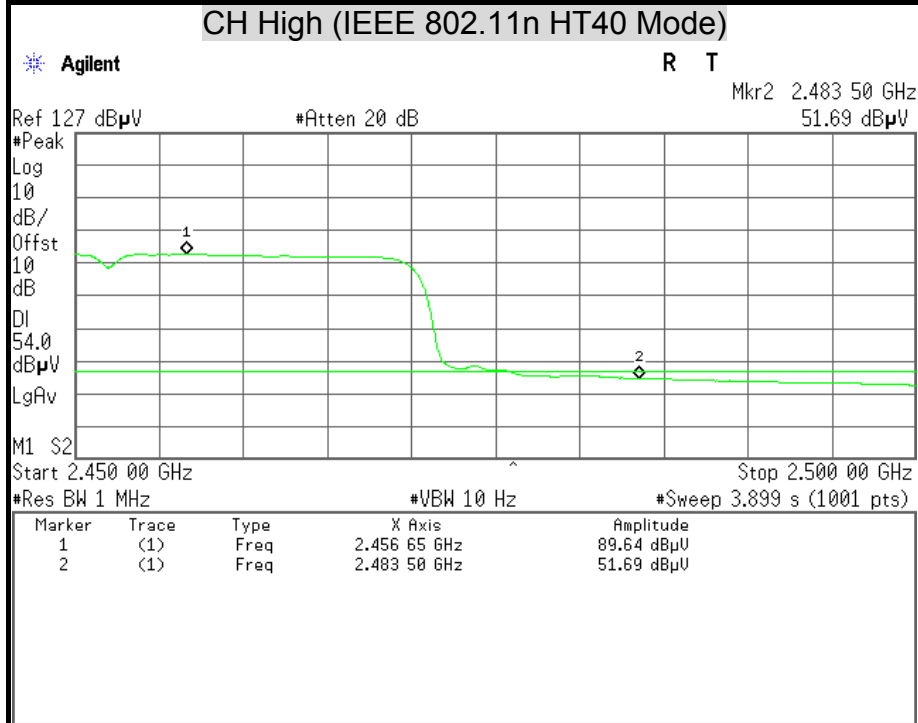



7.6 CONDUCTED EMISSION

LIMITS

§ 15.207 (a) Except as shown in paragraph (b) and (c) this section, for an intentional radiator that is designed to be connected to the public utility (AC) power line, the radio frequency voltage that is conducted back onto the AC power line on any frequency or frequencies within the band 150 kHz to 30 MHz shall not exceed the limits in the following table, as measured using a 50 µH/50 ohms line impedance stabilization network (LISN). Compliance with the provisions of this paragraph shall be based on the measurement of the radio frequency voltage between each power line and ground at the power terminal. The lower limit applies at the boundary between the frequency ranges.

Frequency Range (MHz)	Conducted Limit (dBµv)	
	Quasi-peak	Average
0.15 - 0.50	66 - 56*	56 - 46*
0.50 - 5.00	56	46
5.00 - 30.0	60	50

*Remark: * Decreasing linearly with the logarithm of the frequency.*

TEST EQUIPMENT

Name of Equipment	Manufacturer	Model	Serial Number	Calibration Due
L.I.S.N	SCHWARZBECK	NSLK 8127	8127465	08/06/2015
L.I.S.N	SCHWARZBECK	NSLK 8127	8127473	03/09/2016
EMI Test Receiver	ROHDE & SCHWARZ	ESHS 30	838550/003	11/02/2015
Pulse Limiter	ROHDE & SCHWARZ	ESH3-Z2	100111	06/30/2015

Remark: Each piece of equipment is scheduled for calibration once a year.



TEST SETUP

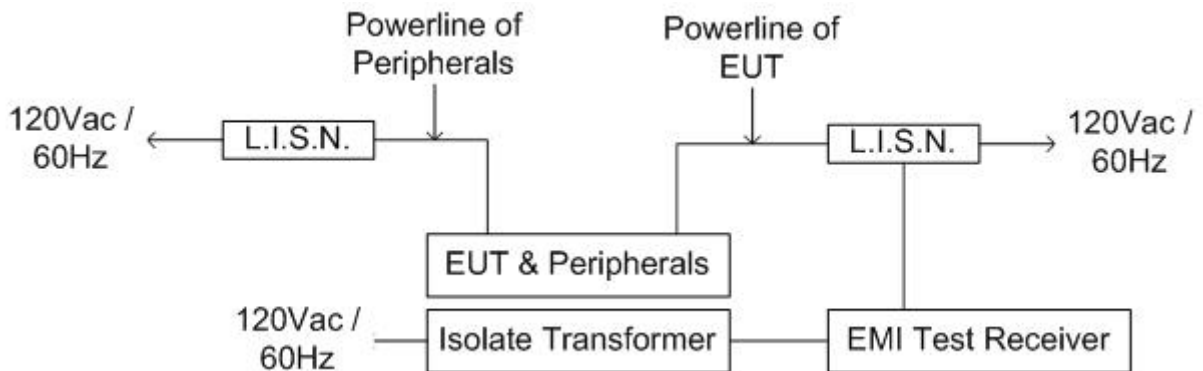
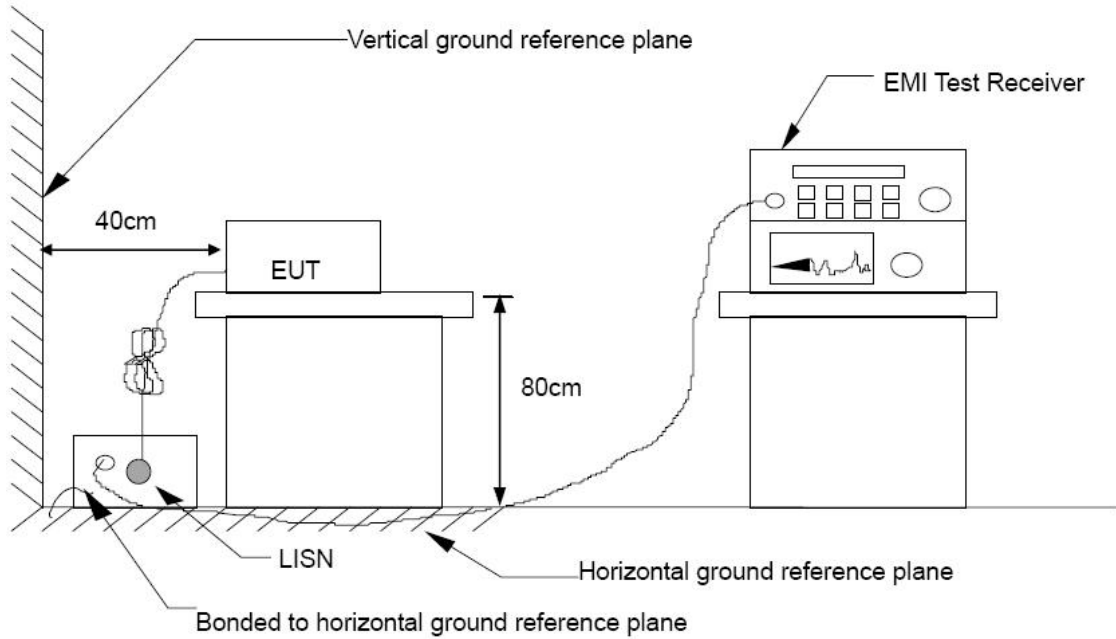



TEST PROCEDURE

The basic test procedure was in accordance with ANSI C63.10:2009.

The test procedure is performed in a 4m × 3m × 2.4m (L×W×H) shielded room.

The EUT along with its peripherals were placed on a 1.0m (W) × 1.5m (L) and 0.8m in height wooden table and the EUT was adjusted to maintain a 0.4 meter space from a vertical reference plane.

The EUT was connected to power mains through a line impedance stabilization network (LISN) which provides 50 ohm coupling impedance for measuring instrument and the chassis ground was bounded to the horizontal ground plane of shielded room. All peripherals were connected to the second LISN and the chassis ground also bounded to the horizontal ground plane of shielded room.

The EUT was located so that the distance between the boundary of the EUT and the closest surface of the LISN is 0.8 m. Where a mains flexible cord was provided by the manufacturer shall be 1 m long, or if in excess of 1 m, the excess cable was folded back and forth as far as possible so as to form a bundle not exceeding 0.4 m in length.



TEST RESULTS

Product Name	4G/LTE 4G/LTE VoIP Wireless-N VPN Broadband Router	Test By	Rueyyan Lin
Test Model	BiPAC 6300VNOZ	Temp. & Humidity	25°C, 53%
Test Mode	TX Mode / Power Port		

LINE

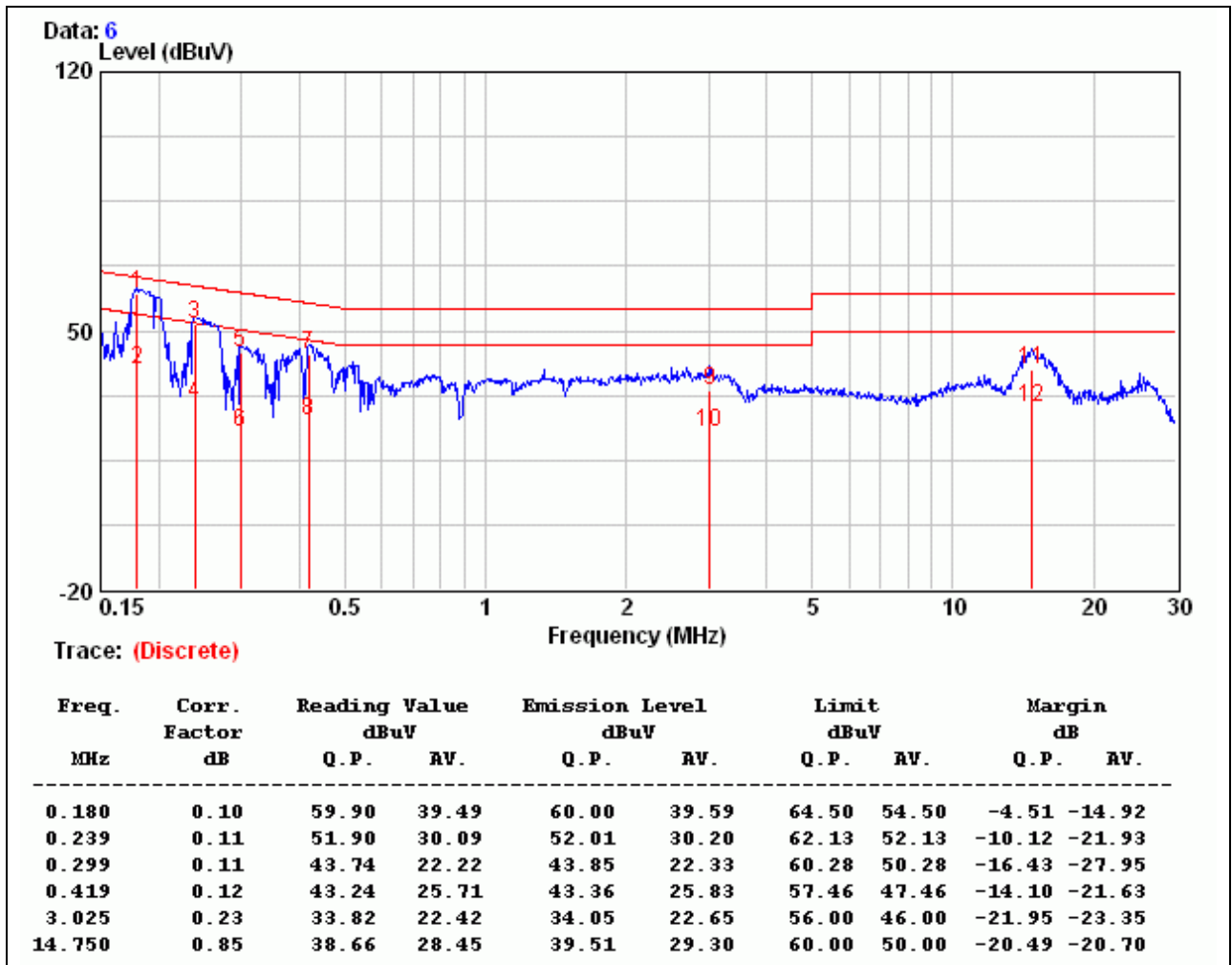

Remark:

1. Correction Factor = Insertion loss + Cable loss
2. Emission level = Reading Value + Correction factor
3. Margin value = Emission level – Limit value



Product Name	4G/LTE 4G/LTE VoIP Wireless-N VPN Broadband Router	Test By	Rueyyan Lin
Test Model	BiPAC 6300VNOZ	Temp. & Humidity	25°C, 53%
Test Mode	TX Mode / Power Port		

NEUTRAL

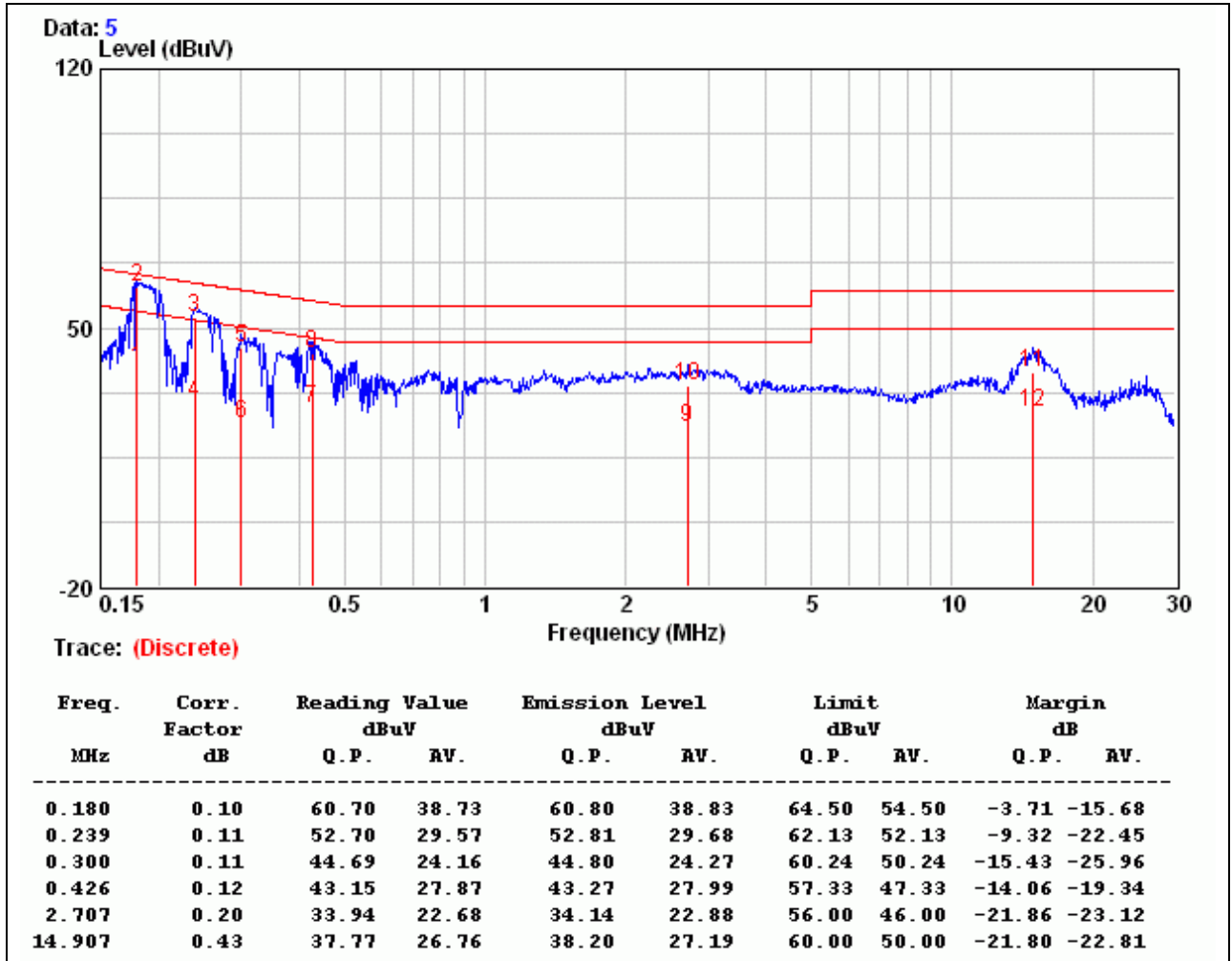

Remark:

1. Correction Factor = Insertion loss + Cable loss
2. Emission level = Reading Value + Correction factor
3. Margin value = Emission level – Limit value



Product Name	4G/LTE 4G/LTE VoIP Wireless-N VPN Broadband Router	Test By	Rueyyan Lin
Test Model	BiPAC 6300VNOZ	Temp. & Humidity	25°C, 53%
Test Mode	TX Mode / UPS Port		

LINE

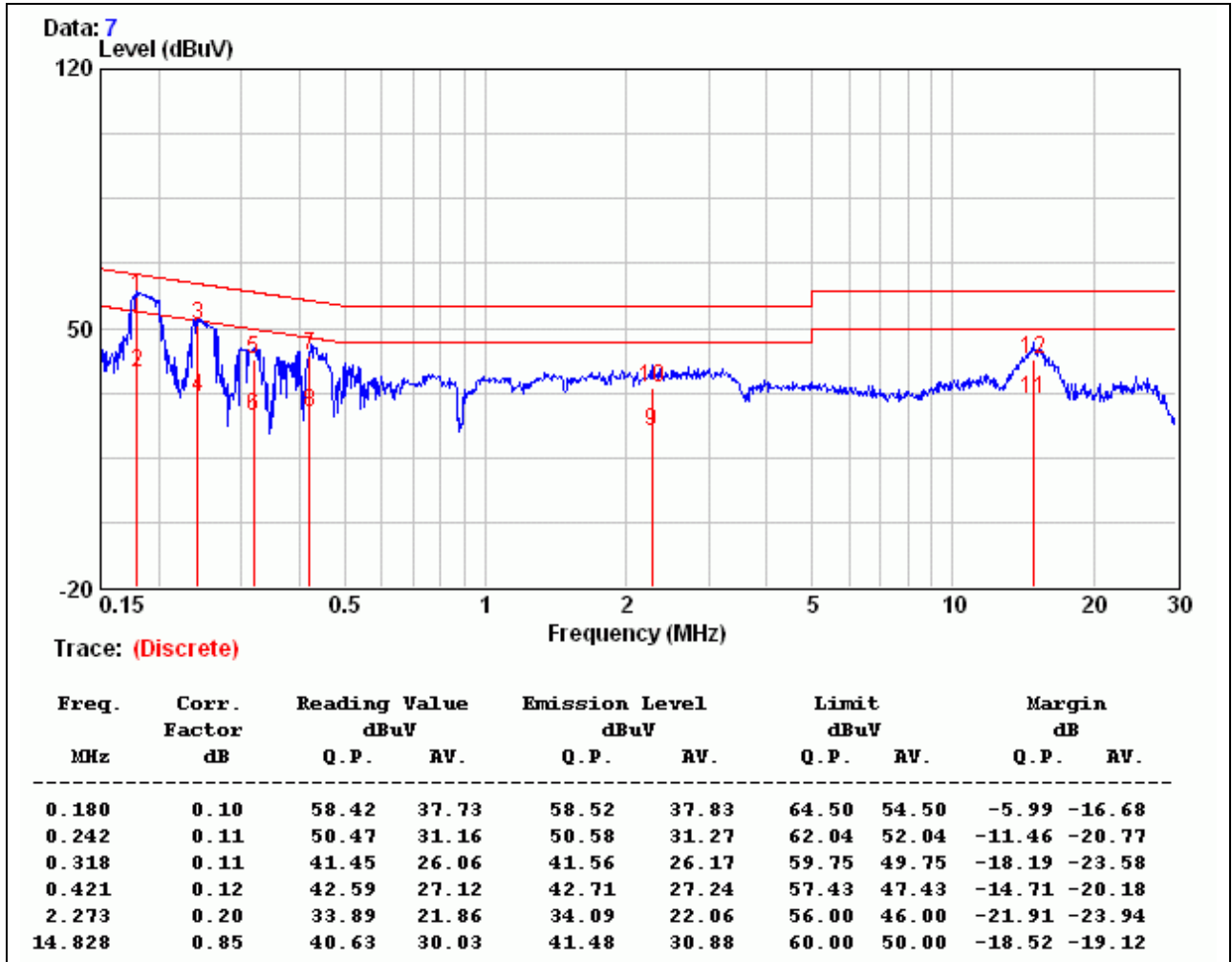

Remark:

1. Correction Factor = Insertion loss + Cable loss
2. Emission level = Reading Value + Correction factor
3. Margin value = Emission level - Limit value



Product Name	4G/LTE 4G/LTE VoIP Wireless-N VPN Broadband Router	Test By	Rueyyan Lin
Test Model	BiPAC 6300VNOZ	Temp. & Humidity	25°C, 53%
Test Mode	TX Mode / UPS Port		

NEUTRAL

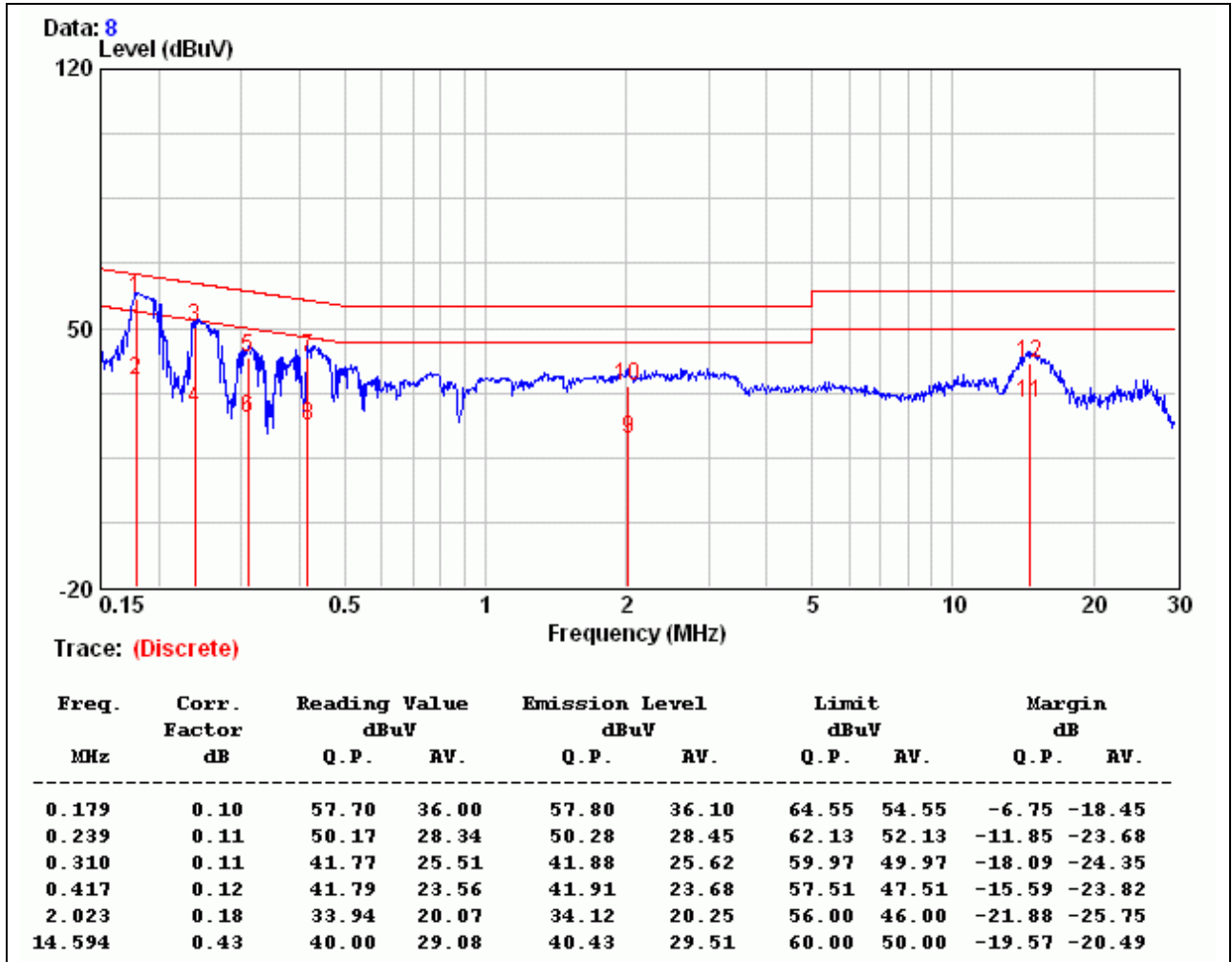

Remark:

1. Correction Factor = Insertion loss + Cable loss
2. Emission level = Reading Value + Correction factor
3. Margin value = Emission level – Limit value