



FCC TEST REPORT

According to

FCC Rules and Regulations

Part 15 Subpart C

Applicant : Billion Electric Co., Ltd.

Address : 8F., No. 192, Sec. 2, Chung Hsing Road,
Hsin Tien City, Taipei Hsien, Taiwan, R.O.C.

Equipment : Wireless-N HomePlug AV200 Ethernet Adapter

Model No. : BiPAC 2073N, BEC 2073N, BiPAC 2171N,
BEC 2171N, BiPAC 3100SN, BiPAC 2073W,
BEC 2073W, BiPAC 3100SW, 220P-I1, 210P-I1,
BEC 3100SN, BEC 3100SW

FCC ID : QI3BIL-2073N-R

Trade Name : Billion, BEC, Innoband

Laboratory Accreditation



- The test result refers exclusively to the test presented test model / sample.,
- Without written approval of **CerpPASS Technology Corp.**, the test report shall not be reproduced except in full.
- The EUT is also considered as a kind of computer peripheral, because the connection to computer is necessary for typical use. It has been verified to comply with the requirements of FCC Part 15, Subpart B, Class B (DoC). The test report has been issued separately.



Contents

1. Report of Measurements and Examinations	5
1.1 List of Measurements and Examinations	5
2. Test Configuration of Equipment under Test	6
2.1 Feature of Equipment under Test	6
2.2 Wireless LAN	7
2.3 Carrier Frequency of Channels	7
2.4 Test Mode and Test Software	8
2.5 Description of Test System	9
2.6 Connection Diagram of Test System	10
2.7 General Information of Test	11
2.8 Measurement Uncertainty	11
2.9 History of this test report	12
3. Antenna Requirements	13
3.1 Standard Applicable	13
3.2 Antenna Construction and Directional Gain	13
4. Test of Conducted Emission	14
4.1 Test Limit	14
4.2 Test Procedures	14
4.3 Typical Test Setup	15
4.4 Measurement Equipment	15
4.5 Test Result and Data of Carrier current on	16
4.6 Test Result and Data of Carrier current off	22
4.7 Test Photographs	28
5. Test of Radiated Emission	29
5.1 Test Limit	29
5.2 Test Procedures	29
5.3 Typical Test Setup	30
5.4 Measurement Equipment	30
5.5 Test Result and Data	31
5.6 Test Photographs	83
6. 6dB Bandwidth Measurement Data	84
6.1 Test Limit	84
6.2 Test Procedures	84
6.3 Test Setup Layout	84
6.4 Measurement Equipment	84
6.5 Test Result and Data	84
7. Maximum Peak Output Power	97
7.1 Test Limit	97
7.2 Test Procedures	97
7.3 Test Setup Layout	97
7.4 Measurement Equipment	98
7.5 Test Result and Data	98
8. Power Spectral Density	124
8.1 Test Limit	124



8.2 Test Procedures 124

8.3 Test Setup Layout 124

8.4 Measurement Equipment..... 124

8.5 Test Result and Data 124

9. Band Edges Measurement 137

9.1 Test Limit 137

9.2 Test Procedure 137

9.3 Test Setup Layout 137

9.4 Measurement Equipment..... 137

9.5 Test Result and Data 138

9.6 Restrict Band Emission Measurement Data 175

10. Restricted Bands of Operation 177

10.1 Labeling Requirement 177

Appendix A. Photographs of EUT.....A1 ~ A6



CERTIFICATE OF COMPLIANCE

According to

FCC Rules and Regulations

Part 15 Subpart C

Applicant : Billion Electric Co., Ltd.

Address : 8F., No. 192, Sec. 2, Chung Hsing Road,
Hsin Tien City, Taipei Hsien, Taiwan, R.O.C.

Equipment : Wireless-N HomePlug AV200 Ethernet Adapter

Model No. : BiPAC 2073N, BEC 2073N, BiPAC 2171N,
BEC 2171N, BiPAC 3100SN, BiPAC 2073W,
BEC 2073W, BiPAC 3100SW, 220P-I1, 210P-I1,
BEC 3100SN, BEC 3100SW

FCC ID : QI3BIL-2073N-R

I **HEREBY** CERTIFY THAT :

The measurements shown in this test report were made in accordance with the procedures given in **ANSI C63.4**. The equipment was **passed** the test performed according to **FCC Rules and Regulations Part 15 Subpart C (2005)**.

The test was carried out on Jan. 27, 2011 at CerpPASS Technology Corp.

Signature

Clark Lin

EMC/RF B.U. Manager



1. Report of Measurements and Examinations

1.1 List of Measurements and Examinations

FCC Rule	Description of Test	Result
15.203	. Antenna Requirement	Pass
15.207	. Conducted Emission	Pass
15.209 15.247(d)	. Radiated Emission	Pass
15.247(a)(2)	. 6dB Bandwidth	Pass
15.247(b)	. Maximum Peak Output Power	Pass
15.247(d)	. 100kHz Bandwidth of Frequency Band Edges	Pass
15.247(e)	. Power Spectral Density	Pass
1.1307 1.1310 2.1091 2.1093	. RF Exposure Compliance	Pass



2. Test Configuration of Equipment under Test

2.1 Feature of Equipment under Test

Protocol	TDMA, CSMA/CA
Standard	Ethernet specification: IEEE 802.3, IEEE 802.3x, IEEE 802.3u, Auto MDI/MDIX
Transmission Speed	200Mbps
Modulation	Supports OFDM – 1155 carriers, 1024 / 256 / 64 / 16 / 8 QAM, QPSK, BPSK and ROBO
Frequency Band	2MHz ~ 30MHz
Security	128-bit AES Link Encryption with key management for secure power line communications Encryption: NMK (Network Membership Key) used to authenticate/access Rotating NEK (Network Encryption Key)
Operating System	Windows 98 / 98SE / Me / 2000 / XP / Vista Other 10/100 Base-T Ethernet devices
Power Supplier	Input: 100 ~ 240V AC, 50 ~ 60Hz Protection: OCP, OVP, SCP
Physical Interface	AC power plug 2 fixed antennas WPS button Sync button Reset button RJ-45 compatible LED display: - WLAN - Power - PLC (Powerline Link/Act) - ETH (Ethernet Link/Act)
Physical Specifications	Dimensions (W, D, H): 4.42" x 3.05" x 2.12" (112.4mm x 77.4mm x 53mm)
Operating Environment	Operating temperature: 0 ~ 40 Storage temperature: -20 ~ 70 Humidity: 20 ~ 95% non-condensing



2.2 Wireless LAN

Spreading	802.11b: DSSS, CCK(QPSK, BPSK) 802.11g / n: OFDM (64QAM, 16QAM, QPSK, BPSK)
Frequency Range	2.4 ~ 2.484GHz
Number of Channels	802.11b/g/n HT20: -USA, Canada and Taiwan: CH 1 ~ 11 (11channels) -Most European Countries: CH 1 ~ 13 (13channels) -France: CH 1 ~ 7 (7channels) 802.11n HT40: -USA, Canada and Taiwan: CH 3 ~ 9 (7channels) -Most European Countries: CH 1 ~ 13 (13channels) -France: CH 3 ~ 5 (3channels)
Data Rate	802.11b: 11, 5.5, 2, 1 Mbps 802.11g: 54, 48, 36, 24, 18, 12, 9, 6 Mbps 802.11n HT20: 130/15, 117/14, 104/13, 78/12, 52/11, 39/10, 26/9, 13/8, 65/7, 58.5/6, 52/5, 39/4, 26/3, 19.5/2, 13/1, 6.5/0Mbps 802.11 n HT40: 270/15, 243/14, 216/13, 162/12, 108/11, 81/10, 54/9, 27/8, 135/7, 121.5/6, 108/5, 81/4, 54/3, 40.5/2, 27/1, 13.5/0Mbps
Transmit Power	802.11b: 18±2 dBm (Average); 802.11g: 15±2 dBm (Average); 802.11n HT20: 18±2dBm(Tx1+Tx2 Average); 802.11n HT40: 18±2dBm (Tx1+Tx2 Average)
Antenna Type / Gain	Dipole antenna / Ant1: 2.24dBi; Ant2: 2.24dBi;

2.3 Carrier Frequency of Channels

802.11b, 802.11g, 802.11n HT 20

Channel	Frequency(MHz)	Channel	Frequency(MHz)
01	2412	07	2442
02	2417	08	2447
03	2422	09	2452
04	2427	10	2457
05	2432	11	2462
06	2437	---	---

802.11n HT40

Channel	Frequency(MHz)	Channel	Frequency(MHz)
---	---	07	2442
---	---	08	2447
03	2422	09	2452
04	2427	---	---
05	2432	---	---
06	2437	---	---



2.4 Test Mode and Test Software

- a. During testing, the interface cables and equipment positions were varied according to ANSI C63.4.
 - b. The complete test system included remote workstation, PC, Monitor, Keyboard, Mouse, Modem, Printer and EUT for RF test. The remote workstation included Notebook and EUT.
 - c. An executive program, ping.exe under WIN XP, which transmits and receives data to the remote workstation through Wireless (270M).
 - d. The following test modes were performed for test:
 - 802.11b/g/n HT20: CH01: 2412MHz, CH06: 2437MHz, CH11: 2462MHz
 - 802.11n HT40: CH03: 2422MHz, CH06: 2437MHz, CH09: 2452MHz
 - e. For Radiated Emission test, the EUT was set by three orthogonal. The performed data was the worst case.
 - f. The following data rates were the worst cases of power output and be performed for test:
 - 802.11b: 11Mbps
 - 802.11g: 54Mbps
 - 802.11n HT20: 130Mbps
 - 802.11n HT40: 270Mbps
- * Power output of data rate:

802.11b		802.11g	
Data Rate (Mbps)	Power output (dBm)	Data Rate (Mbps)	Power output (dBm)
11	20.39	54	16.73
5.5	20.20	48	16.64
2	19.72	36	16.57
1	19.67	24	16.47
		18	16.51
		12	16.55
		9	16.53
		6	16.50

802.11n HT20		802.11n HT40	
Data Rate (Mbps)	Power output (dBm)	Data Rate (Mbps)	Power output (dBm)
130/15	18.66	270/15	17.81
117/14	18.60	243/14	17.73
104/13	18.53	216/13	17.71
78/12	18.39	162/12	17.58
52/11	18.41	108/11	17.47
39/10	18.40	81/10	17.45
26/9	18.39	54/9	17.42
13/8	18.21	27/8	17.49
65/7	18.15	135/7	17.46
58.5/6	18.00	121.5/6	17.55
52/5	17.99	108/5	17.40
39/4	18.02	81/4	17.45
26/3	18.11	54/3	17.40
19.5/2	18.05	40.5/2	17.36
13/1	18.13	27/1	17.46
6.5/0	18.22	13.5/0	17.48



2.5 Description of Test System

Device	Manufacturer	Model No.	Description
PC	IBM	IGV	Power Cable, Unshielding 1.8 m
Monitor	ViewSonic	G90fB	Power Cable, Adapter Unshielding 1.8 m Data Cable, VGA Shielding 1.35 m
Keyboard	IBM	KB-0225	Data Cable, PS2 Shielding 1.85 m
Mouse	IBM	MU29J	PS/2 Cable, PS2 Shielding 1.85 m
Modem	ACEXX	DM-1414	Power Cable, Adapter Unshielding 1.8 m Data Cable, RS232 Shielding 1.35 m
Printer	HP	Desk Jet 400	Power Cable, Adapter Unshielding 1.8 m Data Cable, Print Shielding 1.6 m
Remote Workstation			
Notebook	DELL	PP10L	Power Cable, Adapter Unshielding 1.8 m
Notebook	TOSHIBA	PSA50T-05M00C	Power Cable, Adapter Unshielding 1.8 m

Use Cable:

Cable	Quantity	Description
RJ45	1	Unshielding, 1.5m
RJ45	1	Unshielding, 5.0m



2.6 Connection Diagram of Test System

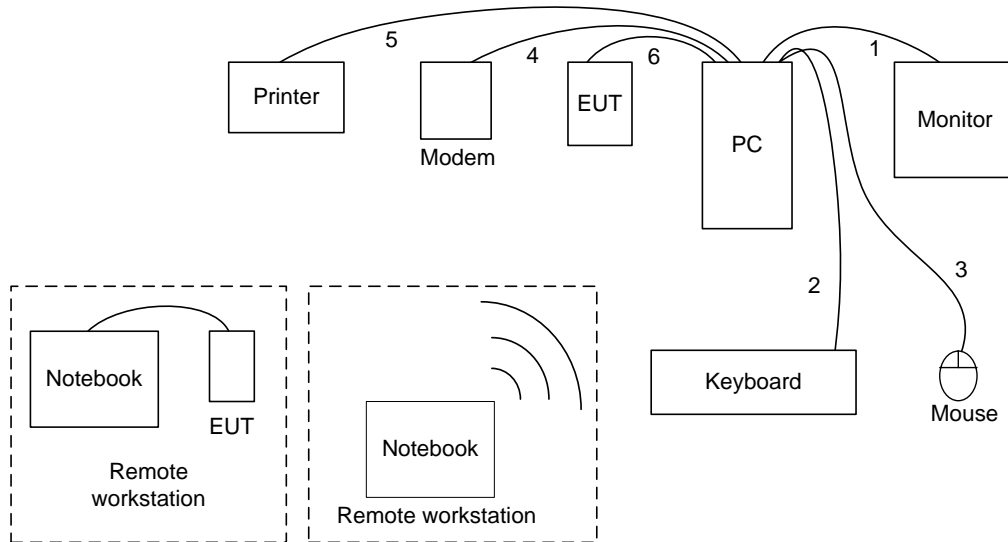

1. The VGA cable is connected from PC to the Monitor.
 2. The PS2 cable is connected from PC to the Keyboard.
 3. The PS2 cable is connected from PC to the Mouse.
 4. The RS232 cable is connected from PC to the Modem.
 5. The Print cable is connected from PC to the Printer.
 6. The RJ45 cable is connected from PC to the EUT.
- * The EUT keeps to transmit and receive data to remote workstation by Wireless.



2.7 General Information of Test

Test Site :	CerpPASS Technology Corp. 2F-11, No. 3, Yuan Qu St. (Nankang Software Park), Taipei, Taiwan 115, R.O.C.
Test Site Location (OATS1-SD):	No. 7-2, Moshihkeng, Fongtian Village, Shihding Township, Taipei County, Taiwan, R.O.C.
FCC Registration Number :	TW1049, TW1056, 982971, 488071
IC Registration Number :	4934C-1, 4934D-1
VCCI Registration Number :	T-543 for Telecommunication Test C-3328 for Conducted emission test R-3013 for Radiated emission test
Test Voltage:	AC 120V / 60Hz
Test in Compliance with:	ANSI C63.4-2003 FCC Part 15 Subpart C
Frequency Range Investigated:	Conducted: Carrier current on: from 535kHz to 1.705MHz Carrier current off: from 150kHz to 30MHz Radiation: from 30MHz to 25,000MHz
Test Distance:	The test distance of radiated emission from antenna to EUT is 3 M.

2.8 Measurement Uncertainty

Measurement Item	Measurement Frequency	Polarization	Uncertainty
Conducted Emission	9 kHz ~ 30 MHz	LINE/NEUTRAL	2.71 dB
Radiated Emission	30 MHz ~ 25GHz	Vertical	4.11 dB
		Horizontal	4.10 dB
6 dB Bandwidth	---	---	7500 Hz
Maximum Peak Output Power	---	---	1.4 dB
100kHz Bandwidth of Frequency Band Edges	---	---	2.2 dB
Power Spectral Density	---	---	2.2 dB



2.9 History of this test report

ORIGINAL.

Additional attachment as following record:

Attachment No.	Issue Date	Description
TECE0906271	Dec. 17, 2009	Missing Factor in the original report, re-perform the testing and correct the factor issue.



3. Antenna Requirements

3.1 Standard Applicable

For intentional device, according to FCC 47 CFR Section 15.203, an intentional radiator shall be designed to ensure that no antenna other than that furnished by the responsible party shall be used with the device.

And according to FCC 47 CFR Section 15.247 (b), if transmitting antennas of directional gain greater than 6dBi are used, the power shall be reduced by the amount in dB that the directional gain of the antenna exceeds 6dBi.

3.2 Antenna Construction and Directional Gain

Ant1: Dipole antenna, 2.24 dBi

Ant2: Dipole antenna, 2.24 dBi



4. Test of Conducted Emission

4.1 Test Limit

Conducted Emissions were measured from 535 kHz to 1.705 MHz, 150 kHz to 30 MHz with a bandwidth of 9 KHz on the 120 VAC power and return leads of the EUT according to the methods defined in ANSI C63.4-2003 Section 3.1. The EUT was placed on a nonmetallic stand in a shielded room 0.8 meters above the ground plane as shown in section 2.2. The interface cables and equipment positioning were varied within limits of reasonable applications to determine the position produced maximum conducted emissions.

Carrier current on:

Frequency (kHz)	Quasi Peak (dB μ V)	Quasi Peak (μ V)
535 – 1705	60	1000

Carrier current off:

Frequency (MHz)	Quasi Peak (dB μ V)	Average (dB μ V)
0.15 – 0.5	66-56*	56-46*
0.5 – 5.0	56	46
5.0 – 30.0	60	50

*Decreases with the logarithm of the frequency.

4.2 Test Procedures

- The EUT was placed 0.4 meter from the conducting wall of the shielding room was kept at least 80 centimeters from any other grounded conducting surface.
- Connect EUT to the power mains through a line impedance stabilization network (LISN).
- All the support units are connecting to the other LISN.
- The LISN provides 50 ohm coupling impedance for the measuring instrument.
- The FCC states that a 50 ohm, 50 micro-Henry LISN should be used.
- Both sides of AC line were checked for maximum conducted interference.
- The frequency range from 150 kHz to 30 MHz was searched.
- Set the test-receiver system to Peak Detect Function and Specified Bandwidth with Maximum Hold Mode.



4.3 Typical Test Setup

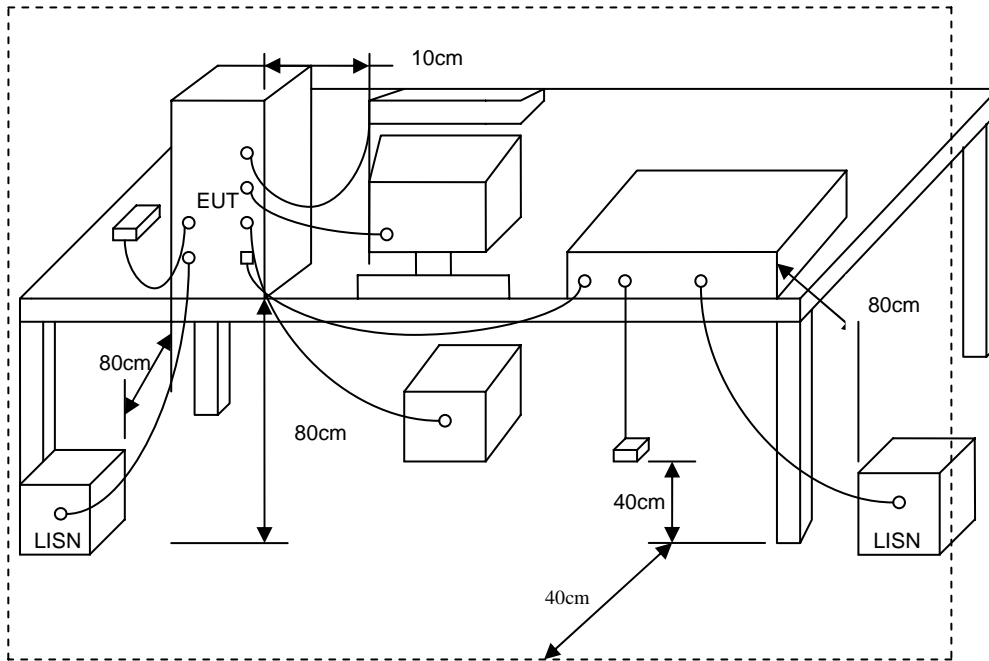

4.4 Measurement Equipment

Instrument/ Ancillary	Model No.	Manufacturer	Serial No.	Calibration Date	Valid Date
EMI Receiver	R&S	ESCI	100443	2008/12/19	2009/12/18
LISN	NSLK 8127	Schwarzbeck	8127-516	2009/05/15	2010/05/14
LISN	ROLF HEINE	NNB-2/16Z	03/10058	2009/04/18	2010/04/17



4.5 Test Result and Data of Carrier current on

Power	: AC 120V	Pol/Phase	: LINE
Test Mode 1	: 802.11g (54Mbps), CH1	Temperature	: 25 °C
Memo	: Carrier current on	Humidity	: 72 %

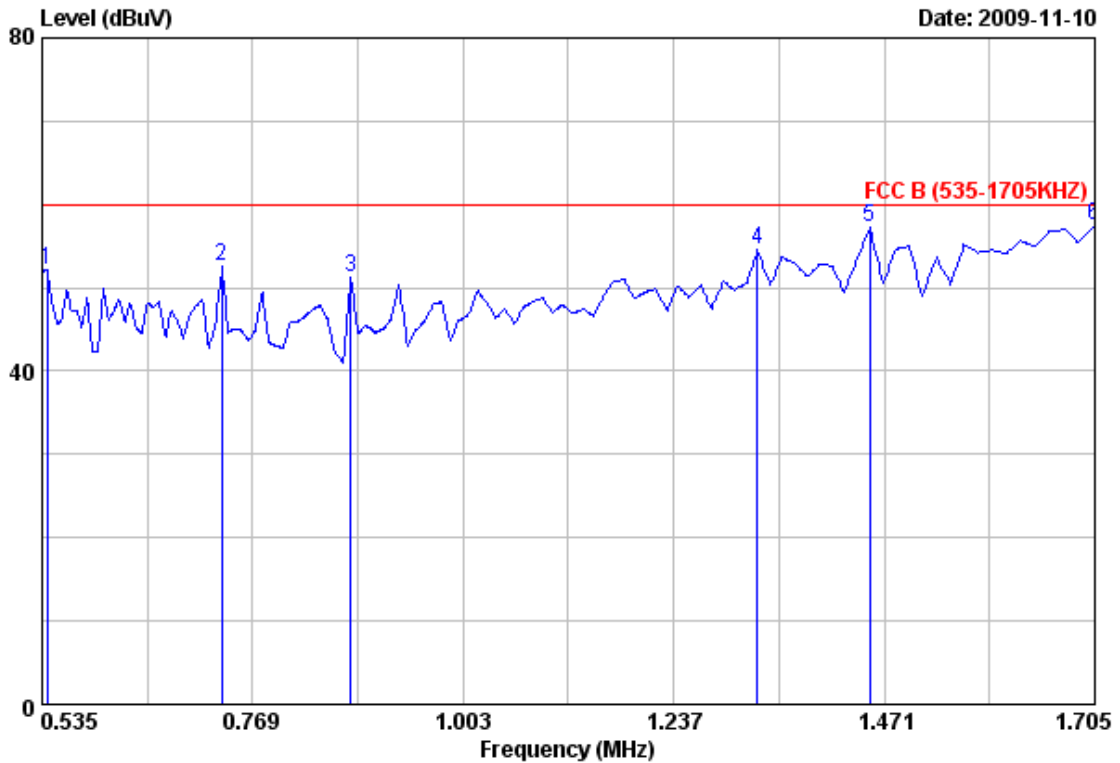

Item	Freq	Read Value	Factor	Result	Limit	Margin	Remark
	MHz	dBuV	dB/m	dBuV/m	dBuV/m	dB	
1	0.54	52.02	0.09	52.11	60.00	-7.89	Peak
2	0.73	52.46	0.09	52.55	60.00	-7.45	Peak
3	0.88	51.05	0.10	51.15	60.00	-8.85	Peak
4	1.33	54.46	0.12	54.58	60.00	-5.42	Peak
5	1.45	57.05	0.12	57.17	60.00	-2.83	Peak
6	1.71	57.47	0.13	57.60	60.00	-2.40	Peak

Notes:

1. Result = Read Value + Factor
2. Factor = LISN Factor + Cable Loss
3. All emission below 1GHz at 802.11g mode are all the same,so the 802.11g mode chosen as representative in final test.
4. According to technical experiences,all spurious emission of 802.11g mode at channel 1,6,11 are almost the same below 1GHz,so that the channel 1 was chosen as representative in final test.
5. The data is worse case.



Power	: AC 120V	Pol/Phase	: NEUTRAL
Test Mode 1	: 802.11g (54Mbps), CH1	Temperature	: 25 °C
Memo	: Carrier current on	Humidity	: 72 %

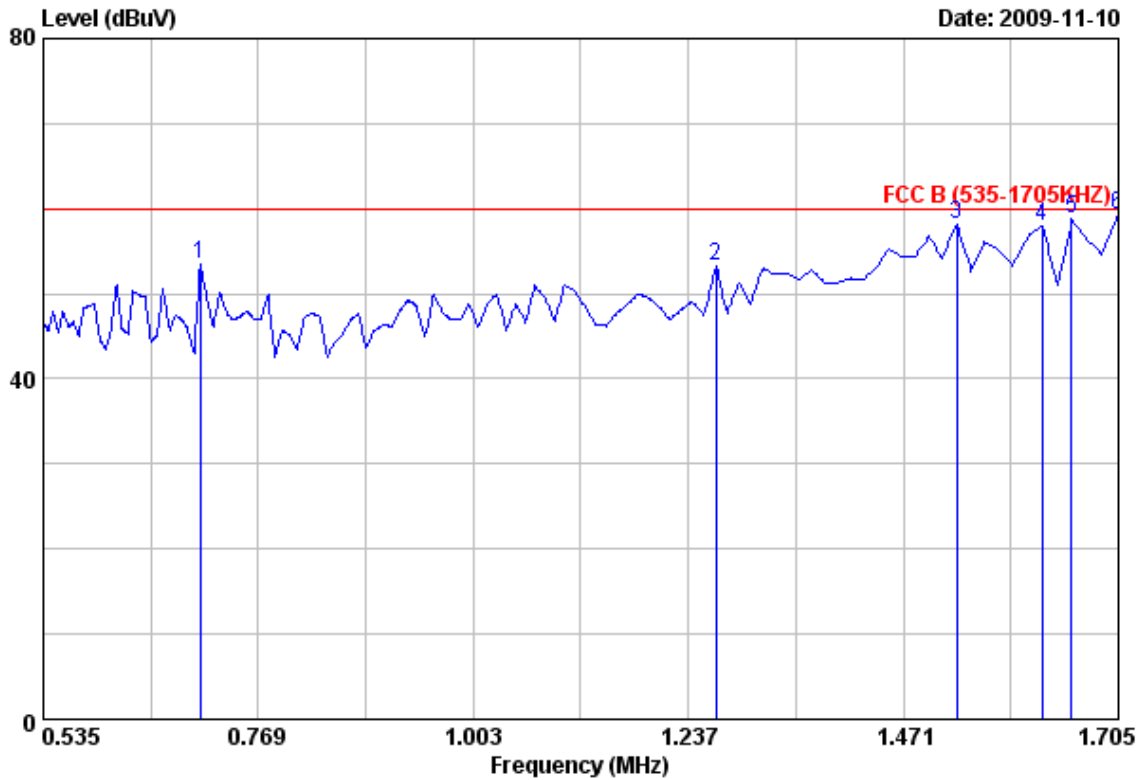

Item	Freq MHz	Read Value dBuV	Factor dB/m	Result dBuV/m	Limit dBuV/m	Margin dB	Remark
1	0.71	53.47	0.09	53.56	60.00	-6.44	Peak
2	1.27	53.10	0.11	53.21	60.00	-6.79	Peak
3	1.53	58.07	0.11	58.18	60.00	-1.82	Peak
4	1.62	57.91	0.11	58.02	60.00	-1.98	Peak
5	1.65	58.72	0.11	58.83	60.00	-1.17	Peak
6	1.71	59.22	0.12	59.34	60.00	-0.66	Peak

Notes:

1. Result = Read Value + Factor
2. Factor = LISN Factor + Cable Loss
3. All emission below 1GHz at 802.11b/g mode are all the same, so the 802.11g mode chosen as representative in final test.
4. According to technical experiences, all spurious emission of 802.11g mode at channel 1, 6, 11 are almost the same below 1GHz, so that the channel 1 was chosen as representative in final test.
5. The data is worse case.



Power	: AC 120V	Pol/Phase	: LINE
Test Mode 2	: 802.11n HT20 (130Mbps), CH1	Temperature	: 25 °C
Memo	: Carrier current on	Humidity	: 72 %

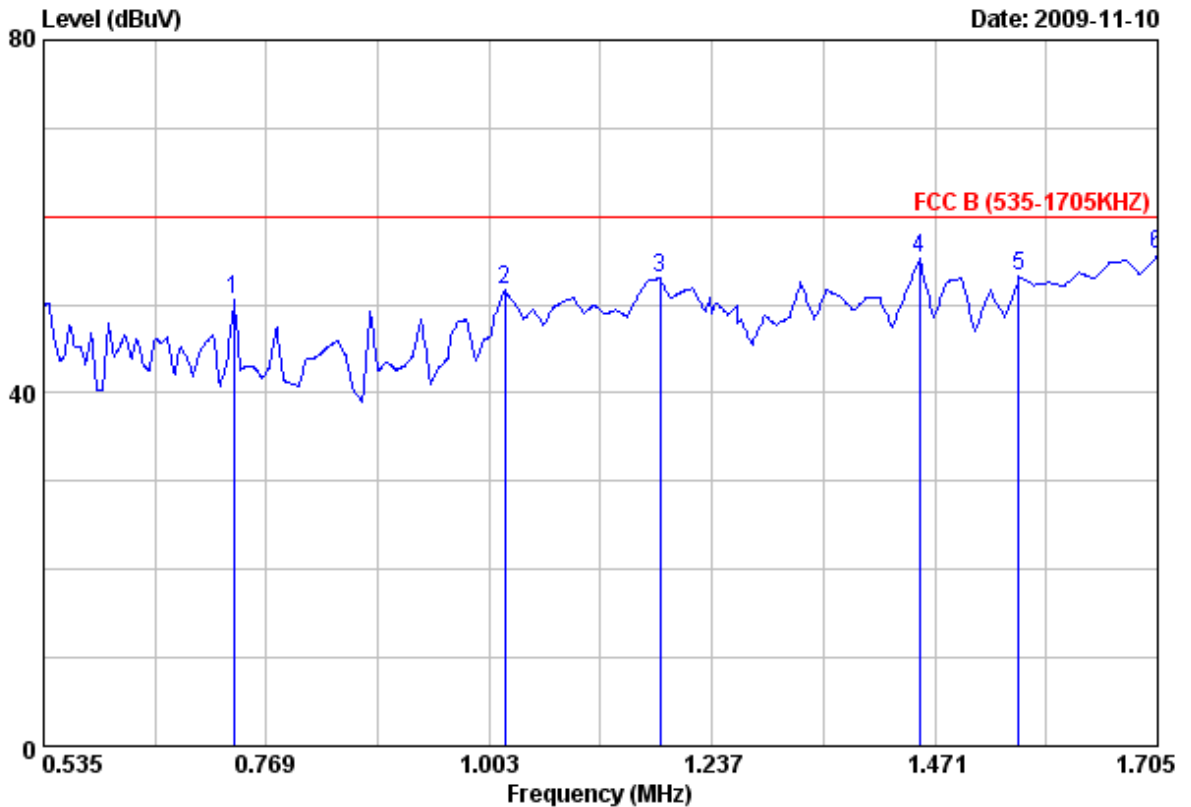

Item	Freq	Read Value	Factor	Result	Limit	Margin	Remark
	MHz	dBuV	dB/m	dBuV/m	dBuV/m	dB	
1	0.73	50.46	0.09	50.55	60.00	-9.45	Peak
2	1.02	51.54	0.10	51.64	60.00	-8.36	Peak
3	1.18	52.87	0.10	52.97	60.00	-7.03	Peak
4	1.45	55.05	0.12	55.17	60.00	-4.83	Peak
5	1.56	53.04	0.12	53.16	60.00	-6.84	Peak
6	1.71	55.47	0.13	55.60	60.00	-4.40	Peak

Notes:

1. Result = Read Value + Factor
2. Factor = LISN Factor + Cable Loss
3. According to technical experiences, all spurious emission of 802.11n mode at channel 1, 6, 11 are almost the same below 1GHz, so that the channel 1 was chosen as representative in final test.
4. The data is worse case.



Power	: AC 120V	Pol/Phase	: NEUTRAL
Test Mode 2	: 802.11n HT20 (130Mbps), CH1	Temperature	: 25 °C
Memo	: Carrier current on	Humidity	: 72 %

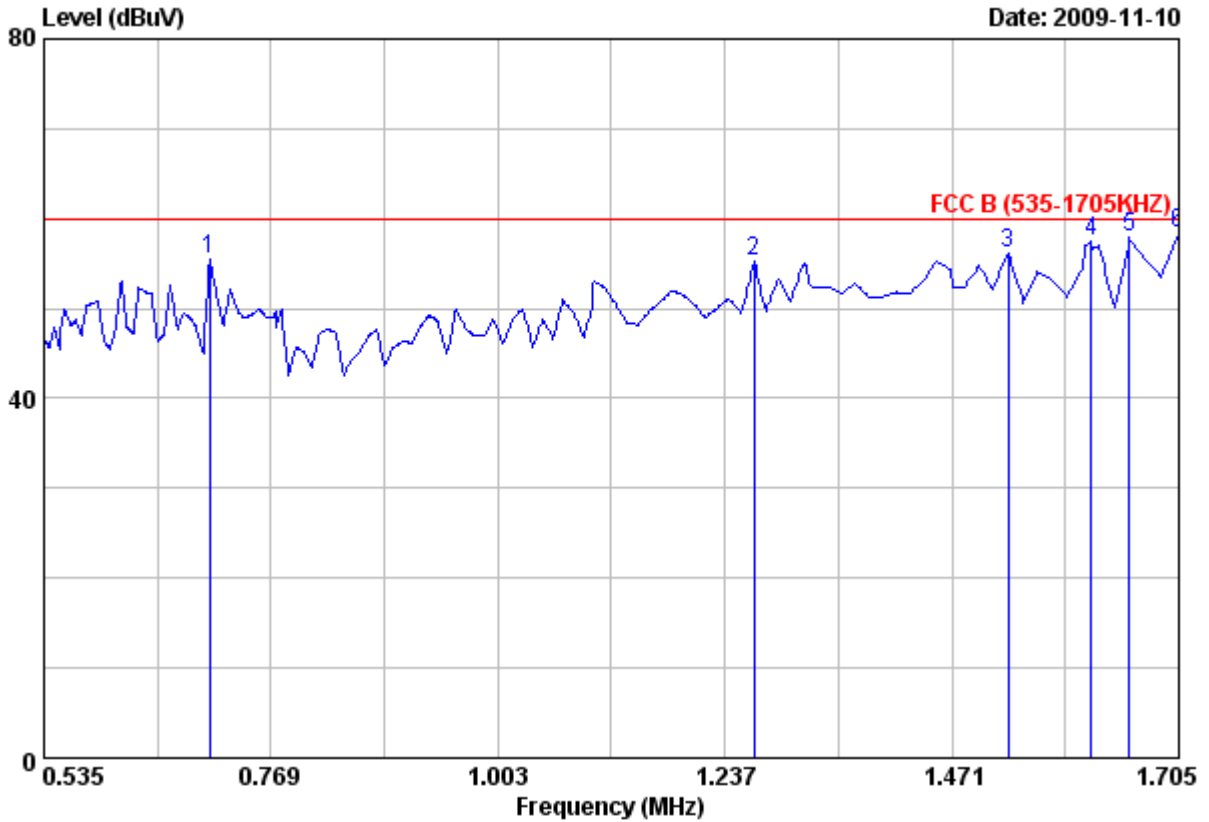

Item	Freq	Read Value	Factor	Result	Limit	Margin	Remark
	MHz	dBuV	dB/m	dBuV/m	dBuV/m	dB	
1	0.71	55.47	0.09	55.56	60.00	-4.44	Peak
2	1.27	55.10	0.11	55.21	60.00	-4.79	Peak
3	1.53	56.07	0.11	56.18	60.00	-3.82	Peak
4	1.61	57.32	0.11	57.43	60.00	-2.57	Peak
5	1.65	57.72	0.11	57.83	60.00	-2.17	Peak
6	1.71	58.22	0.12	58.34	60.00	-1.66	Peak

Notes:

1. Result = Read Value + Factor
2. Factor = LISN Factor + Cable Loss
3. According to technical experiences, all spurious emission of 802.11n mode at channel 1, 6, 11 are almost the same below 1GHz, so that the channel 1 was chosen as representative in final test.
4. The data is worse case.



Power	: AC 120V	Pol/Phase	: LINE
Test Mode 3	: 802.11n HT40 (270Mbps), CH3	Temperature	: 25 °C
Memo	: Carrier current on	Humidity	: 72 %

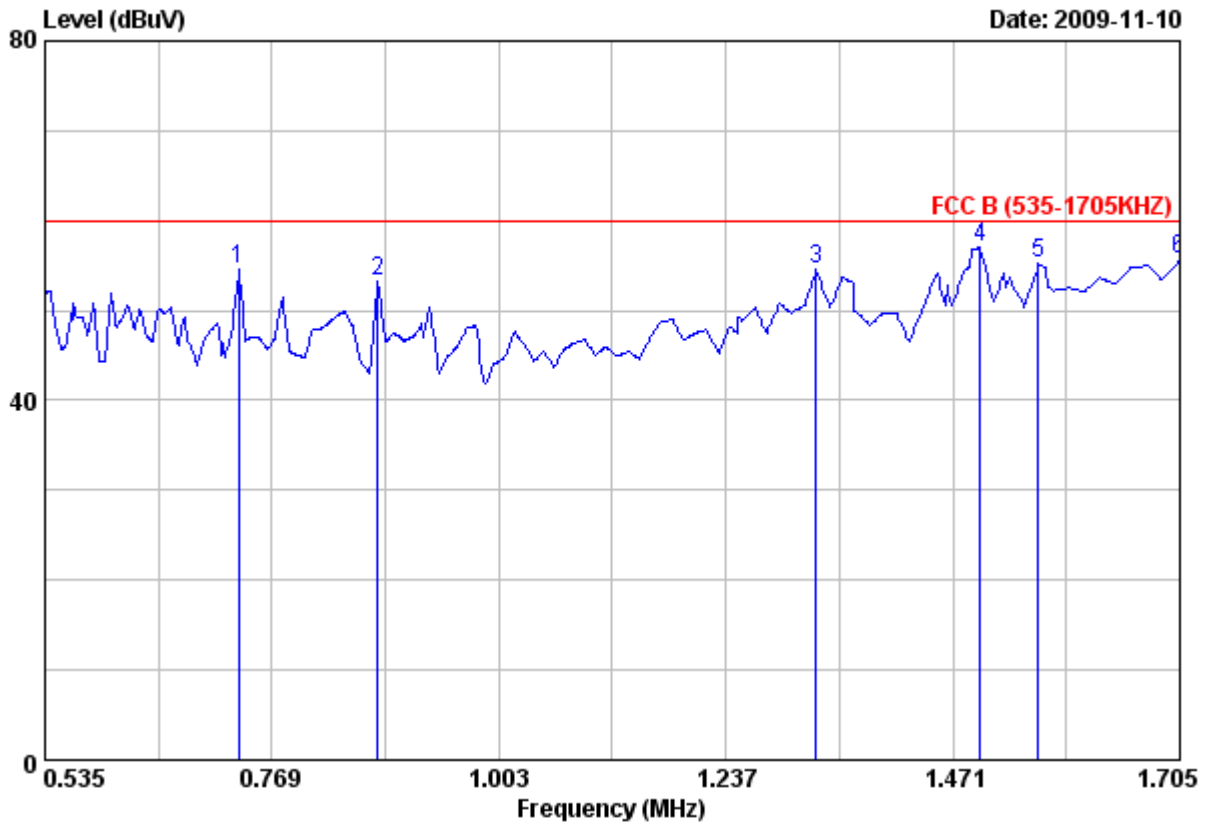

Item	Freq	Read Value	Factor	Result	Limit	Margin	Remark
	MHz	dBuV	dB/m	dBuV/m	dBuV/m	dB	
1	0.73	54.46	0.09	54.55	60.00	-5.45	Peak
2	0.88	53.05	0.10	53.15	60.00	-6.85	Peak
3	1.33	54.46	0.12	54.58	60.00	-5.42	Peak
4	1.50	56.89	0.12	57.01	60.00	-2.99	Peak
5	1.56	55.04	0.12	55.16	60.00	-4.84	Peak
6	1.71	55.47	0.13	55.60	60.00	-4.40	Peak

Notes:

1. Result = Read Value + Factor
2. Factor = LISN Factor + Cable Loss
3. According to technical experiences, all spurious emission of 802.11n mode at channel 3, 6, 9 are almost the same below 1GHz, so that the channel 3 was chosen as representative in final test.
4. The data is worse case.



Power	: AC 120V	Pol/Phase	: NEUTRAL
Test Mode 3	: 802.11n HT40 (270Mbps), CH3	Temperature	: 25 °C
Memo	: Carrier current on	Humidity	: 72 %

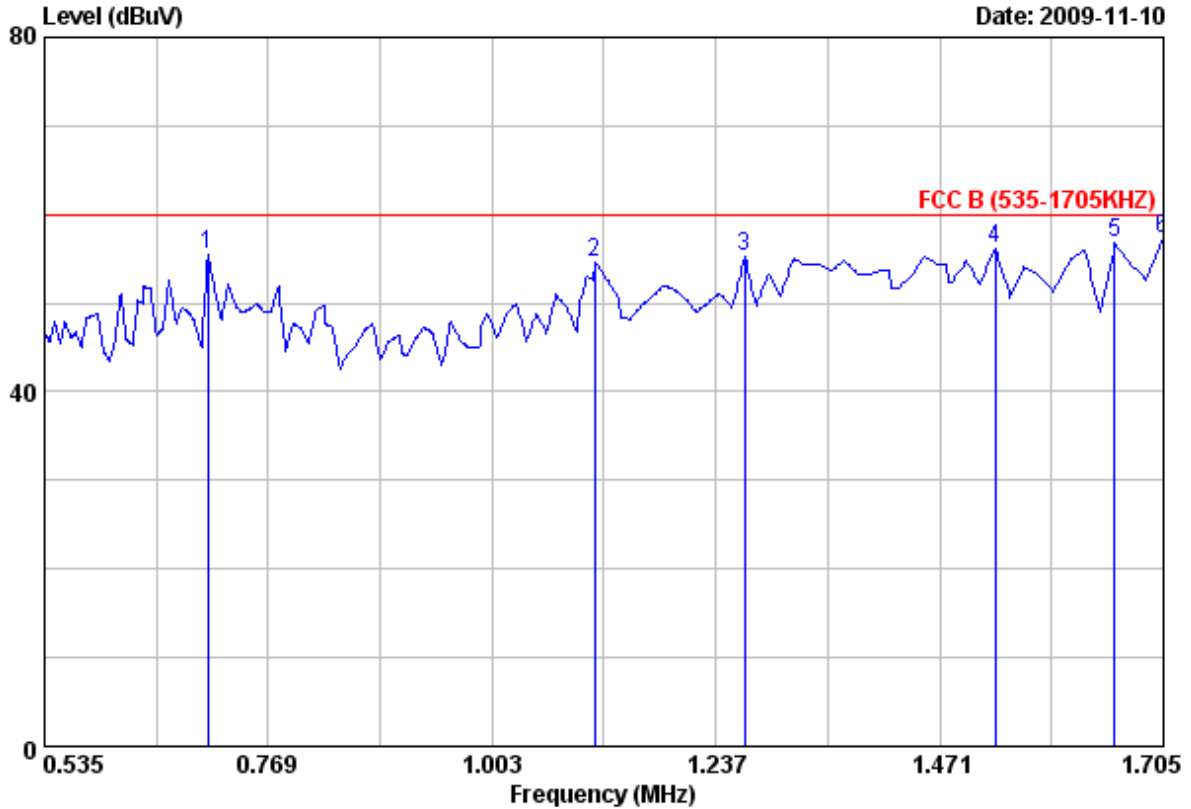

Item	Freq	Read Value	Factor	Result	Limit	Margin	Remark
	MHz	dBuV	dB/m	dBuV/m	dBuV/m	dB	
1	0.71	55.47	0.09	55.56	60.00	-4.44	Peak
2	1.11	54.44	0.10	54.54	60.00	-5.46	Peak
3	1.27	55.10	0.11	55.21	60.00	-4.79	Peak
4	1.53	56.07	0.11	56.18	60.00	-3.82	Peak
5	1.65	56.72	0.11	56.83	60.00	-3.17	Peak
6	1.71	57.22	0.12	57.34	60.00	-2.66	Peak

Notes:

1. Result = Read Value + Factor
2. Factor = LISN Factor + Cable Loss
3. According to technical experiences, all spurious emission of 802.11n mode at channel 3, 6, 9 are almost the same below 1GHz, so that the channel 3 was chosen as representative in final test.
4. The data is worse case.



4.6 Test Result and Data of Carrier current off

Power	: AC 120V	Pol/Phase	: LINE
Test Mode 1	: 802.11g (54Mbps), CH1	Temperature	: 25 °C
Memo	: Carrier current off	Humidity	: 72 %

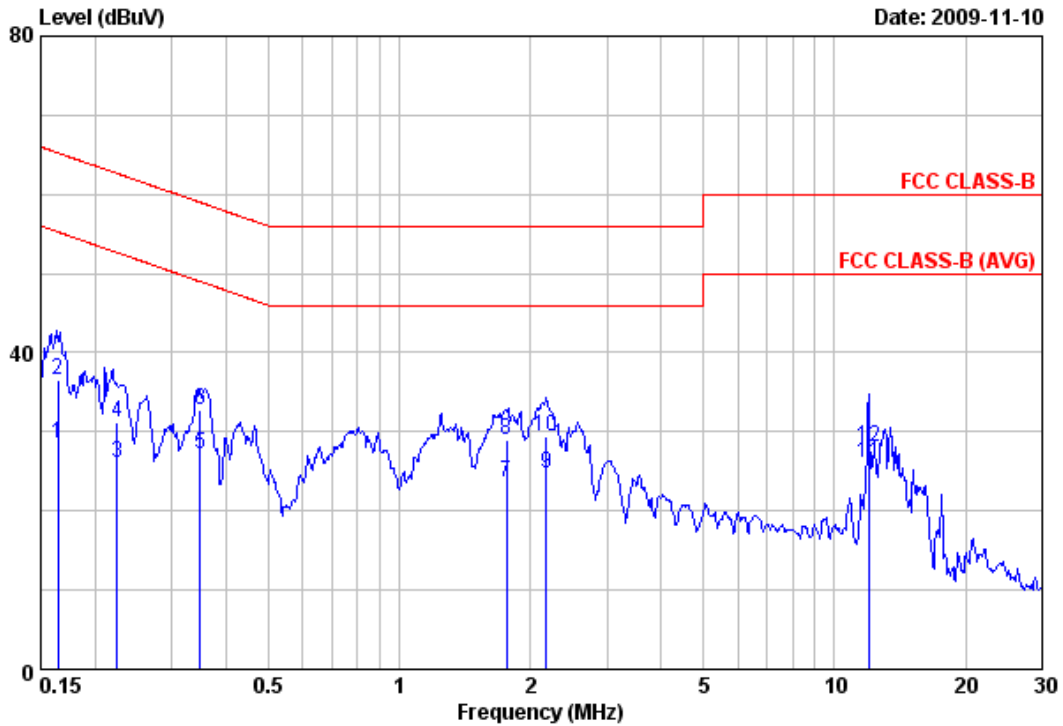

Item	Freq	Read Value	Factor	Result	Limit	Margin	Remark
	MHz	dBuV	dB/m	dBuV/m	dBuV/m	dB	
1	0.16	28.48	0.07	28.55	55.25	-26.70	Average
2	0.16	36.47	0.07	36.54	65.25	-28.71	QP
3	0.22	25.93	0.07	26.00	52.64	-26.64	Average
4	0.22	31.24	0.07	31.31	62.64	-31.33	QP
5	0.35	27.02	0.08	27.10	48.98	-21.88	Average
6	0.35	32.63	0.08	32.71	58.98	-26.27	QP
7	1.77	23.48	0.14	23.62	46.00	-22.38	Average
8	1.77	28.84	0.14	28.98	56.00	-27.02	QP
9	2.17	24.52	0.15	24.67	46.00	-21.33	Average
10	2.17	29.26	0.15	29.41	56.00	-26.59	QP
11	12.00	25.53	0.54	26.07	50.00	-23.93	Average
12	12.00	27.50	0.54	28.04	60.00	-31.96	QP

Notes:

1. Result = Read Value + Factor
2. Factor = LISN Factor + Cable Loss
3. All emission below 1GHz at 802.11b/g mode are all the same,so the 802.11g mode chosen as representative in final test.
4. According to technical experiences,all spurious emission of 802.11g mode at channel 1,6,11 are almost the same below 1GHz,so that the channel 1 was chosen as representative in final test.
5. The data is worse case.



Power	: AC 120V	Pol/Phase	: NEUTRAL
Test Mode 1	: 802.11g (54Mbps), CH1	Temperature	: 25 °C
Memo	: Carrier current off	Humidity	: 72 %

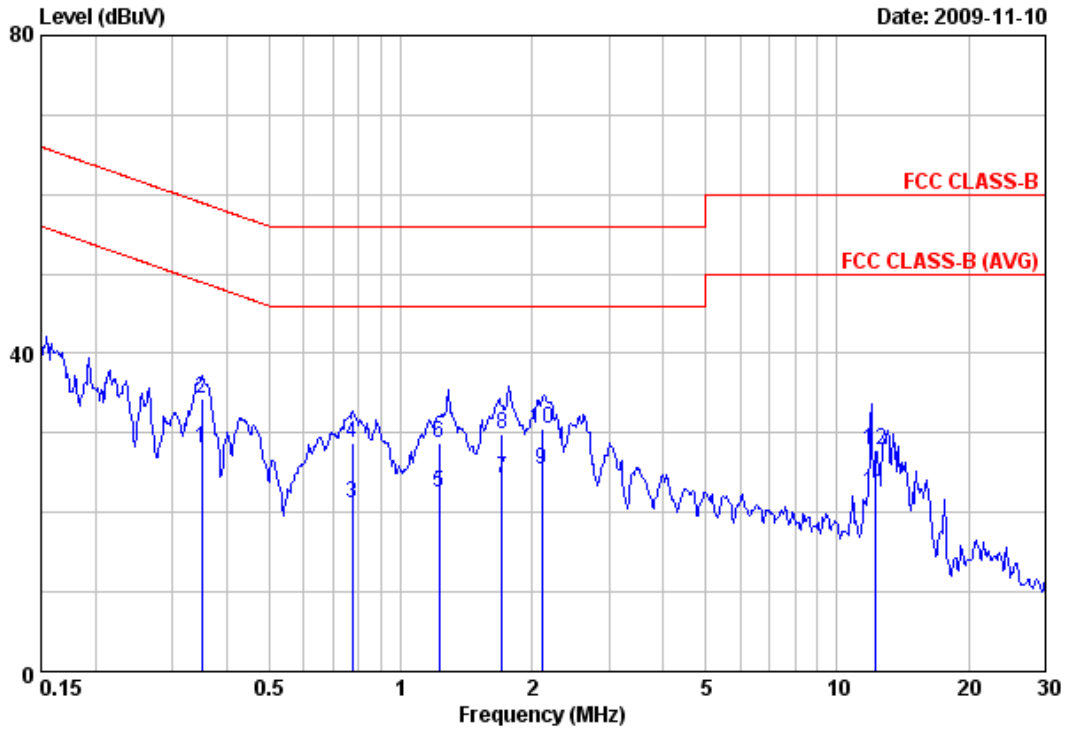

Item	Freq MHz	Read Value dBuV	Factor dB/m	Result dBuV/m	Limit dBuV/m	Margin dB	Remark
1	0.35	28.08	0.08	28.16	48.94	-20.78	Average
2	0.35	34.29	0.08	34.37	58.94	-24.57	QP
3	0.77	21.05	0.09	21.14	46.00	-24.86	Average
4	0.77	28.57	0.09	28.66	56.00	-27.34	QP
5	1.22	22.30	0.11	22.41	46.00	-23.59	Average
6	1.22	28.55	0.11	28.66	56.00	-27.34	QP
7	1.71	24.25	0.12	24.37	46.00	-21.63	Average
8	1.71	29.77	0.12	29.89	56.00	-26.11	QP
9	2.11	25.31	0.12	25.43	46.00	-20.57	Average
10	2.11	30.37	0.12	30.49	56.00	-25.51	QP
11	12.29	22.13	0.44	22.57	50.00	-27.43	Average
12	12.29	27.40	0.44	27.84	60.00	-32.16	QP

Notes:

1. Result = Read Value + Factor
2. Factor = LISN Factor + Cable Loss
3. All emission below 1GHz at 802.11g mode are all the same,so the 802.11g mode chosen as representative in final test.
4. According to technical experiences,all spurious emission of 802.11g mode at channel 1,6,11 are almost the same below 1GHz,so that the channel 1 was chosen as representative in final test.
5. The data is worse case.



Power	: AC 120V	Pol/Phase	: LINE
Test Mode 2	: 802.11n HT20 (130Mbps), CH1	Temperature	: 25 °C
Memo	: Carrier current off	Humidity	: 72 %

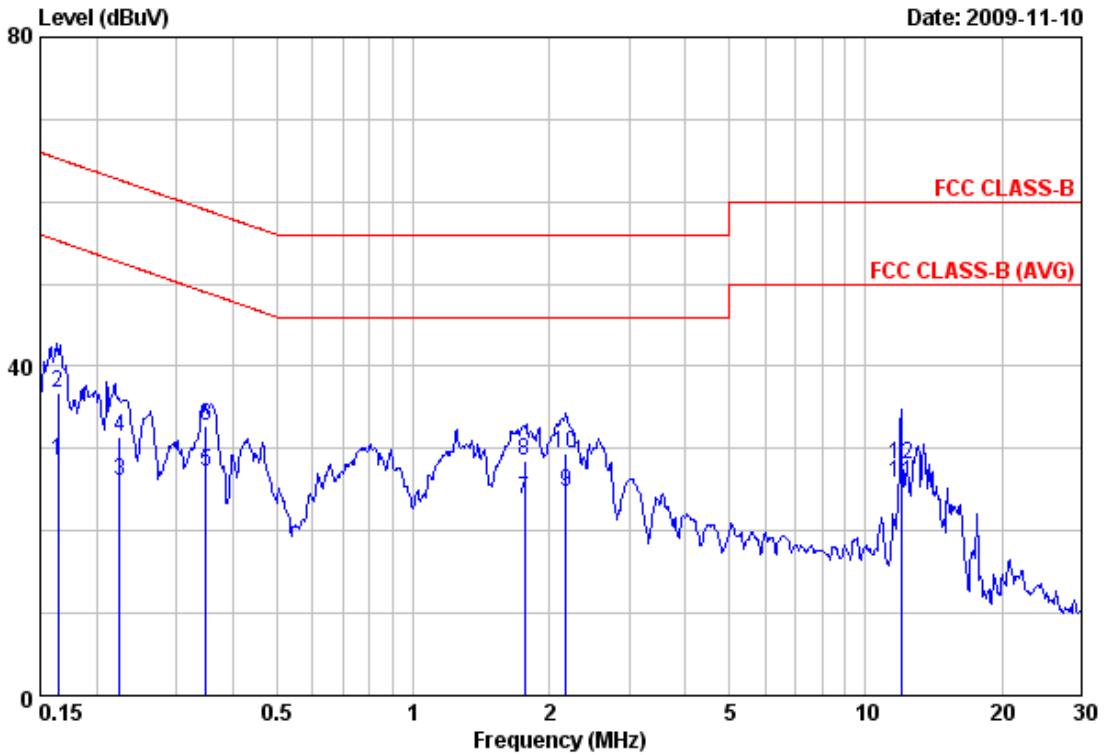

Item	Freq	Read Value	Factor	Result	Limit	Margin	Remark
	MHz	dBuV	dB/m	dBuV/m	dBuV/m	dB	
1	0.16	28.45	0.07	28.52	55.25	-26.73	Average
2	0.16	36.74	0.07	36.81	65.25	-28.44	QP
3	0.22	25.92	0.07	25.99	52.64	-26.65	Average
4	0.22	31.35	0.07	31.42	62.64	-31.22	QP
5	0.35	27.10	0.08	27.18	48.98	-21.80	Average
6	0.35	32.57	0.08	32.65	58.98	-26.33	QP
7	1.77	23.68	0.14	23.82	46.00	-22.18	Average
8	1.77	28.46	0.14	28.60	56.00	-27.40	QP
9	2.17	24.53	0.15	24.68	46.00	-21.32	Average
10	2.17	29.22	0.15	29.37	56.00	-26.63	QP
11	12.00	25.31	0.54	25.85	50.00	-24.15	Average
12	12.00	27.51	0.54	28.05	60.00	-31.95	QP

Notes:

1. Result = Read Value + Factor
2. Factor = LISN Factor + Cable Loss
3. According to technical experiences, all spurious emission of 802.11n mode at channel 1,6,11 are almost the same below 1GHz, so that the channel 1 was chosen as representative in final test.
4. The data is worse case.



Power	: AC 120V	Pol/Phase	: NEUTRAL
Test Mode 2	: 802.11n HT20 (130Mbps), CH1	Temperature	: 25 °C
Memo	: Carrier current off	Humidity	: 72 %

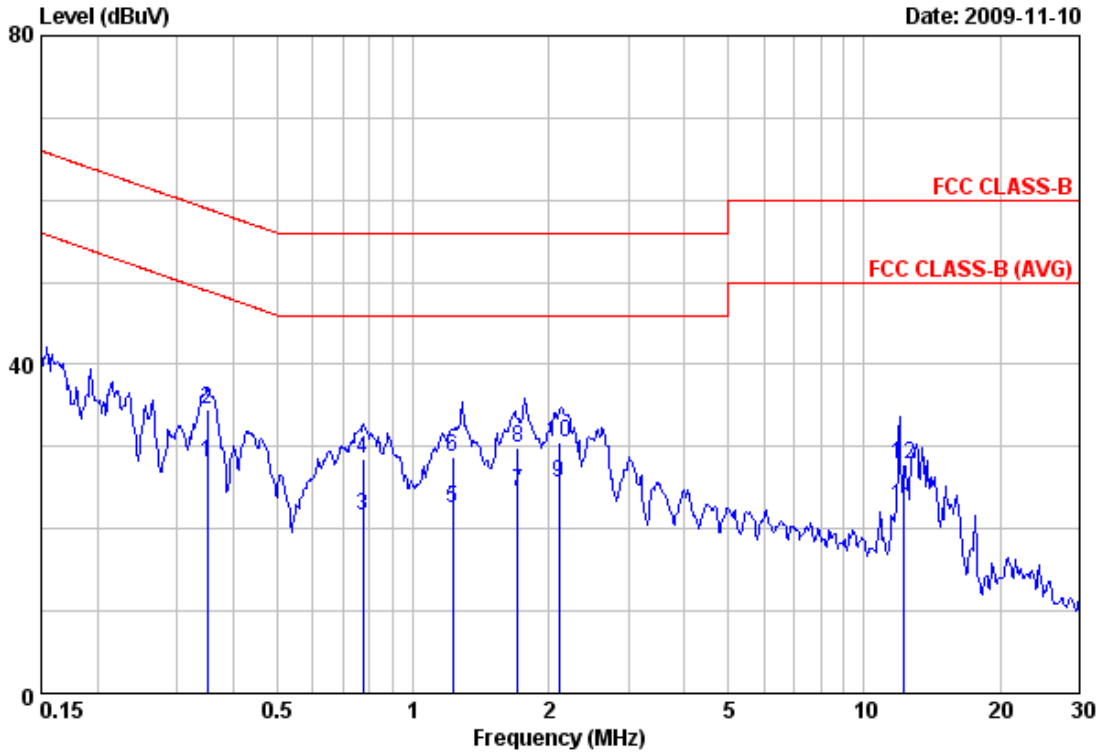

Item	Freq	Read Value	Factor	Result	Limit	Margin	Remark
	MHz	dBuV	dB/m	dBuV/m	dBuV/m	dB	
1	0.35	28.02	0.08	28.10	48.94	-20.84	Average
2	0.35	34.40	0.08	34.48	58.94	-24.46	QP
3	0.77	21.51	0.09	21.60	46.00	-24.40	Average
4	0.77	28.50	0.09	28.59	56.00	-27.41	QP
5	1.22	22.45	0.11	22.56	46.00	-23.44	Average
6	1.22	28.56	0.11	28.67	56.00	-27.33	QP
7	1.71	24.40	0.12	24.52	46.00	-21.48	Average
8	1.71	29.71	0.12	29.83	56.00	-26.17	QP
9	2.11	25.48	0.12	25.60	46.00	-20.40	Average
10	2.11	30.35	0.12	30.47	56.00	-25.53	QP
11	12.29	22.23	0.44	22.67	50.00	-27.33	Average
12	12.29	27.36	0.44	27.80	60.00	-32.20	QP

Notes:

1. Result = Read Value + Factor
2. Factor = LISN Factor + Cable Loss
3. According to technical experiences, all spurious emission of 802.11n mode at channel 1,6,11 are almost the same below 1GHz, so that the channel 1 was chosen as representative in final test.
4. The data is worse case.



Power	: AC 120V	Pol/Phase	: LINE
Test Mode 3	: 802.11n HT40 (270Mbps), CH3	Temperature	: 25 °C
Memo	: Carrier current off	Humidity	: 72 %

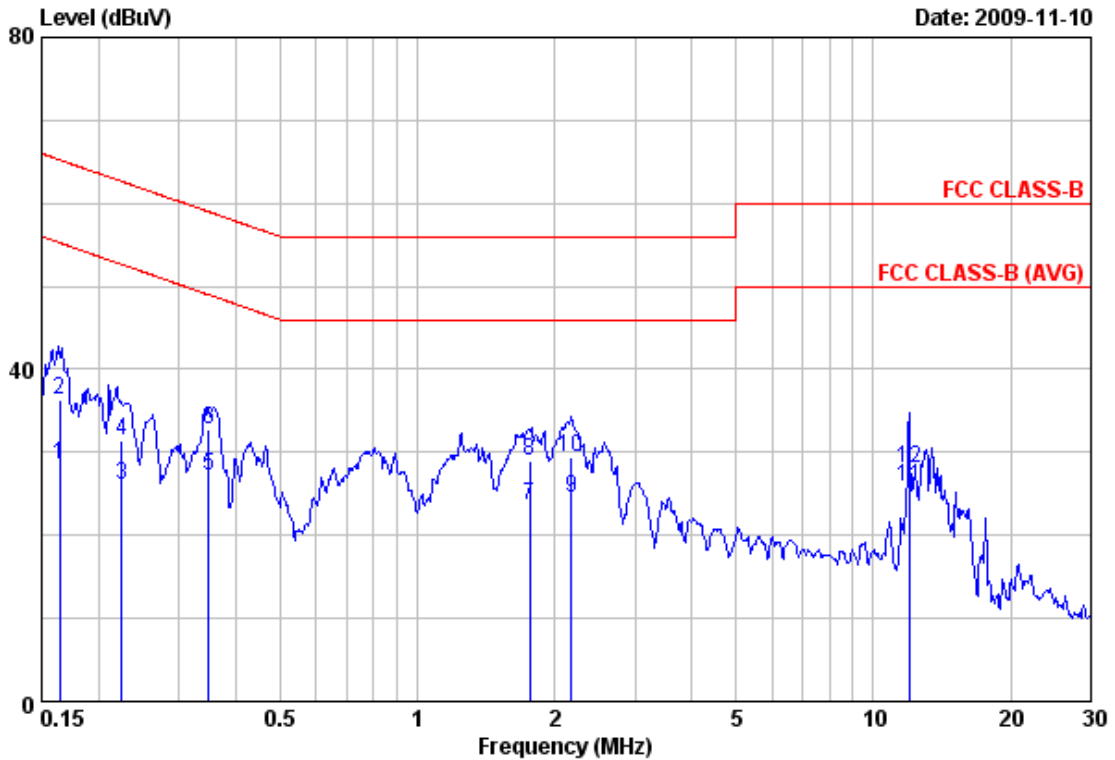

Item	Freq	Read Value	Factor	Result	Limit	Margin	Remark
	MHz	dBuV	dB/m	dBuV/m	dBuV/m	dB	
1	0.16	28.55	0.07	28.62	55.25	-26.63	Average
2	0.16	36.33	0.07	36.40	65.25	-28.85	QP
3	0.22	25.92	0.07	25.99	52.64	-26.65	Average
4	0.22	31.45	0.07	31.52	62.64	-31.12	QP
5	0.35	27.20	0.08	27.28	48.98	-21.70	Average
6	0.35	32.57	0.08	32.65	58.98	-26.33	QP
7	1.77	23.44	0.14	23.58	46.00	-22.42	Average
8	1.77	28.86	0.14	29.00	56.00	-27.00	QP
9	2.17	24.33	0.15	24.48	46.00	-21.52	Average
10	2.17	29.22	0.15	29.37	56.00	-26.63	QP
11	12.00	25.24	0.54	25.78	50.00	-24.22	Average
12	12.00	27.51	0.54	28.05	60.00	-31.95	QP

Notes:

1. Result = Read Value + Factor
2. Factor = LISN Factor + Cable Loss
3. According to technical experiences, all spurious emission of 802.11n mode at channel 3, 6, 9 are almost the same below 1GHz, so that the channel 3 was chosen as representative in final test.
4. The data is worse case.



Power	: AC 120V	Pol/Phase	: NEUTRAL
Test Mode 3	: 802.11n HT40 (270Mbps), CH3	Temperature	: 25 °C
Memo	: Carrier current off	Humidity	: 72 %

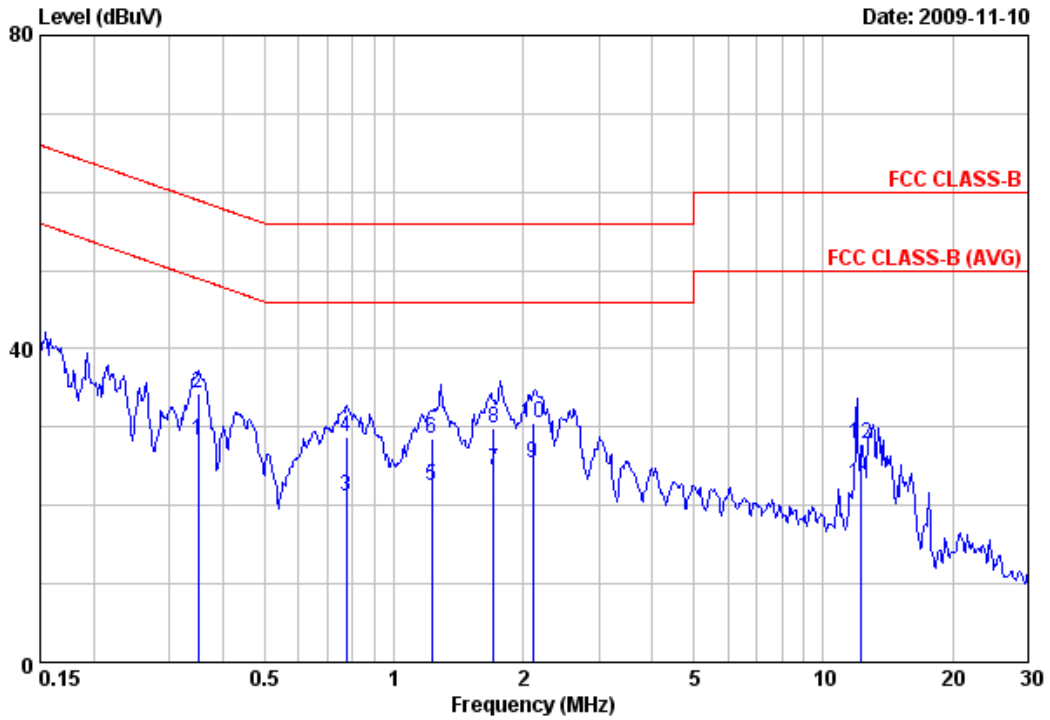

Item	Freq	Read Value	Factor	Result	Limit	Margin	Remark
	MHz	dBuV	dB/m	dBuV/m	dBuV/m	dB	
1	0.35	28.32	0.08	28.40	48.94	-20.54	Average
2	0.35	34.30	0.08	34.38	58.94	-24.56	QP
3	0.77	21.01	0.09	21.10	46.00	-24.90	Average
4	0.77	28.60	0.09	28.69	56.00	-27.31	QP
5	1.22	22.35	0.11	22.46	46.00	-23.54	Average
6	1.22	28.35	0.11	28.46	56.00	-27.54	QP
7	1.71	24.30	0.12	24.42	46.00	-21.58	Average
8	1.71	29.71	0.12	29.83	56.00	-26.17	QP
9	2.11	25.38	0.12	25.50	46.00	-20.50	Average
10	2.11	30.39	0.12	30.51	56.00	-25.49	QP
11	12.29	22.33	0.44	22.77	50.00	-27.23	Average
12	12.29	27.36	0.44	27.80	60.00	-32.20	QP

Notes:

1. Result = Read Value + Factor
2. Factor = LISN Factor + Cable Loss
3. According to technical experiences, all spurious emission of 802.11n mode at channel 3,6,9 are almost the same below 1GHz, so that the channel 3 was chosen as representative in final test.
4. The data is worse case.

Test engineer: Ben



5. Test of Radiated Emission

5.1 Test Limit

Radiated emissions from 30 MHz to 25 GHz were measured according to the methods defines in ANSI C63.4-2003. The EUT was placed, 0.8 meter above the ground plane, as shown in section 5.6.3. The interface cables and equipment positions were varied within limits of reasonable applications to determine the positions producing maximum radiated emissions for unintentional device, according to § 15.109(a), except for Class A digital devices, the field strength of radiated emissions from unintentional radiators at a distance of 3 meters shall not exceed the following values:

Frequency (MHz)	Distance Meters	Radiated (μ V / M)	Radiated (dB μ V / M)
30-88	3	100	40.0
88-216	3	150	43.5
216-960	3	200	46.0
Above 960	3	500	54.0

For unintentional device, according to CISPR PUB.22, for Class B digital devices, the general requirement of field strength of radiated emissions from intentional radiators at a distance of 10 meters shall not exceed the below table.

Frequency (MHz)	Distance Meters	Radiated (dB μ V / M)
30-230	10	30
230-1000	10	37

5.2 Test Procedures

- The EUT was placed on a rotatable table top 0.8 meter above ground.
- The EUT was set 3 meters from the interference receiving antenna which was mounted on the top of a variable height antenna tower.
- The table was rotated 360 degrees to determine the position of the highest radiation.
- The antenna is a broadband antenna and its height is varied between one meter and four meters above ground to find the maximum value of the field strength both horizontal polarization and vertical polarization of the antenna are set to make the measurement.
- For each suspected emission the EUT was arranged to its worst case and then tune the antenna tower (from 1 M to 4 M) and turn table (from 0 degree to 360 degrees) to find the maximum reading.
- Set the test-receiver system to Peak or CISPR quasi-peak Detect Function and specified bandwidth with Maximum Hold Mode.
- If the emission level of the EUT in peak mode was 3 dB lower than the limit specified, then testing will be stopped and peak values of EUT will be reported, otherwise, the emissions which do not have 3 dB margin will be repeated one by one using the quasi-peak method and reported.
- For testing above 1GHz, the emission level of the EUT in peak mode was 20dB lower than average limit (that means the emission level in peak mode also complies with the limit in average mode), then testing will be stopped and peak values of EUT will be reported, otherwise, the emissions will be measured in average mode again and reported.
- “Cone of radiation” has been considered to be 3dB bandwidth of the measurement antenna.



5.3 Typical Test Setup

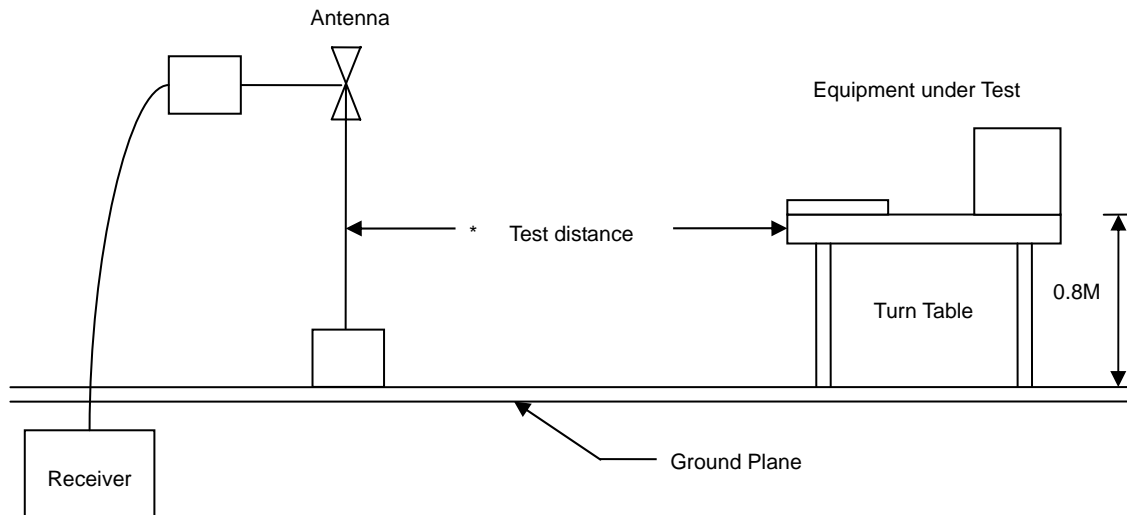

5.4 Measurement Equipment

(below 1GHz)

Instrument/Ancillary	Model No.	Manufacturer	Serial No.	Calibration Date	Valid Date
Bilog Antenna	Schaffner	CBL6112B	2840	2009/05/14	2010/05/13
EMI Receiver	R&S	ESCI	100443	2008/12/19	2009/12/18
Amplifier	Agilent	8447D	2944A10593	2009/05/21	2010/05/20
AC Power Converter	APC	AFC-11005	F103120008	N/A	N/A

(above 1GHz)

Instrument/Ancillary	Model No.	Manufacturer	Serial No.	Calibration Date	Valid Date
Spectrum Analyzer	R&S	FSP40	100047	2010/05/08	2011/05/07
Horn Antenna	EMCO	3115	31589	2010/05/04	2011/05/03
Preamplifier	Agilent	8449B	3008A01954	2010/02/26	2011/02/25



5.5 Test Result and Data

Power	: AC 120V	Pol/Phase	: VERTICAL
Test Mode 1	: 802.11g (54Mbps), CH1	Temperature	: 25 °C
Memo	: Antenna 1	Humidity	: 59 %

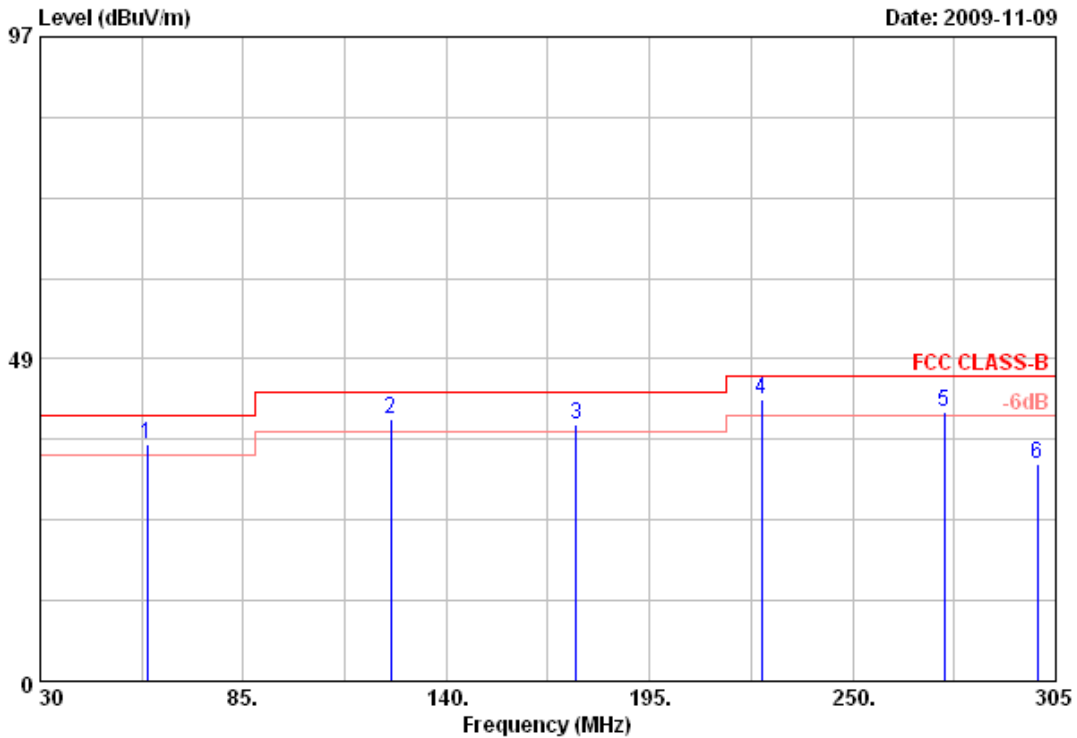

Item	Freq	Read Value	Factor	Result	Limit	Margin	Remark	Ant Pos	Tab Pos
	MHz	dBuV	dB/m	dBuV/m	dBuV/m	dB		cm	Deg
1	58.88	48.21	-12.68	35.53	40.00	-4.47	QP	100	0
2	124.88	48.84	-9.43	39.41	43.50	-4.09	QP	100	0
3	175.20	50.53	-11.89	38.64	43.50	-4.86	QP	100	0
4	225.25	52.94	-10.44	42.50	46.00	-3.50	QP	100	0
5	274.75	53.14	-12.69	40.45	46.00	-5.55	QP	100	0
6	300.05	44.57	-12.01	32.56	46.00	-13.44	Peak	100	0

Notes:

1. Result = Read Value + Factor
2. Factor = Antenna Factor + Cable Loss - Amplifier
3. The resolution bandwidth of test receiver/spectrum analyzer is 120KHz and video bandwidth is 300kHz for Peak detection and Quasi-peak detection at frequency below 1GHz.
4. All emission below 1GHz at 802.11b/g mode are all the same,so the 802.11g mode chosen as representative in final test.
5. According to technical experiences,all spurious emission of 802.11g mode at channel 1,6,11 are almost the same below 1GHz,so that the channel 1 was chosen as representative in final test.
6. The data is worse case.



Power	: AC 120V	Pol/Phase	: VERTICAL
Test Mode 1	: 802.11g (54Mbps), CH1	Temperature	: 25 °C
Memo	: Antenna 1	Humidity	: 59 %

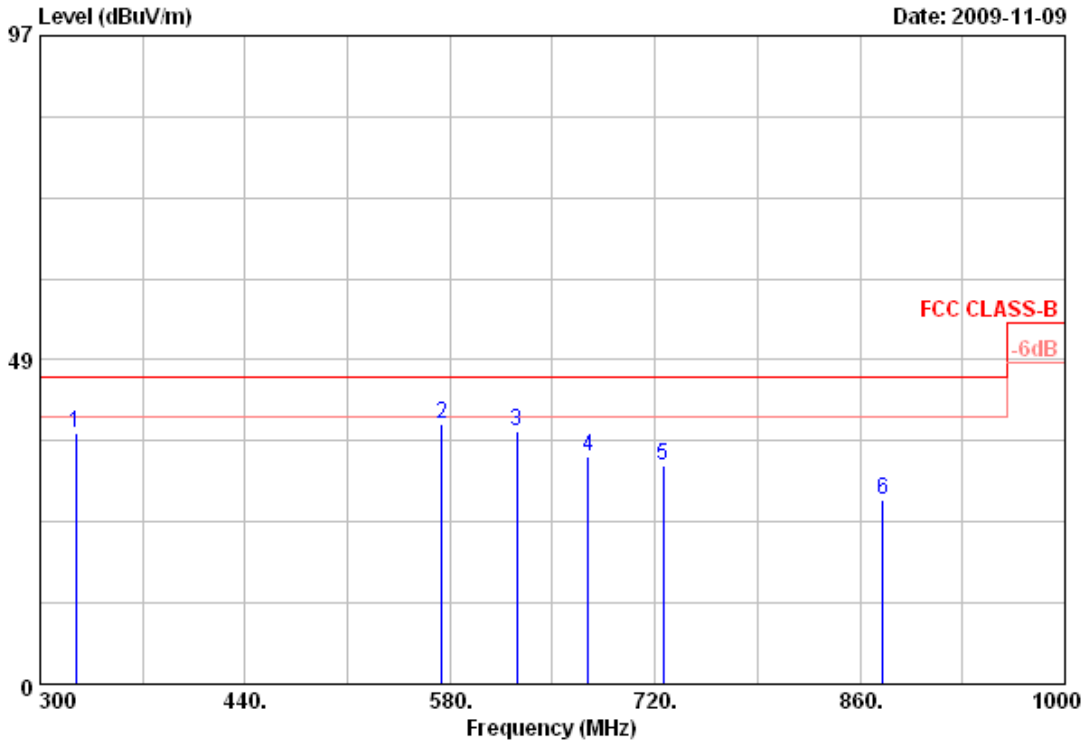

Item	Freq	Read Value	Factor	Result	Limit	Margin	Remark	Ant Pos	Tab Pos
	MHz	dBuV	dB/m	dBuV/m	dBuV/m	dB		cm	Deg
1	324.50	47.28	-9.78	37.50	46.00	-8.50	Peak	100	0
2	574.40	42.28	-3.43	38.85	46.00	-7.15	Peak	100	0
3	625.50	44.28	-6.52	37.76	46.00	-8.24	Peak	100	0
4	674.50	39.19	-5.15	34.04	46.00	-11.96	Peak	100	0
5	725.60	33.65	-1.09	32.56	46.00	-13.44	Peak	100	0
6	875.40	26.81	0.75	27.56	46.00	-18.44	Peak	100	0

Notes:

1. Result = Read Value + Factor
2. Factor = Antenna Factor + Cable Loss - Amplifier
3. The resolution bandwidth of test receiver/spectrum analyzer is 120KHz and video bandwidth is 300KHz for Peak detection and Quasi-peak detection at frequency below 1GHz.
4. All emission below 1GHz at 802.11b/g mode are all the same,so the 802.11g mode chosen as representative in final test.
5. According to technical experiences,all spurious emission of 802.11g mode at channel 1,6,11 are almost the same below 1GHz,so that the channel 1 was chosen as representative in final test.
6. The data is worse case.



Power	: AC 120V	Pol/Phase	: HORIZONTAL
Test Mode 1	: 802.11g (54Mbps), CH1	Temperature	: 25 °C
Memo	: Antenna 1	Humidity	: 59 %

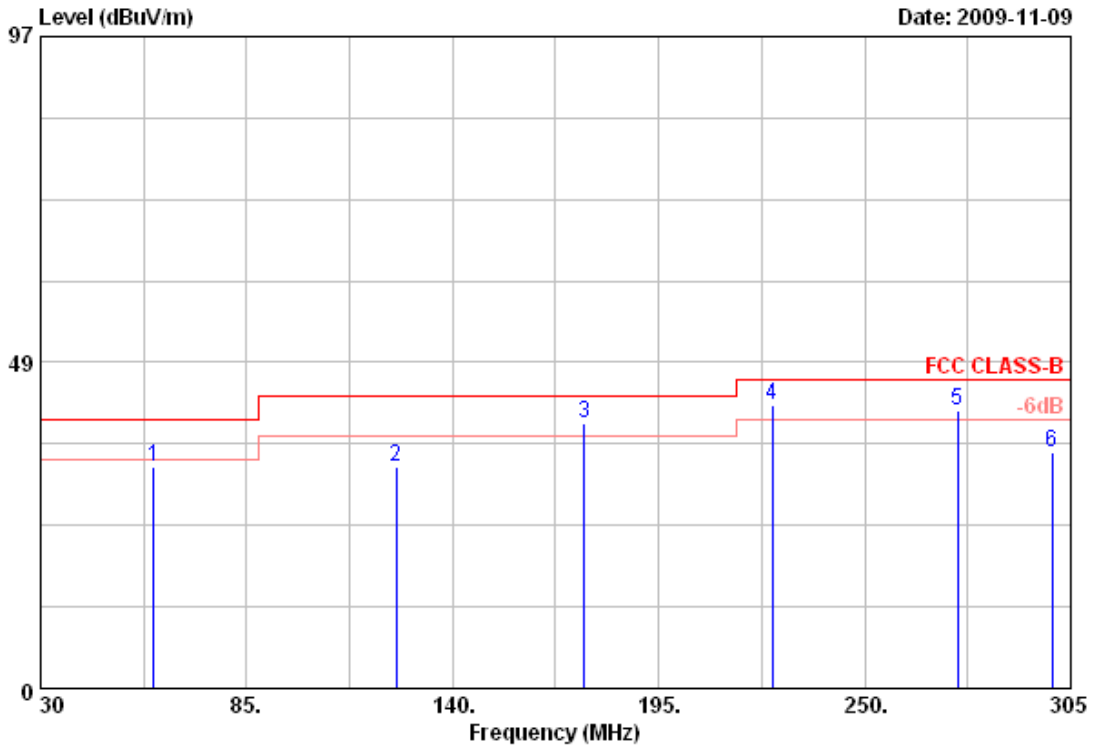

Item	Freq	Read Value	Factor	Result	Limit	Margin	Remark	Ant Pos	Tab Pos
	MHz	dBuV	dB/m	dBuV/m	dBuV/m	dB		cm	Deg
1	60.25	51.81	-18.87	32.94	40.00	-7.06	Peak	100	0
2	124.88	49.70	-16.67	33.03	43.50	-10.47	Peak	100	0
3	175.20	56.70	-17.16	39.54	43.50	-3.96	QP	100	0
4	225.25	57.49	-15.23	42.26	46.00	-3.74	QP	100	0
5	274.75	54.50	-13.18	41.32	46.00	-4.68	Peak	100	0
6	300.05	48.03	-13.01	35.02	46.00	-10.98	Peak	100	0

Notes:

1. Result = Read Value + Factor
2. Factor = Antenna Factor + Cable Loss - Amplifier
3. The resolution bandwidth of test receiver/spectrum analyzer is 120KHz and video bandwidth is 300kHz for Peak detection and Quasi-peak detection at frequency below 1GHz.
4. All emission below 1GHz at 802.11b/g mode are all the same,so the 802.11g mode chosen as representative in final test.
5. According to technical experiences,all spurious emission of 802.11g mode at channel 1,6,11 are almost the same below 1GHz,so that the channel 1 was chosen as representative in final test.
6. The data is worse case.



Power	: AC 120V	Pol/Phase	: HORIZONTAL
Test Mode 1	: 802.11g (54Mbps), CH1	Temperature	: 25 °C
Memo	: Antenna 1	Humidity	: 59 %

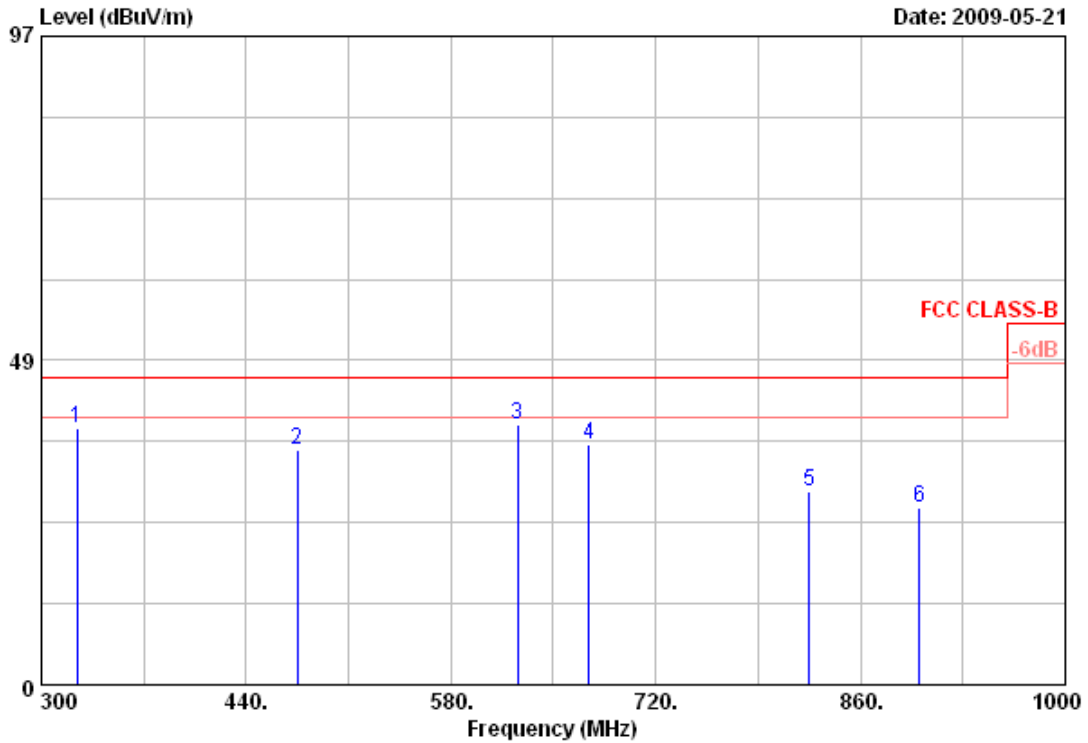

Item	Freq	Read Value	Factor	Result	Limit	Margin	Remark	Ant Pos	Tab Pos
	MHz	dBuV	dB/m	dBuV/m	dBuV/m	dB		cm	Deg
1	324.50	50.32	-11.95	38.37	46.00	-7.63	Peak	100	0
2	475.00	40.48	-5.42	35.06	46.00	-10.94	Peak	100	0
3	625.50	40.49	-1.45	39.04	46.00	-6.96	Peak	100	0
4	674.50	39.69	-3.71	35.98	46.00	-10.02	Peak	100	0
5	825.00	27.70	1.34	29.04	46.00	-16.96	Peak	100	0
6	900.60	25.02	1.54	26.56	46.00	-19.44	Peak	100	0

Notes:

1. Result = Read Value + Factor
2. Factor = Antenna Factor + Cable Loss - Amplifier
3. The resolution bandwidth of test receiver/spectrum analyzer is 120KHz and video bandwidth is 300KHz for Peak detection and Quasi-peak detection at frequency below 1GHz.
4. All emission below 1GHz at 802.11g mode are all the same,so the 802.11g mode chosen as representative in final test.
5. According to technical experiences,all spurious emission of 802.11g mode at channel 1,6,11 are almost the same below 1GHz,so that the channel 1 was chosen as representative in final test.
6. The data is worse case.



Power	: AC 120V	Pol/Phase	: VERTICAL
Test Mode 1	: 802.11b (11Mbps), CH1	Temperature	: 26 °C
Memo	: Antenna 1	Humidity	: 58 %

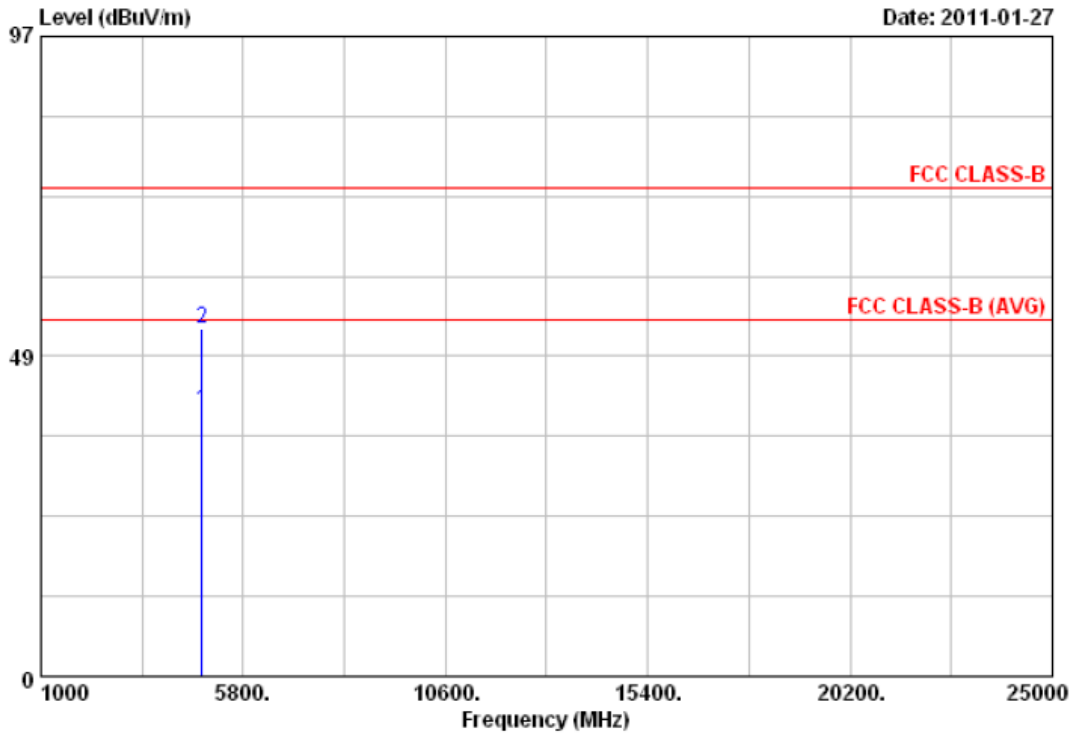

Item	Freq	Read Value	Factor	Result	Limit	Margin	Remark	Ant Pos	Tab Pos
	MHz	dBuV	dB/m	dBuV/m	dBuV/m	dB		cm	Deg
1	4824.00	37.41	2.72	40.13	54.00	-13.87	Average	100	0
2	4824.00	49.99	2.72	52.71	74.00	-21.29	Peak	100	0

Notes:

1. Result = Read Value + Factor
2. Factor = Antenna Factor + Cable Loss - Amplifier
3. The resolution bandwidth of test receiver/spectrum analyzer is 120KHz and video bandwidth is 300kHz for Peak detection and Quasi-peak detection at frequency below 1GHz.
4. The resolution bandwidth of test receiver/spectrum analyzer is 1MHz and video bandwidth is 3MHz for Peak detection at frequency above 1GHz.
5. The resolution bandwidth of test receiver/spectrum analyzer is 1MHz and video bandwidth is 10Hz for Average detection at frequency above 1GHz.
6. The other emissions is too low to be measured.
7. The data is worse case.



Power	: AC 120V	Pol/Phase	: HORIZONTAL
Test Mode 1	: 802.11b (11Mbps), CH1	Temperature	: 26 °C
Memo	: Antenna 1	Humidity	: 58 %

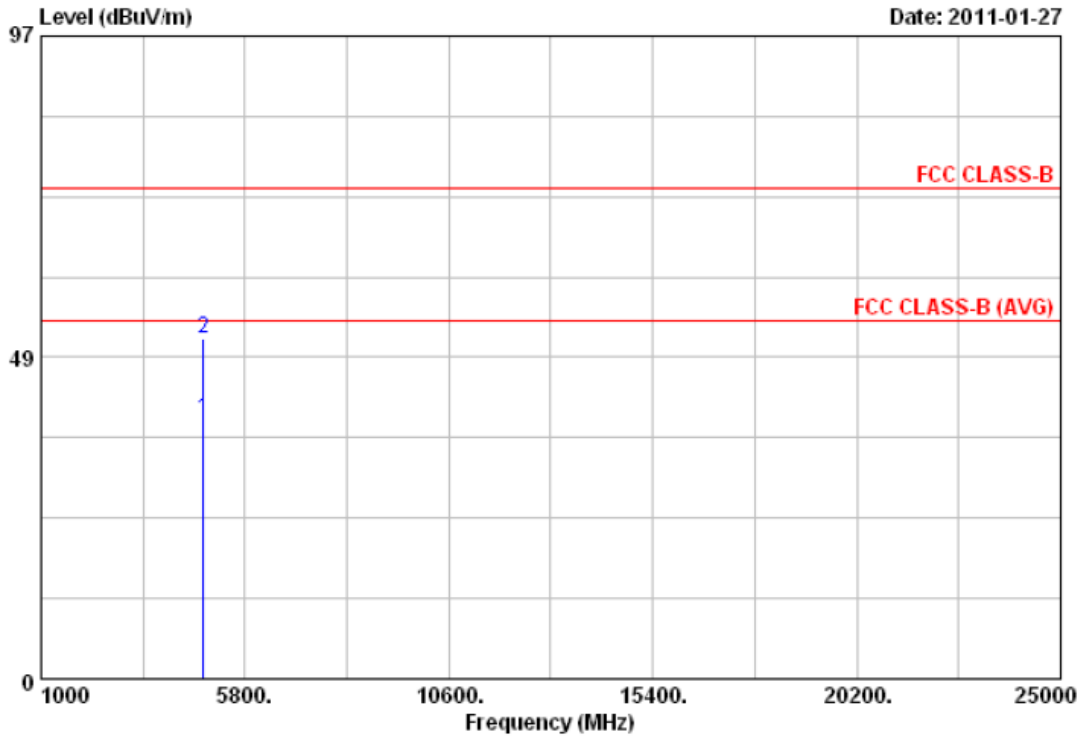

Item	Freq	Read Value	Factor	Result	Limit	Margin	Remark	Ant Pos	Tab Pos
	MHz	dBuV	dB/m	dBuV/m	dBuV/m	dB		cm	Deg
1	4824.40	36.56	2.72	39.28	54.00	-14.72	Average	100	0
2	4824.40	48.66	2.72	51.38	74.00	-22.62	Peak	100	0

Notes:

1. Result = Read Value + Factor
2. Factor = Antenna Factor + Cable Loss - Amplifier
3. The resolution bandwidth of test receiver/spectrum analyzer is 120KHz and video bandwidth is 300kHz for Peak detection and Quasi-peak detection at frequency below 1GHz.
4. The resolution bandwidth of test receiver/spectrum analyzer is 1MHz and video bandwidth is 3MHz for Peak detection at frequency above 1GHz.
5. The resolution bandwidth of test receiver/spectrum analyzer is 1MHz and video bandwidth is 10Hz for Average detection at frequency above 1GHz.
6. The other emissions is too low to be measured.
7. The data is worse case.



Power	: AC 120V	Pol/Phase	: VERTICAL
Test Mode 1	: 802.11b (11Mbps), CH6	Temperature	: 26 °C
Memo	: Antenna 1	Humidity	: 58 %

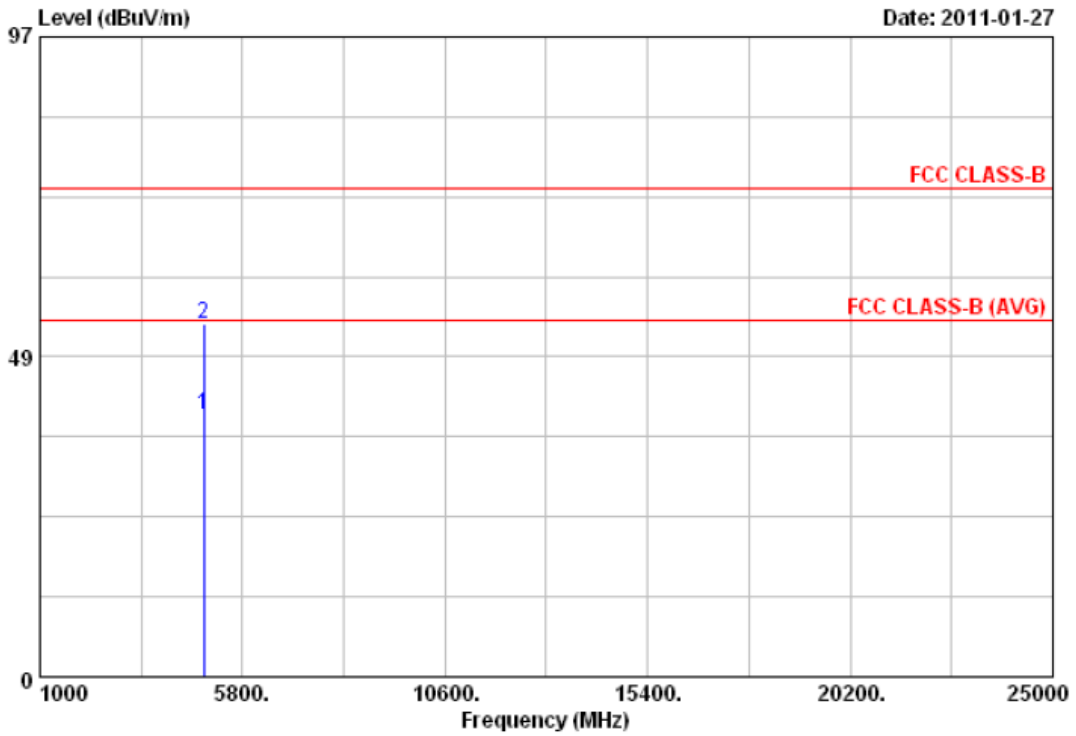

Item	Freq	Read Value	Factor	Result	Limit	Margin	Remark	Ant Pos	Tab Pos
	MHz	dBuV	dB/m	dBuV/m	dBuV/m	dB		cm	Deg
1	4874.00	36.95	2.87	39.82	54.00	-14.18	Average	100	0
2	4874.00	50.56	2.87	53.43	74.00	-20.57	Peak	100	0

Notes:

1. Result = Read Value + Factor
2. Factor = Antenna Factor + Cable Loss - Amplifier
3. The resolution bandwidth of test receiver/spectrum analyzer is 120KHz and video bandwidth is 300kHz for Peak detection and Quasi-peak detection at frequency below 1GHz.
4. The resolution bandwidth of test receiver/spectrum analyzer is 1MHz and video bandwidth is 3MHz for Peak detection at frequency above 1GHz.
5. The resolution bandwidth of test receiver/spectrum analyzer is 1MHz and video bandwidth is 10Hz for Average detection at frequency above 1GHz.
6. The other emissions is too low to be measured.
7. The data is worse case.



Power	: AC 120V	Pol/Phase	: HORIZONTAL
Test Mode 1	: 802.11b (11Mbps), CH6	Temperature	: 26 °C
Memo	: Antenna 1	Humidity	: 58 %

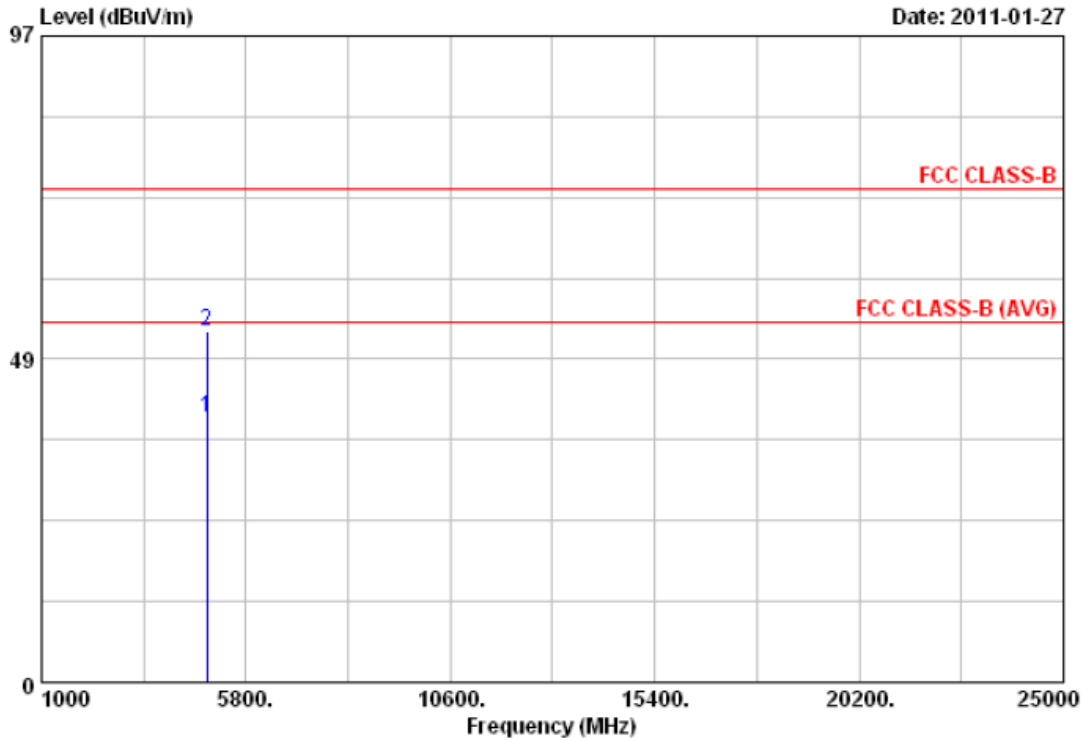

Item	Freq	Read Value	Factor	Result	Limit	Margin	Remark	Ant Pos	Tab Pos
	MHz	dBuV	dB/m	dBuV/m	dBuV/m	dB		cm	Deg
1	4874.00	36.76	2.87	39.63	54.00	-14.37	Average	100	0
2	4874.00	49.85	2.87	52.72	74.00	-21.28	Peak	100	0

Notes:

1. Result = Read Value + Factor
2. Factor = Antenna Factor + Cable Loss - Amplifier
3. The resolution bandwidth of test receiver/spectrum analyzer is 120KHz and video bandwidth is 300kHz for Peak detection and Quasi-peak detection at frequency below 1GHz.
4. The resolution bandwidth of test receiver/spectrum analyzer is 1MHz and video bandwidth is 3MHz for Peak detection at frequency above 1GHz.
5. The resolution bandwidth of test receiver/spectrum analyzer is 1MHz and video bandwidth is 10Hz for Average detection at frequency above 1GHz.
6. The other emissions is too low to be measured.
7. The data is worse case.



Power	: AC 120V	Pol/Phase	: VERTICAL
Test Mode 1	: 802.11b (11Mbps), CH11	Temperature	: 26 °C
Memo	: Antenna 1	Humidity	: 58 %

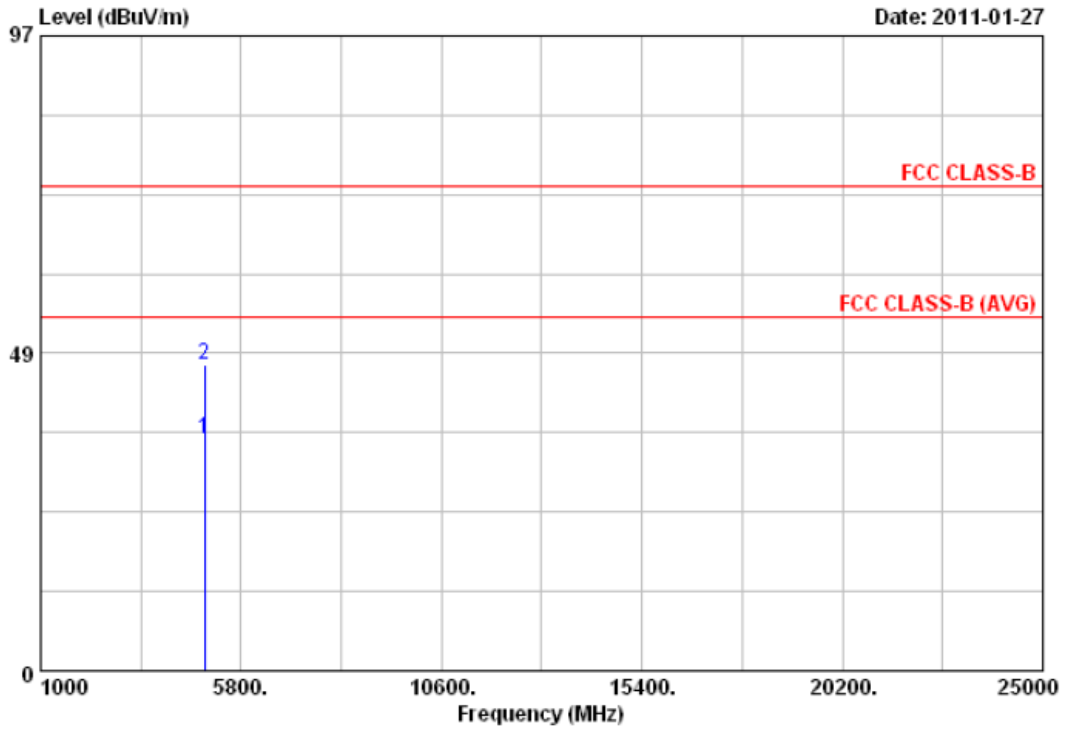

Item	Freq	Read Value	Factor	Result	Limit	Margin	Remark	Ant Pos	Tab Pos
	MHz	dBuV	dB/m	dBuV/m	dBuV/m	dB		cm	Deg
1	4924.00	32.43	3.01	35.44	54.00	-18.56	Average	100	0
2	4924.00	43.62	3.01	46.63	74.00	-27.37	Peak	100	0

Notes:

1. Result = Read Value + Factor
2. Factor = Antenna Factor + Cable Loss - Amplifier
3. The resolution bandwidth of test receiver/spectrum analyzer is 120KHz and video bandwidth is 300KHz for Peak detection and Quasi-peak detection at frequency below 1GHz.
4. The resolution bandwidth of test receiver/spectrum analyzer is 1MHz and video bandwidth is 3MHz for Peak detection at frequency above 1GHz.
5. The resolution bandwidth of test receiver/spectrum analyzer is 1MHz and video bandwidth is 10Hz for Average detection at frequency above 1GHz.
6. The other emissions is too low to be measured.
7. The data is worse case.



Power	: AC 120V	Pol/Phase	: HORIZONTAL
Test Mode 1	: 802.11b (11Mbps), CH11	Temperature	: 26 °C
Memo	: Antenna 1	Humidity	: 58 %

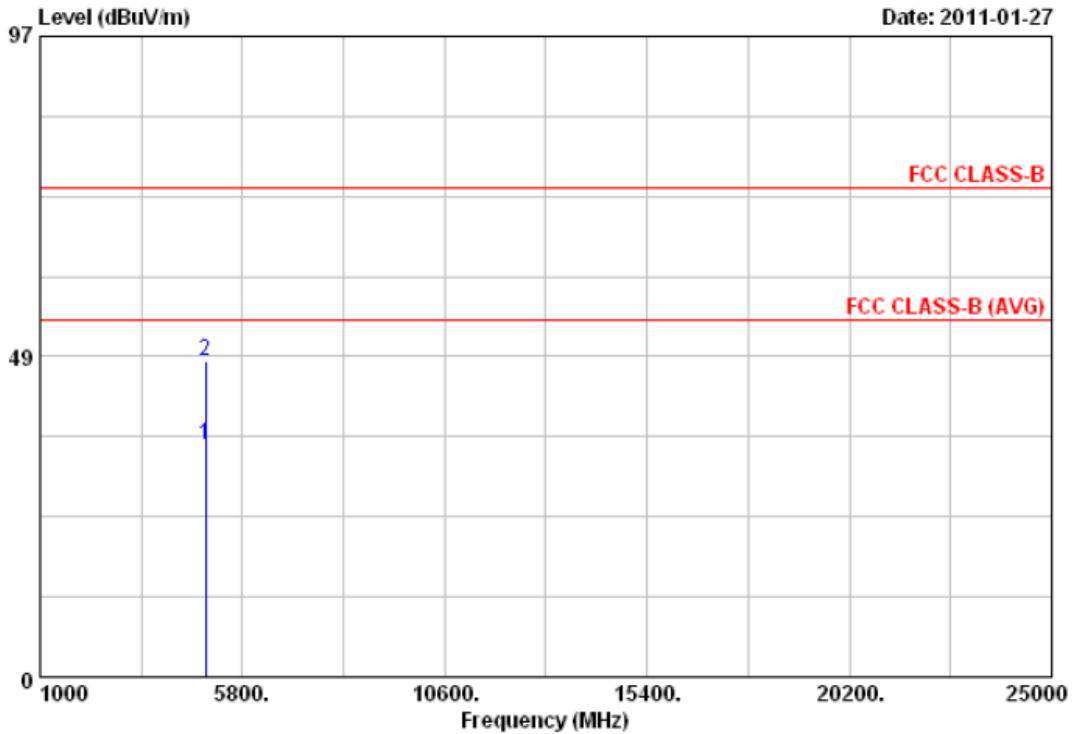

Item	Freq	Read Value	Factor	Result	Limit	Margin	Remark	Ant Pos	Tab Pos
	MHz	dBuV	dB/m	dBuV/m	dBuV/m	dB		cm	Deg
1	4924.00	32.03	3.01	35.04	54.00	-18.96	Average	100	0
2	4924.00	44.92	3.01	47.93	74.00	-26.07	Peak	100	0

Notes:

1. Result = Read Value + Factor
2. Factor = Antenna Factor + Cable Loss - Amplifier
3. The resolution bandwidth of test receiver/spectrum analyzer is 120KHz and video bandwidth is 300kHz for Peak detection and Quasi-peak detection at frequency below 1GHz.
4. The resolution bandwidth of test receiver/spectrum analyzer is 1MHz and video bandwidth is 3MHz for Peak detection at frequency above 1GHz.
5. The resolution bandwidth of test receiver/spectrum analyzer is 1MHz and video bandwidth is 10Hz for Average detection at frequency above 1GHz.
6. The other emissions is too low to be measured.
7. The data is worse case.



Power	: AC 120V	Pol/Phase	: VERTICAL
Test Mode 1	: 802.11g (54Mbps), CH1	Temperature	: 26 °C
Memo	: Antenna 1	Humidity	: 58 %

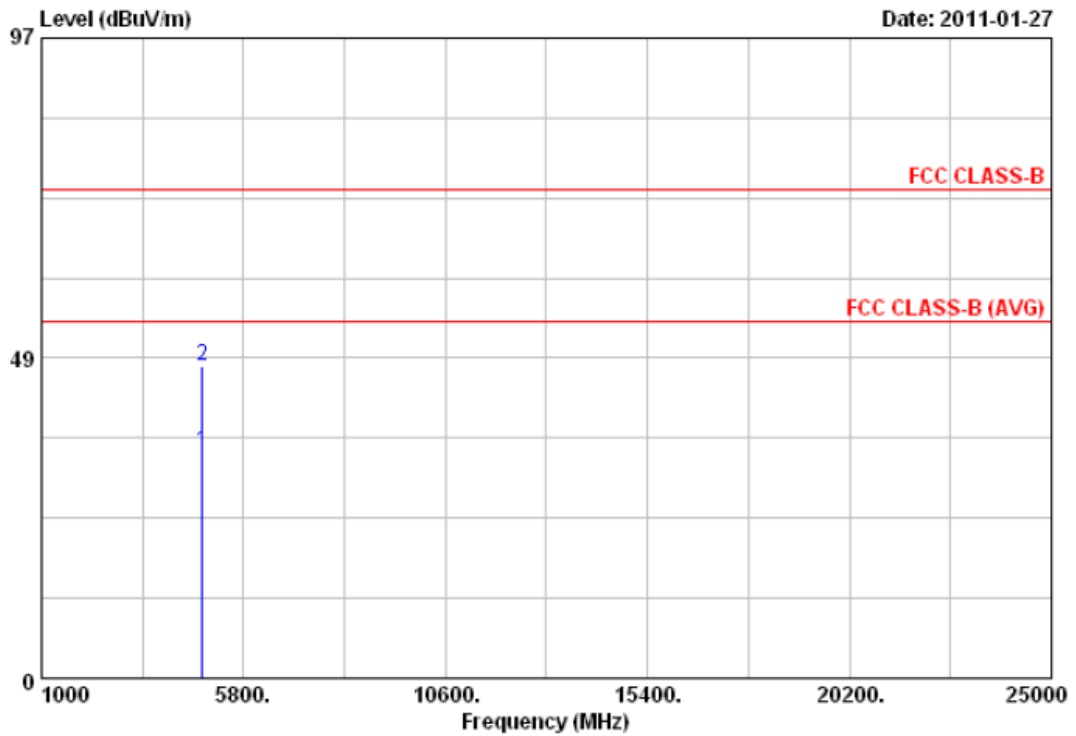

Item	Freq	Read Value	Factor	Result	Limit	Margin	Remark	Ant Pos	Tab Pos
	MHz	dBuV	dB/m	dBuV/m	dBuV/m	dB		cm	Deg
1	4824.00	31.62	2.72	34.34	54.00	-19.66	Average	100	0
2	4824.00	44.63	2.72	47.35	74.00	-26.65	Peak	100	0

Notes:

1. Result = Read Value + Factor
2. Factor = Antenna Factor + Cable Loss - Amplifier
3. The resolution bandwidth of test receiver/spectrum analyzer is 120KHz and video bandwidth is 300KHz for Peak detection and Quasi-peak detection at frequency below 1GHz.
4. The resolution bandwidth of test receiver/spectrum analyzer is 1MHz and video bandwidth is 3MHz for Peak detection at frequency above 1GHz.
5. The resolution bandwidth of test receiver/spectrum analyzer is 1MHz and video bandwidth is 10Hz for Average detection at frequency above 1GHz.
6. The other emissions is too low to be measured.
7. The data is worse case.



Power	: AC 120V	Pol/Phase	: HORIZONTAL
Test Mode 1	: 802.11g (54Mbps), CH1	Temperature	: 26 °C
Memo	: Antenna 1	Humidity	: 58 %

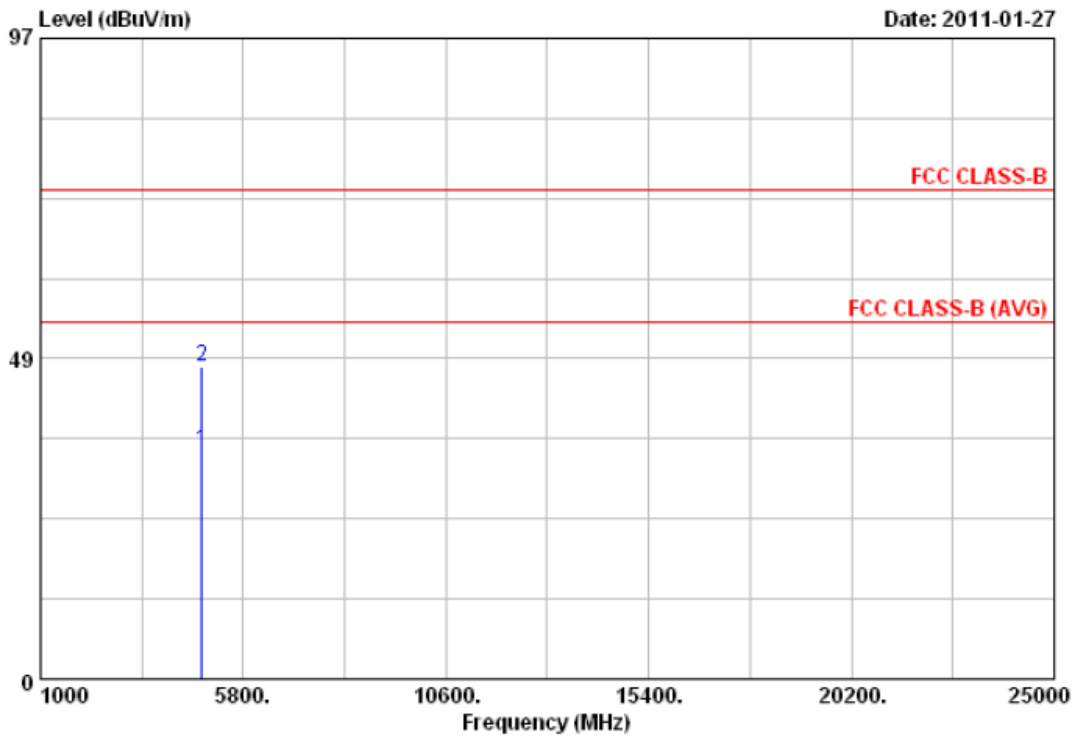

Item	Freq MHz	Read Value		Factor dB/m	Result dBUV/m	Limit dBUV/m	Margin dB	Remark	Ant	Tab
		dBuV							cm	Deg
1	4824.00	31.87		2.72	34.59	54.00	-19.41	Average	100	0
2	4824.00	44.57		2.72	47.29	74.00	-26.71	Peak	100	0

Notes:

1. Result = Read Value + Factor
2. Factor = Antenna Factor + Cable Loss - Amplifier
3. The resolution bandwidth of test receiver/spectrum analyzer is 120KHz and video bandwidth is 300kHz for Peak detection and Quasi-peak detection at frequency below 1GHz.
4. The resolution bandwidth of test receiver/spectrum analyzer is 1MHz and video bandwidth is 3MHz for Peak detection at frequency above 1GHz.
5. The resolution bandwidth of test receiver/spectrum analyzer is 1MHz and video bandwidth is 10Hz for Average detection at frequency above 1GHz.
6. The other emissions is too low to be measured.
7. The data is worse case.



Power	: AC 120V	Pol/Phase	: VERTICAL
Test Mode 1	: 802.11g (54Mbps), CH6	Temperature	: 26 °C
Memo	: Antenna 1	Humidity	: 58 %

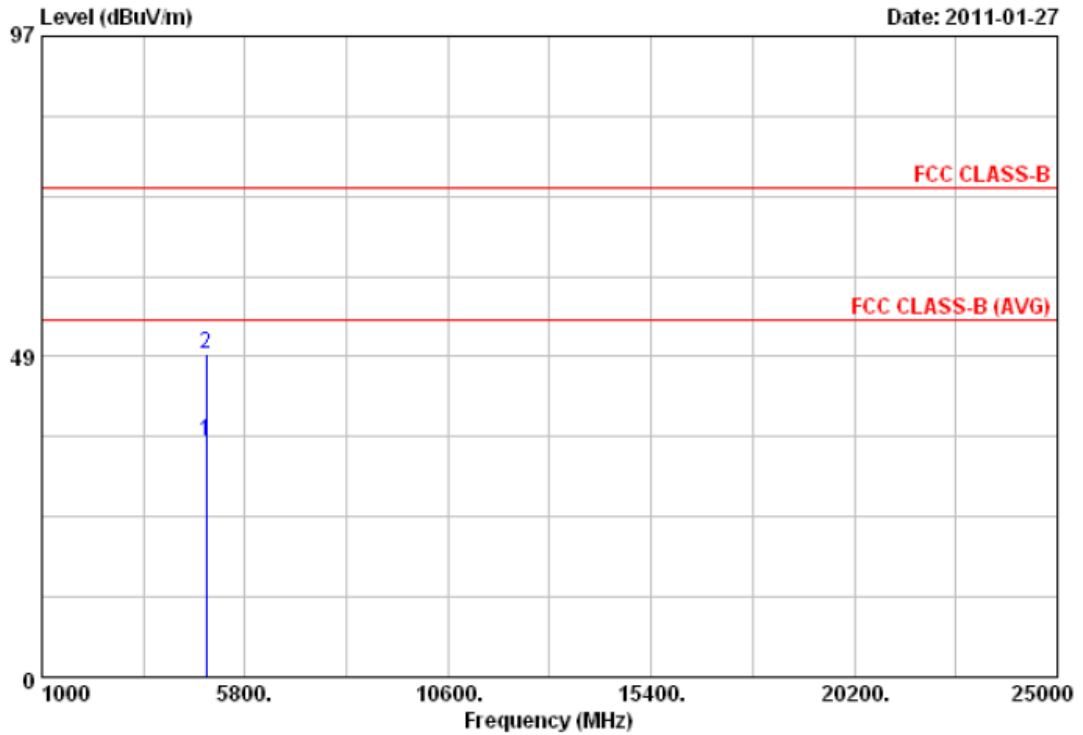

Item	Freq	Read Value	Factor	Result	Limit	Margin	Remark	Ant Pos	Tab Pos
	MHz	dBuV	dB/m	dBuV/m	dBuV/m	dB		cm	Deg
1	4874.00	32.85	2.87	35.72	54.00	-18.28	Average	100	0
2	4874.00	45.93	2.87	48.80	74.00	-25.20	Peak	100	0

Notes:

1. Result = Read Value + Factor
2. Factor = Antenna Factor + Cable Loss - Amplifier
3. The resolution bandwidth of test receiver/spectrum analyzer is 120KHz and video bandwidth is 300kHz for Peak detection and Quasi-peak detection at frequency below 1GHz.
4. The resolution bandwidth of test receiver/spectrum analyzer is 1MHz and video bandwidth is 3MHz for Peak detection at frequency above 1GHz.
5. The resolution bandwidth of test receiver/spectrum analyzer is 1MHz and video bandwidth is 10Hz for Average detection at frequency above 1GHz.
6. The other emissions is too low to be measured.
7. The data is worse case.



Power	: AC 120V	Pol/Phase	: HORIZONTAL
Test Mode 1	: 802.11g (54Mbps), CH6	Temperature	: 26 °C
Memo	: Antenna 1	Humidity	: 58 %

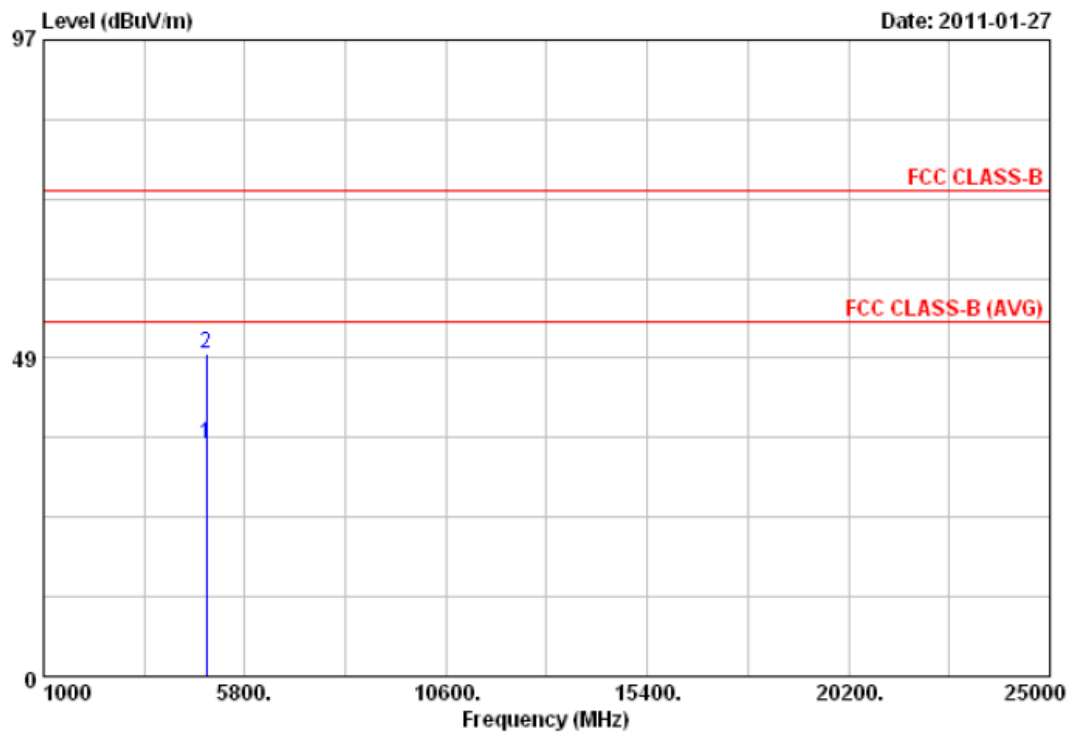

Item	Freq	Read Value	Factor	Result	Limit	Margin	Remark	Ant Pos	Tab Pos
	MHz	dBuV	dB/m	dBuV/m	dBuV/m	dB		cm	Deg
1	4874.00	32.66	2.87	35.53	54.00	-18.47	Average	100	0
2	4874.00	46.17	2.87	49.04	74.00	-24.96	Peak	100	0

Notes:

1. Result = Read Value + Factor
2. Factor = Antenna Factor + Cable Loss - Amplifier
3. The resolution bandwidth of test receiver/spectrum analyzer is 120KHz and video bandwidth is 300kHz for Peak detection and Quasi-peak detection at frequency below 1GHz.
4. The resolution bandwidth of test receiver/spectrum analyzer is 1MHz and video bandwidth is 3MHz for Peak detection at frequency above 1GHz.
5. The resolution bandwidth of test receiver/spectrum analyzer is 1MHz and video bandwidth is 10Hz for Average detection at frequency above 1GHz.
6. The other emissions is too low to be measured.
7. The data is worse case.



Power	: AC 120V	Pol/Phase	: VERTICAL
Test Mode 1	: 802.11g (54Mbps), CH11	Temperature	: 26 °C
Memo	: Antenna 1	Humidity	: 58 %

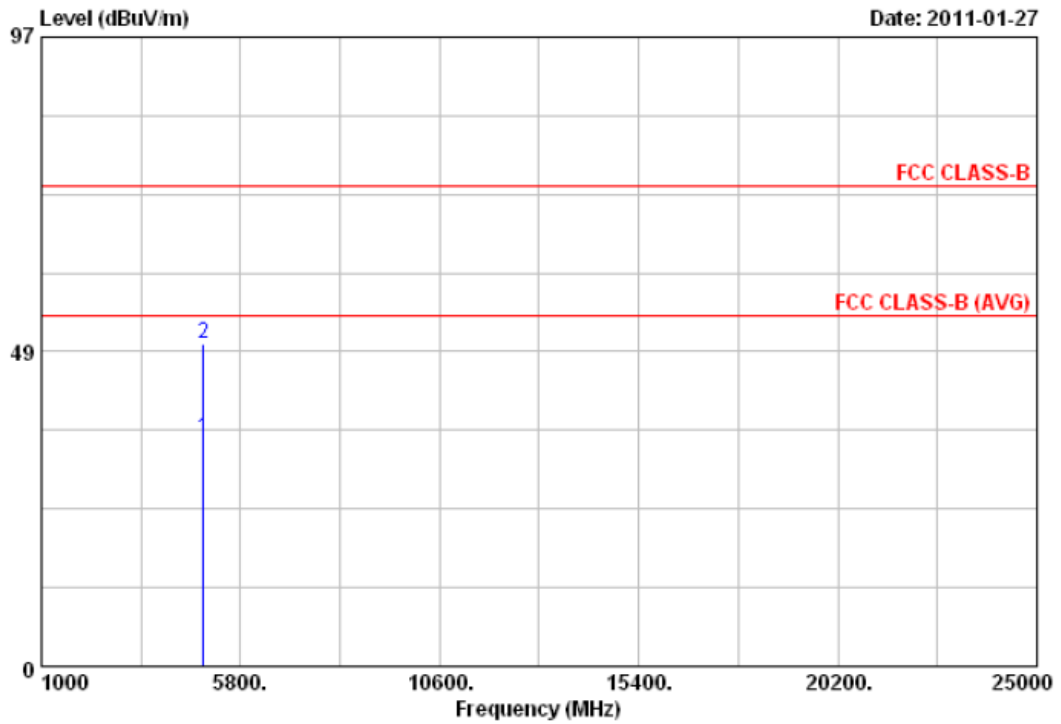

Item	Freq	Read Value	Factor	Result	Limit	Margin	Remark	Ant Pos	Tab Pos
	MHz	dBuV	dB/m	dBuV/m	dBuV/m	dB		cm	Deg
1	4912.00	32.07	2.97	35.04	54.00	-18.96	Average	100	0
2	4912.00	46.63	2.97	49.60	74.00	-24.40	Peak	100	0

Notes:

1. Result = Read Value + Factor
2. Factor = Antenna Factor + Cable Loss - Amplifier
3. The resolution bandwidth of test receiver/spectrum analyzer is 120KHz and video bandwidth is 300kHz for Peak detection and Quasi-peak detection at frequency below 1GHz.
4. The resolution bandwidth of test receiver/spectrum analyzer is 1MHz and video bandwidth is 3MHz for Peak detection at frequency above 1GHz.
5. The resolution bandwidth of test receiver/spectrum analyzer is 1MHz and video bandwidth is 10Hz for Average detection at frequency above 1GHz.
6. The other emissions is too low to be measured.
7. The data is worse case.



Power	: AC 120V	Pol/Phase	: HORIZONTAL
Test Mode 1	: 802.11g (54Mbps), CH11	Temperature	: 26 °C
Memo	: Antenna 1	Humidity	: 58 %

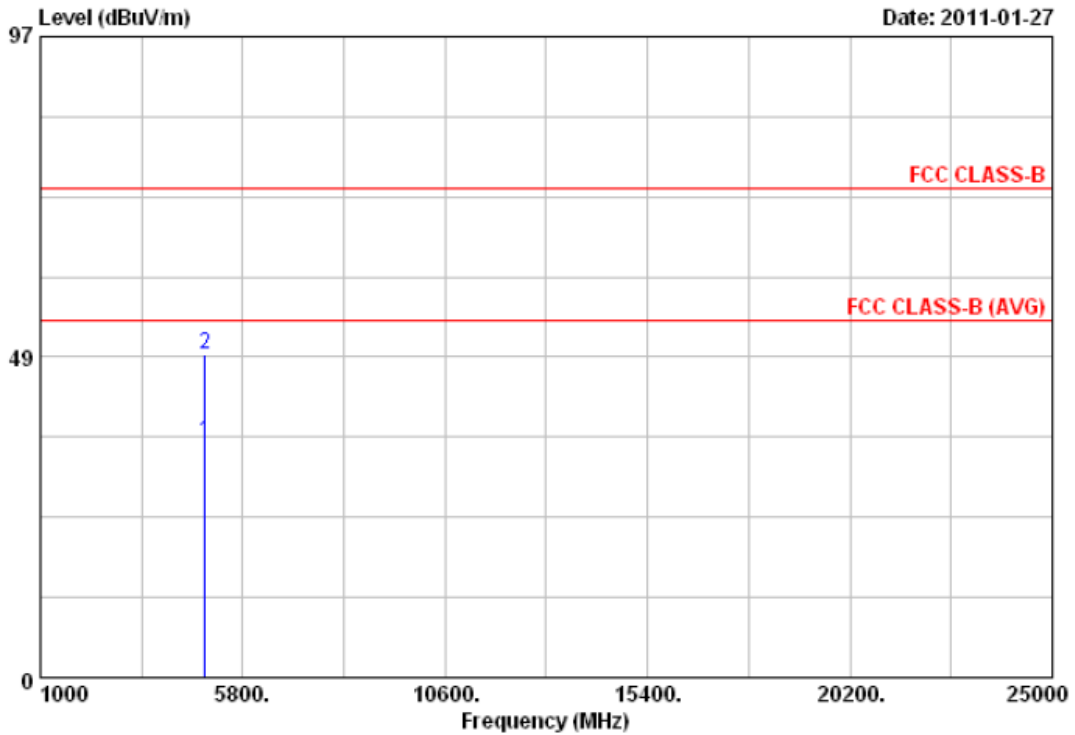

Item	Freq	Read Value	Factor	Result	Limit	Margin	Remark	Ant Pos	Tab Pos
	MHz	dBuV	dB/m	dBuV/m	dBuV/m	dB		cm	Deg
1	4912.00	32.57	2.97	35.54	54.00	-18.46	Average	100	0
2	4912.00	45.83	2.97	48.80	74.00	-25.20	Peak	100	0

Notes:

1. Result = Read Value + Factor
2. Factor = Antenna Factor + Cable Loss - Amplifier
3. The resolution bandwidth of test receiver/spectrum analyzer is 120KHz and video bandwidth is 300kHz for Peak detection and Quasi-peak detection at frequency below 1GHz.
4. The resolution bandwidth of test receiver/spectrum analyzer is 1MHz and video bandwidth is 3MHz for Peak detection at frequency above 1GHz.
5. The resolution bandwidth of test receiver/spectrum analyzer is 1MHz and video bandwidth is 10Hz for Average detection at frequency above 1GHz.
6. The other emissions is too low to be measured.
7. The data is worse case.



Power	: AC 120V	Pol/Phase	: VERTICAL
Test Mode 1	: 802.11g (54Mbps), CH1	Temperature	: 25 °C
Memo	: Antenna 2	Humidity	: 59 %

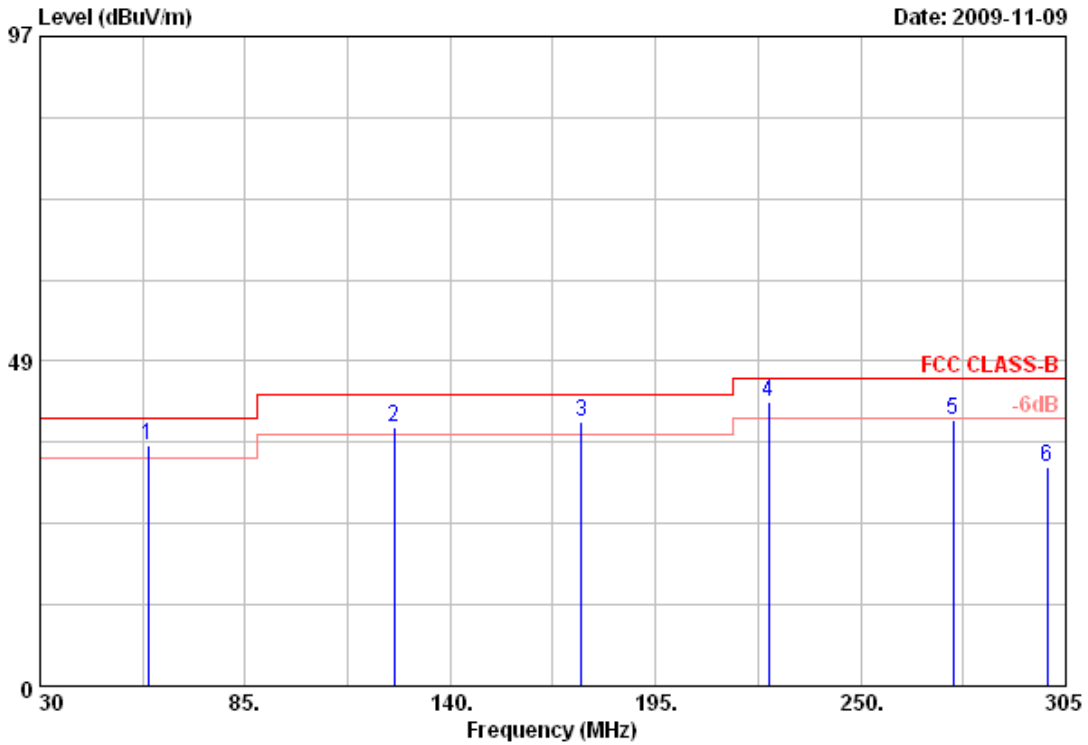

Item	Freq	Read Value	Factor	Result	Limit	Margin	Remark	Ant Pos	Tab Pos
	MHz	dBuV	dB/m	dBuV/m	dBuV/m	dB		cm	Deg
1	58.88	48.72	-12.68	36.04	40.00	-3.96	QP	100	179
2	124.88	48.18	-9.43	38.75	43.50	-4.75	QP	100	179
3	175.20	51.25	-11.89	39.36	43.50	-4.14	QP	100	179
4	225.25	52.91	-10.44	42.47	46.00	-3.53	QP	100	179
5	274.75	52.30	-12.69	39.61	46.00	-6.39	Peak	100	179
6	300.05	44.73	-12.01	32.72	46.00	-13.28	Peak	100	179

Notes:

1. Result = Read Value + Factor
2. Factor = Antenna Factor + Cable Loss - Amplifier
3. The resolution bandwidth of test receiver/spectrum analyzer is 120KHz and video bandwidth is 300kHz for Peak detection and Quasi-peak detection at frequency below 1GHz.
4. All emission below 1GHz at 802.11g mode are all the same,so the 802.11g mode chosen as representative in final test.
5. According to technical experiences,all spurious emission of 802.11g mode at channel 1,6,11 are almost the same below 1GHz,so that the channel 1 was chosen as representative in final test.
6. The data is worse case.



Power	: AC 120V	Pol/Phase	: VERTICAL
Test Mode 1	: 802.11g (54Mbps), CH1	Temperature	: 25 °C
Memo	: Antenna 2	Humidity	: 59 %

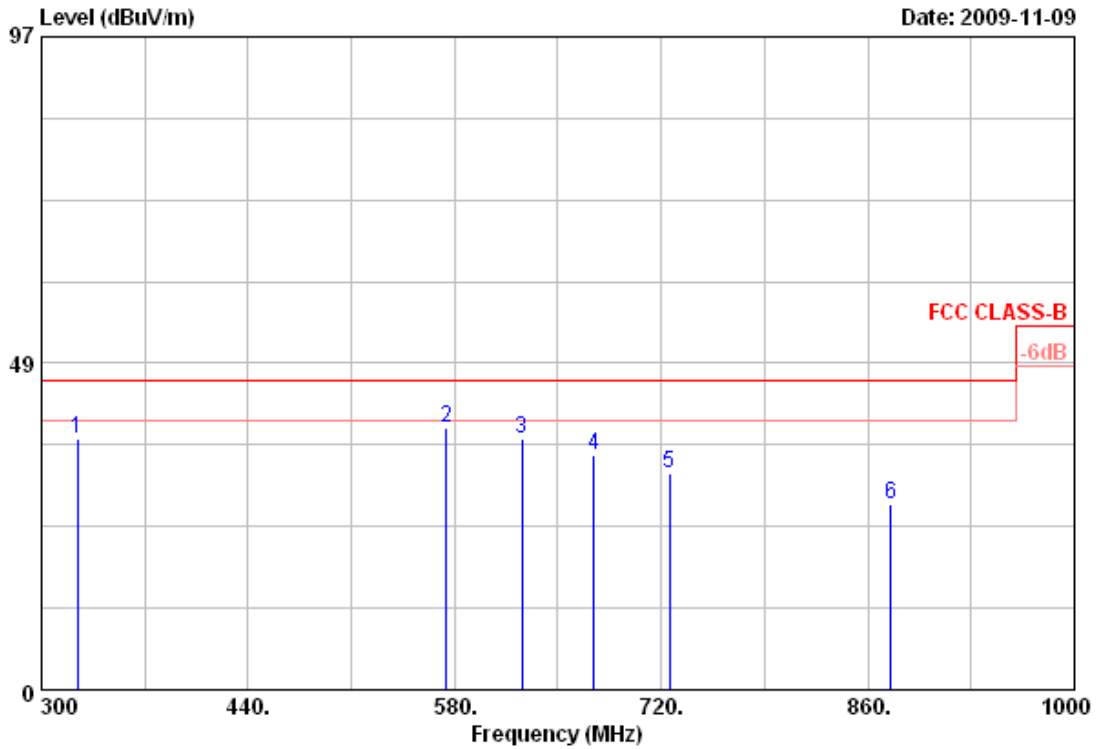

Item	Freq MHz	Read Value dBuV	Factor dB/m	Result dBuV/m	Limit dBuV/m	Margin dB	Remark	Ant Pos cm	Tab Pos Deg
1	324.50	47.18	-9.78	37.40	46.00	-8.60	Peak	100	150
2	574.40	42.41	-3.43	38.98	46.00	-7.02	Peak	100	150
3	625.50	43.83	-6.52	37.31	46.00	-8.69	Peak	100	150
4	674.50	39.89	-5.15	34.74	46.00	-11.26	Peak	100	150
5	725.60	33.15	-1.09	32.06	46.00	-13.94	Peak	100	150
6	875.40	26.68	0.75	27.43	46.00	-18.57	Peak	100	150

Notes:

1. Result = Read Value + Factor
2. Factor = Antenna Factor + Cable Loss - Amplifier
3. The resolution bandwidth of test receiver/spectrum analyzer is 120KHz and video bandwidth is 300kHz for Peak detection and Quasi-peak detection at frequency below 1GHz.
4. All emission below 1GHz at 802.11b/g mode are all the same,so the 802.11g mode chosen as representative in final test.
5. According to technical experiences,all spurious emission of 802.11g mode at channel 1,6,11 are almost the same below 1GHz,so that the channel 1 was chosen as representative in final test.
6. The data is worse case.



Power	: AC 120V	Pol/Phase	: HORIZONTAL
Test Mode 1	: 802.11g (54Mbps), CH1	Temperature	: 25 °C
Memo	: Antenna 2	Humidity	: 59 %

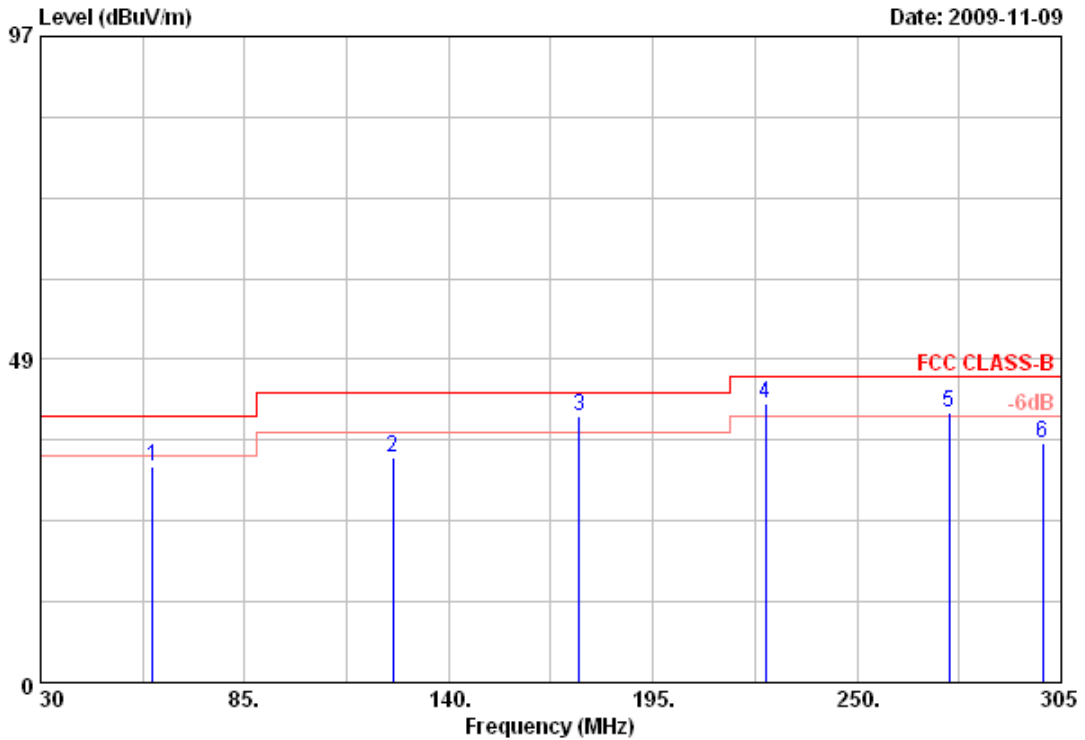

Item	Freq	Read Value	Factor	Result	Limit	Margin	Remark	Ant Pos	Tab Pos
	MHz	dBuV	dB/m	dBuV/m	dBuV/m	dB		cm	Deg
1	60.25	51.41	-18.87	32.54	40.00	-7.46	Peak	100	121
2	124.88	50.52	-16.67	33.85	43.50	-9.65	Peak	100	121
3	175.20	57.27	-17.16	40.11	43.50	-3.39	QP	100	121
4	225.25	57.04	-15.23	41.81	46.00	-4.19	QP	100	121
5	274.75	53.60	-13.18	40.42	46.00	-5.58	QP	100	121
6	300.05	48.96	-13.01	35.95	46.00	-10.05	Peak	100	121

Notes:

1. Result = Read Value + Factor
2. Factor = Antenna Factor + Cable Loss - Amplifier
3. The resolution bandwidth of test receiver/spectrum analyzer is 120KHz and video bandwidth is 300kHz for Peak detection and Quasi-peak detection at frequency below 1GHz.
4. All emission below 1GHz at 802.11b/g mode are all the same,so the 802.11g mode chosen as representative in final test.
5. According to technical experiences,all spurious emission of 802.11g mode at channel 1,6,11 are almost the same below 1GHz,so that the channel 1 was chosen as representative in final test.
6. The data is worse case.



Power	: AC 120V	Pol/Phase	: HORIZONTAL
Test Mode 1	: 802.11g (54Mbps), CH1	Temperature	: 25 °C
Memo	: Antenna 2	Humidity	: 59 %

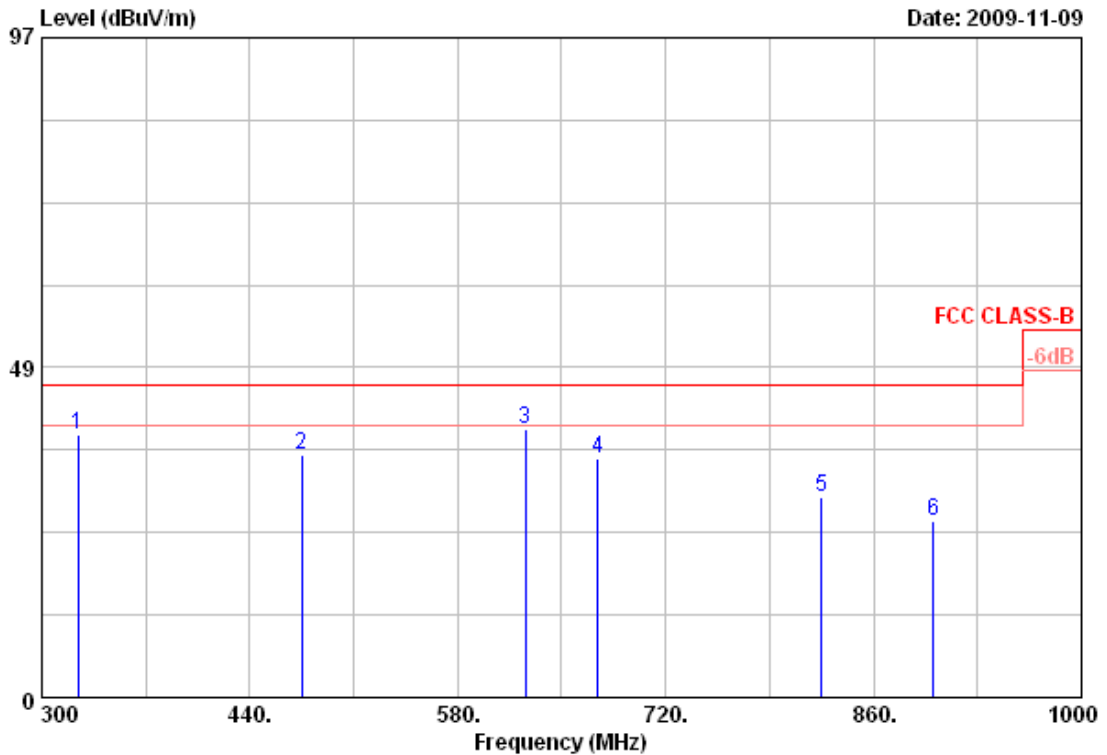

Item	Freq	Read Value	Factor	Result	Limit	Margin	Remark	Ant Pos	Tab Pos
	MHz	dBuV	dB/m	dBuV/m	dBuV/m	dB		cm	Deg
1	324.50	50.67	-11.95	38.72	46.00	-7.28	Peak	100	162
2	475.00	41.09	-5.42	35.67	46.00	-10.33	Peak	100	162
3	625.50	40.81	-1.45	39.36	46.00	-6.64	Peak	100	162
4	674.50	38.85	-3.71	35.14	46.00	-10.86	Peak	100	162
5	825.00	28.22	1.34	29.56	46.00	-16.44	Peak	100	162
6	900.60	24.52	1.54	26.06	46.00	-19.94	Peak	100	162

Notes:

1. Result = Read Value + Factor
2. Factor = Antenna Factor + Cable Loss - Amplifier
3. The resolution bandwidth of test receiver/spectrum analyzer is 120KHz and video bandwidth is 300kHz for Peak detection and Quasi-peak detection at frequency below 1GHz.
4. All emission below 1GHz at 802.11b/g mode are all the same,so the 802.11g mode chosen as representative in final test.
5. According to technical experiences,all spurious emission of 802.11g mode at channel 1,6,11 are almost the same below 1GHz,so that the channel 1 was chosen as representative in final test.
6. The data is worse case.



Power	: AC 120V	Pol/Phase	: VERTICAL
Test Mode 1	: 802.11b (11Mbps), CH1	Temperature	: 26 °C
Memo	: Antenna 2	Humidity	: 58 %

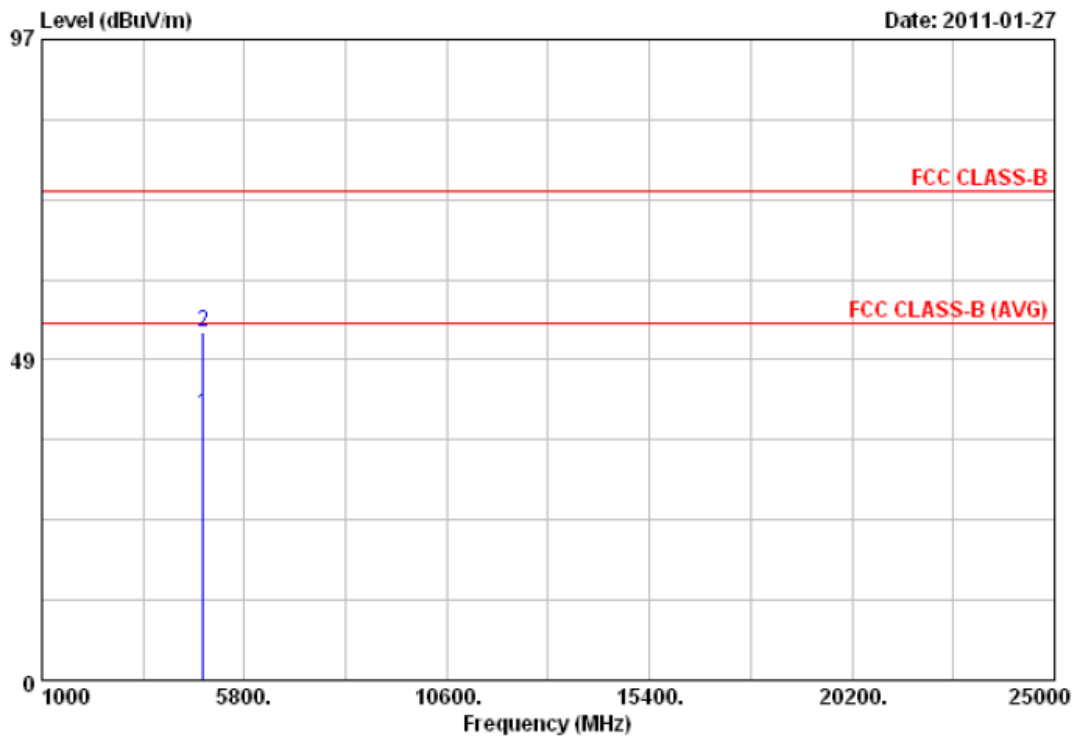

Item	Freq	Read Value	Factor	Result	Limit	Margin	Remark	Ant Pos	Tab Pos
	MHz	dBuV	dB/m	dBuV/m	dBuV/m	dB		cm	Deg
1	4824.00	37.46	2.72	40.18	54.00	-13.82	Average	100	0
2	4824.00	49.92	2.72	52.64	74.00	-21.36	Peak	100	0

Notes:

1. Result = Read Value + Factor
2. Factor = Antenna Factor + Cable Loss - Amplifier
3. The resolution bandwidth of test receiver/spectrum analyzer is 120KHz and video bandwidth is 300kHz for Peak detection and Quasi-peak detection at frequency below 1GHz.
4. The resolution bandwidth of test receiver/spectrum analyzer is 1MHz and video bandwidth is 3MHz for Peak detection at frequency above 1GHz.
5. The resolution bandwidth of test receiver/spectrum analyzer is 1MHz and video bandwidth is 10Hz for Average detection at frequency above 1GHz.
6. The other emissions is too low to be measured.
7. The data is worse case.



Power	: AC 120V	Pol/Phase	: HORIZONTAL
Test Mode 1	: 802.11b (11Mbps), CH1	Temperature	: 26 °C
Memo	: Antenna 2	Humidity	: 58 %

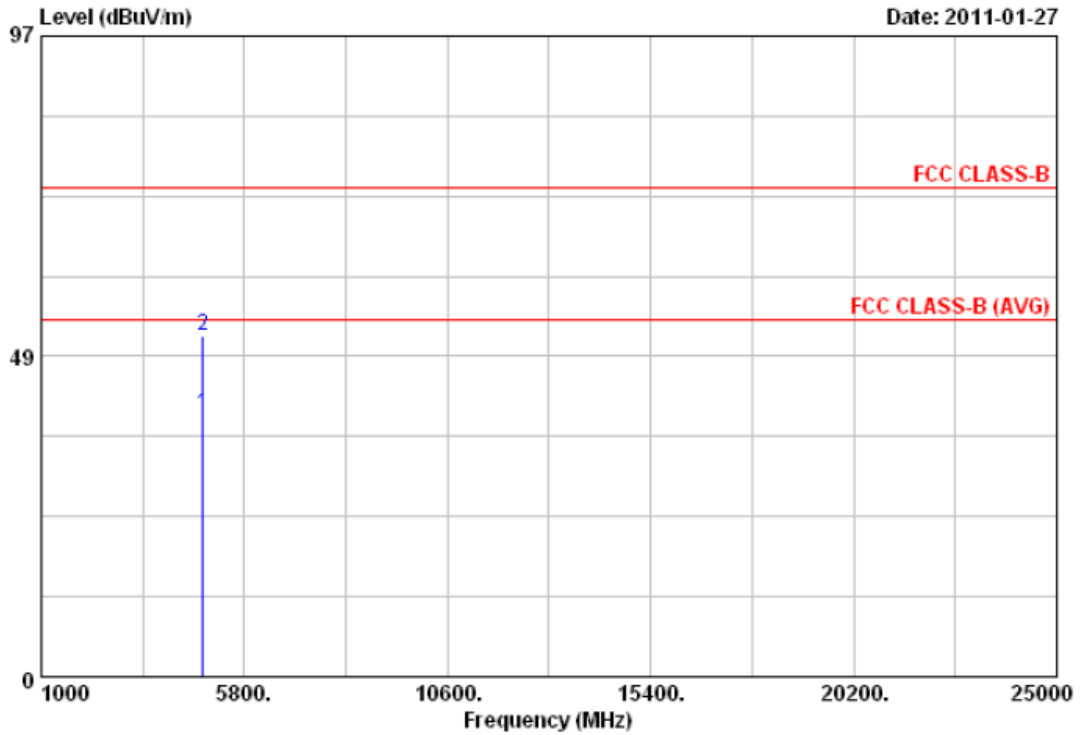

Item	Freq	Read Value	Factor	Result	Limit	Margin	Remark	Ant Pos	Tab Pos
	MHz	dBuV	dB/m	dBuV/m	dBuV/m	dB		cm	Deg
1	4824.40	37.00	2.72	39.72	54.00	-14.28	Average	100	0
2	4824.40	48.91	2.72	51.63	74.00	-22.37	Peak	100	0

Notes:

1. Result = Read Value + Factor
2. Factor = Antenna Factor + Cable Loss - Amplifier
3. The resolution bandwidth of test receiver/spectrum analyzer is 120KHz and video bandwidth is 300kHz for Peak detection and Quasi-peak detection at frequency below 1GHz.
4. The resolution bandwidth of test receiver/spectrum analyzer is 1MHz and video bandwidth is 3MHz for Peak detection at frequency above 1GHz.
5. The resolution bandwidth of test receiver/spectrum analyzer is 1MHz and video bandwidth is 10Hz for Average detection at frequency above 1GHz.
6. The other emissions is too low to be measured.
7. The data is worse case.



Power	: AC 120V	Pol/Phase	: VERTICAL
Test Mode 1	: 802.11b (11Mbps), CH6	Temperature	: 26 °C
Memo	: Antenna 2	Humidity	: 58 %

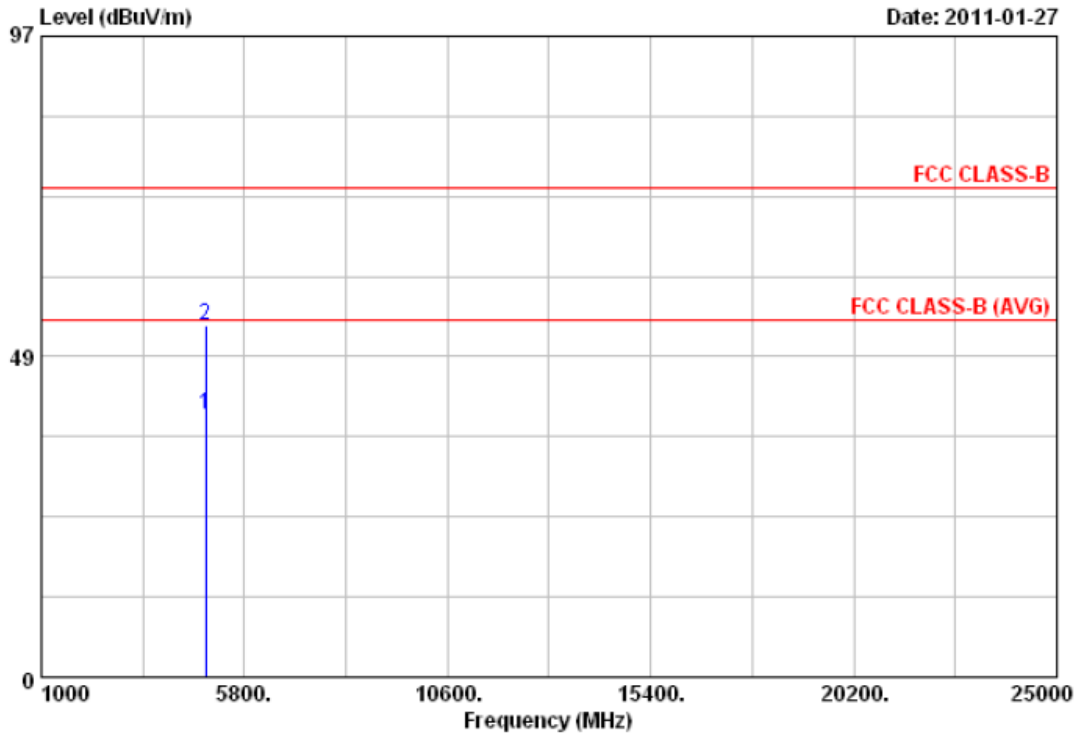

Item	Freq	Read Value	Factor	Result	Limit	Margin	Remark	Ant Pos	Tab Pos
	MHz	dBuV	dB/m	dBuV/m	dBuV/m	dB		cm	Deg
1	4874.00	36.85	2.87	39.72	54.00	-14.28	Average	100	0
2	4874.00	50.49	2.87	53.36	74.00	-20.64	Peak	100	0

Notes:

1. Result = Read Value + Factor
2. Factor = Antenna Factor + Cable Loss - Amplifier
3. The resolution bandwidth of test receiver/spectrum analyzer is 120KHz and video bandwidth is 300kHz for Peak detection and Quasi-peak detection at frequency below 1GHz.
4. The resolution bandwidth of test receiver/spectrum analyzer is 1MHz and video bandwidth is 3MHz for Peak detection at frequency above 1GHz.
5. The resolution bandwidth of test receiver/spectrum analyzer is 1MHz and video bandwidth is 10Hz for Average detection at frequency above 1GHz.
6. The other emissions is too low to be measured.
7. The data is worse case.



Power	: AC 120V	Pol/Phase	: HORIZONTAL
Test Mode 1	: 802.11b (11Mbps), CH6	Temperature	: 26 °C
Memo	: Antenna 2	Humidity	: 58 %

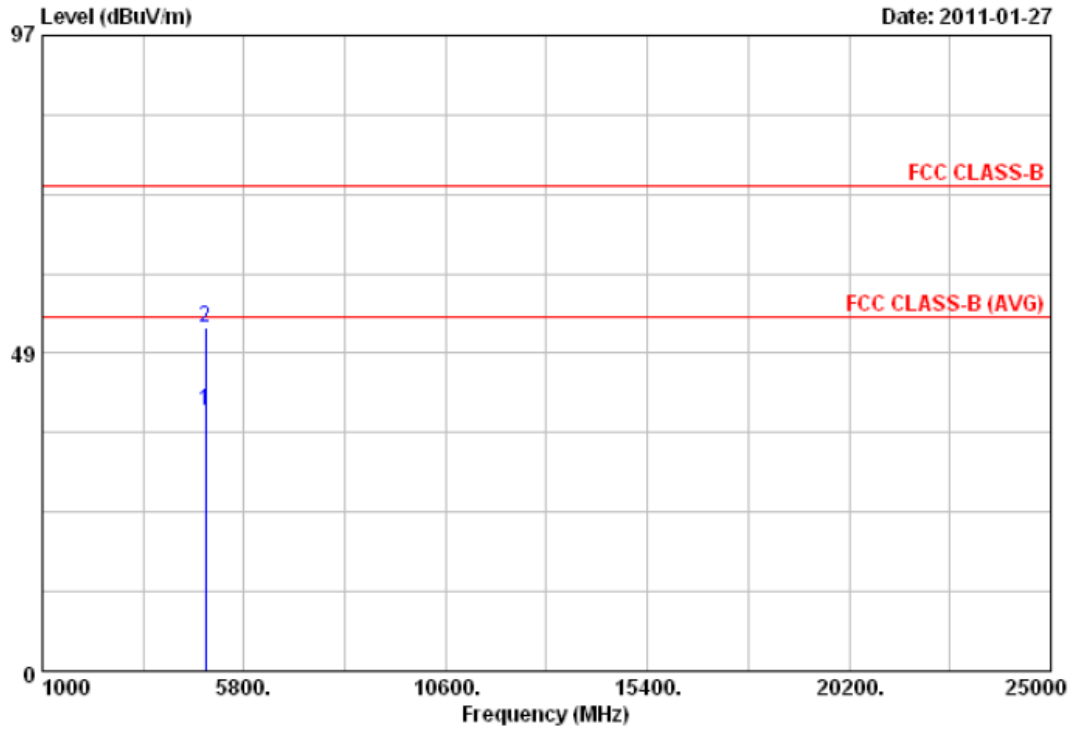

Item	Freq	Read Value	Factor	Result	Limit	Margin	Remark	Ant Pos	Tab Pos
	MHz	dBuV	dB/m	dBuV/m	dBuV/m	dB		cm	Deg
1	4874.00	36.97	2.87	39.84	54.00	-14.16	Average	100	0
2	4874.00	49.46	2.87	52.33	74.00	-21.67	Peak	100	0

Notes:

1. Result = Read Value + Factor
2. Factor = Antenna Factor + Cable Loss - Amplifier
3. The resolution bandwidth of test receiver/spectrum analyzer is 120KHz and video bandwidth is 300kHz for Peak detection and Quasi-peak detection at frequency below 1GHz.
4. The resolution bandwidth of test receiver/spectrum analyzer is 1MHz and video bandwidth is 3MHz for Peak detection at frequency above 1GHz.
5. The resolution bandwidth of test receiver/spectrum analyzer is 1MHz and video bandwidth is 10Hz for Average detection at frequency above 1GHz.
6. The other emissions is too low to be measured.
7. The data is worse case.



Power	: AC 120V	Pol/Phase	: VERTICAL
Test Mode 1	: 802.11b (11Mbps), CH11	Temperature	: 26 °C
Memo	: Antenna 2	Humidity	: 58 %

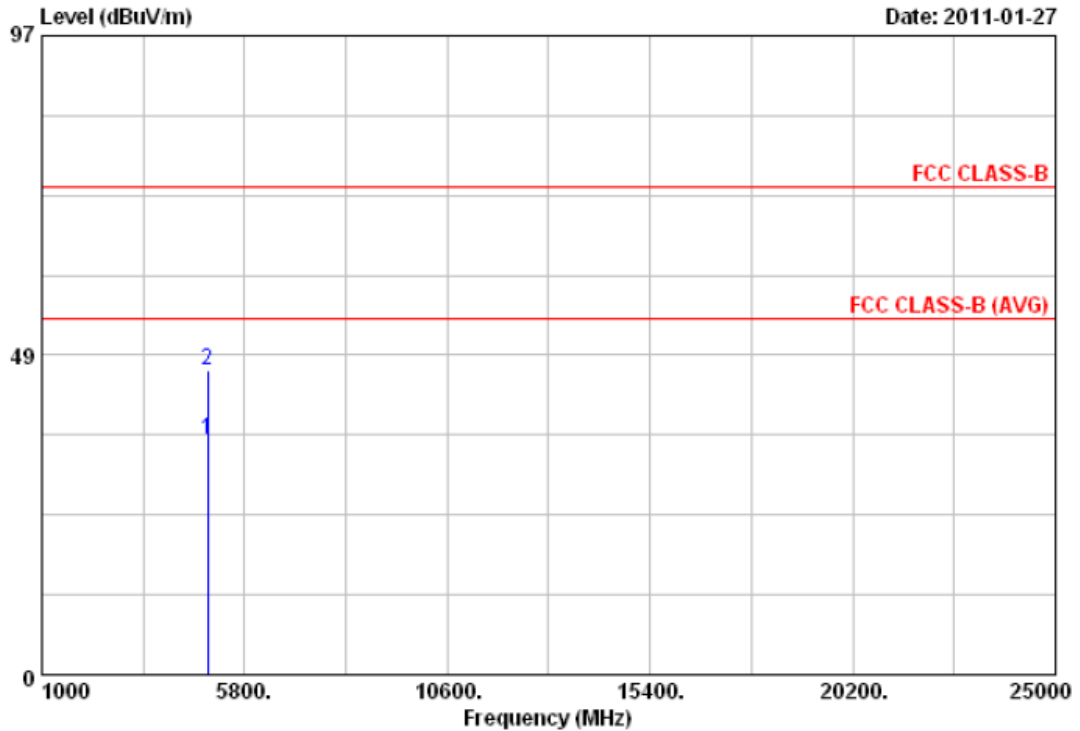

Item	Freq	Read Value	Factor	Result	Limit	Margin	Remark	Ant Pos	Tab Pos
	MHz	dBuV	dB/m	dBuV/m	dBuV/m	dB		cm	Deg
1	4924.00	32.75	3.01	35.76	54.00	-18.24	Average	100	0
2	4924.00	43.25	3.01	46.26	74.00	-27.74	Peak	100	0

Notes:

1. Result = Read Value + Factor
2. Factor = Antenna Factor + Cable Loss - Amplifier
3. The resolution bandwidth of test receiver/spectrum analyzer is 120KHz and video bandwidth is 300kHz for Peak detection and Quasi-peak detection at frequency below 1GHz.
4. The resolution bandwidth of test receiver/spectrum analyzer is 1MHz and video bandwidth is 3MHz for Peak detection at frequency above 1GHz.
5. The resolution bandwidth of test receiver/spectrum analyzer is 1MHz and video bandwidth is 10Hz for Average detection at frequency above 1GHz.
6. The other emissions is too low to be measured.
7. The data is worse case.



Power	: AC 120V	Pol/Phase	: HORIZONTAL
Test Mode 1	: 802.11b (11Mbps), CH11	Temperature	: 26 °C
Memo	: Antenna 2	Humidity	: 58 %

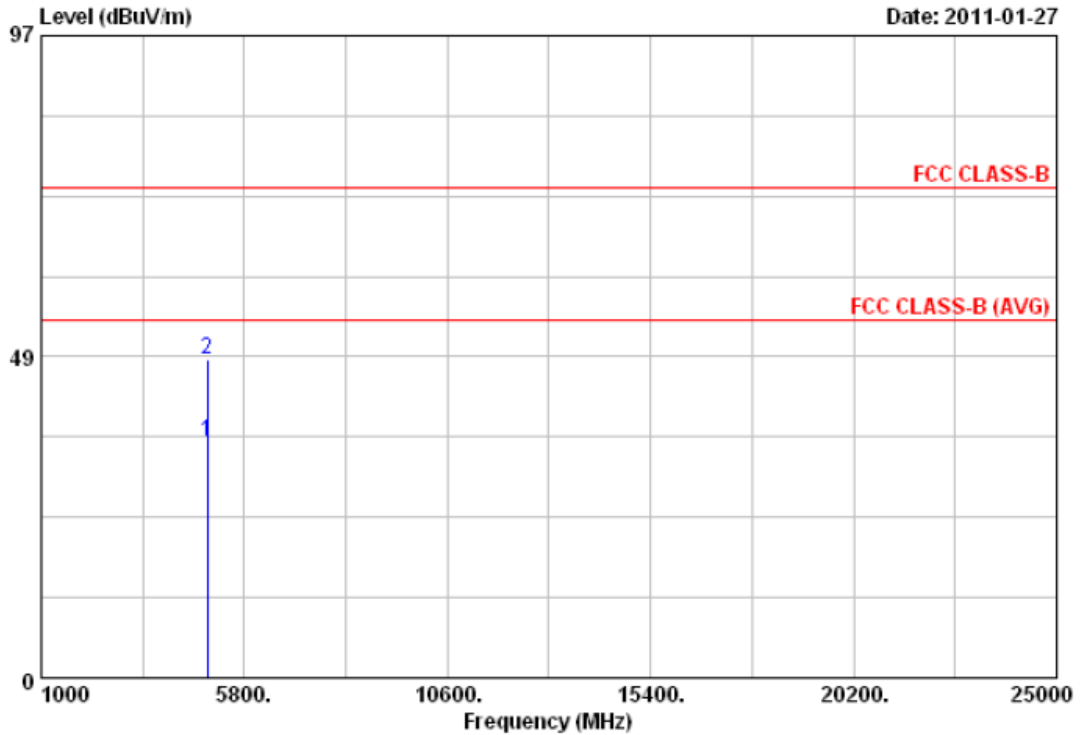

Item	Freq	Read Value	Factor	Result	Limit	Margin	Remark	Ant Pos	Tab Pos
	MHz	dBuV	dB/m	dBuV/m	dBuV/m	dB		cm	Deg
1	4924.00	32.60	3.01	35.61	54.00	-18.39	Average	100	0
2	4924.00	44.99	3.01	48.00	74.00	-26.00	Peak	100	0

Notes:

1. Result = Read Value + Factor
2. Factor = Antenna Factor + Cable Loss - Amplifier
3. The resolution bandwidth of test receiver/spectrum analyzer is 120KHz and video bandwidth is 300kHz for Peak detection and Quasi-peak detection at frequency below 1GHz.
4. The resolution bandwidth of test receiver/spectrum analyzer is 1MHz and video bandwidth is 3MHz for Peak detection at frequency above 1GHz.
5. The resolution bandwidth of test receiver/spectrum analyzer is 1MHz and video bandwidth is 10Hz for Average detection at frequency above 1GHz.
6. The other emissions is too low to be measured.
7. The data is worse case.



Power	: AC 120V	Pol/Phase	: VERTICAL
Test Mode 1	: 802.11g (54Mbps), CH1	Temperature	: 26 °C
Memo	: Antenna 2	Humidity	: 58 %

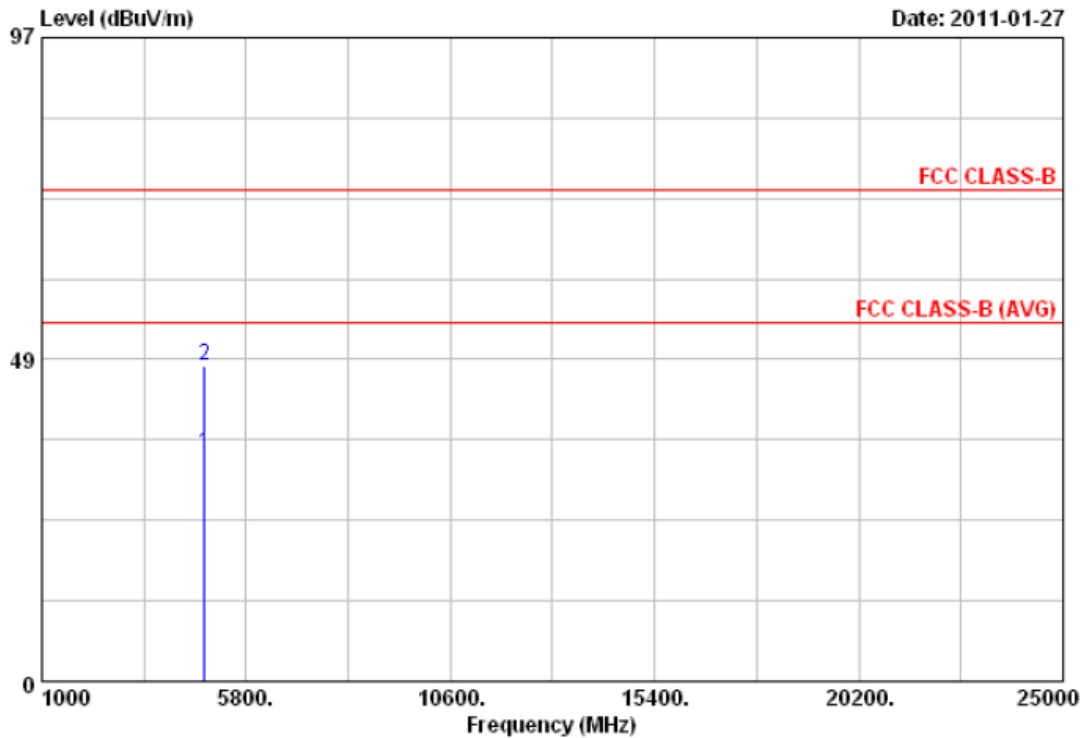

Item	Freq	Read Value	Factor	Result	Limit	Margin	Remark	Ant Pos	Tab Pos
	MHz	dBuV	dB/m	dBuV/m	dBuV/m	dB		cm	Deg
1	4824.00	31.72	2.72	34.44	54.00	-19.56	Average	100	0
2	4824.00	44.91	2.72	47.63	74.00	-26.37	Peak	100	0

Notes:

1. Result = Read Value + Factor
2. Factor = Antenna Factor + Cable Loss - Amplifier
3. The resolution bandwidth of test receiver/spectrum analyzer is 120KHz and video bandwidth is 300kHz for Peak detection and Quasi-peak detection at frequency below 1GHz.
4. The resolution bandwidth of test receiver/spectrum analyzer is 1MHz and video bandwidth is 3MHz for Peak detection at frequency above 1GHz.
5. The resolution bandwidth of test receiver/spectrum analyzer is 1MHz and video bandwidth is 10Hz for Average detection at frequency above 1GHz.
6. The other emissions is too low to be measured.
7. The data is worse case.



Power	: AC 120V	Pol/Phase	: HORIZONTAL
Test Mode 1	: 802.11g (54Mbps), CH1	Temperature	: 26 °C
Memo	: Antenna 2	Humidity	: 58 %

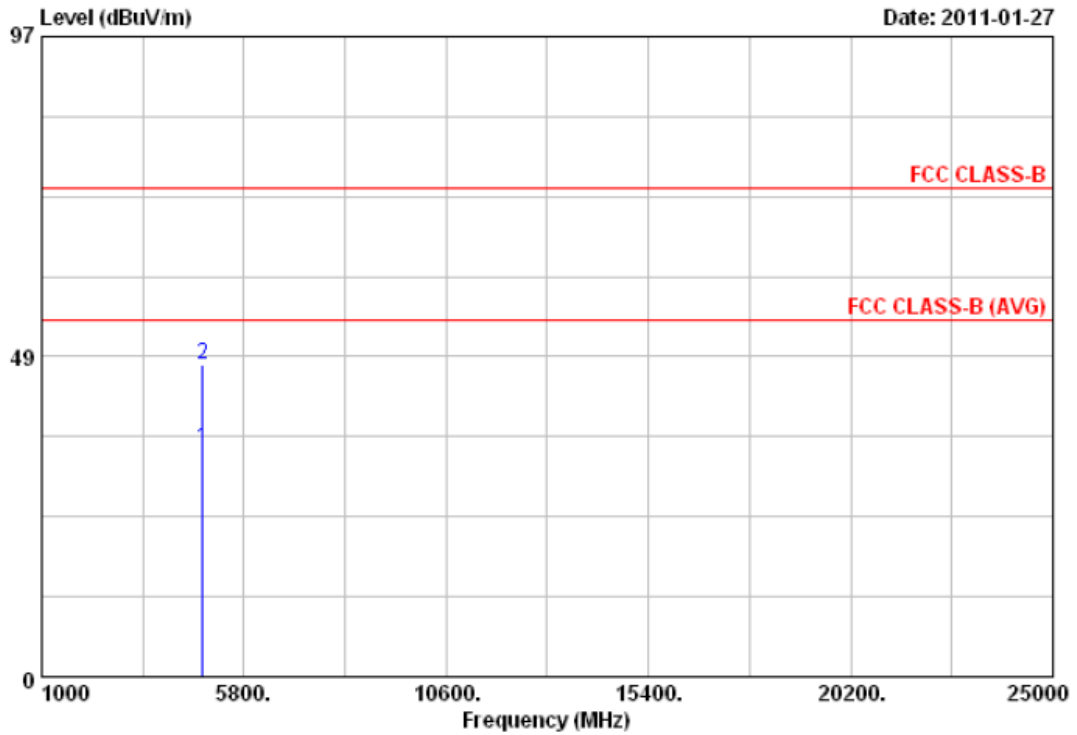

Item	Freq	Read Value	Factor	Result	Limit	Margin	Remark	Ant Pos	Tab Pos
	MHz	dBuV	dB/m	dBuV/m	dBuV/m	dB		cm	Deg
1	4824.00	31.94	2.72	34.66	54.00	-19.34	Average	100	0
2	4824.00	44.54	2.72	47.26	74.00	-26.74	Peak	100	0

Notes:

1. Result = Read Value + Factor
2. Factor = Antenna Factor + Cable Loss - Amplifier
3. The resolution bandwidth of test receiver/spectrum analyzer is 120KHz and video bandwidth is 300kHz for Peak detection and Quasi-peak detection at frequency below 1GHz.
4. The resolution bandwidth of test receiver/spectrum analyzer is 1MHz and video bandwidth is 3MHz for Peak detection at frequency above 1GHz.
5. The resolution bandwidth of test receiver/spectrum analyzer is 1MHz and video bandwidth is 10Hz for Average detection at frequency above 1GHz.
6. The other emissions is too low to be measured.
7. The data is worse case.



Power	: AC 120V	Pol/Phase	: VERTICAL
Test Mode 1	: 802.11g (54Mbps), CH6	Temperature	: 26 °C
Memo	: Antenna 2	Humidity	: 58 %

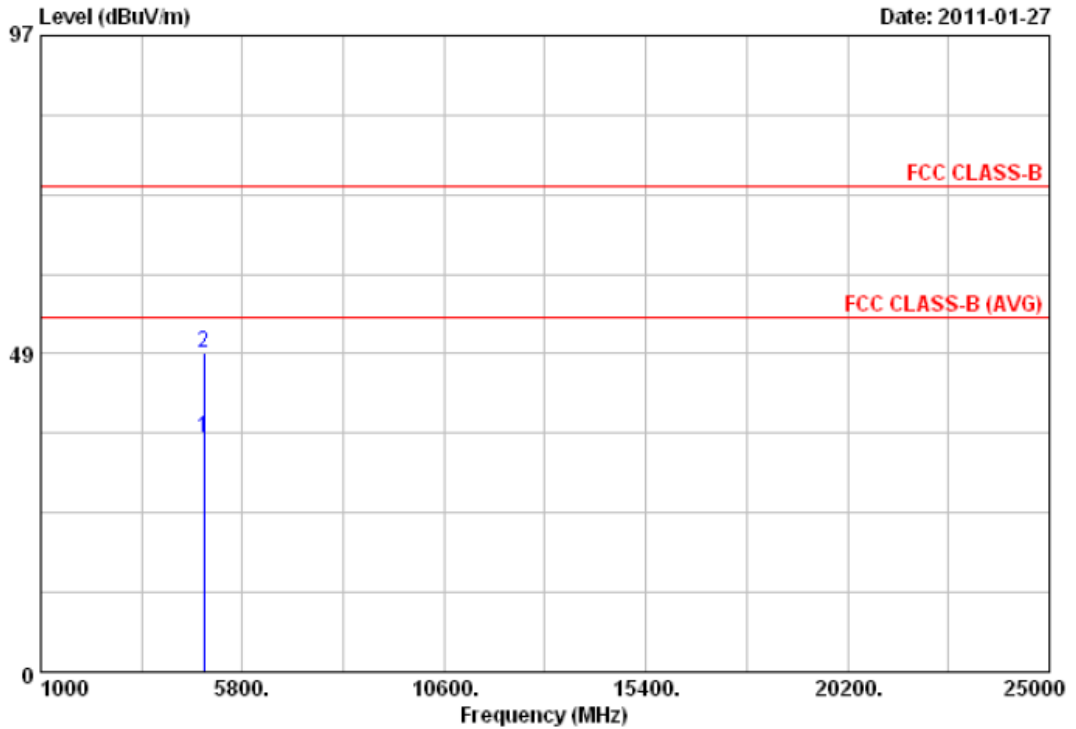

Item	Freq	Read Value	Factor	Result	Limit	Margin	Remark	Ant Pos	Tab Pos
	MHz	dBuV	dB/m	dBuV/m	dBuV/m	dB		cm	Deg
1	4874.00	32.86	2.87	35.73	54.00	-18.27	Average	100	0
2	4874.00	45.76	2.87	48.63	74.00	-25.37	Peak	100	0

Notes:

1. Result = Read Value + Factor
2. Factor = Antenna Factor + Cable Loss - Amplifier
3. The resolution bandwidth of test receiver/spectrum analyzer is 120KHz and video bandwidth is 300kHz for Peak detection and Quasi-peak detection at frequency below 1GHz.
4. The resolution bandwidth of test receiver/spectrum analyzer is 1MHz and video bandwidth is 3MHz for Peak detection at frequency above 1GHz.
5. The resolution bandwidth of test receiver/spectrum analyzer is 1MHz and video bandwidth is 10Hz for Average detection at frequency above 1GHz.
6. The other emissions is too low to be measured.
7. The data is worse case.



Power	: AC 120V	Pol/Phase	: HORIZONTAL
Test Mode 1	: 802.11g (54Mbps), CH6	Temperature	: 26 °C
Memo	: Antenna 2	Humidity	: 58 %

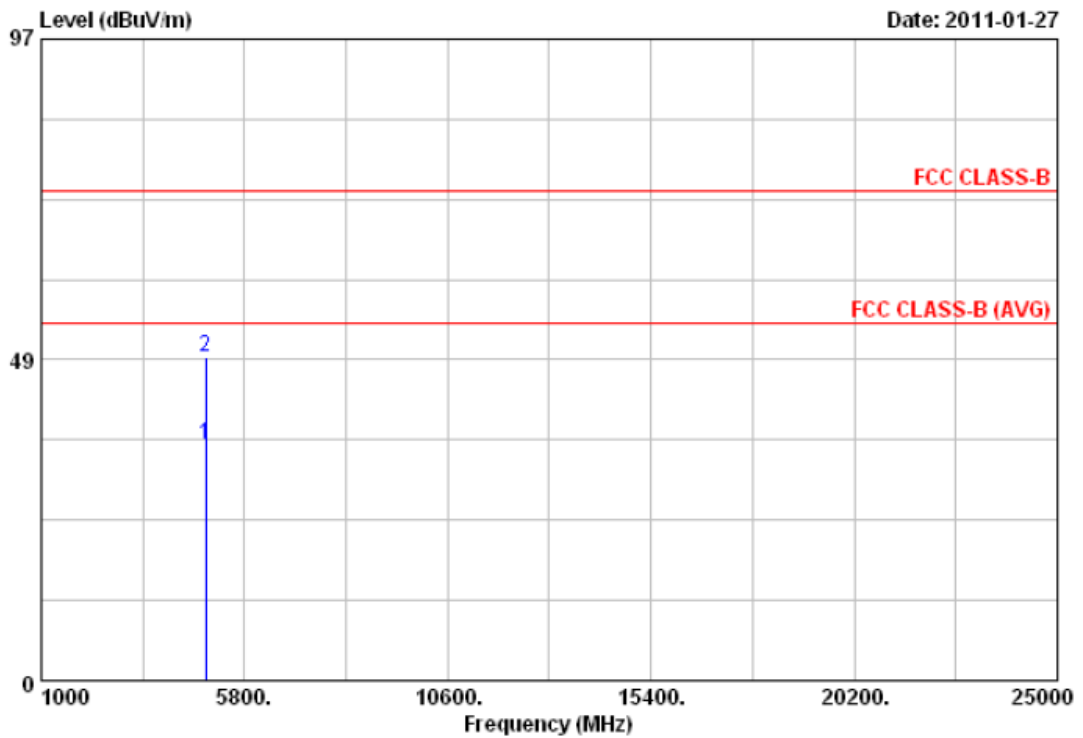

Item	Freq	Read Value	Factor	Result	Limit	Margin	Remark	Ant Pos	Tab Pos
	MHz	dBuV	dB/m	dBuV/m	dBuV/m	dB		cm	Deg
1	4874.00	32.69	2.87	35.56	54.00	-18.44	Average	100	0
2	4874.00	46.16	2.87	49.03	74.00	-24.97	Peak	100	0

Notes:

1. Result = Read Value + Factor
2. Factor = Antenna Factor + Cable Loss - Amplifier
3. The resolution bandwidth of test receiver/spectrum analyzer is 120KHz and video bandwidth is 300kHz for Peak detection and Quasi-peak detection at frequency below 1GHz.
4. The resolution bandwidth of test receiver/spectrum analyzer is 1MHz and video bandwidth is 3MHz for Peak detection at frequency above 1GHz.
5. The resolution bandwidth of test receiver/spectrum analyzer is 1MHz and video bandwidth is 10Hz for Average detection at frequency above 1GHz.
6. The other emissions is too low to be measured.
7. The data is worse case.



Power	: AC 120V	Pol/Phase	: VERTICAL
Test Mode 1	: 802.11g (54Mbps), CH11	Temperature	: 26 °C
Memo	: Antenna 2	Humidity	: 58 %

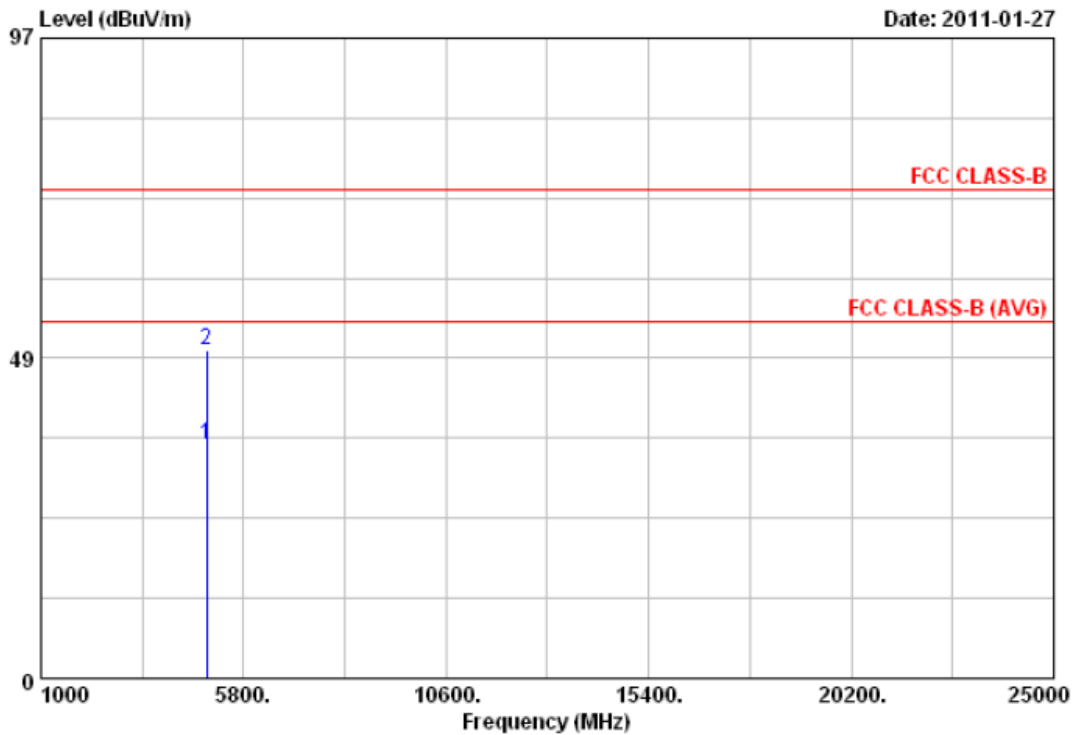

Item	Freq	Read Value	Factor	Result	Limit	Margin	Remark	Ant Pos	Tab Pos
	MHz	dBuV	dB/m	dBuV/m	dBuV/m	dB		cm	Deg
1	4924.00	32.32	3.01	35.33	54.00	-18.67	Average	100	0
2	4924.00	46.77	3.01	49.78	74.00	-24.22	Peak	100	0

Notes:

1. Result = Read Value + Factor
2. Factor = Antenna Factor + Cable Loss - Amplifier
3. The resolution bandwidth of test receiver/spectrum analyzer is 120KHz and video bandwidth is 300kHz for Peak detection and Quasi-peak detection at frequency below 1GHz.
4. The resolution bandwidth of test receiver/spectrum analyzer is 1MHz and video bandwidth is 3MHz for Peak detection at frequency above 1GHz.
5. The resolution bandwidth of test receiver/spectrum analyzer is 1MHz and video bandwidth is 10Hz for Average detection at frequency above 1GHz.
6. The other emissions is too low to be measured.
7. The data is worse case.



Power	: AC 120V	Pol/Phase	: HORIZONTAL
Test Mode 1	: 802.11g (54Mbps), CH11	Temperature	: 26 °C
Memo	: Antenna 2	Humidity	: 58 %

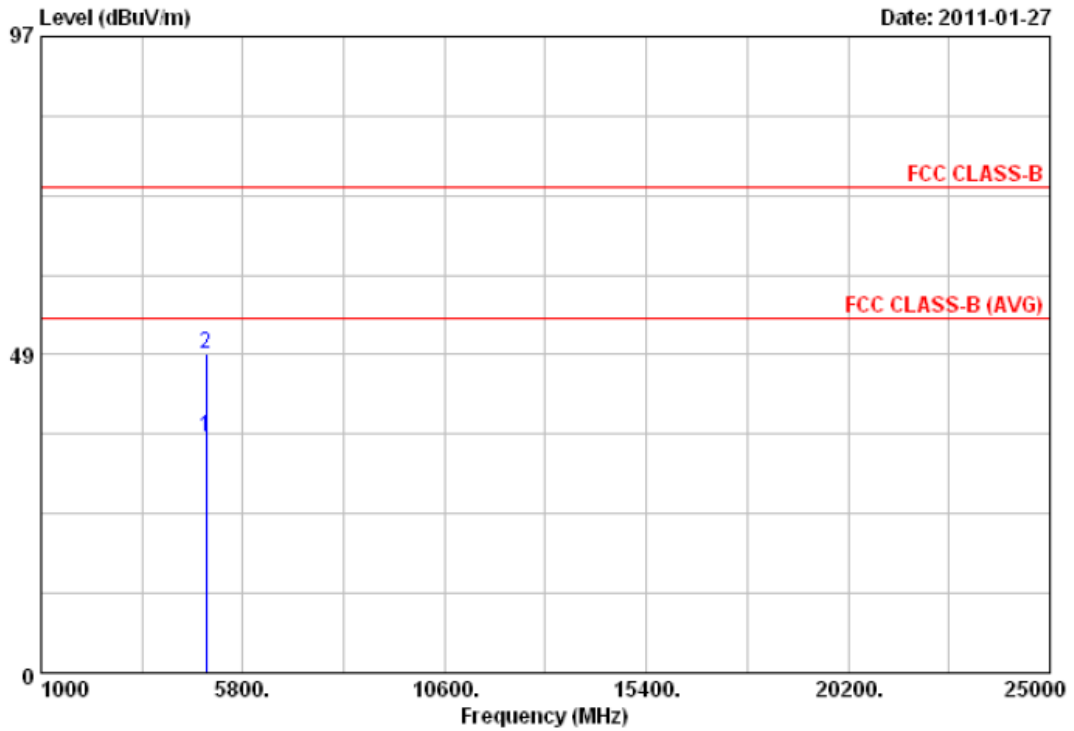

Item	Freq	Read Value	Factor	Result	Limit	Margin	Remark	Ant Pos	Tab Pos
	MHz	dBuV	dB/m	dBuV/m	dBuV/m	dB		cm	Deg
1	4924.00	32.86	3.01	35.87	54.00	-18.13	Average	100	0
2	4924.00	45.52	3.01	48.53	74.00	-25.47	Peak	100	0

Notes:

1. Result = Read Value + Factor
2. Factor = Antenna Factor + Cable Loss - Amplifier
3. The resolution bandwidth of test receiver/spectrum analyzer is 120KHz and video bandwidth is 300kHz for Peak detection and Quasi-peak detection at frequency below 1GHz.
4. The resolution bandwidth of test receiver/spectrum analyzer is 1MHz and video bandwidth is 3MHz for Peak detection at frequency above 1GHz.
5. The resolution bandwidth of test receiver/spectrum analyzer is 1MHz and video bandwidth is 10Hz for Average detection at frequency above 1GHz.
6. The other emissions is too low to be measured.
7. The data is worse case.



Power	: AC 120V	Pol/Phase	: VERTICAL
Test Mode 2	: 802.11n HT20 (130Mbps), CH1	Temperature	: 25 °C
Memo	:	Humidity	: 59 %

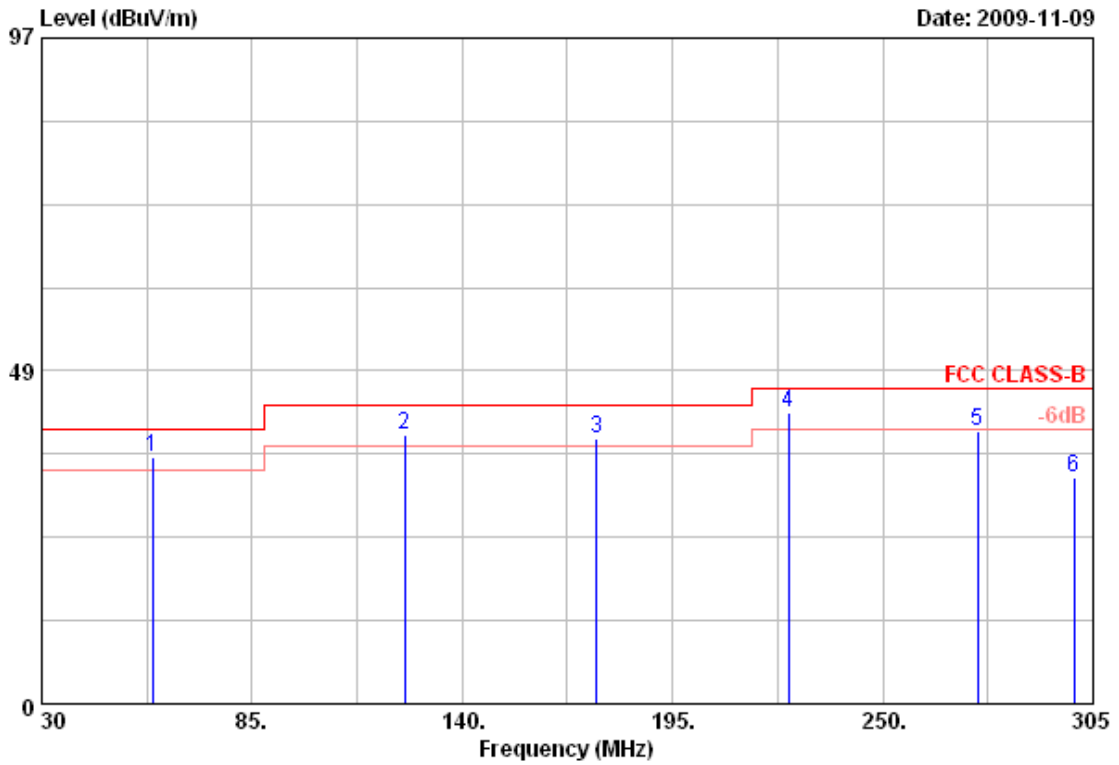

Item	Freq	Read Value	Factor	Result	Limit	Margin	Remark	Ant Pos	Tab Pos
	MHz	dBuV	db/m	dBuV/m	dBuV/m	dB		cm	Deg
1	58.88	48.73	-12.68	36.05	40.00	-3.95	QP	100	0
2	124.88	48.73	-9.43	39.30	43.50	-4.20	QP	100	0
3	175.20	50.45	-11.89	38.56	43.50	-4.94	QP	100	0
4	225.25	52.98	-10.44	42.54	46.00	-3.46	QP	100	0
5	274.75	52.54	-12.69	39.85	46.00	-6.15	Peak	100	0
6	300.05	44.88	-12.01	32.87	46.00	-13.13	Peak	100	0

Notes:

1. Result = Read Value + Factor
2. Factor = Antenna Factor + Cable Loss - Amplifier
3. The resolution bandwidth of test receiver/spectrum analyzer is 120KHz and video bandwidth is 300kHz for Peak detection and Quasi-peak detection at frequency below 1GHz.
4. According to technical experiences, all spurious emission of 802.11MIMO mode at channel 1,6,11 are almost the same below 1GHz, so that the channel 1 was chosen as representative in final test.
5. The data is worse case.



Power	: AC 120V	Pol/Phase	: VERTICAL
Test Mode 2	: 802.11n HT20 (130Mbps), CH1	Temperature	: 25 °C
Memo	:	Humidity	: 59 %

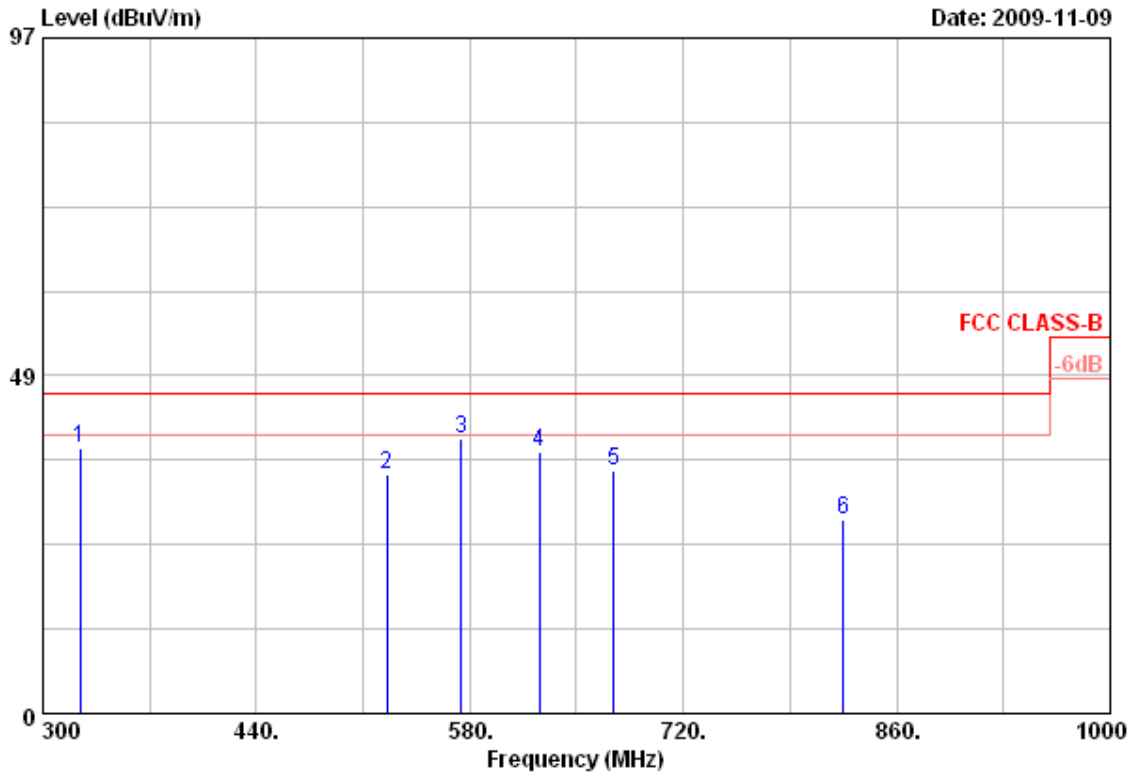

Item	Freq	Read Value	Factor	Result	Limit	Margin	Remark	Ant Pos	Tab Pos
	MHz	dBuV	db/m	dBuV/m	dBuV/m	dB		cm	Deg
1	324.50	47.76	-9.78	37.98	46.00	-8.02	Peak	100	0
2	525.40	42.36	-7.95	34.41	46.00	-11.59	Peak	100	0
3	574.40	42.94	-3.43	39.51	46.00	-6.49	Peak	100	0
4	625.50	44.02	-6.52	37.50	46.00	-8.50	Peak	100	0
5	674.50	39.99	-5.15	34.84	46.00	-11.16	Peak	100	0
6	825.00	27.64	0.16	27.80	46.00	-18.20	Peak	100	0

Notes:

1. Result = Read Value + Factor
2. Factor = Antenna Factor + Cable Loss - Amplifier
3. The resolution bandwidth of test receiver/spectrum analyzer is 120KHz and video bandwidth is 300KHz for Peak detection and Quasi-peak detection at frequency below 1GHz.
4. According to technical experiences, all spurious emission of 802.11MIMO mode at channel 1,6,11 are almost the same below 1GHz, so that the channel 1 was chosen as representative in final test.
5. The data is worse case.



Power	: AC 120V	Pol/Phase	: HORIZONTAL
Test Mode 2	: 802.11n HT20 (130Mbps), CH1	Temperature	: 25 °C
Memo	:	Humidity	: 59 %

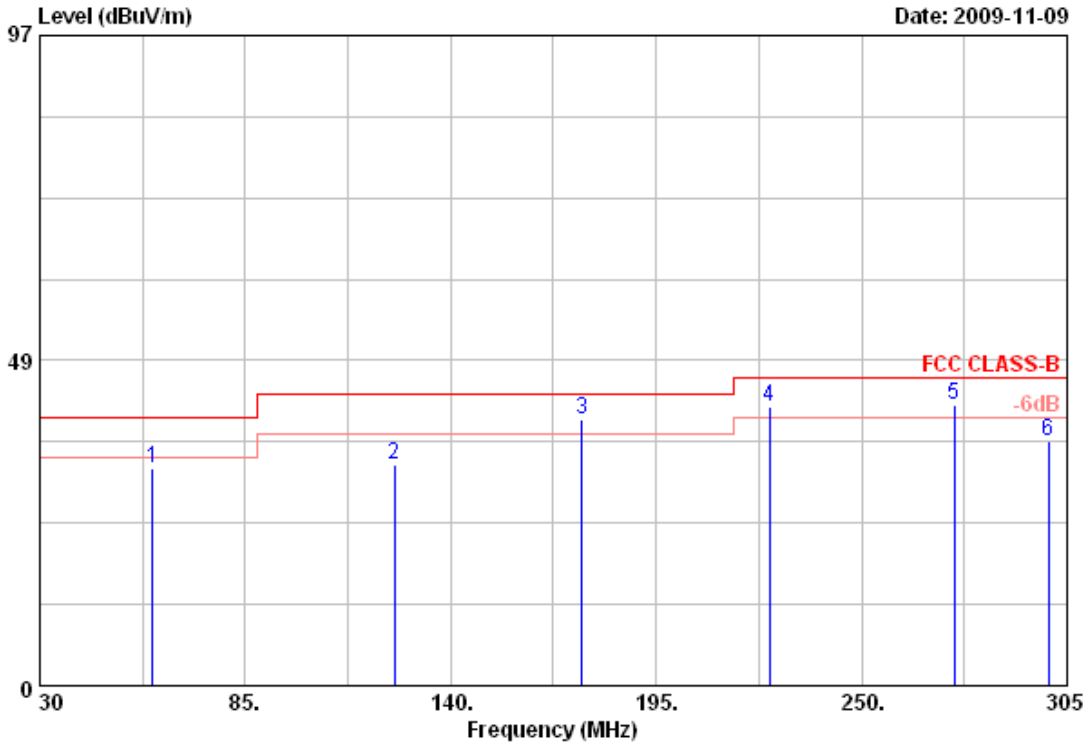

Item	Freq	Read Value	Factor	Result	Limit	Margin	Remark	Ant Pos	Tab Pos
	MHz	dBuV	db/m	dBuV/m	dBuV/m	dB		cm	Deg
1	60.25	51.41	-18.87	32.54	40.00	-7.46	Peak	100	0
2	124.88	49.73	-16.67	33.06	43.50	-10.44	Peak	100	0
3	175.20	56.81	-17.16	39.65	43.50	-3.85	QP	100	0
4	225.25	56.79	-15.23	41.56	46.00	-4.44	QP	100	0
5	274.75	54.96	-13.18	41.78	46.00	-4.22	QP	100	0
6	300.05	49.55	-13.01	36.54	46.00	-9.46	Peak	100	0

Notes:

1. Result = Read Value + Factor
2. Factor = Antenna Factor + Cable Loss - Amplifier
3. The resolution bandwidth of test receiver/spectrum analyzer is 120KHz and video bandwidth is 300kHz for Peak detection and Quasi-peak detection at frequency below 1GHz.
4. According to technical experiences, all spurious emission of 802.11MIMO mode at channel 1,6,11 are almost the same below 1GHz, so that the channel 1 was chosen as representative in final test.
5. The data is worse case.



Power	: AC 120V	Pol/Phase	: HORIZONTAL
Test Mode 2	: 802.11n HT20 (130Mbps), CH1	Temperature	: 25 °C
Memo	:	Humidity	: 59 %

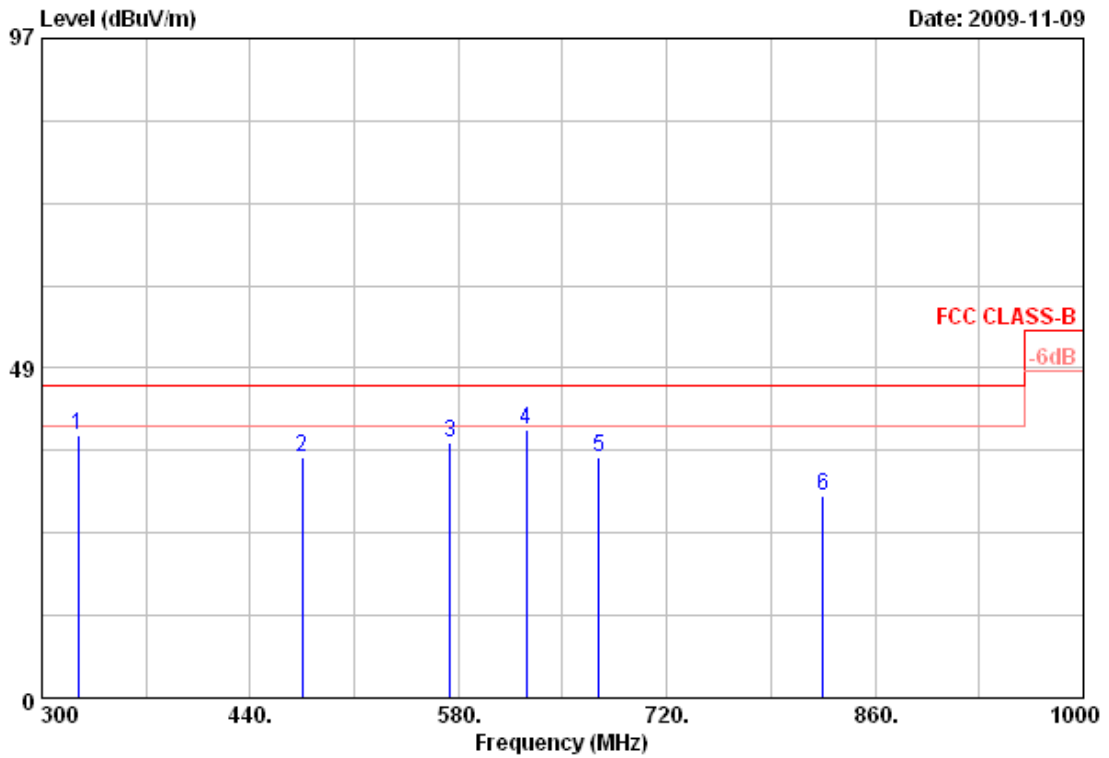

Item	Freq	Read Value	Factor	Result	Limit	Margin	Remark	Ant Pos	Tab Pos
	MHz	dBuV	db/m	dBuV/m	dBuV/m	dB		cm	Deg
1	324.50	50.51	-11.95	38.56	46.00	-7.44	Peak	100	0
2	475.00	40.91	-5.42	35.49	46.00	-10.51	Peak	100	0
3	574.40	40.95	-3.39	37.56	46.00	-8.44	Peak	100	0
4	625.50	40.96	-1.45	39.51	46.00	-6.49	Peak	100	0
5	674.50	39.21	-3.71	35.50	46.00	-10.50	Peak	100	0
6	825.00	28.50	1.34	29.84	46.00	-16.16	Peak	100	0

Notes:

1. Result = Read Value + Factor
2. Factor = Antenna Factor + Cable Loss - Amplifier
3. The resolution bandwidth of test receiver/spectrum analyzer is 120KHz and video bandwidth is 300kHz for Peak detection and Quasi-peak detection at frequency below 1GHz.
4. According to technical experiences, all spurious emission of 802.11MIMO mode at channel 1,6,11 are almost the same below 1GHz, so that the channel 1 was chosen as representative in final test.
5. The data is worse case.



Power	: AC 120V	Pol/Phase	: VERTICAL
Test Mode 2	: 802.11n HT20 (130Mbps), CH1	Temperature	: 26 °C
Memo	:	Humidity	: 58 %

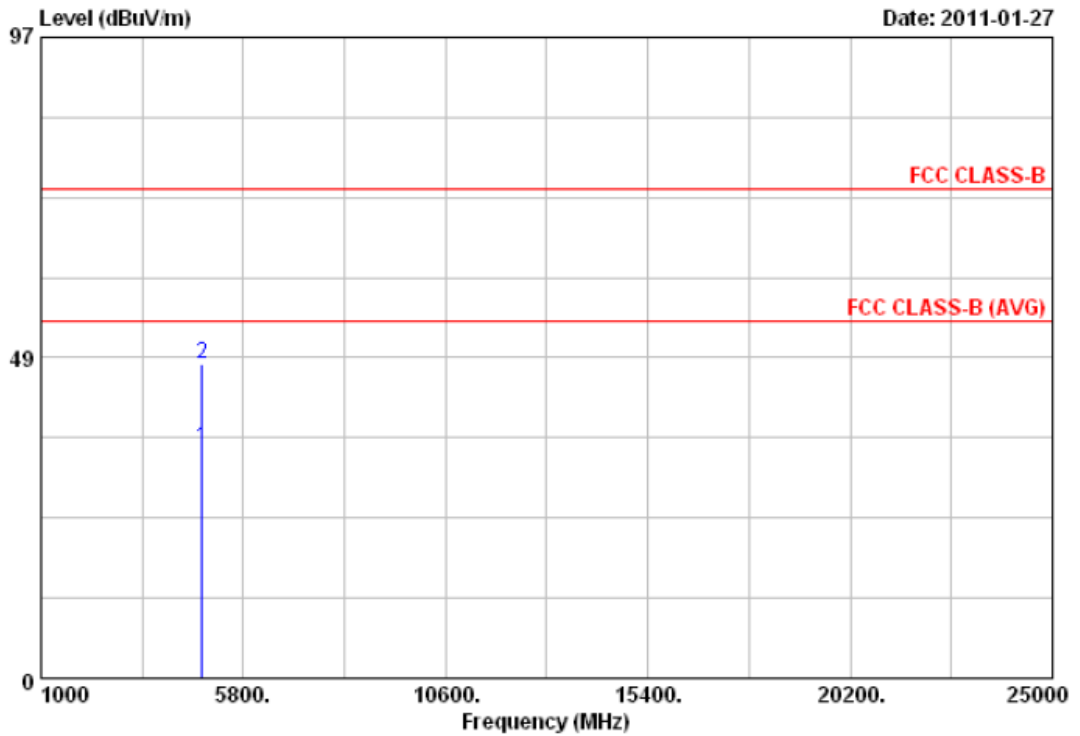

Item	Freq	Read Value	Factor	Result	Limit	Margin	Remark	Ant Pos	Tab Pos
	MHz	dBuV	dB/m	dBuV/m	dBuV/m	dB		cm	Deg
1	4824.00	32.02	2.72	34.74	54.00	-19.26	Average	100	0
2	4824.00	44.70	2.72	47.42	74.00	-26.58	Peak	100	0

Notes:

1. Result = Read Value + Factor
2. Factor = Antenna Factor + Cable Loss - Amplifier
3. The resolution bandwidth of test receiver/spectrum analyzer is 120KHz and video bandwidth is 300kHz for Peak detection and Quasi-peak detection at frequency below 1GHz.
4. The resolution bandwidth of test receiver/spectrum analyzer is 1MHz and video bandwidth is 3MHz for Peak detection at frequency above 1GHz.
5. The resolution bandwidth of test receiver/spectrum analyzer is 1MHz and video bandwidth is 10Hz for Average detection at frequency above 1GHz.
6. The other emissions is too low to be measured.
7. The data is worse case.



Power	: AC 120V	Pol/Phase	: HORIZONTAL
Test Mode 2	: 802.11n HT20 (130Mbps), CH1	Temperature	: 26 °C
Memo	:	Humidity	: 58 %

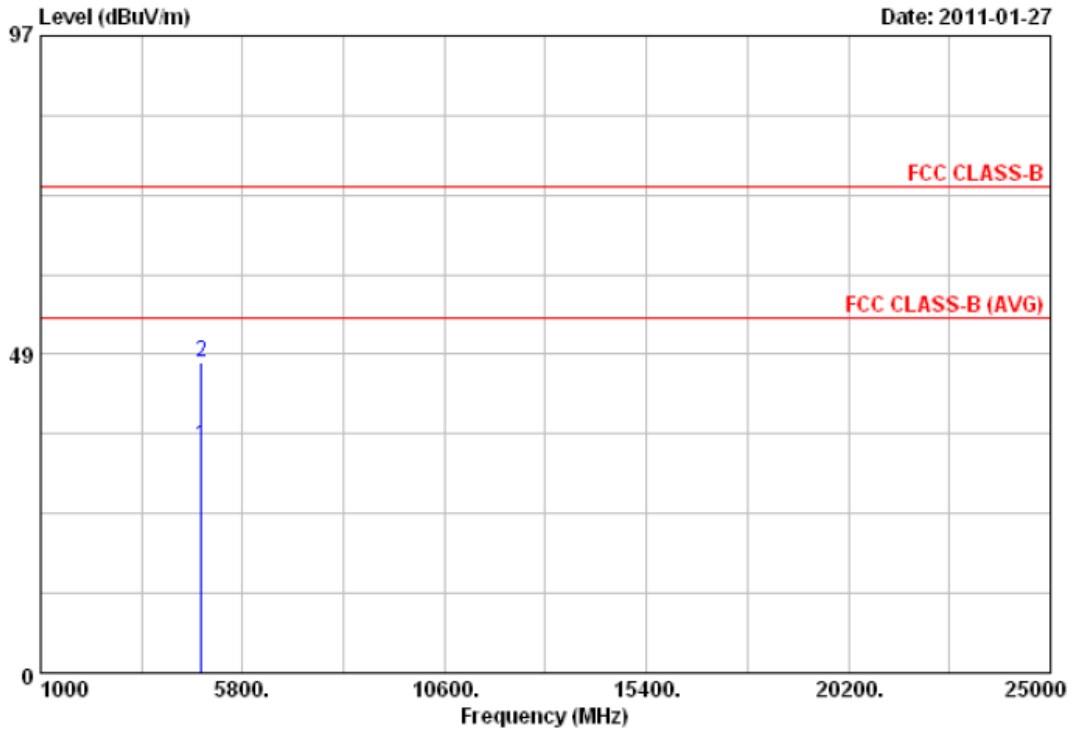

Item	Freq	Read Value	Factor	Result	Limit	Margin	Remark	Ant Pos	Tab Pos
	MHz	dBuV	dB/m	dBuV/m	dBuV/m	dB		cm	Deg
1	4824.00	31.82	2.72	34.54	54.00	-19.46	Average	100	0
2	4824.00	44.66	2.72	47.38	74.00	-26.62	Peak	100	0

Notes:

1. Result = Read Value + Factor
2. Factor = Antenna Factor + Cable Loss - Amplifier
3. The resolution bandwidth of test receiver/spectrum analyzer is 120KHz and video bandwidth is 300kHz for Peak detection and Quasi-peak detection at frequency below 1GHz.
4. The resolution bandwidth of test receiver/spectrum analyzer is 1MHz and video bandwidth is 3MHz for Peak detection at frequency above 1GHz.
5. The resolution bandwidth of test receiver/spectrum analyzer is 1MHz and video bandwidth is 10Hz for Average detection at frequency above 1GHz.
6. The other emissions is too low to be measured.
7. The data is worse case.



Power	: AC 120V	Pol/Phase	: VERTICAL
Test Mode 2	: 802.11n HT20 (130Mbps), CH6	Temperature	: 26 °C
Memo	:	Humidity	: 58 %

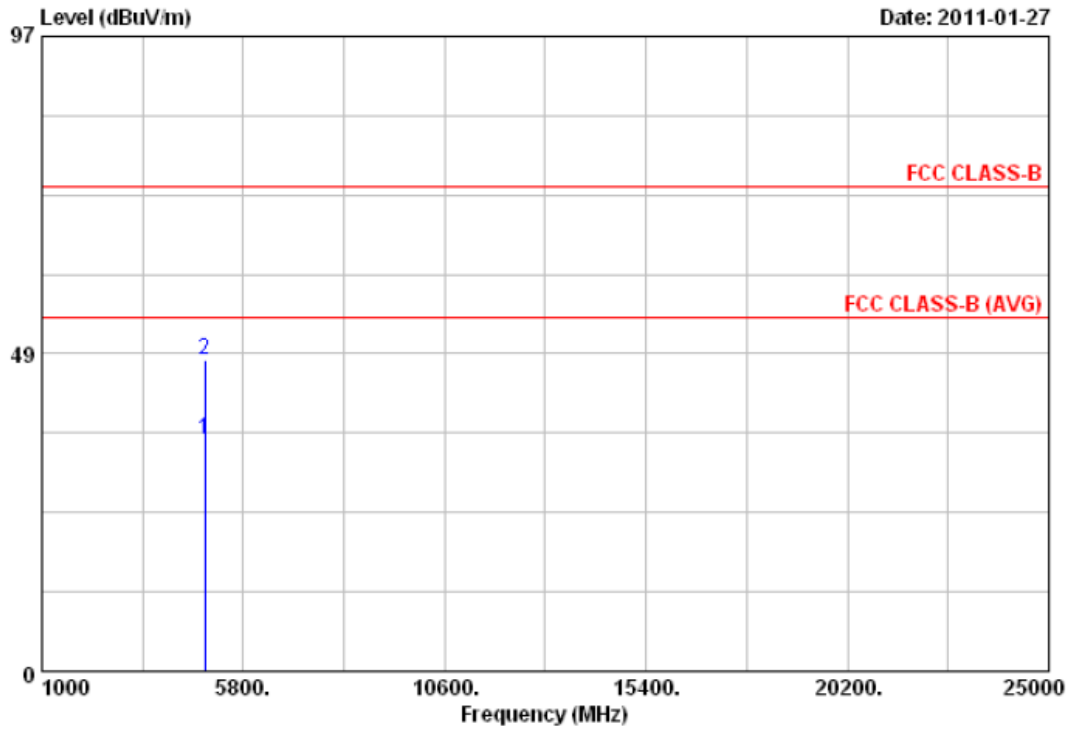

Item	Freq	Read Value	Factor	Result	Limit	Margin	Remark	Ant Pos	Tab Pos
	MHz	dBuV	dB/m	dBuV/m	dBuV/m	dB		cm	Deg
1	4874.00	32.66	2.87	35.53	54.00	-18.47	Average	100	0
2	4874.00	44.64	2.87	47.51	74.00	-26.49	Peak	100	0

Notes:

1. Result = Read Value + Factor
2. Factor = Antenna Factor + Cable Loss - Amplifier
3. The resolution bandwidth of test receiver/spectrum analyzer is 120KHz and video bandwidth is 300kHz for Peak detection and Quasi-peak detection at frequency below 1GHz.
4. The resolution bandwidth of test receiver/spectrum analyzer is 1MHz and video bandwidth is 3MHz for Peak detection at frequency above 1GHz.
5. The resolution bandwidth of test receiver/spectrum analyzer is 1MHz and video bandwidth is 10Hz for Average detection at frequency above 1GHz.
6. The other emissions is too low to be measured.
7. The data is worse case.



Power	: AC 120V	Pol/Phase	: HORIZONTAL
Test Mode 2	: 802.11n HT20 (130Mbps), CH6	Temperature	: 26 °C
Memo	:	Humidity	: 58 %

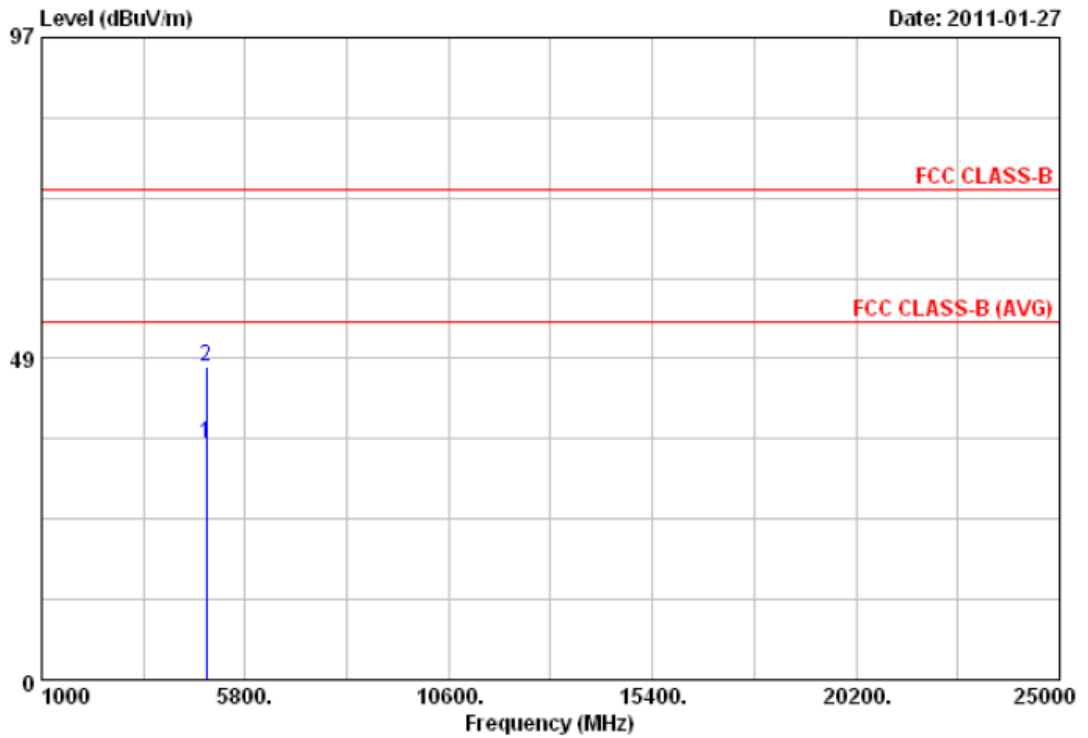

Item	Freq	Read Value	Factor	Result	Limit	Margin	Remark	Ant Pos	Tab Pos
	MHz	dBuV	dB/m	dBuV/m	dBuV/m	dB		cm	Deg
1	4874.00	32.75	2.87	35.62	54.00	-18.38	Average	100	0
2	4874.00	44.42	2.87	47.29	74.00	-26.71	Peak	100	0

Notes:

1. Result = Read Value + Factor
2. Factor = Antenna Factor + Cable Loss - Amplifier
3. The resolution bandwidth of test receiver/spectrum analyzer is 120KHz and video bandwidth is 300kHz for Peak detection and Quasi-peak detection at frequency below 1GHz.
4. The resolution bandwidth of test receiver/spectrum analyzer is 1MHz and video bandwidth is 3MHz for Peak detection at frequency above 1GHz.
5. The resolution bandwidth of test receiver/spectrum analyzer is 1MHz and video bandwidth is 10Hz for Average detection at frequency above 1GHz.
6. The other emissions is too low to be measured.
7. The data is worse case.



Power	: AC 120V	Pol/Phase	: VERTICAL
Test Mode 2	: 802.11n HT20 (130Mbps), CH11	Temperature	: 26 °C
Memo	:	Humidity	: 58 %

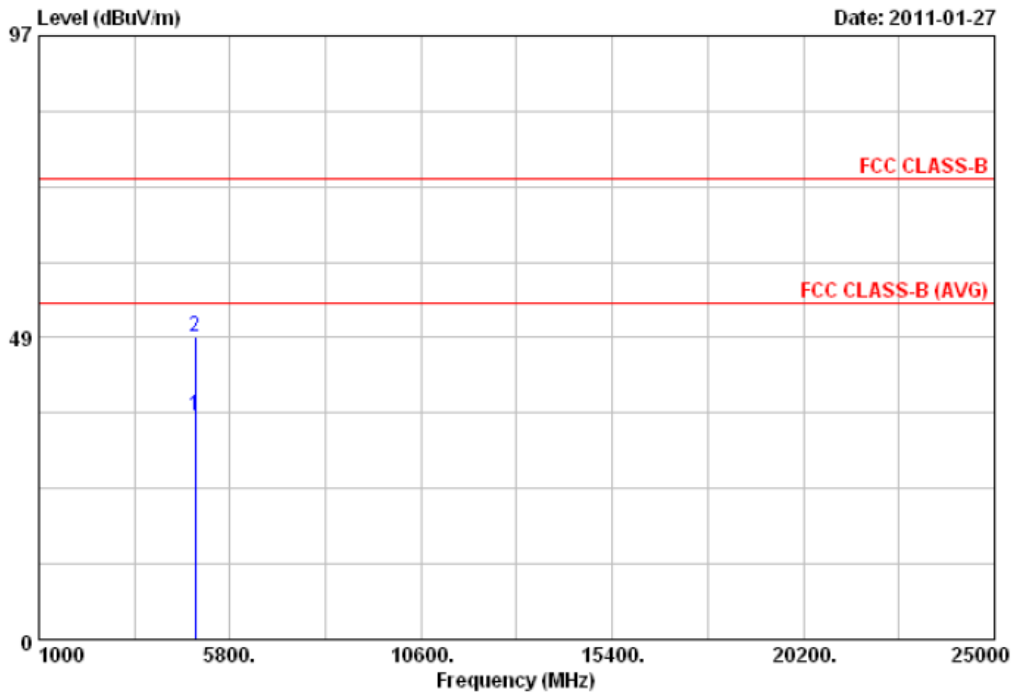

Item	Freq	Read Value	Factor	Result	Limit	Margin	Remark	Ant Pos	Tab Pos
	MHz	dBuV	dB/m	dBuV/m	dBuV/m	dB		cm	Deg
1	4924.00	32.82	3.01	35.83	54.00	-18.17	Average	100	0
2	4924.00	45.68	3.01	48.69	74.00	-25.31	Peak	100	0

Notes:

1. Result = Read Value + Factor
2. Factor = Antenna Factor + Cable Loss - Amplifier
3. The resolution bandwidth of test receiver/spectrum analyzer is 120KHz and video bandwidth is 300kHz for Peak detection and Quasi-peak detection at frequency below 1GHz.
4. The resolution bandwidth of test receiver/spectrum analyzer is 1MHz and video bandwidth is 3MHz for Peak detection at frequency above 1GHz.
5. The resolution bandwidth of test receiver/spectrum analyzer is 1MHz and video bandwidth is 10Hz for Average detection at frequency above 1GHz.
6. The other emissions is too low to be measured.
7. The data is worse case.



Power	: AC 120V	Pol/Phase	: HORIZONTAL
Test Mode 2	: 802.11n HT20 (130Mbps), CH11	Temperature	: 26 °C
Memo	:	Humidity	: 58 %

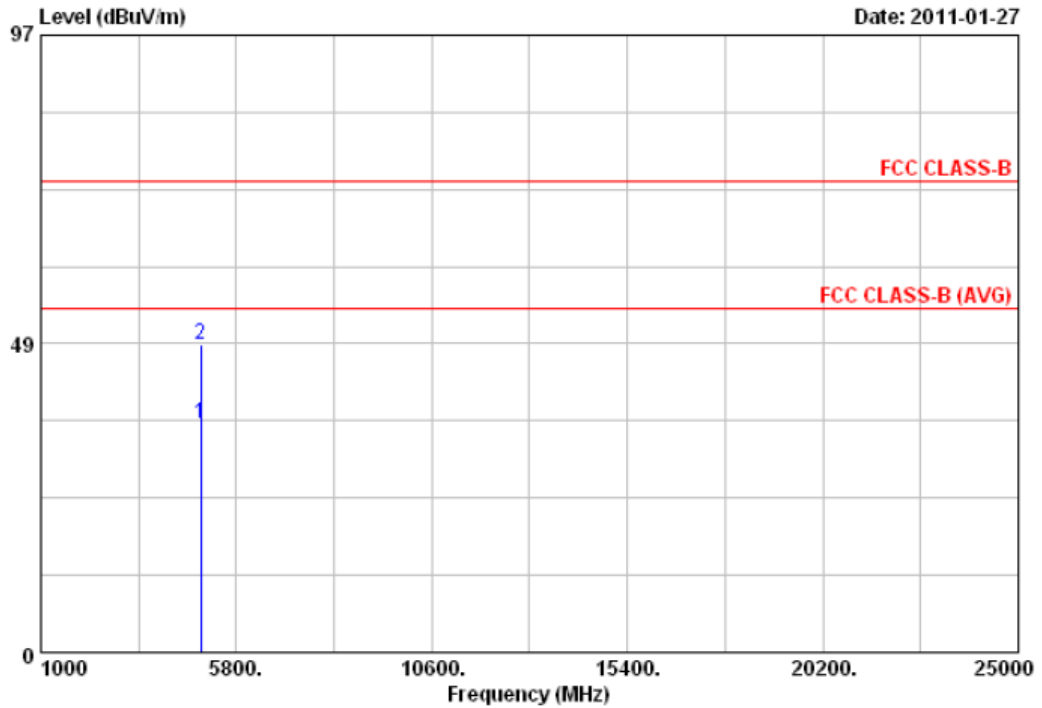

Item	Freq	Read Value	Factor	Result	Limit	Margin	Remark	Ant Pos	Tab Pos
	MHz	dBuV	dB/m	dBuV/m	dBuV/m	dB		cm	Deg
1	4924.00	32.90	3.01	35.91	54.00	-18.09	Average	100	0
2	4924.00	45.42	3.01	48.43	74.00	-25.57	Peak	100	0

Notes:

1. Result = Read Value + Factor
2. Factor = Antenna Factor + Cable Loss - Amplifier
3. The resolution bandwidth of test receiver/spectrum analyzer is 120KHz and video bandwidth is 300kHz for Peak detection and Quasi-peak detection at frequency below 1GHz.
4. The resolution bandwidth of test receiver/spectrum analyzer is 1MHz and video bandwidth is 3MHz for Peak detection at frequency above 1GHz.
5. The resolution bandwidth of test receiver/spectrum analyzer is 1MHz and video bandwidth is 10Hz for Average detection at frequency above 1GHz.
6. The other emissions is too low to be measured.
7. The data is worse case.



Power	: AC 120V	Pol/Phase	: VERTICAL
Test Mode 3	: 802.11n HT40 (270Mbps), CH3	Temperature	: 25 °C
Memo	:	Humidity	: 59 %

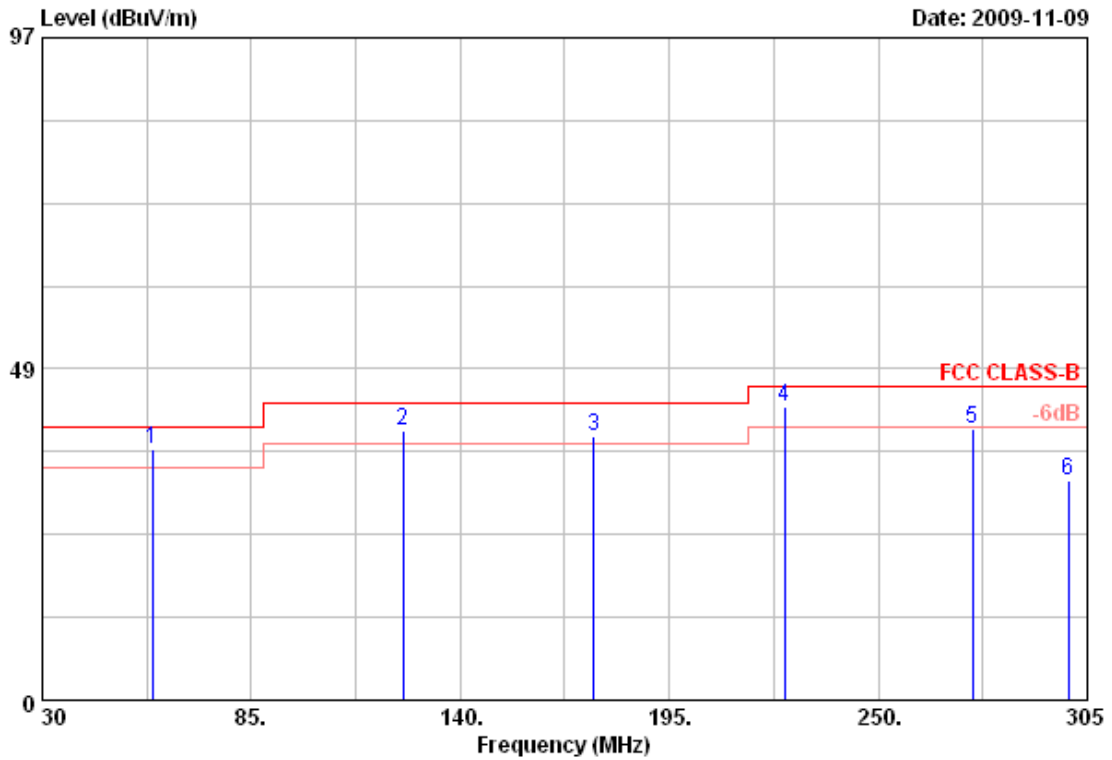

Item	Freq	Read Value	Factor	Result	Limit	Margin	Remark	Ant Pos	Tab Pos
	MHz	dBuV	dB/m	dBuV/m	dBuV/m	dB		cm	Deg
1	58.88	49.55	-12.68	36.87	40.00	-3.13	QP	100	0
2	124.88	48.99	-9.43	39.56	43.50	-3.94	QP	100	0
3	175.20	50.45	-11.89	38.56	43.50	-4.94	QP	100	0
4	225.25	53.31	-10.44	42.87	46.00	-3.13	QP	100	0
5	274.75	52.40	-12.69	39.71	46.00	-6.29	QP	100	0
6	300.05	44.07	-12.01	32.06	46.00	-13.94	Peak	100	0

Notes:

1. Result = Read Value + Factor
2. Factor = Antenna Factor + Cable Loss - Amplifier
3. The resolution bandwidth of test receiver/spectrum analyzer is 120KHz and video bandwidth is 300kHz for Peak detection and Quasi-peak detection at frequency below 1GHz.
4. According to technical experiences, all spurious emission of 802.11MIMO mode at channel 3,6,9 are almost the same below 1GHz, so that the channel 3 was chosen as representative in final test.
5. The data is worse case.



Power	: AC 120V	Pol/Phase	: VERTICAL
Test Mode 3	: 802.11n HT40 (270Mbps), CH3	Temperature	: 25 °C
Memo	:	Humidity	: 59 %

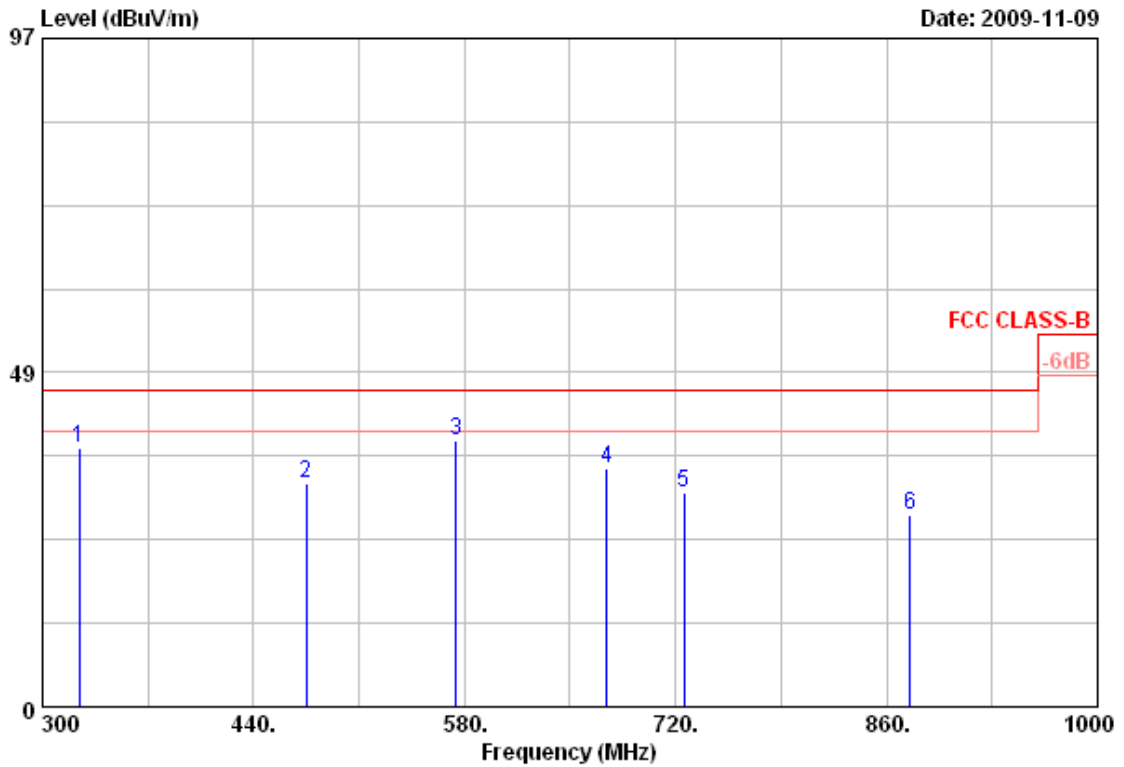

Item	Freq	Read Value	Factor	Result	Limit	Margin	Remark	Ant Pos	Tab Pos
	MHz	dBuV	dB/m	dBuV/m	dBuV/m	dB		cm	Deg
1	324.50	47.34	-9.78	37.56	46.00	-8.44	Peak	100	0
2	475.00	40.80	-8.25	32.55	46.00	-13.45	Peak	100	0
3	574.40	41.94	-3.43	38.51	46.00	-7.49	Peak	100	0
4	674.50	39.71	-5.15	34.56	46.00	-11.44	Peak	100	0
5	725.60	32.11	-1.09	31.02	46.00	-14.98	Peak	100	0
6	875.40	27.09	0.75	27.84	46.00	-18.16	Peak	100	0

Notes:

1. Result = Read Value + Factor
2. Factor = Antenna Factor + Cable Loss - Amplifier
3. The resolution bandwidth of test receiver/spectrum analyzer is 120KHz and video bandwidth is 300kHz for Peak detection and Quasi-peak detection at frequency below 1GHz.
4. According to technical experiences, all spurious emission of 802.11MIMO mode at channel 3,6,9 are almost the same below 1GHz, so that the channel 3 was chosen as representative in final test.
5. The data is worse case.



Power	: AC 120V	Pol/Phase	: HORIZONTAL
Test Mode 3	: 802.11n HT40 (270Mbps), CH3	Temperature	: 25 °C
Memo	:	Humidity	: 59 %

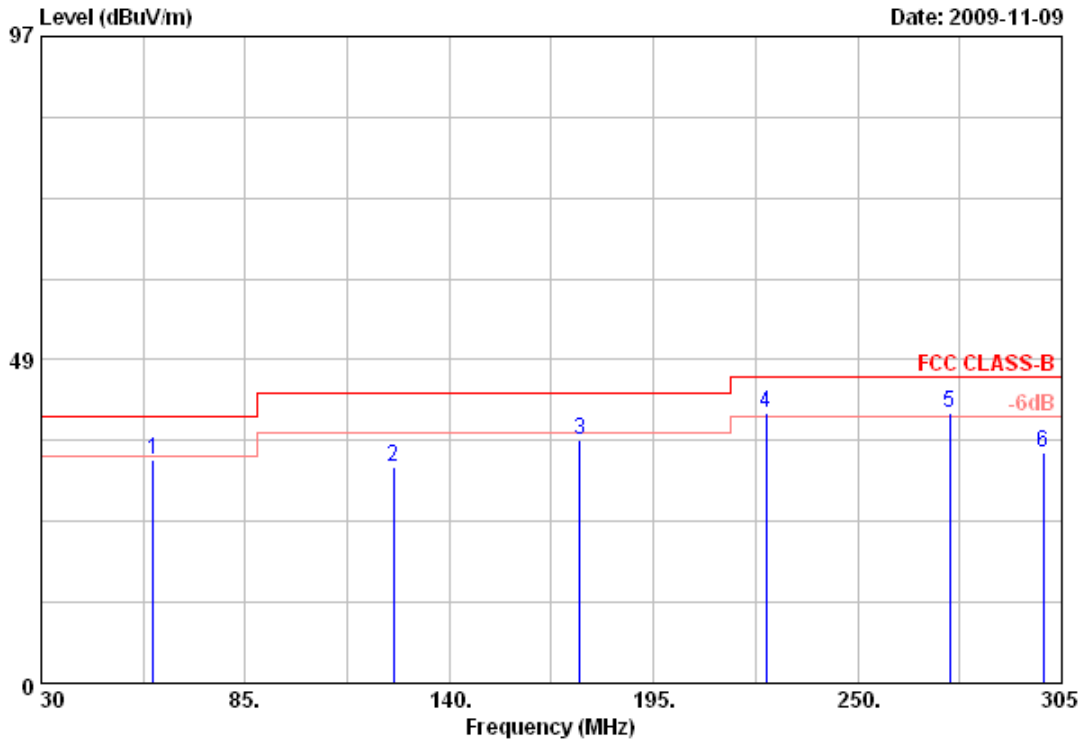

Item	Freq	Read Value	Factor	Result	Limit	Margin	Remark	Ant Pos	Tab Pos
	MHz	dBuV	dB/m	dBuV/m	dBuV/m	dB		cm	Deg
1	60.25	52.38	-18.87	33.51	40.00	-6.49	Peak	100	0
2	124.88	49.21	-16.67	32.54	43.50	-10.96	Peak	100	0
3	175.20	53.72	-17.16	36.56	43.50	-6.94	Peak	100	0
4	225.25	55.79	-15.23	40.56	46.00	-5.44	QP	100	0
5	274.75	53.72	-13.18	40.54	46.00	-5.46	QP	100	0
6	300.05	47.52	-13.01	34.51	46.00	-11.49	Peak	100	0

Notes:

1. Result = Read Value + Factor
2. Factor = Antenna Factor + Cable Loss - Amplifier
3. The resolution bandwidth of test receiver/spectrum analyzer is 120KHz and video bandwidth is 300kHz for Peak detection and Quasi-peak detection at frequency below 1GHz.
4. According to technical experiences, all spurious emission of 802.11MIMO mode at channel 3,6,9 are almost the same below 1GHz, so that the channel 3 was chosen as representative in final test.
5. The data is worse case.



Power	: AC 120V	Pol/Phase	: HORIZONTAL
Test Mode 3	: 802.11n HT40 (270Mbps), CH3	Temperature	: 25 °C
Memo	:	Humidity	: 59 %

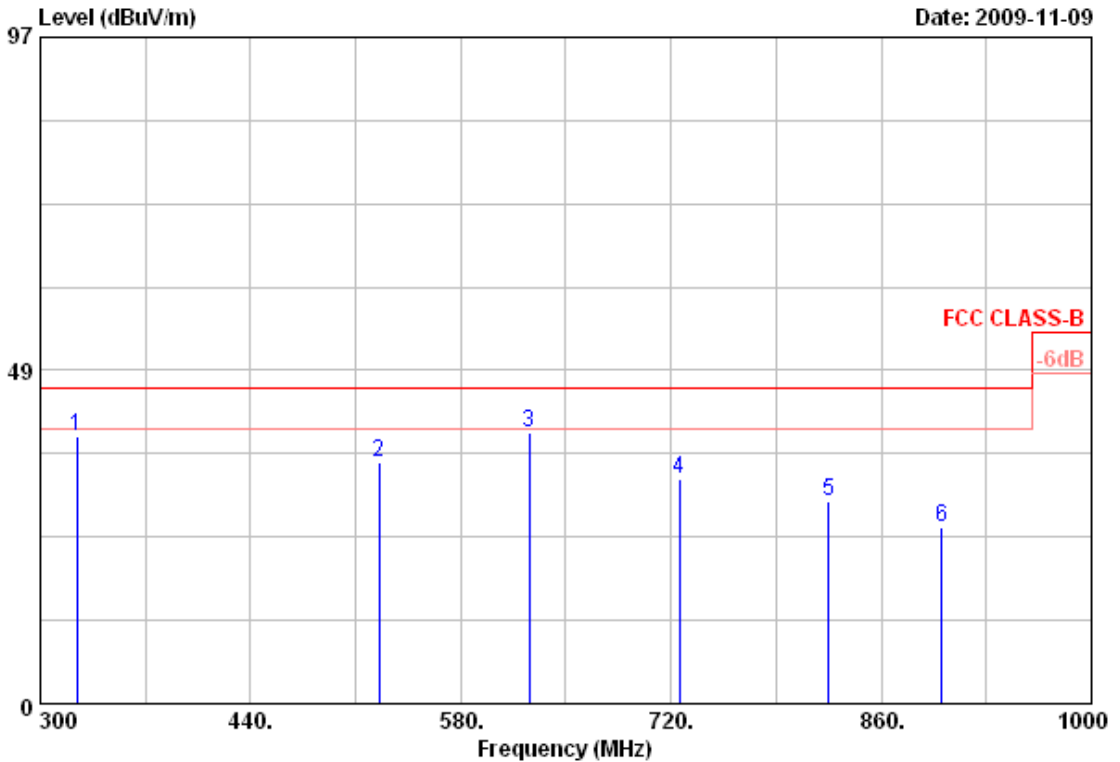

Item	Freq	Read Value	Factor	Result	Limit	Margin	Remark	Ant Pos	Tab Pos
	MHz	dBuV	dB/m	dBuV/m	dBuV/m	dB		cm	Deg
1	324.50	50.91	-11.95	38.96	46.00	-7.04	Peak	100	0
2	525.40	41.09	-5.86	35.23	46.00	-10.77	Peak	100	0
3	625.50	40.96	-1.45	39.51	46.00	-6.49	Peak	100	0
4	725.60	35.51	-2.76	32.75	46.00	-13.25	Peak	100	0
5	825.00	28.22	1.34	29.56	46.00	-16.44	Peak	100	0
6	900.60	24.00	1.54	25.54	46.00	-20.46	Peak	100	0

Notes:

1. Result = Read Value + Factor
2. Factor = Antenna Factor + Cable Loss - Amplifier
3. The resolution bandwidth of test receiver/spectrum analyzer is 120KHz and video bandwidth is 300kHz for Peak detection and Quasi-peak detection at frequency below 1GHz.
4. According to technical experiences, all spurious emission of 802.11MIMO mode at channel 3,6,9 are almost the same below 1GHz, so that the channel 3 was chosen as representative in final test.
5. The data is worse case.



Power	: AC 120V	Pol/Phase	: VERTICAL
Test Mode 3	: 802.11n HT40 (270Mbps), CH3	Temperature	: 26 °C
Memo	:	Humidity	: 58 %

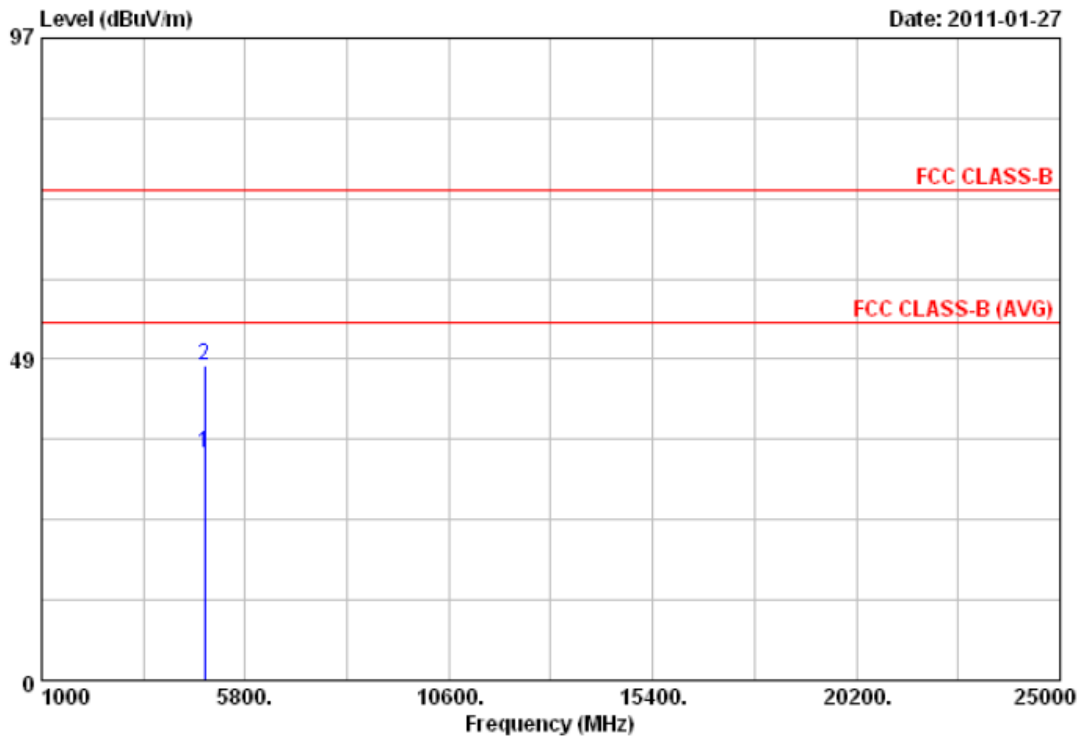

Item	Freq	Read Value	Factor	Result	Limit	Margin	Remark	Ant Pos	Tab Pos
	MHz	dBuV	dB/m	dBuV/m	dBuV/m	dB		cm	Deg
1	4844.00	31.63	2.79	34.42	54.00	-19.58	Average	100	0
2	4844.00	44.82	2.79	47.61	74.00	-26.39	Peak	100	0

Notes:

1. Result = Read Value + Factor
2. Factor = Antenna Factor + Cable Loss - Amplifier
3. The resolution bandwidth of test receiver/spectrum analyzer is 120KHz and video bandwidth is 300kHz for Peak detection and Quasi-peak detection at frequency below 1GHz.
4. The resolution bandwidth of test receiver/spectrum analyzer is 1MHz and video bandwidth is 3MHz for Peak detection at frequency above 1GHz.
5. The resolution bandwidth of test receiver/spectrum analyzer is 1MHz and video bandwidth is 10Hz for Average detection at frequency above 1GHz.
6. The other emissions is too low to be measured.
7. The data is worse case.



Power	: AC 120V	Pol/Phase	: HORIZONTAL
Test Mode 3	: 802.11n HT40 (270Mbps), CH3	Temperature	: 26 °C
Memo	:	Humidity	: 58 %

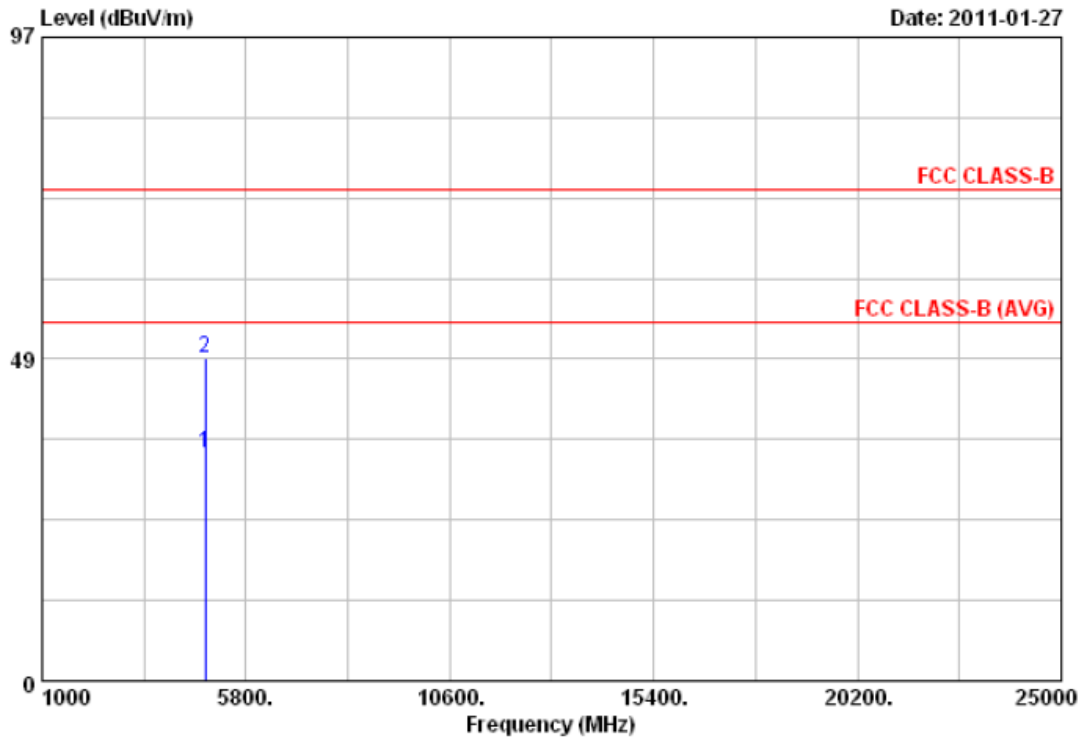

Item	Freq	Read Value	Factor	Result	Limit	Margin	Remark	Ant Pos	Tab Pos
	MHz	dBuV	dB/m	dBuV/m	dBuV/m	dB		cm	Deg
1	4844.00	31.51	2.79	34.30	54.00	-19.70	Average	100	0
2	4844.00	45.77	2.79	48.56	74.00	-25.44	Peak	100	0

Notes:

1. Result = Read Value + Factor
2. Factor = Antenna Factor + Cable Loss - Amplifier
3. The resolution bandwidth of test receiver/spectrum analyzer is 120KHz and video bandwidth is 300kHz for Peak detection and Quasi-peak detection at frequency below 1GHz.
4. The resolution bandwidth of test receiver/spectrum analyzer is 1MHz and video bandwidth is 3MHz for Peak detection at frequency above 1GHz.
5. The resolution bandwidth of test receiver/spectrum analyzer is 1MHz and video bandwidth is 10Hz for Average detection at frequency above 1GHz.
6. The other emissions is too low to be measured.
7. The data is worse case.



Power	: AC 120V	Pol/Phase	: VERTICAL
Test Mode 3	: 802.11n HT40 (270Mbps), CH6	Temperature	: 26 °C
Memo	:	Humidity	: 58 %

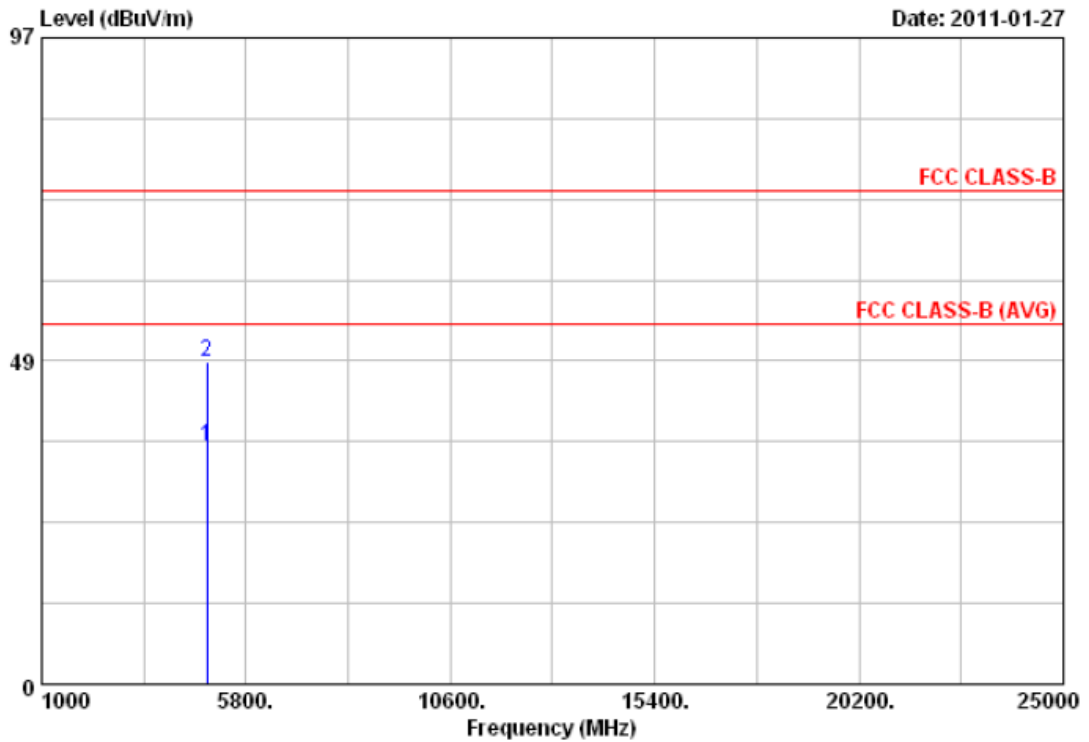

Item	Freq	Read Value	Factor	Result	Limit	Margin	Remark	Ant Pos	Tab Pos
	MHz	dBuV	dB/m	dBuV/m	dBuV/m	dB		cm	Deg
1	4874.00	32.90	2.87	35.77	54.00	-18.23	Average	100	0
2	4874.00	45.48	2.87	48.35	74.00	-25.65	Peak	100	0

Notes:

1. Result = Read Value + Factor
2. Factor = Antenna Factor + Cable Loss - Amplifier
3. The resolution bandwidth of test receiver/spectrum analyzer is 120KHz and video bandwidth is 300kHz for Peak detection and Quasi-peak detection at frequency below 1GHz.
4. The resolution bandwidth of test receiver/spectrum analyzer is 1MHz and video bandwidth is 3MHz for Peak detection at frequency above 1GHz.
5. The resolution bandwidth of test receiver/spectrum analyzer is 1MHz and video bandwidth is 10Hz for Average detection at frequency above 1GHz.
6. The other emissions is too low to be measured.
7. The data is worse case.



Power	: AC 120V	Pol/Phase	: HORIZONTAL
Test Mode 3	: 802.11n HT40 (270Mbps), CH6	Temperature	: 26 °C
Memo	:	Humidity	: 58 %

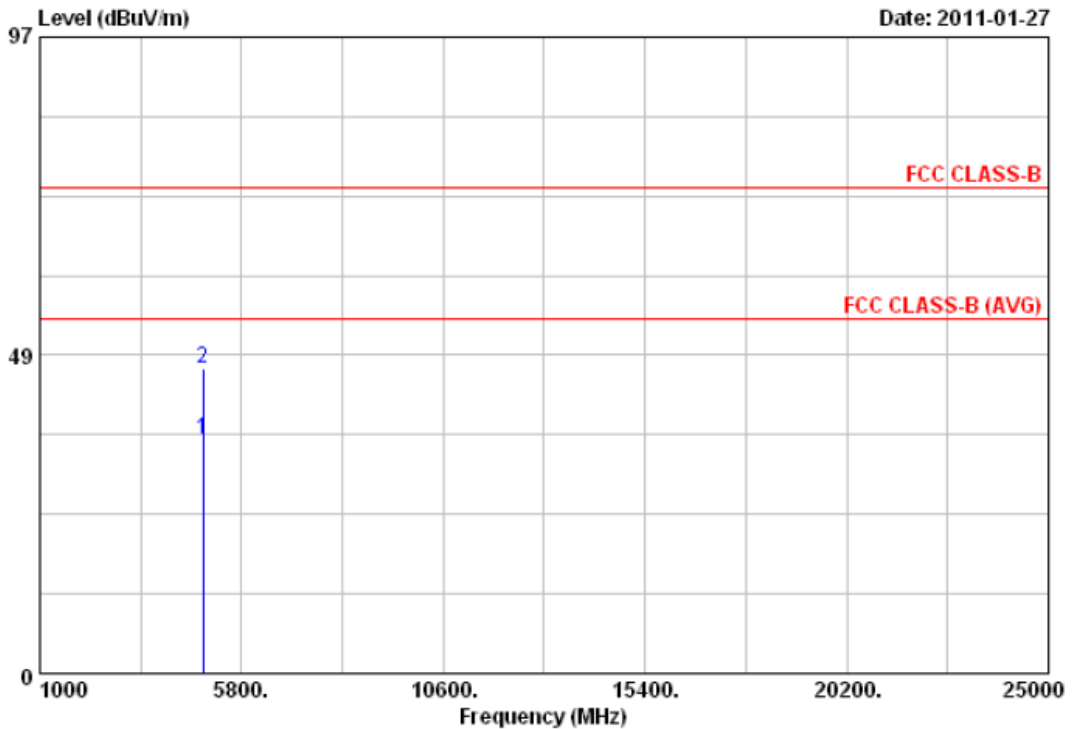

Item	Freq	Read Value	Factor	Result	Limit	Margin	Remark	Ant Pos	Tab Pos
	MHz	dBuV	dB/m	dBuV/m	dBuV/m	dB		cm	Deg
1	4874.00	32.87	2.87	35.74	54.00	-18.26	Average	100	0
2	4874.00	43.67	2.87	46.54	74.00	-27.46	Peak	100	0

Notes:

1. Result = Read Value + Factor
2. Factor = Antenna Factor + Cable Loss - Amplifier
3. The resolution bandwidth of test receiver/spectrum analyzer is 120KHz and video bandwidth is 300kHz for Peak detection and Quasi-peak detection at frequency below 1GHz.
4. The resolution bandwidth of test receiver/spectrum analyzer is 1MHz and video bandwidth is 3MHz for Peak detection at frequency above 1GHz.
5. The resolution bandwidth of test receiver/spectrum analyzer is 1MHz and video bandwidth is 10Hz for Average detection at frequency above 1GHz.
6. The other emissions is too low to be measured.
7. The data is worse case.



Power	: AC 120V	Pol/Phase	: VERTICAL
Test Mode 3	: 802.11n HT40 (270Mbps), CH9	Temperature	: 26 °C
Memo	:	Humidity	: 58 %

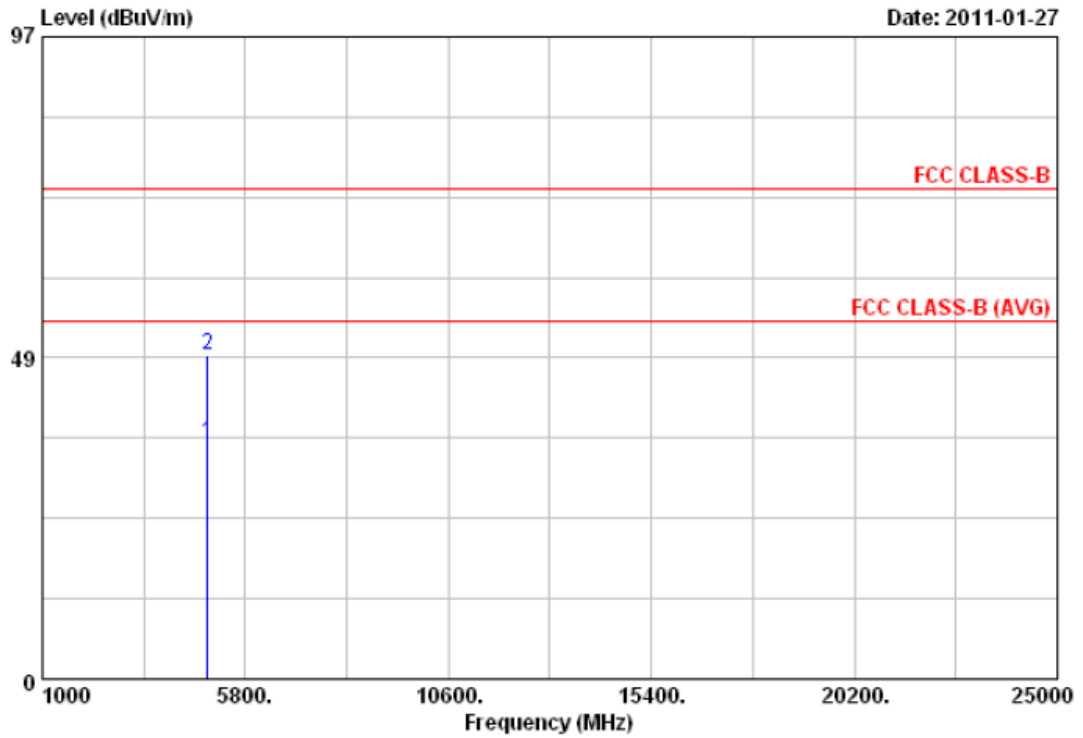

Item	Freq	Read Value	Factor	Result	Limit	Margin	Remark	Ant Pos	Tab Pos
	MHz	dBuV	dB/m	dBuV/m	dBuV/m	dB		cm	Deg
1	4904.00	32.70	2.96	35.66	54.00	-18.34	Average	100	0
2	4904.00	45.89	2.96	48.85	74.00	-25.15	Peak	100	0

Notes:

1. Result = Read Value + Factor
2. Factor = Antenna Factor + Cable Loss - Amplifier
3. The resolution bandwidth of test receiver/spectrum analyzer is 120KHz and video bandwidth is 300kHz for Peak detection and Quasi-peak detection at frequency below 1GHz.
4. The resolution bandwidth of test receiver/spectrum analyzer is 1MHz and video bandwidth is 3MHz for Peak detection at frequency above 1GHz.
5. The resolution bandwidth of test receiver/spectrum analyzer is 1MHz and video bandwidth is 10Hz for Average detection at frequency above 1GHz.
6. The other emissions is too low to be measured.
7. The data is worse case.



Power	: AC 120V	Pol/Phase	: HORIZONTAL
Test Mode 3	: 802.11n HT40 (270Mbps), CH9	Temperature	: 26 °C
Memo	:	Humidity	: 58 %

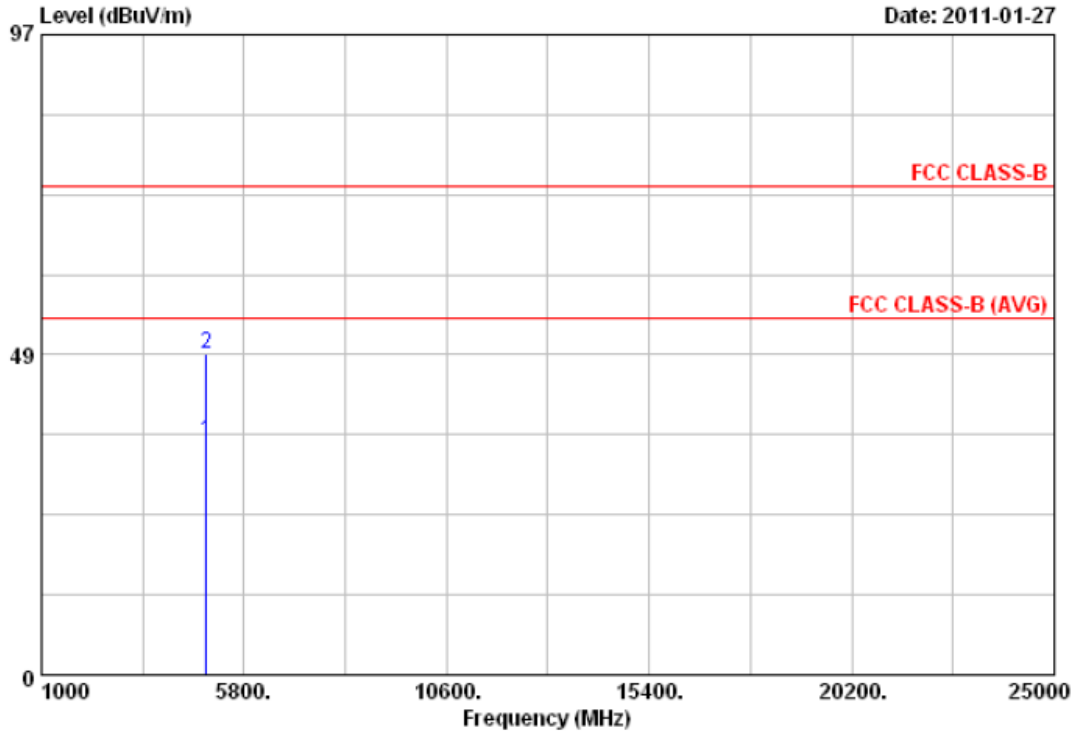

Item	Freq	Read Value	Factor	Result	Limit	Margin	Remark	Ant Pos	Tab Pos
	MHz	dBuV	dB/m	dBuV/m	dBuV/m	dB		cm	Deg
1	4904.00	32.51	2.96	35.47	54.00	-18.53	Average	100	0
2	4904.00	45.79	2.96	48.75	74.00	-25.25	Peak	100	0

Notes:

1. Result = Read Value + Factor
2. Factor = Antenna Factor + Cable Loss - Amplifier
3. The resolution bandwidth of test receiver/spectrum analyzer is 120KHz and video bandwidth is 300kHz for Peak detection and Quasi-peak detection at frequency below 1GHz.
4. The resolution bandwidth of test receiver/spectrum analyzer is 1MHz and video bandwidth is 3MHz for Peak detection at frequency above 1GHz.
5. The resolution bandwidth of test receiver/spectrum analyzer is 1MHz and video bandwidth is 10Hz for Average detection at frequency above 1GHz.
6. The other emissions is too low to be measured.
7. The data is worse case.

Test engineer: Ben



6. 6dB Bandwidth Measurement Data

6.1 Test Limit

The minimum of 6dB Bandwidth Measurement is 0.5 MHz.

6.2 Test Procedures

The EUT was tested according to DTS test procedure of KDB558074 for compliance to FCC 47CFR 15.247 requirements.

- a. The transmitter output was connected to the spectrum analyzer.
- b. Set RBW = 100 kHz, Span greater than RBW.
- c. The 6 dB bandwidth is defined as the total spectrum the power of which is higher than peak power minus 6 dB.

6.3 Test Setup Layout

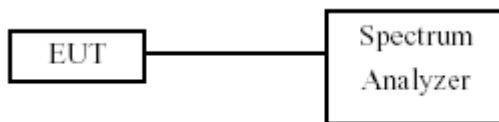

6.4 Measurement Equipment

Instrument/Ancillary	Model No.	Manufacturer	Serial No.	Calibration Date	Valid Date
Spectrum Analyzer	FSP40	R&S	10047	2010/05/08	2011/05/07

6.5 Test Result and Data

Test Date: Jan. 27, 2011

Temperature: 22

Atmospheric pressure: 1022 hPa

Humidity: 65%

Modulation Standard	Channel	Frequency (MHz)	6dB Bandwidth (MHz)	
			Ant1	Ant2
802.11b (11Mbps)	01	2412	12.00	12.00
	06	2437	12.10	12.00
	11	2462	12.10	12.10
802.11g (54Mbps)	01	2412	16.50	16.60
	06	2437	16.60	16.60
	11	2462	16.80	16.60
802.11n HT20 (130Mbps)	01	2412	17.20	17.30
	06	2437	17.60	17.60
	11	2462	17.40	17.50
802.11n HT40 (270Mbps)	03	2422	36.40	35.40
	06	2437	35.40	35.80
	09	2452	36.20	36.40



Modulation Standard: 802.11b (11Mbps), Ant1
Channel: 01

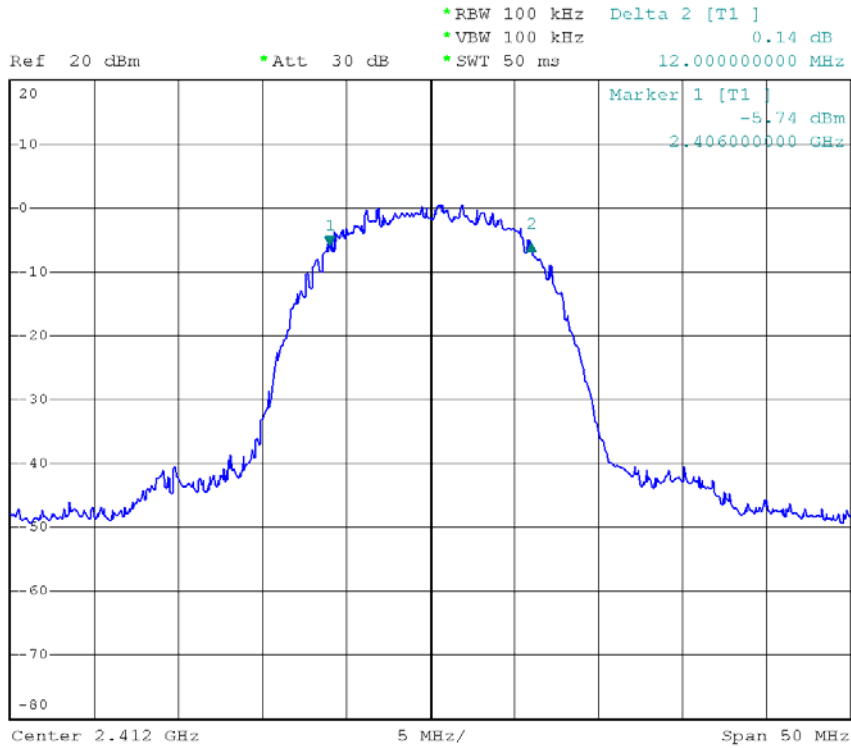

Modulation Standard: 802.11b (11Mbps), Ant1
Channel: 06

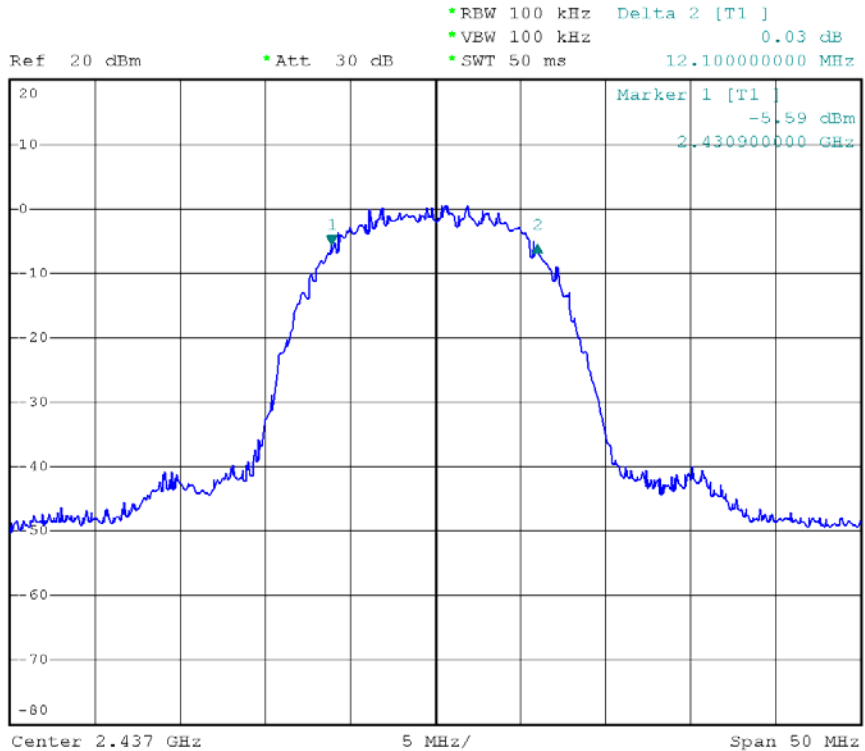



Modulation Standard: 802.11b (11Mbps), Ant1
Channel: 11

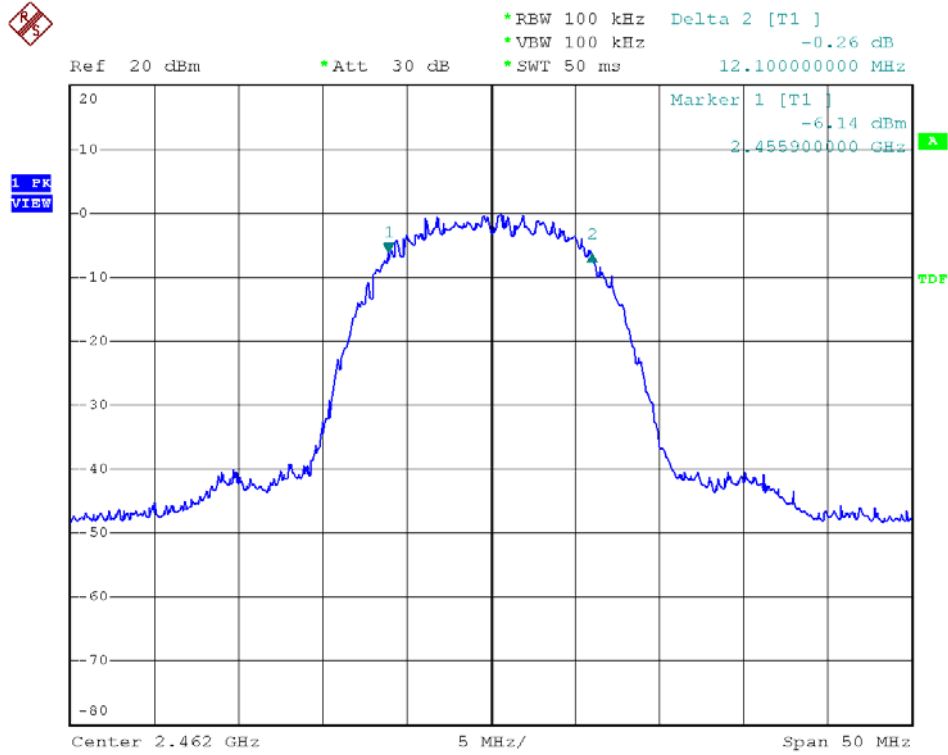

Modulation Standard: 802.11b (11Mbps), Ant2
Channel: 01

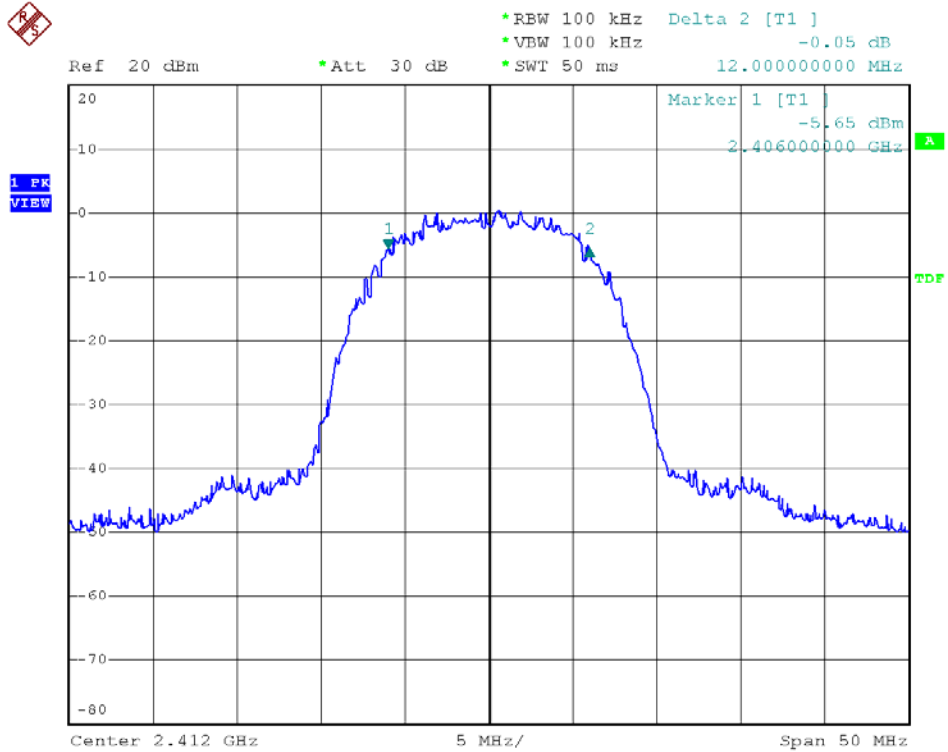



Modulation Standard: 802.11b (11Mbps), Ant2
Channel: 06

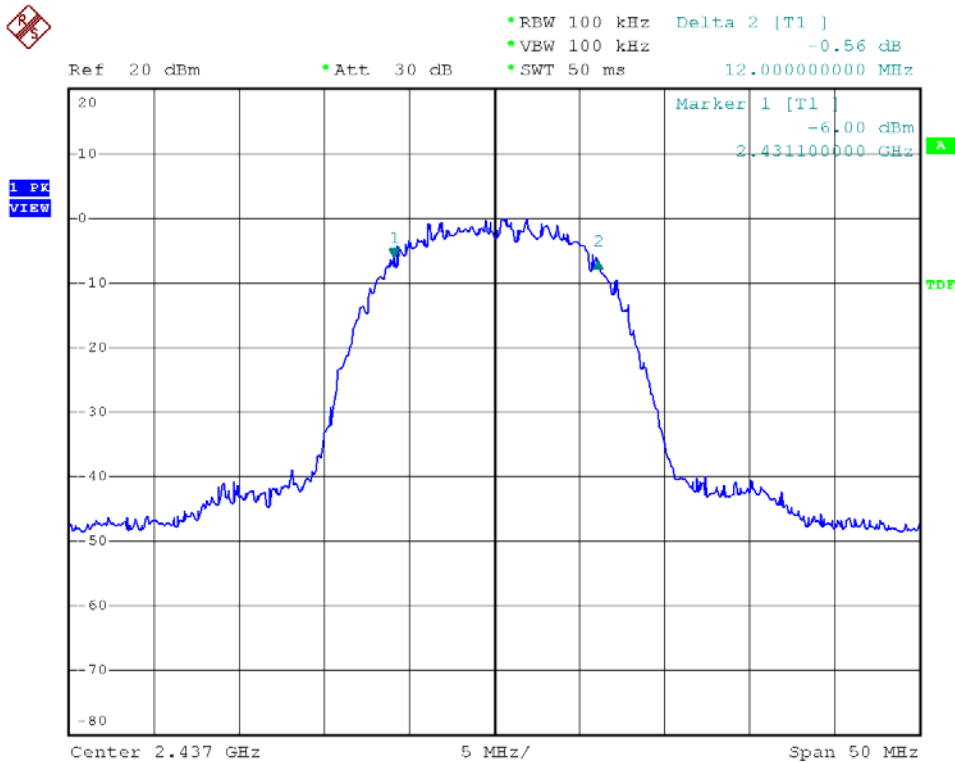

Modulation Standard: 802.11b (11Mbps), Ant2
Channel: 11

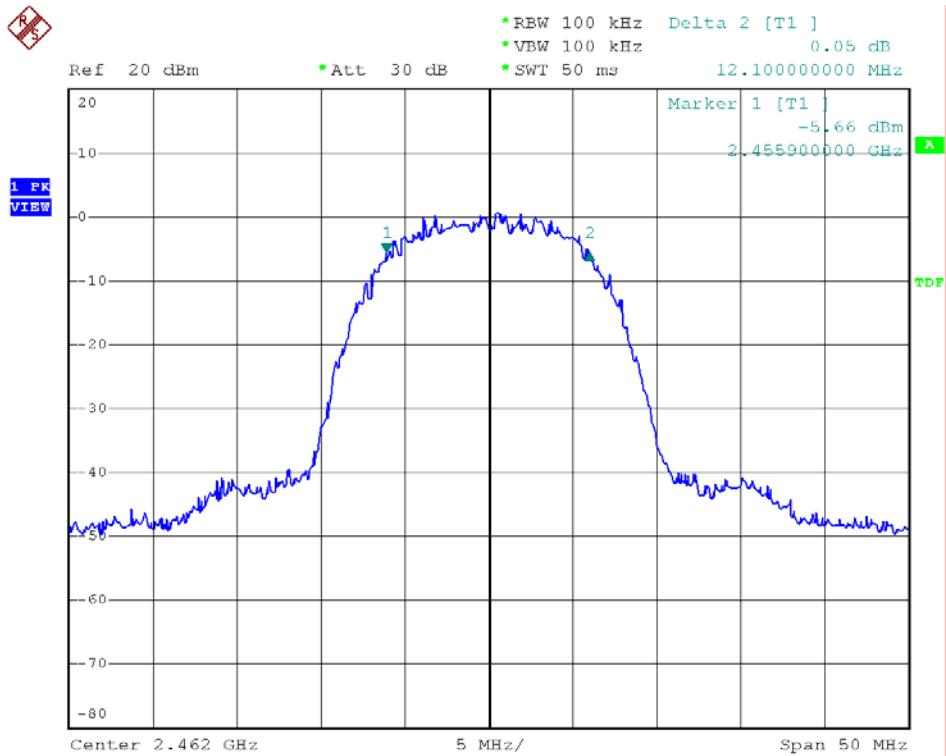



Modulation Standard: 802.11g (54Mbps), Ant1
Channel: 01

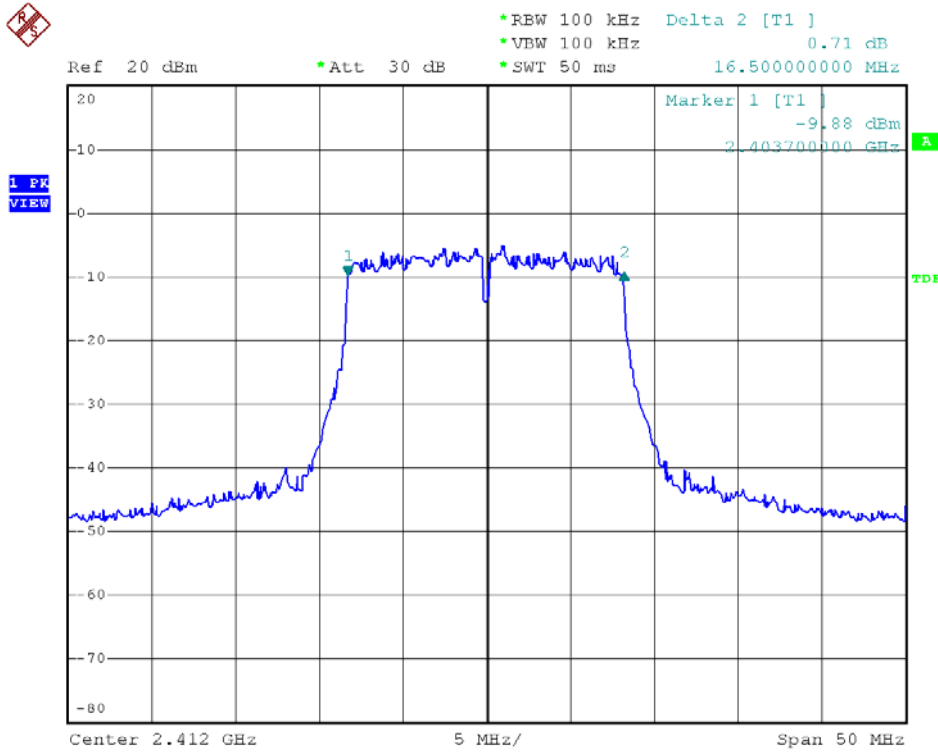

Modulation Standard: 802.11g (54Mbps), Ant1
Channel: 06

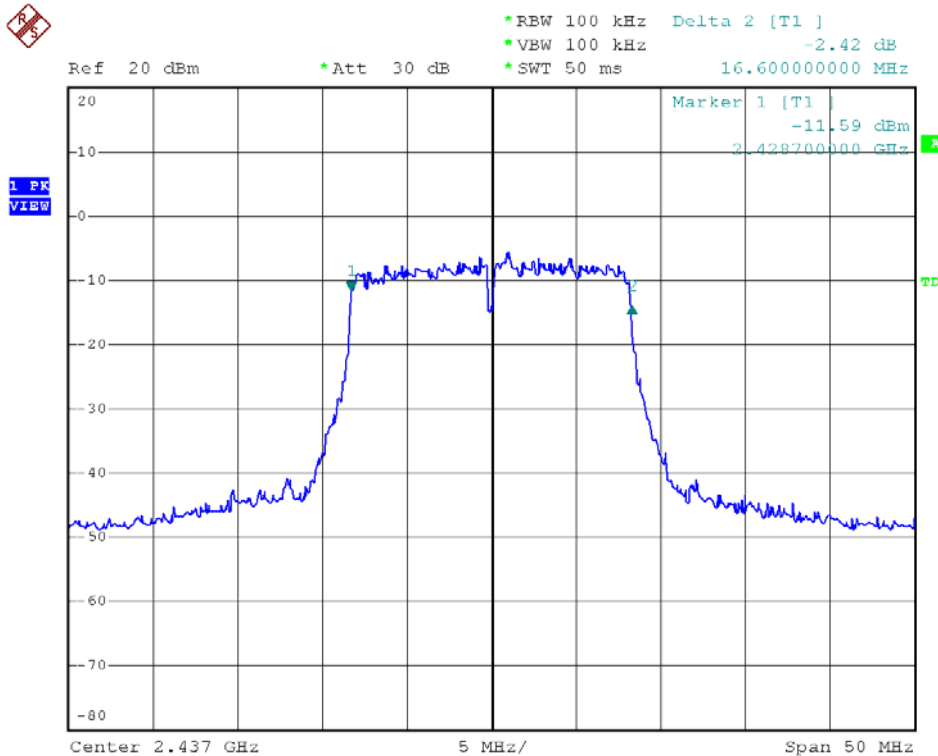



Modulation Standard: 802.11g (54Mbps), Ant1
Channel: 11

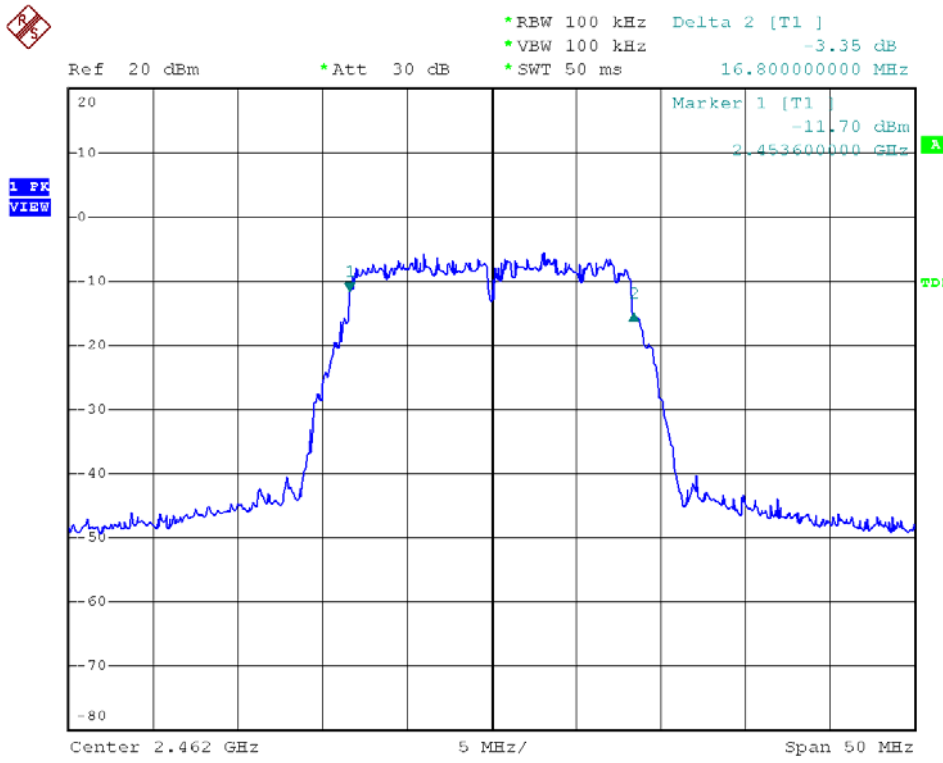

Modulation Standard: 802.11g (54Mbps), Ant2
Channel: 01

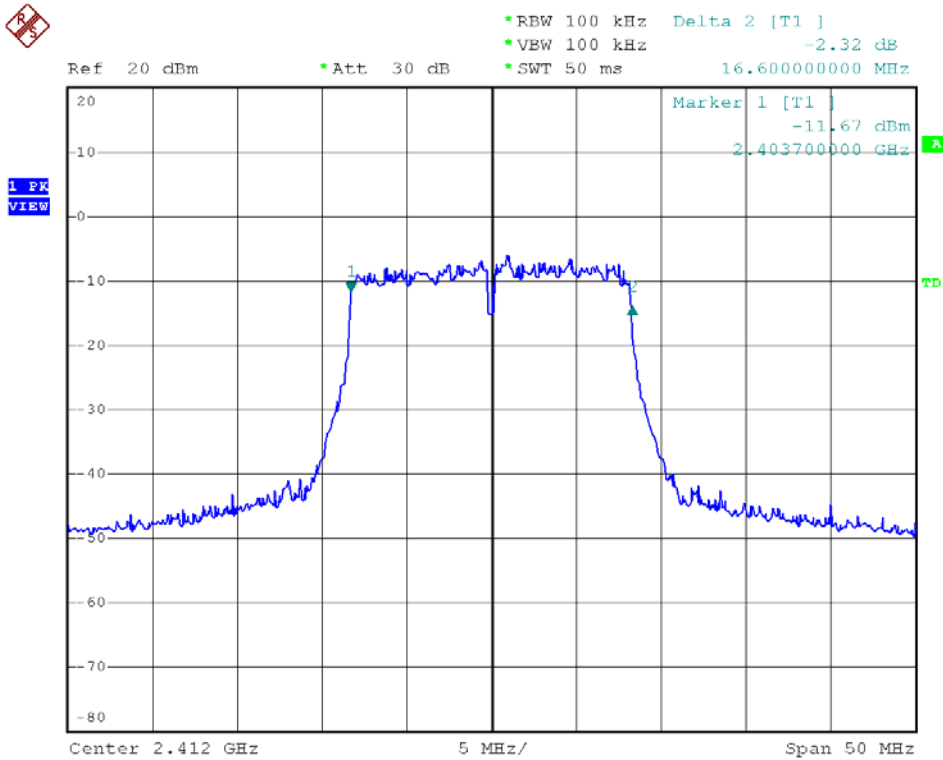



Modulation Standard: 802.11g (54Mbps), Ant2
Channel: 06

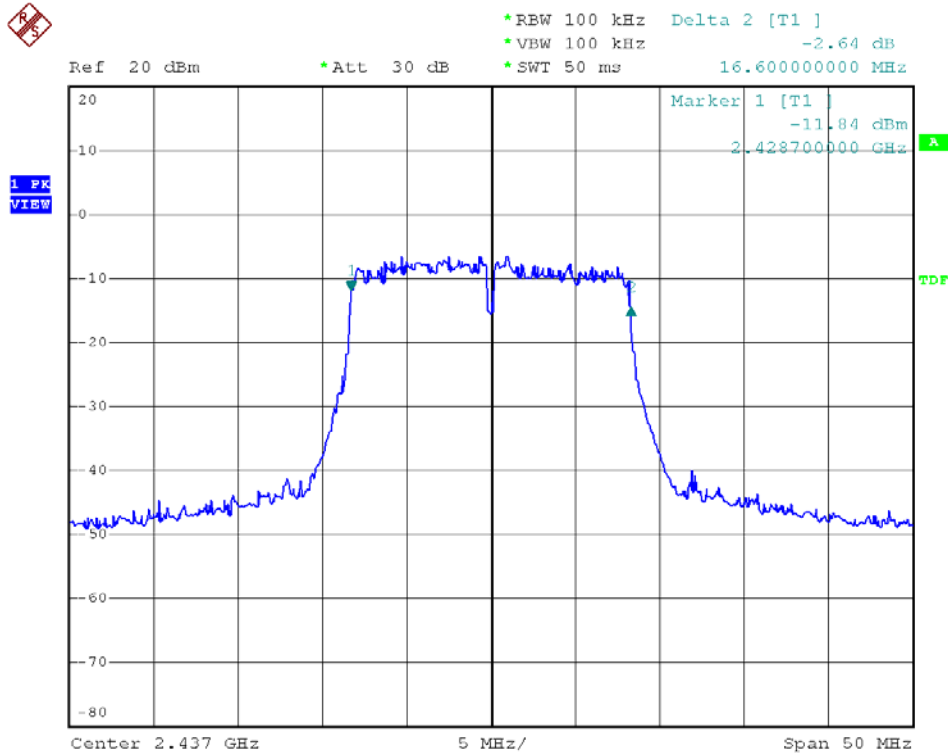

Modulation Standard: 802.11g (54Mbps), Ant2
Channel: 11

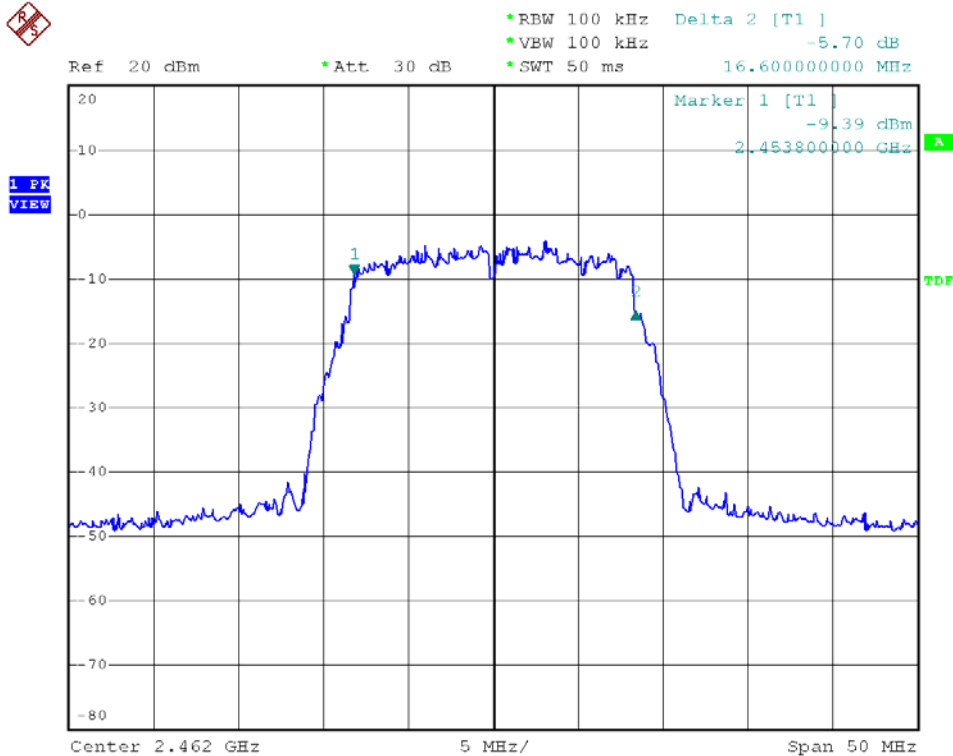



Modulation Standard: 802.11n HT20 (130Mbps), Ant1
Channel: 01

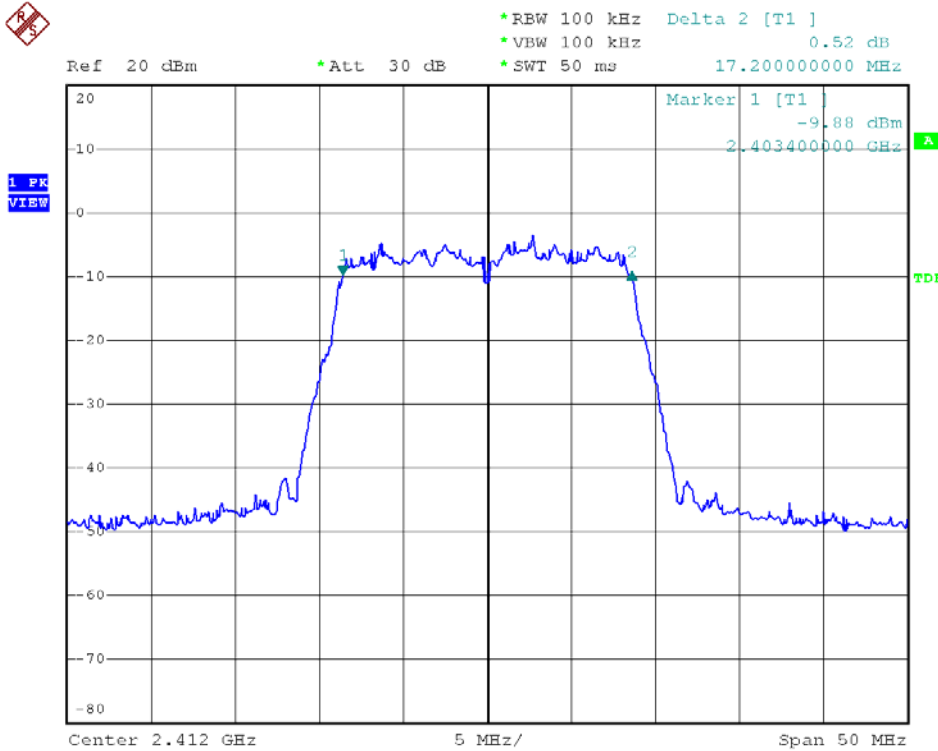

Modulation Standard: 802.11n HT20 (130Mbps), Ant1
Channel: 06

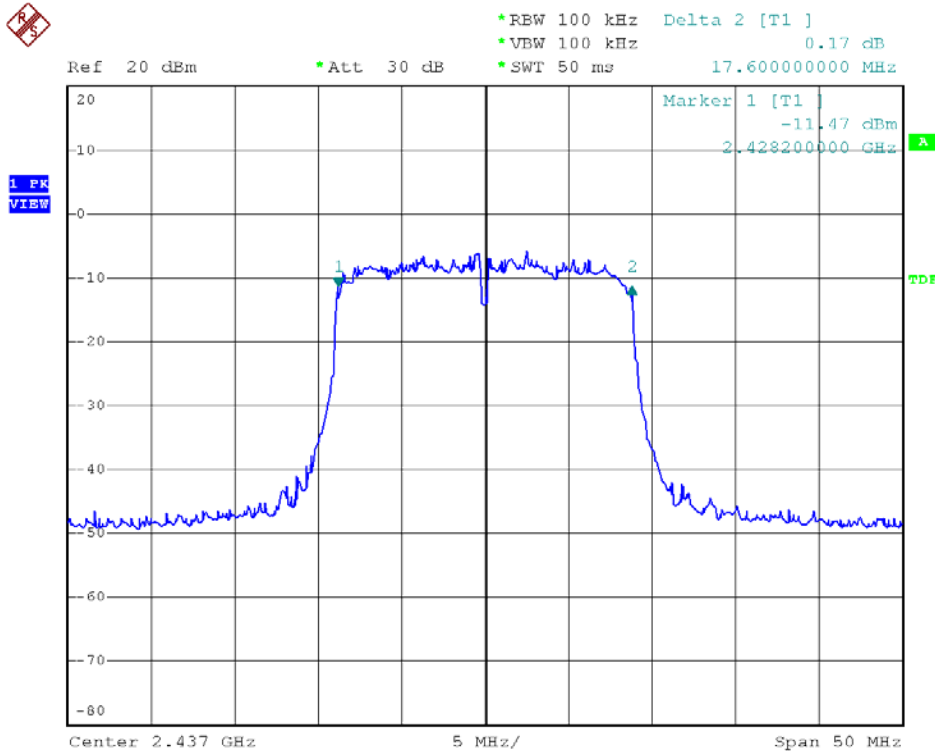



Modulation Standard: 802.11n HT20 (130Mbps), Ant1
Channel: 11

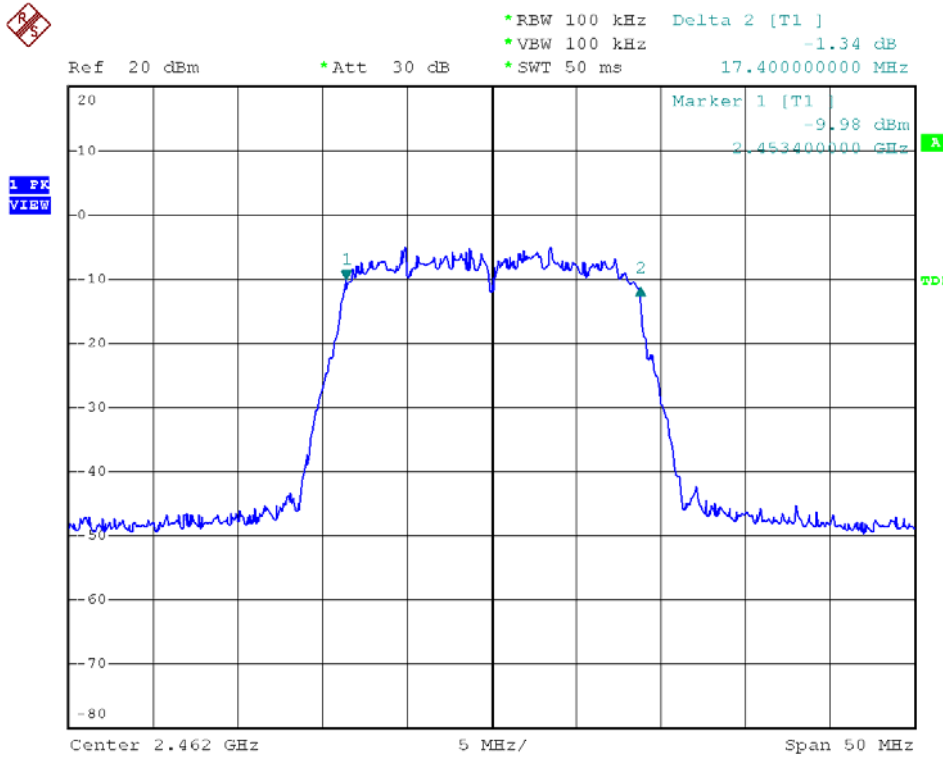

Modulation Standard: 802.11n HT20 (130Mbps), Ant2
Channel: 01

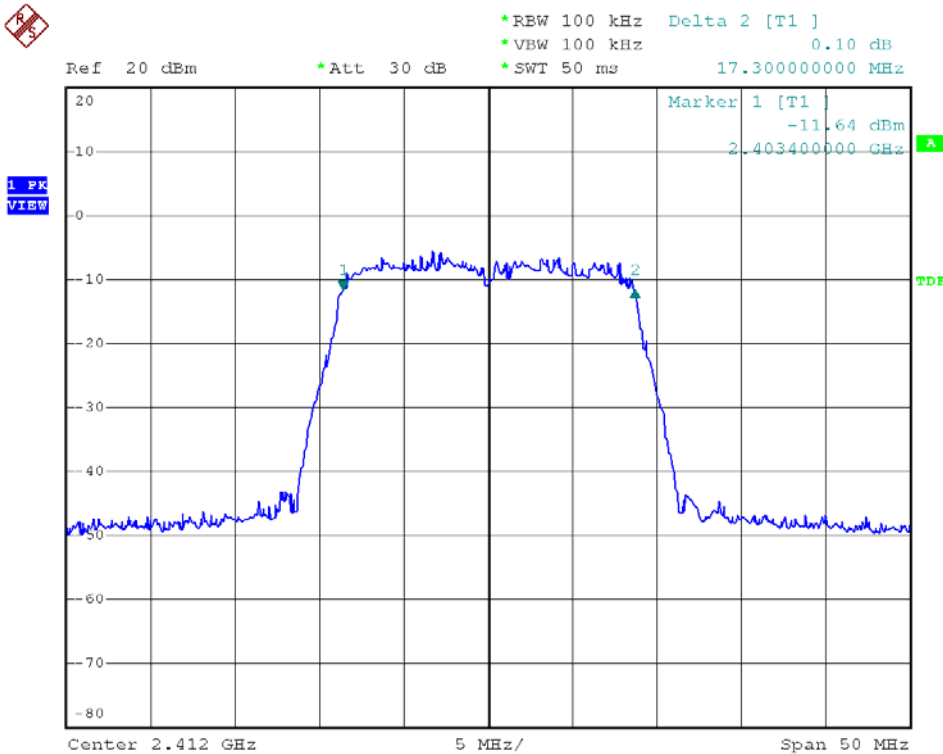



Modulation Standard: 802.11n HT20 (130Mbps), Ant2
Channel: 06

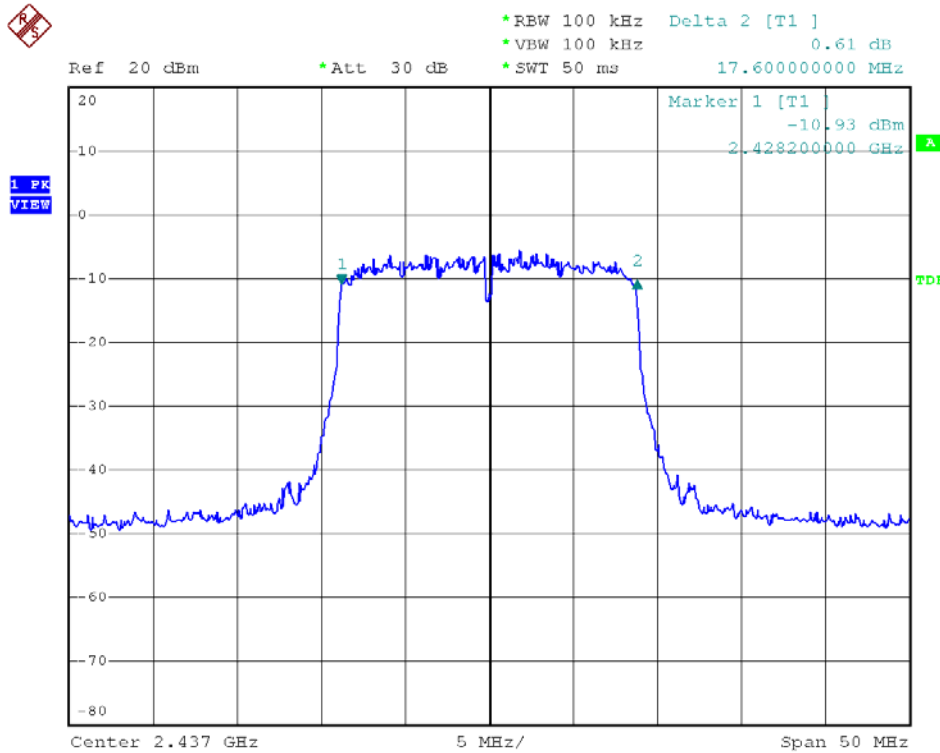

Modulation Standard: 802.11n HT20 (130Mbps), Ant2
Channel: 11

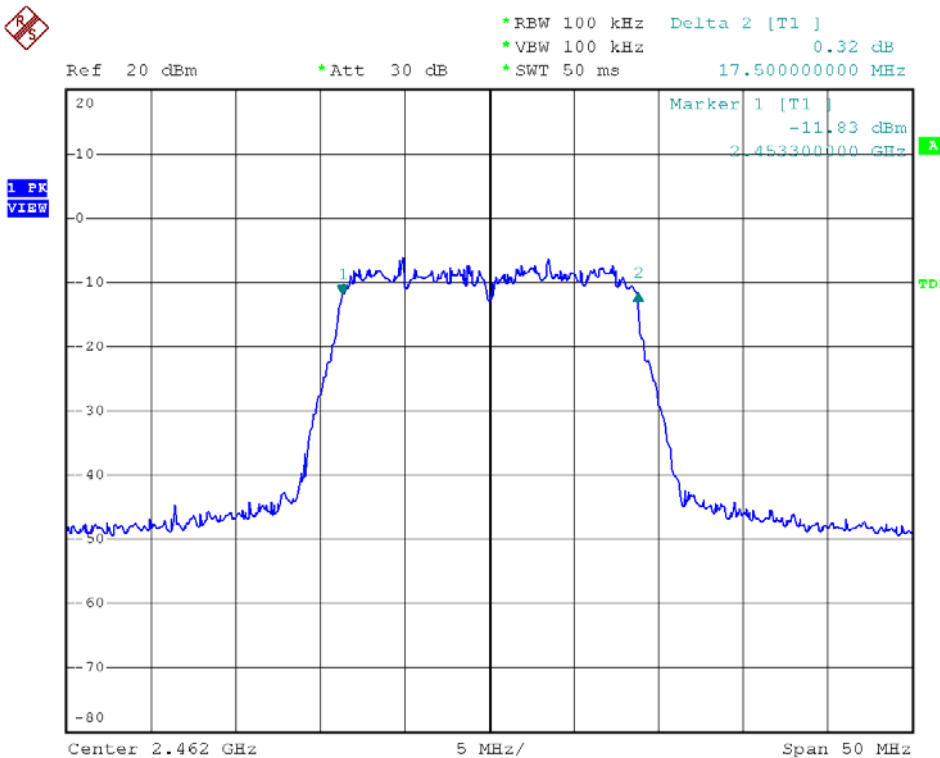



Modulation Standard: 802.11n HT40 (270Mbps), Ant1
Channel: 03

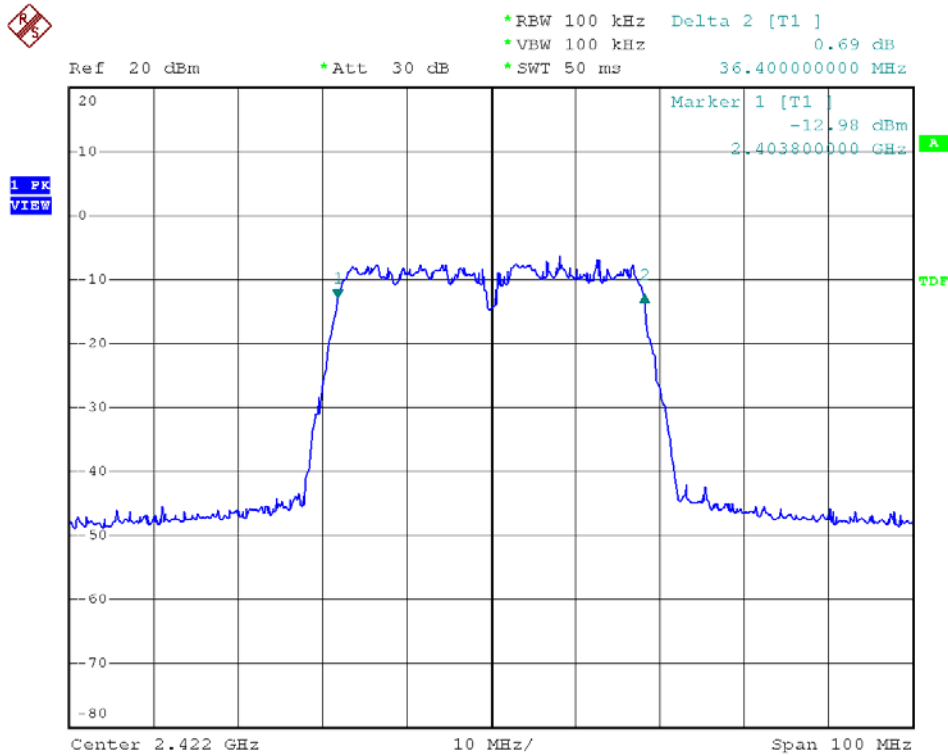

Modulation Standard: 802.11n HT40 (270Mbps), Ant1
Channel: 06

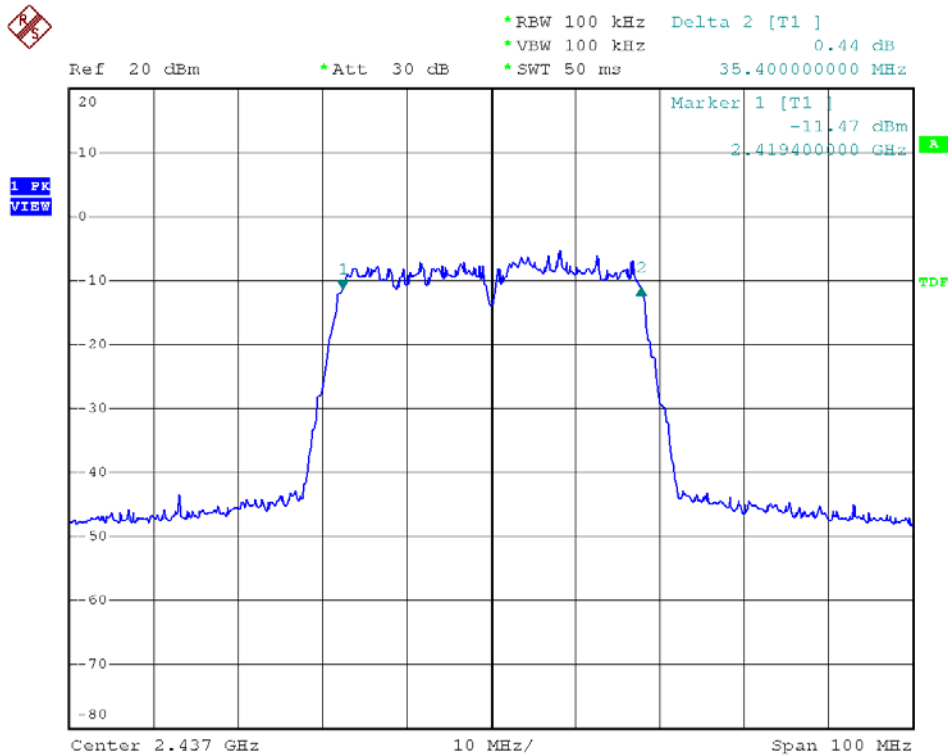



Modulation Standard: 802.11n HT40 (270Mbps), Ant1
Channel: 09

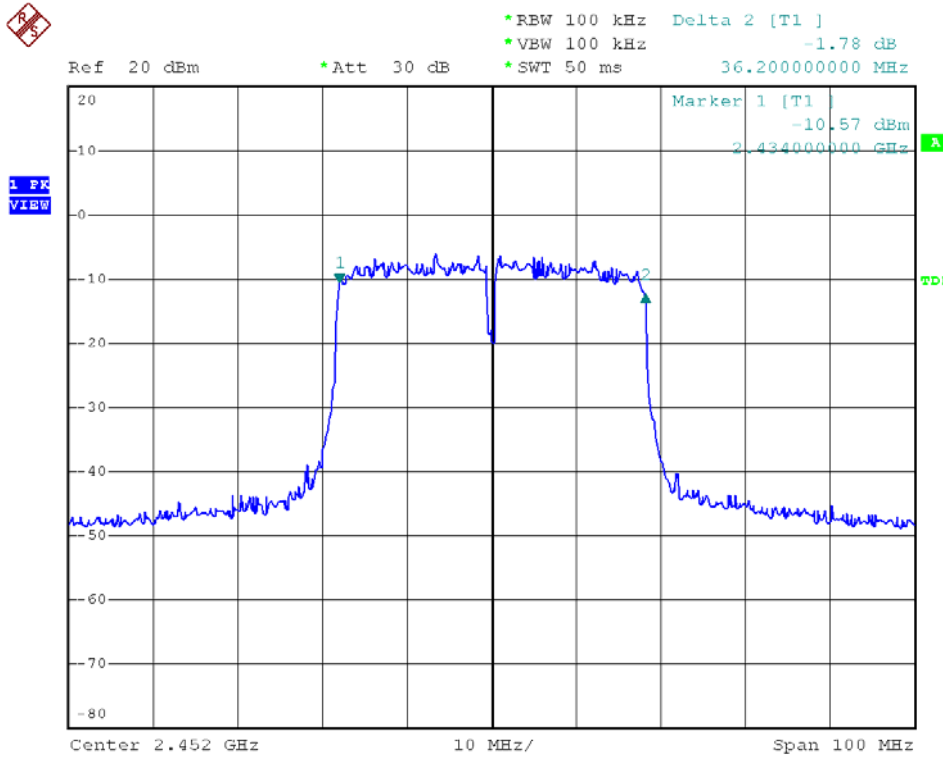

Modulation Standard: 802.11n HT40 (270Mbps), Ant2
Channel: 03

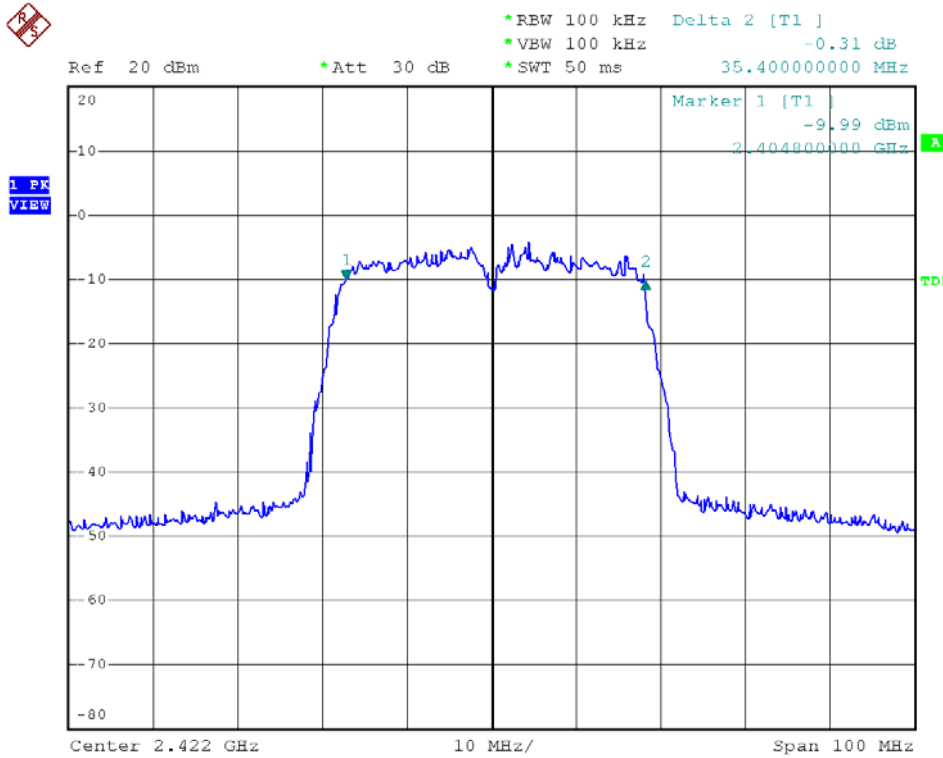



Modulation Standard: 802.11n HT40 (270Mbps), Ant2
Channel: 06

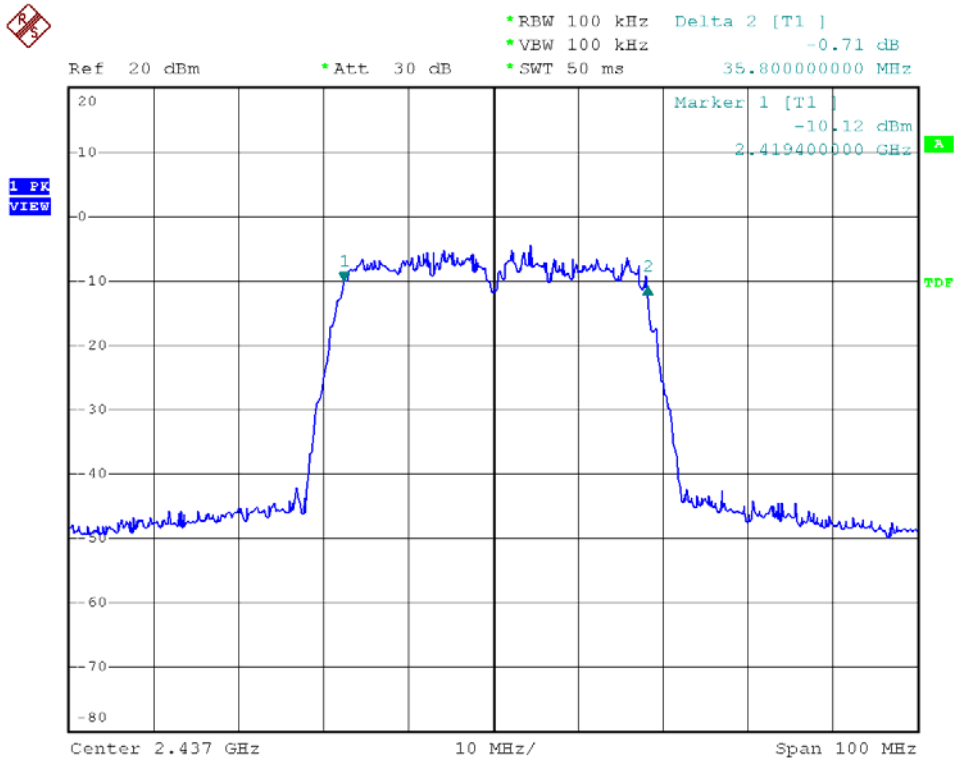

Modulation Standard: 802.11n HT40 (270Mbps), Ant2
Channel: 09

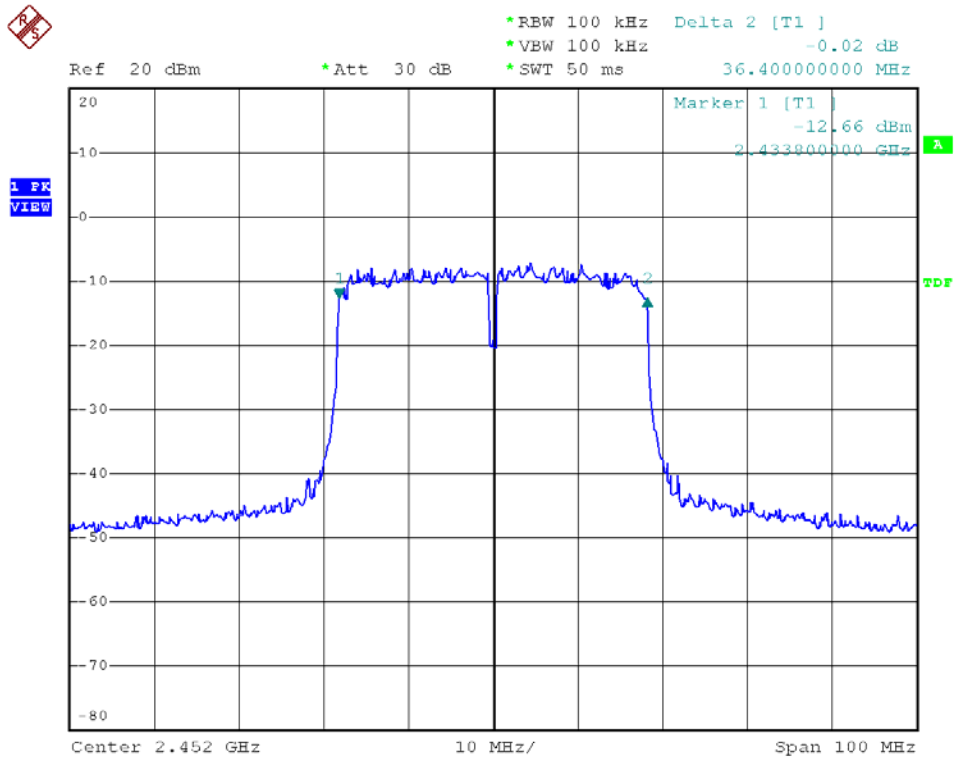



7. Maximum Peak Output Power

7.1 Test Limit

The Maximum Peak Output Power Measurement is 30dBm.

7.2 Test Procedures

The EUT was tested according to DTS test procedure of KDB558074 for compliance to FCC 47CFR 15.247 requirements.

In the following, "T" is the transmission pulse duration over which the transmitter is on and transmitting at its maximum power control level. Measurements are performed with a spectrum analyzer. Three methods are provided to accommodate measurement limitations of the spectrum analyzer depending on signal parameters. Set resolution bandwidth (RBW) = 1 MHz. Set span to encompass the entire emission bandwidth (EBW) of the signal. Use automatic setting for analyzer sweep time. Check the sweep time to determine which procedure to use.

As "T" sweep time, the test procedure will be used as following:

1. Set span to encompass the entire emission bandwidth (EBW) of the signal.
2. Set the sweep to "free run"
3. Set SBW=1MHz, Set VBW $1/T$.
4. Use linear display mode.
5. Use sample detector mode if bin width(i.e., span/number of points in spectrum) $< 0.5RBW$.
Otherwise use peak detector mode.
6. Set max hold.
7. Allow max hold to run for 60 seconds.
8. Compute power by integrating the spectrum across the 26 dB EBW or apply a bandwidth correction factor of $10 \log (EBW/1 \text{ MHz})$ to the spectral peak of the emission. The integration can be performed using the spectrum analyzer's bandpower measurement function with band limits set equal to the EBW band edges or by summing power levels in each 1 MHz band in linear power terms. The 1 MHz band power levels to be summed can be obtained by averaging, in linear power terms, power levels in each frequency bin across the 1 MHz.

7.3 Test Setup Layout

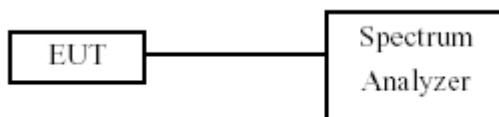



7.4 Measurement Equipment

Instrument/Ancillary	Model No.	Manufacturer	Serial No.	Calibration Date	Valid Date
Spectrum Analyzer	FSP40	R&S	10047	2010/05/08	2011/05/07

7.5 Test Result and Data

Test Date: Jan. 13, 2011

Temperature: 20

Atmospheric pressure: 1022 hPa

Humidity: 65%

Modulation Standard	Channel	Frequency (MHz)	Peak Power Output							
			Reading (dBm)		Factor (dB)		Total (dBm)		total (mW)	
			Ant1	Ant2	Ant1	Ant2	Ant1	Ant2	Ant1	Ant2
802.11b (11Mbps)	01	2412	7.94	7.89	12.81	12.76	20.75	20.65	118.9	116.1
	06	2437	7.61	7.60	12.76	12.79	20.37	20.39	108.9	109.4
	11	2462	7.60	7.63	12.79	12.79	20.39	20.42	109.4	110.2
802.11g (54Mbps)	01	2412	3.43	3.17	13.30	13.34	16.73	16.51	47.1	44.8
	06	2437	3.80	3.05	13.34	13.36	17.14	16.41	51.8	43.8
	11	2462	3.20	2.94	13.30	13.34	16.15	16.28	41.2	42.5

Modulation Standard	Channel	Frequency (MHz)	Peak Power Output							
			Reading (dBm)		Factor (dB)		Total (dBm)		total (mW)	
			Ant1	Ant2	Ant1	Ant2	Ant1	Ant2	Ant1+2	Ant1+2
802.11n HT20 (130Mbps)	01	2412	2.58	2.13	13.24	13.34	15.82	15.47	18.66	73.4
	06	2437	1.99	1.99	13.26	13.38	15.25	15.37	18.32	67.9
	11	2462	2.48	1.47	13.26	13.38	15.74	14.85	18.33	68.0
802.11n HT40 (270Mbps)	03	2422	-1.46	-1.53	16.25	16.23	14.79	14.70	17.76	59.6
	06	2437	-1.33	-1.55	16.23	16.25	14.90	14.70	17.81	60.4
	09	2452	-1.42	-1.62	16.25	16.23	14.83	14.61	17.73	59.3



Modulation Standard	Channel	Frequency (MHz)	26dB Bandwidth (MHz)		Correct Factor (dB)	
			Ant1	Ant2	Ant1	Ant2
802.11b (11Mbps)	01	2412	19.1	18.9	12.81	12.76
	06	2437	18.9	19.0	12.76	12.79
	11	2462	19.0	19.0	12.79	12.79
802.11g (54Mbps)	01	2412	21.4	21.6	13.30	13.34
	06	2437	21.6	21.7	13.34	13.36
	11	2462	21.4	21.6	13.30	13.34

Modulation Standard	Channel	Frequency (MHz)	26dB Bandwidth (MHz)		Correct Factor (dB)	
			Ant1	Ant2	Ant1	Ant2
802.11n HT20 (130Mbps)	01	2412	21.1	21.6	13.24	13.34
	06	2437	21.2	21.8	13.26	13.38
	11	2462	21.2	21.8	13.26	13.38
802.11n HT40 (270Mbps)	03	2422	42.2	42.0	16.25	16.23
	06	2437	42.0	42.2	16.23	16.25
	09	2452	42.2	42.0	16.25	16.23

Note: 1. Peak Power Output Result = Output Power + Correct factor
 2. Total power value of MIMO mode: $10\log(10^{(Ant1/10)} + 10^{(Ant2/10)})$



Modulation Standard: 802.11b (11Mbps), Ant1
Channel: 01

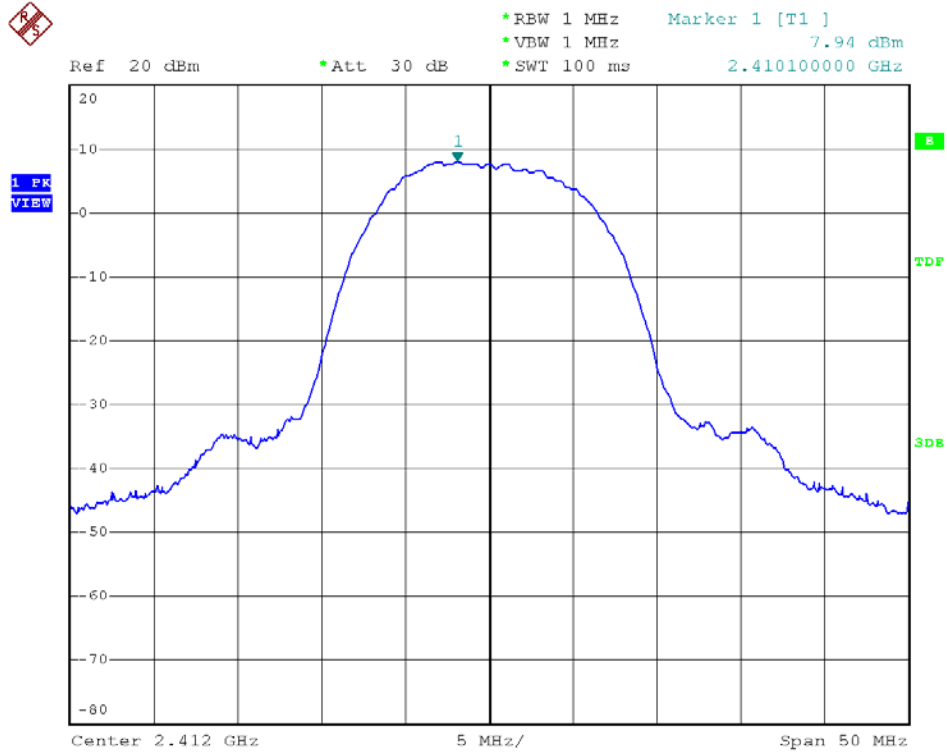

Modulation Standard: 802.11b (11Mbps), Ant1
Channel: 06

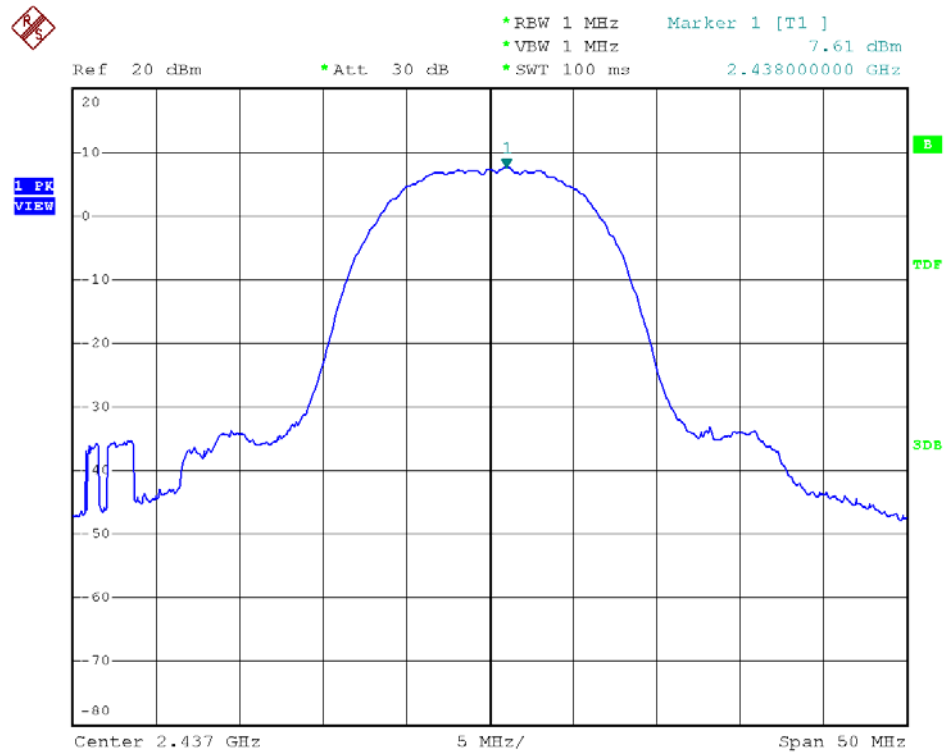



Modulation Standard: 802.11b (11Mbps), Ant1
Channel: 11

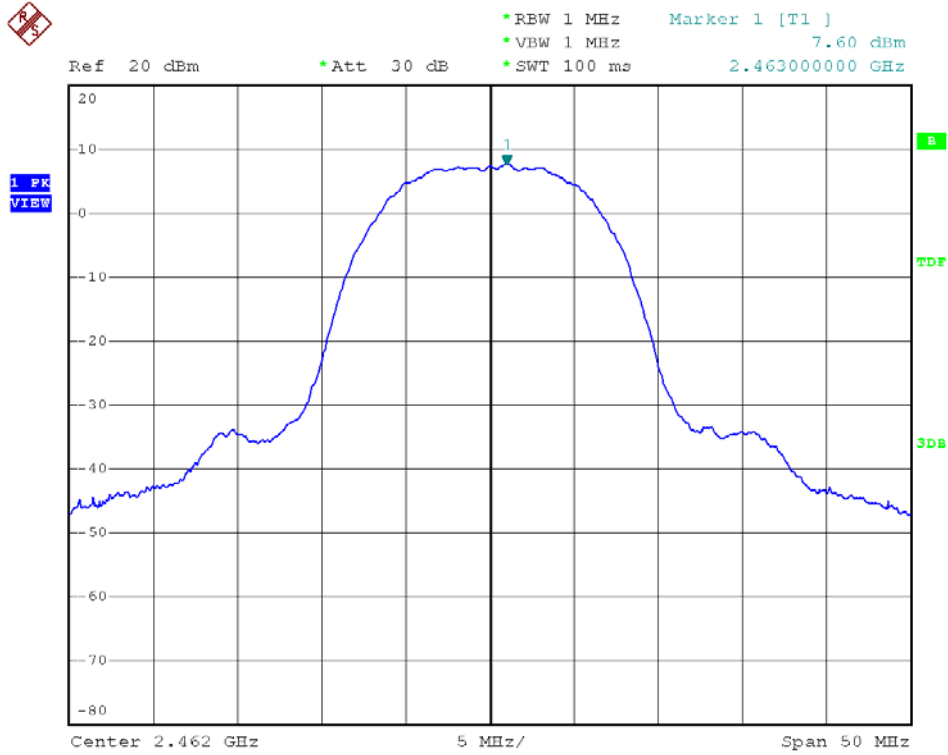

Modulation Standard: 802.11b (11Mbps), Ant2
Channel: 01

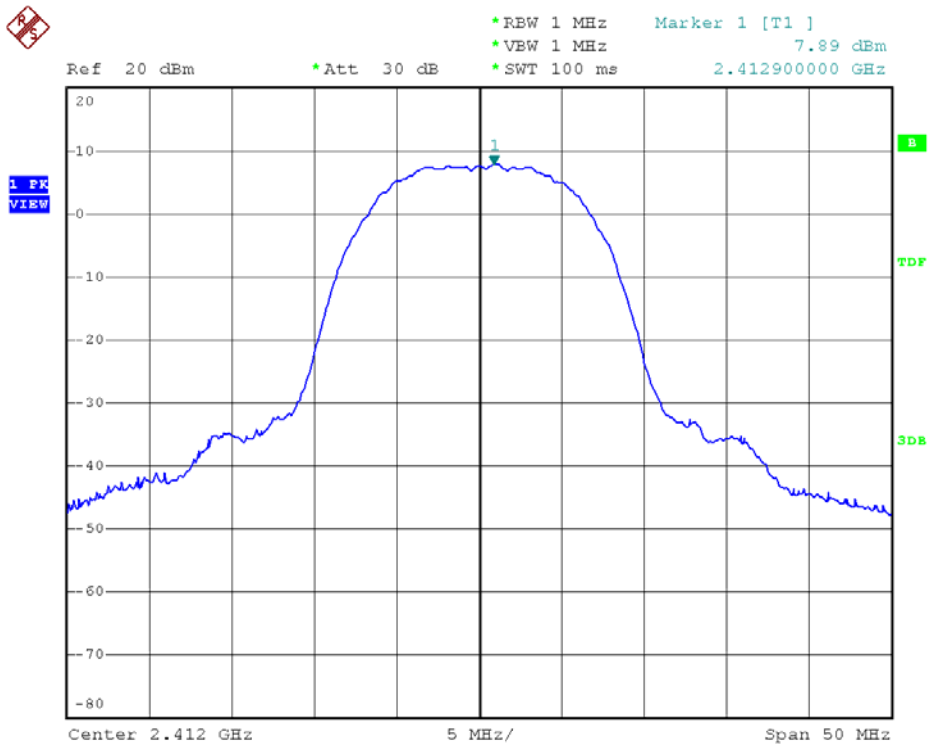



Modulation Standard: 802.11b (11Mbps), Ant2
Channel: 06

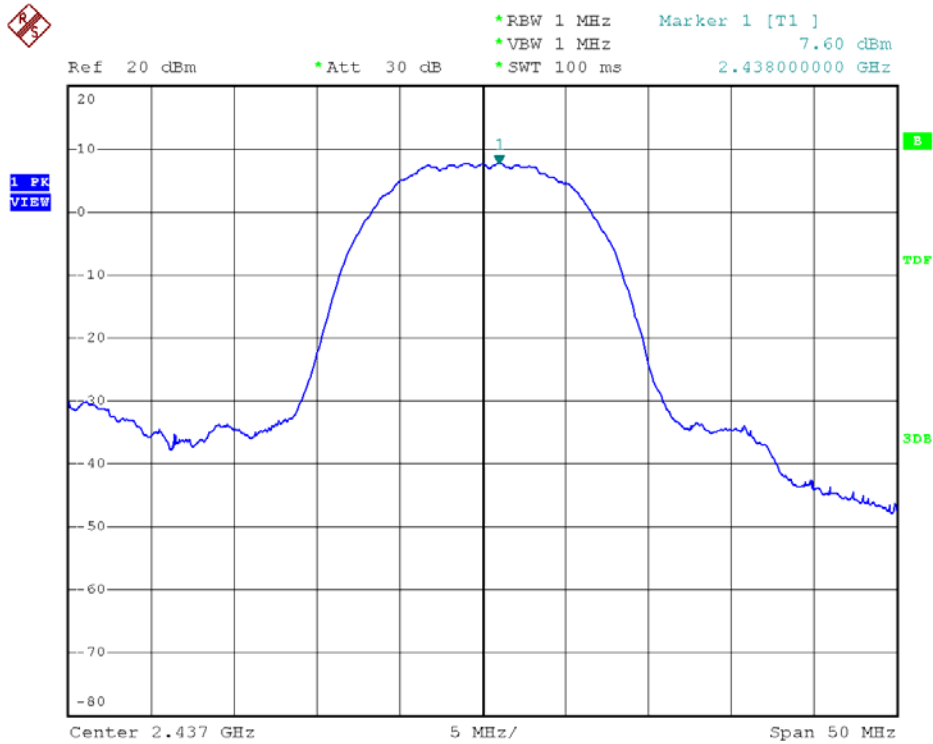

Modulation Standard: 802.11b (11Mbps), Ant2
Channel: 11

