



SPORTON International Inc.

No. 52, Hwa Ya 1st Rd., Kwei-Shan Hsiang, TaoYuan Hsien, Taiwan, R.O.C.
Ph: 886-3-327-3456 / FAX: 886-3-327-0973 / www.sporton.com.tw

FCC RADIO TEST REPORT

Applicant's company	Billion Electric Co., Ltd.
Applicant Address	8F.,No192,Sec2,Chung Hsing Road, Hsin Tien City,Taipei Hsien,Taiwan,R.O.C.
FCC ID	QI3-7300WX
Manufacturer's company	Billion Electric Co., Ltd.
Manufacturer Address	8F.,No192,Sec2,Chung Hsing Road, Hsin Tien City,Taipei Hsien,Taiwan,R.O.C.

Product Name	Wireless-N ADSL2+ Firewall Router
Brand Name	Billion; BEC
Model Name	BiPAC 7300WX/BiPAC 7300W/BiPAC 5210W/BiPAC 5200W, BEC 7300WX/BEC 7300W/BEC 5210W/BEC 5200W
Test Rule	47 CFR FCC Part 15 Subpart C § 15.247
Test Freq. Range	2400 ~ 2483.5MHz
Received Date	Feb. 25, 2010
Final Test Date	May 03, 2010
Submission Type	Original Equipment
Multiple Listing	Please refer to section 3.7



Statement

Test result included in this report is for the IEEE 802.11n and IEEE 802.11b/g part of the product.

The test result in this report refers exclusively to the presented test model / sample.

Without written approval of SPORTON International Inc., the test report shall not be reproduced except in full.

The measurements and test results shown in this test report were made in accordance with the procedures and found in compliance with the limit given in **ANSI C63.4-2003** and **47 CFR FCC Part 15 Subpart C**.

The test equipment used to perform the test is calibrated and traceable to NML/ROC.



Table of Contents

1. CERTIFICATE OF COMPLIANCE	1
2. SUMMARY OF THE TEST RESULT	2
3. GENERAL INFORMATION	3
3.1. Product Details.....	3
3.2. Accessories.....	5
3.3. Table for Filed Antenna.....	5
3.4. Table for Carrier Frequencies	5
3.5. Table for Test Modes	6
3.6. Table for Testing Locations.....	6
3.7. Table for Multiple Listing.....	7
3.8. Table for Supporting Units	7
3.9. Table for Parameters of Test Software Setting	8
3.10. Test Configurations	9
4. TEST RESULT	14
4.1. AC Power Line Conducted Emissions Measurement.....	14
4.2. Maximum Conducted Output Power Measurement.....	20
4.3. Power Spectral Density Measurement	26
4.4. 6dB Spectrum Bandwidth Measurement	32
4.5. Radiated Emissions Measurement	38
4.6. Band Edge Emissions Measurement	58
4.7. Antenna Requirements	67
5. LIST OF MEASURING EQUIPMENTS	68
6. TEST LOCATION.....	70
7. TAF CERTIFICATE OF ACCREDITATION	71
APPENDIX A. PHOTOGRAPHS OF EUT.....	A1 ~ A25
APPENDIX B. TEST PHOTOS.....	B1 ~ B7
APPENDIX C. MAXIMUM PERMISSIBLE EXPOSURE.....	C1 ~C3



History of This Test Report

Original Issue Date: May 07, 2010

Report No.: FR022562

- No additional attachment.
- Additional attachment were issued as following record:

Attachment No.	Issue Date	Description



1. CERTIFICATE OF COMPLIANCE

Product Name : Wireless-N ADSL2+ Firewall Router
Brand Name : Billion; BEC
Model Name : BIPAC 7300WX/BIPAC 7300W/BIPAC 5210W/BIPAC 5200W,
BEC 7300WX/BEC 7300W/BEC 5210W/BEC 5200W
Applicant : Billion Electric Co., Ltd.
Test Rule Part(s) : 47 CFR FCC Part 15 Subpart C § 15.247

Sporton International as requested by the applicant to evaluate the EMC performance of the product sample received on Feb. 25, 2010 would like to declare that the tested sample has been evaluated and found to be in compliance with the tested rule parts. The data recorded as well as the test configuration specified is true and accurate for showing the sample's EMC nature.



Jordan Hsiao

SPORTON INTERNATIONAL INC.

2. SUMMARY OF THE TEST RESULT

Applied Standard: 47 CFR FCC Part 15 Subpart C				
Part	Rule Section	Description of Test	Result	Under Limit
4.1	15.207	AC Power Line Conducted Emissions	Complies	17.75 dB
4.2	15.247(b)(3)	Maximum Conducted Output Power	Complies	8.24 dB
4.3	15.247(e)	Power Spectral Density	Complies	14.64 dB
4.4	15.247(a)(2)	6dB Spectrum Bandwidth	Complies	-
4.5	15.247(d)	Radiated Emissions	Complies	0.22 dB
4.6	15.247(d)	Band Edge Emissions	Complies	0.37 dB
4.7	15.203	Antenna Requirements	Complies	-

Test Items	Uncertainty	Remark
AC Power Line Conducted Emissions	±2.3dB	Confidence levels of 95%
Maximum Conducted Output Power	±0.8dB	Confidence levels of 95%
Power Spectral Density	±0.5dB	Confidence levels of 95%
6dB Spectrum Bandwidth	±8.5×10 ⁻⁸	Confidence levels of 95%
Radiated Emissions (9kHz~30MHz)	±0.8dB	Confidence levels of 95%
Radiated Emissions (30MHz~1000MHz)	±1.9dB	Confidence levels of 95%
Radiated / Band Edge Emissions (1GHz~18GHz)	±1.9dB	Confidence levels of 95%
Radiated Emissions (18GHz~26.5GHz)	±1.9dB	Confidence levels of 95%
Temperature	±0.7°C	Confidence levels of 95%
Humidity	±3.2%	Confidence levels of 95%
DC / AC Power Source	±1.4%	Confidence levels of 95%

3. GENERAL INFORMATION

3.1. Product Details

IEEE 802.11n

Items	Description
Product Type	WLAN (1TX, 1RX)
Radio Type	Intentional Transceiver
Power Type	Power Adapter
Modulation	see the below table for IEEE 802.11n
Data Modulation	OFDM (BPSK / QPSK / 16QAM / 64QAM)
Data Rate (Mbps)	see the below table for IEEE 802.11n
Frequency Range	2400 ~ 2483.5MHz
Channel Number	11 for 20MHz bandwidth ; 7 for 40MHz bandwidth
Channel Band Width (99%)	MCS0 (20MHz): 17.60 MHz ; MCS0 (40MHz): 36.00 MHz
Conducted Output Power	MCS0 (20MHz): 21.03 dBm ; MCS0 (40MHz): 14.58 dBm
Carrier Frequencies	Please refer to section 3.4
Antenna	Please refer to section 3.3

IEEE 802.11b/g

Items	Description
Product Type	802.11b :WLAN (1TX, 1RX) 802.11g :WLAN (1TX, 1RX)
Radio Type	Intentional Transceiver
Power Type	Power Adapter
Modulation	DSSS for IEEE 802.11b ; OFDM for IEEE 802.11g
Data Modulation	DSSS (BPSK / QPSK / CCK) ; OFDM (BPSK / QPSK / 16QAM / 64QAM)
Data Rate (Mbps)	DSSS (1/ 2/ 5.5/11) ; OFDM (6/9/12/18/24/36/48/54)
Frequency Range	2400 ~ 2483.5MHz
Channel Number	11
Channel Band Width (99%)	11b: 15.08 MHz ; 11g: 16.48 MHz
Conducted Output Power	11b: 14.37 dBm ; 11g: 21.76 dBm
Carrier Frequencies	Please refer to section 3.4
Antenna	Please refer to section 3.3

Antenna & Band width

Antenna	Single (TX)	
	20 MHz	40 MHz
Band width Mode	20 MHz	40 MHz
IEEE 802.11b	V	X
IEEE 802.11g	V	X
IEEE 802.11n	V	V

IEEE 802.11n spec

MCS Index	Nss	Modulation	R	NBPS	NCBPS		NDBPS		Datarate(Mbps)			
					20MHz	40MHz	20MHz	40MHz	800nsGI		400nsGI	
									20MHz	40MHz	20MHz	40MHz
0	1	BPSK	1/2	1	52	108	26	54	6.5	13.5	7.200	15
1	1	QPSK	1/2	2	104	216	52	108	13.0	27.0	14.400	30
2	1	QPSK	3/4	2	104	216	78	162	19.5	40.5	21.700	45
3	1	16-QAM	1/2	4	208	432	104	216	26.0	54.0	28.900	60
4	1	16-QAM	3/4	4	208	432	156	324	39.0	81.0	43.300	90
5	1	64-QAM	2/3	6	312	648	208	432	52.0	108.0	57.800	120
6	1	64-QAM	3/4	6	312	648	234	486	58.5	121.5	65.000	135
7	1	64-QAM	5/6	6	312	648	260	540	65.0	135.0	72.200	150
8	2	BPSK	1/2	1	104	216	52	108	13.0	27.0	14.444	30
9	2	QPSK	1/2	2	208	432	104	216	26.0	54.0	28.889	60
10	2	QPSK	3/4	2	208	432	156	324	39.0	81.0	43.333	90
11	2	16-QAM	1/2	4	416	864	208	432	52.0	108.0	57.778	120
12	2	16-QAM	3/4	4	416	864	312	648	78.0	162.0	86.667	180
13	2	64-QAM	2/3	6	624	1296	416	864	104.0	216.0	115.556	240
14	2	64-QAM	3/4	6	624	1296	468	972	117.0	243.0	130.000	270
15	2	64-QAM	5/6	6	624	1296	520	1080	130.0	270.0	144.444	300

Symbol	Explanation
NSS	Number of spatial streams
R	Code rate
NBPS	Number of coded bits per single carrier
NCBPS	Number of coded bits per symbol
NDBPS	Number of data bits per symbol
GI	guard interval

3.2. Accessories

Power	Brand	Model	Rating
Adapter 1	EGB	PAW012A12UL	Input: 100-240VAC, 50/60Hz, 0.5A Output: 12VDC, 1.0A

3.3. Table for Filed Antenna

Ant.	Brand	Model Name	Antenna Type	Connector	Gain (dBi)
A	ARISTOTLE	A0ZAND2S202C2M2000	Dipole Antenna	RP-SMA Plug	1.70

3.4. Table for Carrier Frequencies

For IEEE 802.11b/g, use Channel 1~Channel 11.

There are two bandwidth systems for IEEE 802.11n.

For both 20MHz bandwidth systems, use Channel 1~Channel 11.

For both 40MHz bandwidth systems, use Channel 3~Channel 9.

Frequency Band	Channel No.	Frequency	Channel No.	Frequency
2400~2483.5MHz	1	2412 MHz	7	2442 MHz
	2	2417 MHz	8	2447 MHz
	3	2422 MHz	9	2452 MHz
	4	2427 MHz	10	2457 MHz
	5	2432 MHz	11	2462 MHz
	6	2437 MHz		

3.5. Table for Test Modes

Preliminary tests were performed in different data rate to find the worst radiated emission. The data rate shown in the table below is the worst-case rate with respect to the specific test item. Investigation has been done on all the possible configurations for searching the worst cases. The following table is a list of the test modes shown in this test report.

Test Items	Mode	Data Rate	Channel	Antenna
AC Power Line Conducted Emissions	Normal Link	-	-	A
Maximum Peak Conducted Output Power	MCS0/20MHz	6.5 Mbps	1/6/11	A
	MCS0/40MHz	13.5 Mbps	3/6/9	A
	11b/BPSK	1 Mbps	1/6/11	A
	11g/BPSK	6 Mbps	1/6/11	A
Power Spectral Density 6dB Spectrum Bandwidth	MCS0/20MHz	6.5 Mbps	1/6/11	A
	MCS0/40MHz	13.5 Mbps	3/6/9	A
	11b/BPSK	1 Mbps	1/6/11	A
	11g/BPSK	6 Mbps	1/6/11	A
Radiated Emissions 9kHz~1GHz	Normal Link	-	-	A
Radiated Emissions 1GHz~10 th Harmonic	MCS0/20MHz	6.5 Mbps	1/6/11	A
	MCS0/40MHz	13.5 Mbps	3/6/9	A
	11b/BPSK	1 Mbps	1/6/11	A
	11g/BPSK	6 Mbps	1/6/11	A
Band Edge Emissions	MCS0/20MHz	6.5 Mbps	1/11	A
	MCS0/40MHz	13.5 Mbps	3/9	A
	11b/BPSK	1 Mbps	1/11	A
	11g/BPSK	6 Mbps	1/11	A

The following test modes were performed for all tests:

Mode 1. EUT 1 (link with PC)

Mode 2. EUT 2 (link with USB)

All the test results were tested and recorded in the report.

3.6. Table for Testing Locations

Test Site No.	Site Category	Location	FCC Reg. No.	IC File No.	VCCI Reg. No
03CH03-HY	SAC	Hwa Ya	480872	IC 4086	-
CO04-HY	Conduction	Hwa Ya	480872	IC 4086	-
TH01-HY	OVEN Room	Hwa Ya	-	-	-

Open Area Test Site (OATS); Semi Anechoic Chamber (SAC); Fully Anechoic Chamber (FAC).

Please refer section 6 for Test Site Address.

3.7. Table for Multiple Listing

The brand/model names in the following table are all refer to the identical product.

Brand Name	Model Name	Flash	SDRAM	USB	layout
Billion	BiPAC 5200W	2MB	16MB	X	V
BEC	BEC 5200W				
Billion	BiPAC 5210W	2MB	16MB	USB2.0 slave	V
BEC	BEC 5210W				
Billion	BiPAC 7300W	4MB	32MB	X	V
BEC	BEC 7300W				
Billion	BiPAC 7300WX	8MB	32MB	USB2.0 Master	V
BEC	BEC 7300WX				

3.8. Table for Supporting Units

Support Unit	Brand	Model	FCC ID
Notebook	DELL	M1330	E2KWM3945ABG
Notebook	DELL	D400	E2K24GBRL
Notebook	DELL	1200	E2K4965AGNM
Notebook	DELL	1200	E2K4965AGNM
ADSL 2+ Simulator	ZYXEL	IES-1000	DoC
FDISK	SILICON	2G	DoC
HUB	Laneed	LD-LSW16C/AT	N/A

3.9. Table for Parameters of Test Software Setting

During testing, Channel & Power Controlling Software provided by the customer was used to control the operating channel as well as the output power level. The RF output power selection is for the setting of RF output power expected by the customer and is going to be fixed on the firmware of the final end product.

Power Parameters of IEEE 802.11n MCS0

Test Software Version	DOS		
Frequency	2412 MHz	2437 MHz	2462 MHz
MCS0 20MHz	3	14	4
Frequency	2422 MHz	2437 MHz	2452 MHz
MCS0 40MHz	0	2	0

Power Parameters of IEEE 802.11b/g

Test Software Version	DOS		
Frequency	2412 MHz	2437 MHz	2462 MHz
IEEE 802.11b	10	10	10
IEEE 802.11g	7	17	4

During the test, "DOS" under WIN XP was executed the test program to control the EUT continuously transmit RF signal.

3.10. Test Configurations

3.10.1. Radiation Emissions Test Configuration

Test Configuration: 9KHz~1GHz

Test Mode: Mode 1

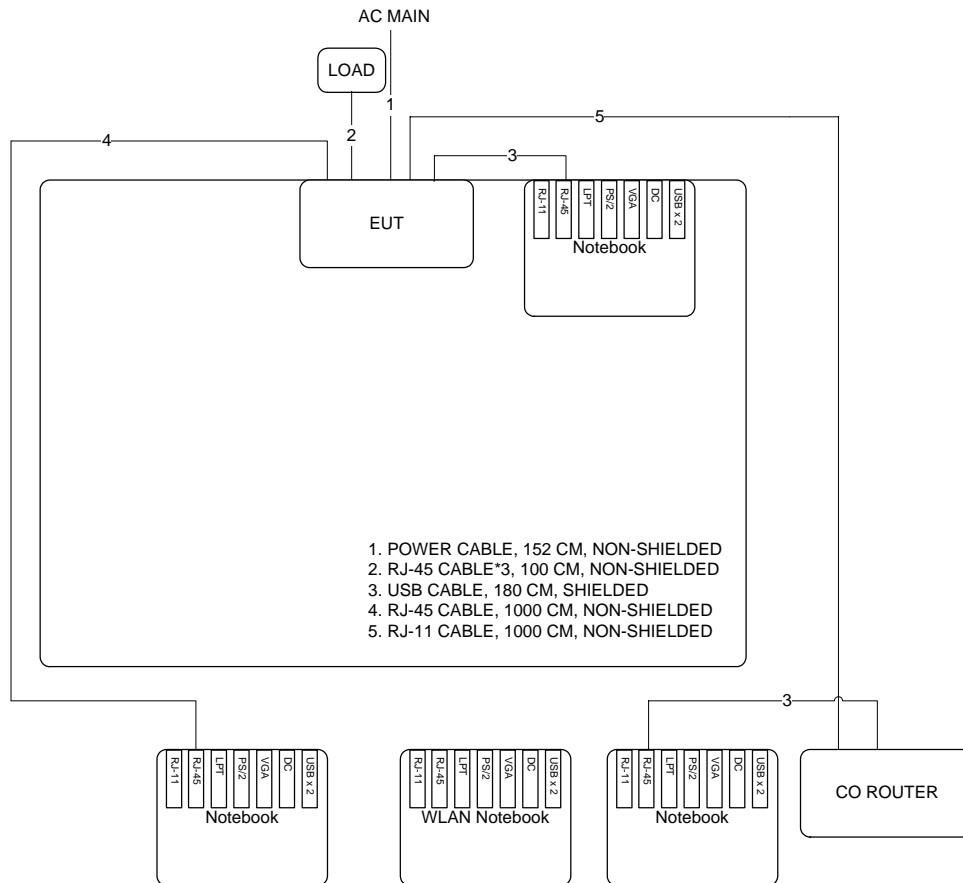

Test Mode: Mode 2

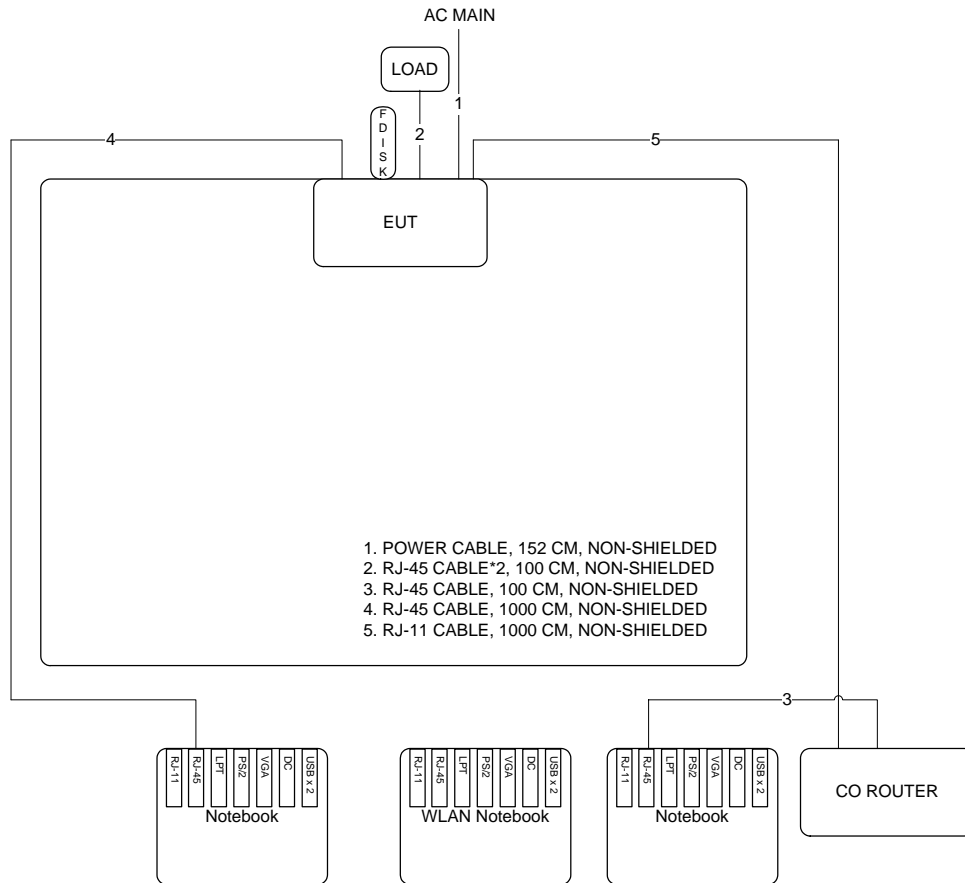

Test Configuration: above 1GHz

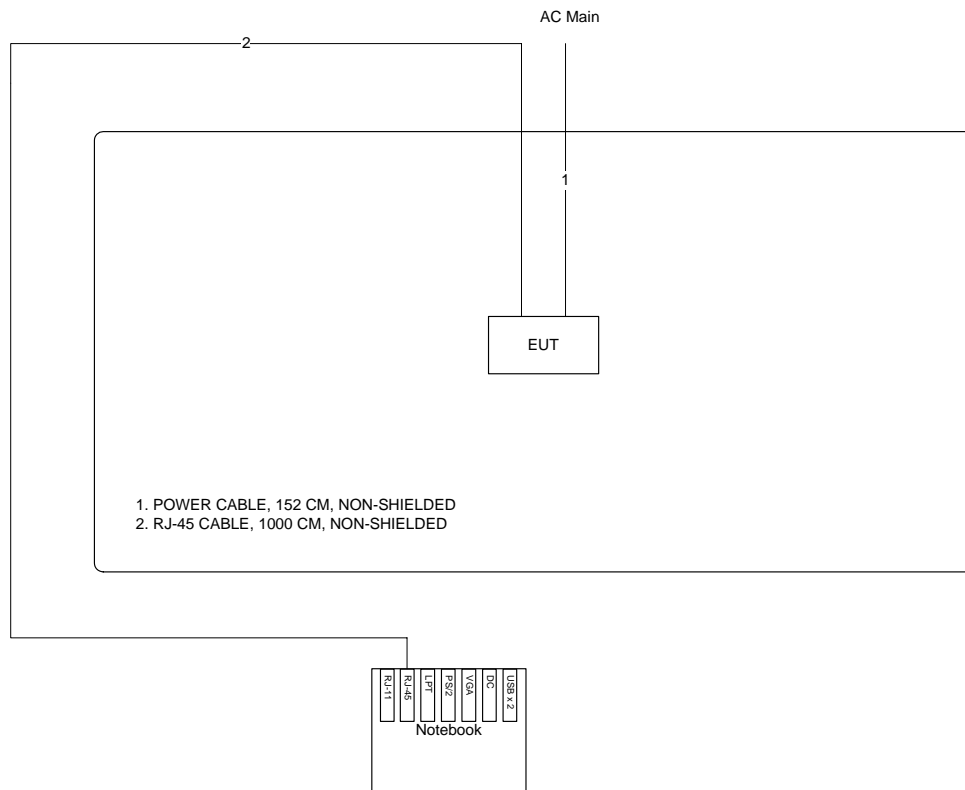

3.10.2. AC Power Line Conduction Emissions Test Configuration

Test Mode: Mode 1

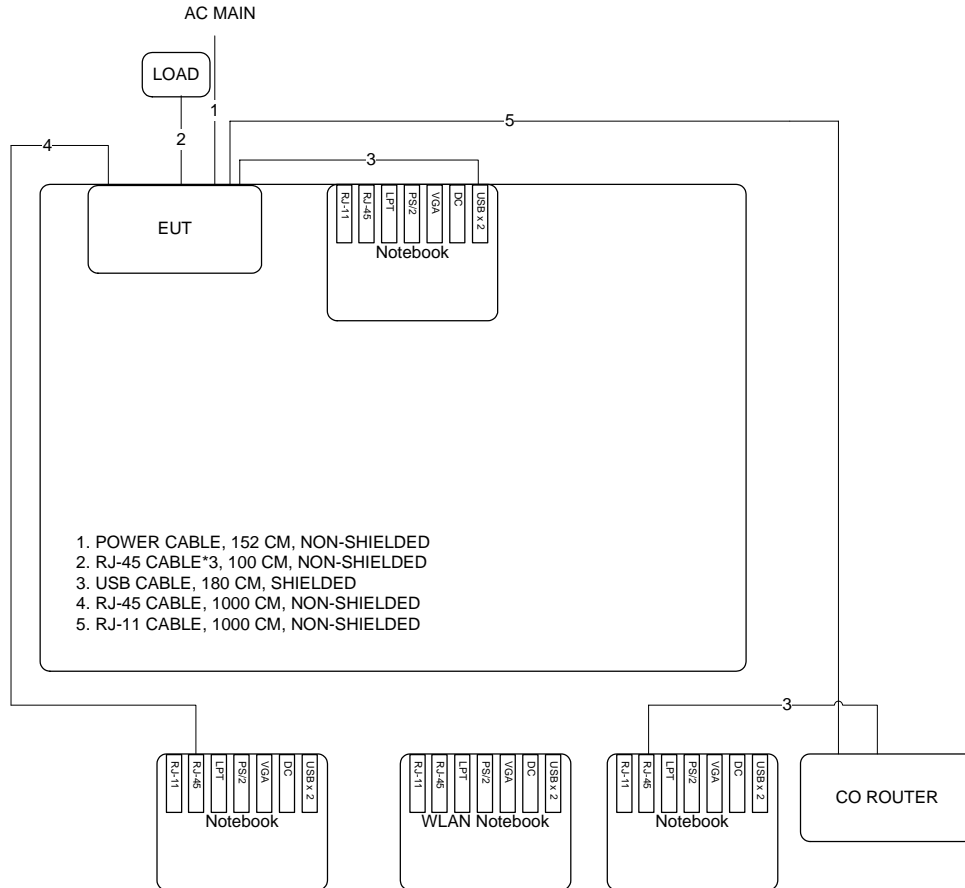

Test Mode: Mode 2

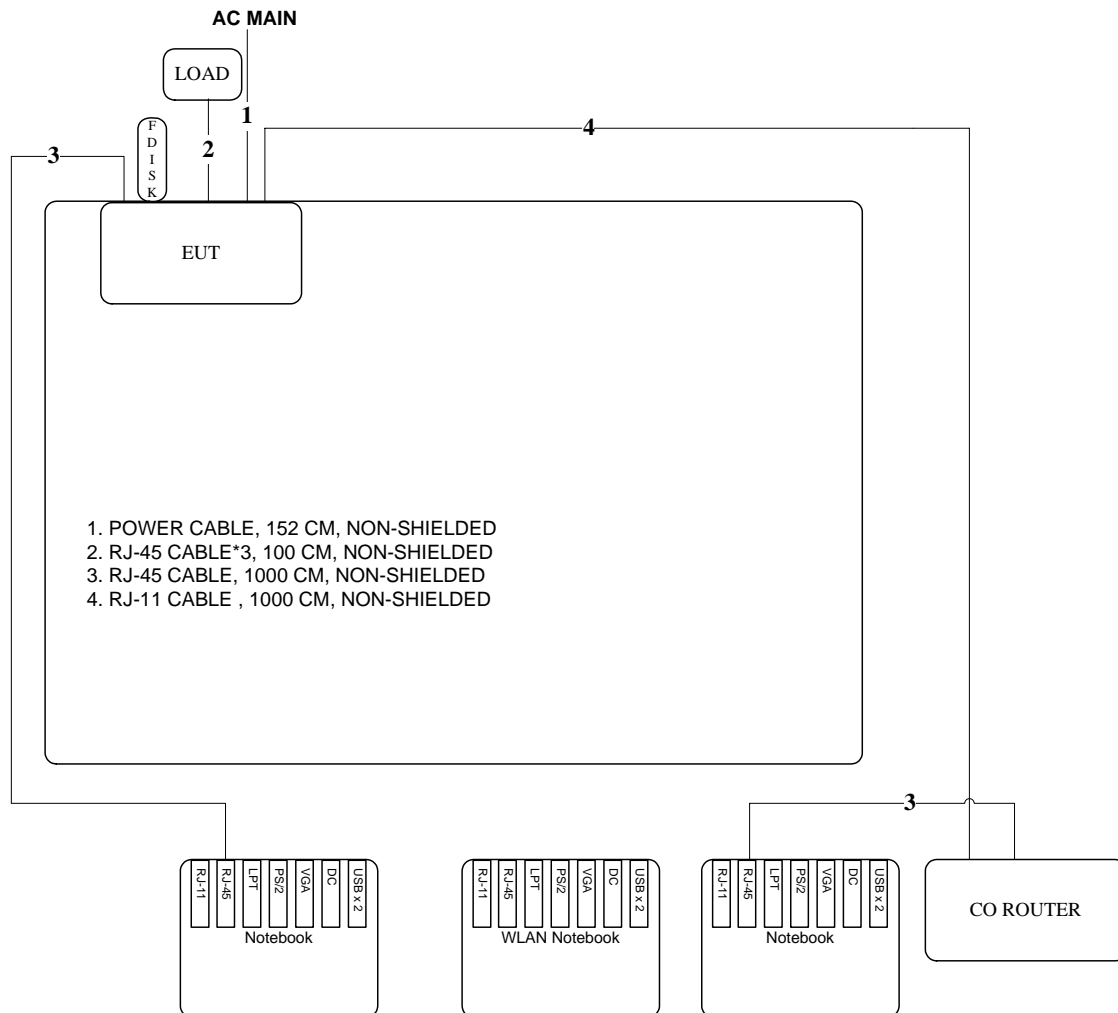

4. TEST RESULT

4.1. AC Power Line Conducted Emissions Measurement

4.1.1. Limit

For this product which is designed to be connected to the AC power line, the radio frequency voltage that is conducted back onto the AC power line on any frequency or frequencies within the band 150 kHz to 30 MHz shall not exceed below limits table.

Frequency (MHz)	QP Limit (dBuV)	AV Limit (dBuV)
0.15~0.5	66~56	56~46
0.5~5	56	46
5~30	60	50

4.1.2. Measuring Instruments and Setting

Please refer to section 5 of equipments list in this report. The following table is the setting of the receiver.

Receiver Parameters	Setting
Attenuation	10 dB
Start Frequency	0.15 MHz
Stop Frequency	30 MHz
IF Bandwidth	9 KHz

4.1.3. Test Procedures

1. Configure the EUT according to ANSI C63.4. The EUT or host of EUT has to be placed 0.4 meter far from the conducting wall of the shielding room and at least 80 centimeters from any other grounded conducting surface.
2. Connect EUT or host of EUT to the power mains through a line impedance stabilization network (LISN).
3. All the support units are connected to the other LISNs. The LISN should provide 50uH/50ohms coupling impedance.
4. The frequency range from 150 KHz to 30 MHz was searched.
5. Set the test-receiver system to Peak Detect Function and Specified Bandwidth with Maximum Hold Mode.
6. The measurement has to be done between each power line and ground at the power terminal.

4.1.4. Test Setup Layout

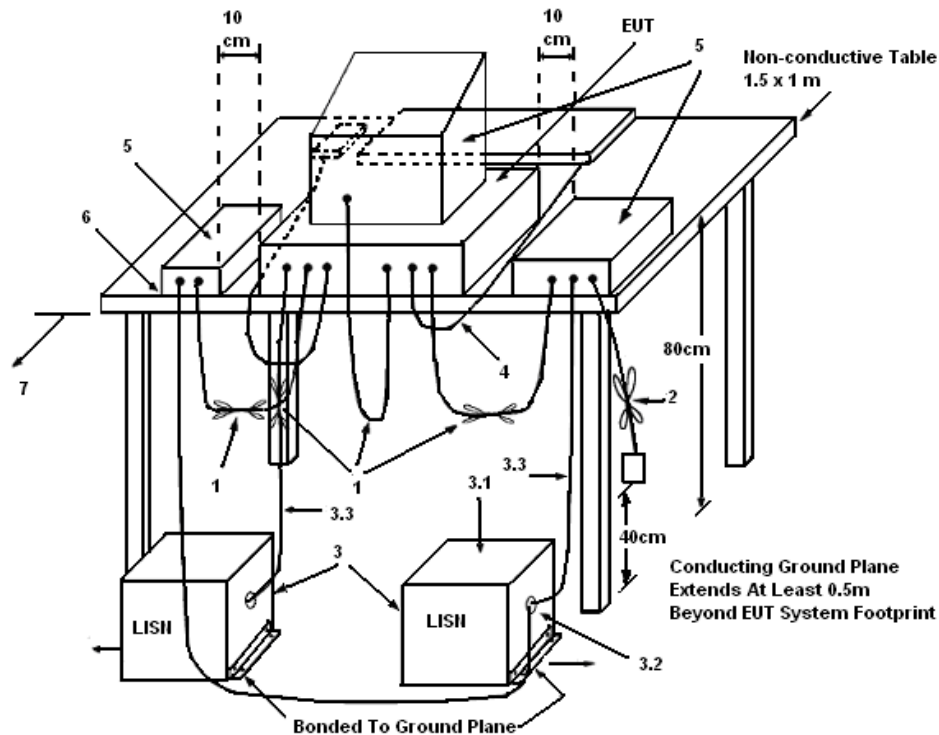

LEGEND:

- (1) Interconnecting cables that hang closer than 40 cm to the ground plane shall be folded back and forth in the center forming a bundle 30 to 40 cm long.
- (2) I/O cables that are not connected to a peripheral shall be bundled in the center. The end of the cable may be terminated, if required, using the correct terminating impedance. The overall length shall not exceed 1 m.
- (3) EUT connected to one LISN. Unused LISN measuring port connectors shall be terminated in 50 Ω . LISN can be placed on top of, or immediately beneath, reference ground plane.
 - (3.1) All other equipment powered from additional LISN(s).
 - (3.2) Multiple outlet strip can be used for multiple power cords of non-EUT equipment.
 - (3.3) LISN at least 80 cm from nearest part of EUT chassis.
- (4) Cables of hand-operated devices, such as keyboards, mice, etc., shall be placed as for normal use.
- (5) Non-EUT components of EUT system being tested.
- (6) Rear of EUT, including peripherals, shall all be aligned and flush with rear of tabletop.
- (7) Rear of tabletop shall be 40 cm removed from a vertical conducting plane that is bonded to the ground plane.

4.1.5. Test Deviation

There is no deviation with the original standard.

4.1.6. EUT Operation during Test

The EUT was placed on the test table and programmed in normal function.

4.1.7. Results of AC Power Line Conducted Emissions Measurement

Temperature	25°C	Humidity	55%
Test Engineer	Aric Li	Phase	Line
Configuration	Normal Link / Mode 1		

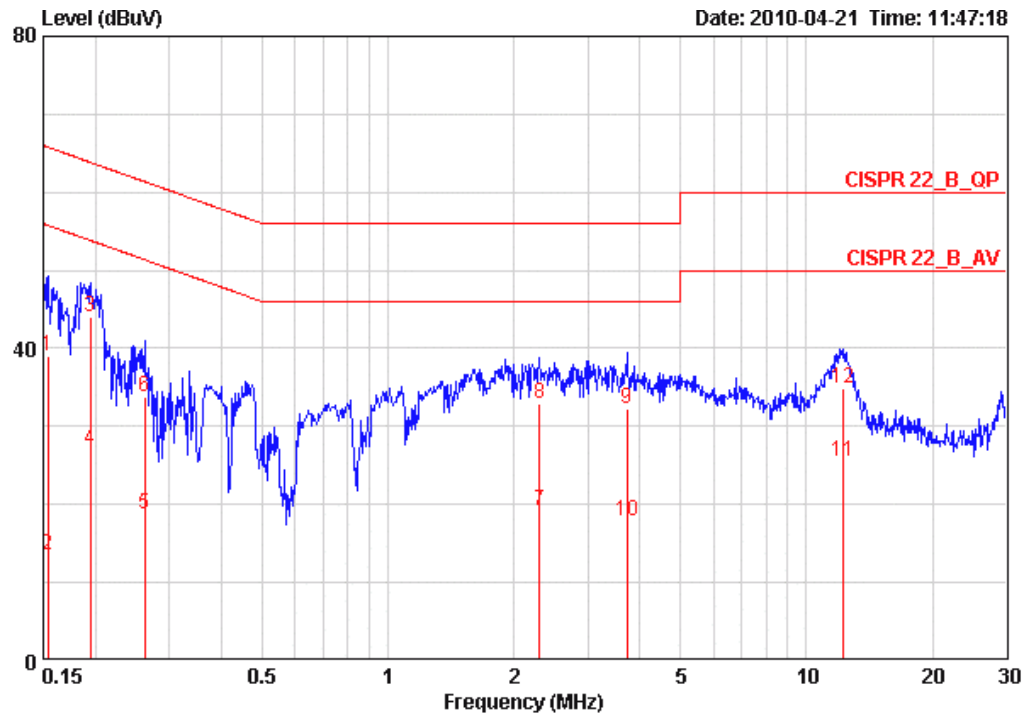

	Freq	Level	Over Limit	Limit Line	Read Level	LISN Factor	Cable Loss	Remark
	MHz	dBuV	dB	dBuV	dBuV	dB	dB	
1	0.15403	39.10	-26.68	65.78	38.83	0.07	0.20	QP
2	0.15403	13.57	-42.21	55.78	13.30	0.07	0.20	AVERAGE
3	0.19447	44.05	-19.79	63.84	43.80	0.05	0.20	QP
4	0.19447	26.98	-26.86	53.84	26.73	0.05	0.20	AVERAGE
5	0.26164	18.78	-32.60	51.38	18.54	0.04	0.20	AVERAGE
6	0.26164	33.81	-27.57	61.38	33.57	0.04	0.20	QP
7	2.297	19.15	-26.85	46.00	18.89	0.06	0.20	AVERAGE
8	2.297	32.89	-23.11	56.00	32.63	0.06	0.20	QP
9	3.720	32.22	-23.78	56.00	31.83	0.09	0.30	QP
10	3.720	17.86	-28.14	46.00	17.47	0.09	0.30	AVERAGE
11	12.253	25.42	-24.58	50.00	24.57	0.45	0.40	AVERAGE
12	12.253	34.86	-25.14	60.00	34.01	0.45	0.40	QP

Temperature	25°C	Humidity	55%
Test Engineer	Aric Li	Phase	Neutral
Configuration	Normal Link / Mode 1		

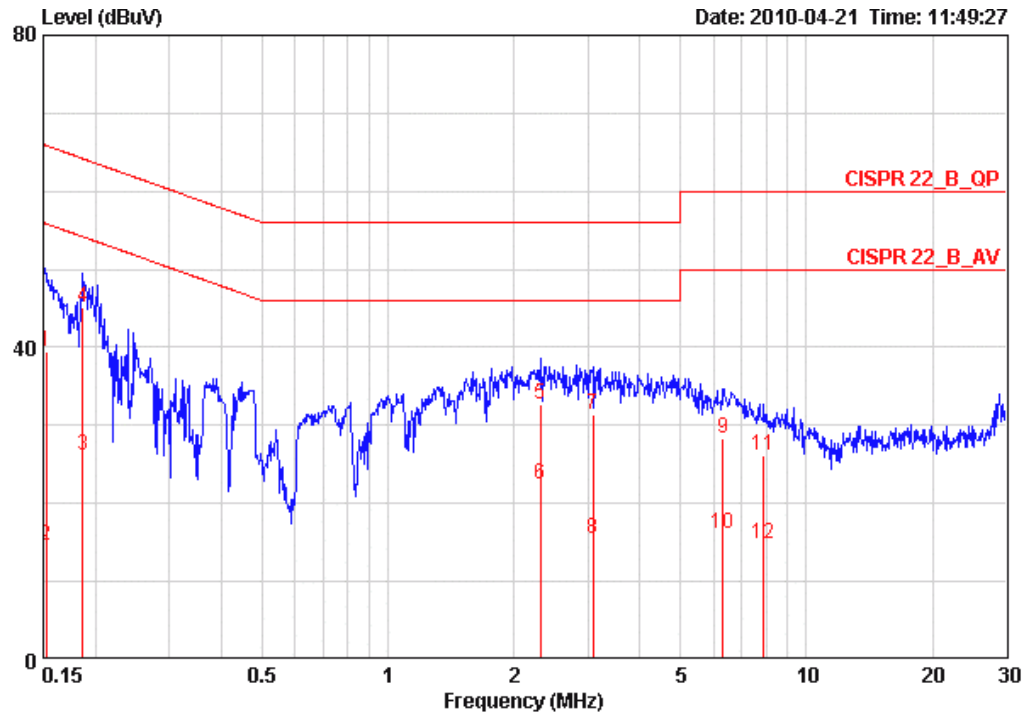

	Freq	Level	Over Limit	Limit Line	Read Level	LISN Factor	Cable Loss	Remark
	MHz	dBuV	dB	dBuV	dBuV	dB	dB	
1	0.15240	39.39	-26.47	65.87	39.09	0.10	0.20	QP
2	0.15240	14.62	-41.24	55.87	14.32	0.10	0.20	AVERAGE
3	0.18640	26.25	-27.95	54.20	25.96	0.09	0.20	AVERAGE
4	0.18640	45.10	-19.10	64.20	44.81	0.09	0.20	QP
5	2.309	32.80	-23.20	56.00	32.50	0.10	0.20	QP
6	2.309	22.44	-23.56	46.00	22.14	0.10	0.20	AVERAGE
7	3.090	31.34	-24.66	56.00	31.00	0.12	0.22	QP
8	3.090	15.39	-30.61	46.00	15.05	0.12	0.22	AVERAGE
9	6.319	28.37	-31.63	60.00	27.74	0.26	0.36	QP
10	6.319	16.17	-33.83	50.00	15.54	0.26	0.36	AVERAGE
11	7.893	26.24	-33.76	60.00	25.52	0.32	0.40	QP
12	7.893	14.83	-35.17	50.00	14.11	0.32	0.40	AVERAGE

Note:

Level = Read Level + LISN Factor + Cable Loss.

Temperature	25°C	Humidity	55%
Test Engineer	Aric Li	Phase	Line
Configuration	Normal Link / Mode 2		

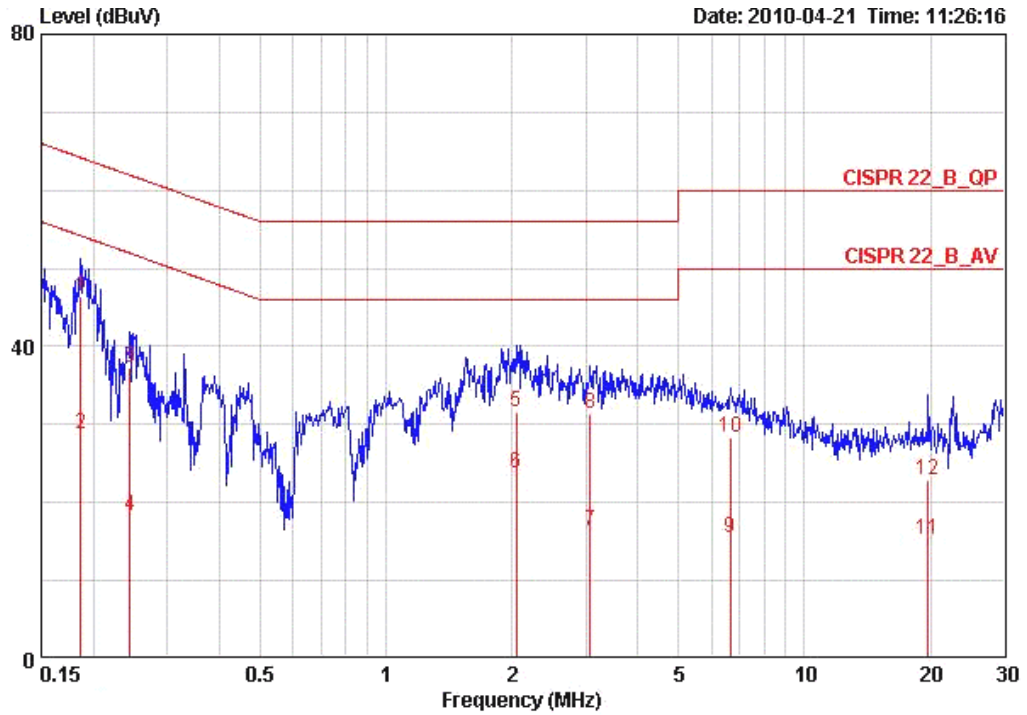

	Freq	Level	Over Limit	Limit Line	Read Level	LISN Factor	Cable Loss	Remark
	MHz	dBuV	dB	dBuV	dBuV	dB	dB	
1	0.18640	46.45	-17.75	64.20	46.19	0.06	0.20	QP
2	0.18640	28.75	-25.45	54.20	28.49	0.06	0.20	AVERAGE
3	0.24422	37.34	-24.61	61.95	37.10	0.04	0.20	QP
4	0.24422	18.30	-33.65	51.95	18.06	0.04	0.20	AVERAGE
5	2.044	31.60	-24.40	56.00	31.35	0.05	0.20	QP
6	2.044	23.86	-22.14	46.00	23.61	0.05	0.20	AVERAGE
7	3.074	16.29	-29.71	46.00	15.99	0.08	0.22	AVERAGE
8	3.074	31.42	-24.58	56.00	31.12	0.08	0.22	QP
9	6.662	15.56	-34.44	50.00	14.96	0.24	0.36	AVERAGE
10	6.662	28.27	-31.73	60.00	27.67	0.24	0.36	QP
11	19.740	15.26	-34.74	50.00	13.95	0.81	0.50	AVERAGE
12	19.740	22.94	-37.06	60.00	21.63	0.81	0.50	QP

Temperature	25°C	Humidity	55%
Test Engineer	Aric Li	Phase	Neutral
Configuration	Normal Link / Mode 2		

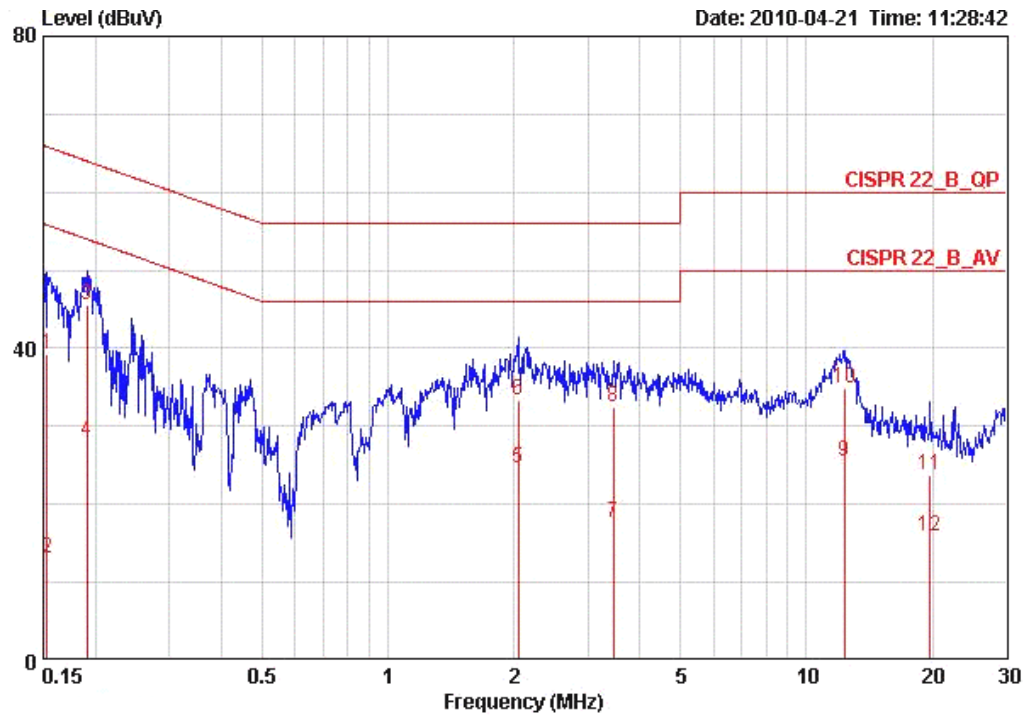

	Freq	Level	Over Limit	Limit Line	Read Level	LISN Factor	Cable Loss	Remark
	MHz	dBuV	dB	dBuV	dBuV	dB	dB	
1	0.15321	39.33	-26.49	65.82	39.03	0.10	0.20	QP
2	0.15321	13.03	-42.79	55.82	12.73	0.10	0.20	AVERAGE
3	0.19039	45.56	-18.46	64.02	45.28	0.08	0.20	QP
4	0.19039	28.01	-26.01	54.02	27.73	0.08	0.20	AVERAGE
5	2.044	24.63	-21.37	46.00	24.34	0.09	0.20	AVERAGE
6	2.044	33.30	-22.70	56.00	33.01	0.09	0.20	QP
7	3.454	17.55	-28.45	46.00	17.13	0.13	0.29	AVERAGE
8	3.454	32.49	-23.51	56.00	32.07	0.13	0.29	QP
9	12.318	25.59	-24.41	50.00	24.71	0.48	0.40	AVERAGE
10	12.318	34.88	-25.12	60.00	34.00	0.48	0.40	QP
11	19.740	23.76	-36.24	60.00	22.47	0.79	0.50	QP
12	19.740	16.00	-34.00	50.00	14.71	0.79	0.50	AVERAGE

Note:

Level = Read Level + LISN Factor + Cable Loss.

4.2. Maximum Conducted Output Power Measurement

4.2.1. Limit

For systems using digital modulation in the 2400-2483.5MHz, the limit for peak output power is 30dBm. The limited has to be reduced by the amount in dB that the gain of the antenna exceed 6dBi. In case of point-to-point operation, the limit has to be reduced by 1dB for every 3dB that the directional gain of the antenna exceeds 6dBi.

4.2.2. Measuring Instruments and Setting

Please refer to section 5 of equipments list in this report. The following table is the setting of the spectrum analyzer.

Spectrum Parameter	Setting
Attenuation	Auto
Span Frequency	Encompass the entire emissions bandwidth (EBW) of the signal
RB	1MHz
VB	3MHz
Detector	RMS
Trace	Max Hold
Sweep Time	Auto

4.2.3. Test Procedures

1. The transmitter output (antenna port) was connected to the spectrum analyzer.
2. Test was performed in accordance with Measurement of Digital Transmission Systems Operating under Section 15.247 March 23, 2005.

4.2.4. Test Setup Layout

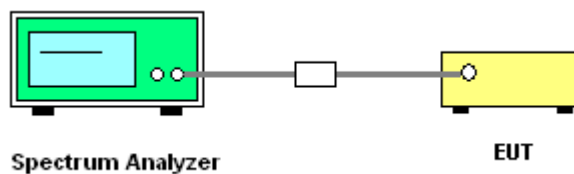

4.2.5. Test Deviation

There is no deviation with the original standard.

4.2.6. EUT Operation during Test

The EUT was programmed to be in continuously transmitting mode.

4.2.7. Test Result of Maximum Conducted Output Power

Temperature	23.5°C	Humidity	52.4%
Test Engineer	Sam Chen	Configurations	IEEE 802.11n

Configuration IEEE 802.11n MCS0 20MHz Ant. A

Channel	Frequency	Conducted Power (dBm)	Max. Limit (dBm)	Result
1	2412 MHz	14.73	30.00	Complies
6	2437 MHz	21.03	30.00	Complies
11	2462 MHz	15.70	30.00	Complies

Configuration IEEE 802.11n MCS0 40MHz Ant. A

Channel	Frequency	Conducted Power (dBm)	Max. Limit (dBm)	Result
3	2422 MHz	13.33	30.00	Complies
6	2437 MHz	14.58	30.00	Complies
9	2452 MHz	13.55	30.00	Complies

Temperature	23.5°C	Humidity	52.4%
Test Engineer	Sam Chen	Configurations	IEEE 802.11b/g

Configuration IEEE 802.11b Ant. A

Channel	Frequency	Conducted Power (dBm)	Max. Limit (dBm)	Result
1	2412 MHz	14.13	30.00	Complies
6	2437 MHz	14.37	30.00	Complies
11	2462 MHz	14.25	30.00	Complies

Configuration IEEE 802.11g Ant. A

Channel	Frequency	Conducted Power (dBm)	Max. Limit (dBm)	Result
1	2412 MHz	17.05	30.00	Complies
6	2437 MHz	21.76	30.00	Complies
11	2462 MHz	15.75	30.00	Complies

Note: All the test values were listed in the report.

For plots, only the worse case of DSSS and OFDM modulation were listed in the report.

Conducted Output Power Plot on Configuration IEEE 802.11b Ant. A / 2412 MHz

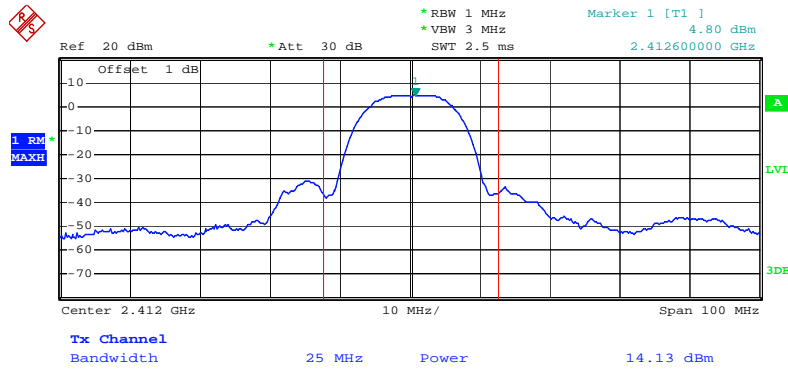

Date: 20.APR.2010 10:33:31

Conducted Output Power Plot on Configuration IEEE 802.11b Ant. A / 2437 MHz

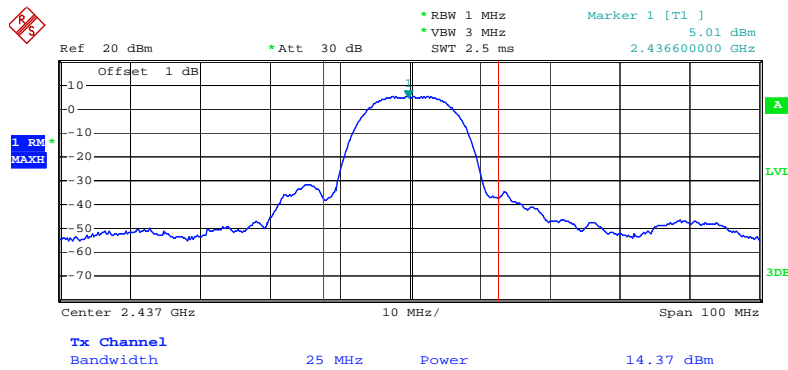

Date: 20.APR.2010 10:34:25

Conducted Output Power Plot on Configuration IEEE 802.11b Ant. A / 2462 MHz

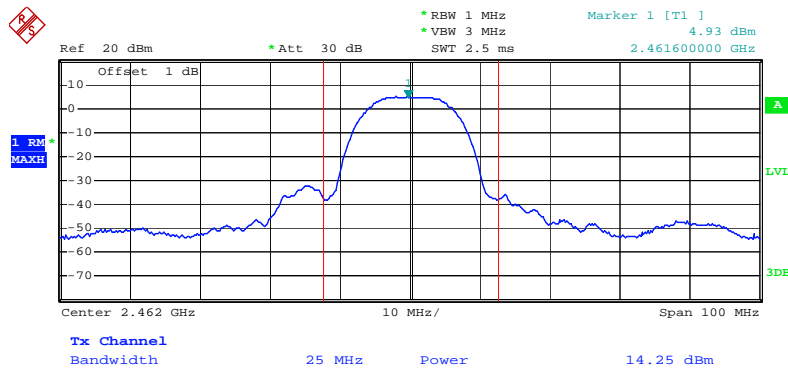

Date: 20.APR.2010 10:35:08

Conducted Output Power Plot on Configuration IEEE 802.11g Ant. A / 2412 MHz

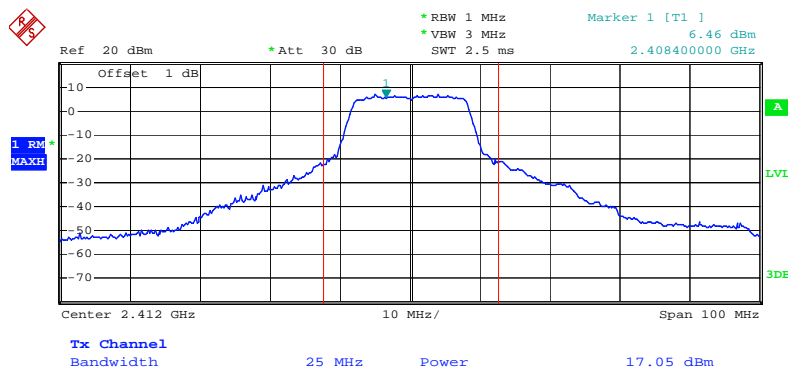

Date: 20.APR.2010 10:37:42

Conducted Output Power Plot on Configuration IEEE 802.11g Ant. A / 2437 MHz

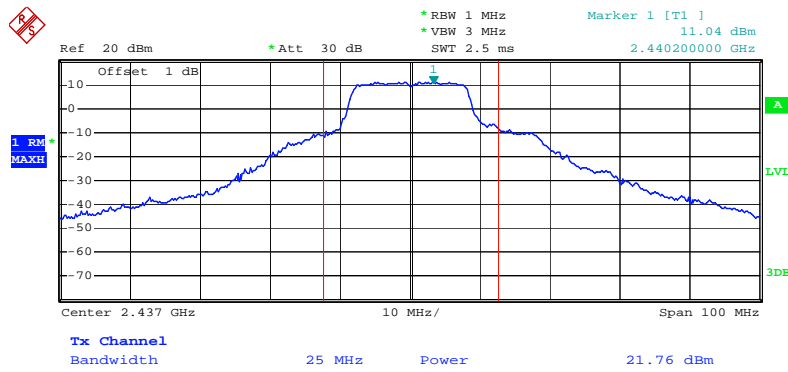

Date: 20.APR.2010 10:36:51

Conducted Output Power Plot on Configuration IEEE 802.11g Ant. A / 2462 MHz

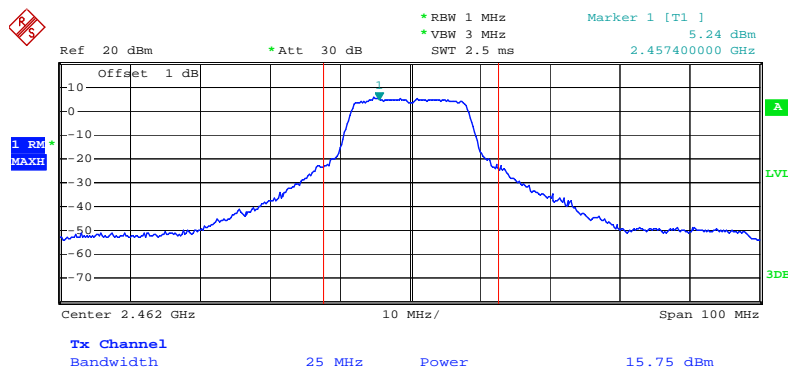

Date: 20.APR.2010 10:36:07

4.3. Power Spectral Density Measurement

4.3.1. Limit

For digitally modulated systems, the power spectral density conducted from the intentional radiator to the antenna shall not be greater than 8 dBm in any 3 kHz band during any time interval of continuous transmission.

4.3.2. Measuring Instruments and Setting

Please refer to section 5 of equipments list in this report. The following table is the setting of Spectrum Analyzer.

Spectrum Parameter	Setting
Attenuation	Auto
Span Frequency	30 kHz
RB	3 kHz
VB	30 kHz
Detector	Peak
Trace	Max Hold
Sweep Time	10s

4.3.3. Test Procedures

1. The transmitter output (antenna port) was connected to the spectrum analyzer.
2. Set RBW of spectrum analyzer to 3kHz and VBW to 30kHz. Set Detector to Peak, Trace to Max Hold.
3. Mark the frequency with maximum peak power as the center of the display of the spectrum.
4. Set the span to 30kHz and the sweep time to 10s and record the maximum peak value.

4.3.4. Test Setup Layout

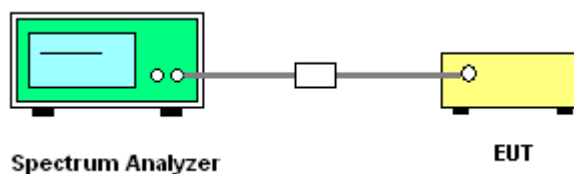

4.3.5. Test Deviation

There is no deviation with the original standard.

4.3.6. EUT Operation during Test

The EUT was programmed to be in continuously transmitting mode.

4.3.7. Test Result of Power Spectral Density

Temperature	23.5°C	Humidity	52.4%
Test Engineer	Sam Chen	Configurations	IEEE 802.11n

Configuration IEEE 802.11n MCS0 20MHz Ant. A

Channel	Frequency	Power Density (dBm/3kHz)	Max. Limit (dBm/3kHz)	Result
1	2412 MHz	-14.40	8.00	Complies
6	2437 MHz	-8.40	8.00	Complies
11	2462 MHz	-11.73	8.00	Complies

Configuration IEEE 802.11n MCS0 40MHz Ant. A

Channel	Frequency	Power Density (dBm/3kHz)	Max. Limit (dBm/3kHz)	Result
3	2422 MHz	-16.94	8.00	Complies
6	2437 MHz	-16.09	8.00	Complies
9	2452 MHz	-16.26	8.00	Complies

Temperature	23.5°C	Humidity	52.4%
Test Engineer	Sam Chen	Configurations	IEEE 802.11b/g

Configuration IEEE 802.11b Ant. A

Channel	Frequency	Power Density (dBm/3kHz)	Max. Limit (dBm/3kHz)	Result
1	2412 MHz	-13.14	8.00	Complies
6	2437 MHz	-12.27	8.00	Complies
11	2462 MHz	-12.55	8.00	Complies

Configuration IEEE 802.11g Ant. A

Channel	Frequency	Power Density (dBm/3kHz)	Max. Limit (dBm/3kHz)	Result
1	2412 MHz	-10.38	8.00	Complies
6	2437 MHz	-6.64	8.00	Complies
11	2462 MHz	-12.75	8.00	Complies

Note: All the test values were listed in the report.

For plots, only the worse case of DSSS and OFDM modulation were listed in the report.

Power Density Plot on Configuration IEEE 802.11b Ant. A / 2412 MHz

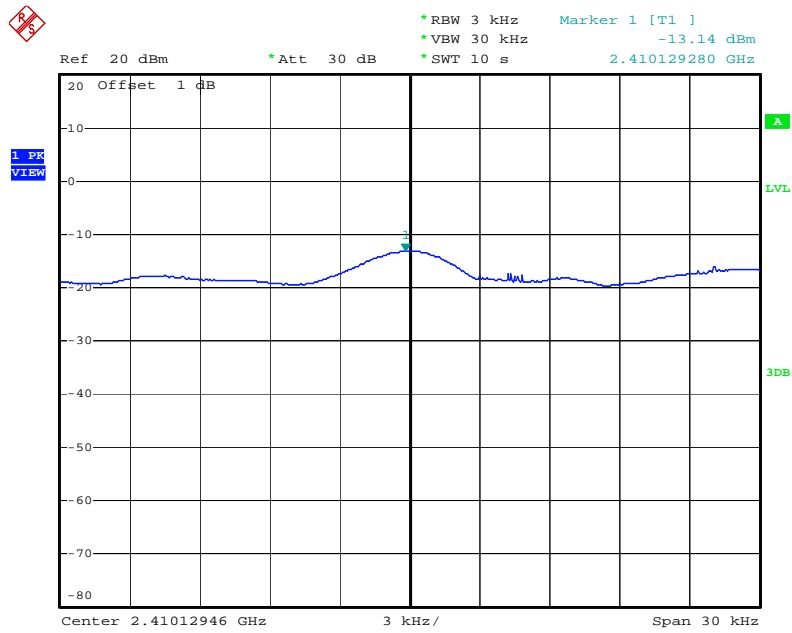

Date: 20.APR.2010 11:23:25

Power Density Plot on Configuration IEEE 802.11b Ant. A / 2437 MHz

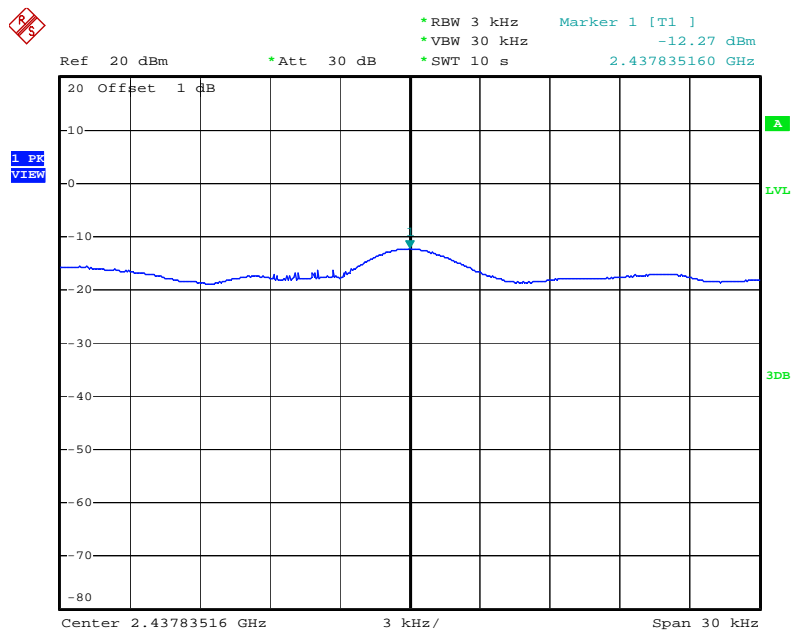

Date: 20.APR.2010 11:21:24

Power Density Plot on Configuration IEEE 802.11b Ant. A / 2462 MHz

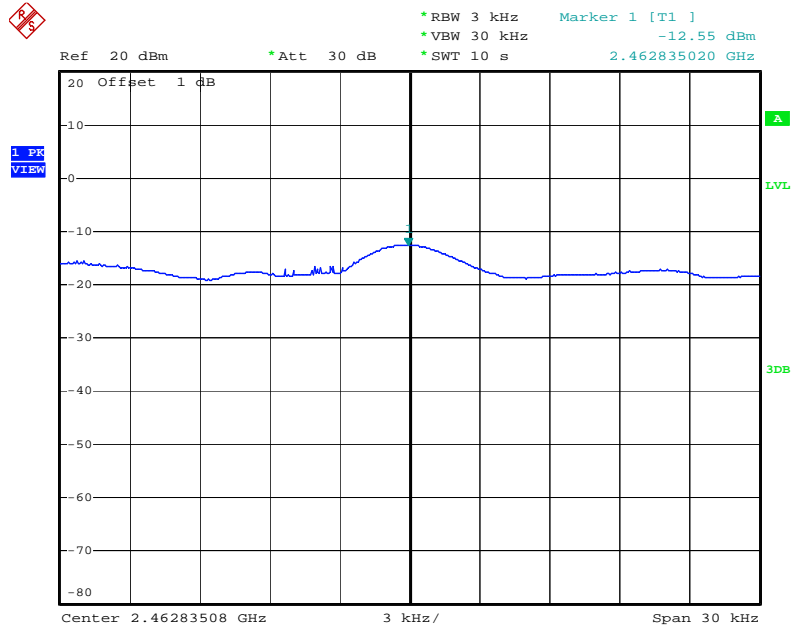

Date: 20.APR.2010 11:19:17

Power Density Plot on Configuration IEEE 802.11g Ant. A / 2412 MHz

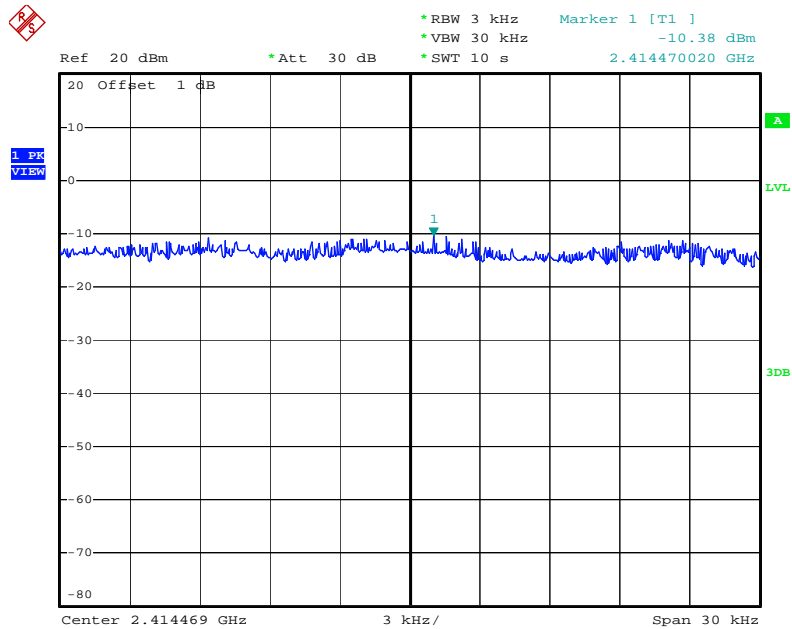

Date: 20.APR.2010 11:11:44

Power Density Plot on Configuration IEEE 802.11g Ant. A / 2437 MHz

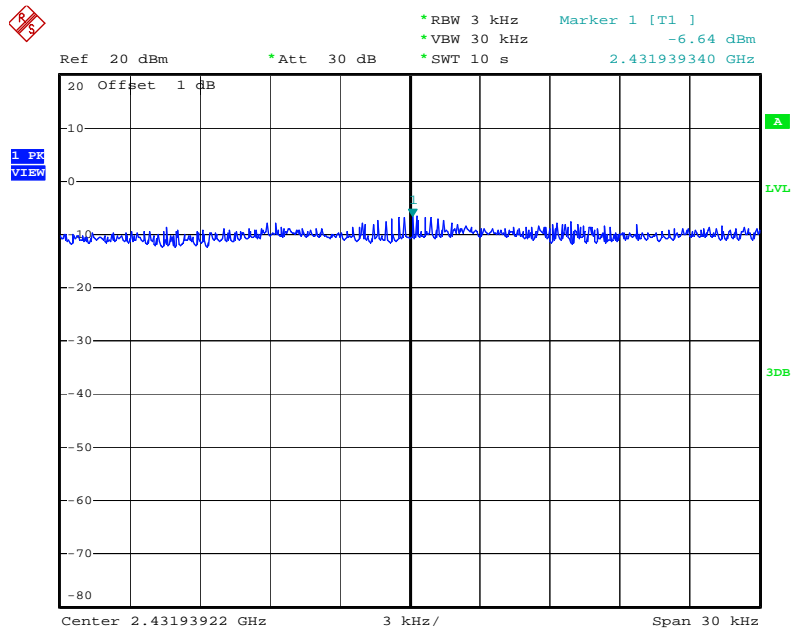

Date: 20.APR.2010 11:14:04

Power Density Plot on Configuration IEEE 802.11g Ant. A / 2462 MHz

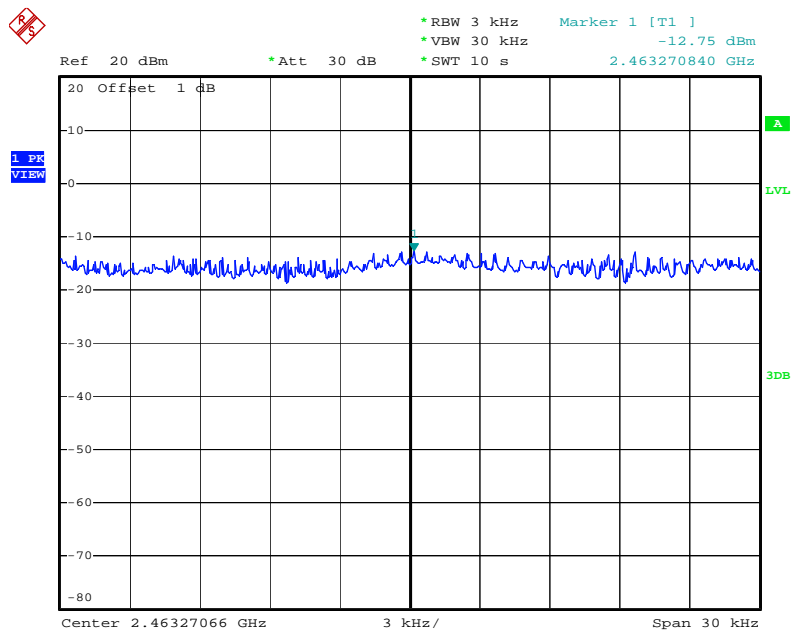

Date: 20.APR.2010 11:16:22

4.4. 6dB Spectrum Bandwidth Measurement

4.4.1. Limit

For digital modulation systems, the minimum 6 dB bandwidth shall be at least 500 kHz.

4.4.2. Measuring Instruments and Setting

Please refer to section 5 of equipments list in this report. The following table is the setting of the Spectrum Analyzer.

Spectrum Parameters	Setting
Attenuation	Auto
Span Frequency	> 6dB Bandwidth
RB	100 kHz
VB	100 kHz
Detector	Peak
Trace	Max Hold
Sweep Time	Auto

4.4.3. Test Procedures

1. The transmitter output (antenna port) was connected to the spectrum analyzer in peak hold mode.
2. The resolution bandwidth of 100 kHz and the video bandwidth of 100 kHz were used.
3. Measured the spectrum width with power higher than 6dB below carrier.
4. Measuring multiple antennas, the connector is required to link with spectrum analyzer through a combiner.

4.4.4. Test Setup Layout

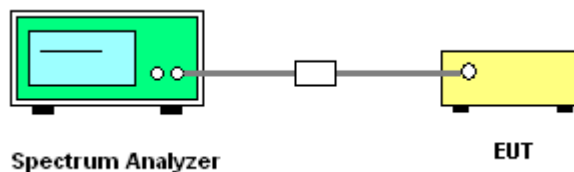

4.4.5. Test Deviation

There is no deviation with the original standard.

4.4.6. EUT Operation during Test

The EUT was programmed to be in continuously transmitting mode.

4.4.7. Test Result of 6dB Spectrum Bandwidth

Temperature	23.5°C	Humidity	52.4%
Test Engineer	Sam Chen	Configurations	IEEE 802.11n

Configuration IEEE 802.11n MCS0 20MHz Ant. A

Channel	Frequency	6dB Bandwidth (MHz)	99% Occupied Bandwidth (MHz)	Min. Limit (kHz)	Test Result
1	2412 MHz	17.32	17.60	500	Complies
6	2437 MHz	17.06	17.60	500	Complies
11	2462 MHz	17.36	17.56	500	Complies

Configuration IEEE 802.11n MCS0 40MHz Ant. A

Channel	Frequency	6dB Bandwidth (MHz)	99% Occupied Bandwidth (MHz)	Min. Limit (kHz)	Test Result
3	2422 MHz	35.76	36.00	500	Complies
6	2437 MHz	35.52	35.92	500	Complies
9	2452 MHz	35.44	36.00	500	Complies

Temperature	23.5°C	Humidity	52.4%
Test Engineer	Sam Chen	Configurations	IEEE 802.11b/g

Configuration IEEE 802.11b Ant. A

Channel	Frequency	6dB Bandwidth (MHz)	99% Occupied Bandwidth (MHz)	Min. Limit (kHz)	Test Result
1	2412 MHz	12.08	15.08	500	Complies
6	2437 MHz	12.60	15.04	500	Complies
11	2462 MHz	12.04	15.04	500	Complies

Configuration IEEE 802.11g Ant. A

Channel	Frequency	6dB Bandwidth (MHz)	99% Occupied Bandwidth (MHz)	Min. Limit (kHz)	Test Result
1	2412 MHz	16.40	16.48	500	Complies
6	2437 MHz	16.32	16.48	500	Complies
11	2462 MHz	16.36	16.44	500	Complies

Note: All the test values were listed in the report.

For plots, only the worse case of DSSS and OFDM modulation were listed in the report.

6 dB Bandwidth Plot on Configuration IEEE 802.11b Ant. A / 2412 MHz

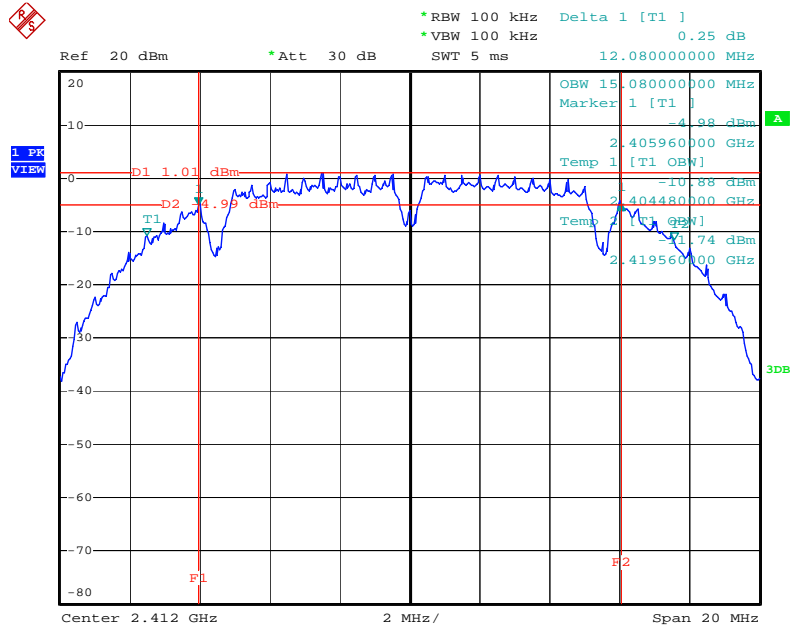

Date: 20.APR.2010 11:21:56

6 dB Bandwidth Plot on Configuration IEEE 802.11b Ant. A / 2437 MHz

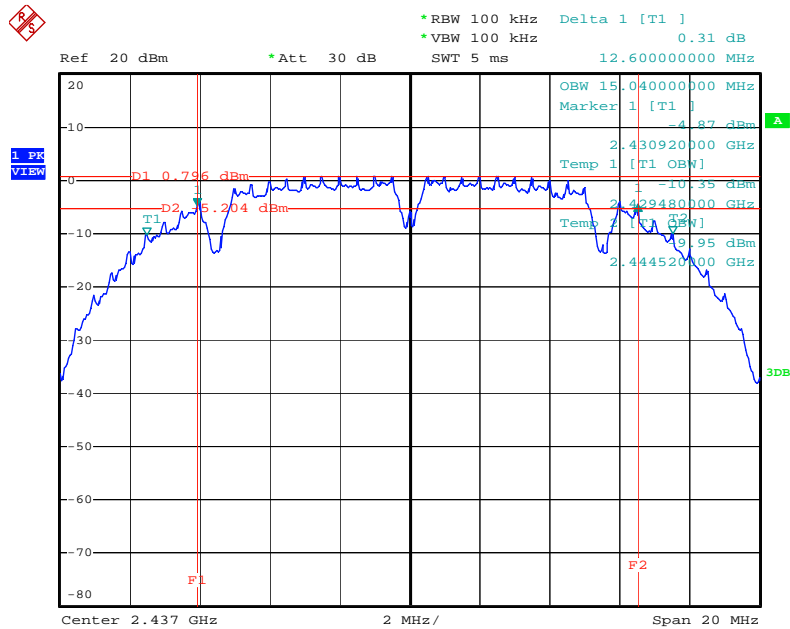

Date: 20.APR.2010 11:19:54

6 dB Bandwidth Plot on Configuration IEEE 802.11b Ant. A / 2462 MHz

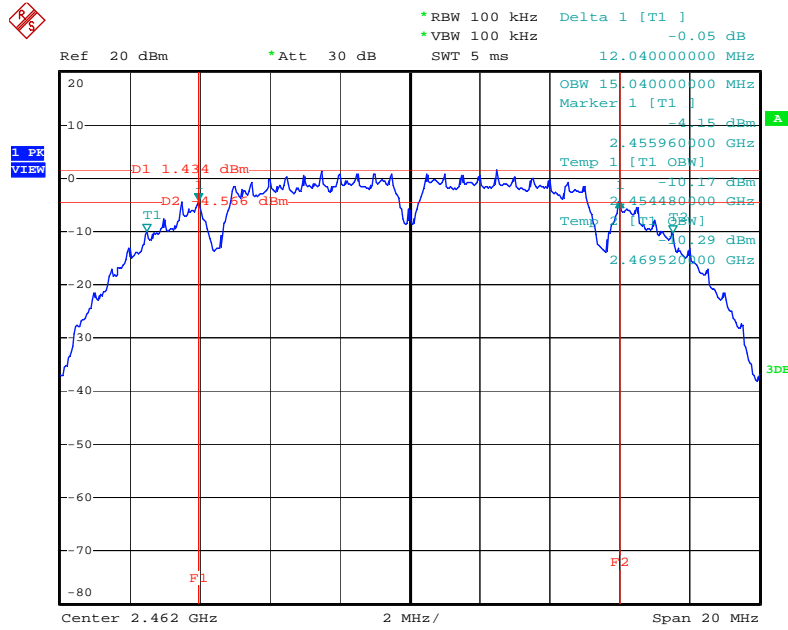

Date: 20.APR.2010 11:17:47

6 dB Bandwidth Plot on Configuration IEEE 802.11g Ant. A / 2412 MHz

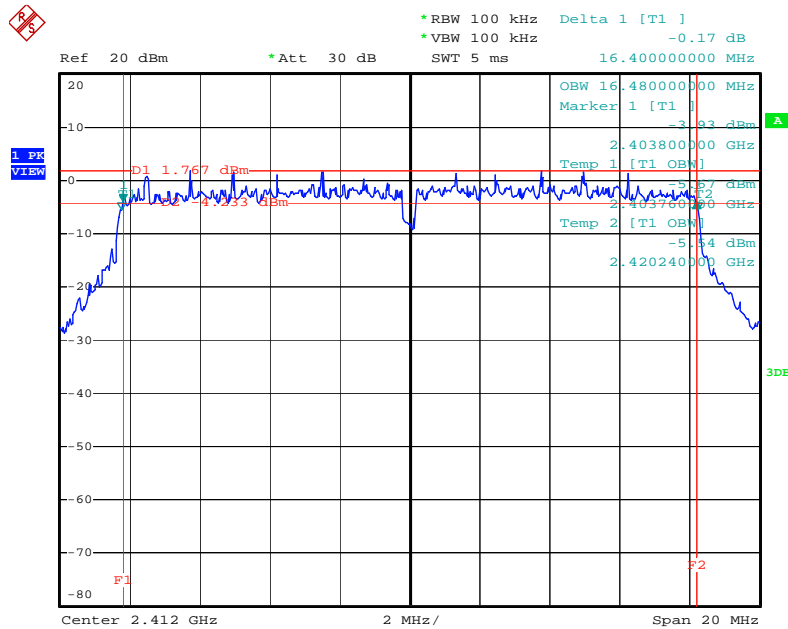

Date: 20.APR.2010 11:10:15

6 dB Bandwidth Plot on Configuration IEEE 802.11g Ant. A / 2437 MHz

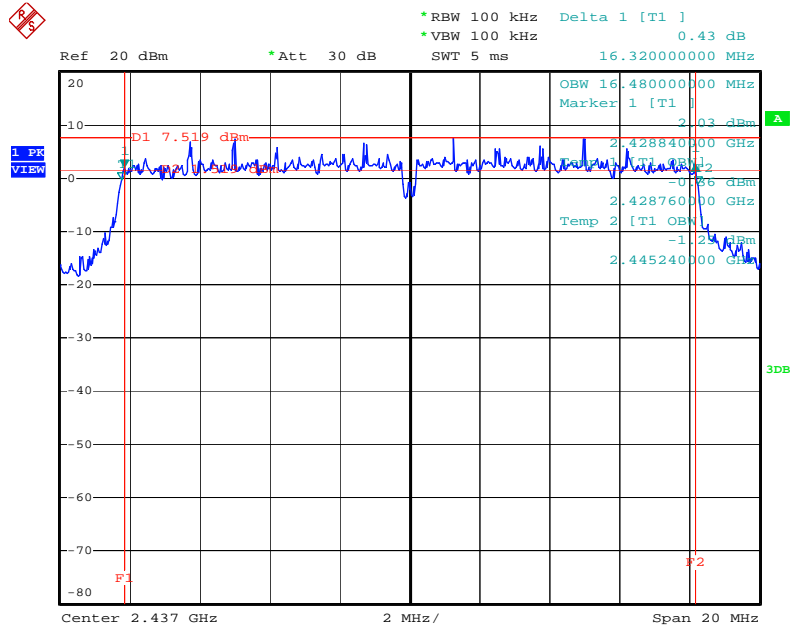

Date: 20.APR.2010 11:12:33

6 dB Bandwidth Plot on Configuration IEEE 802.11g Ant. A / 2462 MHz

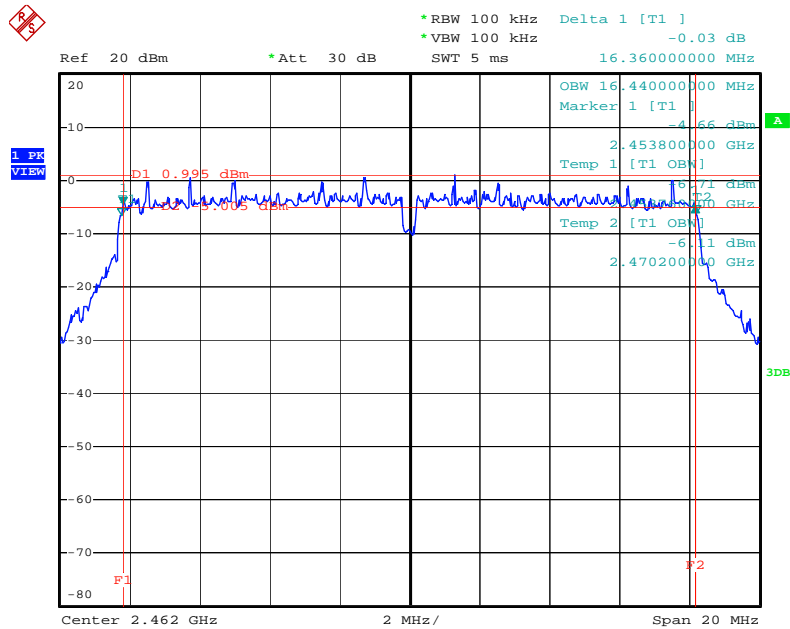

Date: 20.APR.2010 11:14:53

4.5. Radiated Emissions Measurement

4.5.1. Limit

20dBc in any 100 kHz bandwidth outside the operating frequency band. In case the emission fall within the restricted band specified on 15.205(a), then the 15.209(a) limit in the table below has to be followed.

Frequencies (MHz)	Field Strength (micorvolts/meter)	Measurement Distance (meters)
0.009~0.490	2400/F(KHz)	300
0.490~1.705	24000/F(KHz)	30
1.705~30.0	30	30
30~88	100	3
88~216	150	3
216~960	200	3
Above 960	500	3

4.5.2. Measuring Instruments and Setting

Please refer to section 5 of equipments list in this report. The following table is the setting of spectrum analyzer and receiver.

Spectrum Parameter	Setting
Attenuation	Auto
Start Frequency	1000 MHz
Stop Frequency	10th carrier harmonic
RB / VB (Emission in restricted band)	1MHz / 1MHz for Peak, 1 MHz / 10Hz for Average
RB / VB (Emission in non-restricted band)	1MHz / 1MHz for peak

Receiver Parameter	Setting
Attenuation	Auto
Start ~ Stop Frequency	9kHz~150kHz / RB 200Hz for QP
Start ~ Stop Frequency	150kHz~30MHz / RB 9kHz for QP
Start ~ Stop Frequency	30MHz~1000MHz / RB 120kHz for QP

4.5.3. Test Procedures

1. Configure the EUT according to ANSI C63.4. The EUT was placed on the top of the turntable 0.8 meter above ground. The phase center of the receiving antenna mounted on the top of a height-variable antenna tower was placed 3 meters far away from the turntable.
2. Power on the EUT and all the supporting units. The turntable was rotated by 360 degrees to determine the position of the highest radiation.
3. The height of the broadband receiving antenna was varied between one meter and four meters above ground to find the maximum emissions field strength of both horizontal and vertical polarization.
4. For each suspected emissions, the antenna tower was scan (from 1 m to 4 m) and then the turntable was rotated (from 0 degree to 360 degrees) to find the maximum reading.
5. Set the test-receiver system to Peak or CISPR quasi-peak Detect Function with specified bandwidth under Maximum Hold Mode.
6. For emissions above 1GHz, use 1MHz VBW and RBW for peak reading. Then 1MHz RBW and 10Hz VBW for average reading in spectrum analyzer.
7. When the radiated emissions limits are expressed in terms of the average value of the emissions, and pulsed operation is employed, the measurement field strength shall be determined by averaging over one complete pulse train, including blanking intervals, as long as the pulse train does not exceed 0.1 seconds. As an alternative (provided the transmitter operates for longer than 0.1 seconds) or in cases where the pulse train exceeds 0.1 seconds, the measured field strength shall be determined from the average absolute voltage during a 0.1 second interval during which the field strength is at its maximum value.
8. If the emissions level of the EUT in peak mode was 3 dB lower than the average limit specified, then testing will be stopped and peak values of EUT will be reported, otherwise, the emissions which do not have 3 dB margin will be repeated one by one using the quasi-peak method for below 1GHz.
9. For testing above 1GHz, the emissions level of the EUT in peak mode was lower than average limit (that means the emissions level in peak mode also complies with the limit in average mode), then testing will be stopped and peak values of EUT will be reported, otherwise, the emissions will be measured in average mode again and reported.
10. In case the emission is lower than 30MHz, loop antenna has to be used for measurement and the recorded data should be QP measured by receiver. High – Low scan is not required in this case.

4.5.4. Test Setup Layout

For radiated emissions below 30MHz

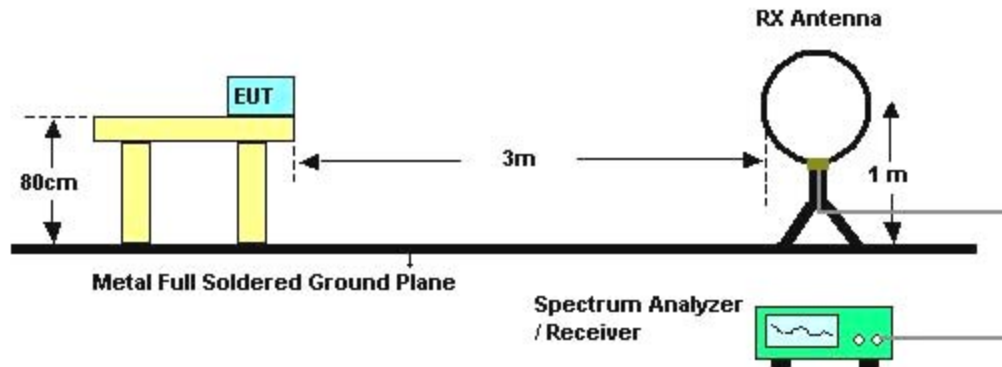

For radiated emissions above 30MHz

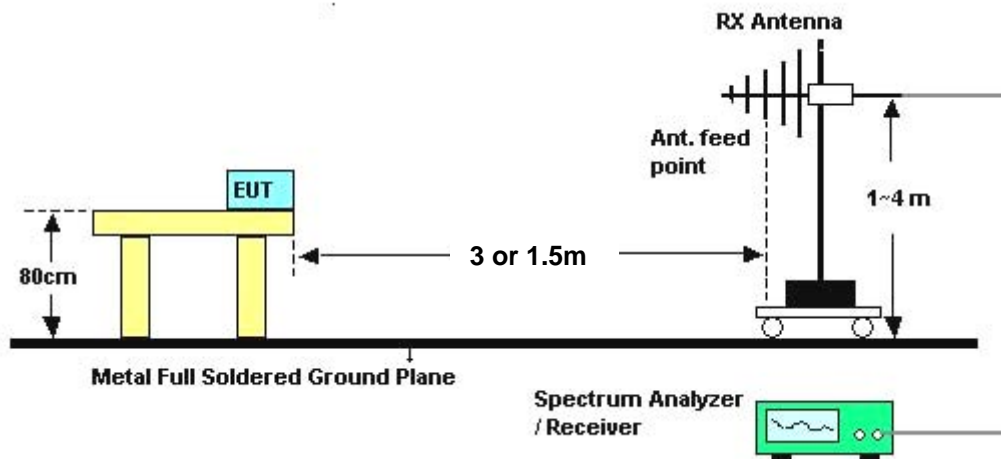

Above 10 GHz shall be extrapolated to the specified distance using an extrapolation factor of 20 dB/decade from 3m to 1.5m.

Distance extrapolation factor = $20 \log (\text{specific distance [3m]} / \text{test distance [1.5m]})$ (dB);

Limit line = specific limits (dBuV) + distance extrapolation factor [6 dB].

4.5.5. Test Deviation

There is no deviation with the original standard.

4.5.6. EUT Operation during Test

The EUT was programmed to be in continuously transmitting mode.

4.5.7. Results of Radiated Emissions (9kHz~30MHz)

Temperature	23.5°C	Humidity	52.4%
Test Engineer	Allen Liu	Configurations	Normal Link
Test Date	Apr. 21, 2010		

Freq. (MHz)	Level (dBuV)	Over Limit (dB)	Limit Line (dBuV)	Remark
-	-	-	-	See Note

Note:

The amplitude of spurious emissions which are attenuated by more than 20 dB below the permissible value has no need to be reported.

Distance extrapolation factor = $40 \log(\text{specific distance} / \text{test distance})$ (dB);

Limit line = specific limits (dBuV) + distance extrapolation factor.

4.5.8. Results of Radiated Emissions (30MHz~1GHz)

Temperature	23.5°C	Humidity	52.4%
Test Engineer	Allen Liu	Configurations	Normal Link / Mode 1

Horizontal

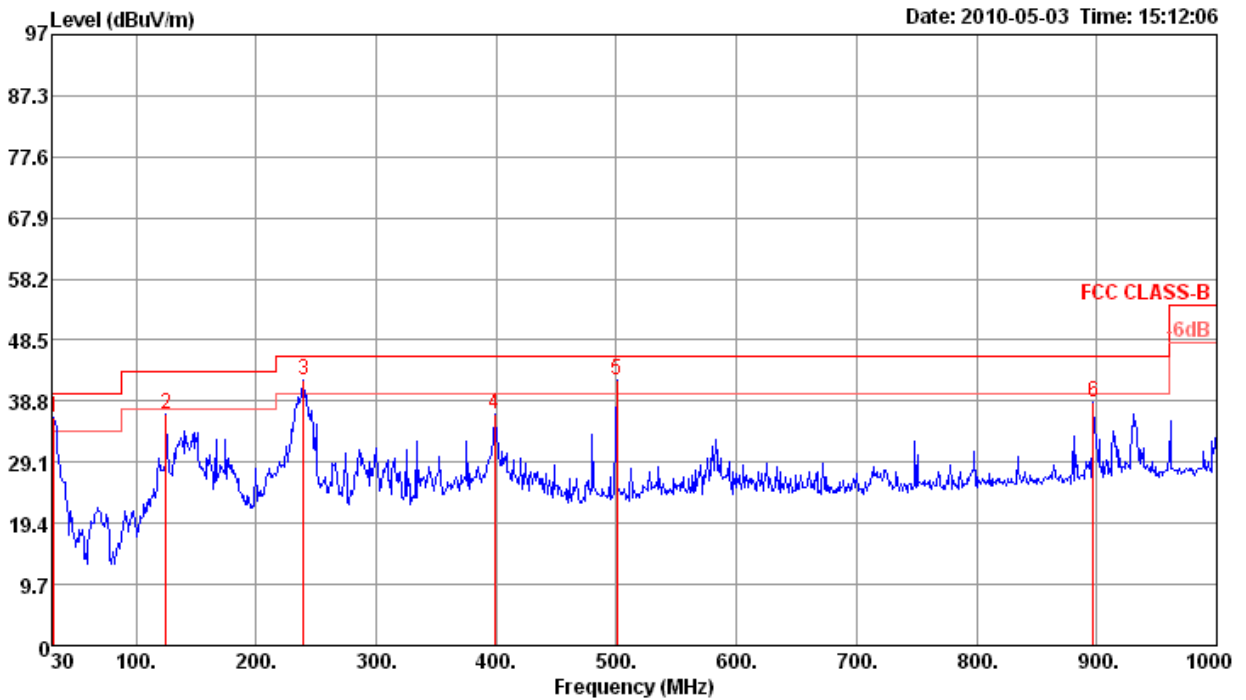

	Freq	Level	Limit	Over	Read	Cable	Preamp	Antenna	T/Pos	A/Pos	Remark	Pol/Phase
	MHz	dBuV/m	dBuV/m	dB	dBuV	dB	dB	dB/m	deg	cm		
1	31.94	36.10	40.00	-3.90	45.71	0.50	27.80	17.69	0	100	Peak	HORIZONTAL
2	125.06	36.69	43.50	-6.81	50.71	1.25	27.48	12.21	0	100	Peak	HORIZONTAL
3	239.52	42.02	46.00	-3.98	55.20	1.86	27.02	11.98	0	100	Peak	HORIZONTAL
4	398.60	36.66	46.00	-9.34	45.92	2.30	27.59	16.03	0	100	Peak	HORIZONTAL
5	500.45	42.19	46.00	-3.81	49.96	2.70	28.10	17.63	0	100	Peak	HORIZONTAL
6	897.18	38.66	46.00	-7.34	41.97	3.59	27.41	20.51	0	100	Peak	HORIZONTAL

Vertical

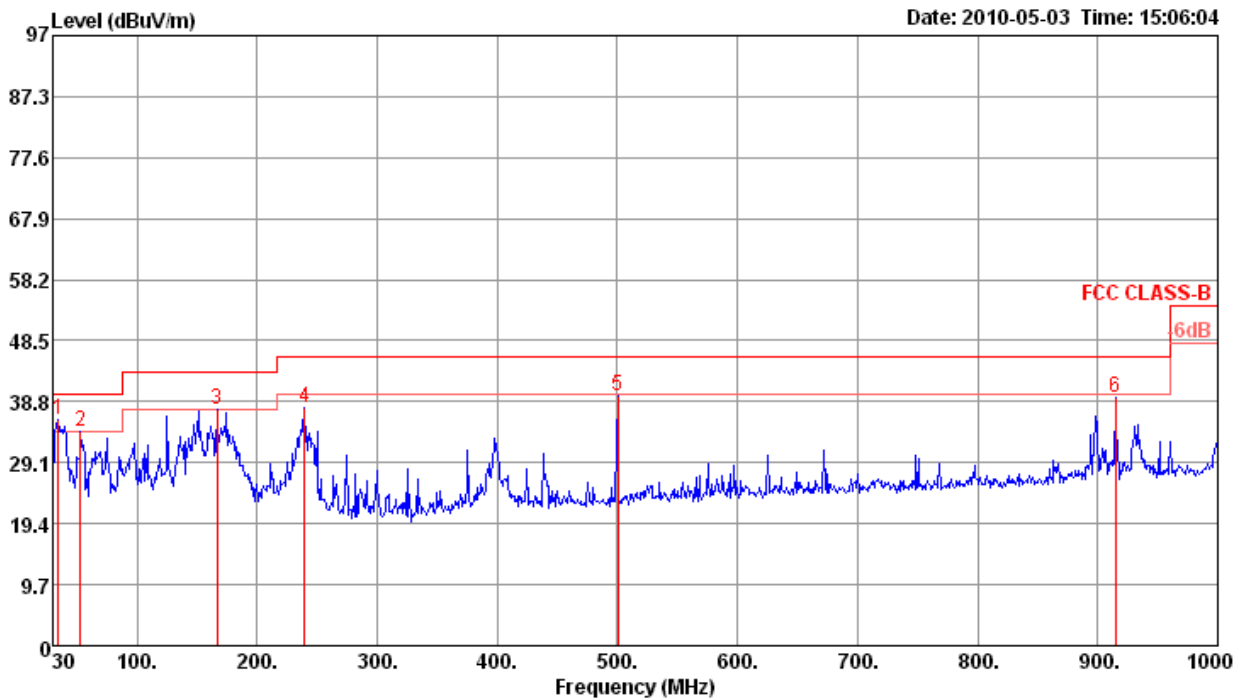

	Freq	Level	Limit Line	Over Limit	Read Level	Cable Loss	Preamp Factor	Antenna Factor	T/Pos	A/Pos	Remark	Pol/Phase
	MHz	dBuV/m	dBuV/m	dB	dBuV	dB	dB	dB/m	deg	cm		
1	34.85	36.06	40.00	-3.94	47.28	0.50	27.80	16.08	0	400	Peak	VERTICAL
2	53.28	33.99	40.00	-6.01	53.02	0.76	27.79	8.00	0	400	Peak	VERTICAL
3	166.77	37.44	43.50	-6.06	50.64	1.53	27.27	12.54	0	400	Peak	VERTICAL
4	239.52	37.85	46.00	-8.15	51.03	1.86	27.02	11.98	0	400	Peak	VERTICAL
5	500.45	39.63	46.00	-6.37	47.40	2.70	28.10	17.63	0	400	Peak	VERTICAL
6	914.64	39.31	46.00	-6.69	42.41	3.60	27.34	20.64	0	400	Peak	VERTICAL

Note:

The amplitude of spurious emissions which are attenuated by more than 20 dB below the permissible value has no need to be reported.

Emission level (dBuV/m) = 20 log Emission level (uV/m).

Corrected Reading: Antenna Factor + Cable Loss + Read Level - Preamp Factor = Level.

Temperature	23.5°C	Humidity	52.4%
Test Engineer	Allen Liu	Configurations	Normal Link / Mode 2

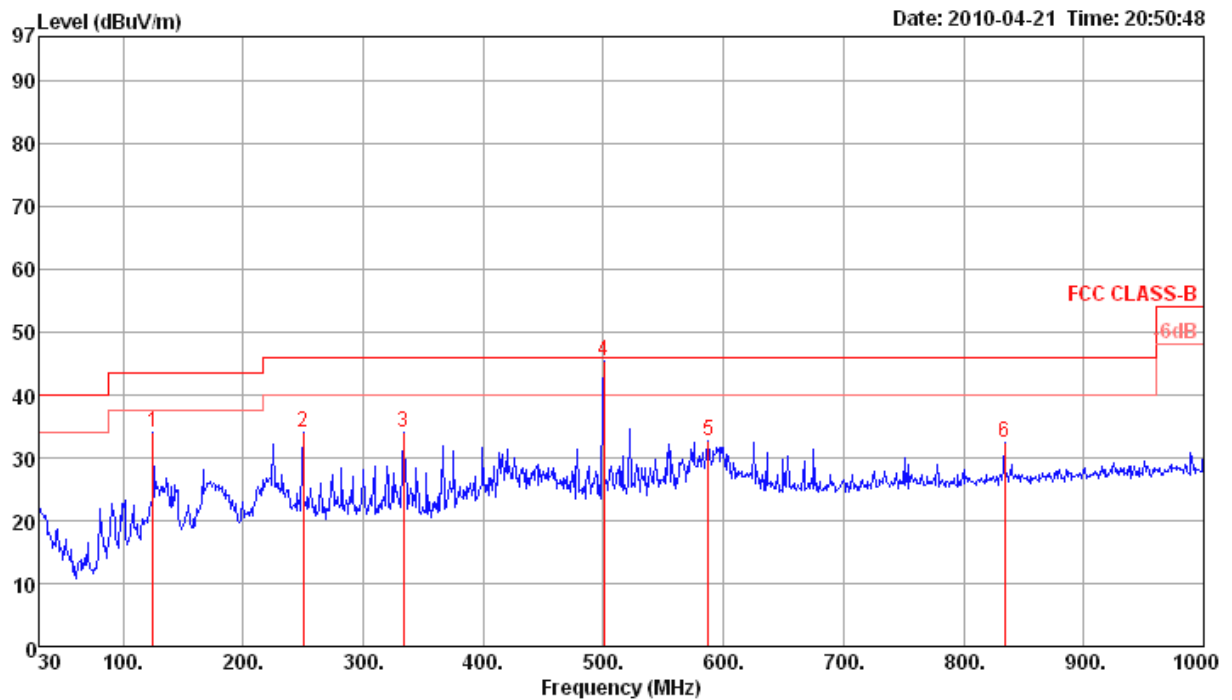
Horizontal

	Freq	Level	Limit	Over	Read	Cable	Preamp	Antenna	T/Pos	A/Pos	Remark	Pol/Phase
	MHz	dBuV/m	dBuV/m	dB	dBuV	dB	dB	dB/m	deg	cm		
1 p	125.06	34.14	43.50	-9.36	48.16	1.25	27.48	12.21	0	100	Peak	HORIZONTAL
2	250.19	34.13	46.00	-11.87	46.46	1.90	27.00	12.77	0	100	Peak	HORIZONTAL
3	333.61	33.99	46.00	-12.01	44.67	2.17	27.13	14.28	0	100	Peak	HORIZONTAL
4 q	500.45	45.33	46.00	-0.67	53.10	2.70	28.10	17.63	226	100	QP	HORIZONTAL
5	587.75	32.82	46.00	-13.18	39.41	2.88	28.10	18.63	0	100	Peak	HORIZONTAL
6	834.13	32.31	46.00	-13.69	36.44	3.37	27.53	20.03	0	100	Peak	HORIZONTAL

Vertical

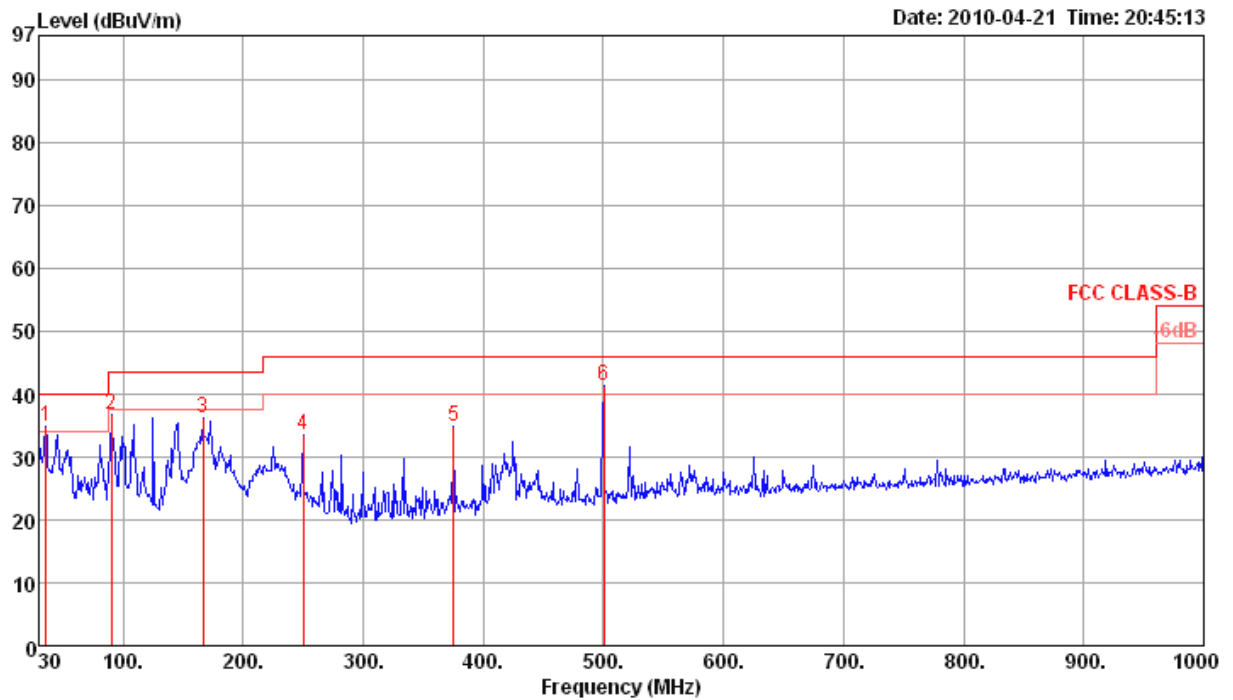

	Freq	Level	Limit	Over	Read	Cable	Preamp	Antenna	T/Pos	A/Pos	Remark	Pol/Phase
	MHz	dBuV/m	dBuV/m	dB	dBuV	dB	dB	dB/m	deg	cm		
1	35.82	34.98	40.00	-5.02	46.75	0.54	27.80	15.49	0	400	Peak	VERTICAL
2	90.14	36.87	43.50	-6.63	54.43	1.10	27.64	8.98	0	400	Peak	VERTICAL
3	166.77	36.18	43.50	-7.32	49.38	1.53	27.27	12.54	0	400	Peak	VERTICAL
4	250.19	33.51	46.00	-12.49	45.84	1.90	27.00	12.77	0	400	Peak	VERTICAL
5	375.32	34.84	46.00	-11.16	44.62	2.25	27.43	15.40	0	400	Peak	VERTICAL
6	500.45	41.46	46.00	-4.54	49.23	2.70	28.10	17.63	265	100	Peak	VERTICAL

Note:

The amplitude of spurious emissions which are attenuated by more than 20 dB below the permissible value has no need to be reported.

Emission level (dBuV/m) = 20 log Emission level (uV/m).

Corrected Reading: Antenna Factor + Cable Loss + Read Level - Preamp Factor = Level.

4.5.9. Results for Radiated Emissions (1GHz~10th Harmonic)

Temperature	23.5°C	Humidity	52.4%
Test Engineer	Allen Liu	Configurations	IEEE 802.11n MCS0 20MHz Ch 1 / Ant. A
Test Date	Apr. 20, 2010		

Horizontal

	Freq	Level	Limit Line	Over Limit	Read Level	Cable Loss	Antenna Factor	Preamp Factor	T/Pos	A/Pos	Remark	Pol/Phase
	MHz	dBuV/m	dBuV/m	dB	dBuV	dB	dB/m	dB	deg	cm		
1	4823.98	35.06	54.00	-18.94	33.07	3.96	33.06	35.03	117	100	Average	HORIZONTAL
2	4824.00	49.84	74.00	-24.16	47.85	3.96	33.06	35.03	117	100	Peak	HORIZONTAL

Vertical

	Freq	Level	Limit Line	Over Limit	Read Level	Cable Loss	Antenna Factor	Preamp Factor	T/Pos	A/Pos	Remark	Pol/Phase
	MHz	dBuV/m	dBuV/m	dB	dBuV	dB	dB/m	dB	deg	cm		
1	4824.01	53.43	74.00	-20.57	51.44	3.96	33.06	35.03	250	100	Peak	VERTICAL
2	4824.03	38.43	54.00	-15.57	36.44	3.96	33.06	35.03	250	100	Average	VERTICAL

Temperature	23.5°C	Humidity	52.4%
Test Engineer	Allen Liu	Configurations	IEEE 802.11n MCS0 20MHz Ch 6 / Ant. A
Test Date	Apr. 20, 2010		

Horizontal

	Freq	Level	Limit Line	Over Limit	Read Level	CableAntenna Loss	Antenna Factor	Preamp Factor	T/Pos	A/Pos	Remark	Pol/Phase
	MHz	dBuV/m	dBuV/m	dB	dBuV	dB	dB/m	dB	deg	cm		
1	4874.01	57.37	74.00	-16.63	55.27	3.97	33.16	35.03	239	100	Peak	HORIZONTAL
2	4874.03	42.86	54.00	-11.14	40.76	3.97	33.16	35.03	239	100	Average	HORIZONTAL

Vertical

	Freq	Level	Limit Line	Over Limit	Read Level	CableAntenna Loss	Antenna Factor	Preamp Factor	T/Pos	A/Pos	Remark	Pol/Phase
	MHz	dBuV/m	dBuV/m	dB	dBuV	dB	dB/m	dB	deg	cm		
1	4874.02	63.88	74.00	-10.12	61.78	3.97	33.16	35.03	126	100	Peak	VERTICAL
2	4874.03	50.42	54.00	-3.58	48.32	3.97	33.16	35.03	126	100	Average	VERTICAL



Temperature	23.5°C	Humidity	52.4%
Test Engineer	Allen Liu	Configurations	IEEE 802.11n MCS0 20MHz Ch11 / Ant. A
Test Date	Apr. 20, 2010		

Horizontal

	Freq	Level	Limit Line	Over Limit	Read Level	Cable Loss	Antenna Factor	Preamp Factor	T/Pos	A/Pos	Remark	Pol/Phase
	MHz	dBuV/m	dBuV/m	dB	dBuV	dB	dB/m	dB	deg	cm		
1	4923.98	37.49	54.00	-16.51	35.27	3.97	33.26	35.01	188	100	Average	HORIZONTAL
2	4924.02	53.25	74.00	-20.75	51.03	3.97	33.26	35.01	188	100	Peak	HORIZONTAL

Vertical

	Freq	Level	Limit Line	Over Limit	Read Level	Cable Loss	Antenna Factor	Preamp Factor	T/Pos	A/Pos	Remark	Pol/Phase
	MHz	dBuV/m	dBuV/m	dB	dBuV	dB	dB/m	dB	deg	cm		
1	4923.98	41.71	54.00	-12.29	39.49	3.97	33.26	35.01	82	100	Average	VERTICAL
2	4924.02	56.03	74.00	-17.97	53.81	3.97	33.26	35.01	82	100	Peak	VERTICAL

Temperature	23.5°C	Humidity	52.4%
Test Engineer	Allen Liu	Configurations	IEEE 802.11n MCS0 40MHz Ch 3 / Ant. A
Test Date	Apr. 20, 2010		

Horizontal

	Freq	Level	Limit Line	Over Limit	Read Level	CableAntenna Loss	Antenna Factor	Preamp Factor	T/Pos	A/Pos	Remark	Pol/Phase
	MHz	dBuV/m	dBuV/m	dB	dBuV	dB	dB/m	dB	deg	cm		
1	4844.00	44.97	74.00	-29.03	42.95	3.96	33.09	35.03	89	100	Peak	HORIZONTAL
2	4844.03	32.99	54.00	-21.01	30.97	3.96	33.09	35.03	89	100	Average	HORIZONTAL

Vertical

	Freq	Level	Limit Line	Over Limit	Read Level	CableAntenna Loss	Antenna Factor	Preamp Factor	T/Pos	A/Pos	Remark	Pol/Phase
	MHz	dBuV/m	dBuV/m	dB	dBuV	dB	dB/m	dB	deg	cm		
1	4843.99	37.59	54.00	-16.41	35.57	3.96	33.09	35.03	239	100	Average	VERTICAL
2	4844.00	50.73	74.00	-23.27	48.71	3.96	33.09	35.03	239	100	Peak	VERTICAL

Temperature	23.5°C	Humidity	52.4%
Test Engineer	Allen Liu	Configurations	IEEE 802.11n MCS0 40MHz Ch 6 / Ant. A
Test Date	Apr. 20, 2010		

Horizontal

	Freq	Level	Limit	Over	Read	CableAntenna	Preamp	T/Pos	A/Pos	Remark	Pol/Phase	
	MHz	dBuV/m	dBuV/m	dB	dBuV	dB	dB/m	dB	deg	cm		
1	4873.98	45.48	74.00	-28.52	43.38	3.97	33.16	35.03	214	100	Peak	HORIZONTAL
2	4873.99	34.10	54.00	-19.90	32.00	3.97	33.16	35.03	214	100	Average	HORIZONTAL

Vertical

	Freq	Level	Limit	Over	Read	CableAntenna	Preamp	T/Pos	A/Pos	Remark	Pol/Phase	
	MHz	dBuV/m	dBuV/m	dB	dBuV	dB	dB/m	dB	deg	cm		
1	4874.02	49.74	74.00	-24.26	47.64	3.97	33.16	35.03	100	100	Peak	VERTICAL
2	4874.03	38.43	54.00	-15.57	36.33	3.97	33.16	35.03	100	100	Average	VERTICAL

Temperature	23.5°C	Humidity	52.4%
Test Engineer	Allen Liu	Configurations	IEEE 802.11n MCS0 40MHz Ch 9 / Ant. A
Test Date	Apr. 20, 2010		

Horizontal

	Freq	Level	Limit Line	Over Limit	Read Level	Cable Loss	Antenna Factor	Preamp Factor	T/Pos	A/Pos	Remark	Pol/Phase
	MHz	dBuV/m	dBuV/m	dB	dBuV	dB	dB/m	dB	deg	cm		
1	4903.98	45.04	74.00	-28.96	42.90	3.97	33.19	35.02	117	100	Peak	HORIZONTAL
2	4903.99	33.73	54.00	-20.27	31.59	3.97	33.19	35.02	117	100	Average	HORIZONTAL

Vertical

	Freq	Level	Limit Line	Over Limit	Read Level	Cable Loss	Antenna Factor	Preamp Factor	T/Pos	A/Pos	Remark	Pol/Phase
	MHz	dBuV/m	dBuV/m	dB	dBuV	dB	dB/m	dB	deg	cm		
1	4903.99	52.07	74.00	-21.93	49.93	3.97	33.19	35.02	248	100	Peak	VERTICAL
2	4904.03	38.24	54.00	-15.76	36.10	3.97	33.19	35.02	248	100	Average	VERTICAL

Note:

The amplitude of spurious emissions which are attenuated by more than 20 dB below the permissible value has no need to be reported.

Emission level (dBuV/m) = 20 log Emission level (uV/m).

Corrected Reading: Antenna Factor + Cable Loss + Read Level - Preamp Factor = Level.

Temperature	23.5°C	Humidity	52.4%
Test Engineer	Allen Liu	Configurations	IEEE 802.11b CH 1 / Ant. A
Test Date	Apr. 19, 2010		

Horizontal

	Freq	Level	Limit	Over	Read	Cable	Preamp	Antenna	T/Pos	A/Pos	Remark	Pol/Phase
	MHz	dBuV/m	dBuV/m	dB	dBuV	dB	dB	dB/m	deg	cm		
1 p	4824.01	53.63	74.00	-20.37	49.05	6.39	35.20	33.39	27	100	Peak	HORIZONTAL
2 a	4824.05	48.51	54.00	-5.49	43.93	6.39	35.20	33.39	27	100	Average	HORIZONTAL

Vertical

	Freq	Level	Limit	Over	Read	Cable	Preamp	Antenna	T/Pos	A/Pos	Remark	Pol/Phase
	MHz	dBuV/m	dBuV/m	dB	dBuV	dB	dB	dB/m	deg	cm		
1 p	4823.93	57.26	74.00	-16.74	52.68	6.39	35.20	33.39	197	101	Peak	VERTICAL
2 a	4823.99	53.73	54.00	-0.27	49.15	6.39	35.20	33.39	197	101	Average	VERTICAL



Temperature	23.5°C	Humidity	52.4%
Test Engineer	Allen Liu	Configurations	IEEE 802.11b CH 6 / Ant. A
Test Date	Apr. 19, 2010		

Horizontal

	Freq	Level	Limit Line	Over Limit	Read Level	Cable Loss	Preamp Factor	Antenna Factor	T/Pos	A/Pos	Remark	Pol/Phase
	MHz	dBuV/m	dBuV/m	dB	dBuV	dB	dB	dB/m	deg	cm		
1 p	4873.97	53.28	74.00	-20.72	48.44	6.56	35.20	33.48	101	117	Peak	HORIZONTAL
2 a	4874.01	47.86	54.00	-6.14	43.02	6.56	35.20	33.48	101	117	Average	HORIZONTAL

Vertical

	Freq	Level	Limit Line	Over Limit	Read Level	Cable Loss	Preamp Factor	Antenna Factor	T/Pos	A/Pos	Remark	Pol/Phase
	MHz	dBuV/m	dBuV/m	dB	dBuV	dB	dB	dB/m	deg	cm		
1 p	4873.95	57.28	74.00	-16.72	52.44	6.56	35.20	33.48	196	100	Peak	VERTICAL
2 a	4873.97	53.51	54.00	-0.49	48.67	6.56	35.20	33.48	196	100	Average	VERTICAL



Temperature	23.5°C	Humidity	52.4%
Test Engineer	Allen Liu	Configurations	IEEE 802.11b CH 11 / Ant. A
Test Date	Apr. 19, 2010		

Horizontal

	Freq	Level	Limit Line	Over Limit	Read Level	Cable Loss	Preamp Factor	Antenna Factor	T/Pos	A/Pos	Remark	Pol/Phase
	MHz	dBuV/m	dBuV/m	dB	dBuV	dB	dB	dB/m	deg	cm		
1 a	4924.05	48.82	54.00	-5.18	43.71	6.73	35.20	33.58	100	120	Average	HORIZONTAL
2 p	4924.12	54.15	74.00	-19.85	49.04	6.73	35.20	33.58	100	120	Peak	HORIZONTAL

Vertical

	Freq	Level	Limit Line	Over Limit	Read Level	Cable Loss	Preamp Factor	Antenna Factor	T/Pos	A/Pos	Remark	Pol/Phase
	MHz	dBuV/m	dBuV/m	dB	dBuV	dB	dB	dB/m	deg	cm		
1 a	4923.97	53.78	54.00	-0.22	48.67	6.73	35.20	33.58	162	100	Average	VERTICAL
2 p	4924.05	57.60	74.00	-16.40	52.49	6.73	35.20	33.58	162	100	Peak	VERTICAL

Temperature	23.5°C	Humidity	52.4%
Test Engineer	Allen Liu	Configurations	IEEE 802.11g CH 1 / Ant. A
Test Date	Apr. 20, 2010		

Horizontal

	Freq	Level	Limit Line	Over Limit	Read Level	Cable Loss	Antenna Factor	Preamp Factor	T/Pos	A/Pos	Remark	Pol/Phase
	MHz	dBuV/m	dBuV/m	dB	dBuV	dB	dB/m	dB	deg	cm		
1	4823.99	52.73	74.00	-21.27	50.74	3.96	33.06	35.03	280	100	Peak	HORIZONTAL
2	4824.01	38.30	54.00	-15.70	36.31	3.96	33.06	35.03	280	100	Average	HORIZONTAL

Vertical

	Freq	Level	Limit Line	Over Limit	Read Level	Cable Loss	Antenna Factor	Preamp Factor	T/Pos	A/Pos	Remark	Pol/Phase
	MHz	dBuV/m	dBuV/m	dB	dBuV	dB	dB/m	dB	deg	cm		
1	4823.98	42.75	54.00	-11.25	40.76	3.96	33.06	35.03	173	100	Average	VERTICAL
2	4823.98	57.15	74.00	-16.85	55.16	3.96	33.06	35.03	173	100	Peak	VERTICAL

Temperature	23.5°C	Humidity	52.4%
Test Engineer	Allen Liu	Configurations	IEEE 802.11g CH 6 / Ant. A
Test Date	Apr. 20, 2010		

Horizontal

	Freq	Level	Limit Line	Over Limit	Read Level	CableAntenna Loss	Antenna Factor	Preamp Factor	T/Pos	A/Pos	Remark	Pol/Phase
	MHz	dBuV/m	dBuV/m	dB	dBuV	dB	dB/m	dB	deg	cm		
1	4874.01	45.60	54.00	-8.40	43.50	3.97	33.16	35.03	182	100	Average	HORIZONTAL
2	4874.02	63.21	74.00	-10.79	61.11	3.97	33.16	35.03	182	100	Peak	HORIZONTAL

Vertical

	Freq	Level	Limit Line	Over Limit	Read Level	CableAntenna Loss	Antenna Factor	Preamp Factor	T/Pos	A/Pos	Remark	Pol/Phase
	MHz	dBuV/m	dBuV/m	dB	dBuV	dB	dB/m	dB	deg	cm		
1	4873.98	65.42	74.00	-8.58	63.32	3.97	33.16	35.03	1	100	Peak	VERTICAL
2	4874.03	48.38	54.00	-5.62	46.28	3.97	33.16	35.03	1	100	Average	VERTICAL

Temperature	23.5°C	Humidity	52.4%
Test Engineer	Allen Liu	Configurations	IEEE 802.11g CH 11 / Ant. A
Test Date	Apr. 20, 2010		

Horizontal

	Freq	Level	Limit Line	Over Limit	Read Level	Cable Loss	Antenna Factor	Preamp Factor	T/Pos	A/Pos	Remark	Pol/Phase
	MHz	dBuV/m	dBuV/m	dB	dBuV	dB	dB/m	dB	deg	cm		
1	4923.98	52.67	74.00	-21.33	50.45	3.97	33.26	35.01	310	100	Peak	HORIZONTAL
2	4924.03	37.54	54.00	-16.46	35.32	3.97	33.26	35.01	310	100	Average	HORIZONTAL

Vertical

	Freq	Level	Limit Line	Over Limit	Read Level	Cable Loss	Antenna Factor	Preamp Factor	T/Pos	A/Pos	Remark	Pol/Phase
	MHz	dBuV/m	dBuV/m	dB	dBuV	dB	dB/m	dB	deg	cm		
1	4923.98	57.20	74.00	-16.80	54.98	3.97	33.26	35.01	184	100	Peak	VERTICAL
2	4924.03	41.84	54.00	-12.16	39.62	3.97	33.26	35.01	184	100	Average	VERTICAL

Note:

The amplitude of spurious emissions that are attenuated by more than 20dB below the permissible value has no need to be reported.

Emission level (dBuV/m) = 20 log Emission level (uV/m).

Corrected Reading: Antenna Factor + Cable Loss + Read Level - Preamp Factor = Level.

4.6. Band Edge Emissions Measurement

4.6.1. Limit

20dBc in any 100 kHz bandwidth outside the operating frequency band. In case the emission fall within the restricted band specified on 15.205(a), then the 15.209(a) limit in the table below has to be followed.

Frequencies (MHz)	Field Strength (micovolts/meter)	Measurement Distance (meters)
0.009~0.490	2400/F(KHz)	300
0.490~1.705	24000/F(KHz)	30
1.705~30.0	30	30
30~88	100	3
88~216	150	3
216~960	200	3
Above 960	500	3

4.6.2. Measuring Instruments and Setting

Please refer to section 5 of equipments list in this report. The following table is the setting of the spectrum analyzer.

Spectrum Parameter	Setting
Attenuation	Auto
Span Frequency	100 MHz
RB / VB (Emission in restricted band)	1 MHz / 1MHz for Peak, 1 MHz / 10Hz for Average
RB / VB (Emission in non-restricted band)	100 KHz /100 KHz for Peak

4.6.3. Test Procedures

1. The test procedure is the same as section 4.5.3, only the frequency range investigated is limited to 100MHz around bandedges.
2. In case the emission is fail due to the used RB/VB is too wide, marker-delta method of FCC Public Notice DA00-705 will be followed.

4.6.4. Test Setup Layout

This test setup layout is the same as that shown in section 4.5.4.

4.6.5. Test Deviation

There is no deviation with the original standard.

4.6.6. EUT Operation during Test

The EUT was programmed to be in continuously transmitting mode.

4.6.7. Test Result of Band Edge and Fundamental Emissions

Temperature	23.5°C	Humidity	52.4%
Test Engineer	Allen Liu	Configurations	IEEE 802.11n MCS0 20MHz Ch 1, 6, 11 / Ant. A
Test Date	Apr. 19, 2010		

Channel 1

	Freq	Level	Limit	Over	Read	Cable	Preamp	Antenna	T/Pos	A/Pos	Remark	Pol/Phase
	MHz	dBuV/m	dBuV/m	dB	dBuV	dB	dB	dB/m	deg	cm		
1 !	2389.20	70.37	74.00	-3.63	39.46	2.86	0.00	28.05	4	100	Peak	VERTICAL
2 !	2389.80	52.68	54.00	-1.32	21.75	2.88	0.00	28.05	4	100	Average	VERTICAL
3 p	2414.60	109.26	74.00			2.88	0.00	28.09	4	100	Peak	VERTICAL
4 a	2415.20	95.31	54.00			2.88	0.00	28.09	4	100	Average	VERTICAL

Item 3, 4 are the fundamental frequency at 2412 MHz

Channel 6

	Freq	Level	Limit	Over	Read	Cable	Preamp	Antenna	T/Pos	A/Pos	Remark	Pol/Phase
	MHz	dBuV/m	dBuV/m	dB	dBuV	dB	dB	dB/m	deg	cm		
1	2389.80	61.11	74.00	-12.89	30.18	2.88	0.00	28.05	215	100	Peak	VERTICAL
2	2390.00	45.89	54.00	-8.11	14.96	2.88	0.00	28.05	215	100	Average	VERTICAL
3 a	2435.00	101.09	54.00			2.89	0.00	28.18	215	100	Average	VERTICAL
4 p	2435.80	115.83	74.00			2.89	0.00	28.18	215	100	Peak	VERTICAL
5 !	2484.30	51.82	54.00	-2.18	20.63	2.93	0.00	28.26	215	100	Average	VERTICAL
6 !	2484.70	73.11	74.00	-0.89	41.92	2.93	0.00	28.26	215	100	Peak	VERTICAL

Item 3, 4 are the fundamental frequency at 2437MHz.

Channel 11

	Freq	Level	Limit	Over	Read	Cable	Preamp	Antenna	T/Pos	A/Pos	Remark	Pol/Phase
	MHz	dBuV/m	dBuV/m	dB	dBuV	dB	dB	dB/m	deg	cm		
1 a	2464.80	97.20	54.00			2.91	0.00	28.22	144	100	Average	VERTICAL
2 p	2467.20	111.81	74.00			2.93	0.00	28.22	144	100	Peak	VERTICAL
3 !	2485.90	72.70	74.00	-1.30	41.47	2.93	0.00	28.30	144	100	Peak	VERTICAL
4 !	2486.10	50.29	54.00	-3.71	19.06	2.93	0.00	28.30	144	100	Average	VERTICAL

Item 1, 2 are the fundamental frequency at 2462 MHz.

Temperature	23.5°C	Humidity	52.4%
Test Engineer	Allen Liu	Configurations	IEEE 802.11n MCS0 40MHz Ch 3, 6, 9 / Ant. A
Test Date	Apr. 19, 2010		

Channel 3

	Freq	Level	Limit Line	Over Limit	Read Level	Cable Loss	Preamp Factor	Antenna Factor	T/Pos	A/Pos	Remark	Pol/Phase
	MHz	dBuV/m	dBuV/m	dB	dBuV	dB	dB	dB/m	deg	cm		
1	2390.00	69.22	74.00	-4.78	38.29	2.88	0.00	28.05	349	100	Peak	VERTICAL
2	2390.00	53.63	54.00	-0.37	22.70	2.88	0.00	28.05	349	349	Average	VERTICAL
3	2416.40	103.78	74.00			2.89	0.00	28.09	349	100	Peak	VERTICAL
4	2416.80	93.75	54.00			2.89	0.00	28.09	349	100	Average	VERTICAL

Item 3, 4 are the fundamental frequency at 2422 MHz.

Channel 6

	Freq	Level	Limit Line	Over Limit	Read Level	Cable Loss	Preamp Factor	Antenna Factor	T/Pos	A/Pos	Remark	Pol/Phase
	MHz	dBuV/m	dBuV/m	dB	dBuV	dB	dB	dB/m	deg	cm		
1	2390.00	60.15	74.00	-13.85	29.22	2.88	0.00	28.05	213	100	Peak	VERTICAL
2	2390.00	47.46	54.00	-6.54	16.53	2.88	0.00	28.05	213	100	Average	VERTICAL
3	2452.60	107.14	74.00			2.91	0.00	28.22	213	100	Peak	VERTICAL
4	2452.60	93.73	54.00			2.91	0.00	28.22	213	100	Average	VERTICAL
5	2483.50	65.94	74.00	-8.06	34.75	2.93	0.00	28.26	213	100	Peak	VERTICAL
6	2483.50	51.36	54.00	-2.64	20.17	2.93	0.00	28.26	213	100	Average	VERTICAL

Item 3, 4 are the fundamental frequency at 2437MHz.

Channel 9

	Freq	Level	Limit Line	Over Limit	Read Level	Cable Loss	Preamp Factor	Antenna Factor	T/Pos	A/Pos	Remark	Pol/Phase
	MHz	dBuV/m	dBuV/m	dB	dBuV	dB	dB	dB/m	deg	cm		
1	2456.00	94.63	54.00			2.91	0.00	28.22	322	100	Average	VERTICAL
2	2466.80	104.47	74.00			2.93	0.00	28.22	322	100	Peak	VERTICAL
3	2484.30	53.22	54.00	-0.78	22.03	2.93	0.00	28.26	322	100	Average	VERTICAL
4	2485.10	70.59	74.00	-3.41	39.36	2.93	0.00	28.30	322	100	Peak	VERTICAL

Item 1, 2 are the fundamental frequency at 2452 MHz.

Note:

Emission level (dBuV/m) = 20 log Emission level (uV/m).

Corrected Reading: Antenna Factor + Cable Loss + Read Level - Preamp Factor = Level.

Temperature	23.5°C	Humidity	52.4%
Test Engineer	Allen Liu	Configurations	IEEE 802.11b CH 1, 6, 11 / Ant. A
Test Date	Apr. 19, 2010		

Channel 1

	Freq	Level	Limit	Over	Read	Cable	Preamp	Antenna	T/Pos	A/Pos	Remark	Pol/Phase
	MHz	dBuV/m	dBuV/m	dB	dBuV	dB	dB	dB/m	deg	cm		
1	2390.00	59.14	74.00	-14.86	28.21	2.88	0.00	28.05	2	100	Peak	VERTICAL
2	2390.00	49.78	54.00	-4.22	18.85	2.88	0.00	28.05	2	100	Average	VERTICAL
3	2413.60	106.08	74.00			2.88	0.00	28.09	2	100	Peak	VERTICAL
4	2414.80	102.68	54.00			2.88	0.00	28.09	2	100	Average	VERTICAL

Item 3, 4 are the fundamental frequency at 2412 MHz.

Channel 6

	Freq	Level	Limit	Over	Read	Cable	Preamp	Antenna	T/Pos	A/Pos	Remark	Pol/Phase
	MHz	dBuV/m	dBuV/m	dB	dBuV	dB	dB	dB/m	deg	cm		
1	2390.00	54.15	74.00	-19.85	23.22	2.88	0.00	28.05	214	100	Peak	VERTICAL
2	2390.00	44.30	54.00	-9.70	13.37	2.88	0.00	28.05	214	100	Average	VERTICAL
3	2434.40	103.43	54.00			2.89	0.00	28.18	214	100	Average	VERTICAL
4	2436.20	107.71	74.00			2.89	0.00	28.18	214	100	Peak	VERTICAL
5	2483.50	58.87	74.00	-15.13	27.68	2.93	0.00	28.26	214	100	Peak	VERTICAL
6	2483.50	47.99	54.00	-6.01	16.80	2.93	0.00	28.26	214	100	Average	VERTICAL

Item 3, 4 are the fundamental frequency at 2437MHz.

Channel 11

	Freq	Level	Limit	Over	Read	Cable	Preamp	Antenna	T/Pos	A/Pos	Remark	Pol/Phase
	MHz	dBuV/m	dBuV/m	dB	dBuV	dB	dB	dB/m	deg	cm		
1	2461.00	109.14	74.00			2.91	0.00	28.22	213	100	Peak	VERTICAL
2	2464.60	104.68	54.00			2.91	0.00	28.22	213	100	Average	VERTICAL
3	2483.70	61.82	74.00	-12.18	30.63	2.93	0.00	28.26	213	100	Peak	VERTICAL
4	2483.90	52.55	54.00	-1.45	21.36	2.93	0.00	28.26	213	100	Average	VERTICAL

Item 1, 2 are the fundamental frequency at 2462 MHz.

Temperature	23.5°C	Humidity	52.4%
Test Engineer	Allen Liu	Configurations	IEEE 802.11g CH 1, 6, 11 / Ant. A
Test Date	Apr. 19, 2010		

Channel 1

	Freq	Level	Limit Line	Over Limit	Read Level	Cable Loss	Preamp Factor	Antenna Factor	T/Pos	A/Pos	Remark	Pol/Phase
	MHz	dBuV/m	dBuV/m	dB	dBuV	dB	dB	dB/m	deg	cm		
1 !	2389.20	53.17	54.00	-0.83	22.26	2.86	0.00	28.05	163	100	Average	VERTICAL
2 !	2389.60	71.32	74.00	-2.68	40.41	2.86	0.00	28.05	163	100	Peak	VERTICAL
3 a	2413.40	99.67	54.00			2.88	0.00	28.09	163	100	Average	VERTICAL
4 p	2416.60	113.36	74.00			2.89	0.00	28.09	163	100	Peak	VERTICAL

Item 3, 4 are the fundamental frequency at 2412 MHz.

Channel 6

	Freq	Level	Limit Line	Over Limit	Read Level	Cable Loss	Preamp Factor	Antenna Factor	T/Pos	A/Pos	Remark	Pol/Phase
	MHz	dBuV/m	dBuV/m	dB	dBuV	dB	dB	dB/m	deg	cm		
1	2390.00	58.36	74.00	-15.64	27.43	2.88	0.00	28.05	213	100	Peak	VERTICAL
2	2390.00	46.45	54.00	-7.55	15.52	2.88	0.00	28.05	213	100	Average	VERTICAL
3 p	2432.20	117.78	74.00			2.89	0.00	28.13	213	100	Peak	VERTICAL
4 a	2435.20	103.08	54.00			2.89	0.00	28.18	213	100	Average	VERTICAL
5 !	2483.50	53.07	54.00	-0.93	21.88	2.93	0.00	28.26	213	100	Average	VERTICAL
6 !	2484.70	70.45	74.00	-3.55	39.26	2.93	0.00	28.26	213	100	Peak	VERTICAL

Item 3, 4 are the fundamental frequency at 2437 MHz.

Channel 11

	Freq	Level	Limit Line	Over Limit	Read Level	Cable Loss	Preamp Factor	Antenna Factor	T/Pos	A/Pos	Remark	Pol/Phase
	MHz	dBuV/m	dBuV/m	dB	dBuV	dB	dB	dB/m	deg	cm		
1 p	2457.40	114.07	74.00			2.91	0.00	28.22	214	100	Peak	VERTICAL
2 a	2467.00	99.42	54.00			2.93	0.00	28.22	214	100	Average	VERTICAL
3 !	2483.50	51.96	54.00	-2.04	20.77	2.93	0.00	28.26	214	100	Average	VERTICAL
4 !	2483.70	72.29	74.00	-1.71	41.10	2.93	0.00	28.26	214	100	Peak	VERTICAL

Item 1, 2 are the fundamental frequency at 2462 MHz.

Note:

Emission level (dBuV/m) = 20 log Emission level (uV/m).

Corrected Reading: Antenna Factor + Cable Loss + Read Level - Preamp Factor = Level.

For Emission not in Restricted Band

Low Band Edge Plot on Configuration IEEE 802.11n MCS0 20MHz Ant. A / 2412 MHz

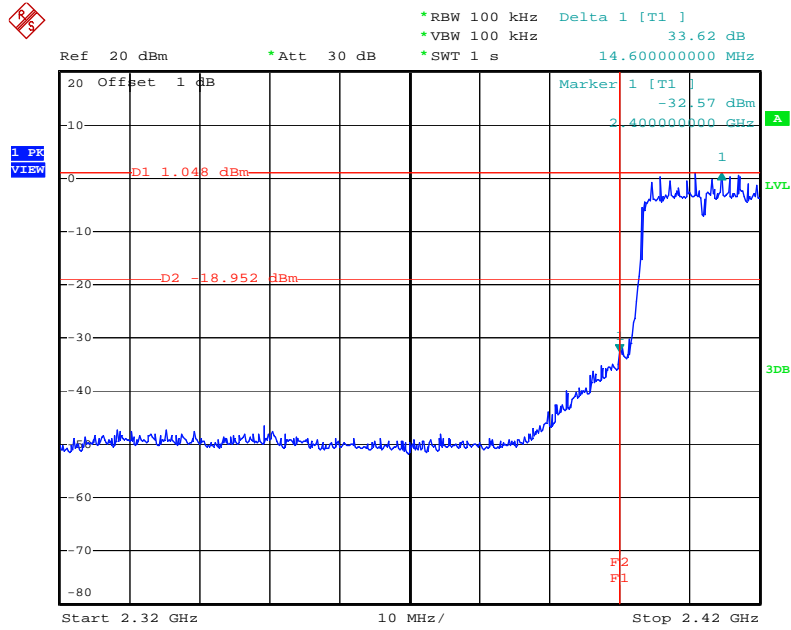

Date: 20.APR.2010 11:09:21

High Band Edge Plot on Configuration IEEE 802.11n MCS0 20MHz Ant. A / 2462 MHz

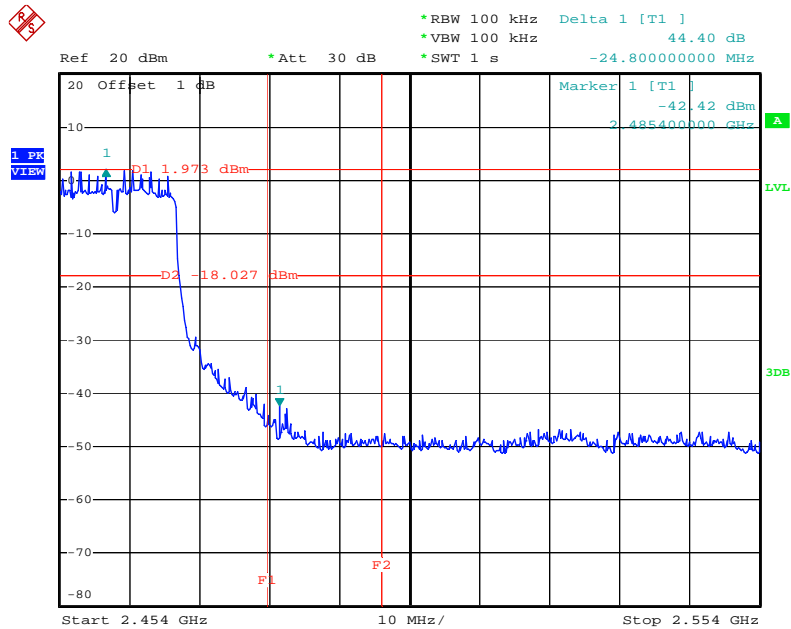

Date: 20.APR.2010 11:07:09

For Emission not in Restricted Band

Low Band Edge Plot on Configuration IEEE 802.11n MCS0 40MHz Ant. A / 2422 MHz

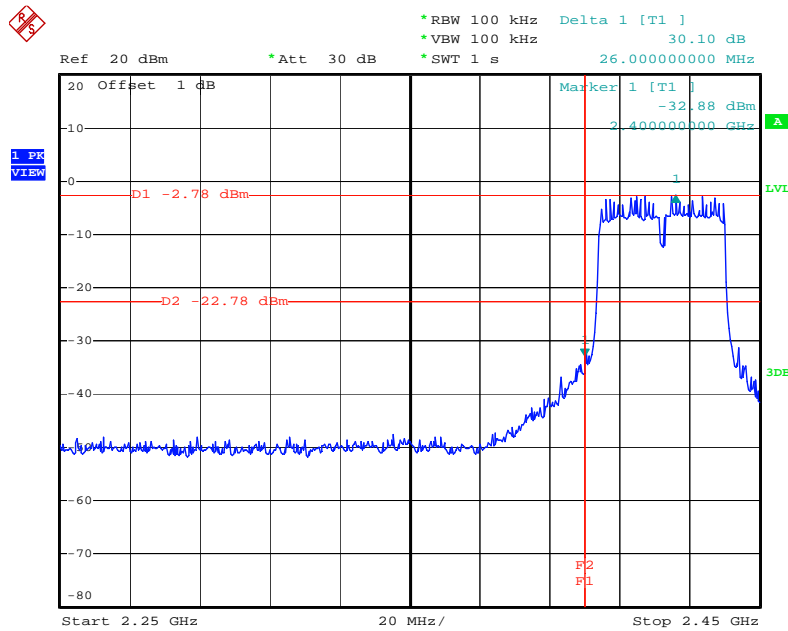

Date: 20.APR.2010 10:49:20

High Band Edge Plot on Configuration IEEE 802.11n MCS0 40MHz Ant. A / 2452 MHz

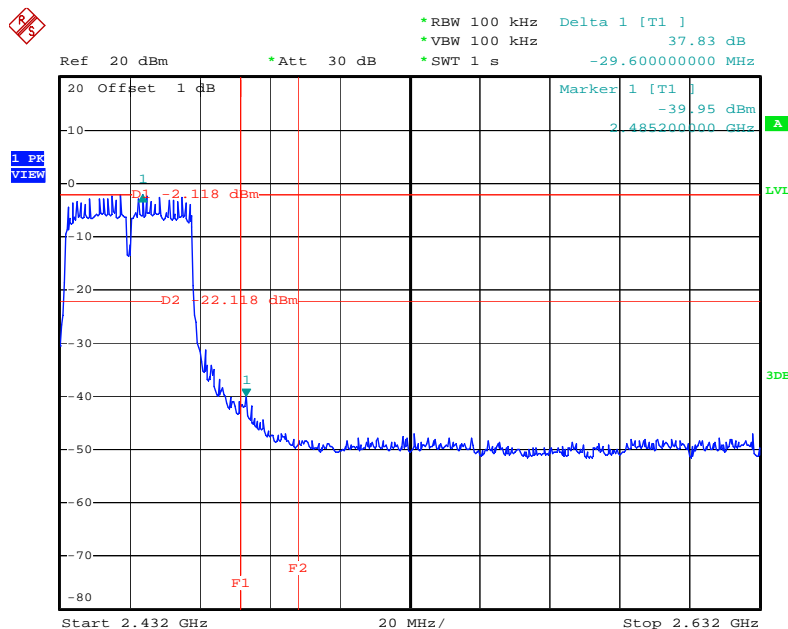

Date: 20.APR.2010 10:54:06

Low Band Edge Plot on Configuration IEEE 802.11b Ant. A / 2412 MHz

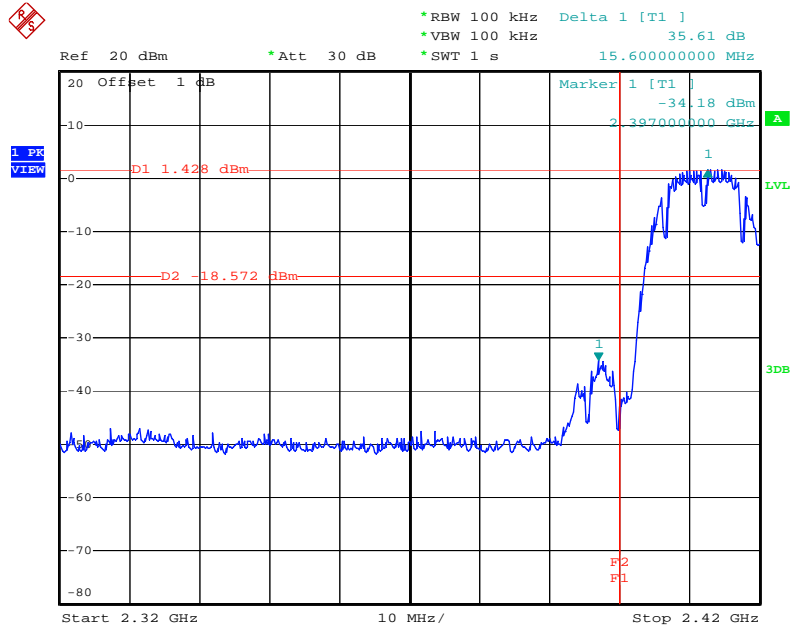

Date: 20.APR.2010 11:23:35

High Band Edge Plot on Configuration IEEE 802.11b Ant. A / 2462 MHz

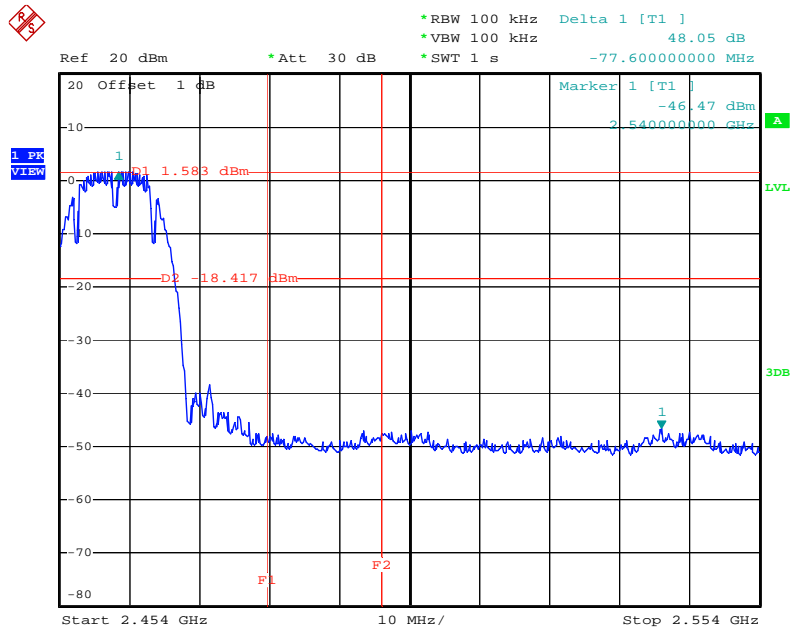

Date: 20.APR.2010 11:19:26

Low Band Edge Plot on Configuration IEEE 802.11g Ant. A / 2412 MHz

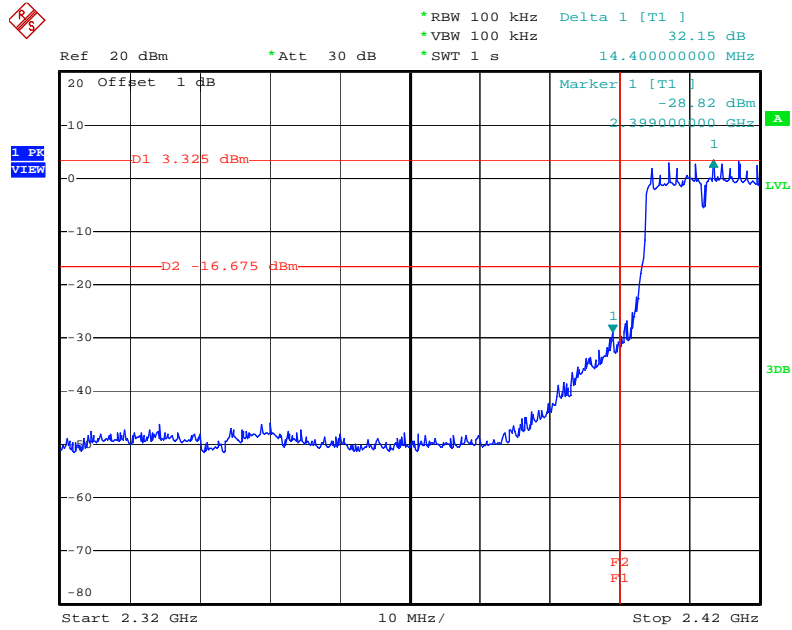

Date: 20.APR.2010 11:11:54

High Band Edge Plot on Configuration IEEE 802.11g Ant. A / 2462 MHz

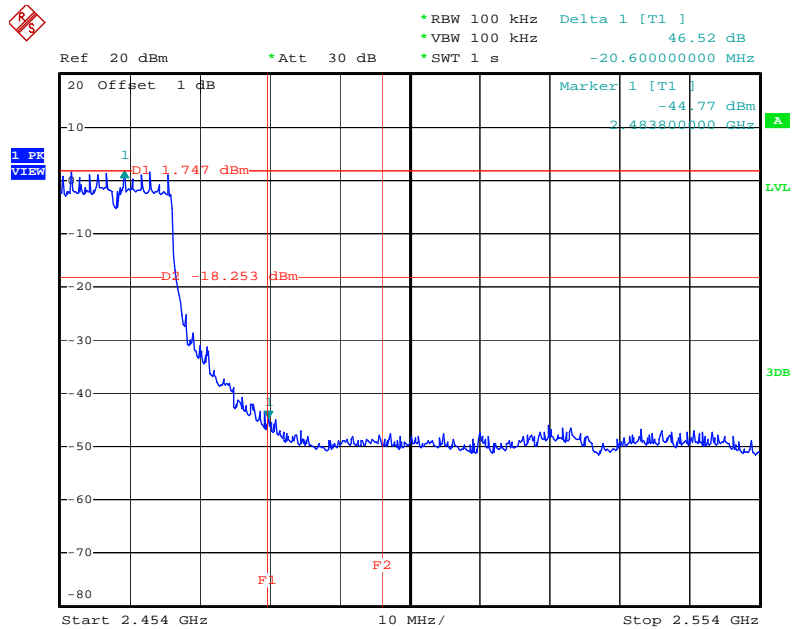

Date: 20.APR.2010 11:16:32

4.7. Antenna Requirements

4.7.1. Limit

Except for special regulations, the Low-power Radio-frequency Devices must not be equipped with any jacket for installing an antenna with extension cable. An intentional radiator shall be designed to ensure that no antenna other than that furnished by the responsible party shall be used with the device. The use of a permanently attached antenna or of an antenna that uses a unique coupling to the intentional radiator shall be considered sufficient to comply with the provisions of this Section. The manufacturer may design the unit so that the user can replace a broken antenna, but the use of a standard antenna jack or electrical connector is prohibited. Further, this requirement does not apply to intentional radiators that must be professionally installed.

4.7.2. Antenna Connector Construction

Please refer to section 3.3 in this test report; antenna connector complied with the requirements.

5. LIST OF MEASURING EQUIPMENTS

Instrument	Manufacturer	Model No.	Serial No.	Characteristics	Calibration Date	Remark
EMC Receiver	R&S	ESCS 30	100174	9kHz – 2.75GHz	Apr. 06, 2010	Conduction (CO04-HY)
LISN	MessTec	NNB-2/16Z	99079	9kHz – 30MHz	Mar. 23, 2010	Conduction (CO04-HY)
LISN (Support Unit)	EMCO	3810/2NM	9703-1839	9kHz – 30MHz	Apr. 29, 2009	Conduction (CO04-HY)
RF Cable-CON	UTIFLEX	3102-26886-4	CB049	9kHz – 30MHz	Apr. 20, 2010	Conduction (CO04-HY)
ISN	SCHAFFNER	ISN T400	21653	9kHz – 30MHz	Jun. 10, 2010	Conduction (CO04-HY)
EMI Filter	LINDGREN	LRE-2030	2651	< 450 Hz	N/A	Conduction (CO04-HY)
3m Semi Anechoic Chamber	SIDT FRANKONIA	SAC-3M	03CH03-HY	30 MHz - 1 GHz 3m	Jun. 07, 2009	Radiation (03CH03-HY)
Amplifier	SCHAFFNER	COA9231A	18667	9 kHz - 2 GHz	Jan. 24, 2010	Radiation (03CH03-HY)
Amplifier	Agilent	8449B	3008A02120	1 GHz - 26.5 GHz	Jul. 21, 2009	Radiation (03CH03-HY)
Amplifier	MITEQ	AMF-6F-260400	9121372	26.5 GHz - 40 GHz	Apr. 06, 2009*	Radiation (03CH03-HY)
Spectrum Analyzer	R&S	FSP40	100004	9 kHz - 40 GHz	Oct. 03, 2009	Radiation (03CH03-HY)
Loop Antenna	R&S	HFH2-Z2	860004/001	9 kHz - 30 MHz	Jul. 28, 2008*	Radiation (03CH03-HY)
Bilog Antenna	SCHAFFNER	CBL 6112D	22237	30 MHz – 1 GHz	Sep. 26, 2009	Radiation (03CH03-HY)
Horn Antenna	EMCO	3115	6741	1GHz ~ 18GHz	Apr. 28, 2010	Radiation (03CH03-HY)
Horn Antenna	SCHWARZBECK	BBHA9170	BBHA9170154	15 GHz - 40 GHz	Jan. 11, 2010	Radiation (03CH03-HY)
RF Cable-R03m	Jye Bao	RG142	CB021	30 MHz - 1 GHz	Jan. 05, 2010	Radiation (03CH03-HY)
RF Cable-HIGH	SUHNER	SUCOFLEX 106	03CH03-HY	1 GHz - 40 GHz	Jan. 05, 2010	Radiation (03CH03-HY)
Turn Table	HD	DS 420	420/650/00	0 – 360 degree	N/A	Radiation (03CH03-HY)
Antenna Mast	HD	MA 240	240/560/00	1 m - 4 m	N/A	Radiation (03CH03-HY)
Spectrum Analyzer	R&S	FSU26.5	100015	20Hz ~ 26.5GHz	Oct. 29, 2009	Conducted (TH01-HY)
Power Meter	R&S	NRVS	100444	DC ~ 40GHz	Jul. 31, 2009	Conducted (TH01-HY)
Power Sensor	R&S	NRV-Z51	100666	DC ~ 30GHz	Aug. 05, 2009	Conducted (TH01-HY)
Power Sensor	R&S	NRV-Z32	100057	30MHz ~ 6GHz	Jul. 31, 2009	Conducted (TH01-HY)
AC Power Source	HPC	HPA-500W	HPA-9100024	AC 0 ~ 300V	Jul. 12, 2009*	Conducted (TH01-HY)
DC Power Source	G.W.	GPC-6030D	C671845	DC 1V ~ 60V	Mar. 13, 2010	Conducted (TH01-HY)
Temp. and Humidity Chamber	Giant Force	GTH-225-20-S	MAB0103-001	N/A	Aug. 06, 2009	Conducted (TH01-HY)
RF CABLE-1m	Jye Bao	RG142	CB034-1m	20MHz ~ 7GHz	Dec. 02, 2009	Conducted (TH01-HY)
RF CABLE-2m	Jye Bao	RG142	CB035-2m	20MHz ~ 1GHz	Dec. 02, 2009	Conducted (TH01-HY)
Vector Signal Generator	R&S	SMU200A	102098	100kHz ~ 6GHz	Feb. 13, 2010	Conducted (TH01-HY)
Signal Generator	R&S	SMR40	100116	10MHz ~ 40GHz	Mar. 25, 2010	Conducted (TH01-HY)
Power Sensor	Anritsu	MA2411B	0917017	300MHz~40GHz	Dec. 03, 2009	Conducted (TH01-HY)
Power Meter	Anritsu	ML2495A	0949003	300MHz~40GHz	Dec. 03, 2009	Conducted (TH01-HY)

Note: Calibration Interval of instruments listed above is one year.

Note: *Calibration Interval of instruments listed above is two year.

6. TEST LOCATION

SHIJR	ADD : 6Fl., No. 106, Sec. 1, Shintai 5th Rd., Shijr City, Taipei, Taiwan 221, R.O.C. TEL : 886-2-2696-2468 FAX : 886-2-2696-2255
HWA YA	ADD : No. 52, Hwa Ya 1st Rd., Kwei-Shan Hsiang, Tao Yuan Hsien, Taiwan, R.O.C. TEL : 886-3-327-3456 FAX : 886-3-318-0055
LINKOU	ADD : No. 30-2, Dingfu Tsuen, Linkou Shiang, Taipei, Taiwan 244, R.O.C TEL : 886-2-2601-1640 FAX : 886-2-2601-1695
DUNGHU	ADD : No. 3, Lane 238, Kangle St., Neihu Chiu, Taipei, Taiwan 114, R.O.C. TEL : 886-2-2631-4739 FAX : 886-2-2631-9740
JUNGHE	ADD : 7Fl., No. 758, Jungjeng Rd., Junghe City, Taipei, Taiwan 235, R.O.C. TEL : 886-2-8227-2020 FAX : 886-2-8227-2626
NEIHU	ADD : 4Fl., No. 339, Hsin Hu 2 nd Rd., Taipei 114, Taiwan, R.O.C. TEL : 886-2-2794-8886 FAX : 886-2-2794-9777
JHUBEI	ADD : No.8, Lane 724, Bo-ai St., Jhubei City, HsinChu County 302, Taiwan, R.O.C. TEL : 886-3-656-9065 FAX : 886-3-656-9085

7. TAF CERTIFICATE OF ACCREDITATION



Certificate No. : L1190-091230

財團法人全國認證基金會
Taiwan Accreditation Foundation

Certificate of Accreditation

This is to certify that

Sporton International Inc.
EMC & Wireless Communications Laboratory
No.52, Hwa Ya 1st Rd., Hwa Ya Technology Park, Kwei-Shan Hsiang, Tao Yuan Hsien,
Taiwan, R.O.C.

is accredited in respect of laboratory

Accreditation Criteria	: ISO/IEC 17025:2005
Accreditation Number	: 1190
Originally Accredited	: December 15, 2003
Effective Period	: January 10, 2010 to January 09, 2013
Accredited Scope	: Testing Field, see described in the Appendix
Specific Accreditation Program	: Accreditation Program for Designated Testing Laboratory for Commodities Inspection Accreditation Program for Telecommunication Equipment Testing Laboratory Accreditation Program for BSMI Mutual Recognition Arrangement with Foreign Authorities

Jay-san Chen

Jay-San Chen
President, Taiwan Accreditation Foundation
Date : December 30, 2009

Pl, total 22 pages

The Appendix forms an integral part of this Certificate, which shall be invalid when use without the Appendix