

## Part III: Appendices

**Appendix A Safety**

**Appendix B Installation troubleshooting**

**Appendix C Specifications**

**Appendix D Field Replaceable Units**

**Appendix E Cable installation and power separation guidelines**



## Safety

This appendix contains specifications for CommScope OneCell, including FCC information and technical data.

<a href="#">Radiation Exposure Statement</a>	<a href="#">A-2</a>
<a href="#">Human exposure limits for OneCell deployments</a>	<a href="#">A-2</a>

## Radiation Exposure Statement

Important: Changes or modifications not expressly approved by CommScope LLC could void your authority to operate the equipment.

### FCC Part 15

The Baseband Controller and RP5100 have been tested and found to comply with the limits for Class A equipment, pursuant to Part 15 of the FCC Rules.



**NOTE**

This equipment has been tested and found to comply with the limits for a Class A digital device, pursuant to part 15 of the FCC Rules. These limits are designed to provide reasonable protection against harmful interference when the equipment is operated in a commercial environment. This equipment generates, uses, and can radiate radio frequency energy and, if not installed and used in accordance with the instruction manual, may cause harmful interference to radio communications. Operation of this equipment in a residential area is likely to cause harmful interference in which case the user will be required to correct the interference at his own expense.

For more information, see the publication femtocells and Health at [http:// www.femtoforum.org](http://www.femtoforum.org) or visit the FCC website at [www.fcc.gov](http://www.fcc.gov).

### EN55032



**WARNING**

This equipment is compliant with Class A of EN55032. In a residential environment, this equipment may cause radio interference.

## Human exposure limits for OneCell deployments

The human exposure limits for the OneCell product is calculated by using the Maximum Permissible Exposure (MPE) method associated with fixed-type transmitter devices at a minimum exposure distance of 20 cm.

[Table A-1](#) includes values for one Radio Point (RP) and four Radio Points per chassis.

**Table A-1. RF exposure for OneCell at maximum power internal antennas**

Parameter	RPM-A5A11-B66	RPM-A5A11-B02	RPM-I5A11-B01	RPM-I5A11-B03	RPM-I5A11-B07	RPM-A5A11-B12	RPM-A5A11-B14	RPM-A5A11-B17
Tx Power (dBm) per antenna	24.13	24.23	24.25	24.00	24.70	21.88	21.45	21.70
Tx Loss (dB)	0	0	0	0	0	0	0	0
Tx Antenna Gain (dBi)	4	4	4	4	4	4	4	4
Transmitter Duty Cycle %	100	100	100	100	100	100	100	100
Number of Antennas (MIMO)	2	2	2	2	2	2	2	2
Contribution due to multiple antennas (dB)	3.0103	3.0103	3.0103	3.0103	3.0103	3.0103	3.0103	3.0103
Derived Total EIRP (dBW)	1.140	1.240	1.260	1.010	1.710	-1.110	-1.540	-1.290
Bands	66	2	1	3	7	12	14	17
Frequency Range (MHz)	2110-2200	1930-1990	2110-2170	1805-1880	2620-2690	729 - 746	758 - 768	734 - 746
Point Source Total EIRP (watts)	1.300	1.331	1.337	1.262	1.483	0.775	0.702	0.743
Power Density (W/m <sup>2</sup> ) @ 20 cm	2.587	2.647	2.569	2.510	2.950	1.541	1.396	1.478
<ol style="list-style-type: none"> <li>1. For persons with implants, the maximum calculated distance of 30cm. This applies to any combination of up to four radio modules in Bands 1,3 and 7.</li> <li>2. For general public and workers, a measured distance of 5mm was determined. This applies to any combination of up to four radio modules in Bands 1,3 and 7.</li> <li>3. For general public and workers, a calculated distance of 20cm was determined. This applies to any combination of up to four radio modules in Bands 2 and 66.</li> </ol>								

**Reference documents**

[1] Federal Communications Commission Document OET Bulletin 65, Supplement C, 2001, Evaluating Compliance with FCC guidelines for Human Exposure to radio

frequency Electromagnetic Fields, US Federal Communications Commission, Office of Engineering and Technology June 2001.

[2] Federal Communications Commission Document OET Bulletin 56, “Questions and answers about biological effects and potential hazards of radio frequency electromagnetic fields”, Federal Communications Commission Office of Engineering and Technology, August 1999.

[3] ICNIRP Guidelines for limiting exposure to time varying electric, magnetic and electromagnetic fields up to 300 GHz. International Commission on Non Ionizing Radiation, published in Health Physics 74 (4): 494-522; 1998

[4] ICNIRP Statement on EMF-Emitting New Technologies, International Commission on Non-Ionizing Radiation, published in Health Physics 94 (4):376-392, 2008

[5] 3GPP Document 3GPP TS 36.104 version 10.11.0 Release 10,” LTE Evolved Universal Terrestrial Radio Access (E-UTRA); Base Station (BS) radio transmission and reception”

## Installation troubleshooting

This section contains information on troubleshooting the OneCell installation. It includes the LED patterns for the Baseband Controller and Radio points.

<a href="#">Baseband Controller LED patterns</a>	<a href="#">B-2</a>
<a href="#">Radio Point LED patterns</a>	<a href="#">B-4</a>

## Baseband Controller LED patterns

The Baseband Controller has four LEDs on the front panel. The following table shows

- Display pattern for each LED
- What the pattern indicates
- Action to take, if any, to resolve the issue

LED	Display Pattern	Indicates	Action to Take
STATUS	Green, solid	Power On Sectors up	None
	Amber, solid	Self-test failure	Replace Baseband Controller
	Green, blinking	Firmware upgrade from DMS Sectors not up	None
	Amber, blinking	No configuration from DMS	<ul style="list-style-type: none"> <li>• Check DMS availability</li> <li>• Check if the provisioning is correct</li> <li>• Escalate to operator</li> </ul>
	OFF	BC rebooting after upgrade	None
	Red, solid*	Error in system - software or hardware issues detected	Replace Baseband Controller Module
RP ERROR	Green, solid	Power On	None
	Amber, solid	Self-test failure	Replace Baseband Controller
	Amber, blinking	No Radio Points connected	Check RP cable
	Off	Radio Points connected, firmware upgrade from DMS	None
	Red, blinking	Radio Point alarm - PLL state unlock; service impacting alarm from Radio Point (alarm in one or more RP)	Check 1588 VLAN configuration



LED	Display Pattern	Indicates	Action to Take
TIMING LED	Green, solid	Power On, timing	None
	Amber, solid	Self-test failure	Replace Baseband Controller
	Amber, blinking	No timing	Check GPS antenna connection feed
	Off	Firmware upgrade from DMS	None
	Red, solid*	Error in system GPS module down Software/Hardware issues	Replace Baseband Controller Module
CORE LED	Green, solid	Power On Connection to MME	None
	Amber, solid	Self-test failure	Replace Baseband Controller
	Amber, blinking	No connection to MME IPsec is up	<ul style="list-style-type: none"> <li>• Check the MME configuration on the BC</li> <li>• Check if MME is reachable</li> </ul>
	Off	Firmware upgrade from DMS	None
	Red, blinking	Internet connection IPsec down	<ul style="list-style-type: none"> <li>• Check if Security Gateway is reachable</li> <li>• Check security credentials</li> </ul>
	Red, solid*	No Internet Interface hardware issues	Replace Baseband Controller Module
* Note: When all of the LEDs are solid red, there is a BC hardware failure.			

## Radio Point LED patterns

The Radio Point has two LEDs on the front cover, indicators for Radio and PoE+. The following table shows

- Display pattern for each LED
- What the pattern indicates
- Action to take, if any, to resolve the issue

LED	Display Pattern	Indicates	Action to Take
RADIO	Green, solid	Power On, transmitting	None
	Amber, solid	<ul style="list-style-type: none"> <li>• RFTxState OFF</li> <li>• No Controller Assigned</li> <li>• No Timing</li> </ul>	<ul style="list-style-type: none"> <li>• Check 1588 VLAN configuration</li> <li>• Verify RP is in STANDBY because more than 32 RPs are connected</li> </ul>
	Red, solid	<ul style="list-style-type: none"> <li>• No connection to Controller</li> <li>• HW error</li> <li>• Low Power</li> </ul>	Hardware error – replace RP module
	Green, blinking	Firmware upgrade	None
	Amber, blinking	RF module Self-Test Failure	Replace RF module
POE+	Green, solid	Power On, PoE++ power	None
	Amber, solid	Link up, no power	Check that the Ethernet cable is connected to the RP
	Green, blinking	PoE+ power	None
	Amber, blinking	Platform Self-Test Failure	Replace RP
	Red, solid	Ethernet port error	<ul style="list-style-type: none"> <li>• Connect the Ethernet cable between the BC and RP</li> <li>• Replace RP</li> </ul>
* Note: When all of the LEDs are solid red, there is an RP hardware failure.			

## Specifications

This appendix contains specifications for CommScope OneCell, including FCC information and technical data.

<a href="#">Electrical ratings and technical data</a>
---

<a href="#">C-2</a>
---------------------

## Electrical ratings and technical data

The following table lists the electrical ratings and technical data for the Baseband Controller.

<b>Operating Environment</b>	0 to 40°C, 10 to 90% relative humidity, indoor use only, not for wet environments
<b>Electrical Rating</b>	100 - 230 AC, 2.0A, 50 - 60Hz (auto ranging, no adjustment required)
<b>Dimensions</b>	19" w x 1.75" H x 18.8" D (483mm W x 44.4mm H x 477mm D)
<b>Weight</b>	Single BC 13.1 lbs (5.9 KG), Dual BC 19.1 lbs. (8.7 KG)
<b>Safety</b>	IEC 60950-1 2005 (Second edition) + A1:2009

## SPF/SPF+ specifications

The following table lists the SPF and SPF+ specifications required for the Baseband Controller.

1G SFP LC SX Transceiver; 220M to 1K M
1G SFP LC LX transceiver, 550M 10K M
10G SFP+ LC SR Transceiver; Multi mode 26M to 300M
SFP-10G-LR Transceiver; Single mode 10KM
10G Direct attach SFP+ cable; Twin ax Cable; 7M (must be compatible with HP & Cisco switches)

## Field Replaceable Units

This appendix contains instructions for replacing Baseband Controller modules and Radio Points in the OneCell system.

<a href="#">FRU overview</a>	<a href="#">D-2</a>
<a href="#">Replacing Baseband Controller modules</a>	<a href="#">D-2</a>
<a href="#">Replacing Radio Points</a>	<a href="#">D-13</a>
<a href="#">Replacing RF modules</a>	<a href="#">D-49</a>

## FRU overview

Field Replaceable Units (FRUs) are modules that can be replaced on-site in case of equipment failure. On-site and off-site activities are required when replacing modules. The off-site activities are achieved by using DMS.

This appendix contains details for replacing Baseband Controllers (BC) modules and Radio Points (RP).

## Replacing Baseband Controller modules

The following procedure provides instructions for replacing the OneCell Baseband Controller (BC) module in a live network environment.

This procedure is divided into four sections:

- [Prerequisites](#)
- [Off-site activities](#)
- [On-site activities](#)
- [Post-Install Verification](#)

### Prerequisites

The following table contains a checklist of prerequisites for replacing a BC.

	Prerequisite
	UDEF file for DMS import
	SSH password
	Replacement OneCell BC module
	Laptop for Web GUI access
	Config.tar file containing operator information <b>Note:</b> This file should be saved on the Laptop that will be used for WebGUI access.
	License file (if applicable) <b>Note:</b> This file should be saved on the Laptop that will be used for WebGUI access.

	Prerequisite
	Configuration details for WebGUI commissioning <b>Note:</b> These parameters are derived from the failed unit being replaced.
	Ethernet cable <b>Note:</b> Required for connecting the laptop to the OneCell Baseband Controller Management port
	DMS FTP IP address

### Off-site activities

Before replacing the BC module, import a new EDF file to the DMS. This file contains the BC MAC address and HeMs password specific to the new BC.

- 1 Access the FTP location on DMS using ftp protocol, port 2100.
- 2 Upload the EDF file to `/appdata/dms/import/factory`.
- 3 Access the DMS Network console from a supported Web Browser.

**NOTE:** The DMS GUI supports Internet Explorer versions 9, 10 and 11 and Chrome version 36 Web browsers, and a screen resolution of 1024 x 768 and higher.

- 4 Enter the IP address for the Network Management portal.

`http://<IP Address DMS server>/networkconsole`

The Sign In dialog box displays.

The image shows a web-based sign-in interface. At the top, it says "Sign in to continue". Below this, there are two input fields: "Username" with a person icon and "Password" with a magnifying glass icon. Under the password field is a checkbox labeled "Remember me". At the bottom of the form is a blue button with the text "Sign in".

- 5 Enter Username and Password. The Search Device screen displays.
- 6 Enter the device Mac ID.  
The Network Management Portal opens.
- 7 Select Import tab located in the left margin of the Device console.
- 8 Select File Import.

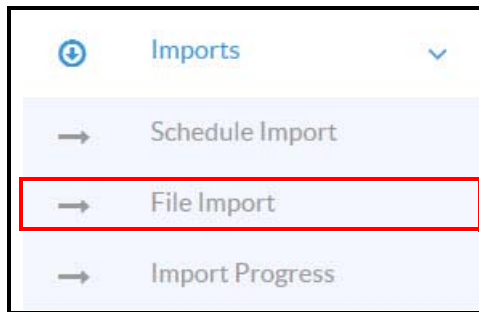

- 9 Browse and select the desired import file. The EDF file format is xml.

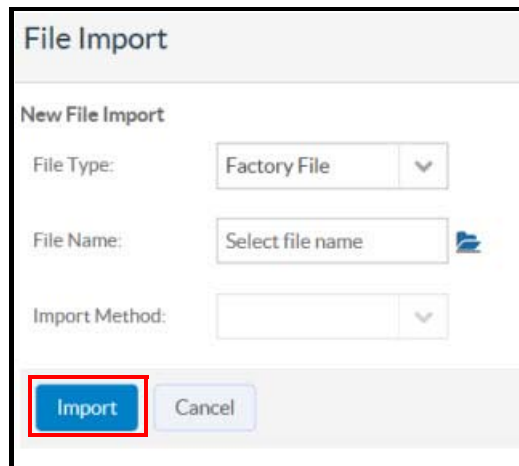

- 10 Click **Import**.
- 11 Click **Import Progress**. Wait for the import to be completed.



### Import Progress

File Type	Operation/File Name	Import Method	Start time	End time	Import Status	Devices Impacted
File Import	uedf-factory-NW-0005B9A10_Sim_CU.xml	FACTORY	2015-05-19 18:49:11 IST		In Progress	<a href="#">View Details</a>
File Import	servicesetting_ServiceSettings_new.xml	COMPLETE	2015-05-19 18:38:33 IST		In Progress	<a href="#">View Details</a>
File Import	servicesetting_ServiceSettings_new_20150429145834.xml	AUTO	2015-05-16 00:14:35 IST		In Progress	<a href="#">View Details</a> 2
File Import	servicesetting_ServiceSettings_new.xml	AUTO	2015-05-15 22:49:20 IST		In Progress	<a href="#">View Details</a>
File Import	servicesetting_ServiceSettings_new.xml	AUTO	2015-04-30 11:32:00 IST		In Progress	<a href="#">View Details</a> 112
File Import	servicesetting_ServiceSettings_new_20150429145834.xml	COMPLETE	2015-04-30 10:29:12 IST		In Progress	<a href="#">View Details</a> 112

12 Click the Operational History icon in the upper right corner of the page.



The Operational History page displays. Check that the file import was successful.

### Operational History

View:  entries

Start Time	Category	Method	File Name	Operation Type	Operation Status	De
2015-05-15 18:16:08 IST	Proactive Scheduled Job	All	Shiva	Provision	Success	<a href="#">View Details &gt;</a>
2015-05-15 18:10:41 IST	Service Package		S1000 - 1.0.1.0-NR06-10	Service Package Save	Success	<a href="#">View Details &gt;</a> 22
2015-05-15 18:04:56 IST	Service Package			Service Package Upgrade	Success	<a href="#">View Details &gt;</a> 22
2015-05-15 17:02:14 IST	Reports	Pws Report Generation	FemtoLTE_CMAS.XML	Pws Report	Success	<a href="#">View Details &gt;</a>
2015-05-15 16:22:42 IST	Reports	Pws Report Generation	FemtoLTE_CMAS.XML	Pws Report	Success	<a href="#">View Details &gt;</a>
2015-05-15 13:05:17 IST	Service Package		S1000 - 1.0.1.0-NR06-10	Service Package Save	Success	<a href="#">View Details &gt;</a>
2015-05-15 13:01:20 IST	Service Package		S1000 - 1.0.1.0-NR06-10	Service Package Save	Success	<a href="#">View Details &gt;</a> 22
2015-05-15 13:00:11 IST	File Import	FACTORY	uedf-factory-RW-0005B9A200_Sim_RP.xml	FACTORY	Success	<a href="#">View Details &gt;</a>
2015-05-15 12:58:10 IST	File Import	FACTORY	uedf-factory-NW-0005B9A10_Sim_CU.xml	FACTORY	Success	<a href="#">View Details &gt;</a>
2015-05-15 08:30:02 IST	Purge	SPS Audit Report Purge		SPS Audit Report	Success	<a href="#">View Details &gt;</a>
2015-05-15 05:30:06 IST	Reports		0005B9-LTEWIFISC_Delta-device-config-2015-05-15-05-30.txt	Device Delta Report	Success	<a href="#">View Details &gt;</a>
2015-05-15 05:30:04 IST	Reports	Pws Report Generation	FemtoLTE_CMAS.XML	Pws Report	Success	<a href="#">View Details &gt;</a>
2015-05-15 05:30:03 IST	Reports	SPS Audit Report Generation	SPS_AUDIT_REPORT_2015-05-15 05:30:02	SPS Audit Report	Success	<a href="#">View Details &gt;</a>
2015-05-15 05:30:02 IST	Reports	Device State Report Generation	Master-device-status-2015-05-15-05-30	Device State Report	Success	<a href="#">View Details &gt;</a>

13 Login to the Device console.

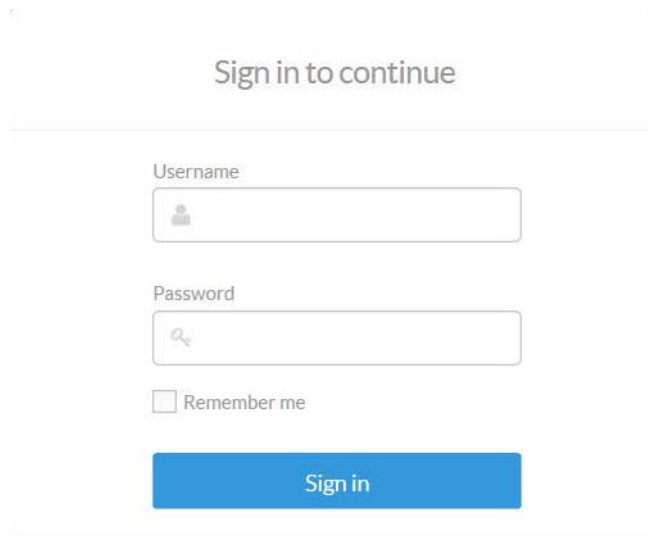

Sign in to continue

Username

Password

Remember me

Sign in

**14** Enter the MAC ID of the replacement Baseband Controller.

**NOTE:** Your CommScope service engineer will provide the new BC MAC ID.

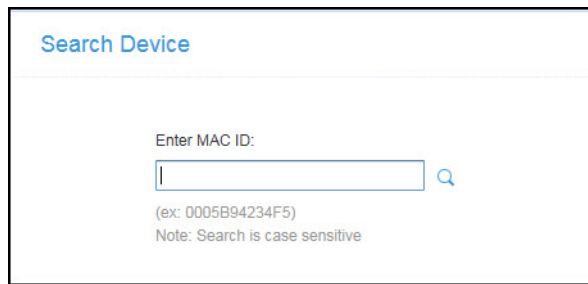

Search Device

Enter MAC ID:

(ex: 0005B94234F5)  
Note: Search is case sensitive

**15** Select the Device configuration tab on the left margin.

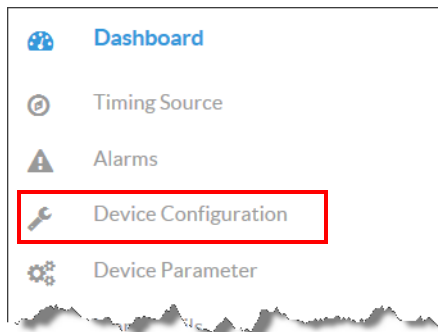

- Dashboard
- Timing Source
- Alarms
- Device Configuration**
- Device Parameter

**16** Configure the same parameters from the BC being replaced.

17 Select the Dashboard menu item.

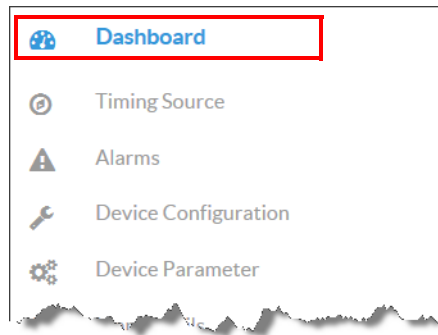

The Controller will display "Out of Service" until the On-site installation is completed.

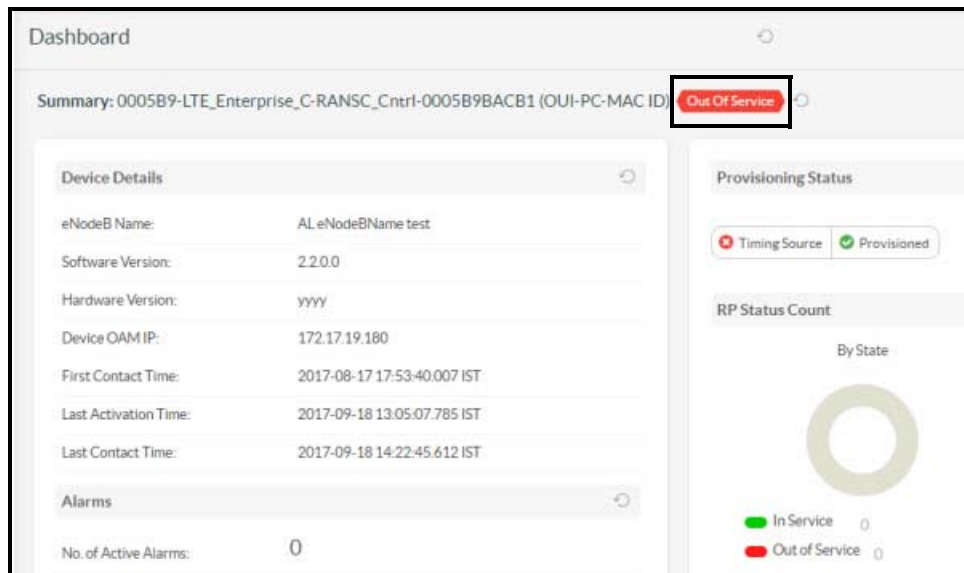

### On-site activities

After the off-site activities are complete, you are ready to replace the BC module on-site.

- 1 Power off the OneCell Baseband Controller.

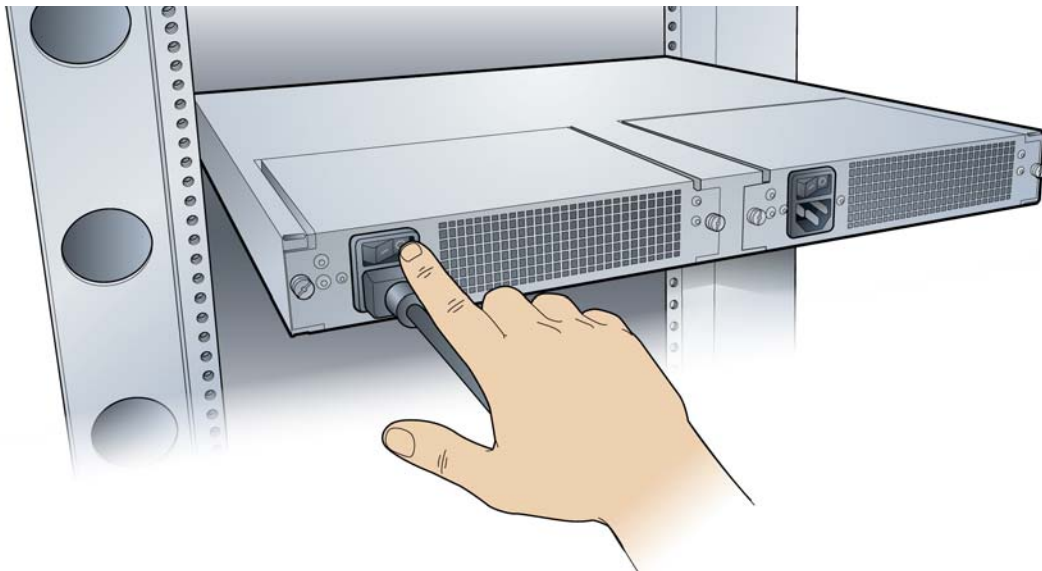

- 2 Make a note of the existing cables connected to the failed OneCell BC.
- 3 Label the cables identifying the port locations on the BC. Disconnect the cables.

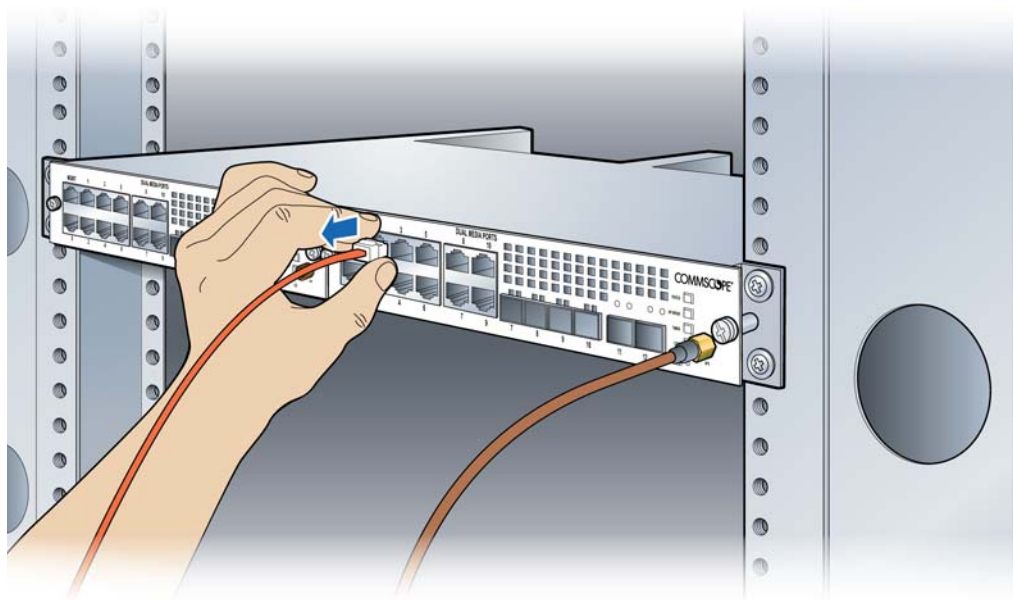

- 4 Remove the GPS antenna cable from the BC (if applicable).

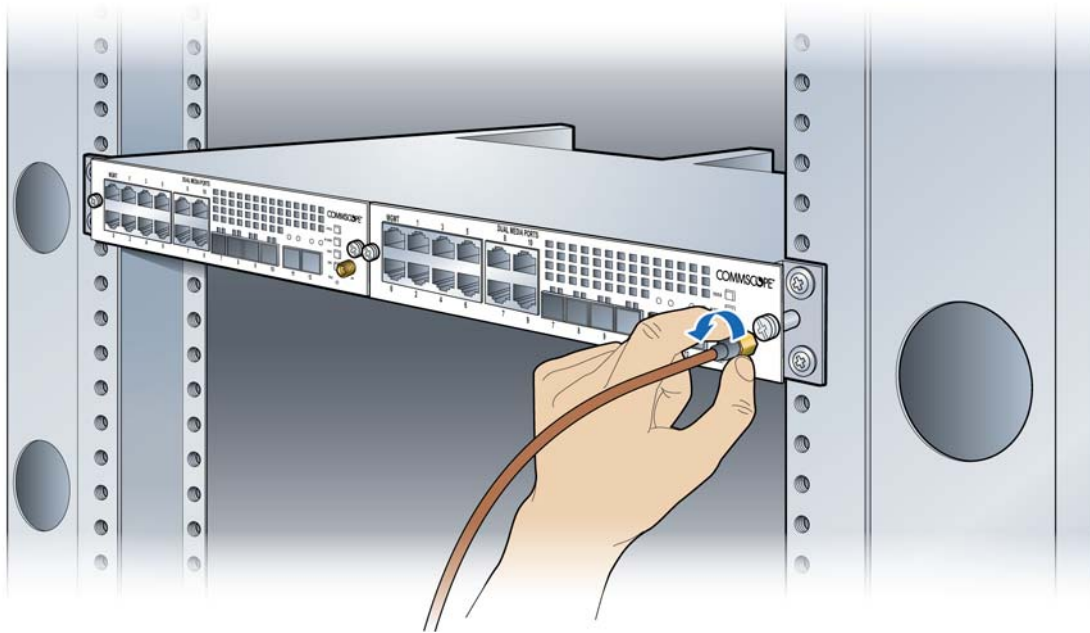

- 5 Turn the mounting screws on the BC front panel counterclockwise to loosen them and remove the BC module.

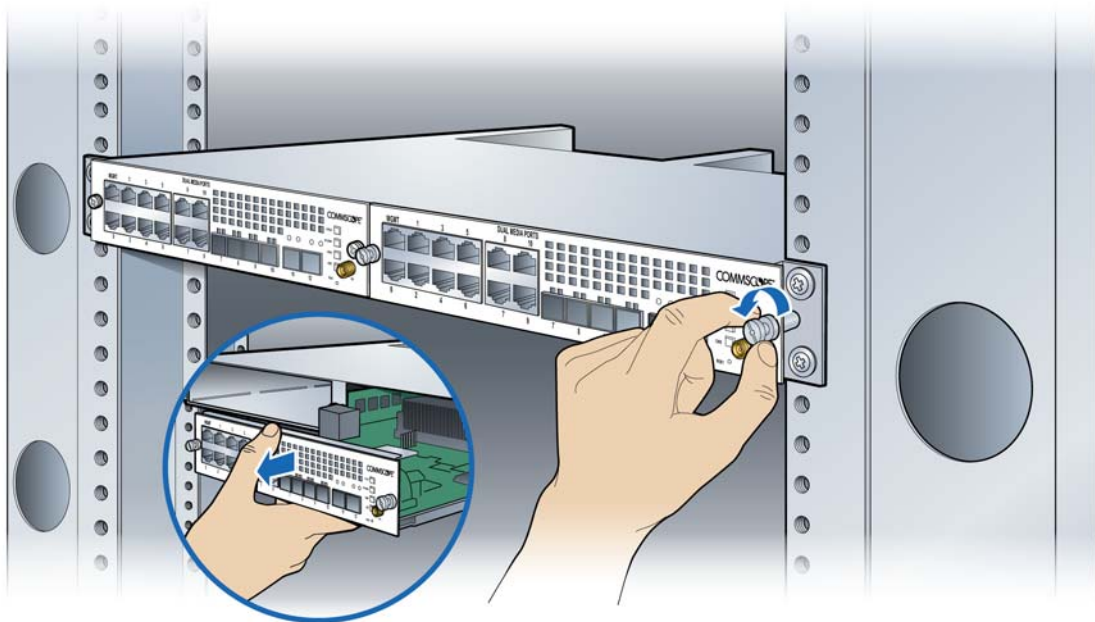

- 6 Insert the new BC module into the chassis and tighten the mounting screws.

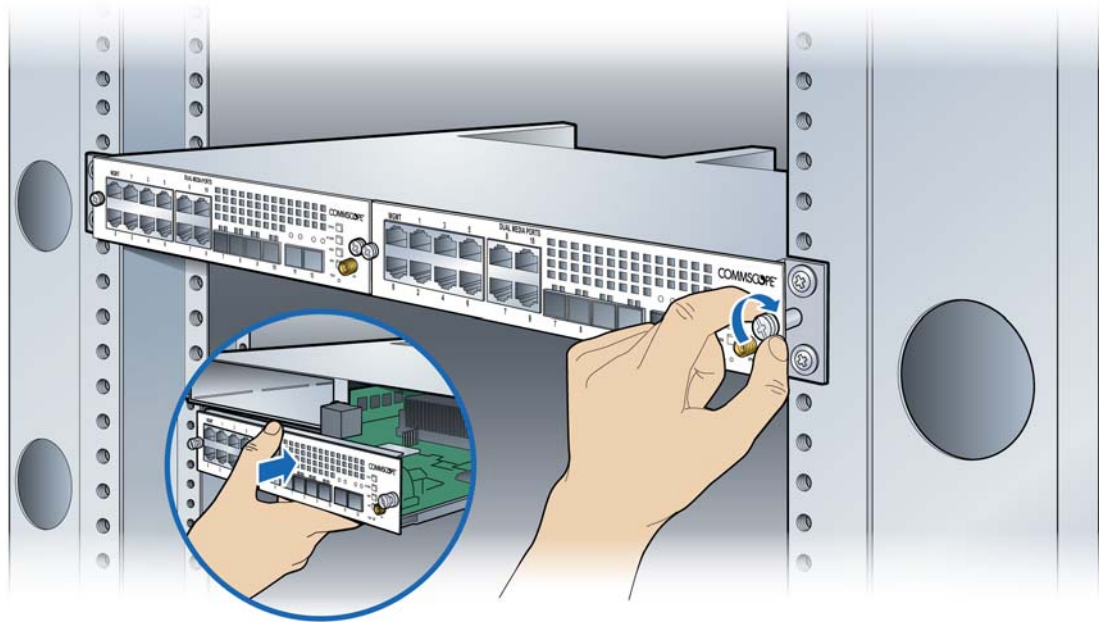

- 7 Re-connect the cables as noted in [step 3](#).

- 8 Power on the controller.

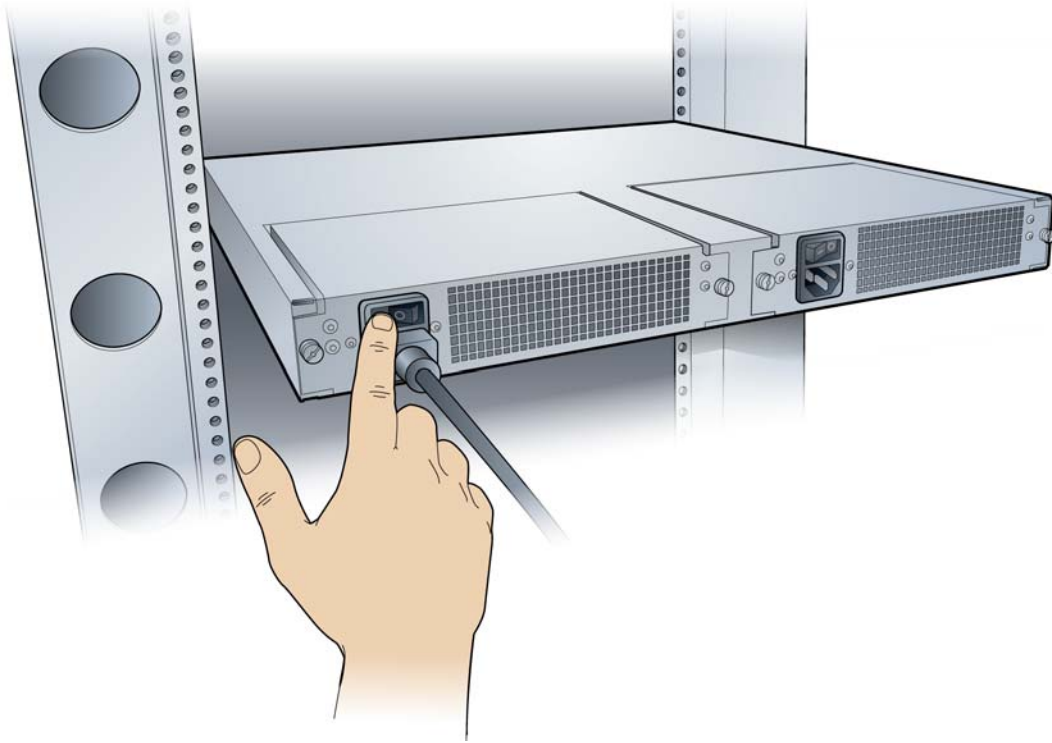

- 9 Configure the BC. Follow configuration procedures starting with [Accessing the Web GUI](#) on page 6-18.

## Post-Install Verification

### On-site

The operational state of the OneCell system can be determined by the LED status on the BC's front panel. Additional information can be attained from the WebGUI status screens.

Start the verification with [Verify the OneCell system installation](#) on page 6-2 and continue through the end of the chapter.

### Off-site

- 1 Open a supported Web browser.

**NOTE:** The DMS GUI supports Internet Explorer versions 9, 10 and 11 and Chrome version 36 Web browsers, and a screen resolution of 1024 x 768 and higher.



- 2 Enter the IP address for the Device Management portal.

`http://<IP Address DMS server>/deviceconsole`

The Sign In dialog box displays.

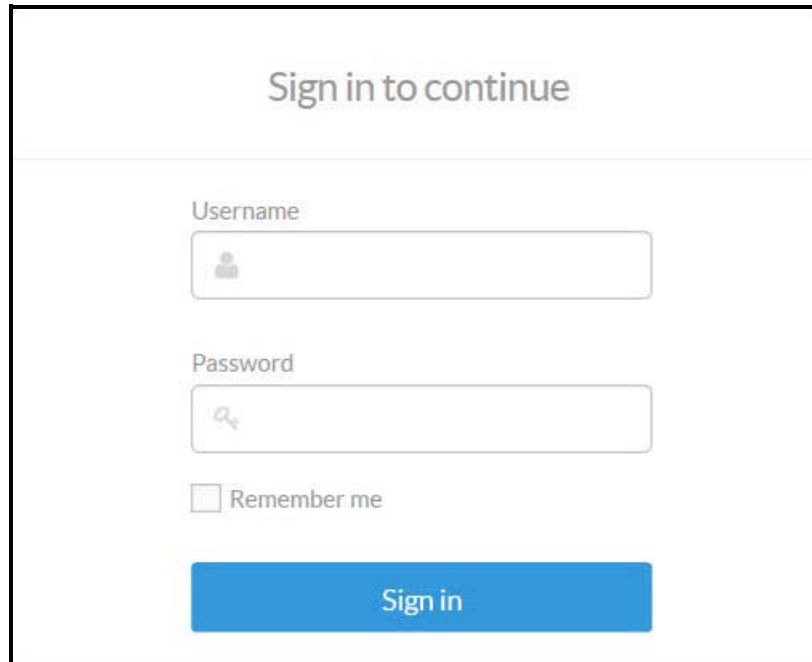

The image shows a 'Sign in to continue' dialog box. It features a title bar with the text 'Sign in to continue'. Below the title bar, there are two input fields: 'Username' with a person icon and 'Password' with a magnifying glass icon. Below the password field is a checkbox labeled 'Remember me'. At the bottom of the dialog is a blue button labeled 'Sign in'.

- 3 Enter Username and Password. The Search Device screen displays.

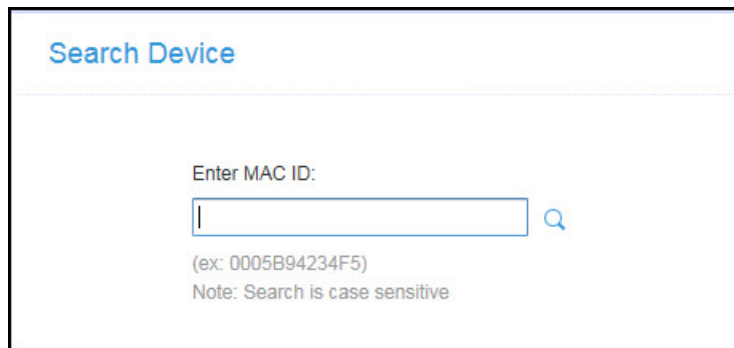

The image shows a 'Search Device' screen. It has a title bar with the text 'Search Device'. Below the title bar, there is a label 'Enter MAC ID:' followed by an input field with a magnifying glass icon. Below the input field, there is an example '(ex: 0005B94234F5)' and a note 'Note: Search is case sensitive'.

- 4 Enter the MAC ID of the new BC.

The BC Dashboard displays. The Summary at the top of the page should show "Ready."



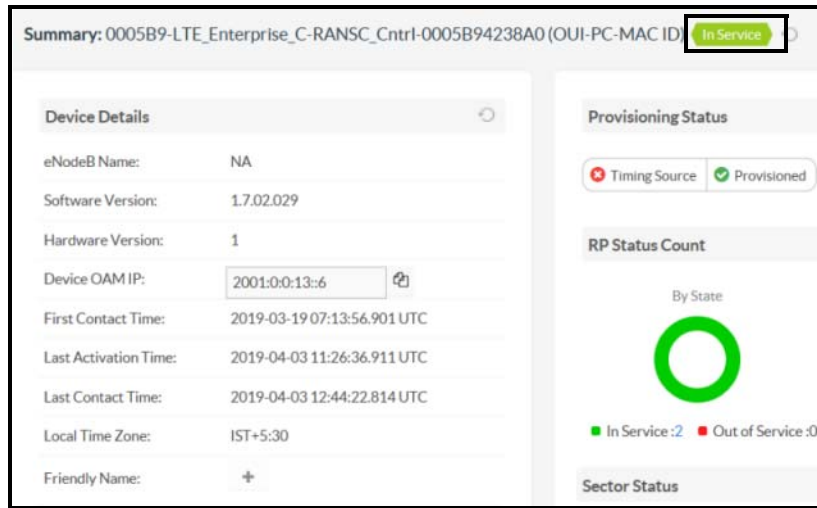

**NOTE:** Provision the remaining Device configurations to align with the failed BC configuration on the DMS Device Configuration page.

5 Scroll to the bottom of the page to view the Device PnP status.

If all of the PnP boxes have green checks, the BC replacement is successful. Stop here.

If one or more of the PnP boxes are red, those activities failed. Go to the Device PnP page to identify the failed activity.

## Replacing Radio Points

The following procedures provide instructions for replacing a OneCell Radio Point (RP) module in a live network environment.

- [Prerequisites](#)
- [On-site activities](#)
- [Replacing a ceiling RP5100i \(above tile\)](#)
- [Replacing a flown mounted RP5100i](#)
- [Replacing a pole mounted Indoor RP](#)
- [RP post-replacement verification](#)

### Prerequisites

The following table contains a checklist of prerequisites for replacing an RP.

	Prerequisite
	SSH password
	Replacement OneCell RP module
	Laptop for Web GUI access
	Ethernet cable <b>Note:</b> Required for connecting the laptop to the OneCell Baseband Controller Management port

### On-site activities

Before replacing the RP, delete the RP from the system using the WebGUI.

- 1 Connect the Ethernet cable to the MGMT port on the BC's front panel.

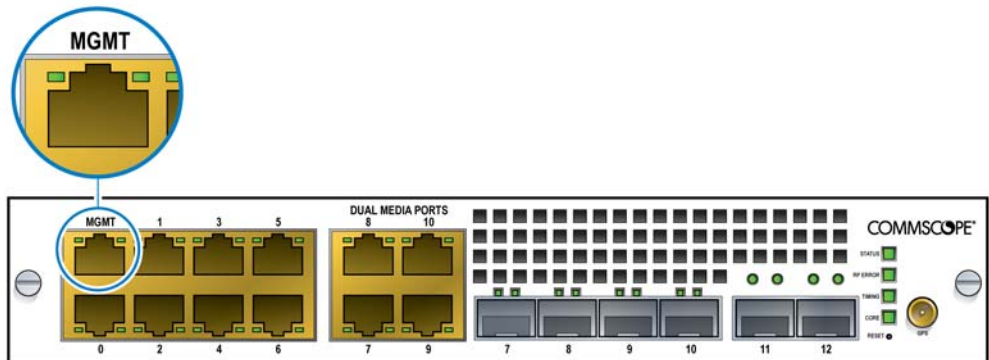

- 2 Open a supported browser.
- 3 Enter the IP address for the GUI, using the format below.

`https://<IP address of Management Interface>:6002`

Example:

`https://192.168.8.1:6002`

The Sign In dialog box appears.

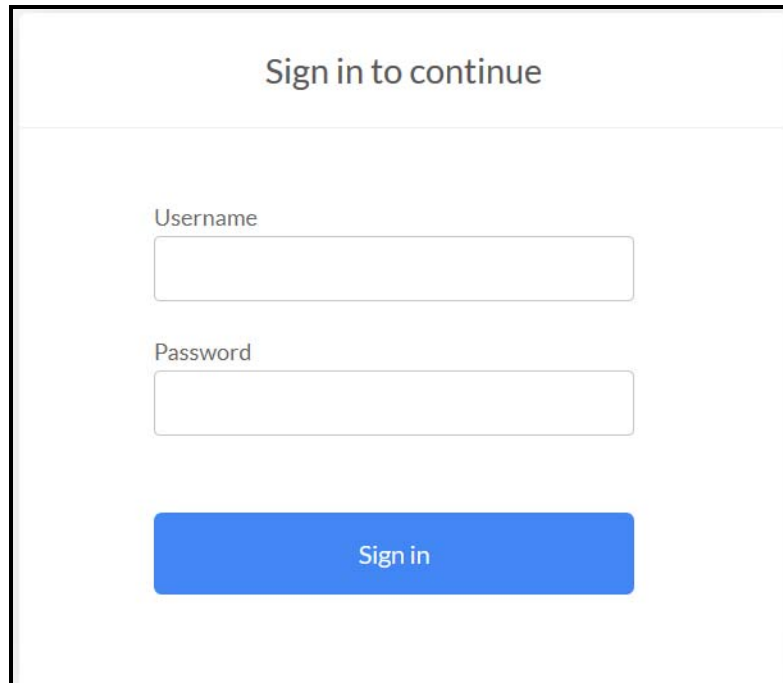

- 4 Ensure the Management Mode tab is selected. The Dashboard displays.

Dashboard Alarms 3 2 1 1

Data last updated on: Mar 12, 2019 2:34:29 PM Refresh to see latest data

**Device Information**

Device Status: UP

Up Time: 80 Hrs 13 Mins 52 Secs

Number of Sectors: 2

Sector 1: UP Sector 2: UP

Admin Status: TRUE TRUE

Operational Status: TRUE TRUE

**Timing Source Status**

GPS: Timing Good Got Fix

**Licensing Information**

Applied: 1 Non Applied: 6

**Radio Points Status**

In Service: 0 Out of Service: 2

**High Availability**

Redundancy: DISABLED Cluster Node State: NA

**Service Status**

Backhaul Network Mode: IPv6 Single Source IP: YES

MME Connection: YES Configuration from HeMS: YES

Security Gateway: Number of IPSec Tunnels: TWO

IPSec Tunnel Status	Tunnel 1	Tunnel 2	Non IPSec	CA Tunnel
IPSec Connection Status	<span style="color: green;">ENABLED</span>	<span style="color: green;">ENABLED</span>	<span style="color: grey;">NA</span>	<span style="color: grey;">DISABLED</span>
Security Gateway Address	10.197.91.12	10.197.91.13	<span style="color: grey;">NA</span>	10.197.91.11
Tunnel Internal Address	2005:1::2:2	2005:1::3:8	<span style="color: grey;">NA</span>	NA
Backhaul Traffic	EPC	HeMS	NA	CA

**CA Server Configuration**

CMPV2 Connection Status: SUCCESS

CMPV2 Last Successful Communication: 2019-02-14 07:02:40

CMPV2 Last Failed Communication Attempt: NA

CMPV2 Last Attempted Communication: NA

CMPV2 Root Certificate Status: VALID

**Operator Certificate Configuration**

Operator Root Certificate Status: VALID

Bootloader Version: Bootloader Dev 2013.01 (Nov 23 2015 - 21:01:04) CU

	Partition 1	Partition 2
Kernel Version	SIQ CU Kernel Image 2019-01-14 12:44:01 UTC	SIQ CU Kernel Image 2019-12-20 8:07:48 UTC
Uboot Version	NA	NA

- 5 On the Dashboard, click the Radio Points link. The Radio Points Dashboard displays.

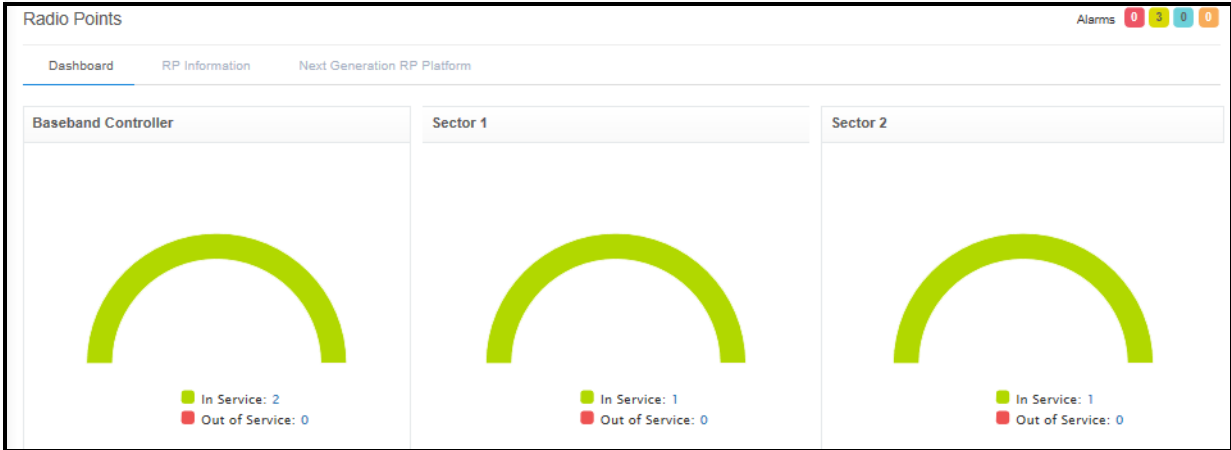

- 6 Click the RP Information tab.

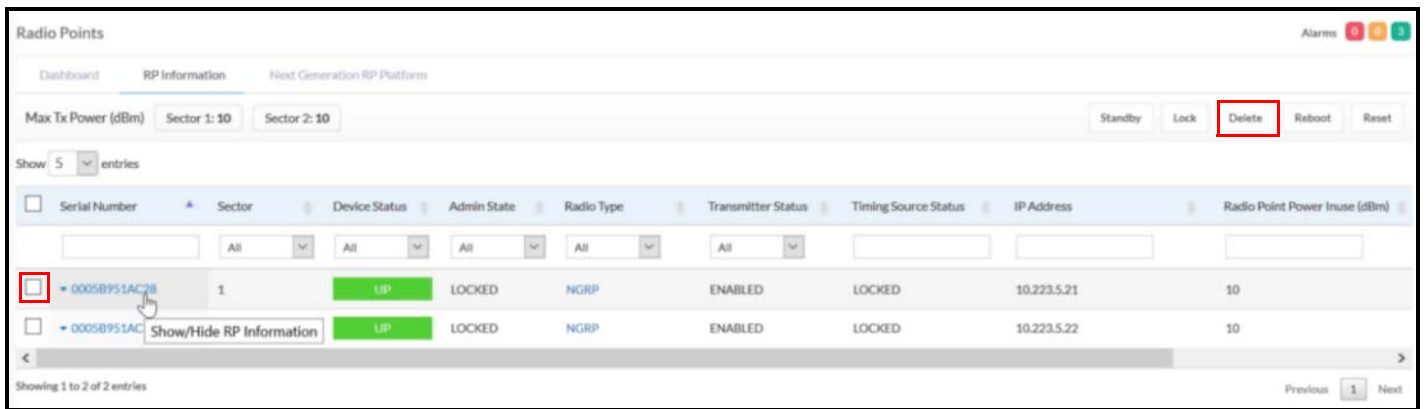

- 7 If one of the Radio Points is Down, select that RP by checking the box next to it.
- 8 Click **Delete**.
- 9 Check the Radio Point Information table to ensure the RP is deleted.

### Replacing a ceiling RP5100i (above tile)

- 1 Remove the ceiling tile next to the mounted RP to allow access to the mounting hardware and Ethernet cable.

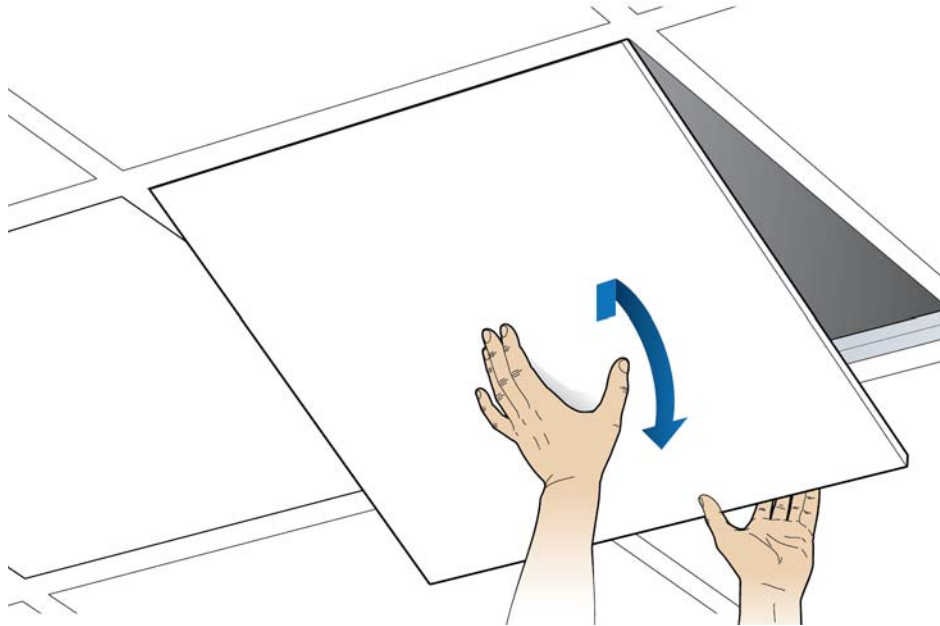

- 2 Remove the RP cover.

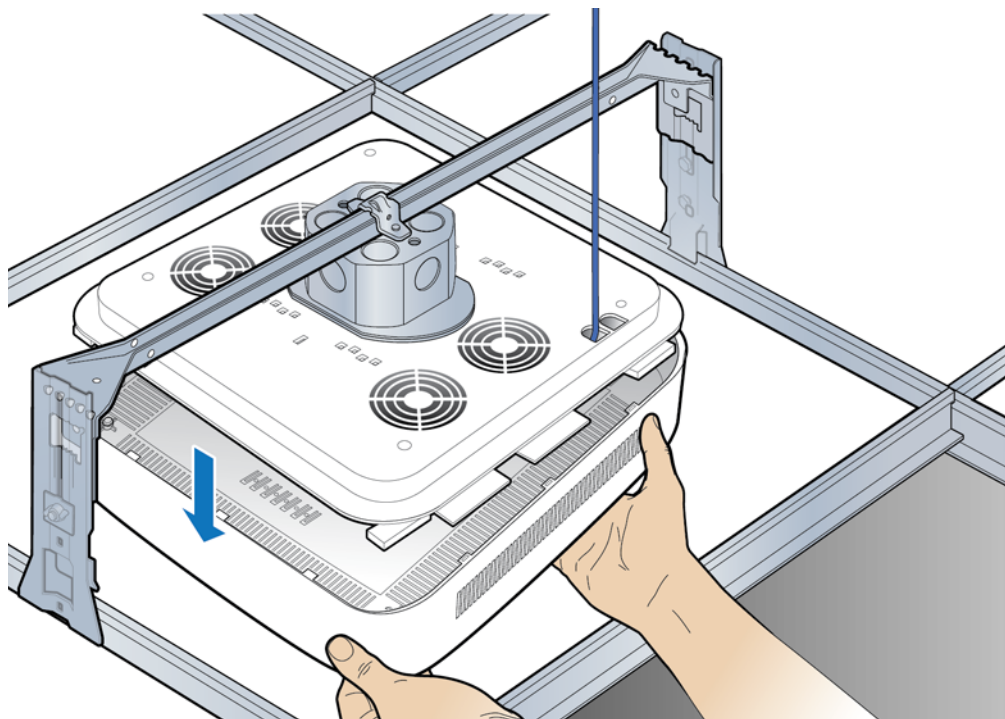

3 Disconnect the Ethernet cable.

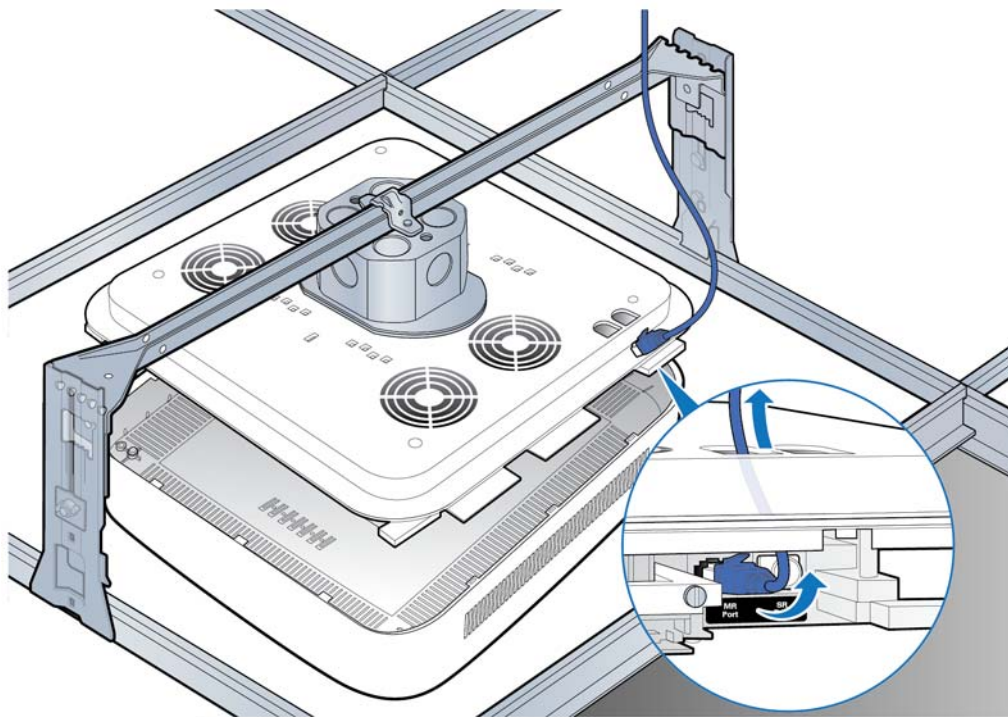

- 4 Replace the cover and twist the RP clockwise to remove it. Set the failed RP aside.

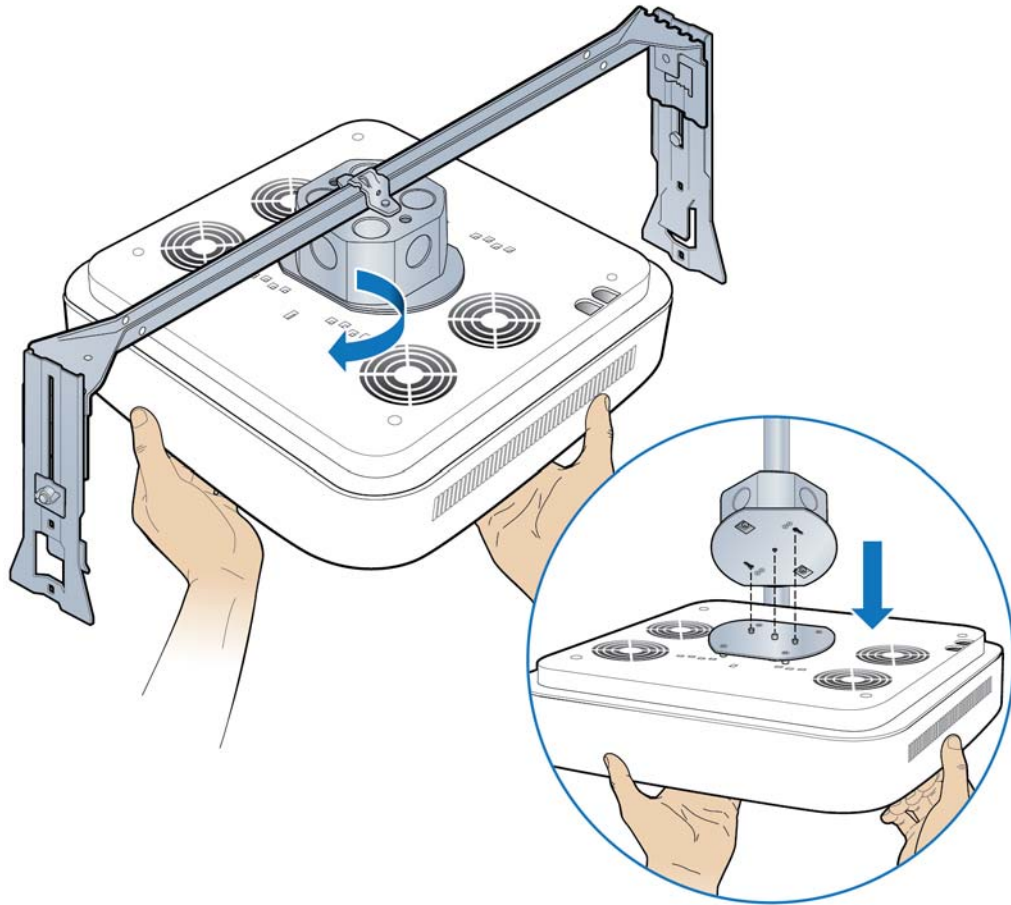

- 5 Attach the mounting plate to the replacement RP.

**NOTE:** Apply thread locking compound to the screws prior to installation.

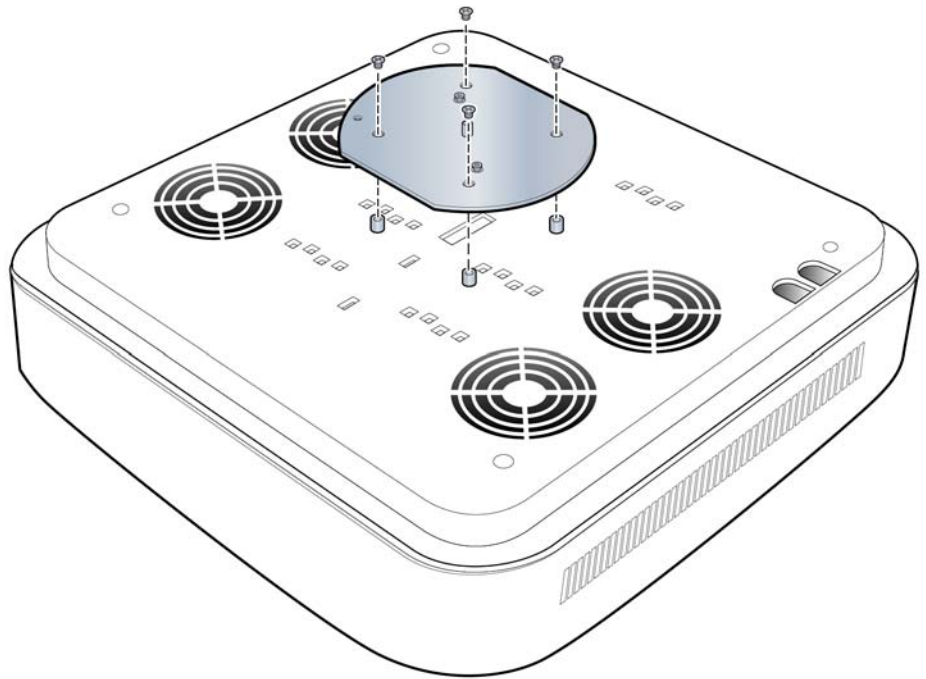



- 6 Attach the RP to the octagonal mounting plate and twist to engage.

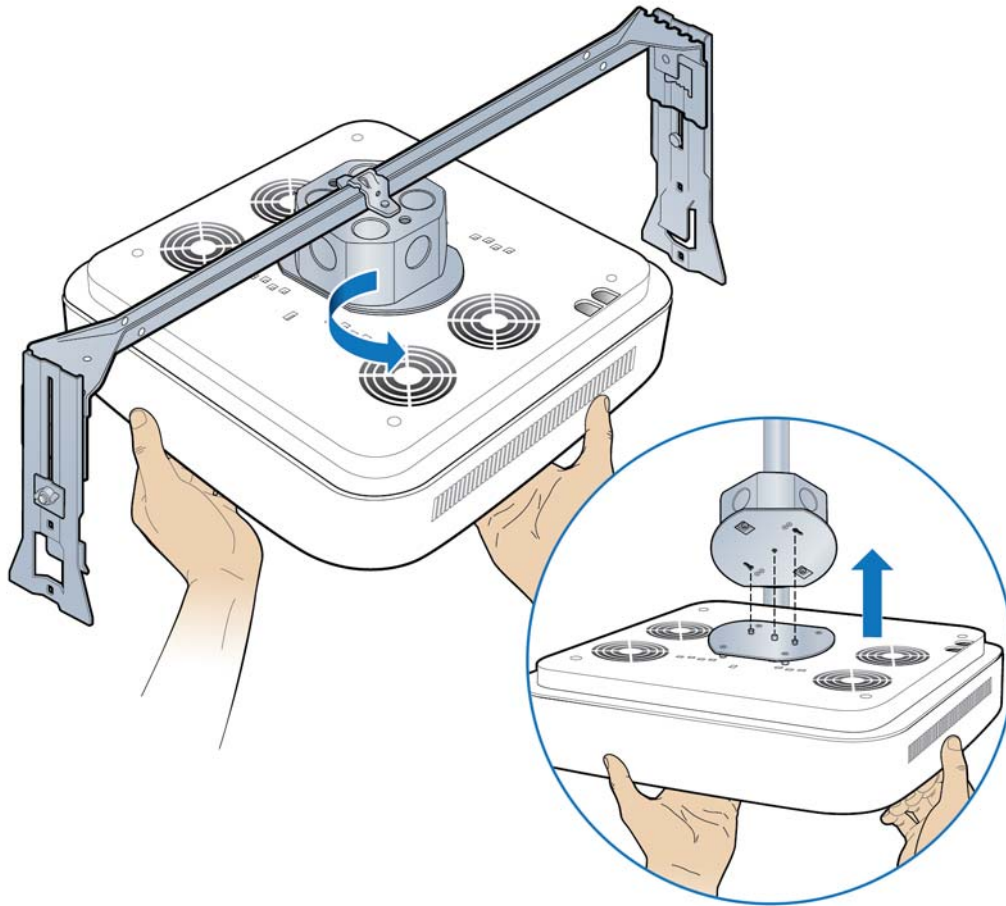

- 7 Remove the cover and connect the Ethernet cable to the MR port.

**NOTE:** The cover is attached to the RP with two lanyards.

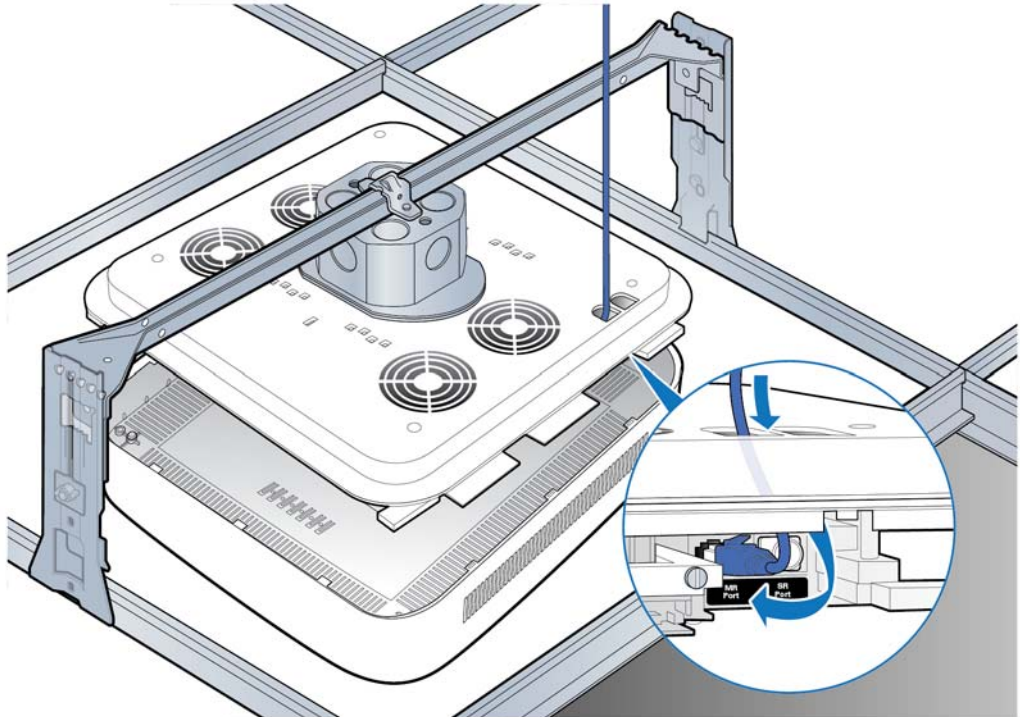

8 Attach the plastic cover to the RP.

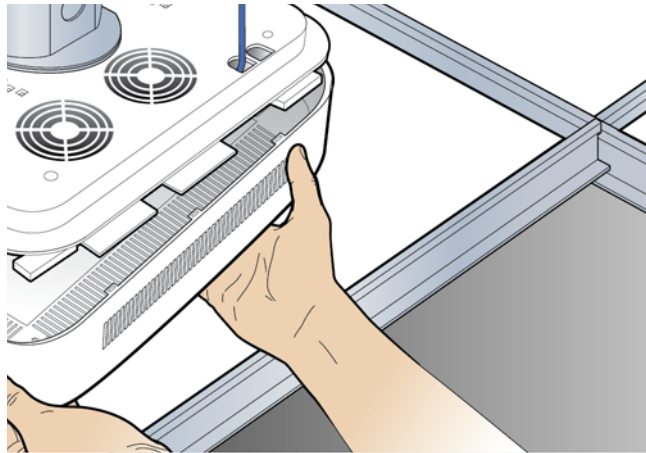

9 Replace the ceiling tile.

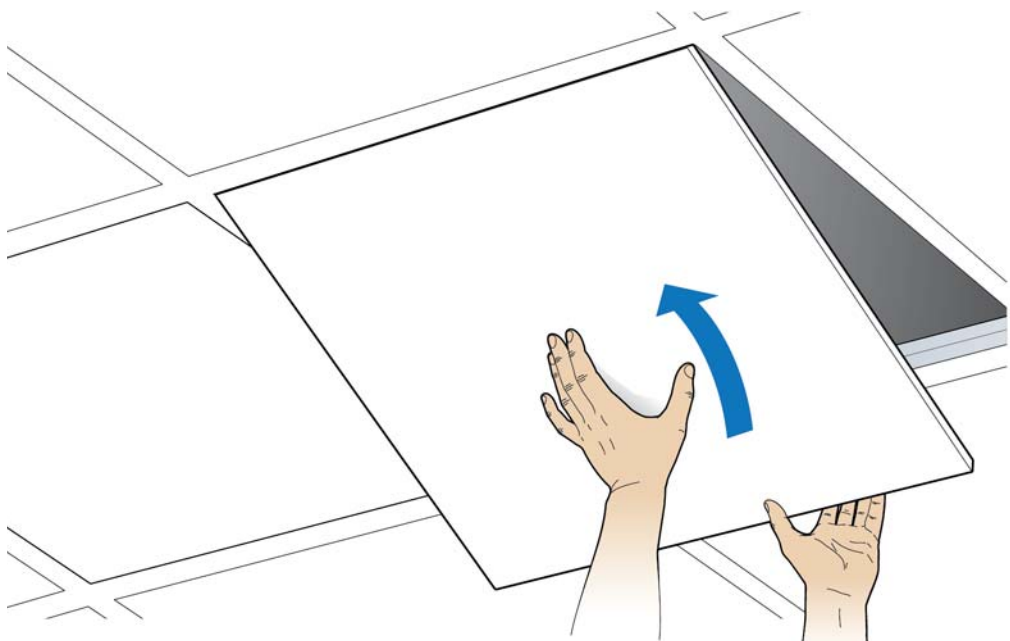

- 10 Verify the RP installation. See The operational state of the RP can be determined by the LED status on the RP. Additional information can be attained from the WebGUI status screens.

For verification procedures, see [RP post-replacement verification](#).

### Replacing a ceiling Indoor RP (on tile)

- 1 Remove the RP cover.

**NOTE:** The cover is attached to the RP with two lanyards.

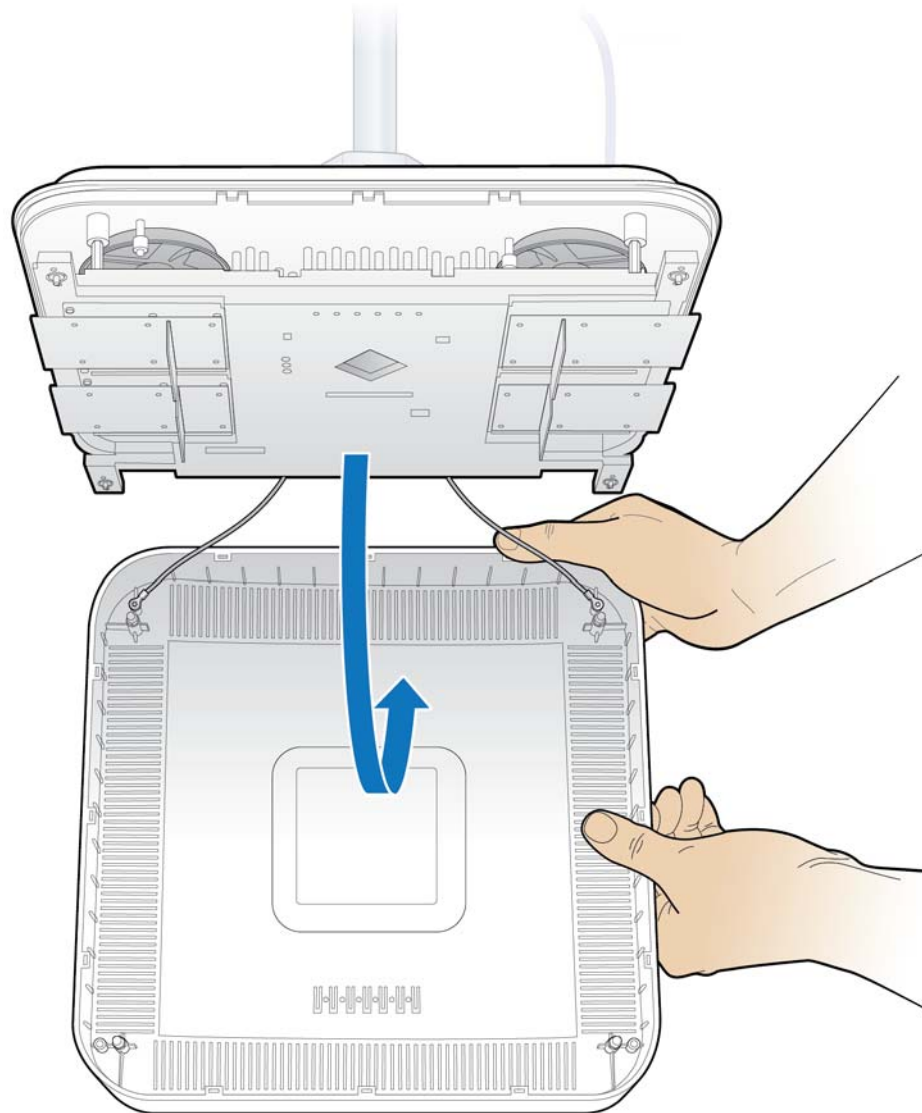

- 2 Disconnect the Ethernet cable from the RP.

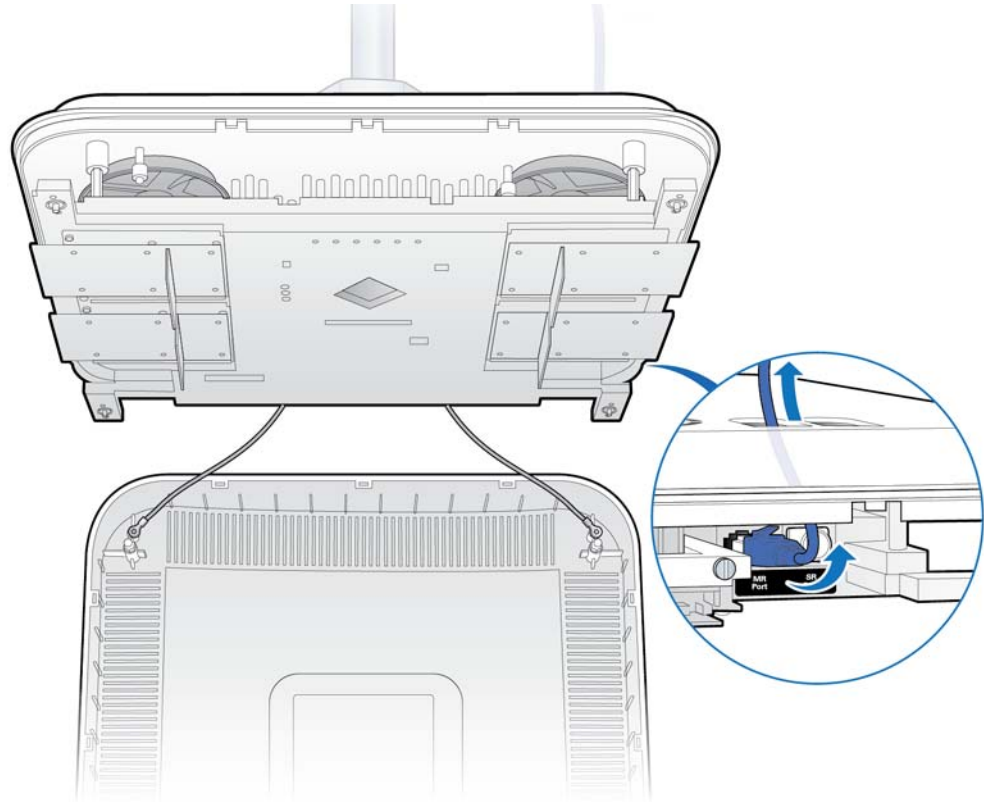

- 3 Replace the cover and twist the RP clockwise and remove the failed RP.

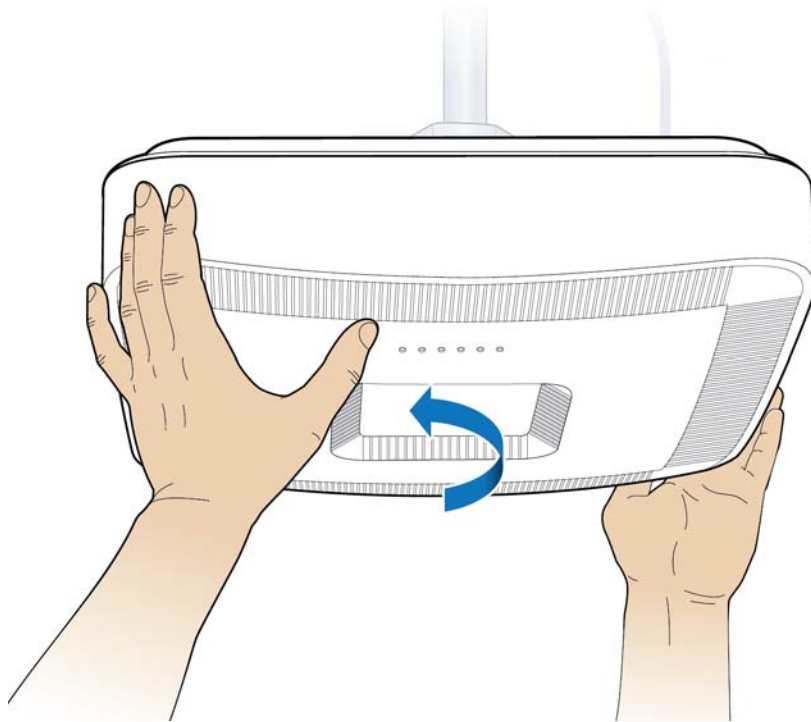

- 4 Attach the plate to the replacement RP.

**NOTE:** Apply thread locking compound to the screws prior to installation.

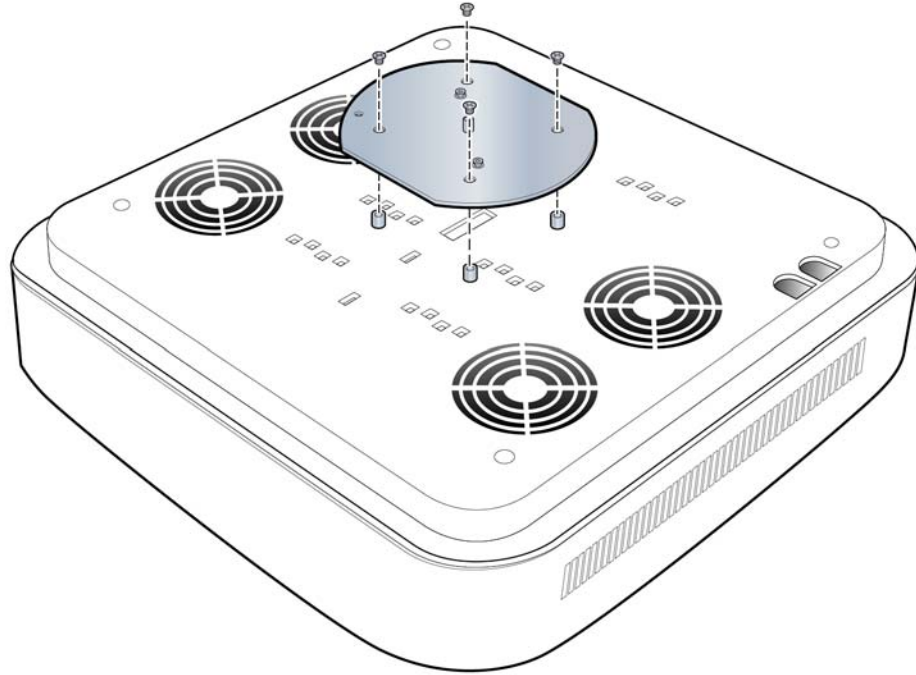

- 5** Attach the RP to the octagonal mounting plate.

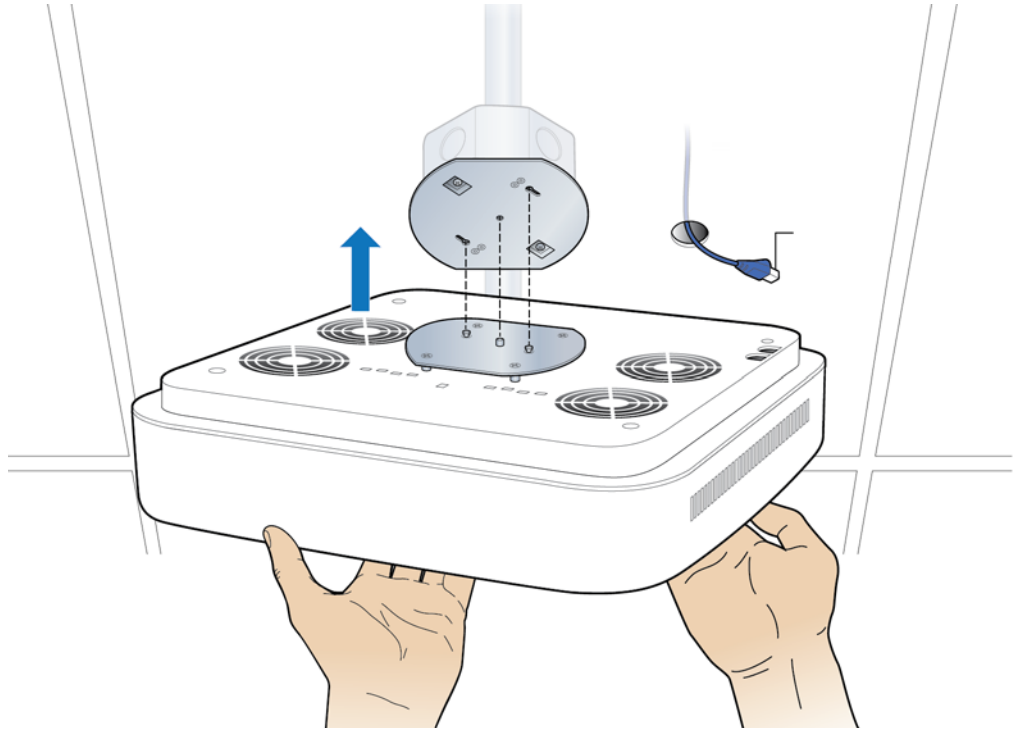

- 6** Secure the RP to the plate by twisting the RP counterclockwise.

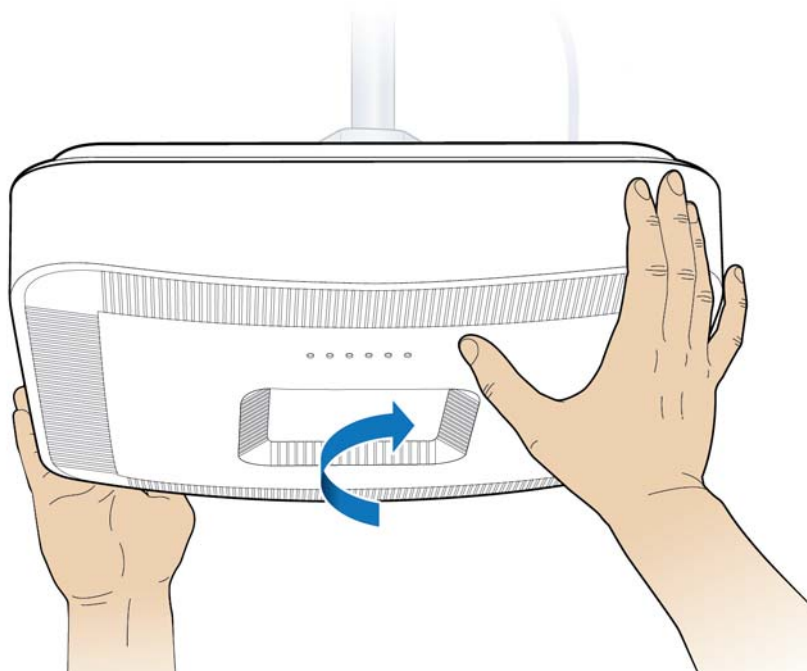



- 7 Remove the cover and connect the Ethernet cable to the MR port.

**NOTE:** The cover is attached to the RP with two lanyards.

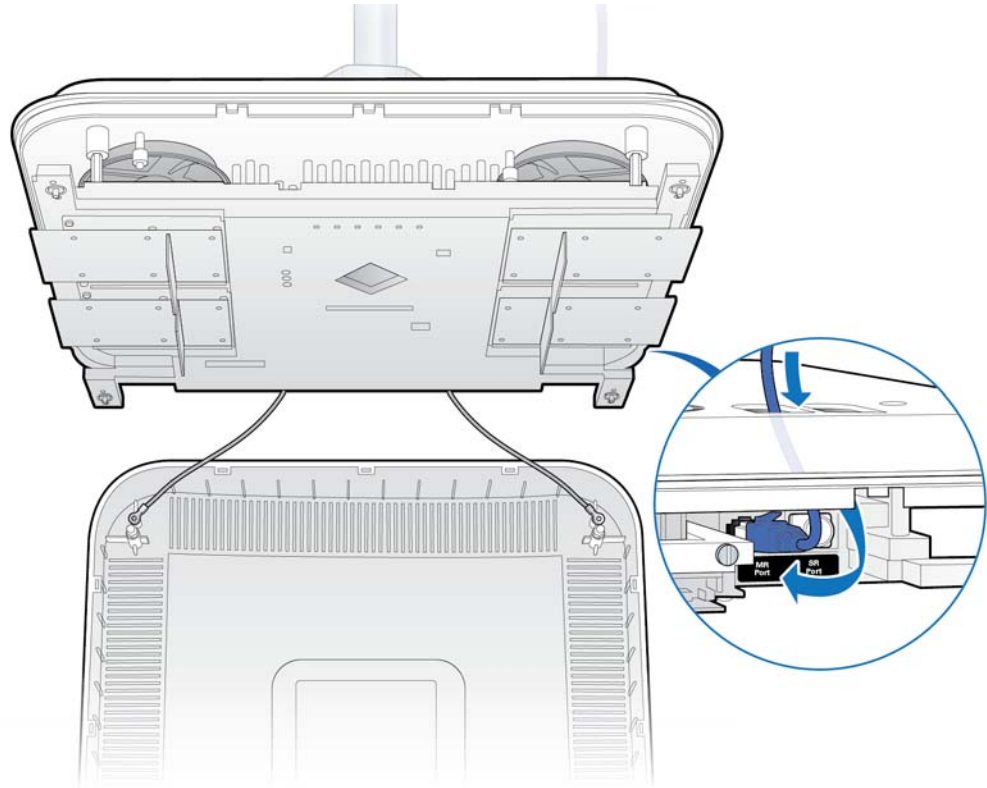

- 8 Attach the plastic cover to the Radio Point.

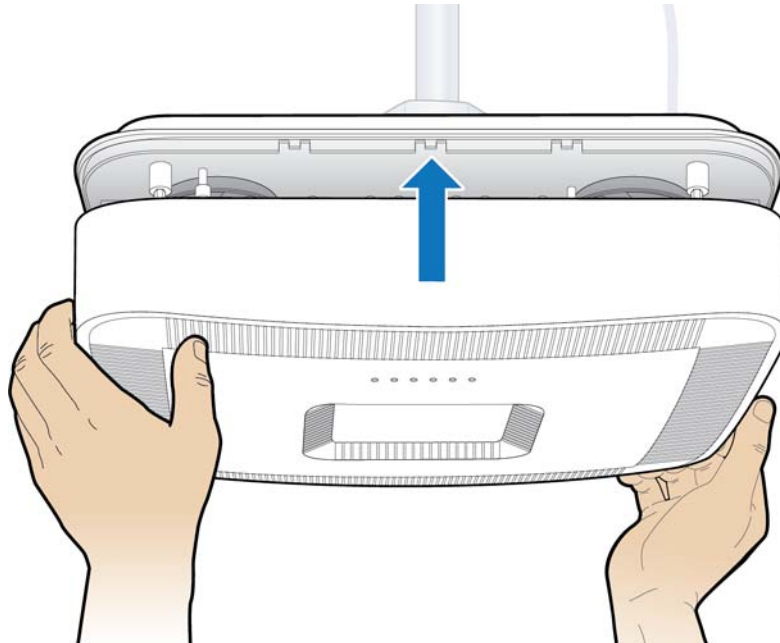

- 9 Verify the RP installation. See The operational state of the RP can be determined by the LED status on the RP. Additional information can be attained from the WebGUI status screens.

For verification procedures, see [RP post-replacement verification](#).

## Replacing a flow mounted RP5100i

- 1 Remove the RP cover.

**NOTE:** The cover is attached to the RP with two lanyards.

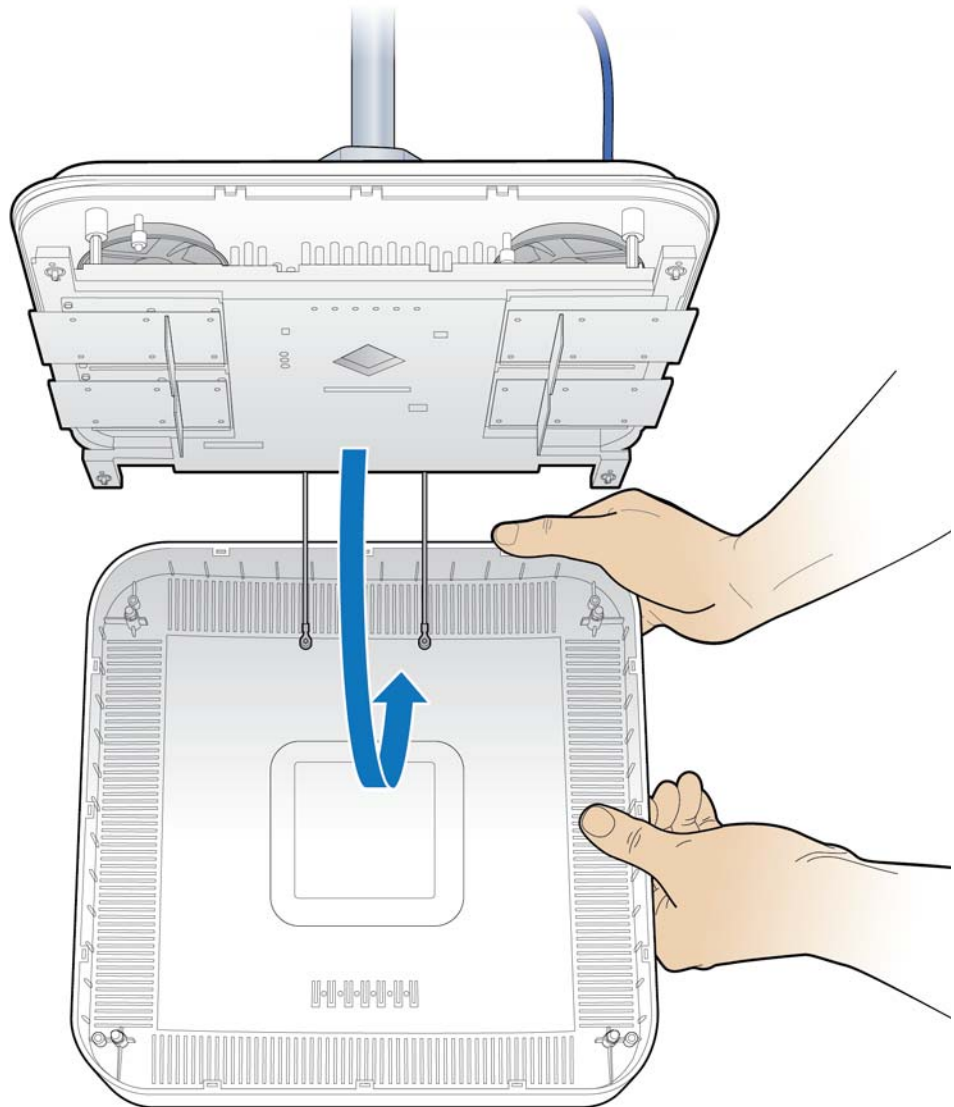

2 Disconnect the Ethernet cable.

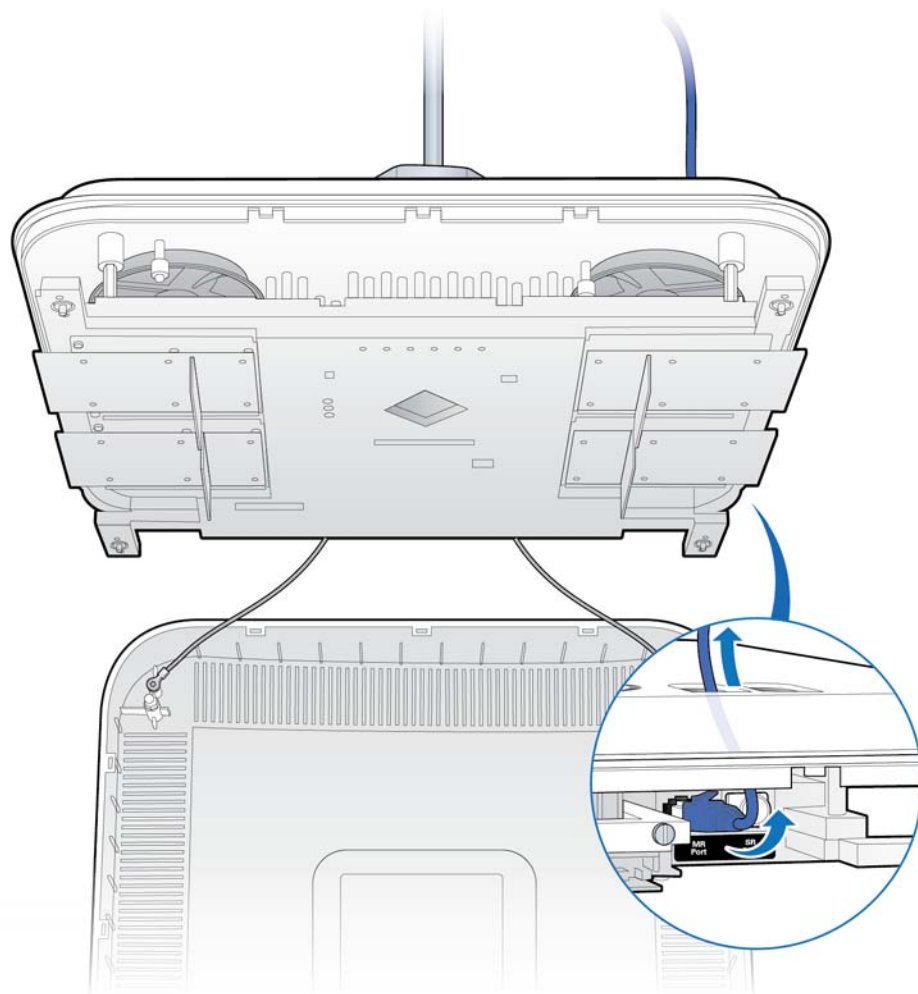

- 3 Replace the cover and twist the RP clockwise.

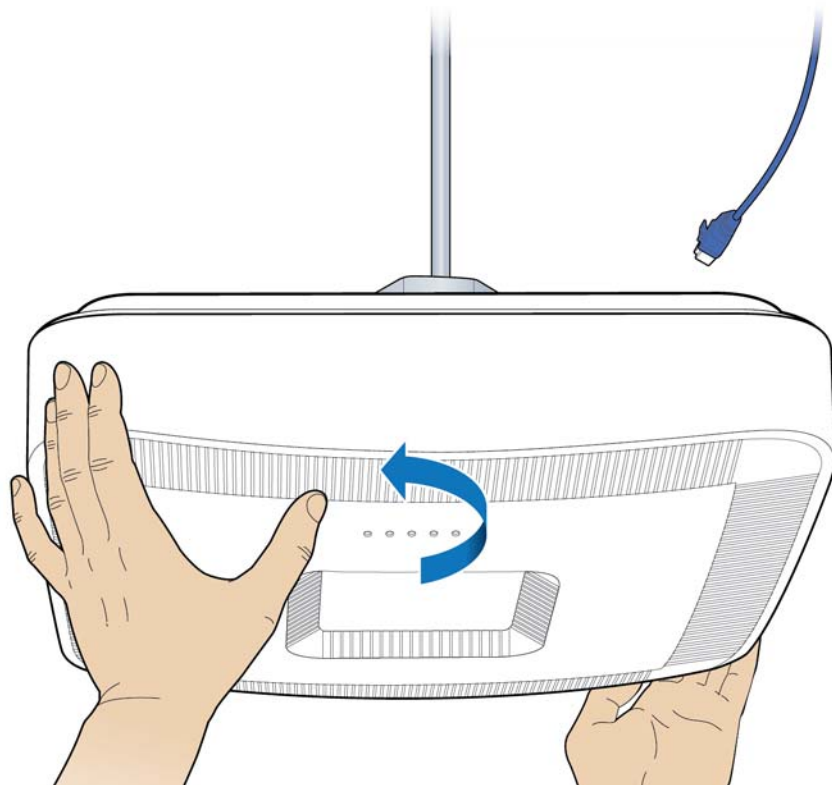

4 Remove the failed RP.

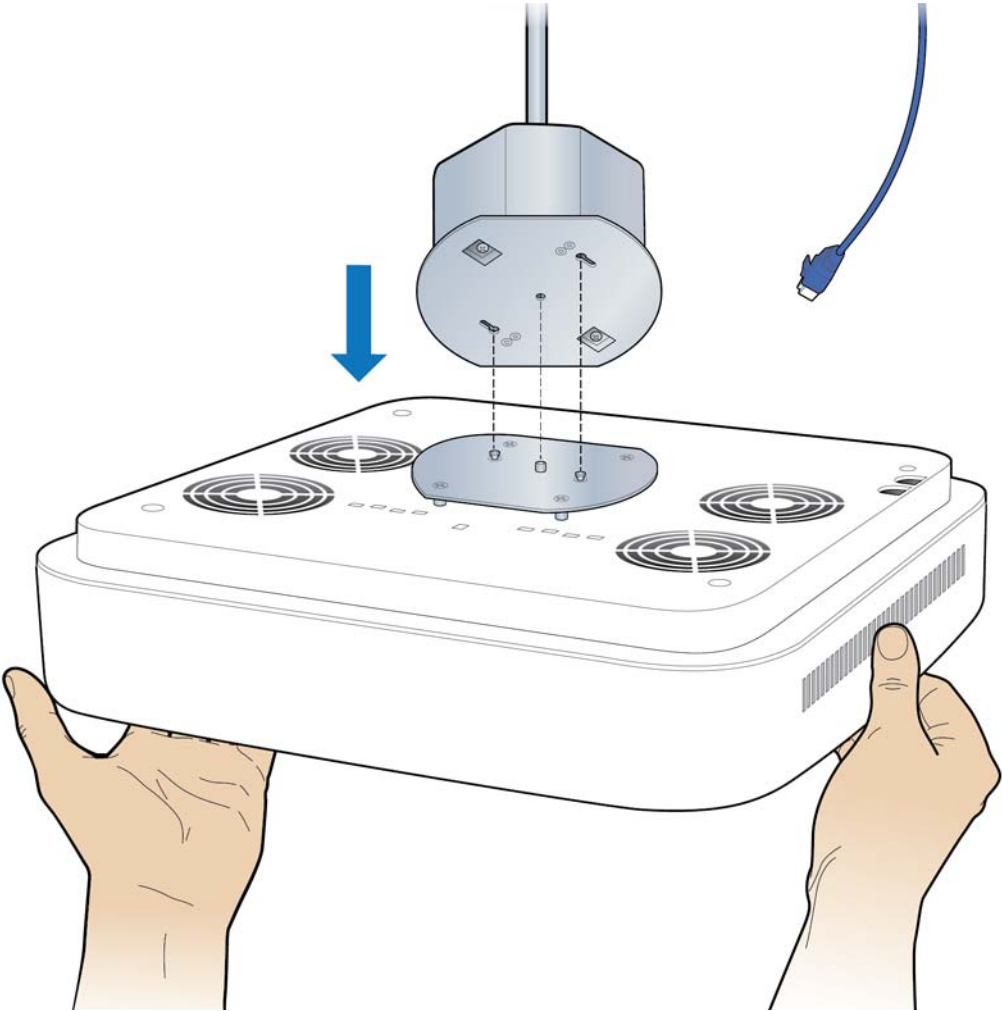

- 5 Attach the mounting plate to the RP.

**NOTE:** Apply thread locking compound to the screws prior to installation.

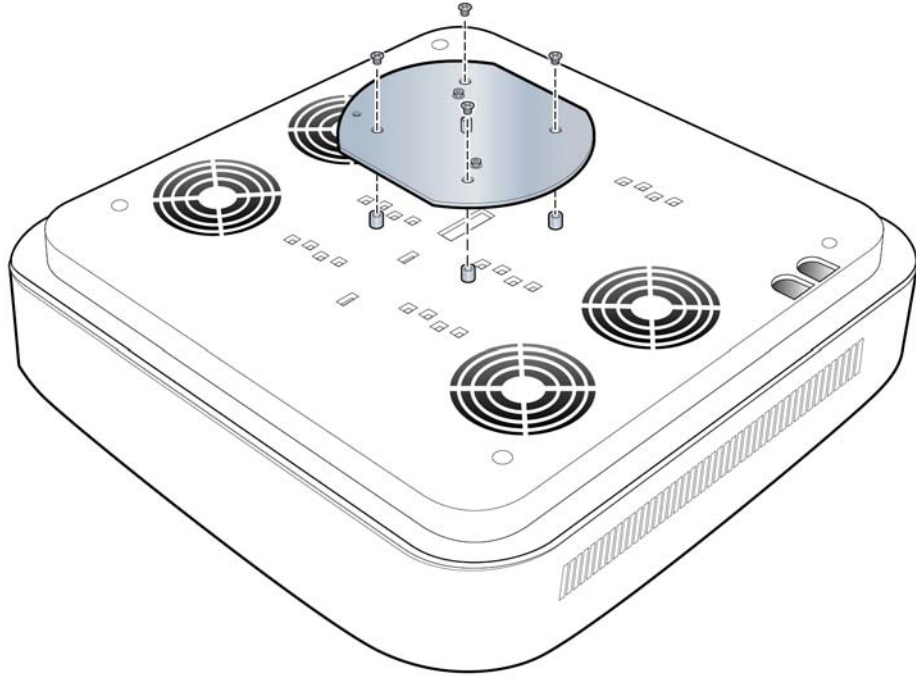

6 Attach the RP to the octagon box.

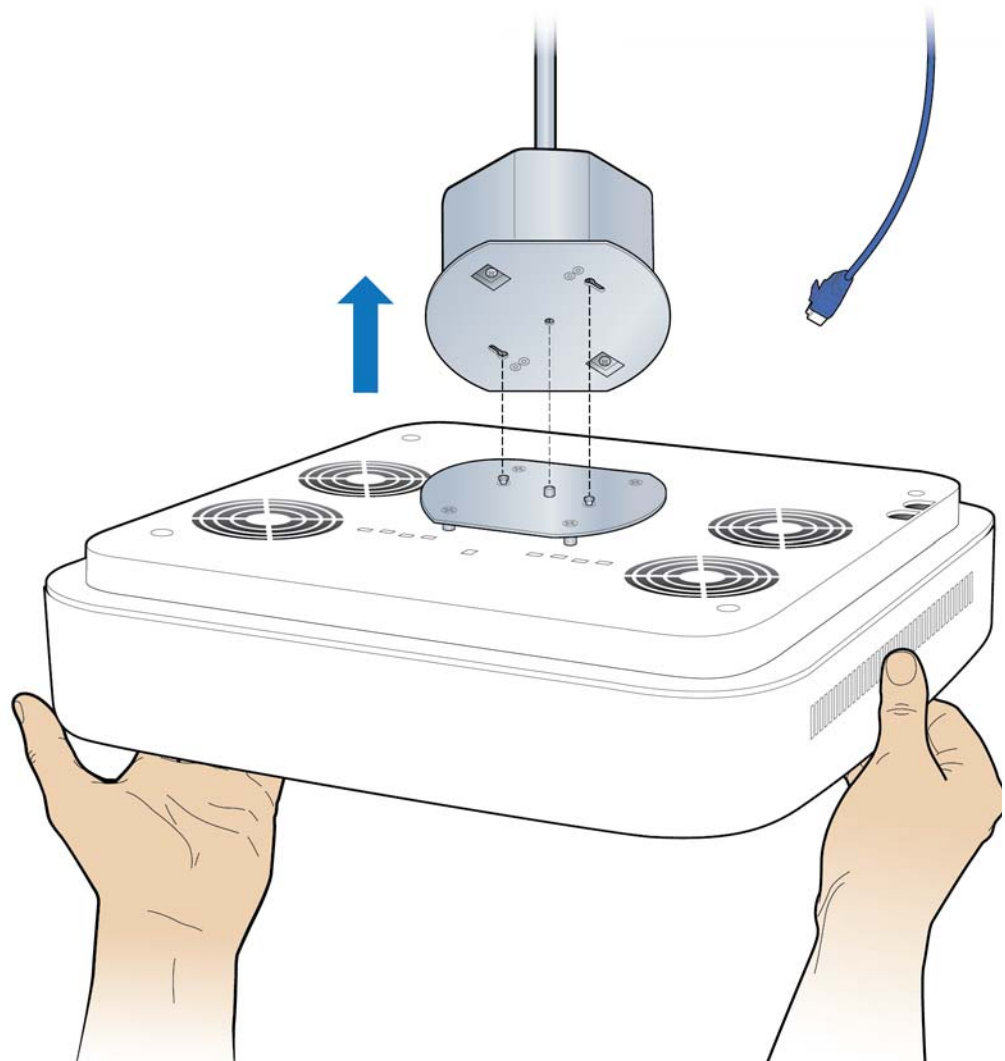



- 7 Twist the RP counterclockwise.

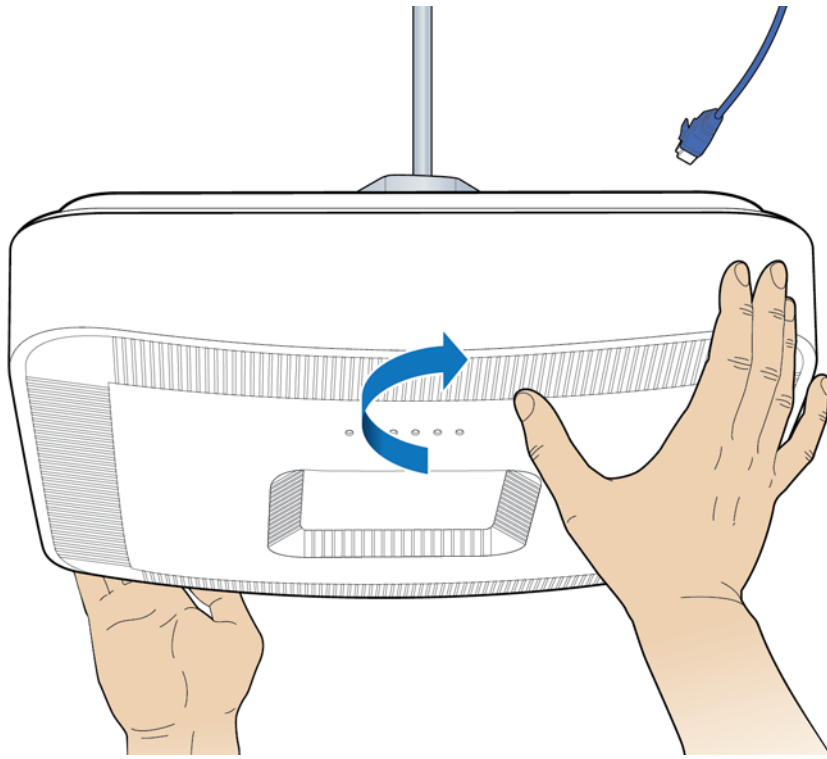

**8** Remove the RP cover.

**NOTE:** The cover is attached to the RP with two lanyards.

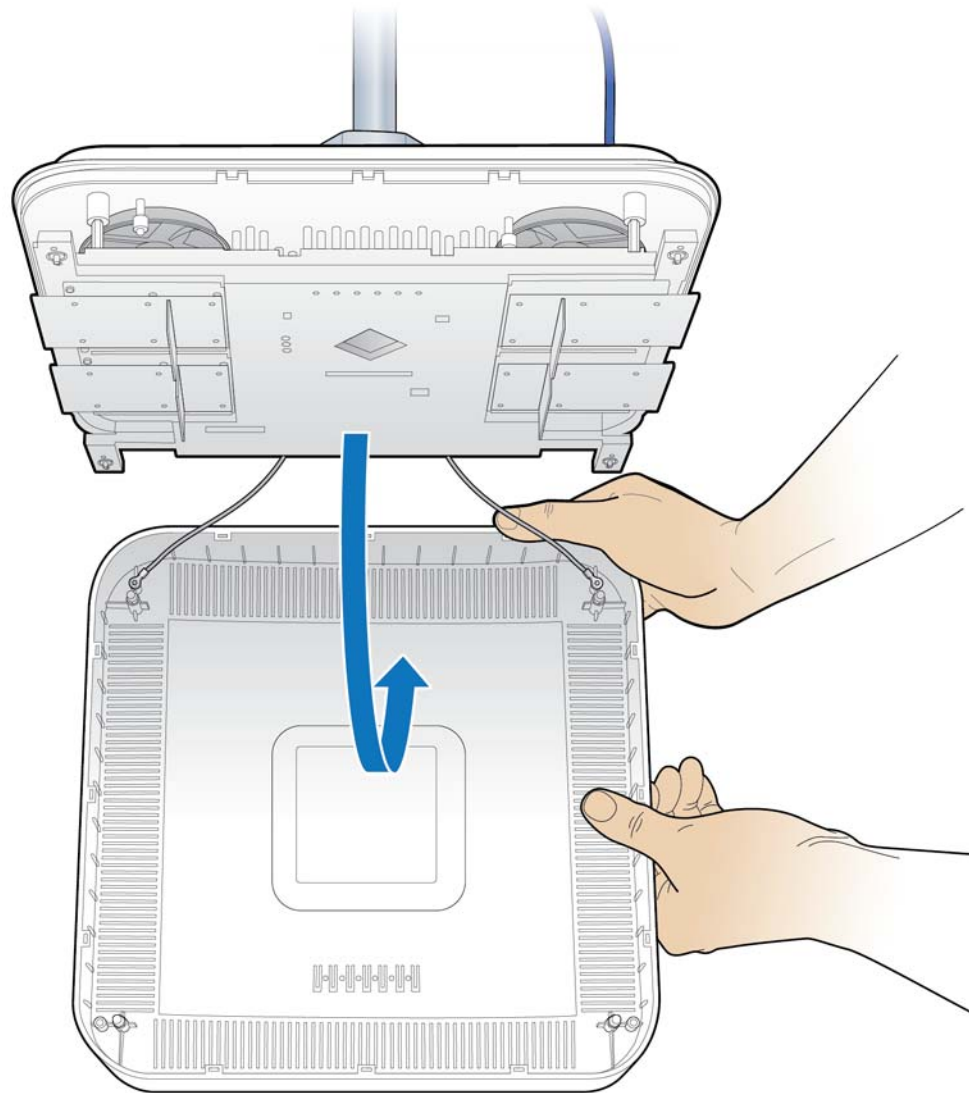

- 9 Connect the Ethernet cable to the MR port.

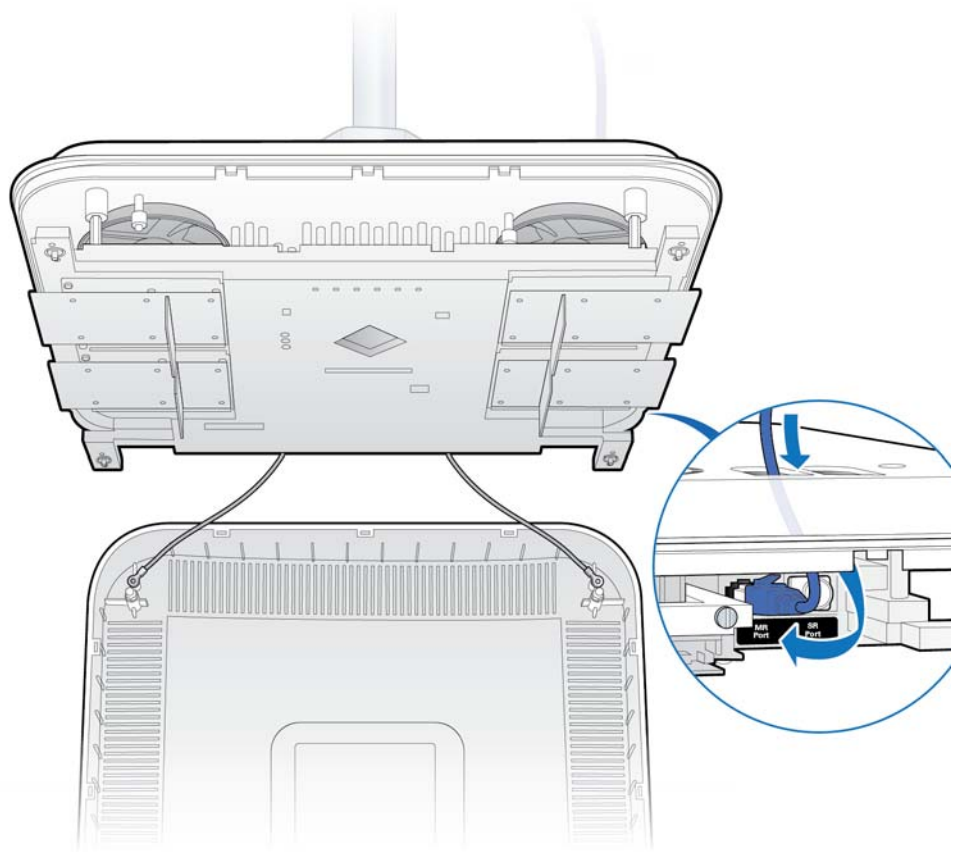

**10** Replace the RP cover.

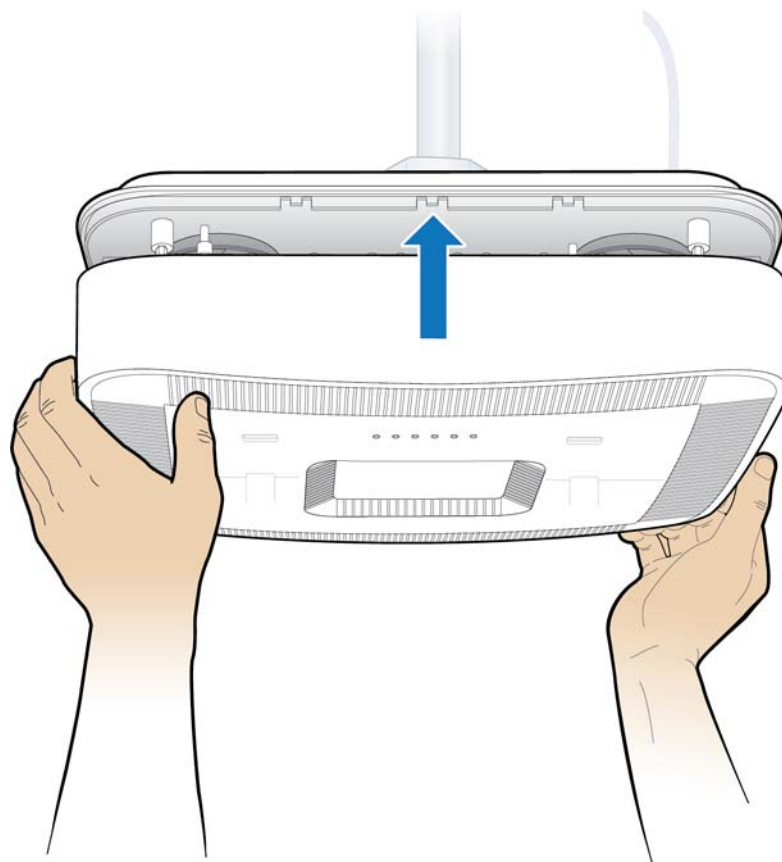

- 11** Verify the RP installation. See The operational state of the RP can be determined by the LED status on the RP. Additional information can be attained from the WebGUI status screens.

For verification procedures, see [RP post-replacement verification](#).

## Replacing a pole mounted Indoor RP

- 1 Remove the RP cover.

**NOTE:** The cover is attached to the RP with two lanyards.

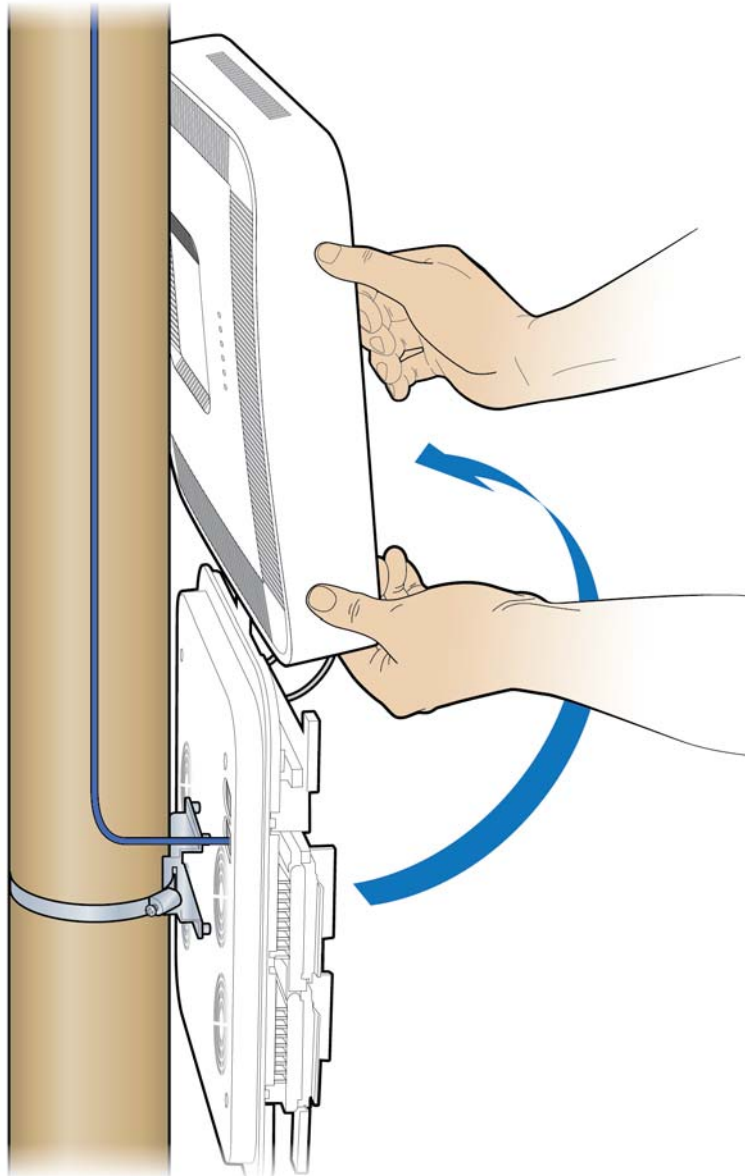

2 Disconnect the Ethernet cable.

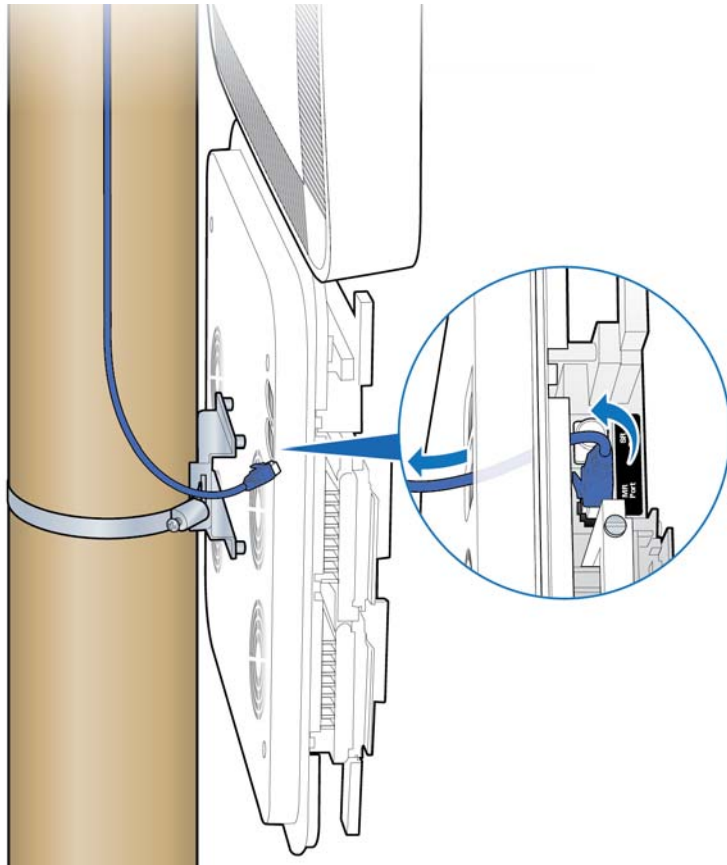

- 3 Loosen the clamp and remove the RP.

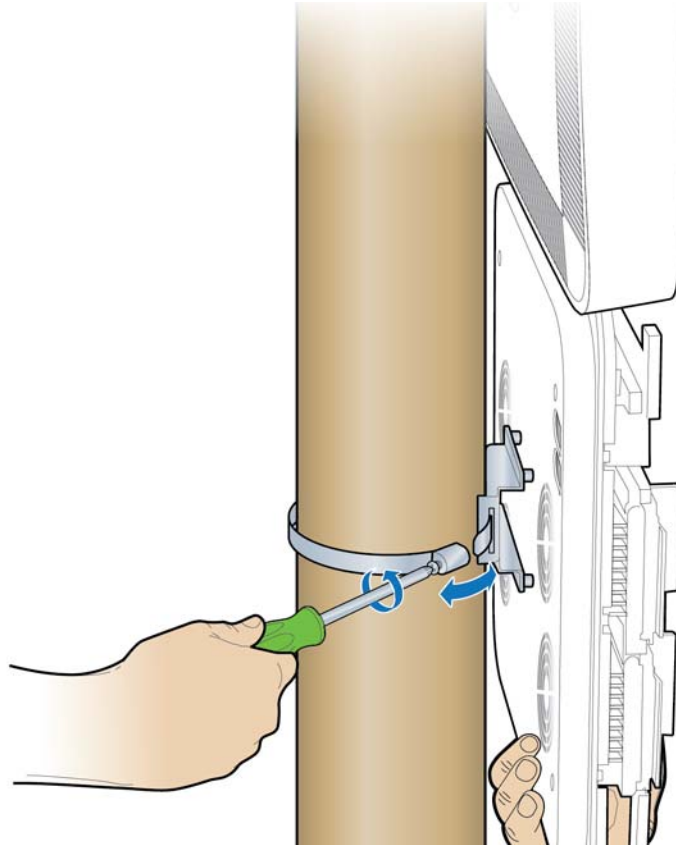

- 4 Attach the bracket to the replacement RP.

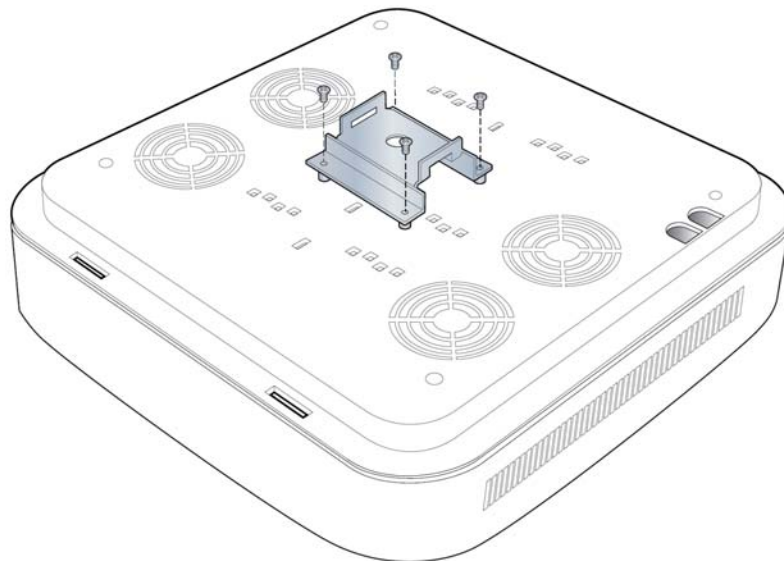

5 Attach the replacement RP to the pole using the clamp.

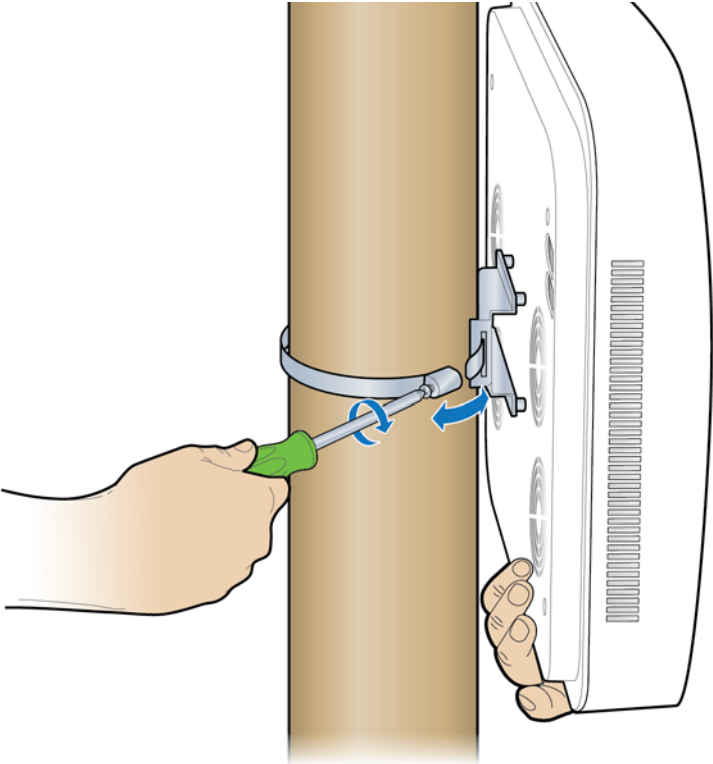



- 6 Remove the cover and connect the Ethernet cable to the RP.

**NOTE:** The cover is attached to the RP with two lanyards.

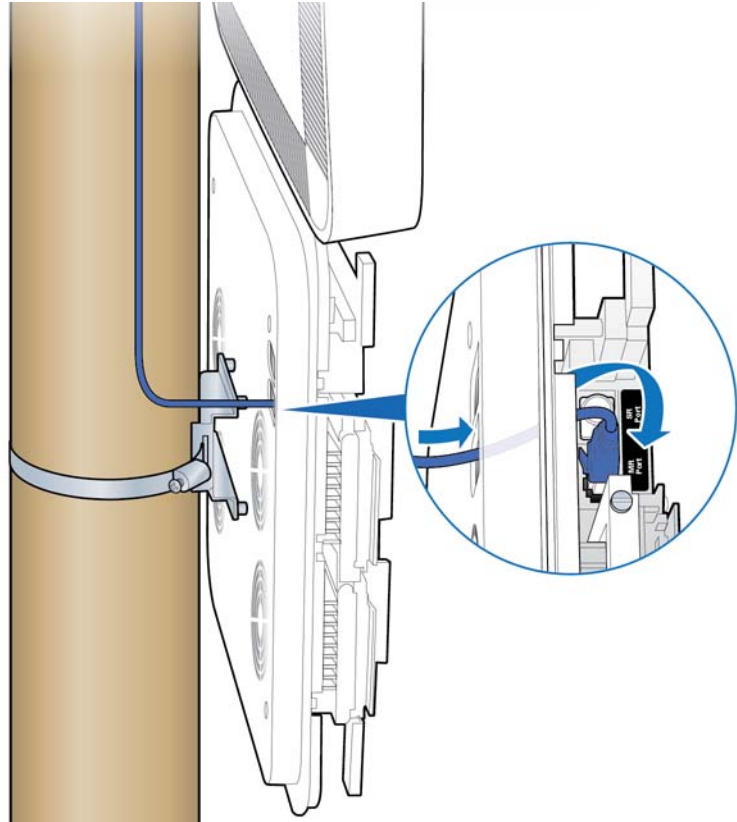

**7** Replace the cover on the RP.

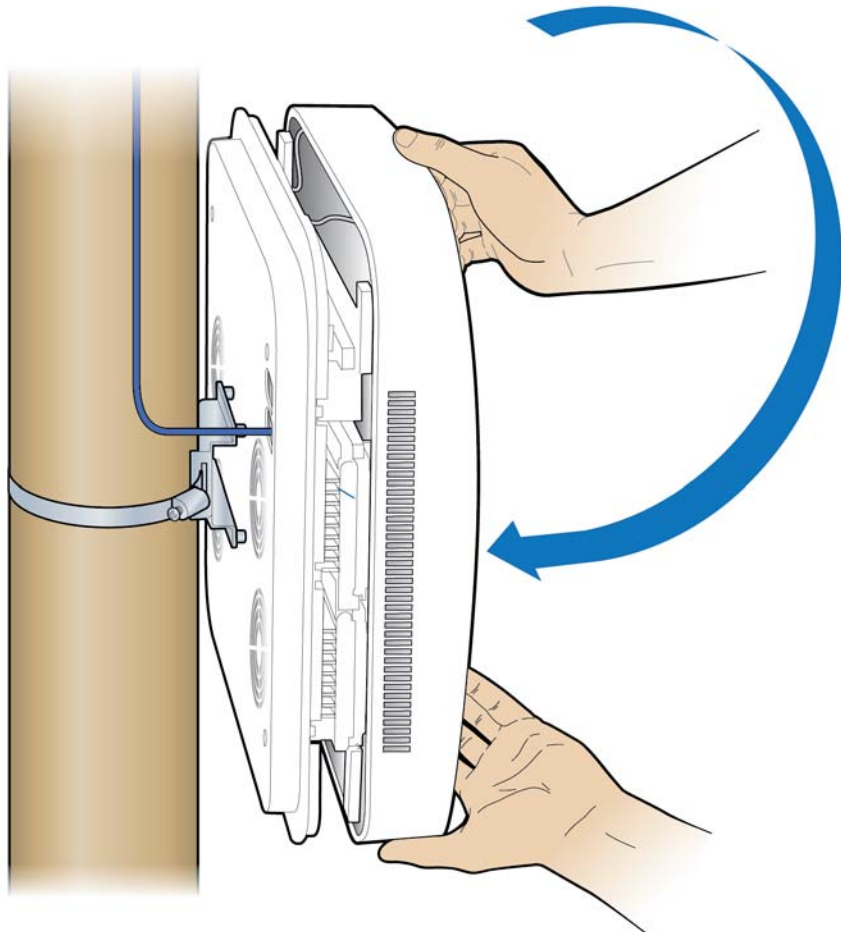

- 8** Verify the RP installation. The operational state of the RP can be determined by the LED status on the RP. Additional information can be attained from the WebGUI status screens.

For verification procedures, see [RP post-replacement verification](#).

## RP post-replacement verification

### On-site

The operational state of the replaced RP can be determined by the LED status on the RP. Additional information can be attained from the WebGUI status screens.

- 1** Connect the Ethernet cable to the MGMT port on the BC's front panel.

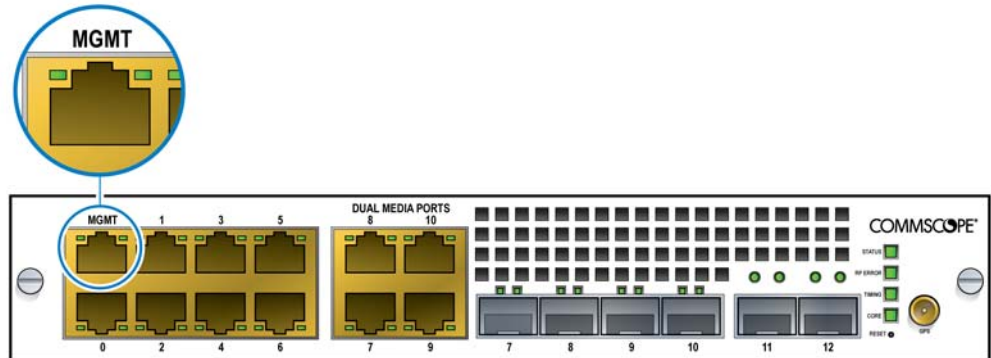

- 2 Open a supported browser.
- 3 Enter the IP address for the GUI, using the format below.

`https://<IP address of Management Interface>:6002`

Example:

`https://192.168.8.1:6002`

The Sign In dialog box appears.

A screenshot of a web-based sign-in dialog box. The title is "Sign in to continue". Below the title are two input fields: "Username" and "Password". At the bottom of the dialog is a blue button labeled "Sign in".

- 4 Ensure the Management Mode tab is selected. The Dashboard displays.

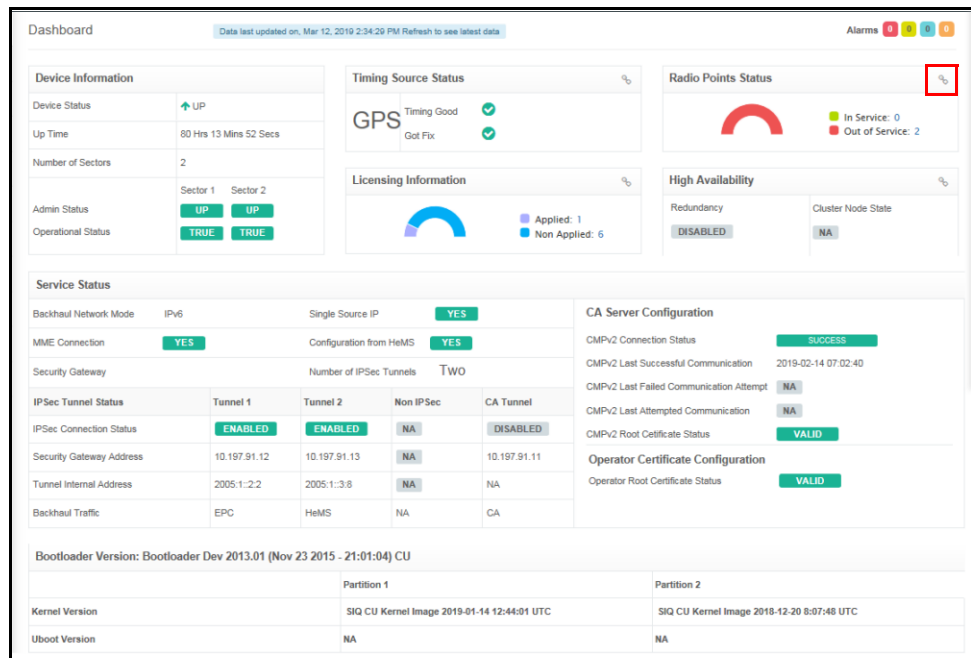

- 5 On the Dashboard, click the Radio Points link. The Radio Points Dashboard displays.



- 6 Click the RP Information tab. The RP Information page displays.

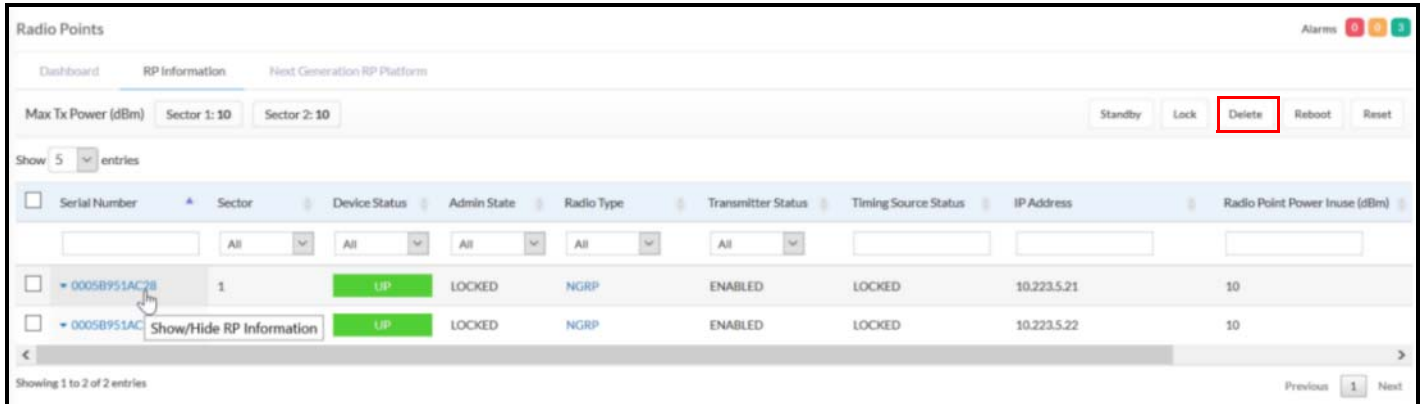

7 Make sure the replaced RP is UP.

## Replacing RF modules

The following procedures provide instructions for replacing a OneCell Radio Point RF module.



**WARNING**

Disconnect the Ethernet cable(s) on the RP to remove the power. Failure to do so will cause damage the RP.

1 Remove the RP cover.

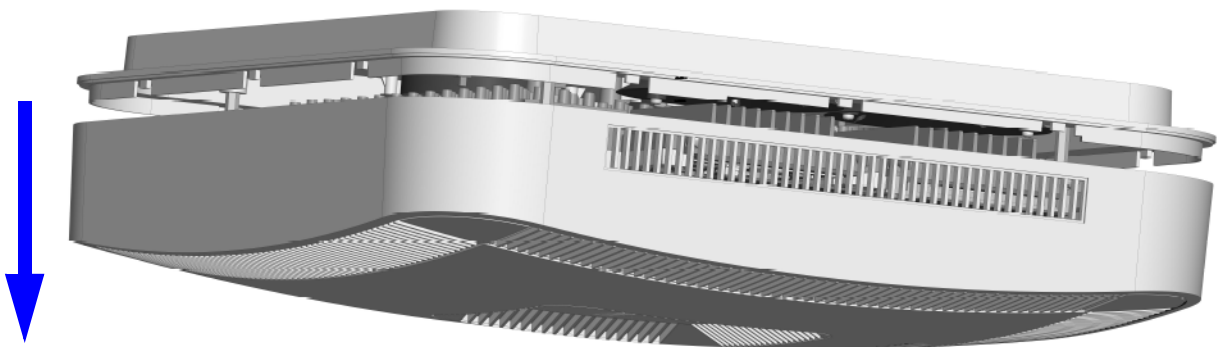

- 2 Disconnect the Ethernet cable on the RP.

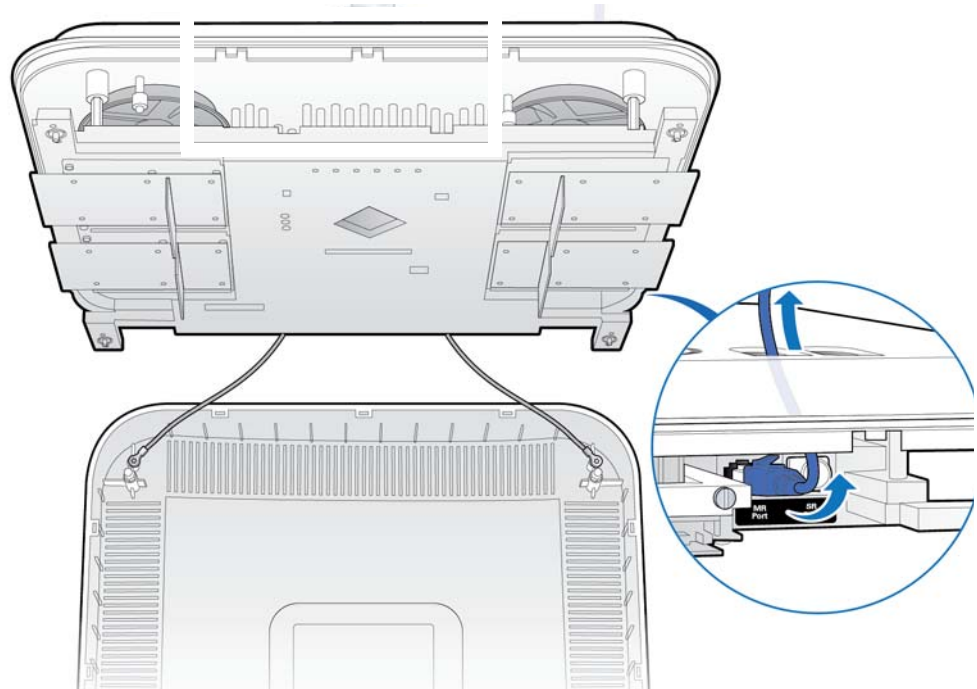

- 3 Unscrew the RF module.

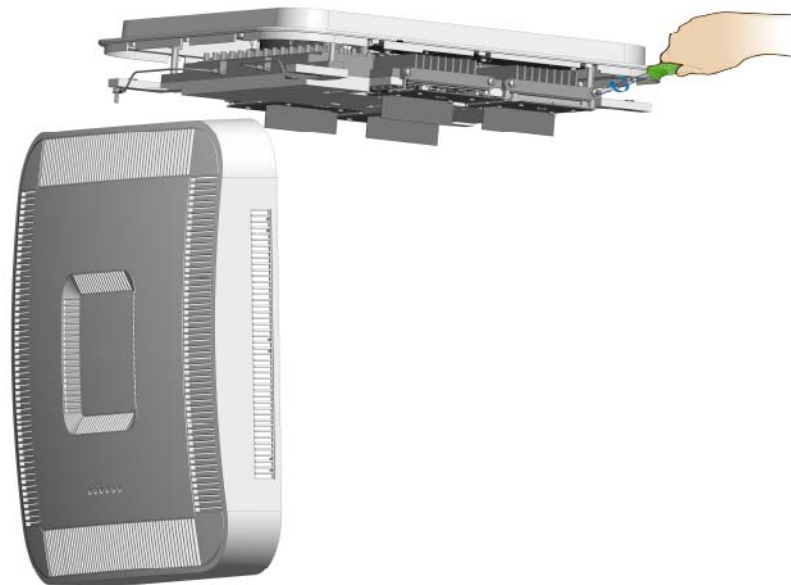

- 4 Remove the RF module.

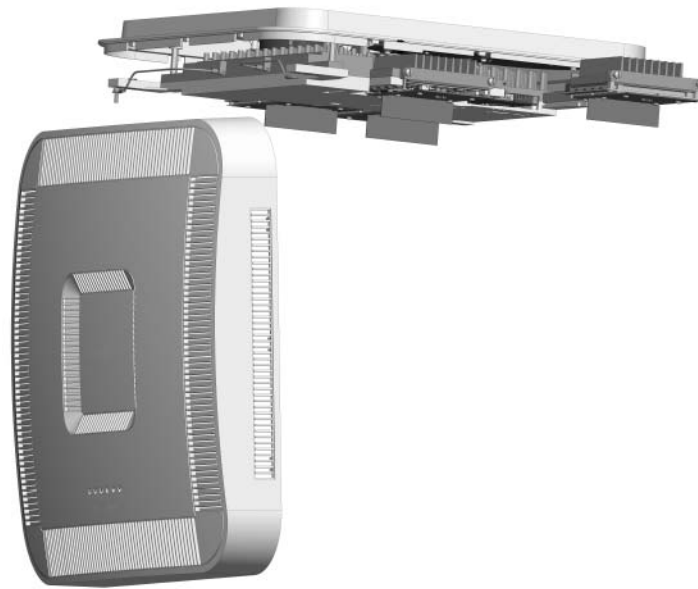

- 5 Install the replacement RF module.
- 6 Secure it in the slot.

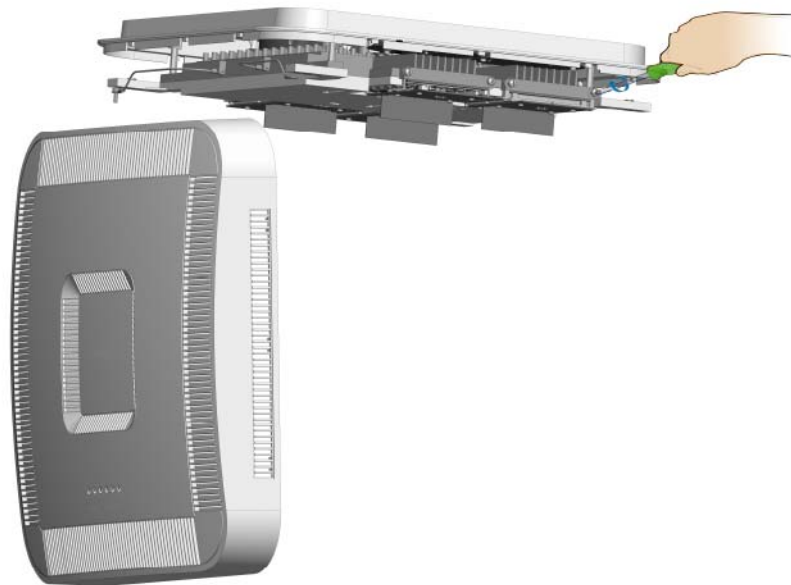

7 Connect the Ethernet cable.

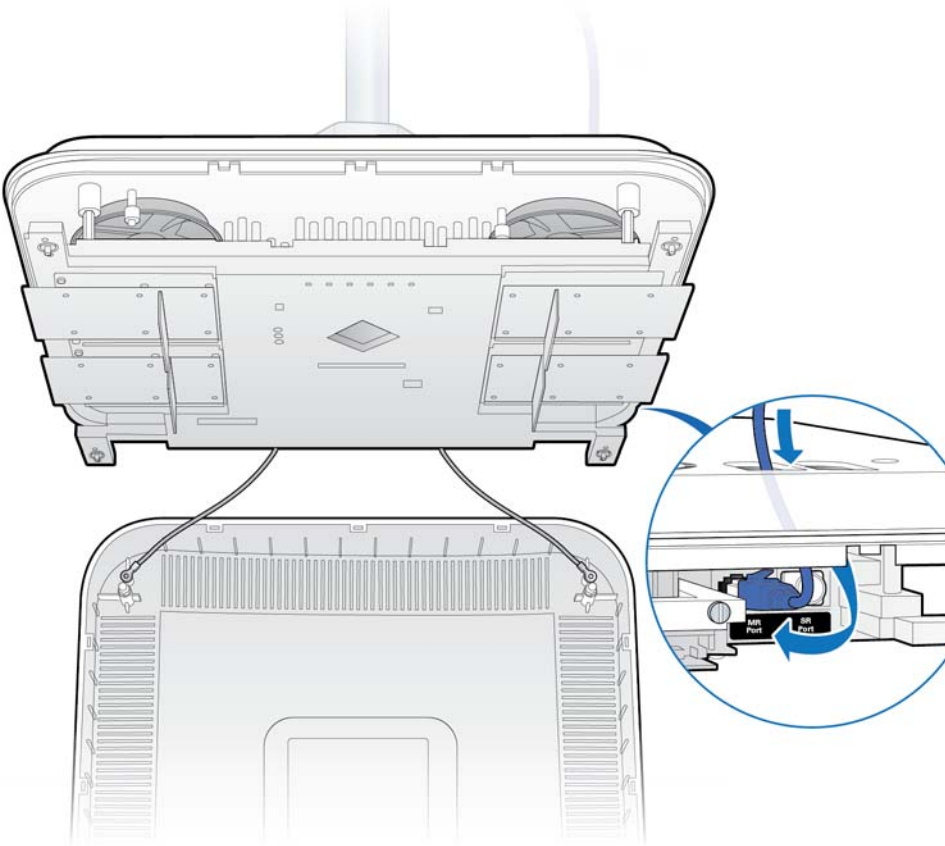



- 8 Attach the RP cover.

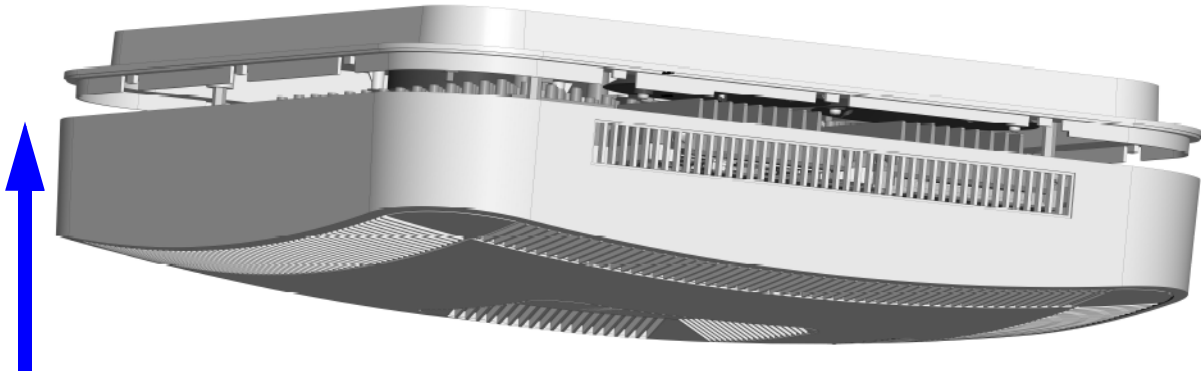

- 9 Verify the RF module installation. The operational state of the RF module can be determined by the LED status on the RP. Additional information can be attained from the WebGUI status screens.

For verification procedures, see [RP post-replacement verification](#).



## Cable installation and power separation guidelines

This section contains best practices for installing Ethernet cables and connecting them to RPs.

Overview	E-2
Cable handling	E-2
Cable termination	E-3
Lightning protection	E-12
Ceiling connector	E-15
Patch panel	E-17
Power separation guidelines	E-17

## Overview

When installing Ruggedized RPs, cables that can withstand temperature extremes and inclement weather should be used. In outside environments, avoid contamination or damage to plugs. Plugs must be protected from sunlight and water in a suitable equipment housing or NEMA 4 rated box. It is also important to avoid exposure to water at cut ends of unfilled cables and cords. The following information is available to help you extend the operation of your RP and switches.

## Cable handling

Indoor/outdoor cords can be routed outdoors above ground and indoors, and can be ordered in lengths long enough for direct (home-run) installations from switch to end equipment. Cords have 20% Insertion Loss De-rating so only 85 meters total can be supported. Extended lengths can be cut in two for terminating the indoor ends at protectors or panels. Terminations are similar to typical 4-pair indoor cables.

Unreel long lengths of cable to ensure the cable does not become twisted or caught on objects.

**Figure E-1. Unreel cable**

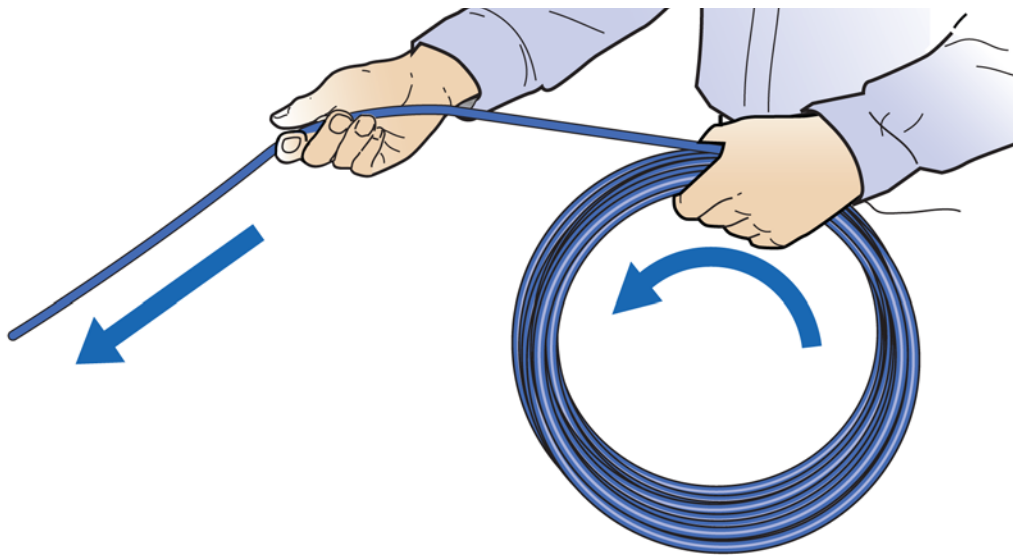

CommScope recommends using a sock fitted and secured over the plug to pull cable through long conduits.

[Sock information](#)

[Tie wrap information](#)

Figure E-2. Cable with sock attached using tie wrap

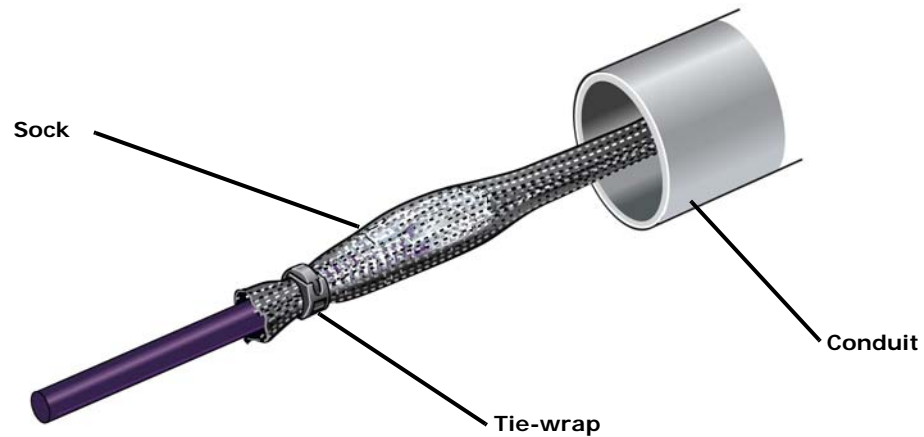

Feed the sock through the conduit and secure the sock on the terminal end of the cable with the tie-wrap. Once the sock and tie-wrap are in place, pull the cable through the conduit.

## Cable termination

Before installing the Ruggedized RP, terminate the RP end of the Ethernet cable with the RJ45, IP67 connector provided in the box.

Figure E-3. RJ45, IP67 connector

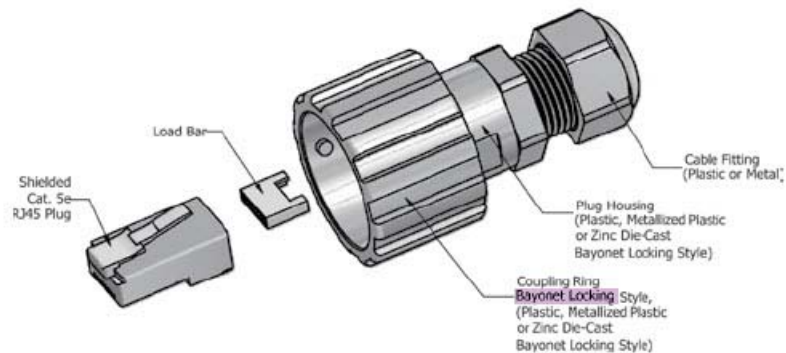

Flip the plug anti-snap to make it easier to push through the cord grips (flip it back before plugging in).

Use the split grommet provided. Once it is in place, coat it with silicone to ensure the connector is sealed.

**Figure E-4. Assembling the connector on the RP end**

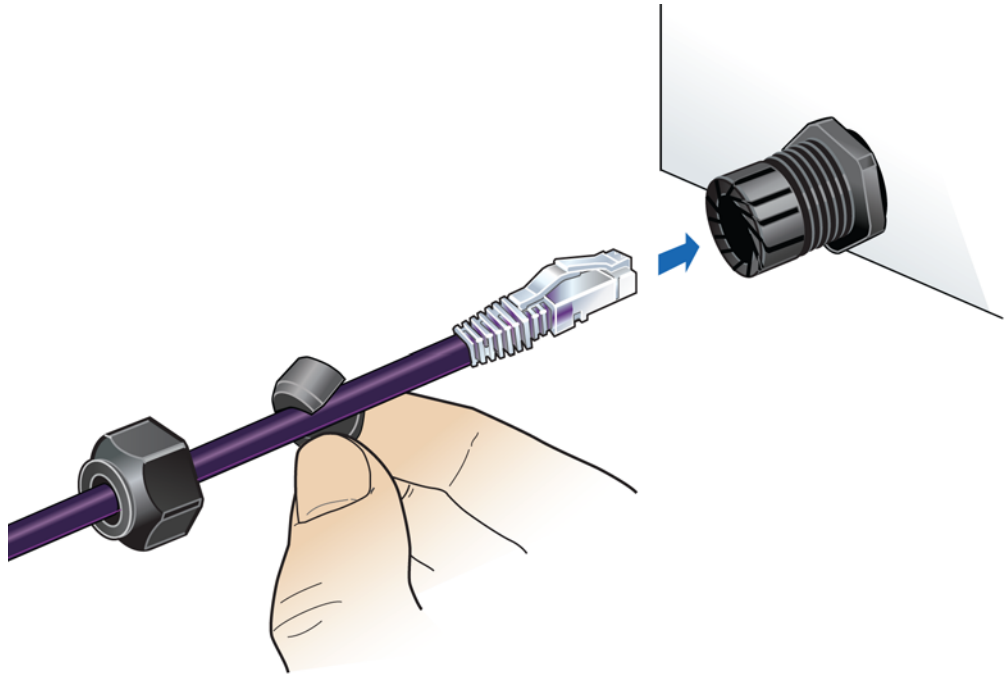

### Cable splicing

Some cables are run in one piece from source to destination and have connector terminations. In other cases, two shorter pieces of cable need to be spliced together. When a cable is run to outdoor devices, you should take measures to ensure that cables are properly protected against moisture entering the cable. This is especially important when the jacket is stripped back from the wires.

Some cables are gel filled and the termination includes cleaning the excess gel and blocking the end with silicone sealant to prevent future leakage. A typical blocking method uses a 2 cm length of [Alpha Wire PVC-105-2](#) tubing or equivalent.

- 1 Fill all space inside the tubing with B-sealant.

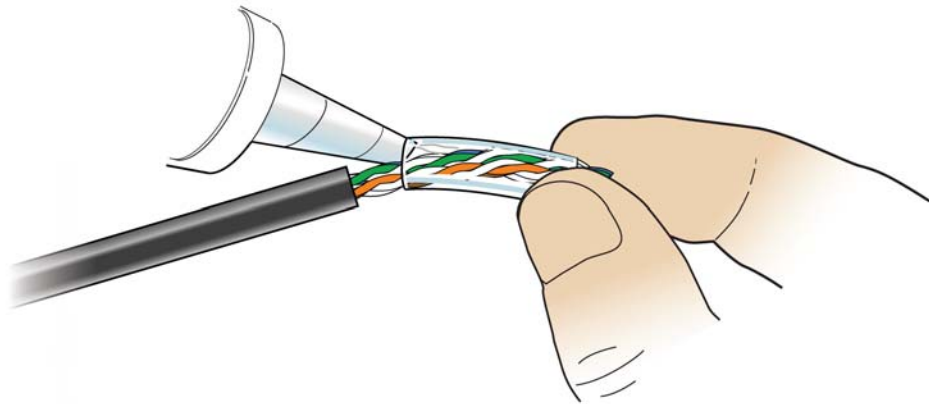

- 2 Position the filled tube to overlap the end of the inner jacket and seal the gel. Clean off all excess sealant.

**NOTE:** Tape can be used to stabilize the tube for immediate termination before the sealant sets.

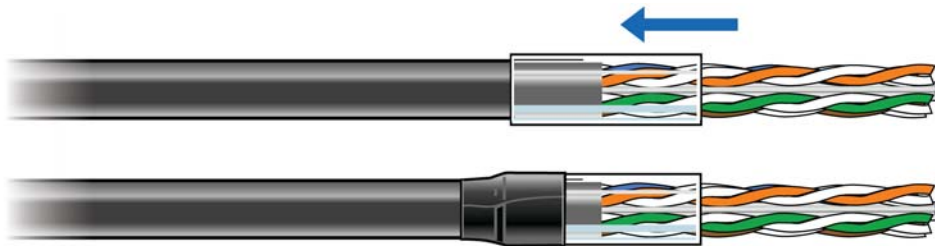

### Cable termination

Shielded cables must be properly terminated, either grounded or isolated. For exposed installations requiring protection, the end of the shield can be bonded in various ways. The following procedure is an example of one method.

- 1 Make a slit along the length of the jacket. Be careful not to tear the underlying shielding.

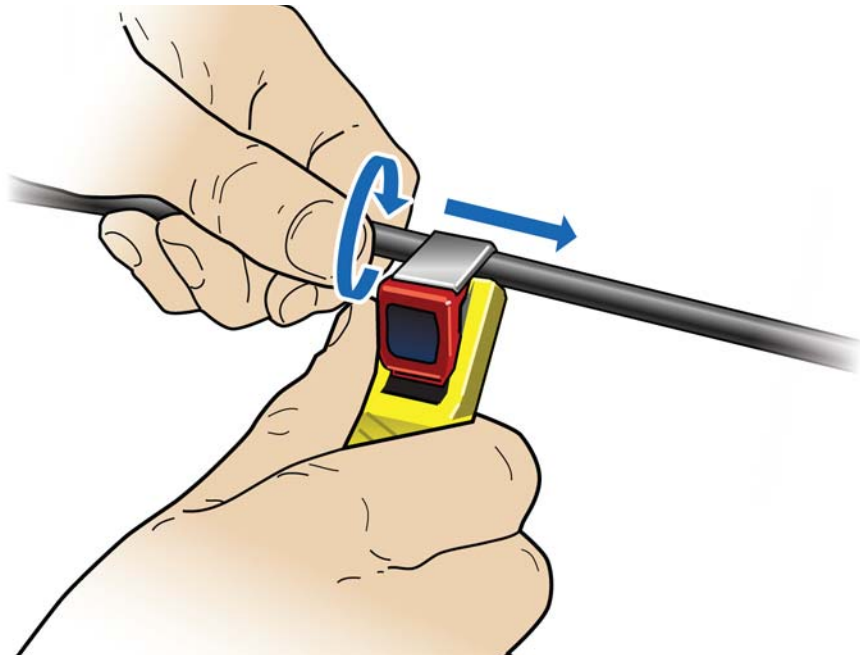

- 2 Pull back the jacket along the slit and remove.

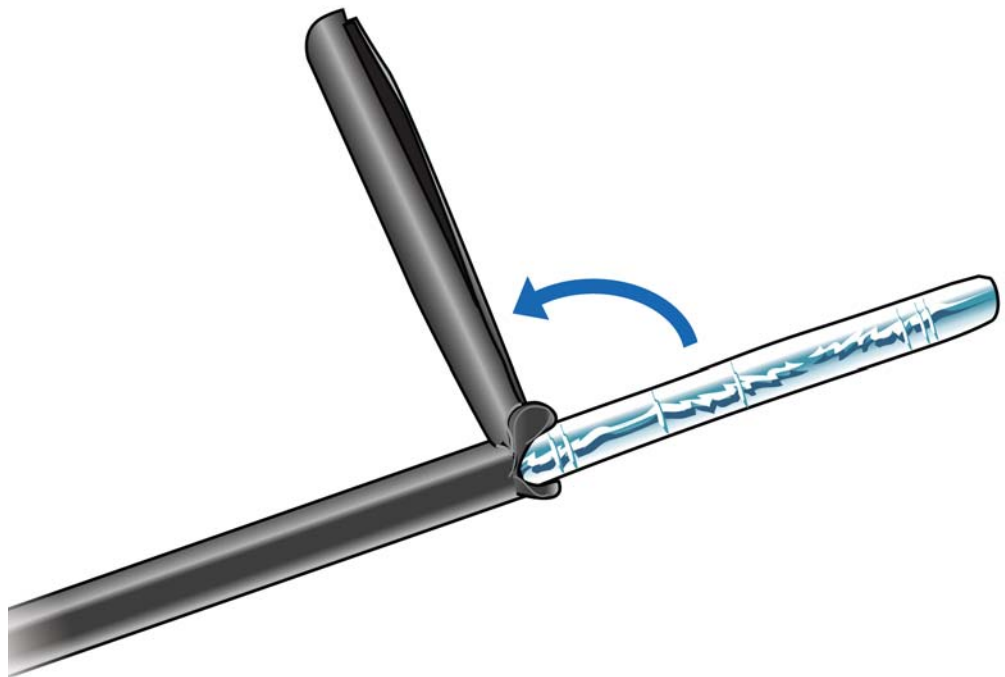



- 3 Fold back the foil shielding and drain wire to expose the inner jacket.

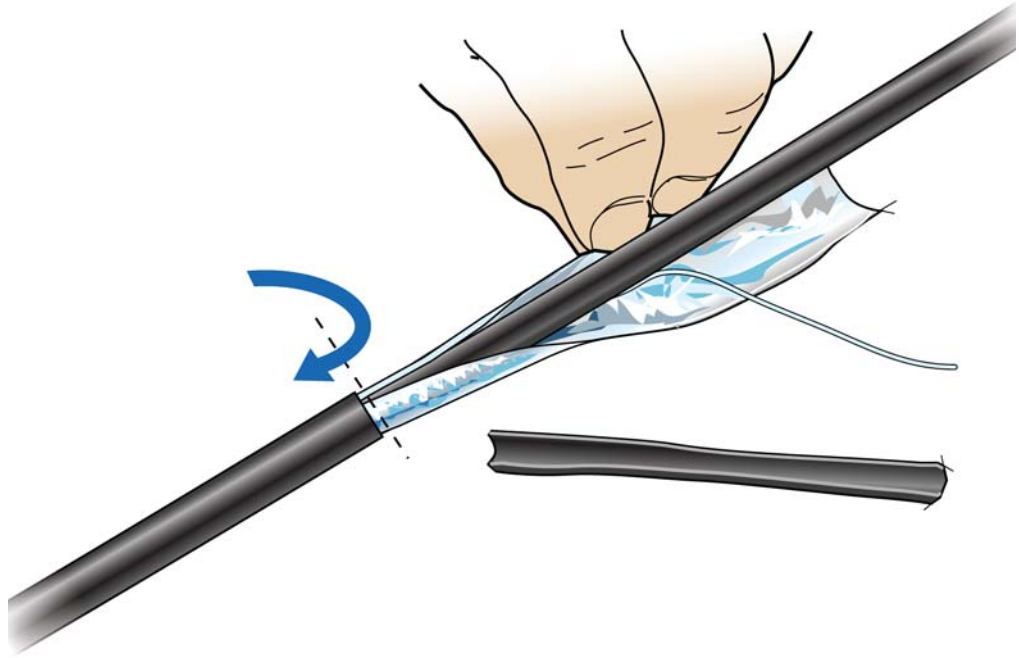

- 4 Prepare the inner jacket for blocking the gel and direct burial.

- a Cut back the inner jacket
- b Trim the flute
- c Clean the excess gel

**NOTE:** The flute can be cut longer to match the blocking tube length.

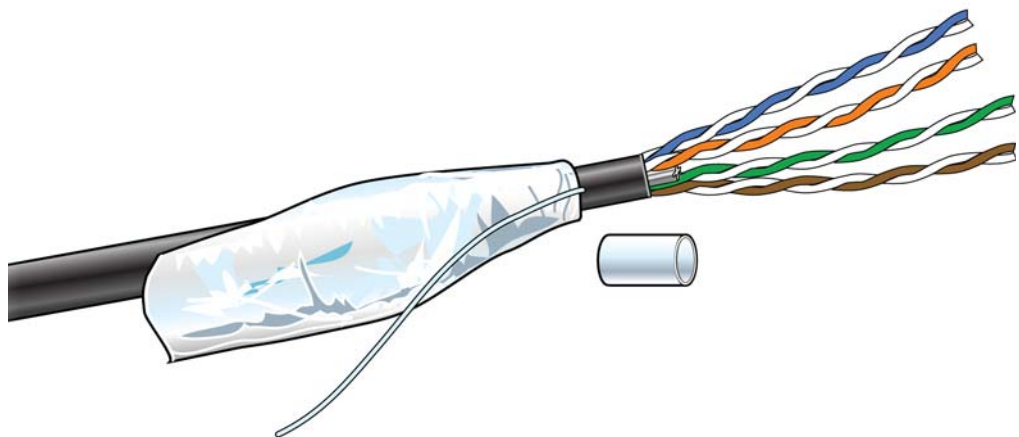

- 5 Fill all space inside the tubing with B-sealant and position the filled tube to overlap the end of the inner jacket and seal the gel.

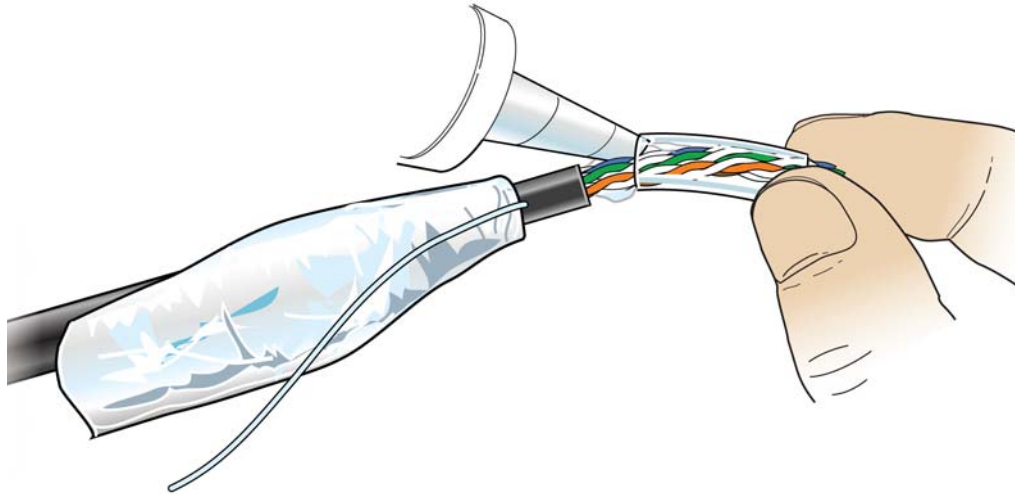

- 6 Fold the drain wire and foil back over the tube and position the foil to be folded back over the tube.

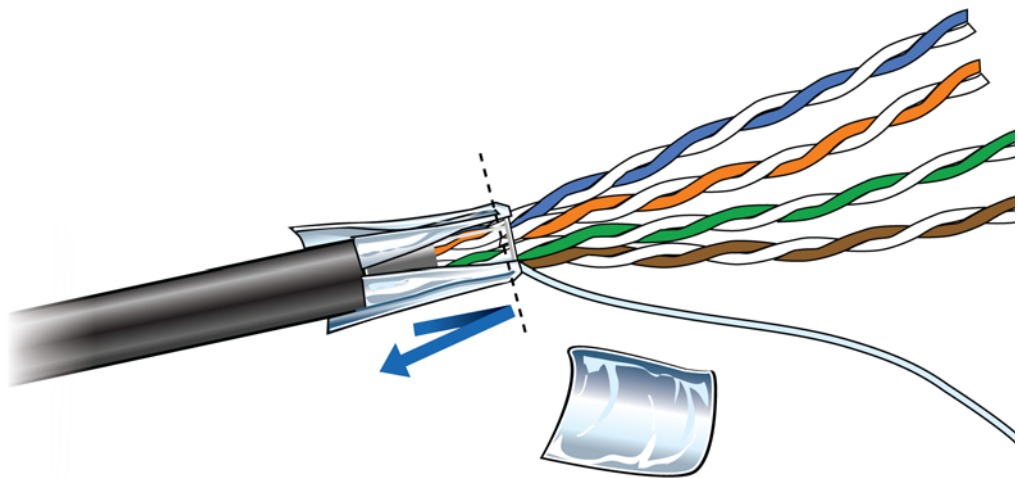

- 7 An extra piece of foil can be used to cover the foil seam.

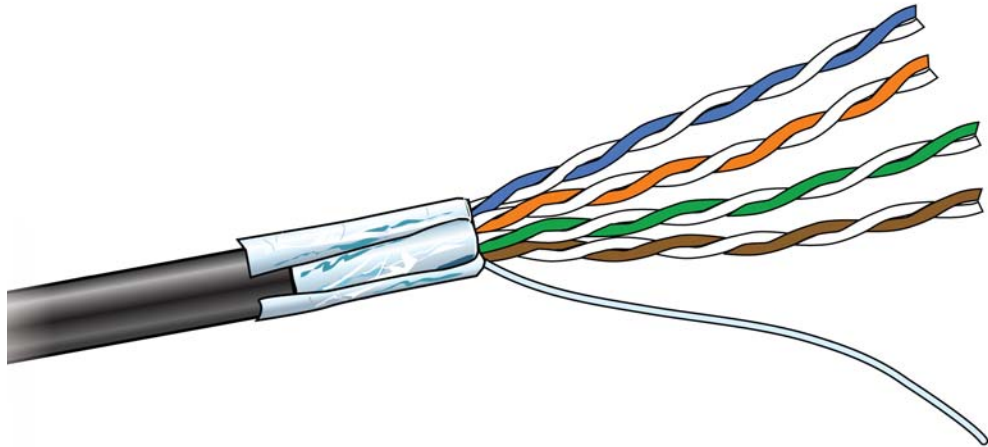

- 8 For an HGS620 termination, wrap the drain wire at least two times around and position it where the spring clips will capture them.

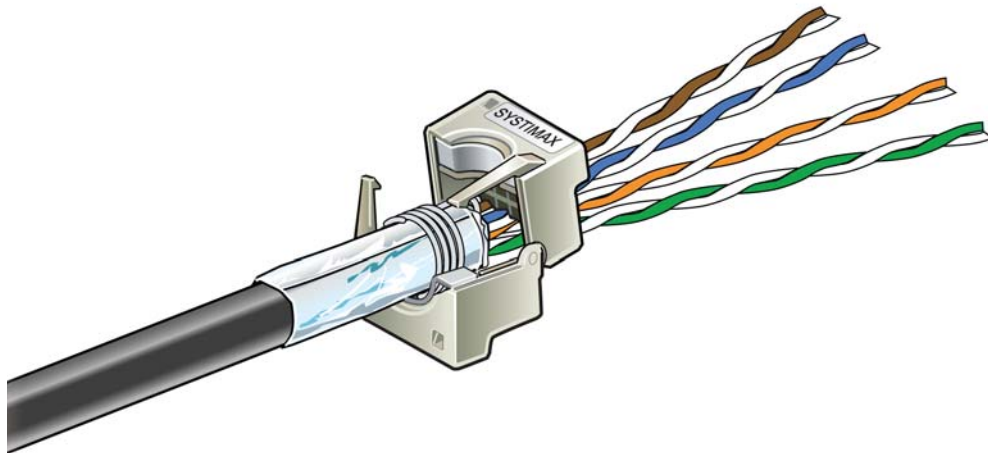

- 9 Tape over the foil for stability.  
10 Trim the wire ends.



### Cable grounding

For CAT-6A cables, the shield termination method is to use the ground lug and B-bond clip that are available in the 12A1 Grounding Kit.

- 1 Fold the foil back over the jacket end and wrap the drain wire around the end and push the ground lug over the wrap.

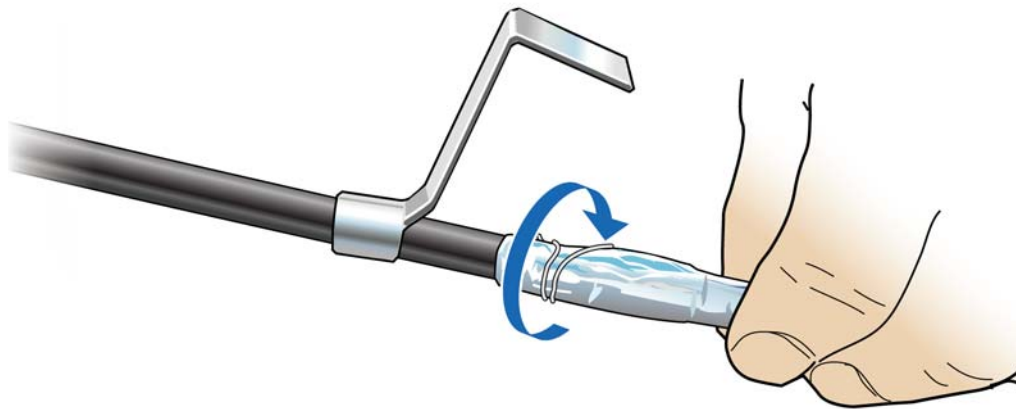

- 2 Open the B-bonding clip to be placed and closed over the grounding lug.

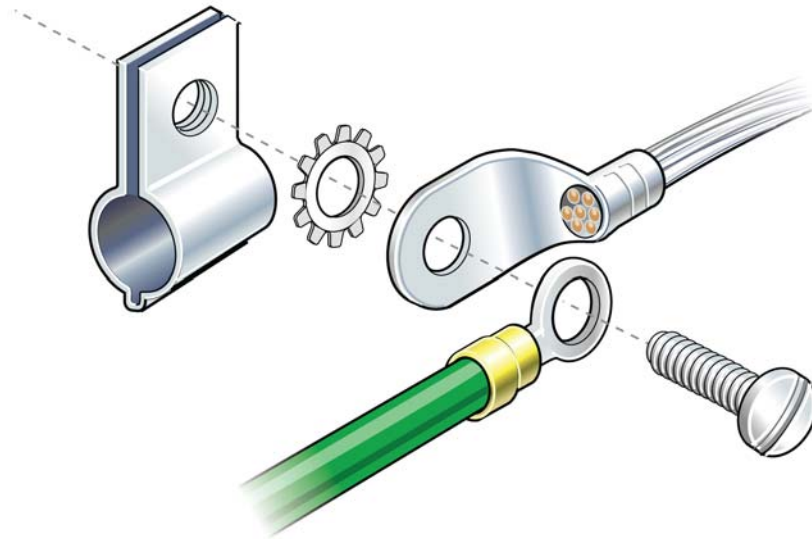

- 3 The lug tail can be cut off or used for ground attachment.

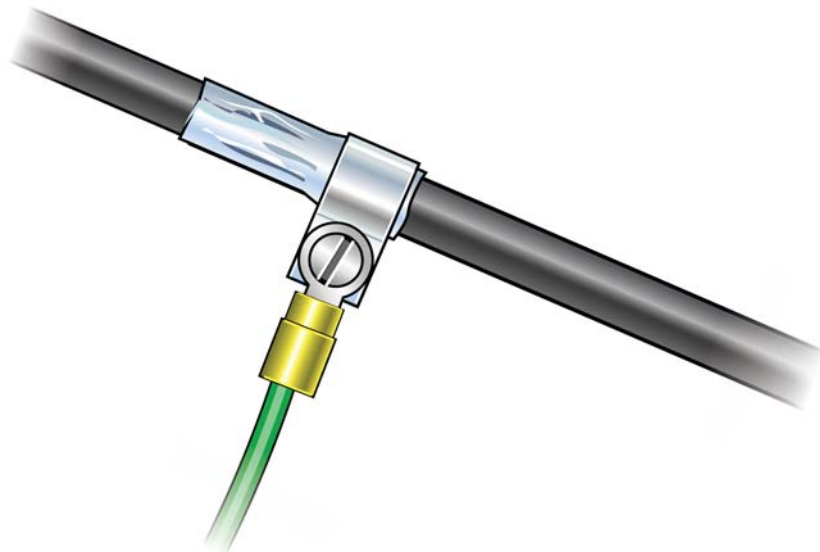

- 4 Treat the inner jacket as described in [step 4 on page E-7](#).

For an isolated shield termination, the 1572A and 1592A outer jacket foil and drain wire are removed a short distance back from the termination and electrical tape is used to isolate the foil end.

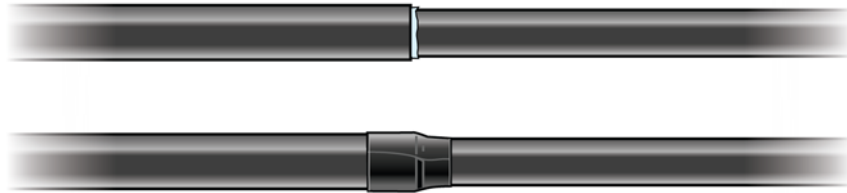

## Lightning protection

CommScope recommends including lightning protection in your OneCell system to isolate equipment from surge damage.

### Important guidelines

- Verify hole diameter – blocking may need to remain outside the cover
- Maintain pair twists up to termination points
- Avoid having pairs crossing over each other

### Indoor box

To protect the cables in an indoor installation from lightning damage, CommScope recommends using the [ITW Linx CAT6-A-LAN](#) protector.



NOTE

The gel filled outdoor cable types will still need blocking. See [Cable splicing](#) and [Cable termination](#) for instructions on blocking cable.

Figure E-5. CAT6-A lightning protector

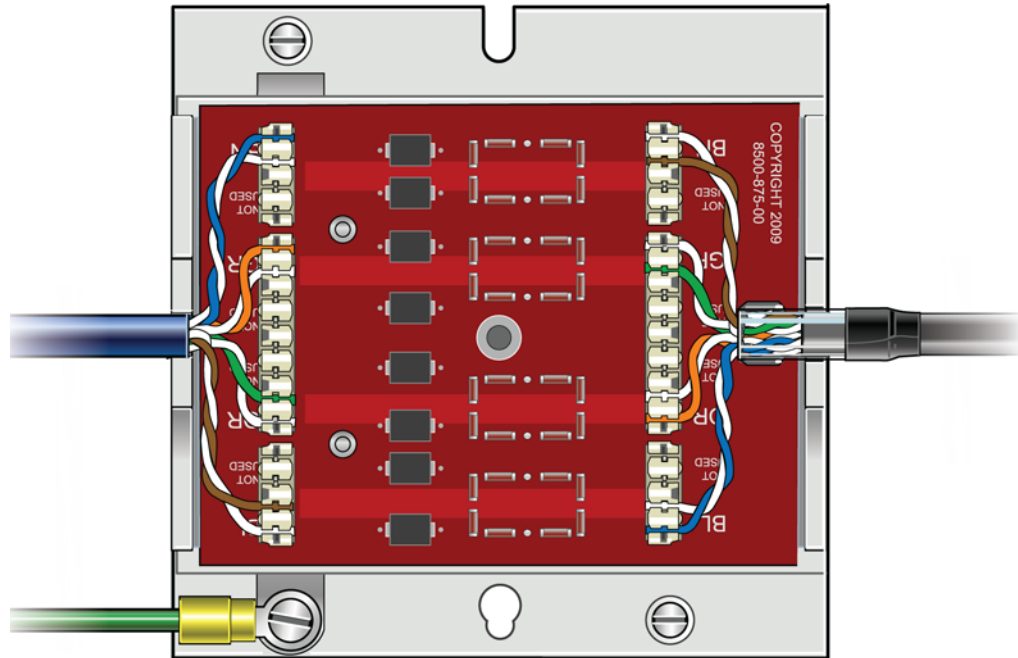

## Outdoor protection

The following is an example of a pole mounted CAT-6A configuration for protecting remote equipment installed outdoors.

Table E-1 lists the recommended parts for installing the protection equipment.

Table E-1. CAT-6A protection equipment parts list

Part Name	Link to Part on Distributor's Web site
NEMA 4x enclosure	<a href="#">Allied Moulded fiberglass enclosure</a>
Back panel	<a href="#">Allied Moulded back panel</a>
Ground buss	<a href="#">Ditek surge protection buss</a>
Bottom Mounted Liquid Tight Cordgrips	<a href="#">Heyco pre-assembled cordgrips</a>
Bottom Mounted Liquid Tight Bushing	<a href="#">Heyco liquid tight bushings – snap-in</a>
Protector	<a href="#">Ditek 110RJC6APOE Protector</a>
Pole mount kit	<a href="#">Allied Moulded pole mount kit</a>

Figure E-6. Remote equipment protection for outdoor devices

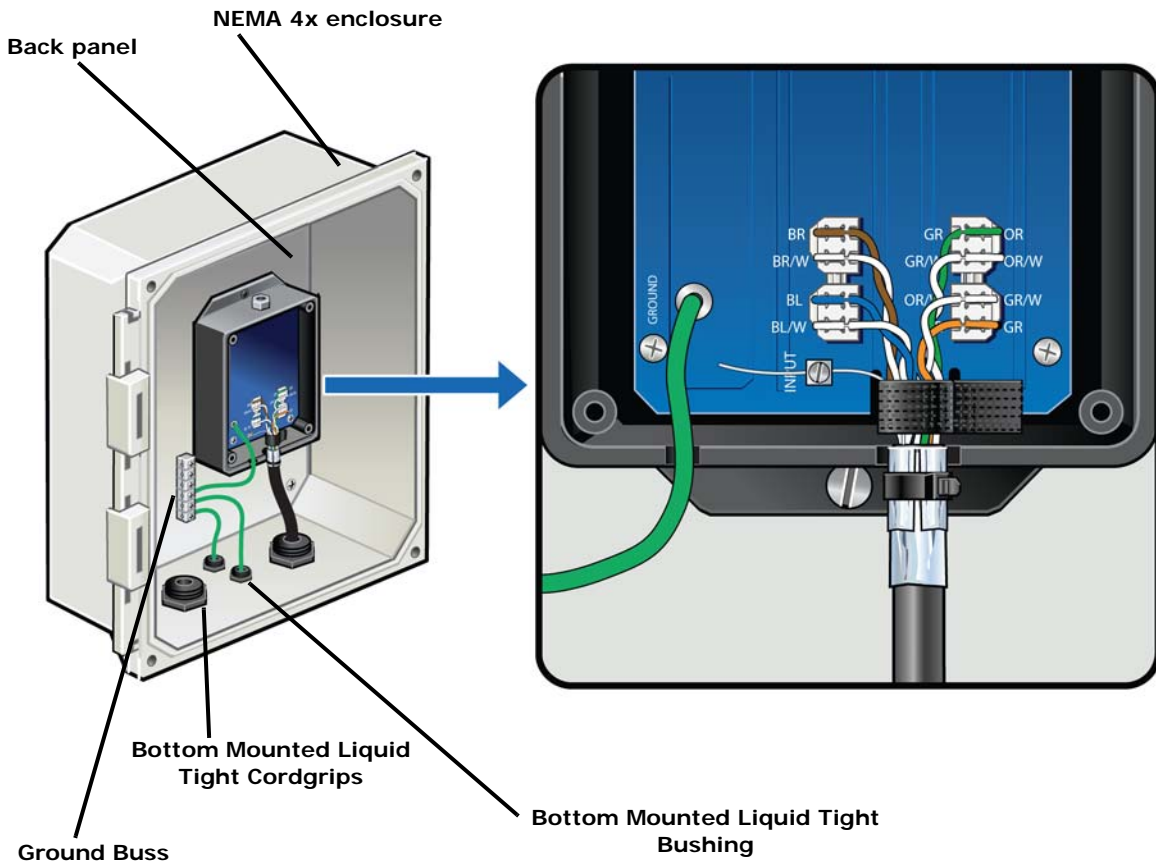

NOTE

Enclosure should be mounted close to the equipment for the best protection.



Figure E-7. Protector box mounted to pole

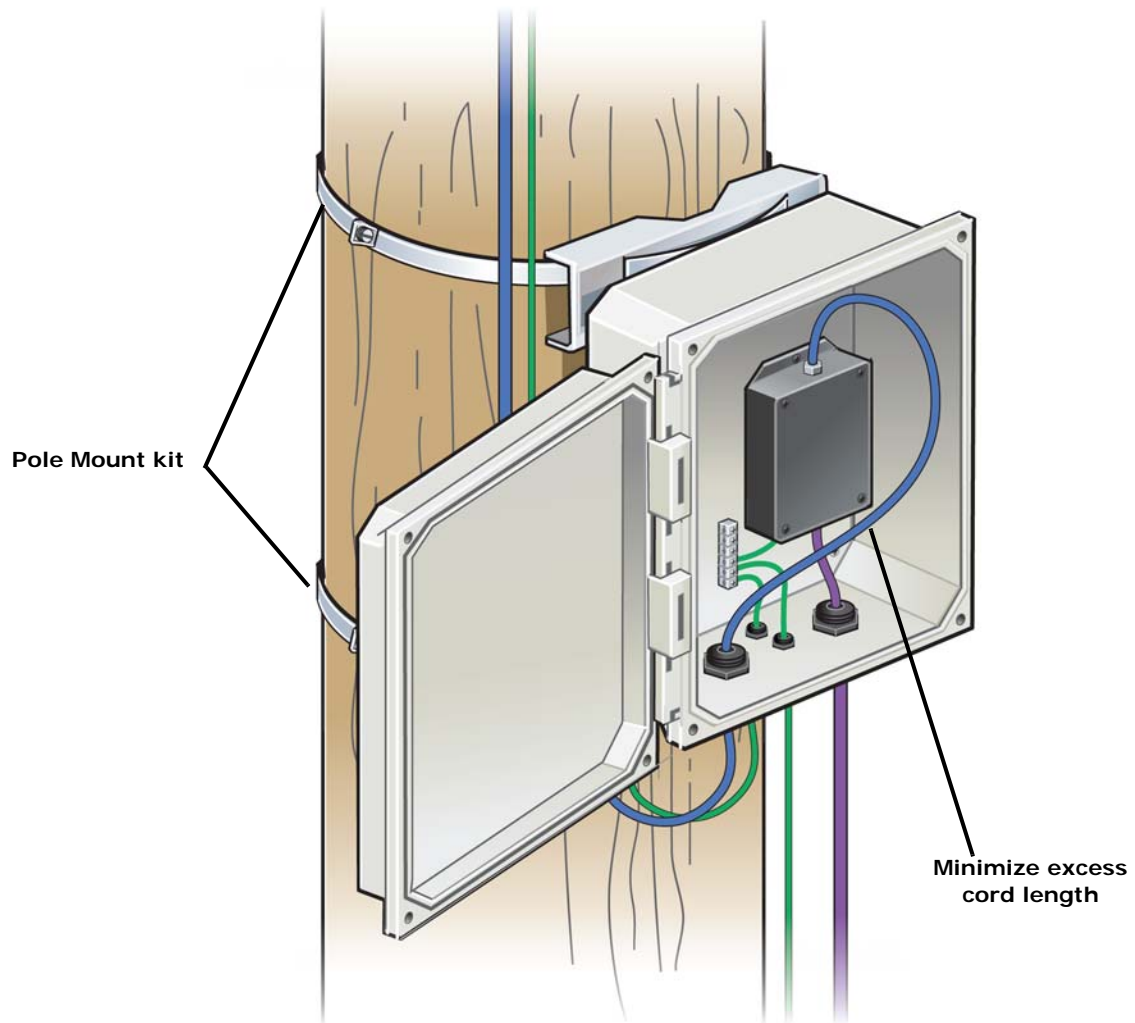

## Ceiling connector

If surge protection is not needed, gel flooded cables can be blocked and transitioned to indoor cable using a ceiling connector. The following link is for the recommended CommScope part.

[Ceiling connector](#)

- 1 Terminate the indoor cable first – then lay down a bed of B sealant.

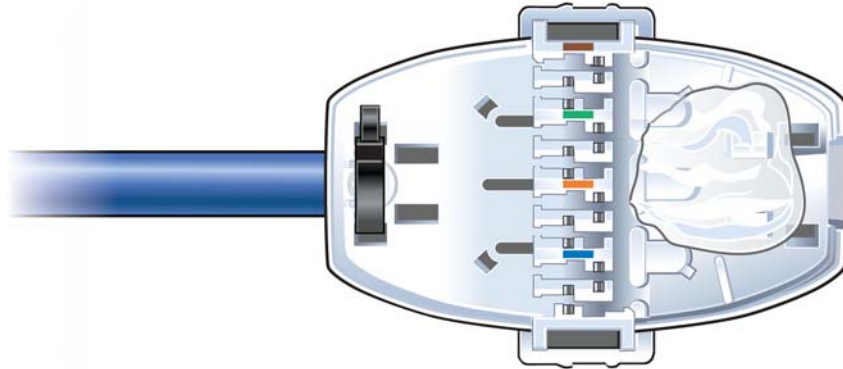

- 2 Clean all gel from the end of the OSP cable.

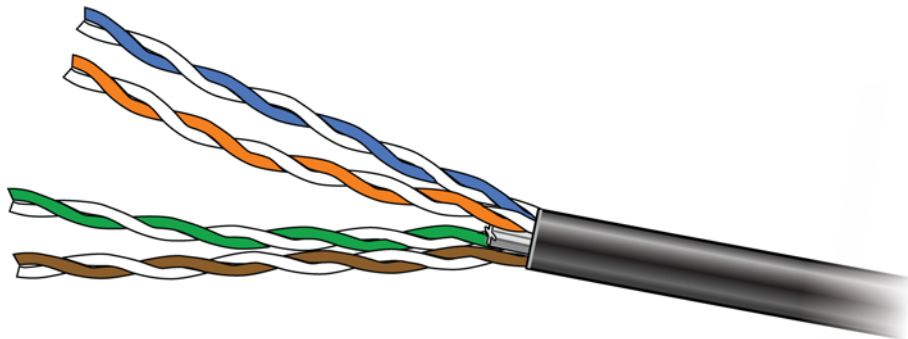

- 3 After the cable and conductors are positioned, fill the area around the cable end with sealant and close the connector housing.

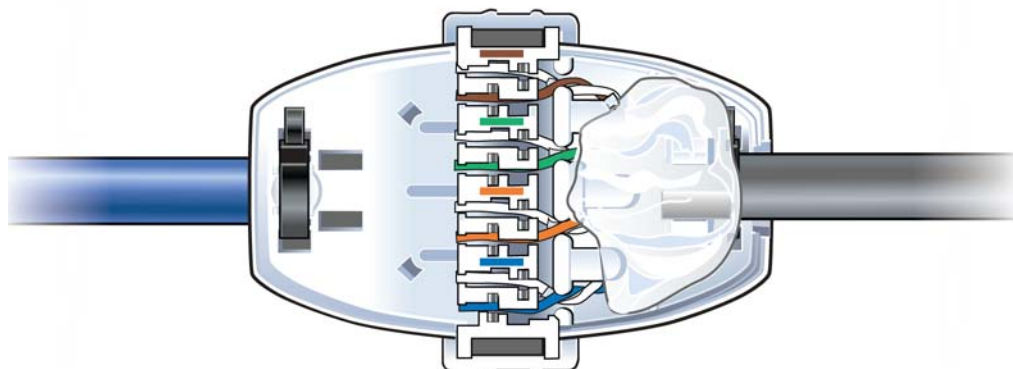

## Patch panel

CommScope recommends installing a patch panel in the NOC to connect and manage CAT-6A cables. The following is a list of recommended CommScope 24 and 48 port patch panels and high density information outlets.

- [760163436 HFTP-HD6B-1U-24](#)
- [760163444 HFTP-HD6B-2U-48](#)
- 760163451\_HFTP-HD6B-1U-24
- 760163469\_HFTP-HD6B-2U-48
- [760163519 HFTP-J6](#)
- 760163527\_HFTP-J10G

For more information, go to [CommScope.com](http://CommScope.com) or contact your CommScope customer representative.

## Power separation guidelines

For power separation best guidelines, refer to the following standards:

- Telecommunications Pathways and Spaces, TIA-569-C
- Information technology – Implementation and operation of customer premises cabling – Part 2: Planning and installation, ISO/IEC 14763-2
- Information Technology – Cabling Installation – Part 2: Installation Planning and practices inside buildings, BS EN 50174-2





OneCell® Installation, RP5000 series, Release 4.0  
M0300A2 4.0.11 January 2020

**COMMScope®**