

FCC Test Report

Report No.: RF_FCC_LT19092001-CMM-001B14 Rev_4.0

FCC ID: QHYRPM-A5A11-B14

Test Model: RPM-A5A11-B14

Host Name: RP5100 Base Band Module

Series Model: N/A

Received Date: 10/03/2019

Test Date: 10/03/2019-10/11/2019

Issued Date: 01/19/2020

Standards: FCC Part 2, FCC Part 90

Applicant: CommScope

Address: 900 Chelmsford St, Lowell, MA 01851

Issued By: Bureau Veritas Consumer Products Services, Inc.

Lab Address: 1 Distribution Center Cir #1, Littleton, MA 01460

Test Location (1): 1 Distribution Center Cir #1, Littleton, MA 01460

**FCC Registration /
Designation Number:** 886956/US1028



Table of Contents

Release Control Record	3
1 Certificate of Conformity	4
2 Summary of Test Results	5
2.1 Measurement Uncertainty	5
2.2 Test Site And Instruments	6
3 General Information	7
3.1 General Description of EUT	7
3.2 Configuration of System under Test	8
3.3 EUT Operating Conditions	8
3.4 General Description of Applied Standards	9
4 Test Types and Results	10
4.1 E.R.P Measurement	10
4.1.1 Limits of E.R.P Measurement	10
4.2 Test Procedures	10
4.2.1 Test Setup	11
4.2.2 Test Results	12
4.3 Frequency Stability Measurement	13
4.3.1 Limits of Frequency Stability Measurement	13
4.3.2 Test Procedure	13
4.3.3 Test Setup	14
4.3.4 Test Results	14
4.4 Occupied Bandwidth Measurement	15
4.4.1 Limits of Occupied Bandwidth Measurement	15
4.4.2 Test Procedure	15
4.4.3 Test Setup	15
4.4.4 Test Result	16
LTE band 14	16
4.5 Band Edge Measurement	19
4.5.1 Limits of Band Edge Measurement	19
4.5.2 Test Setup	19
4.5.3 Test Procedures	19
4.5.4 Test Results	20
4.6 Peak To Average Ratio	23
4.6.1 Limits of Peak To Average Ratio Measurement	23
4.6.1 Test Setup	23
4.6.3 Test Procedures	23
4.6.4 Test Results	24
4.7 Conducted Spurious Emissions	27
4.7.1 Limits of Conducted Spurious Emissions Measurement	27
4.7.2 Test Setup	28
4.7.3 Test Procedure	28
4.7.4 Test Plots	29
4.8 Radiated Emission Measurement	34
4.8.1 Limits of Radiated Emission Measurement	34
4.8.2 Test Procedure	34
4.8.3 Deviation from Test Standard	34
4.8.4 Test Setup	35
4.8.5 Test Results	36
5 Pictures of Test Arrangements	41
Appendix – Information on the Testing Laboratories	42

Release Control Record

Issue No.	Description	Date Issued
RF_FCC_LT19092001-CMM-001B14	Original	12/11/2019
RF_FCC_LT19092001-CMM-001B14 Rev_1.0	Updated Per TCB Review	12/16/2019
RF_FCC_LT19092001-CMM-001B14 Rev_2.0	Updated Per TCB Review	01/09/2020
RF_FCC_LT19092001-CMM-001B14 Rev_3.0	Updated Power measurement	01/16/2020
RF_FCC_LT19092001-CMM-001B14 Rev_4.0	Updated EUT info, emission measurement and delete modulation characteristics	01/19/2020

1 Certificate of Conformity

Product: OneCell Radio Point

Brand: CommScope

Test Model: RPM-A5A11-B14

Host Name: RP5100 Base Band Module

Series Model: N/A

Sample Status: Sample received in good condition

Applicant: CommScope

Test Date: 10/03/2019-10/11/2019 and 01/16/2020

Standards: FCC Part 2, FCC Part 90

The above equipment has been tested by **Bureau Veritas Consumer Products Services, Inc., Littleton Branch**, and found compliance with the requirement of the above standards. The test record, data evaluation & Equipment Under Test (EUT) configurations represented herein are true and accurate accounts of the measurements of the sample's EMC characteristics under the conditions specified in this report.

Prepared by :  _____, **Date:** _____ 01/16/2020
Chen Ge / Test Engineer

Approved by :  _____, **Date:** _____ 01/16/2020
Shuo Zhang / Engineer Reviewer



2 Summary of Test Results

Applied Standard: FCC Part 90 & Part 2			
FCC Clause	Test Item	Result	Remarks
2.1047	Modulation Characteristics	PASS	N/A
2.1046 90.542	Output Power	PASS	Meet the requirement of limit.
2.1055 90.539	Frequency Stability	PASS	Meet the requirement of limit.
2.1049	Occupied Bandwidth	PASS	Meet the requirement of limit.
-	Peak To Average Ratio	PASS	Meet the requirement of limit.
2.1051 90.543	Conducted Spurious Emissions	PASS	Meet the requirement of limit.
2.1053 90.543	Radiated Spurious Emissions	PASS	Meet the requirement of limit.

Note: The report is reproduced in full content only.

The EUT is digital modulation.

All data rate QPSK, 16QAM, 64QAM and 256QAM are evaluated for output power and QPSK and 16QAM are the worst case.

Per ANSI C63.26: 2015 section 5.1.2.2, the results includes worst case modulation only.

2.1 Measurement Uncertainty

Where relevant, the following measurement uncertainty levels have been estimated for tests performed on the EUT as specified in CISPR 16-4-2:

Measurement	Frequency	Expanded Uncertainty (k=2) (\pm)
Conducted Emissions at mains ports	150kHz ~ 30MHz	3.51dB
Radiated Emissions up to 1 GHz	30MHz ~ 1GHz	3.73dB
Radiated Emissions above 1 GHz	1GHz ~ 6GHz	4.64dB
	6GHz ~ 18GHz	4.82dB
	18GHz ~ 40GHz	4.91dB



2.2 Test Site And Instruments

Equipment used for test during 10/03/2019-10/11/2019

Description	Model No.	Serial No.	Date Of Calibration	Due Date Of Calibration
MXE EMI Receiver(1170725)	N9038A	MY51210151	05/30/2019	05/30/2020
2311 PA	PAM-103	441174	10/14/2018	10/14/2019
2111 HF Preamp	PAM-118A	551063	10/14/2018	10/14/2019
Red-Black Bilog	JB1	A091604-2	04/26/2019	04/26/2021
Red-Brown Bilog	JB1	A0032406	03/11/2019	03/11/2021
Orange Horn	3115	0004-6123	11/06/2018	11/06/2020
Yellow Horn	3115	9608-4898	08/20/2018	08/20/2020
Weather Clock	BA928	C3166-1	05/15/2018	05/15/2020
Environment chamber #14	Espec ESZ-4CA	018639B 1426	09/16/2019	09/16/2020
20dB attenuator-64	N/A	N/A	11/20/2018	11/20/2019

Equipment used for test on 01/16/2020:

Description	Model No.	Serial No.	Date Of Calibration	Due Date Of Calibration
50GHz Spectrum Analyzer	N9030B (PXA)	MY57140374	07/22/2019	07/22/2020

3 General Information

3.1 General Description of EUT

Product	OneCell Radio Point
Host Name	RP5100 Base Band Module
Host model	7778115-00
Brand	CommScope
Test Model	RPM-A5A11-B14
Module model	RPM-A5A11-B14
Identification No. of EUT	19198000003
Series Model	N/A
Model Difference	N/A
Power Supply Rating	Input: 100-240VAC OutPut: 42-57V POE
Modulation Type	QPSK, 16QAM, 64QAM, 256QAM
Modulation Technology	OFDM
Operating Frequency	LTE band 14: 758-768MHz
Max. ERP Power	468.81mW
Antenna Type	Internal antenna
Antenna Connector	U.FL

3.2 Configuration of System under Test

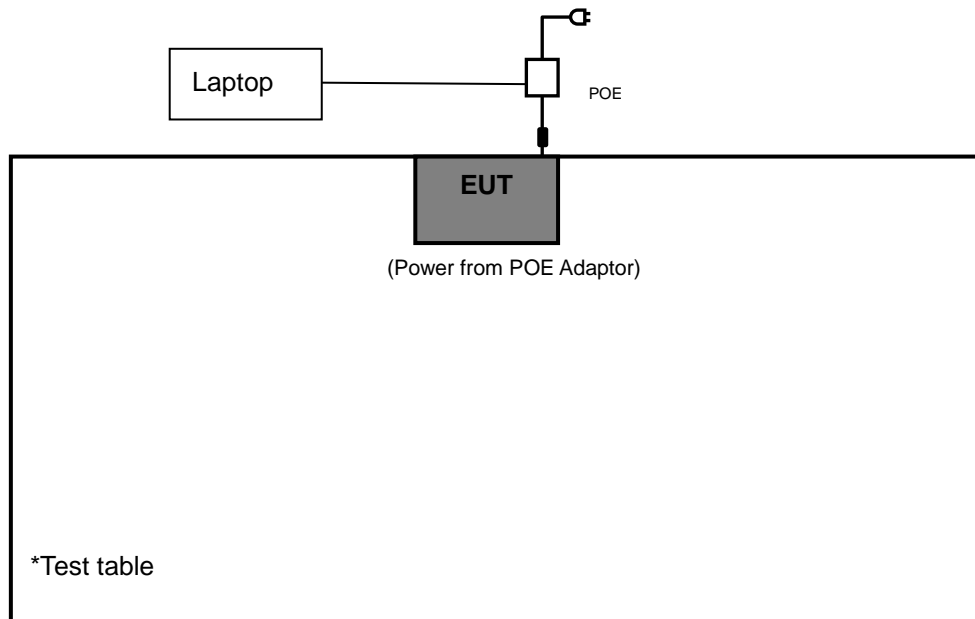

Test Condition:

Test Item	Environmental Conditions	Input Power	Tested By
ERP	21deg. C, 71%RH 22deg. C, 71%RH	120Vac, 60Hz	Chen Ge
Frequency Stability	24deg. C, 64%RH	42-57Vdc	Chen Ge
Modulation Characteristics	24deg. C, 64%RH	120Vac, 60Hz	Chen Ge
Occupied Bandwidth	24deg. C, 64%RH	120Vac, 60Hz	Chen Ge
Band Edge	24deg. C, 64%RH	120Vac, 60Hz	Chen Ge
Peak To Average Ratio	24deg. C, 64%RH	120Vac, 60Hz	Chen Ge
Conducted Emission	24deg. C, 64%RH	120Vac, 60Hz	Chen Ge
Radiated Emission	21deg. C, 71%RH	120Vac, 60Hz	Chen Ge

3.3 EUT Operating Conditions

The EUT makes a call to the communication simulator. The communication simulator station system controlled a EUT to export maximum output power under transmission mode and specific channel frequency

3.4 General Description of Applied Standards

The EUT is a RF Product. According to the specifications of the manufacturer, it must comply with the requirements of the following standards:

FCC 47 CFR Part 2

FCC 47 CFR Part 90

KDB 971168 D01 Power Meas License Digital Systems v02r02

ANSI/TIA/EIA-603-E 2016

ANSI 63.26-2015

NOTE: All test items have been performed and recorded as per the above standards.

4 Test Types and Results

4.1 E.R.P Measurement

4.1.1 Limits of E.R.P Measurement

Per FCC Part 90.542

Fixed and base stations transmitting a signal in the 758-768 MHz band with an emission bandwidth greater than 1 MHz must not exceed an ERP of 1000 watts/MHz and an antenna height of 305 m HAAT, except that antenna heights greater than 305 m HAAT are permitted if power levels are reduced below 1000 watts/MHz ERP accordance with Table 3 of this section.

Fixed and base stations located in a county with population density of 100 or fewer persons per square mile, based upon the most recently available population statistics from the Bureau of the Census, and transmitting a signal in the 758-768 MHz band with an emission bandwidth greater than 1 MHz must not exceed an ERP of 2000 watts/MHz and an antenna height of 305 m HAAT, except that antenna heights greater than 305 m HAAT are permitted if power levels are reduced below 2000 watts/MHz ERP in accordance with Table 4 of this section.

4.2 Test Procedures

EIRP / ERP Measurement:

EIRP = Output power level of S.G – TX cable loss + Antenna gain of substitution horn. E.R.P power can be calculated from E.I.R.P power by subtracting the gain of dipole, E.R.P power = E.I.P.R power - 2.15dBi.

Conducted Power Measurement:

The EUT was set up for the maximum power with LTE link data modulation and link up with simulator. Set the EUT to transmit under low, middle and high channel and record the power level shown on simulator.

4.2.1 Test Setup

CONDUCTED POWER MEASUREMENT:



For the actual test configuration, please refer to the attached file (Test Setup Photo).

4.2.2 Test Results
Conducted Output Power

LTE Band 14						
BW	Modulation	CH	Frequency	Power Chain 0 (dBm)	Power Chain 1 (dBm)	Combined (dBm)
			(MHz)			
5 MHz	QPSK	5305	760.5	21.36	21.06	24.22
		5330	763.0	21.07	21.09	24.09
		5355	765.5	21.37	21.08	24.24
	16QAM	5305	760.5	21.21	21.21	24.22
		5330	763.0	21.07	21.08	24.09
		5355	765.5	21.37	21.36	24.38
	64QAM	5305	760.5	21.30	20.59	23.97
		5330	763.0	20.65	20.56	23.62
		5355	765.5	20.78	20.68	23.74
	256QAM	5305	760.5	20.58	20.49	23.55
		5330	763.0	20.61	21.04	23.84
		5355	765.5	20.65	21.22	23.96
10MHz	QPSK	5330	763.0	21.47	21.47	24.48
	16QAM	5330	763.0	21.42	21.45	24.45
	64QAM	5330	763.0	21.19	20.72	23.98
	256QAM	5330	763.0	20.97	21.37	24.19

Note:
Based on conducted power measurement, QPSK and 16QAM are the worst case modulation.

E.R.P

LTE Band 14						
BW	Modulation	CH	Frequency	Combined (dBm)	Antenna Gain (dBi)	E.R.P (dBm)
			(MHz)			
5 MHz	QPSK	5305	760.5	24.22	4	26.07
		5330	763.0	24.09	4	25.94
		5355	765.5	24.24	4	26.09
	16QAM	5305	760.5	24.22	4	26.07
		5330	763.0	24.09	4	25.94
		5355	765.5	24.38	4	26.23
	64QAM	5305	760.5	23.97	4	25.82
		5330	763.0	23.62	4	25.47
		5355	765.5	23.74	4	25.59
	256QAM	5305	760.5	23.55	4	25.40
		5330	763.0	23.84	4	25.69
		5355	765.5	23.96	4	25.81
10MHz	QPSK	5330	763.0	24.48	4	26.33
	16QAM	5330	763.0	24.45	4	26.30
	64QAM	5330	763.0	23.98	4	25.83
	256QAM	5330	763.0	24.19	4	26.04

4.3 Frequency Stability Measurement

4.3.1 Limits of Frequency Stability Measurement

The frequency stability of base transmitters operating in the wideband segment must be 1 part per million or better.

4.3.2 Test Procedure

- a. Device is placed at the oven room. The oven room could control the temperatures and humidity. Power warm up is at least 15 min and power applied should perform before recording frequency error.
- b. EUT is connected the external power supply to control the DC input power. The test voltage range is from minimum to maximum working voltage. Each step shall be record the frequency error rate.
- c. The temperature range step is 10 degrees in this test items. All temperature levels shall be hold the $\pm 0.5^{\circ}\text{C}$ during the measurement testing. The each temperature step shall be at least 0.5 hours, consider the EUT could be test under the stability condition.

NOTE: The frequency error was recorded frequency error from the communication simulator.

4.3.3 Test Setup



4.3.4 Test Results

Frequency Error vs. Voltage

Voltage (Volts)	Frequency Error (ppm)	Limit (ppm)
42	0	1
57	0	1

NOTE: The applicant defined the normal working voltage of the battery is from 42Vdc to 57Vdc.

Frequency Error vs. Temperature.

TEMP. (°C)	Frequency Error (ppm)	Limit (ppm)
50	0.12	1
40	0.12	1
30	0.12	1
20	0	1
10	0.13	1
0	0.23	1

4.4 Occupied Bandwidth Measurement

4.4.1 Limits of Occupied Bandwidth Measurement

The width of a frequency band such that, below the lower and above the upper frequency limits, the mean powers emitted are each equal to a specified percentage 0.5 %of the total mean power of a given emission.

4.4.2 Test Procedure

The EUT makes a call to the communication simulator. All measurements were done at low, middle and high operational frequency range. The communication simulator station system controlled a EUT to export maximum output power under transmission mode and specific channel frequency. Use OBW measurement function of Spectrum analyzer to measure 99 % occupied bandwidth.

4.4.3 Test Setup



4.4.4 Test Result
LTE BAND 14

Type	Channel	Channel Frequency (MHz)	99% Occupied Bandwidth (MHz)	26 dB Occupied Bandwidth (MHz)
5MHz BW, QPSK	5305	760.5	4.47	4.91
	5330	763.0	4.48	4.87
	5355	765.5	4.48	4.88
5MHz BW, 16QAM	5305	760.5	4.48	4.91
	5330	763.0	4.49	4.90
	5355	765.5	4.48	4.88
10MHz BW, QPSK	5330	763.0	8.94	9.62
10MHz BW, 16QAM	5330	763.0	8.94	9.65

LTE band 14:

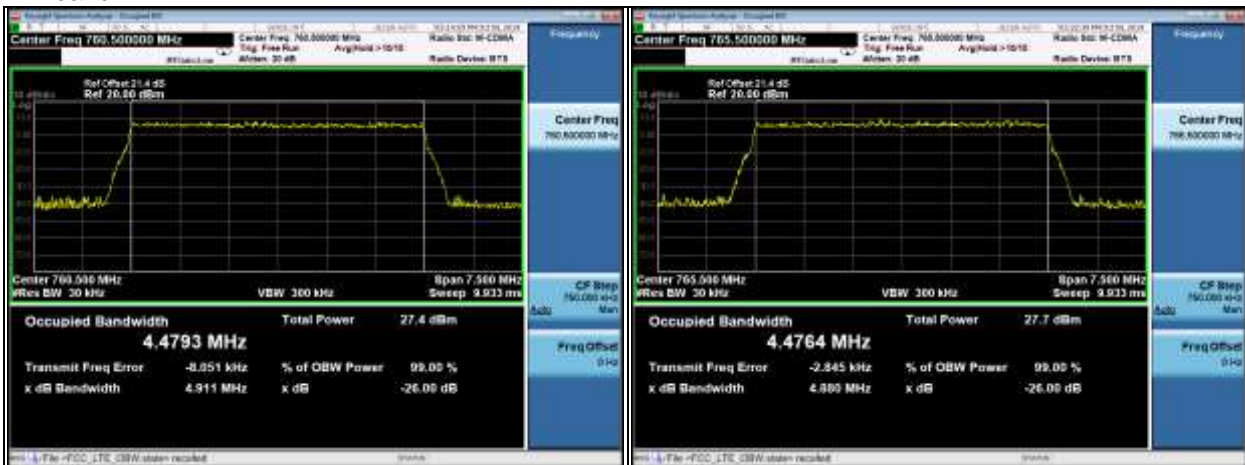

5MHz, QPSK, Low Channel

5MHz, QPSK, Mid Channel



5MHz, QPSK, High Channel

5MHz, 16QAM, Low Channel



5MHz, 16QAM, Mid Channel

5MHz, 16QAM, High Channel

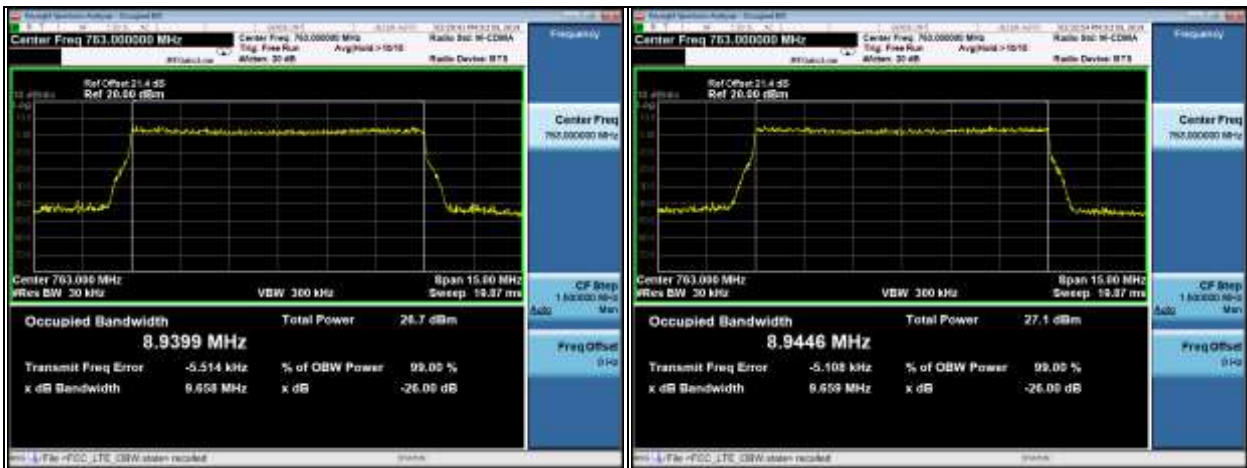

10MHz, QPSK, Mid Channel

10MHz, 16QAM, Mid Channel

4.5 Band Edge Measurement

4.5.1 Limits of Band Edge Measurement

On all frequencies between 769-775 MHz and 799-805 MHz, by a factor not less than $76 + 10 \log (P)$ dB in a 6.25 kHz band segment, for base and fixed stations.

On all frequencies between 769-775 MHz and 799-805 MHz, by a factor not less than $65 + 10 \log (P)$ dB in a 6.25 kHz band segment, for mobile and portable stations.

On any frequency between 775-788 MHz, above 805 MHz, and below 758 MHz, by at least $43 + 10 \log (P)$ dB.

Compliance with the provisions of paragraphs (e)(1) and (2) of this section is based on the use of measurement instrumentation such that the reading taken with any resolution bandwidth setting should be adjusted to indicate spectral energy in a 6.25 kHz segment.

4.5.2 Test Setup

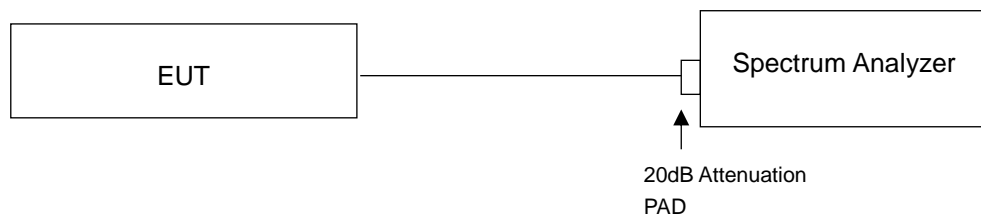

4.5.3 Test Procedures

- a. All measurements were done at low and high operational frequency range.
- b. The band edge measurement used the power splitter via EUT RF power connector between signal generator and spectrum analyzer. This splitter loss, attenuator loss and cable loss are the worst loss 21 dB in the transmitted path track.
- c. The center frequency of spectrum is the band edge frequency and span is 1 MHz. RB of the spectrum is 100kHz and VB of the spectrum is 300kHz.
- d. Record the max trace plot into the test report.

4.5.4 Test Results

Worst case of both chains:

LTE band 14

Type	Channel	Channel Frequency (MHz)	Measurement Band Edge (dBm)	Limit (dBm)
5MHz BW, QPSK	5305	760.5	-24.88	-13
	5355	765.5	-22.84	-13
5MHz BW, 16QAM	5305	760.5	-23.94	-13
	5355	765.5	-25.37	-13
10MHz BW, QPSK	5330	763.0	-31.15	-13
	5330	763.0	-30.05	-13
10MHz BW, 16QAM	5330	763.0	-32.50	-13
	5330	763.0	-30.75	-13

Test Plots
LTE band 14:

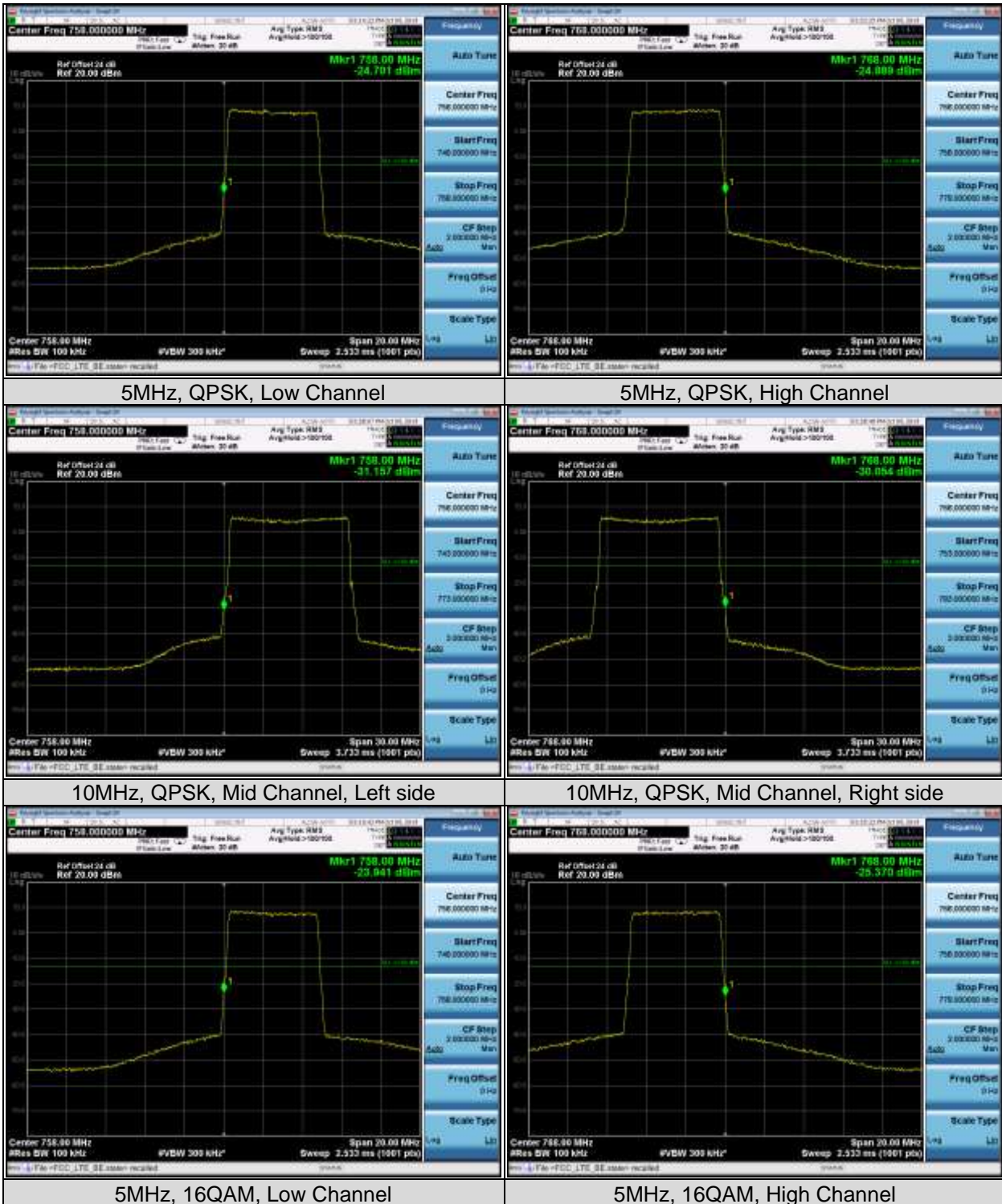

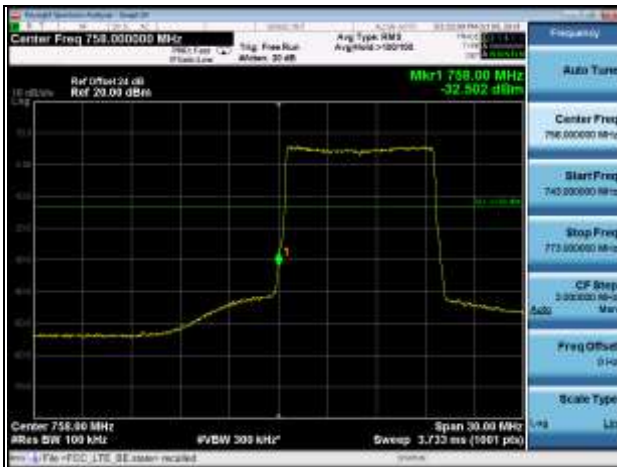

10MHz, 16QAM, Mid Channel, Left side



10MHz, 16QAM, Mid Channel, Right side

4.6 Peak To Average Ratio

4.6.1 Limits of Peak To Average Ratio Measurement

In measuring transmissions in this band using an average power technique, the peak to-average ratio (PAR) of the transmission may not exceed 13 dB

4.6.1 Test Setup



4.6.3 Test Procedures

1. Set resolution/measurement bandwidth \geq signal's occupied bandwidth;
2. Set the number of counts to a value that stabilizes the measured CCDF curve;
3. Record the maximum PAPR level associated with a probability of 0.1%.

4.6.4 Test Results

LTE band 14

Type	Channel	Frequency (MHz)	Peak-Average Ratio (dB)	Peak-Average Ratio (dB)
5MHz BW, QPSK	5305	760.5	9.44	13
	5330	763.0	9.51	13
	5355	765.5	9.50	13
5MHz BW, 16QAM	5305	760.5	9.30	13
	5330	763.0	9.35	13
	5355	765.5	9.33	13
10MHz BW, QPSK	5330	763.0	9.56	13
10MHz BW, 16QAM	5330	763.0	9.63	13

Test Plots
LTE band 14:



5MHz, QPSK, Low Channel

5MHz, QPSK, Mid Channel



5MHz, QPSK, High Channel

5MHz, 16QAM, Low Channel

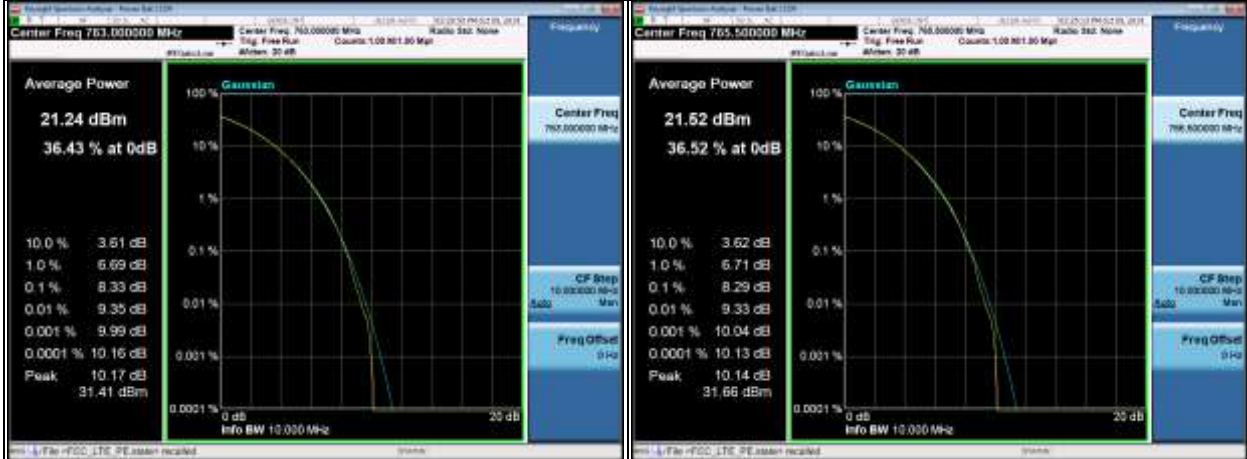

5MHz, 16QAM, Mid Channel

5MHz, 16QAM, High Channel

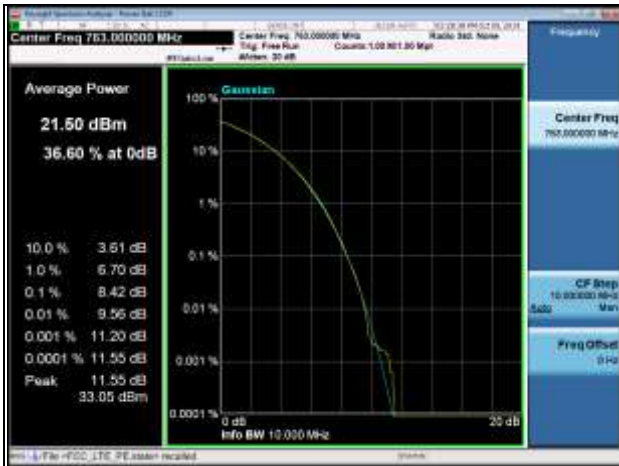

10MHz, QPSK, Mid Channel

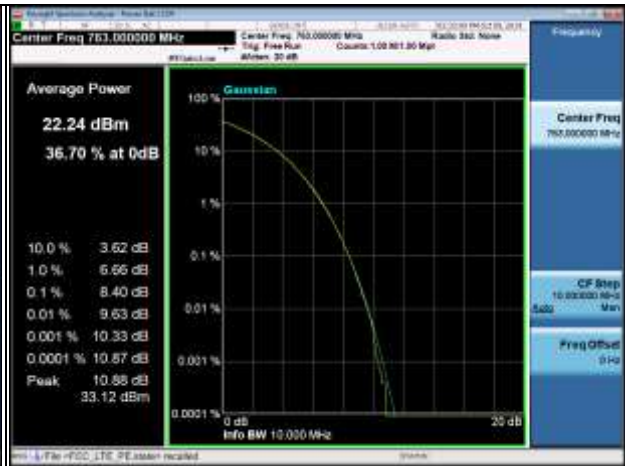

10MHz, 16QAM, Mid Channel

4.7 Conducted Spurious Emissions

4.7.1 Limits of Conducted Spurious Emissions Measurement

(e) For operations in the 758–768 MHz and the 788–798 MHz bands, the power of any emission outside the licensee’s frequency band(s) of operation shall be attenuated below the transmitter power (P) within the licensed band(s) of operation, measured in watts, in accordance with the following:

(1) On all frequencies between 769–775MHz and 799–805 MHz, by a factor not less than $76 + 10 \log (P)$ dB in a 6.25 kHz band segment, for base and fixed stations.

(3) On any frequency between 775–788MHz, above 805 MHz, and below 758MHz, by at least $43 + 10 \log (P)$ dB.

(4) Compliance with the provisions of paragraphs (e)(1) and (2) of this section is based on the use of measurement instrumentation such that the reading taken with any resolution bandwidth setting should be adjusted to indicate spectral energy in a 6.25 kHz segment.

4.7.2 Test Setup



4.7.3 Test Procedure

- a. The EUT was set up for the maximum peak power with LTE link data modulation. The power was measured with Agilent Spectrum Analyzer.
- b. The conducted spurious emission used the power splitter via EUT RF power connector between signal generator and spectrum analyzer.
- c. When the spectrum scanned from 30MHz to 8GHz, it shall be connected to the band reject filter attenuated the carried frequency. The spectrum set RB=1MHz, VB=3MHz.

4.7.4 Test Plots
LTE band 14:

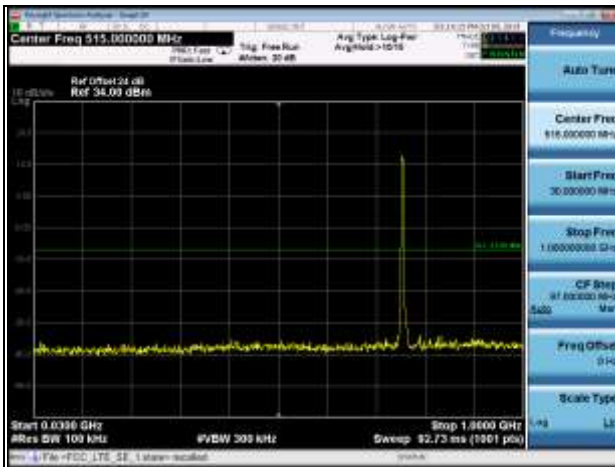

5MHz, QPSK, Low Channel, 30MHz-1GHz



5MHz, QPSK, Low Channel, 1GHz-26.5GHz

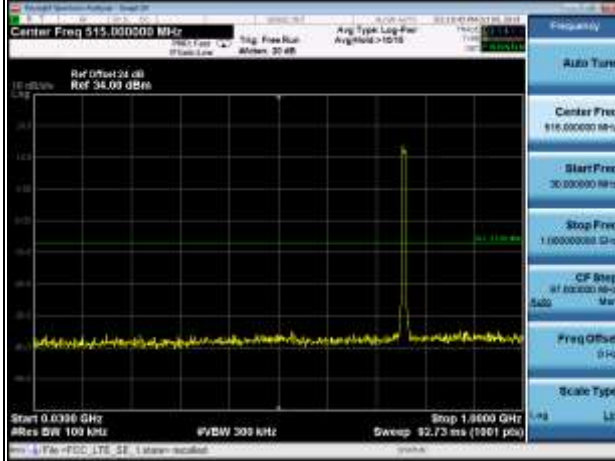

5MHz, QPSK, Mid Channel, 30MHz-1GHz



5MHz, QPSK, Mid Channel, 1GHz-26.5GHz

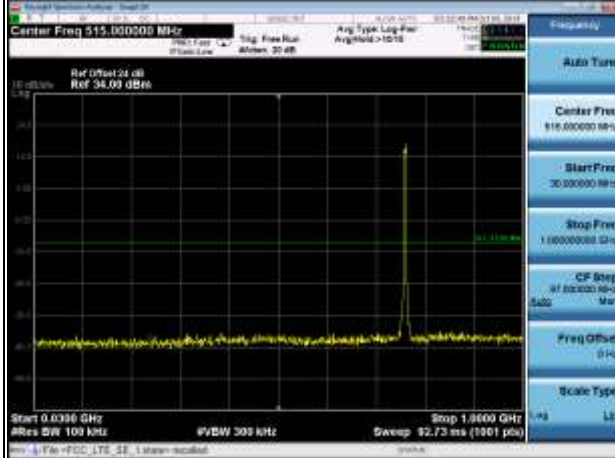

5MHz, QPSK, High Channel, 30MHz-1GHz



5MHz, QPSK, High Channel, 1GHz-26.5GHz



5MHz, QPSK, High Channel, 769MHz-775MHz

5MHz, QPSK, High Channel, 799MHz-805MHz



5MHz, 16QAM, Low Channel, 30MHz-1GHz



5MHz, 16QAM, Low Channel, 1GHz-26.5GHz



5MHz, 16QAM, Mid Channel, 30MHz-1GHz



5MHz, 16QAM, Mid Channel, 1GHz-26.5GHz

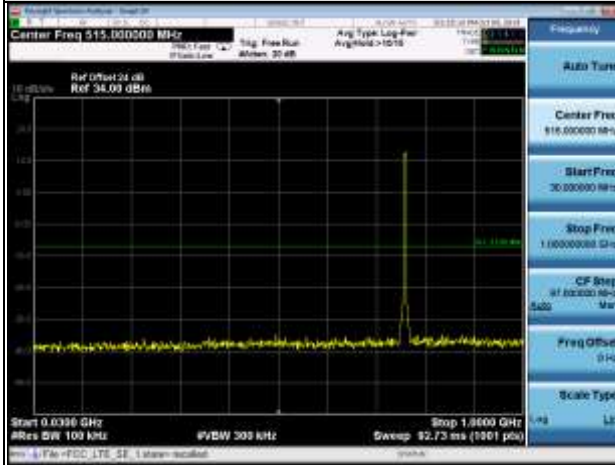

5MHz, 16QAM, High Channel, 30MHz-1GHz



5MHz, 16QAM, High Channel, 1GHz-26.5GHz



5MHz, 16QAM, High Channel, 769MHz-775MHz

5MHz, 16QAM, High Channel, 799MHz-805MHz

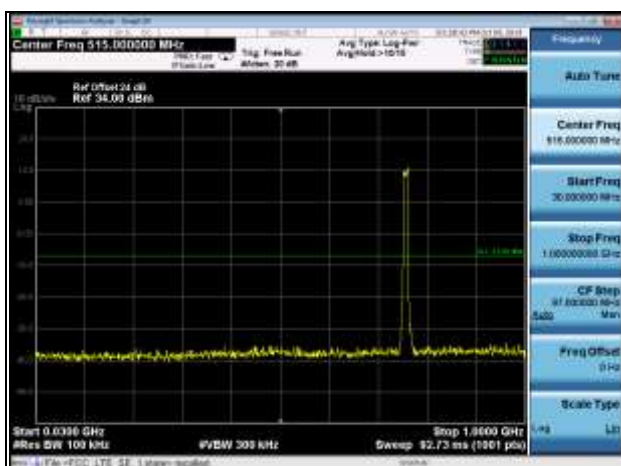

10MHz, QPSK, Mid Channel, 30MHz-1GHz



10MHz, QPSK, Low Channel, 1GHz-26.50GHz



10MHz, QPSK, Mid Channel, 769MHz-775MHz



10MHz, QPSK, Mid Channel, 799MHz-805MHz

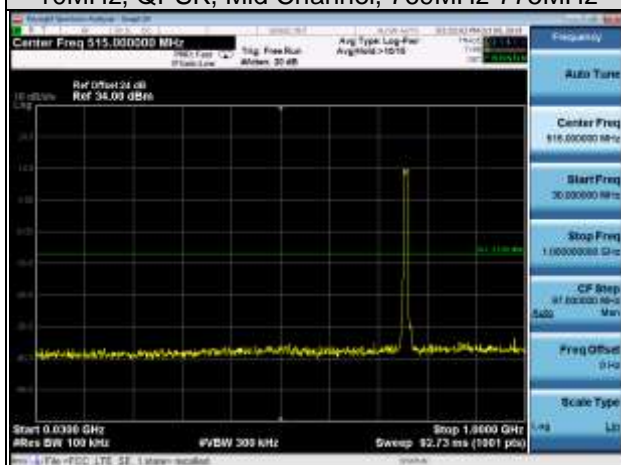

10MHz, 16QAM, Mid Channel, 30MHz-1GHz



10MHz, 16QAM, Mid Channel, 1GHz-26.50GHz



10MHz, 16QAM, Mid Channel, 769MHz-775MHz



10MHz, 16QAM, Mid Channel, 799MHz-805MHz

4.8 Radiated Emission Measurement

4.8.1 Limits of Radiated Emission Measurement

(1) The power of any emission outside a licensee's frequency block shall be attenuated below the transmitter power (P) by at least $43 + 10 \log_{10}(P)$ dB. The limit of emission equal to -13 dBm

(2) For operations in the 758-775 MHz and 788-805 MHz bands, all emissions including harmonics in the band 1559-1610 MHz shall be limited to -70 dBW/MHz equivalent isotropically radiated power (EIRP) for wideband signals, and -80 dBW EIRP for discrete emissions of less than 700 Hz bandwidth.

4.8.2 Test Procedure

- a. Substitution method is used for E.I.R.P measurement. In the semi-anechoic chamber, EUT placed on the 0.8m height of Turn Table, rotated the table around 360 degrees to search the maximum radiation power and receiver antenna shall be rotated vertical and horizontal polarization and moved height from 1m to 4m to find the maximum polar radiated power. The "Read Value" is the spectrum reading the maximum power value.
- b. The substitution horn antenna is substituted for EUT at the same position and signals generator export the CW signal to the substitution antenna via a TX cable. Rotated the Turn Table and moved receiving antenna to find the maximum radiation power. Adjust output power level of S.G to get a Value of spectrum reading equal to "Read Value" of step a. Record the power level of S.G
- c. $EIRP = \text{Output power level of S.G} - \text{TX cable loss} + \text{Antenna gain of substitution horn}$.
- d. E.R.P power can be calculated form E.I.R.P power by subtracting the gain of dipole, $E.R.P \text{ power} = E.I.P.R \text{ power} - 2.15 \text{dBi}$.

NOTE: The resolution bandwidth and video bandwidth of test receiver/spectrum analyzer is 1MHz/3MHz.

4.8.3 Deviation from Test Standard

No deviation.

4.8.4 Test Setup

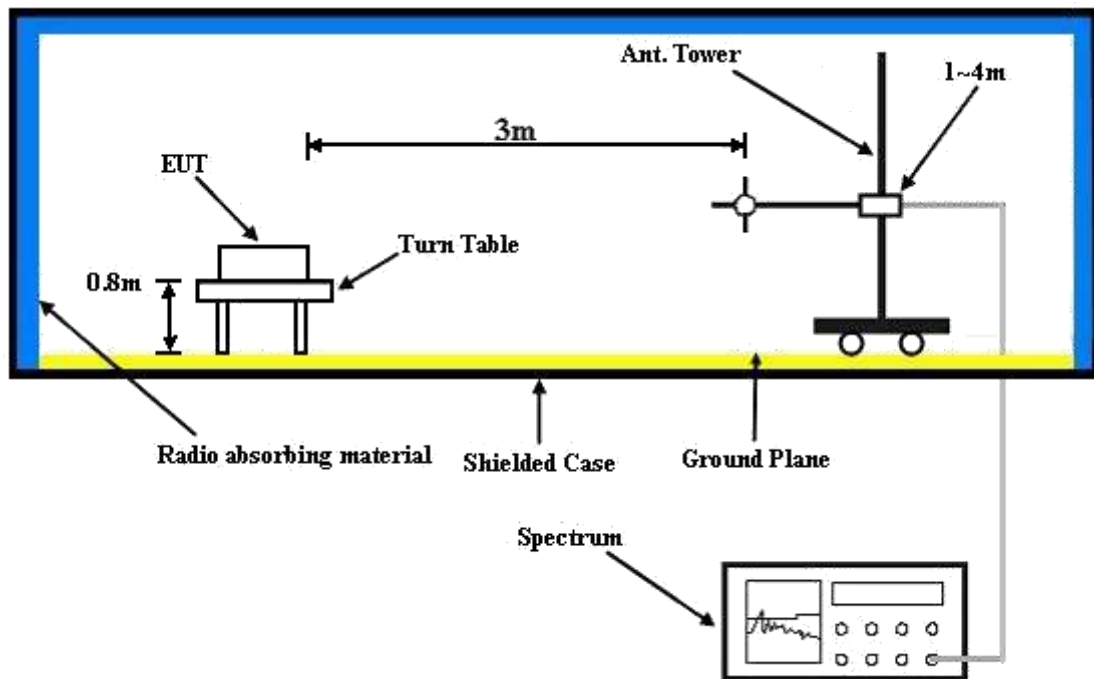

For the actual test configuration, please refer to the attached file (Test Setup Photo).

4.8.5 Test Results

Below 1GHz

Below 1GHz Worst-case Data

Frequency Range	30 MHz ~ 1 GHz	Operating Channel	763MHz
------------------------	----------------	--------------------------	--------

Indicated			Test Antenna		Substituted						
Frequency (MHz)	Raw (dBm)	Degree	Hgt (cm)	Pol (V/H)	Frequency (MHz)	Level (dBm)	Ant Gain (dBi)	Cable Loss (dB)	Absolute Level (dBm)	Limit (dBm)	Margin (dB)
63.24	-73.93	19	155	V	63.24	-68.59	0	0.25	-68.84	-13	-55.84
63.24	-75.28	214	169	H	63.24	-69.74	0	0.25	-69.99	-13	-56.99
625.77	-69.82	228	153	V	625.77	-64.47	0	0.78	-65.25	-13	-52.25
625.77	-70.31	149	200	H	625.77	-64.1	0	0.78	-64.88	-13	-51.88

Above 1GHz

LTE band 14

5MHz BW, low channel, QPSK

Measurement outside 1559-1610MHz

Indicated			Test Antenna		Substituted						
Frequency (MHz)	Raw (dBm)	Degree	Hgt (cm)	Pol (V/H)	Frequency (MHz)	Level (dBm)	Ant Gain (dBi)	Cable Loss (dB)	Absolute Level (dBm)	Limit (dBm)	Margin (dB)
2281.5	-61.19	279	199	V	2281.5	-56.59	9.31	1.45	-48.73	-13	-35.73
2281.5	-63.12	3	197	H	2281.5	-58.52	9.31	1.45	-50.66	-13	-37.66
7938	-55.81	105	171	V	7938	-50.07	10.81	2.54	-41.8	-13	-28.8
7938	-54.06	173	163	H	7938	-48.32	10.81	2.54	-40.05	-13	-27.05

Measurement inside 1559-1610MHz (1MHz BW)

Indicated			Test Antenna		Substituted						
Frequency (MHz)	Raw (dBm)	Degree	Hgt (cm)	Pol (V/H)	Frequency (MHz)	Level (dBm)	Ant Gain (dBi)	Cable Loss (dB)	Absolute Level (dBm)	Limit (dBm)	Margin (dB)
1563	-63.76	150	151	V	1563	-59.42	9.57	1.26	-51.11	-40	-11.11
1563	-63.18	198	174	H	1563	-58.84	9.57	1.26	-50.53	-40	-10.53

Measurement inside 1559-1610MHz (700Hz BW)

Indicated			Test Antenna		Substituted						
Frequency (MHz)	Raw (dBm)	Degree	Hgt (cm)	Pol (V/H)	Frequency (MHz)	Level (dBm)	Ant Gain (dBi)	Cable Loss (dB)	Absolute Level (dBm)	Limit (dBm)	Margin (dB)
1572	-71.84	291	152	V	1572	-67.50	9.53	1.26	-59.23	-50	-9.23
1572	-72.78	131	214	H	1572	-68.44	9.53	1.26	-60.17	-50	-10.17

5MHz BW, mid channel, QPSK

Measurement outside 1559-1610MHz

Indicated			Test Antenna		Substituted						
Frequency (MHz)	Raw (dBm)	Degree	Hgt (cm)	Pol (V/H)	Frequency (MHz)	Level (dBm)	Ant Gain (dBi)	Cable Loss (dB)	Absolute Level (dBm)	Limit (dBm)	Margin (dB)
2289	-58.4	310	166	V	2289	-53.79	9.29	1.45	-45.95	-13	-32.95
2289	-63.45	192	192	H	2289	-58.84	9.29	1.45	-51	-13	-38
7675	-56.26	238	206	V	7675	-50.45	11.05	2.47	-41.87	-13	-28.87
7675	-55.08	225	188	H	7675	-49.27	11.05	2.47	-40.69	-13	-27.69

Measurement inside 1559-1610MHz (1MHz BW)

Indicated			Test Antenna		Substituted						
Frequency (MHz)	Raw (dBm)	Degree	Hgt (cm)	Pol (V/H)	Frequency (MHz)	Level (dBm)	Ant Gain (dBi)	Cable Loss (dB)	Absolute Level (dBm)	Limit (dBm)	Margin (dB)
1562	-63.13	81	172	V	1562	-58.79	9.57	1.26	-50.48	-40	-10.48
1562	-65.38	32	150	H	1562	-61.04	9.57	1.26	-52.73	-40	-12.73

Measurement inside 1559-1610MHz (700Hz BW)

Indicated			Test Antenna		Substituted						
Frequency (MHz)	Raw (dBm)	Degree	Hgt (cm)	Pol (V/H)	Frequency (MHz)	Level (dBm)	Ant Gain (dBi)	Cable Loss (dB)	Absolute Level (dBm)	Limit (dBm)	Margin (dB)
1606	-75	225	157	V	1606	-70.66	9.41	1.27	-62.52	-50	-12.52
1606	-72.82	326	201	H	1606	-68.48	9.41	1.27	-60.34	-50	-10.34

5MHz BW, high channel, QPSK

Measurement outside 1559-1610MHz

Indicated			Test Antenna		Substituted						
Frequency (MHz)	Raw (dBm)	Degree	Hgt (cm)	Pol (V/H)	Frequency (MHz)	Level (dBm)	Ant Gain (dBi)	Cable Loss (dB)	Absolute Level (dBm)	Limit (dBm)	Margin (dB)
2296.5	-62.48	225	196	V	2296.5	-57.87	9.28	1.45	-50.04	-13	-37.04
2296.5	-60.72	64	189	H	2296.5	-56.11	9.28	1.45	-48.28	-13	-35.28
7505	-59.1	180	212	V	7505	-53.25	10.7	2.43	-44.98	-13	-31.98
7505	-57.91	145	189	H	7505	-52.06	10.7	2.43	-43.79	-13	-30.79

Measurement inside 1559-1610MHz (1MHz BW)

Indicated			Test Antenna		Substituted						
Frequency (MHz)	Raw (dBm)	Degree	Hgt (cm)	Pol (V/H)	Frequency (MHz)	Level (dBm)	Ant Gain (dBi)	Cable Loss (dB)	Absolute Level (dBm)	Limit (dBm)	Margin (dB)
1587	-62.08	47	190	V	1587	-57.74	9.47	1.27	-49.54	-40	-9.54
1587	-64.13	2	220	H	1587	-59.79	9.47	1.27	-51.59	-40	-11.59

Measurement inside 1559-1610MHz (700Hz BW)

Indicated			Test Antenna		Substituted						
Frequency (MHz)	Raw (dBm)	Degree	Hgt (cm)	Pol (V/H)	Frequency (MHz)	Level (dBm)	Ant Gain (dBi)	Cable Loss (dB)	Absolute Level (dBm)	Limit (dBm)	Margin (dB)
1590	-73.9	294	196	V	1590	-69.56	9.46	1.27	-61.37	-50	-11.37
1590	-76.28	1	219	H	1590	-71.94	9.46	1.27	-63.75	-50	-13.75

10MHz BW, mid channel, QPSK

Measurement outside 1559-1610MHz

Indicated			Test Antenna		Substituted						
Frequency (MHz)	Raw (dBm)	Degree	Hgt (cm)	Pol (V/H)	Frequency (MHz)	Level (dBm)	Ant Gain (dBi)	Cable Loss (dB)	Absolute Level (dBm)	Limit (dBm)	Margin (dB)
2289	-60.73	6	164	V	2289	-56.12	9.29	1.45	-48.28	-13	-35.28
2289	-62.06	245	160	H	2289	-57.45	9.29	1.45	-49.61	-13	-36.61
7468	-54.71	99	181	V	7468	-48.85	10.64	2.42	-40.63	-13	-27.63
7468	-53.77	172	177	H	7468	-47.91	10.64	2.42	-39.69	-13	-26.69

Measurement inside 1559-1610MHz (1MHz BW)

Indicated			Test Antenna		Substituted						
Frequency (MHz)	Raw (dBm)	Degree	Hgt (cm)	Pol (V/H)	Frequency (MHz)	Level (dBm)	Ant Gain (dBi)	Cable Loss (dB)	Absolute Level (dBm)	Limit (dBm)	Margin (dB)
1600	-63.26	217	183	V	1600	-58.92	9.42	1.27	-50.77	-40	-10.77
1600	-63.18	246	168	H	1600	-58.84	9.42	1.27	-50.69	-40	-10.69

Measurement inside 1559-1610MHz (700Hz BW)

Indicated			Test Antenna		Substituted						
Frequency (MHz)	Raw (dBm)	Degree	Hgt (cm)	Pol (V/H)	Frequency (MHz)	Level (dBm)	Ant Gain (dBi)	Cable Loss (dB)	Absolute Level (dBm)	Limit (dBm)	Margin (dB)
1592	-71.3	260	216	V	1592	-66.96	9.45	1.27	-58.78	-50	-8.78
1592	-71.68	93	179	H	1592	-67.34	9.45	1.27	-59.16	-50	-9.16

REMARKS:

1. Absolute level (dBm) = Level (dBm) + Ant Gain(dBi) – Cable Loss(dB)
2. Margin value = Absolute level – Limit value.

5 Pictures of Test Arrangements

Please refer to the attached file (Test Setup Photo).



Appendix – Information on the Testing Laboratories

Bureau Veritas is a global leader in testing, inspection and certification (TIC) services. We help businesses improve safety, sustainability and productivity; and our clients include the majority of leading brands in retail, manufacturing and other industries. With a presence in every major country around the world, our quality assurance and compliance solutions are vital in helping our customers enhance product quality and concept-to-consumer journeys. We also assist with increasing speed to market, profitability and brand equity throughout the supply chain. Bureau Veritas is a leading wireless/IoT testing, inspection, audit and certification provider, with a global network of test laboratories to support the IoT industry in areas of connectivity, security, interoperability as well as quality, health & safety, and environmental/chemical requirements.

If you have any comments, please feel free to contact us at the following:

Milpitas EMC/RF/Safety/Telecom Lab

775 Montague Expressway, Milpitas, CA 95035

Tel: +1 408 526 1188

Sunnyvale OTA/Bluetooth Lab

1293 Anvilwood Avenue, Sunnyvale, CA 94089

Tel: +1 669 600 5293

Littleton EMC/RF/Safety/Environmental Lab

1 Distribution Center Cir #1, Littleton, MA 01460

Tel: +1 978 486 8880

Irvine OTA/PTCRB/Bluetooth/V2X Lab

15 Musick, Irvine, CA 92618

Tel: +1 949 716 6512

Email: sales.eaw@us.bureauveritas.com

Web Site: www.cpsusa-bureauveritas.com

The address and road map of all our labs can be found in our web site also.

--- END ---