



MET Laboratories, Inc. *Safety Certification - EMI - Telecom Environmental Simulation*

914 WEST PATAPSCO AVENUE • BALTIMORE, MARYLAND 21230-3432 • PHONE (410) 354-3300 • FAX (410) 354-3313

33439 WESTERN AVENUE • UNION CITY, CALIFORNIA 94587 • PHONE (510) 489-6300 • FAX (510) 489-6372

3162 BELICK STREET • SANTA CLARA, CA 95054 • PHONE (408) 748-3585 • FAX (510) 489-6372

13501 MCCALLEN PASS • AUSTIN, TEXAS 78753 • PHONE (512) 287-2500 • FAX (512) 287-2513

July 14, 2015

Airvana
250 Apollo Drive
Chelmsford, MA 01824

Dear Gary Falk,

Enclosed is the EMC Wireless test report for compliance testing of the Airvana, Small Cell Type as tested to the requirements of Title 47 of the CFR, Ch. 1 (10-1-06 ed.), Part 15 Subpart C for Intentional Radiators.

Thank you for using the services of MET Laboratories, Inc. If you have any questions regarding these results or if MET can be of further service to you, please feel free to contact me.

Sincerely yours,
MET LABORATORIES, INC.

Jennifer Warnell
Documentation Department

Reference: (\Airvana\EMC85068-FCC247 Rev. 1)

Certificates and reports shall not be reproduced except in full, without the written permission of MET Laboratories, Inc.

Electromagnetic Compatibility Criteria Test Report

for the

**Airvana
Small Cell Type**

Tested under
the FCC Certification Rules
contained in
Title 47 of the CFR, Part 15.247 Subpart C
for Intentional Radiators

MET Report: EMC85068-FCC247 Rev. 1

July 14, 2015

Prepared For:

**Airvana
250 Apollo Drive
Chelmsford, MA 01824**

Prepared By:
MET Laboratories, Inc.
914 W. Patapsco Ave.
Baltimore, MD 21230

Electromagnetic Compatibility Criteria Test Report

for the

Airvana Small Cell Type

Tested under
the FCC Certification Rules
contained in
Title 47 of the CFR, Part 15.247 Subpart C
for Intentional Radiators



Benjamin Taylor, Project Engineer
Electromagnetic Compatibility Lab



Jennifer Warnell
Documentation Department

Engineering Statement: The measurements shown in this report were made in accordance with the procedures indicated, and the emissions from this equipment were found to be within the limits applicable. I assume full responsibility for the accuracy and completeness of these measurements, and for the qualifications of all persons taking them. It is further stated that upon the basis of the measurements made, the equipment tested is capable of operation in accordance with the requirements of the FCC Rules Part 15.247 under normal use and maintenance.



Asad Bajwa,
Director, Electromagnetic Compatibility Lab

Report Status Sheet

Revision	Report Date	Reason for Revision
∅	June 29, 2015	Initial Issue.
1	July 14, 2015	Editorial correction.

Table of Contents

I.	Executive Summary	1
	A. Purpose of Test	2
	B. Executive Summary	2
II.	Equipment Configuration	3
	A. Overview.....	4
	B. References.....	5
	C. Test Site	5
	D. Description of Test Sample.....	5
	E. Equipment Configuration.....	6
	F. Support Equipment	6
	G. Ports and Cabling Information.....	7
	H. Mode of Operation.....	7
	I. Method of Monitoring EUT Operation	7
	J. Modifications	7
	a) Modifications to EUT.....	7
	b) Modifications to Test Standard.....	7
	K. Disposition of EUT	7
III.	Electromagnetic Compatibility Criteria for Intentional Radiators.....	8
	§ 15.203 Antenna Requirement.....	9
	§ 15.207(a) Conducted Emissions Limits.....	10
	§ 15.247(a)(a) 6 dB Bandwidth	13
	§ 15.247(b) Peak Power Output	21
	§ 15.247(d) Radiated Spurious Emissions Requirements and Band Edge.....	23
	§ 15.247(d) RF Conducted Spurious Emissions Requirements and Band Edge.....	41
	§ 15.247(e) Peak Power Spectral Density	56
	§ 15.247(i) Maximum Permissible Exposure	58
IV.	Test Equipment	59
V.	Certification & User's Manual Information.....	61
	A. Certification Information	62
	B. Label and User's Manual Information	68

List of Tables

Table 1. Executive Summary of EMC Part 15.247 Compliance Testing	2
Table 2. EUT Summary Table.....	4
Table 3. References	5
Table 4. Equipment Configuration	6
Table 5. Support Equipment.....	6
Table 6. Ports and Cabling Information	7
Table 7. Conducted Limits for Intentional Radiators from FCC Part 15 § 15.207(a)	10
Table 8. Conducted Emissions, 15.207(a), Phase Line, Test Results	11
Table 9. Conducted Emissions, 15.207(a), Neutral Line, Test Results	12
Table 10. Occupied Bandwidth, Test Results.....	14
Table 11. Output Power Requirements from §15.247(b)	21
Table 12. RF Output Power, Test Results	22
Table 13. RF Output Power, Test Results, Summed Ports	22
Table 14. Restricted Bands of Operation.....	23
Table 15. Radiated Emissions Limits Calculated from FCC Part 15, § 15.209 (a)	24
Table 16. Peak Power Spectral Density, Test Results	57
Table 17. Test Equipment List	60

List of Plots

Plot 1. Conducted Emissions, 15.207(a), Phase Line	11
Plot 2. Conducted Emissions, 15.207(a), Neutral Line	12
Plot 3. Occupied Bandwidth, 802.11b 20 MHz, Low Channel, MIMO	15
Plot 4. Occupied Bandwidth, 802.11b 20 MHz, Mid Channel, MIMO	15
Plot 5. Occupied Bandwidth, 802.11b 20 MHz, High Channel, MIMO	15
Plot 6. Occupied Bandwidth, 802.11g 20 MHz, Low Channel, MIMO	16
Plot 7. Occupied Bandwidth, 802.11g 20 MHz, Mid Channel, MIMO.....	16
Plot 8. Occupied Bandwidth, 802.11g 20 MHz, High Channel, MIMO	16
Plot 9. Occupied Bandwidth, 802.11n 20 MHz, Low Channel, MIMO, Port 1	17
Plot 10. Occupied Bandwidth, 802.11n 20 MHz, Mid Channel, MIMO, Port 1	17
Plot 11. Occupied Bandwidth, 802.11n 20 MHz, High Channel, MIMO, Port 1	17
Plot 12. Occupied Bandwidth, 802.11n 40 MHz, Low Channel, MIMO, Port 1	18
Plot 13. Occupied Bandwidth, 802.11n 40 MHz, Mid Channel, MIMO, Port 1	18
Plot 14. Occupied Bandwidth, 802.11n 40 MHz, High Channel, MIMO, Port 1	18
Plot 15. Occupied Bandwidth, 802.11n 20 MHz, Low Channel, MIMO, Port 2	19
Plot 16. Occupied Bandwidth, 802.11n 20 MHz, Mid Channel, MIMO, Port 2	19
Plot 17. Occupied Bandwidth, 802.11n 20 MHz, High Channel, MIMO, Port 2	19
Plot 18. Occupied Bandwidth, 802.11n 40 MHz, Low Channel, MIMO, Port 2	20
Plot 19. Occupied Bandwidth, 802.11n 40 MHz, Mid Channel, MIMO, Port 2	20
Plot 20. Occupied Bandwidth, 802.11n 40 MHz, High Channel, MIMO, Port 2.....	20
Plot 21. Radiated Spurious Emissions, 802.11b 20 MHz, Low Channel, 2412 MHz, 1 GHz – 18 GHz, Average	25
Plot 22. Radiated Spurious Emissions, 802.11b 20 MHz, Low Channel, 2412 MHz, 1 GHz – 18 GHz, Peak.....	25
Plot 23. Radiated Spurious Emissions, 802.11b 20 MHz, Mid Channel, 2442 MHz, 30 MHz – 1 GHz	25
Plot 24. Radiated Spurious Emissions, 802.11b 20 MHz, Mid Channel, 2442 MHz, 1 GHz – 18 GHz, Average.....	26
Plot 25. Radiated Spurious Emissions, 802.11b 20 MHz, Mid Channel, 2442 MHz, 1 GHz – 18 GHz, Peak	26
Plot 26. Radiated Spurious Emissions, 802.11b 20 MHz, High Channel, 2462 MHz, 1 GHz – 18 GHz, Average	26
Plot 27. Radiated Spurious Emissions, 802.11b 20 MHz, High Channel, 2462 MHz, 1 GHz – 18 GHz, Peak	27
Plot 28. Radiated Spurious Emissions, 802.11g 20 MHz, Low Channel, 2412 MHz, 1 GHz – 18 GHz, Average	27
Plot 29. Radiated Spurious Emissions, 802.11g 20 MHz, Low Channel, 2412 MHz, 1 GHz – 18 GHz, Peak.....	27
Plot 30. Radiated Spurious Emissions, 802.11g 20 MHz, Mid Channel, 2442 MHz, 30 MHz – 1 GHz	28
Plot 31. Radiated Spurious Emissions, 802.11g 20 MHz, Mid Channel, 2442 MHz, 1 GHz – 18 GHz, Average.....	28
Plot 32. Radiated Spurious Emissions, 802.11g 20 MHz, Mid Channel, 2442 MHz, 1 GHz – 18 GHz, Peak	28

Plot 33. Radiated Spurious Emissions, 802.11g 20 MHz, High Channel, 2462 MHz, 1 GHz – 18 GHz, Average	29
Plot 34. Radiated Spurious Emissions, 802.11g 20 MHz, High Channel, 2462 MHz, 1 GHz – 18 GHz, Peak	29
Plot 35. Radiated Spurious Emissions, 802.11n 20 MHz, Low Channel, 2412 MHz, 1 GHz – 18 GHz, Average	29
Plot 36. Radiated Spurious Emissions, 802.11n 20 MHz, Low Channel, 2412 MHz, 1 GHz – 18 GHz, Peak	30
Plot 37. Radiated Spurious Emissions, 802.11n 20 MHz, Mid Channel, 2442 MHz, 30 MHz – 1 GHz	30
Plot 38. Radiated Spurious Emissions, 802.11n 20 MHz, Mid Channel, 2442 MHz, 1 GHz – 18 GHz, Average	30
Plot 39. Radiated Spurious Emissions, 802.11n 20 MHz, Mid Channel, 2442 MHz, 1 GHz – 18 GHz, Peak	31
Plot 40. Radiated Spurious Emissions, 802.11n 20 MHz, High Channel, 2462 MHz, 1 GHz – 18 GHz, Average	31
Plot 41. Radiated Spurious Emissions, 802.11n 20 MHz, High Channel, 2462 MHz, 1 GHz – 18 GHz, Peak	31
Plot 42. Radiated Spurious Emissions, 802.11n 40 MHz, Low Channel, 2422 MHz, 1 GHz – 18 GHz, Average	32
Plot 43. Radiated Spurious Emissions, 802.11n 40 MHz, Low Channel, 2422 MHz, 1 GHz – 18 GHz, Peak	32
Plot 44. Radiated Spurious Emissions, 802.11n 40 MHz, Mid Channel, 2442 MHz, 30 MHz – 1 GHz	32
Plot 45. Radiated Spurious Emissions, 802.11n 40 MHz, Mid Channel, 2442 MHz, 1 GHz – 18 GHz, Average	33
Plot 46. Radiated Spurious Emissions, 802.11n 40 MHz, Mid Channel, 2442 MHz, 1 GHz – 18 GHz, Peak	33
Plot 47. Radiated Spurious Emissions, 802.11n 40 MHz, High Channel, 2452 MHz, 1 GHz – 18 GHz, Average	33
Plot 48. Radiated Spurious Emissions, 802.11n 40 MHz, High Channel, 2452 MHz, 1 GHz – 18 GHz, Peak	34
Plot 49. Radiated Band Edge, 802.11b 20 MHz, Low Channel, 2412 MHz @ 2390 MHz, Average	35
Plot 50. Radiated Band Edge, 802.11b 20 MHz, Low Channel, 2412 MHz @ 2390 MHz, Peak	35
Plot 51. Radiated Band Edge, 802.11b 20 MHz, High Channel, 2462 MHz @ 2483.5 MHz, Average	35
Plot 52. Radiated Band Edge, 802.11b 20 MHz, High Channel, 2462 MHz @ 2483.5 MHz, Peak	36
Plot 53. Radiated Band Edge, 802.11g 20 MHz, Low Channel, 2412 MHz @ 2390 MHz, Average	36
Plot 54. Radiated Band Edge, 802.11g 20 MHz, Low Channel, 2412 MHz @ 2390 MHz, Peak	36
Plot 55. Radiated Band Edge, 802.11g 20 MHz, High Channel, 2462 MHz @ 2483.5 MHz, Average	37
Plot 56. Radiated Band Edge, 802.11g 20 MHz, High Channel, 2462 MHz @ 2483.5 MHz, Peak	37
Plot 57. Radiated Band Edge, 802.11n 20 MHz, Low Channel, 2412 MHz @ 2390 MHz, Average	37
Plot 58. Radiated Band Edge, 802.11n 20 MHz, Low Channel, 2412 MHz @ 2390 MHz, Peak	38
Plot 59. Radiated Band Edge, 802.11n 20 MHz, High Channel, 2462 MHz @ 2483.5 MHz, Average	38
Plot 60. Radiated Band Edge, 802.11n 20 MHz, High Channel, 2462 MHz @ 2483.5 MHz, Peak	38
Plot 61. Radiated Band Edge, 802.11n 40 MHz, Low Channel, 2422 MHz @ 2390 MHz, Average	39
Plot 62. Radiated Band Edge, 802.11n 40 MHz, Low Channel, 2422 MHz @ 2390 MHz, Peak	39
Plot 63. Radiated Band Edge, 802.11n 40 MHz, High Channel, 2452 MHz @ 2483.5 MHz, Average	39
Plot 64. Radiated Band Edge, 802.11n 40 MHz, High Channel, 2452 MHz @ 2483.5 MHz, Peak	40
Plot 65. Conducted Spurious Emissions, 802.11b 20 MHz, 2412 MHz, 30 MHz – 25 GHz, Port 1	42
Plot 66. Conducted Spurious Emissions, 802.11b 20 MHz, 2442 MHz, 30 MHz – 25 GHz, Port 1	42
Plot 67. Conducted Spurious Emissions, 802.11b 20 MHz, 2462 MHz, 30 MHz – 25 GHz, Port 1	42
Plot 68. Conducted Spurious Emissions, 802.11g 20 MHz, 2412 MHz, 30 MHz – 25 GHz, Port 1	43
Plot 69. Conducted Spurious Emissions, 802.11g 20 MHz, 2442 MHz, 30 MHz – 25 GHz, Port 1	43
Plot 70. Conducted Spurious Emissions, 802.11g 20 MHz, 2462 MHz, 30 MHz – 25 GHz, Port 1	43
Plot 71. Conducted Spurious Emissions, 802.11n 20 MHz, 2412 MHz, 30 MHz – 25 GHz, Port 1	44
Plot 72. Conducted Spurious Emissions, 802.11n 20 MHz, 2442 MHz, 30 MHz – 25 GHz, Port 1	44
Plot 73. Conducted Spurious Emissions, 802.11n 20 MHz, 2462 MHz, 30 MHz – 25 GHz, Port 1	44
Plot 74. Conducted Spurious Emissions, 802.11n 40 MHz, 2422 MHz, 30 MHz – 25 GHz, Port 1	45
Plot 75. Conducted Spurious Emissions, 802.11n 40 MHz, 2437 MHz, 30 MHz – 25 GHz, Port 1	45
Plot 76. Conducted Spurious Emissions, 802.11n 40 MHz, 2452 MHz, 30 MHz – 25 GHz, Port 1	45
Plot 77. Conducted Spurious Emissions, 802.11b 20 MHz, 2412 MHz, 30 MHz – 25 GHz, Port 2	46
Plot 78. Conducted Spurious Emissions, 802.11b 20 MHz, 2442 MHz, 30 MHz – 25 GHz, Port 2	46
Plot 79. Conducted Spurious Emissions, 802.11b 20 MHz, 2462 MHz, 30 MHz – 25 GHz, Port 2	46
Plot 80. Conducted Spurious Emissions, 802.11g 20 MHz, 2412 MHz, 30 MHz – 25 GHz, Port 2	47
Plot 81. Conducted Spurious Emissions, 802.11g 20 MHz, 2442 MHz, 30 MHz – 25 GHz, Port 2	47
Plot 82. Conducted Spurious Emissions, 802.11g 20 MHz, 2462 MHz, 30 MHz – 25 GHz, Port 2	47
Plot 83. Conducted Spurious Emissions, 802.11n 20 MHz, 2412 MHz, 30 MHz – 25 GHz, Port 2	48
Plot 84. Conducted Spurious Emissions, 802.11n 20 MHz, 2442 MHz, 30 MHz – 25 GHz, Port 2	48
Plot 85. Conducted Spurious Emissions, 802.11n 20 MHz, 2462 MHz, 30 MHz – 25 GHz, Port 2	48
Plot 86. Conducted Spurious Emissions, 802.11n 40 MHz, 2422 MHz, 30 MHz – 25 GHz, Port 2	49
Plot 87. Conducted Spurious Emissions, 802.11n 40 MHz, 2437 MHz, 30 MHz – 25 GHz, Port 2	49
Plot 88. Conducted Spurious Emissions, 802.11n 40 MHz, 2452 MHz, 30 MHz – 25 GHz, Port 2	49

Plot 89. Conducted Band Edge, 802.11b 20 MHz, Low Channel, Port 1	50
Plot 90. Conducted Band Edge, 802.11b 20 MHz, High Channel, Port 1	50
Plot 91. Conducted Band Edge, 802.11g 20 MHz, Low Channel, Port 1	50
Plot 92. Conducted Band Edge, 802.11g 20 MHz, High Channel, Port 1	51
Plot 93. Conducted Band Edge, 802.11n 20 MHz, Low Channel, Port 1	51
Plot 94. Conducted Band Edge, 802.11n 20 MHz, High Channel, Port 1	51
Plot 95. Conducted Band Edge, 802.11n 40 MHz, Low Channel, Port 1	52
Plot 96. Conducted Band Edge, 802.11n 40 MHz, High Channel, Port 1	52
Plot 97. Conducted Band Edge, 802.11b 20 MHz, Low Channel, Port 2	53
Plot 98. Conducted Band Edge, 802.11b 20 MHz, High Channel, Port 2	53
Plot 99. Conducted Band Edge, 802.11g 20 MHz, Low Channel, Port 2	53
Plot 100. Conducted Band Edge, 802.11g 20 MHz, High Channel, Port 2	54
Plot 101. Conducted Band Edge, 802.11n 20 MHz, Low Channel, Port 2	54
Plot 102. Conducted Band Edge, 802.11n 20 MHz, High Channel, Port 2	54
Plot 103. Conducted Band Edge, 802.11n 40 MHz, Low Channel, Port 2	55
Plot 104. Conducted Band Edge, 802.11n 40 MHz, High Channel, Port 2	55

List of Figures

Figure 1. Block Diagram of Test Configuration	6
Figure 2. Block Diagram, Occupied Bandwidth Test Setup	13
Figure 3. Peak Power Output Test Setup	21
Figure 4. Block Diagram, Conducted Spurious Emissions Test Setup	41
Figure 5. Block Diagram, Peak Power Spectral Density Test Setup	56

List of Terms and Abbreviations

AC	Alternating Current
ACF	Antenna Correction Factor
Cal	Calibration
<i>d</i>	Measurement Distance
dB	Decibels
dB μ A	Decibels above one microamp
dB μ V	Decibels above one microvolt
dB μ A/m	Decibels above one microamp per meter
dB μ V/m	Decibels above one microvolt per meter
DC	Direct Current
E	Electric Field
DSL	Digital Subscriber Line
ESD	Electrostatic Discharge
EUT	Equipment Under Test
<i>f</i>	Frequency
FCC	Federal Communications Commission
GRP	Ground Reference Plane
H	Magnetic Field
HCP	Horizontal Coupling Plane
Hz	Hertz
IEC	International Electrotechnical Commission
kHz	kilohertz
kPa	kilopascal
kV	kilovolt
LISN	Line Impedance Stabilization Network
MHz	Megahertz
μ H	microhenry
μ	microfarad
μ s	microseconds
NEBS	Network Equipment-Building System
PRF	Pulse Repetition Frequency
RF	Radio Frequency
RMS	Root-Mean-Square
TWT	Traveling Wave Tube
V/m	Volts per meter
VCP	Vertical Coupling Plane

I. Executive Summary

A. Purpose of Test

An EMC evaluation was performed to determine compliance of the Airvana Small Cell Type, with the requirements of Part 15, §15.247. All references are to the most current version of Title 47 of the Code of Federal Regulations in effect. In accordance with §2.1033, the following data is presented in support of the Certification of the Small Cell Type. Airvana should retain a copy of this document which should be kept on file for at least two years after the manufacturing of the Small Cell Type, has been **permanently** discontinued.

B. Executive Summary

The following tests were conducted on a sample of the equipment for the purpose of demonstrating compliance with Part 15, §15.247, in accordance with Airvana, purchase order number 52229. All tests were conducted using measurement procedure ANSI C63.4-2003.

FCC Reference 47 CFR Part 15.247:2005	Description	Compliance
Title 47 of the CFR, Part 15 §15.203	Antenna Requirement	Compliant
Title 47 of the CFR, Part 15 §15.207(a)	Conducted Emission Limits	Compliant
Title 47 of the CFR, Part 15 §15.247(a)(2)	6dB Occupied Bandwidth	Compliant
Title 47 of the CFR, Part 15 §15.247(b)	Peak Power Output	Compliant
Title 47 of the CFR, Part 15 §15.247(d); §15.209; §15.205	Radiated Spurious Emissions Requirements	Compliant
Title 47 of the CFR, Part 15 §15.247(d)	RF Conducted Spurious Emissions Requirements	Compliant
Title 47 of the CFR, Part 15 §15.247(d)	RF Conducted Band Edge	Compliant
Title 47 of the CFR, Part 15; §15.247(e)	Peak Power Spectral Density	Compliant
Title 47 of the CFR, Part 15 §15.247(i)	Maximum Permissible Exposure (MPE)	Compliant

Table 1. Executive Summary of EMC Part 15.247 Compliance Testing

II. Equipment Configuration

A. Overview

MET Laboratories, Inc. was contracted by Airvana to perform testing on the Small Cell Type, under Airvana's purchase order number 52229.

This document describes the test setups, test methods, required test equipment, and the test limit criteria used to perform compliance testing of the Airvana, Small Cell Type.

The results obtained relate only to the item(s) tested.

Model(s) Tested:	Small Cell Type	
Model(s) Covered:	Small Cell Type	
EUT Specifications:	Primary Power: 120vac 60Hz	
	FCC ID: QHY-S1000-RP	
	Type of Modulations:	OFDM
	Equipment Code:	DTS
	Peak RF Output Power:	27.25dBm
	EUT Frequency Ranges:	2412-2462MHz
Analysis:	The results obtained relate only to the item(s) tested.	
Environmental Test Conditions:	Temperature: 15-35° C	
	Relative Humidity: 30-60%	
	Barometric Pressure: 860-1060 mbar	
Evaluated by:	Benjamin Taylor	
Report Date(s):	July 14, 2015	

Table 2. EUT Summary Table

B. References

CFR 47, Part 15, Subpart C	Federal Communication Commission, Code of Federal Regulations, Title 47, Part 15: General Rules and Regulations, Allocation, Assignment, and Use of Radio Frequencies
ANSI C63.4:2003	Methods and Measurements of Radio-Noise Emissions from Low-Voltage Electrical And Electronic Equipment in the Range of 9 kHz to 40 GHz
ISO/IEC 17025:2005	General Requirements for the Competence of Testing and Calibration Laboratories
ANSI C63.10-2009	American National Standard for Testing Unlicensed Wireless Devices

Table 3. References

C. Test Site

All testing was performed at MET Laboratories, Inc., 914 W. Patapsco Ave., Baltimore, MD 21230. All equipment used in making physical determinations is accurate and bears recent traceability to the National Institute of Standards and Technology.

Radiated Emissions measurements were performed in a 10 meter semi-anechoic chamber (equivalent to an Open Area Test Site). In accordance with §2.948(a)(3), a complete site description is contained at MET Laboratories.

D. Description of Test Sample

The Airvana Small Cell Type, Equipment Under Test (EUT), is a small cell intended for small to medium size business and residential application.

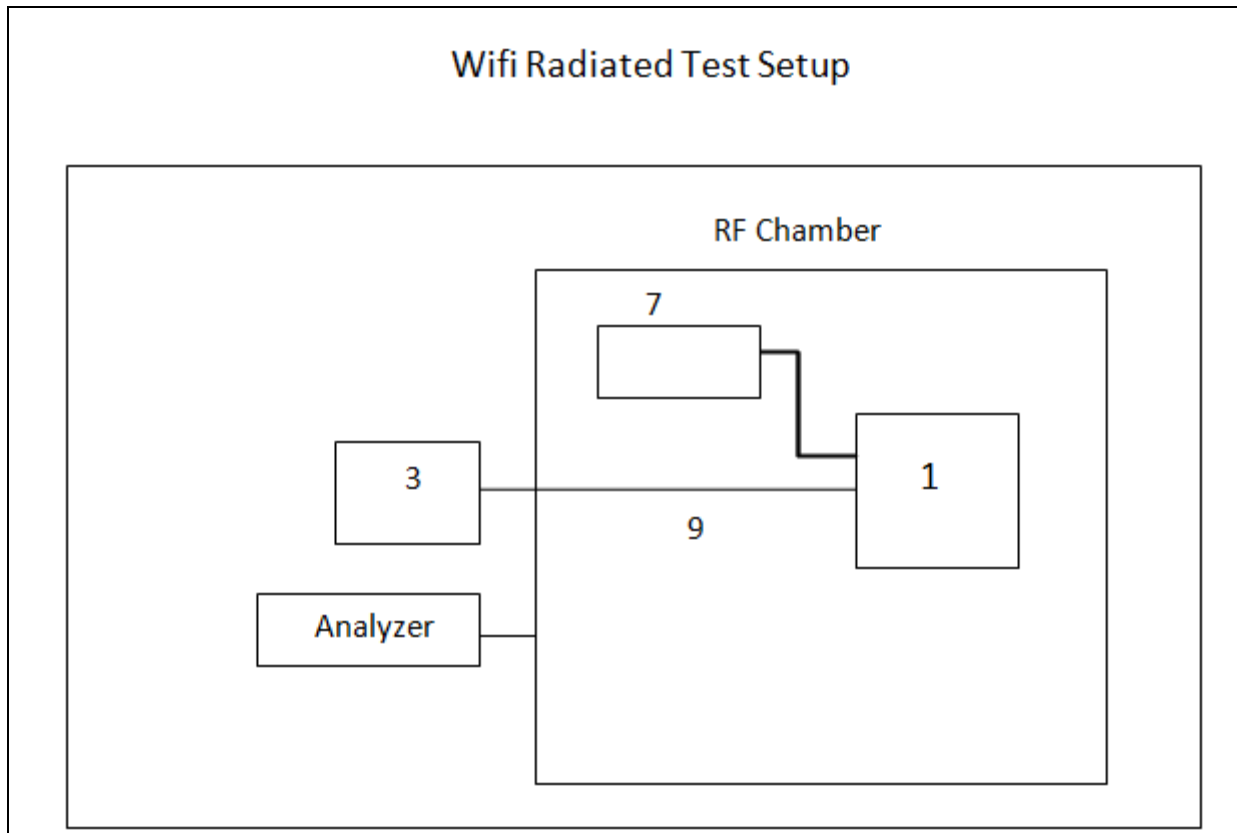

Figure 1. Block Diagram of Test Configuration

E. Equipment Configuration

The EUT was set up as outlined in Figure 1, Block Diagram of Test Setup. All cards, racks, etc., incorporated as part of the EUT is included in the following list.

Ref. ID	Name / Description	Model Number	Part Number	Serial Number	Revision
1	NSC	--	800238	15046000032	--
7	MLF AC Adapter	--	(MLF -A0030120250000051)	--	--

Table 4. Equipment Configuration

F. Support Equipment

Support equipment necessary for the operation and testing of the EUT is included in the following list.

Ref. ID	Name / Description	Manufacturer	Model Number
3	Laptop (Airvana 02682)	Dell	Latitude 6410
4	Laptop (NTQALAPXP2)	Dell	Vostro 1510
5	AC Adapter for Dell Latitude 6410	Dell	DA130PE1-00
6	AC Adapter for Dell Vostro 1510	Dell	DA90PM130

Table 5. Support Equipment

G. Ports and Cabling Information

Ref. ID	Port Name on EUT	Cable Description	Qty.	Length (m)	Shielded (Y/N)	Termination Point
8	Power Port (J10)	--	1	--	--	--
9	Ethernet Port (J1204/5)	--	2	--	--	--
10	Console Port (J1323)	--	1	--	--	--

Table 6. Ports and Cabling Information

H. Mode of Operation

2.4GHz - transmitter modes of operation supported:

1. 802.11 b (22MHz BW – CCK modulation)
2. 802.11g (20MHz BW – OFDM modulation)
3. 802.11 n (20 and 40MHz bandwidth, OFDM modulation)

5 GHz

1. 802.11n (20 and 40MHz bandwidth OFDM modulation)
2. 802.11ac (20, 40 and 80MHz bandwidths – BPSK, QPSK, 16QAM, 64QAM, 256QAM modulation)
3. DFS supported

Band 41 licensed spectrum LTE – Not being tested.

EMC testing is not being done.

I. Method of Monitoring EUT Operation

1. ART has software to support all operating modes. Console port access to laptops is supplied with scripts to set and monitor modes.
2. Same as above. Software will be monitored.

J. Modifications

a) Modifications to EUT

No modifications were made to the EUT.

b) Modifications to Test Standard

No modifications were made to the test standard.

K. Disposition of EUT

The test sample including all support equipment submitted to the Electro-Magnetic Compatibility Lab for testing was returned to Airvana upon completion of testing.

III. Electromagnetic Compatibility Criteria for Intentional Radiators

Electromagnetic Compatibility Criteria for Intentional Radiators

§ 15.203 Antenna Requirement

Test Requirement: § 15.203: An intentional radiator shall be designed to ensure that no antenna other than that furnished by the responsible party shall be used with the device. The use of a permanently attached antenna or of an antenna that uses a unique coupling to the intentional radiator shall be considered sufficient to comply with the provisions of this section. The manufacturer may design the unit so that a broken antenna can be replaced by the user, but the use of a standard antenna jack or electrical connector is prohibited.

The structure and application of the EUT were analyzed to determine compliance with Section 15.203 of the Rules. Section 15.203 states that the subject device must meet at least one of the following criteria:

- a.) Antenna must be permanently attached to the unit.
- b.) Antenna must use a unique type of connector to attach to the EUT.
- c.) Unit must be professionally installed. Installer shall be responsible for verifying that the correct antenna is employed with the unit.

Results: The EUT as tested is compliant the criteria of §15.203. The EUT employs an integral antenna.

Test Engineer(s): Benjamin Taylor

Test Date(s): 03/31/15

Electromagnetic Compatibility Criteria for Intentional Radiators

§ 15.207(a) Conducted Emissions Limits

Test Requirement(s): § 15.207 (a): For an intentional radiator that is designed to be connected to the public utility (AC) power line, the radio frequency voltage that is conducted back onto the AC power line on any frequency or frequencies, within the band 150 kHz to 30MHz, shall not exceed the limits in the following table, as measured using a 50 μ H/50 Σ line impedance stabilization network (LISN). Compliance with the provisions of this paragraph shall be based on the measurement of the radio frequency voltage between each power line and ground at the power terminal. The lower limit applies at the boundary between the frequency ranges.

Frequency range (MHz)	§ 15.207(a), Conducted Limit (dB μ V)	
	Quasi-Peak	Average
* 0.15- 0.45	66 – 56	56 - 46
0.45 - 0.5	56	46
0.5 - 30	60	50

Table 7. Conducted Limits for Intentional Radiators from FCC Part 15 § 15.207(a)

Test Procedure: The EUT was placed on a 0.8 m-high wooden table inside a screen room. The EUT was situated such that the back of the EUT was 0.4 m from one wall of the vertical ground plane, and the remaining sides of the EUT were no closer than 0.8 m from any other conductive surface. The EUT was powered from a 50 Ω /50 μ H Line Impedance Stabilization Network (LISN). The EMC receiver scanned the frequency range from 150 kHz to 30 MHz. Conducted Emissions measurements were made in accordance with *ANSI C63.4-2003 "Methods and Measurements of Radio-Noise Emissions from Low-Voltage Electrical and Electronic Equipment in the Range of 9kHz to 40 GHz"*. The measurements were performed over the frequency range of 0.15 MHz to 30 MHz using a 50 Ω /50 μ H LISN as the input transducer to an EMC/field intensity meter. For the purpose of this testing, the transmitter was turned on. Scans were performed with the transmitter on.

Test Results: The EUT was compliant with this requirement.

Test Engineer(s): Benjamin Taylor

Test Date(s): 05/01/15

15.207(a) Conducted Emissions Test Results

Frequency (MHz)	Uncorrected Meter Reading (dB μ V) QP	Cable Loss (dB)	Corrected Measurement (dB μ V) QP	Limit (dB μ V) QP	Margin (dB) QP	Uncorrected Meter Reading (dB μ V) Avg.	Cable Loss (dB)	Corrected Measurement (dB μ V) AVG	Limit (dB μ V) AVG	Margin (dB) AVG
0.248	43.61	0	43.61	79	-35.39	38.98	0	38.98	66	-27.02
0.441	45.19	0	45.19	79	-33.81	43.24	0	43.24	66	-22.76
0.559	49.51	0	49.51	73	-23.49	42.56	0	42.56	60	-17.44
1.32	48.68	0	48.68	73	-24.32	40.91	0	40.91	60	-19.09
5.67	49.12	0.17	49.29	73	-23.71	43.95	0.17	44.12	60	-15.88
11.91	50.5	0.17	50.67	73	-22.33	44.17	0.17	44.34	60	-15.66

Table 8. Conducted Emissions, 15.207(a), Phase Line, Test Results

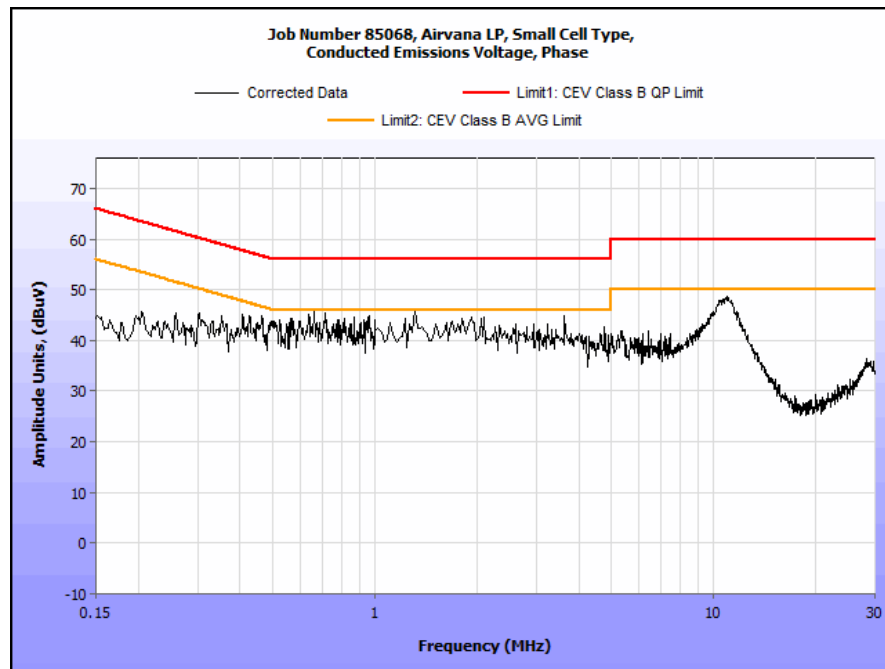

Plot 1. Conducted Emissions, 15.207(a), Phase Line

15.207(a) Conducted Emissions Test Results

Frequency (MHz)	Uncorrected Meter Reading (dB μ V) QP	Cable Loss (dB)	Corrected Measurement (dB μ V) QP	Limit (dB μ V) QP	Margin (dB) QP	Uncorrected Meter Reading (dB μ V) Avg.	Cable Loss (dB)	Corrected Measurement (dB μ V) AVG	Limit (dB μ V) AVG	Margin (dB) AVG
0.249	42.56	0	42.56	79	-36.44	39.45	0	39.45	66	-26.55
0.339	46.18	0	46.18	79	-32.82	42.34	0	42.34	66	-23.66
0.541	48.65	0	48.65	73	-24.35	41.57	0	41.57	60	-18.43
1.29	49.63	0	49.63	73	-23.37	41.54	0	41.54	60	-18.46
5.68	48.6	0.17	48.77	73	-24.23	41.6	0.17	41.77	60	-18.23
11.99	49.66	0.17	49.83	73	-23.17	45.45	0.17	45.62	60	-14.38

Table 9. Conducted Emissions, 15.207(a), Neutral Line, Test Results

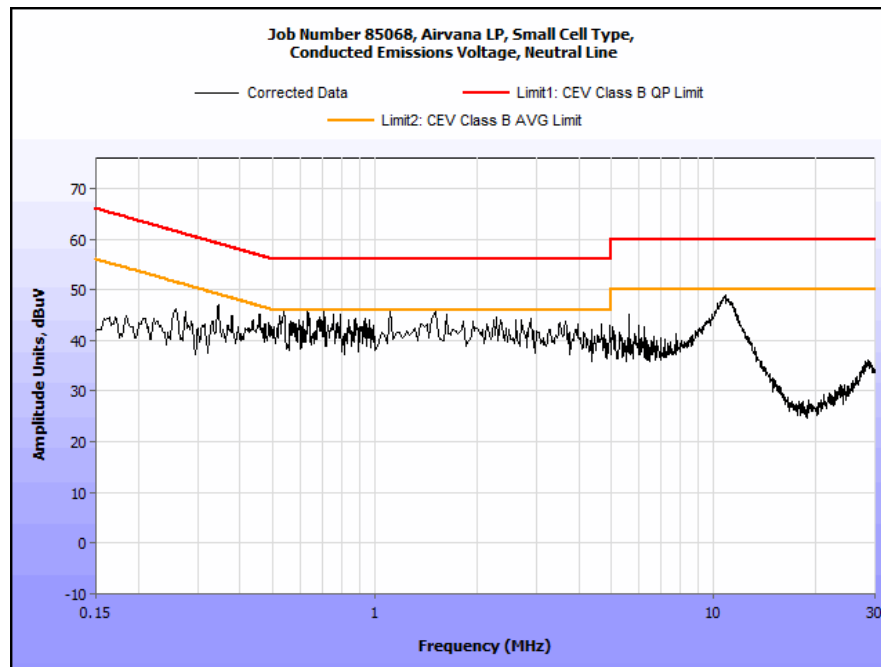

Plot 2. Conducted Emissions, 15.207(a), Neutral Line

Electromagnetic Compatibility Criteria for Intentional Radiators

§ 15.247(a)(2) 6 dB Occupied Bandwidth

Test Requirements: § 15.247(a)(2): Operation under the provisions of this section is limited to frequency hopping and digitally modulated intentional radiators that comply with the following provisions:

For systems using digital modulation techniques, the EUT may operate in the 902-928 MHz, 2400-2483.5 MHz and 5725-5850 MHz bands. The minimum 6dB bandwidth shall be at least 500 kHz.

Test Procedure: The transmitter was on and transmitting at the highest output power. The bandwidth of the fundamental frequency was measured with the spectrum analyzer using a RBW approximately 1% of the total emission bandwidth, VBW > RBW. The 6 dB Bandwidth was measured and recorded. The measurements were performed on the low, mid and high channels.

Test Results The EUT was compliant with § 15.247 (a)(2).

The 6 dB Occupied Bandwidth was determined from the plots on the following pages.

Test Engineer(s): Benjamin Taylor

Test Date(s): 05/01/15

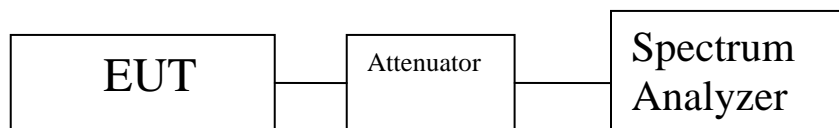
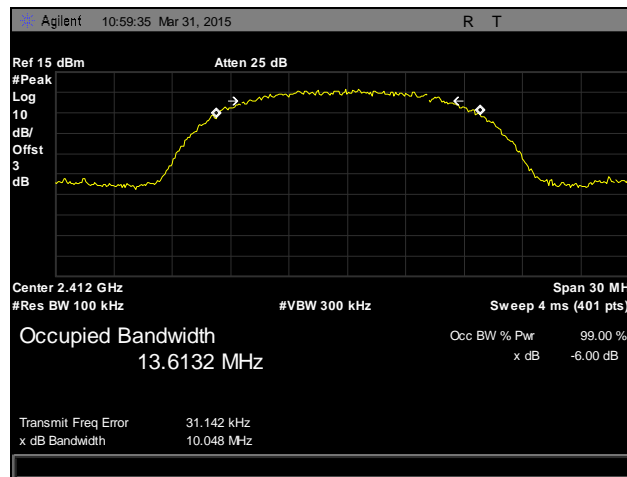

Figure 2. Block Diagram, Occupied Bandwidth Test Setup

Occupied Bandwidth		
Carrier Channel Mode	Frequency (MHz)	Measured 6 dB Bandwidth (MHz)
802.11b	2412	10.048
802.11b	2442	10.084
802.11b	2462	9.917
802.11g	2412	16.520
802.11g	2442	16.483
802.11g	2462	16.517
802.11n HT20 Port 1	2412	17.739
802.11n HT20 Port 1	2442	17.667
802.11n HT20 Port 1	2462	17.662
802.11n HT40 Port1	2422	35.936
802.11n HT40 Port1	2442	36.449
802.11n HT40 Port1	2452	36.481
802.11n HT20 Port 2	2412	17.661
802.11n HT20 Port 2	2442	17.702
802.11n HT20 Port 2	2462	17.650
802.11n HT40 Port2	2422	36.176
802.11n HT40 Port2	2442	36.505
802.11n HT40 Port2	2452	36.533

Table 10. Occupied Bandwidth, Test Results

Occupied Bandwidth Test Results, MIMO, Port 1



Plot 3. Occupied Bandwidth, 802.11b 20 MHz, Low Channel, MIMO

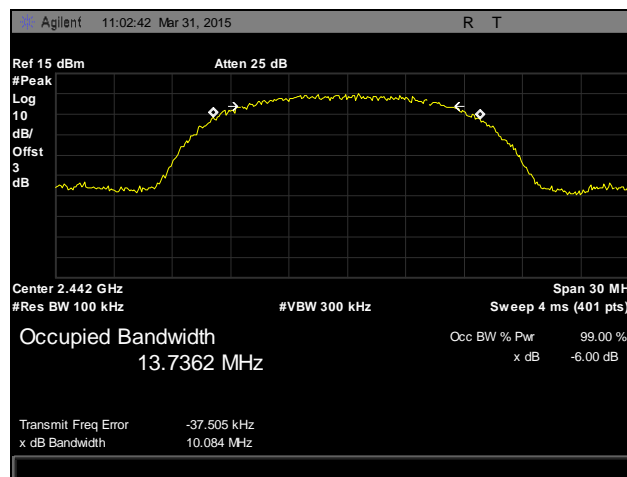

Plot 4. Occupied Bandwidth, 802.11b 20 MHz, Mid Channel, MIMO

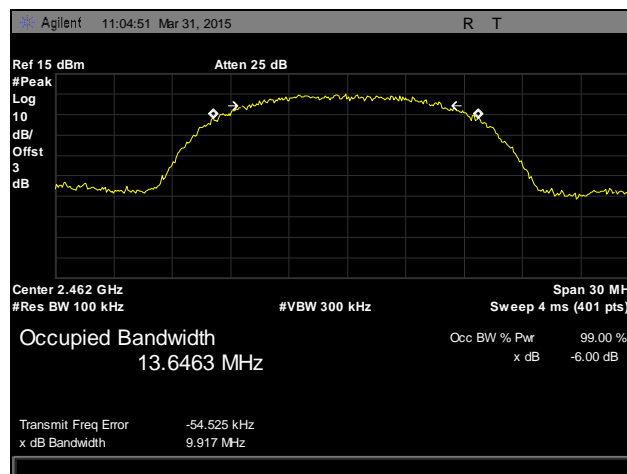

Plot 5. Occupied Bandwidth, 802.11b 20 MHz, High Channel, MIMO

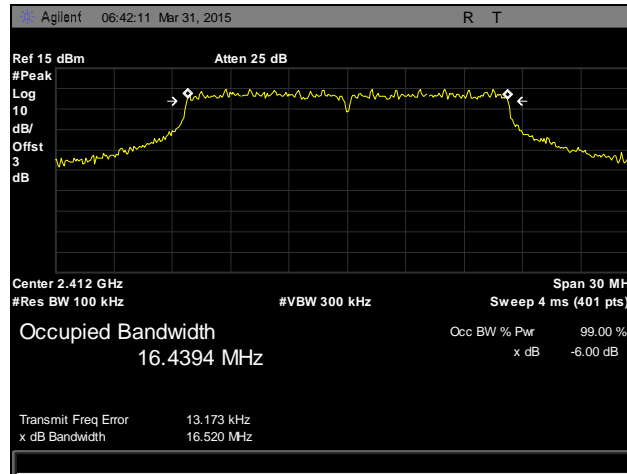

Plot 6. Occupied Bandwidth, 802.11g 20 MHz, Low Channel, MIMO

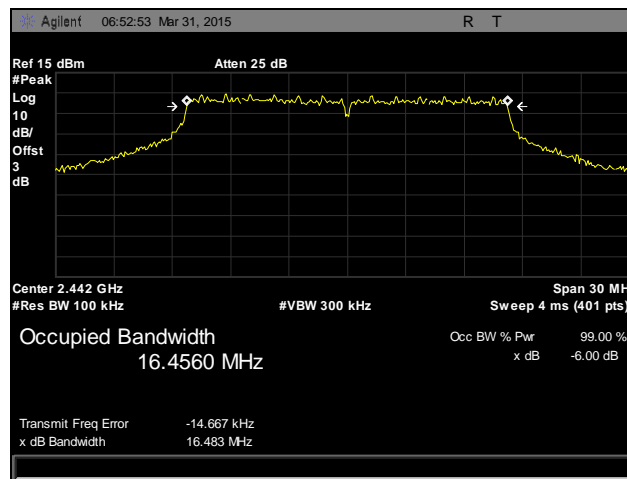

Plot 7. Occupied Bandwidth, 802.11g 20 MHz, Mid Channel, MIMO

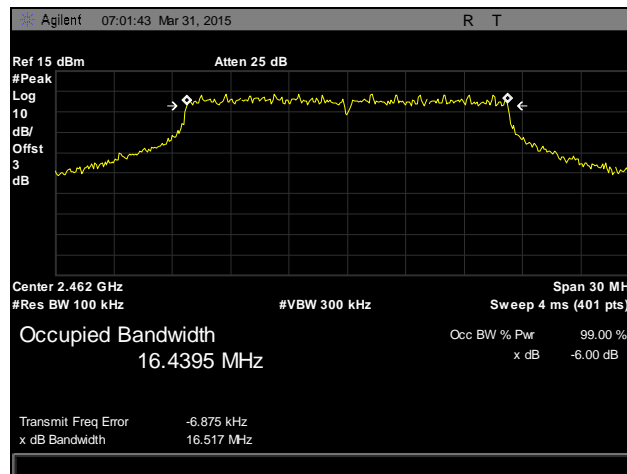

Plot 8. Occupied Bandwidth, 802.11g 20 MHz, High Channel, MIMO

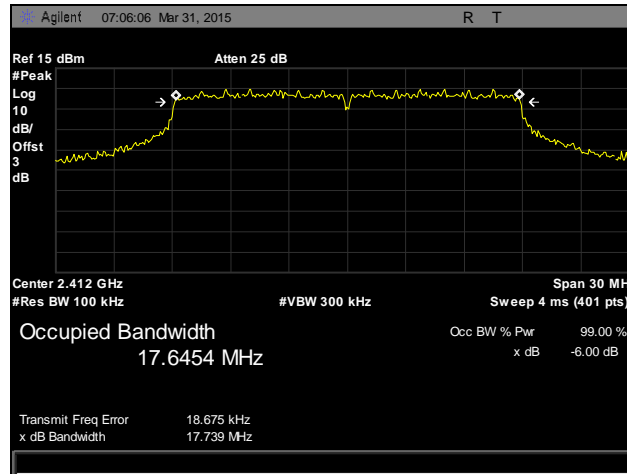

Plot 9. Occupied Bandwidth, 802.11n 20 MHz, Low Channel, MIMO, Port 1

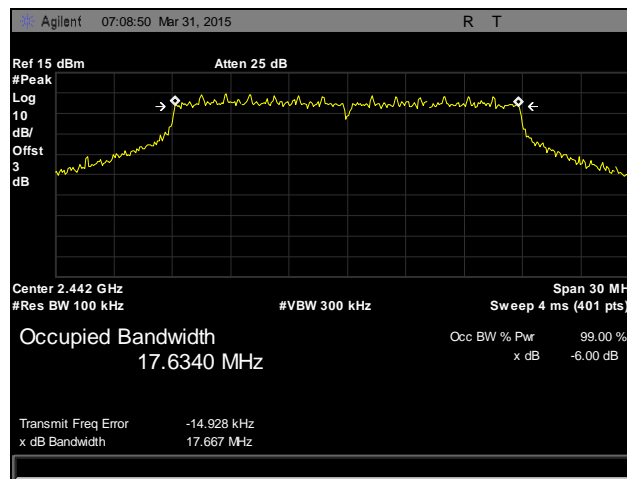

Plot 10. Occupied Bandwidth, 802.11n 20 MHz, Mid Channel, MIMO, Port 1

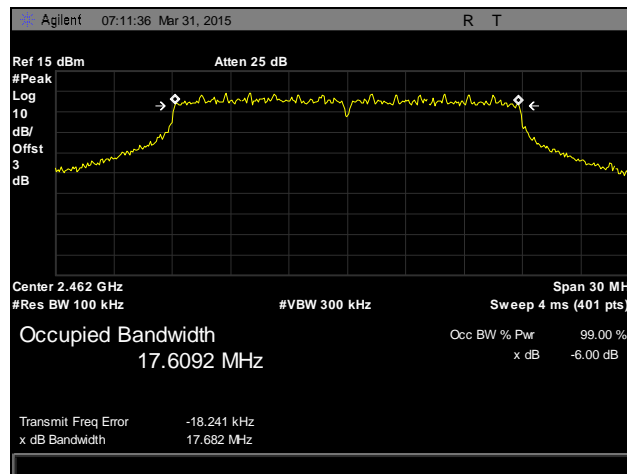

Plot 11. Occupied Bandwidth, 802.11n 20 MHz, High Channel, MIMO, Port 1

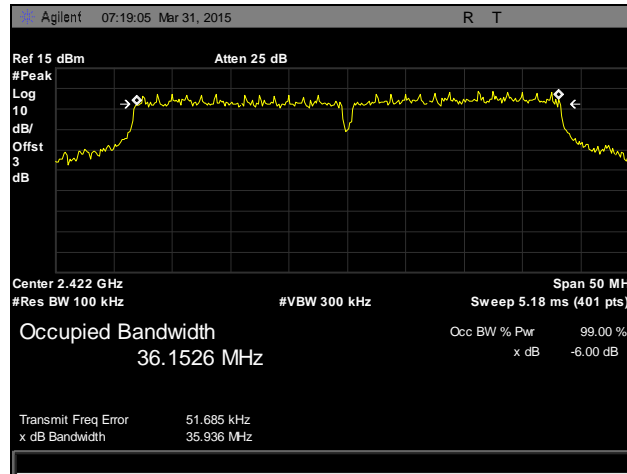

Plot 12. Occupied Bandwidth, 802.11n 40 MHz, Low Channel, MIMO, Port 1

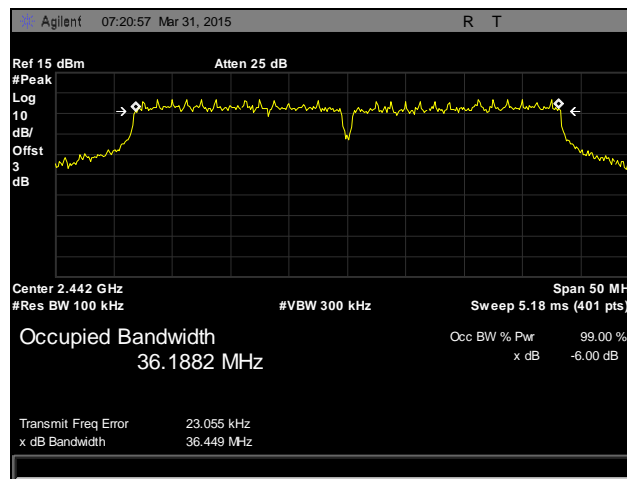

Plot 13. Occupied Bandwidth, 802.11n 40 MHz, Mid Channel, MIMO, Port 1

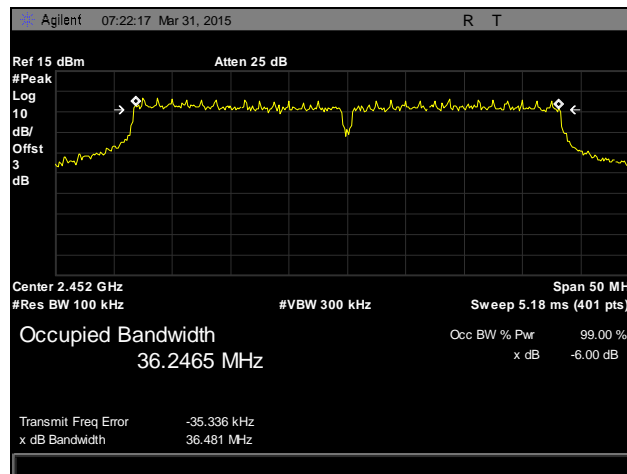

Plot 14. Occupied Bandwidth, 802.11n 40 MHz, High Channel, MIMO, Port 1

Occupied Bandwidth Test Results, MIMO, Port 2

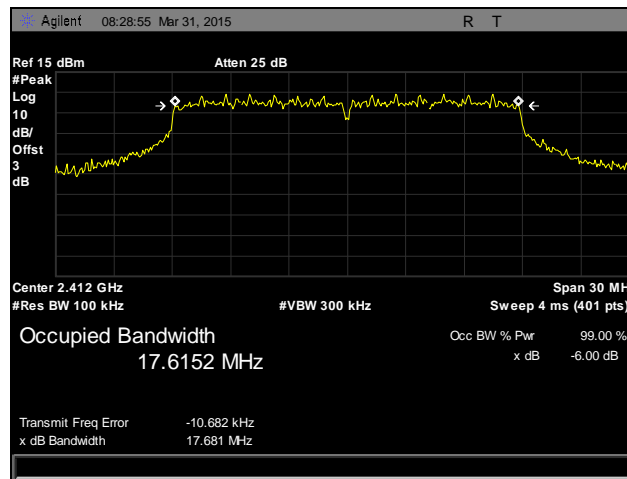

Plot 15. Occupied Bandwidth, 802.11n 20 MHz, Low Channel, MIMO, Port 2

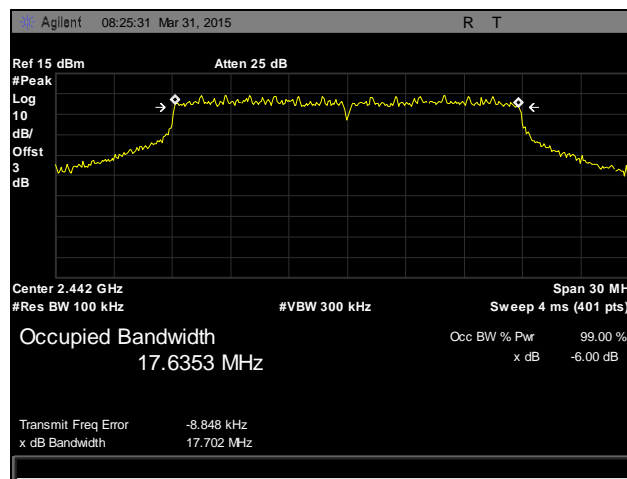

Plot 16. Occupied Bandwidth, 802.11n 20 MHz, Mid Channel, MIMO, Port 2

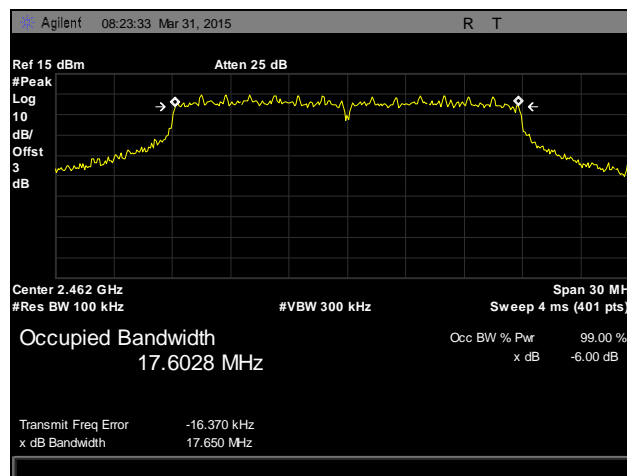

Plot 17. Occupied Bandwidth, 802.11n 20 MHz, High Channel, MIMO, Port 2

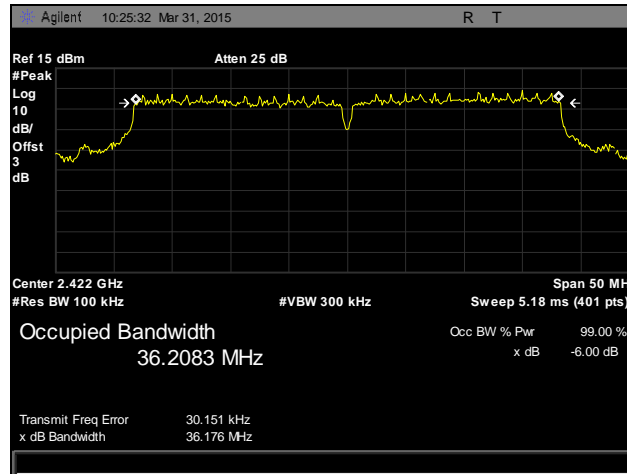

Plot 18. Occupied Bandwidth, 802.11n 40 MHz, Low Channel, MIMO, Port 2

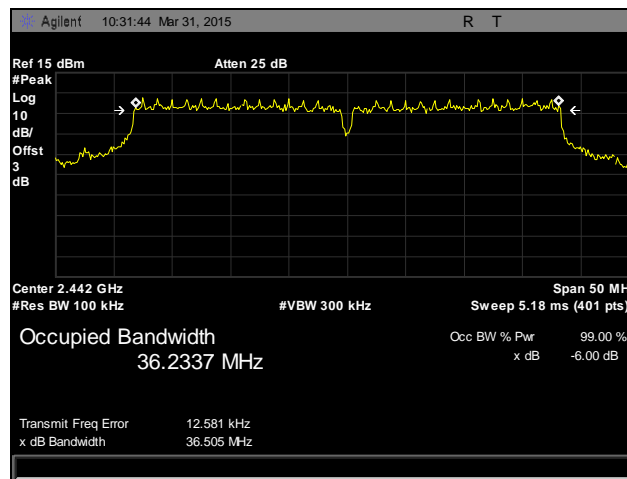

Plot 19. Occupied Bandwidth, 802.11n 40 MHz, Mid Channel, MIMO, Port 2

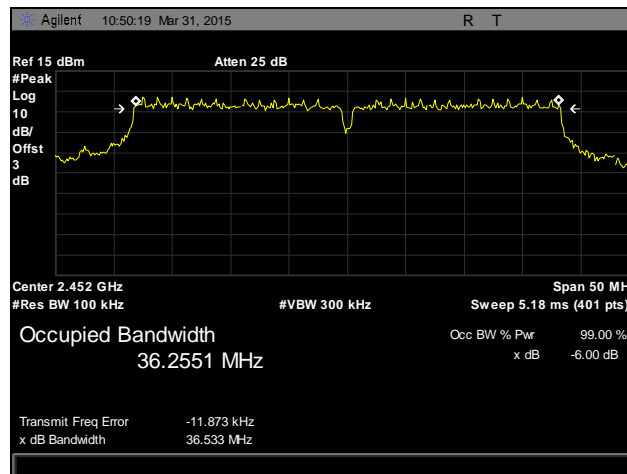

Plot 20. Occupied Bandwidth, 802.11n 40 MHz, High Channel, MIMO, Port 2

Electromagnetic Compatibility Criteria for Intentional Radiators

§ 15.247(b) Peak Power Output

Test Requirements: §15.247(b): The maximum peak output power of the intentional radiator shall not exceed the following:

Digital Transmission Systems (MHz)	Output Limit (Watts)
902-928	1.000
2400-2483.5	1.000
5725- 5850	1.000

Table 11. Output Power Requirements from §15.247(b)

§15.247(b)(4): The conducted output power limit specified in paragraph (b) of this section is based on the use of antennas with directional gains that do not exceed 6 dBi. Except as shown in paragraph (c) of this section, if transmitting antennas of directional gain greater than 6 dBi are used, the conducted output power from the intentional radiator shall be reduced below the stated values in paragraphs (b)(1), (b)(2), and (b)(3) of this section, as appropriate, by the amount in dB that the directional gain of the antenna exceeds 6 dBi.

Test Procedure: The transmitter was connected to a calibrated spectrum analyzer. The EUT was measured at the low, mid and high channels of each band at the maximum power level.

Test Results: The EUT was compliant with the Peak Power Output limits of §15.247(b).

Test Engineer(s): Benjamin Taylor

Test Date(s): 05/05/15

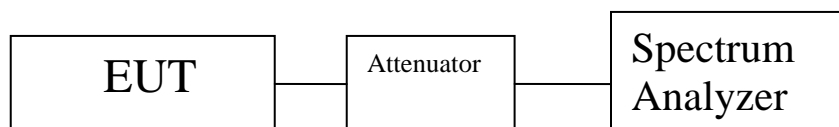

Figure 3. Peak Power Output Test Setup

Peak Conducted Output Power			
	Carrier Channel	Frequency (MHz)	Measured Peak Output Power (dBm)
802.11b	Low	2412	23.77
	Mid	2442	26.73
	High	2462	25
802.11g	Low	2412	18.27
	Mid	2442	26.21
	High	2462	18.24
802.11n 20 MHz Port1	Low	2412	18.75
	Mid	2442	24.42
	High	2462	17.81
802.11n 20 MHz Port2	Low	2412	18.12
	Mid	2442	24.05
	High	2462	16.19
802.11n 40 MHz Port1	Low	2422	14.88
	Mid	2437	23.91
	High	2452	14.43
802.11n 40 MHz Port2	Low	2422	14.05
	Mid	2437	23.11
	High	2452	14.27

Table 12. RF Output Power, Test Results

Summed Conducted Output Power			
	Carrier Channel	Frequency (MHz)	Measured Power (dBm)
802.11n 20 MHz Summed	Low	2412	21.46
	Mid	2437	27.25
	High	2462	20.09
802.11n 40 MHz Summed	Low	2422	17.50
	Mid	2437	26.54
	High	2452	17.36

Table 13. RF Output Power, Test Results, Summed Ports

Electromagnetic Compatibility Criteria for Intentional Radiators

§ 15.209(a) Radiated Spurious Emissions Requirements and Band Edge

Test Requirements: §15.205: Emissions outside the frequency band.

§15.205(a): Except as shown in paragraph (d) of this section, only spurious emissions are permitted in any of the frequency bands listed below:

MHz	MHz	MHz	GHz
0.090–0.110-----	16.42–16.423	399.9–410	4.5–5.15
¹ 0.495–0.505-----	16.69475–16.69525	608–614	5.35–5.46
2.1735–2.1905-----	16.80425–16.80475	960–1240	7.25–7.75
4.125–4.128-----	25.5–25.67	1300–1427	8.025–8.5
4.17725–4.17775-----	37.5–38.25	1435–1626.5	9.0–9.2
4.20725–4.20775-----	73–74.6	1645.5–1646.5	9.3–9.5
6.215–6.218-----	74.8–75.2	1660–1710	10.6–12.7
6.26775–6.26825-----	108–121.94	1718.8–1722.2	13.25–13.4
6.31175–6.31225-----	123–138	2200–2300	14.47–14.5
8.291–8.294-----	149.9–150.05	2310–2390	15.35–16.2
8.362–8.366-----	156.52475–156.52525	2483.5–2500	17.7–21.4
8.37625–8.38675-----	156.7–156.9	2655–2900	22.01–23.12
8.41425–8.41475-----	162.0125–167.17	3260–3267	23.6–24.0
12.29–12.293-----	167.72–173.2	3332–3339	31.2–31.8
12.51975–12.52025-----	240–285	3345.8–3358.36	43–36.5
12.57675–12.57725-----	322–335.4	3600–4400	(²)

Table 14. Restricted Bands of Operation

¹ Until February 1, 1999, this restricted band shall be 0.490 – 0.510 MHz.

² Above 38.6

Test Requirement(s): § 15.209 (a): Except as provided elsewhere in this subpart, the emissions from an intentional radiator shall not exceed the field strength levels specified in Table 15.

Frequency (MHz)	§ 15.209(a), Radiated Emission Limits (dB μ V) @ 3m
30 - 88	40.00
88 - 216	43.50
216 - 960	46.00
Above 960	54.00

Table 15. Radiated Emissions Limits Calculated from FCC Part 15, § 15.209 (a)

Test Procedures: The transmitter was turned on. A 2.4GHz notch filter was use to filter out the transmitting signal. Measurements were performed of the low, mid and high Channels. The EUT was rotated orthogonally through all three axes. Plots shown are corrected for both antenna correction factor and distance and compared to a 3 m limit line. Only noise floor was measured above 18 GHz.

Test Results: The EUT was compliant with the Radiated Spurious Emission limits of § 15.247(d).

Test Engineer(s): Benjamin Taylor

Test Date(s): 05/05/15

Radiated Spurious Emissions

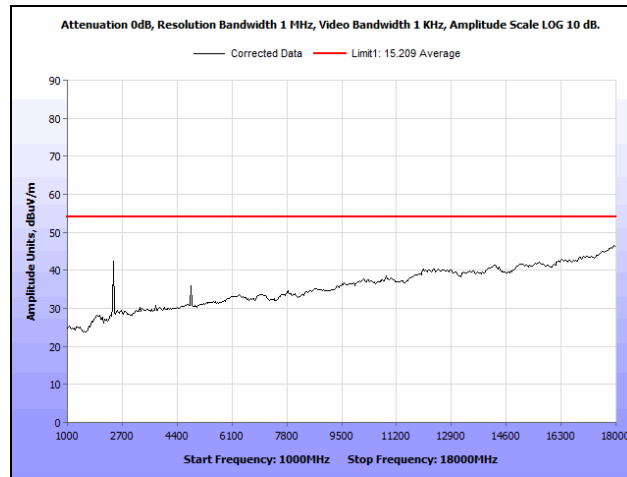

Plot 21. Radiated Spurious Emissions, 802.11b 20 MHz, Low Channel, 2412 MHz, 1 GHz – 18 GHz, Average

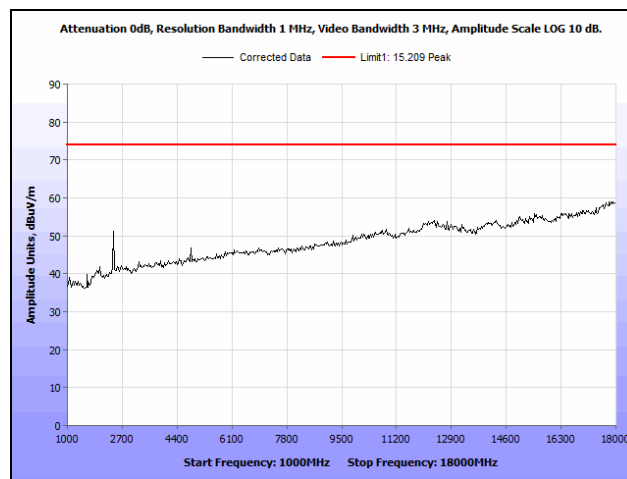

Plot 22. Radiated Spurious Emissions, 802.11b 20 MHz, Low Channel, 2412 MHz, 1 GHz – 18 GHz, Peak

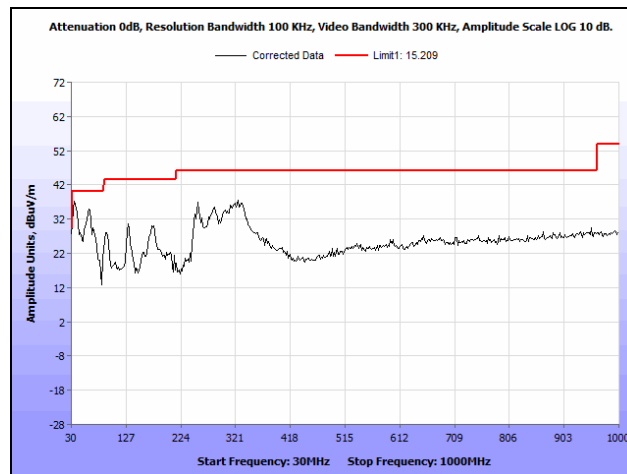

Plot 23. Radiated Spurious Emissions, 802.11b 20 MHz, Mid Channel, 2442 MHz, 30 MHz – 1 GHz

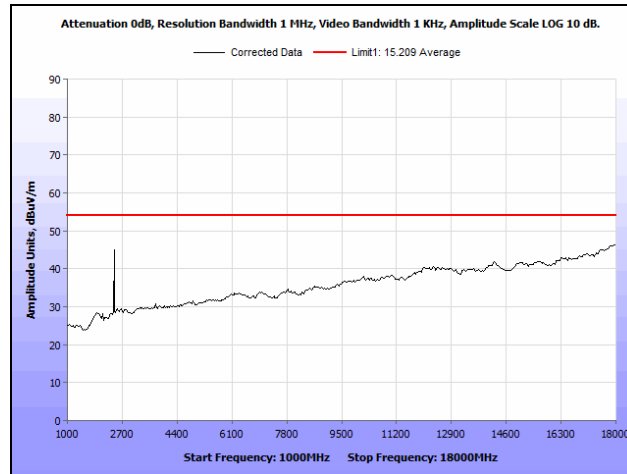

Plot 24. Radiated Spurious Emissions, 802.11b 20 MHz, Mid Channel, 2442 MHz, 1 GHz – 18 GHz, Average

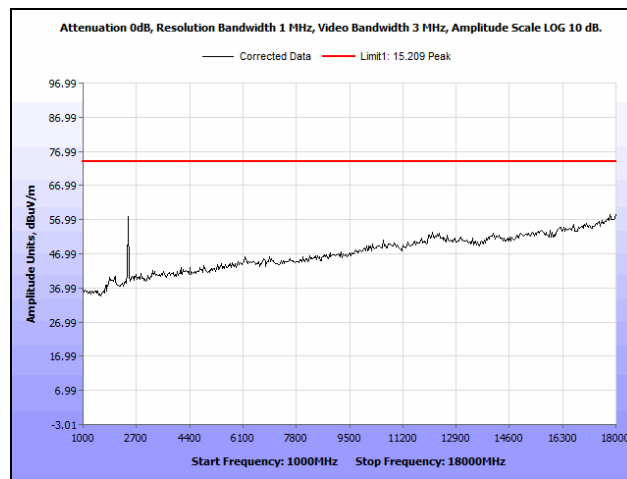

Plot 25. Radiated Spurious Emissions, 802.11b 20 MHz, Mid Channel, 2442 MHz, 1 GHz – 18 GHz, Peak

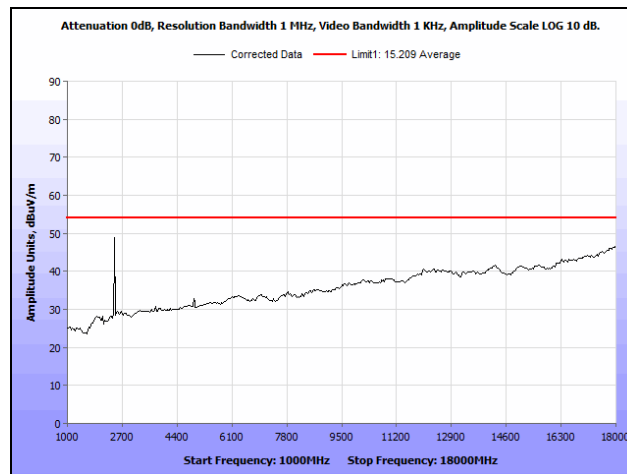

Plot 26. Radiated Spurious Emissions, 802.11b 20 MHz, High Channel, 2462 MHz, 1 GHz – 18 GHz, Average

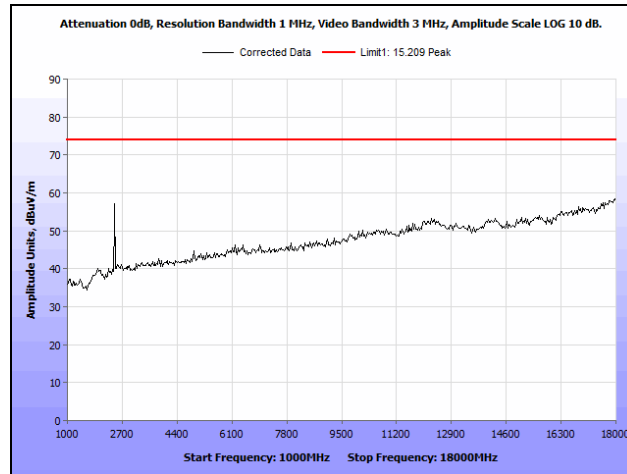

Plot 27. Radiated Spurious Emissions, 802.11b 20 MHz, High Channel, 2462 MHz, 1 GHz – 18 GHz, Peak

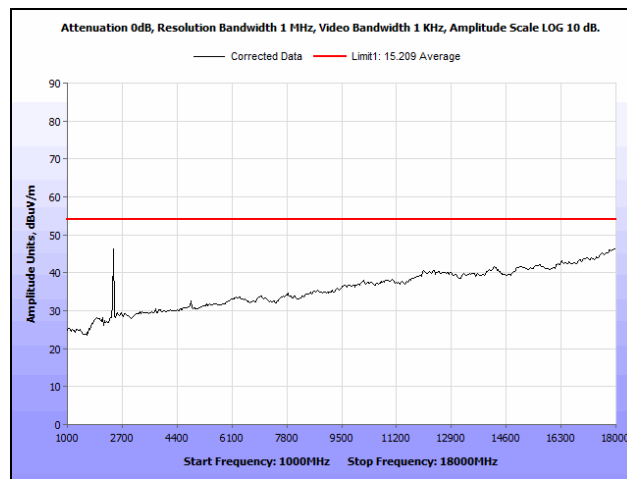

Plot 28. Radiated Spurious Emissions, 802.11g 20 MHz, Low Channel, 2412 MHz, 1 GHz – 18 GHz, Average

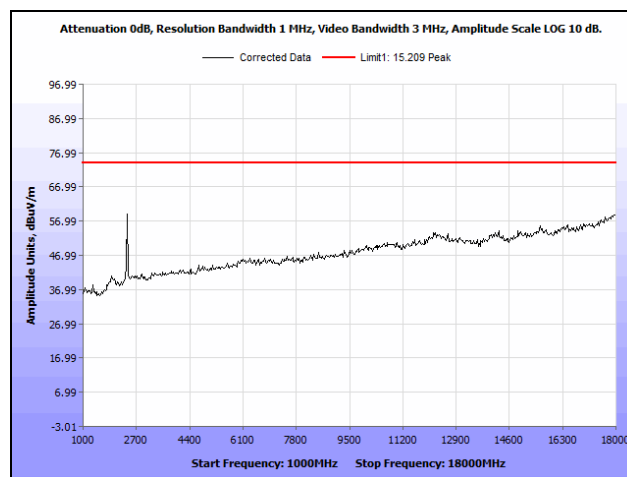

Plot 29. Radiated Spurious Emissions, 802.11g 20 MHz, Low Channel, 2412 MHz, 1 GHz – 18 GHz, Peak

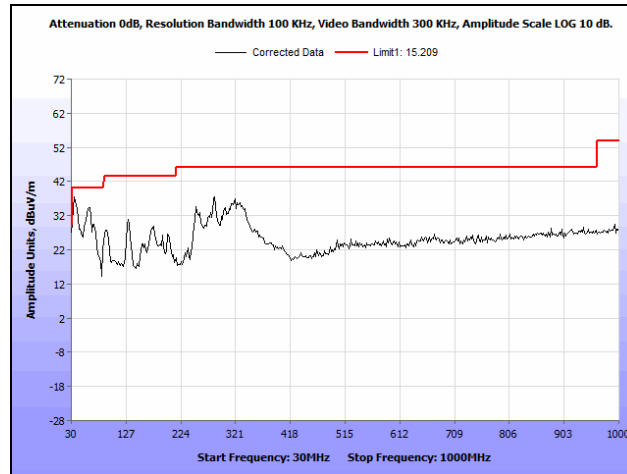

Plot 30. Radiated Spurious Emissions, 802.11g 20 MHz, Mid Channel, 2442 MHz, 30 MHz – 1 GHz

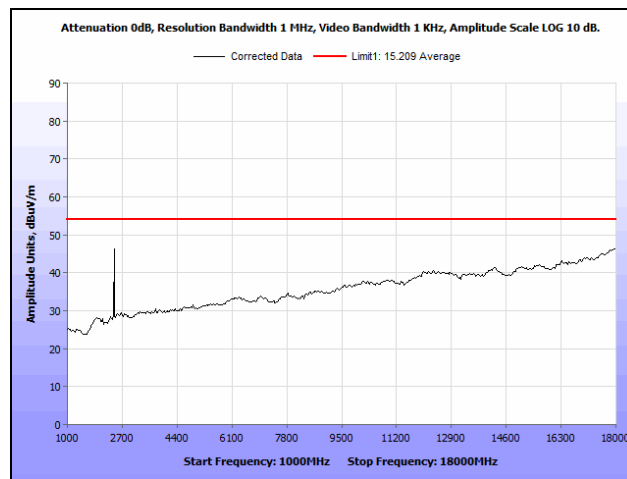

Plot 31. Radiated Spurious Emissions, 802.11g 20 MHz, Mid Channel, 2442 MHz, 1 GHz – 18 GHz, Average

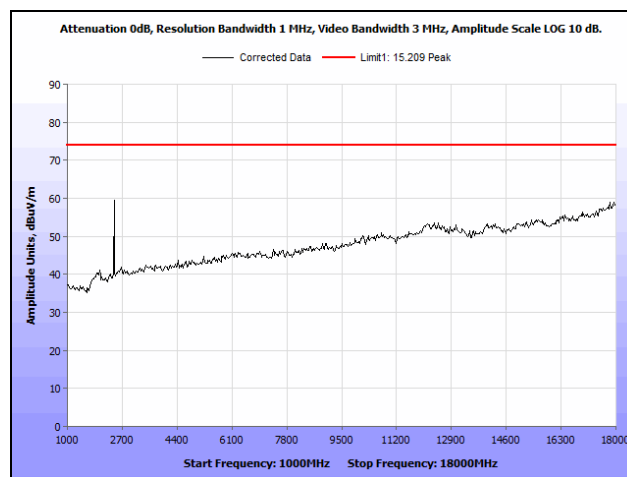

Plot 32. Radiated Spurious Emissions, 802.11g 20 MHz, Mid Channel, 2442 MHz, 1 GHz – 18 GHz, Peak

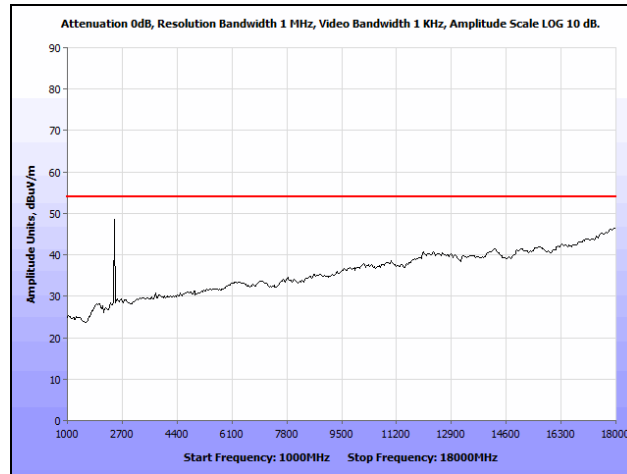

Plot 33. Radiated Spurious Emissions, 802.11g 20 MHz, High Channel, 2462 MHz, 1 GHz – 18 GHz, Average

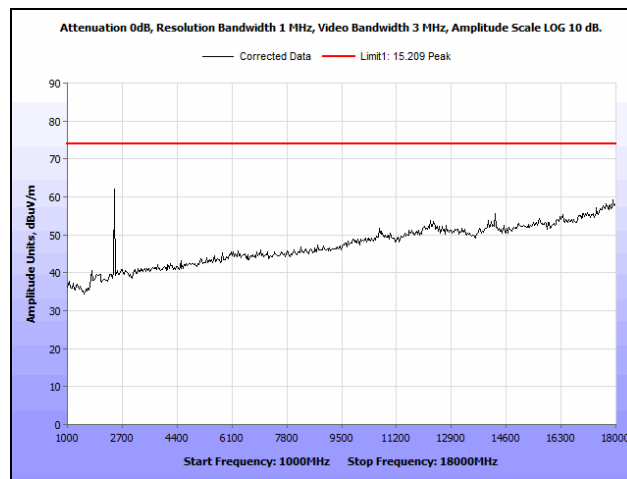

Plot 34. Radiated Spurious Emissions, 802.11g 20 MHz, High Channel, 2462 MHz, 1 GHz – 18 GHz, Peak

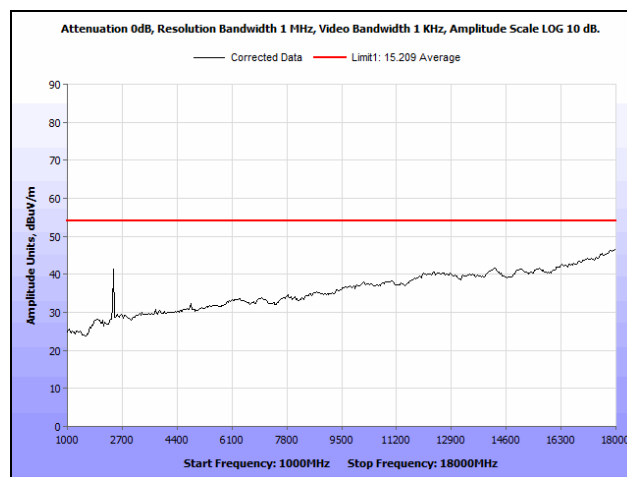

Plot 35. Radiated Spurious Emissions, 802.11n 20 MHz, Low Channel, 2412 MHz, 1 GHz – 18 GHz, Average

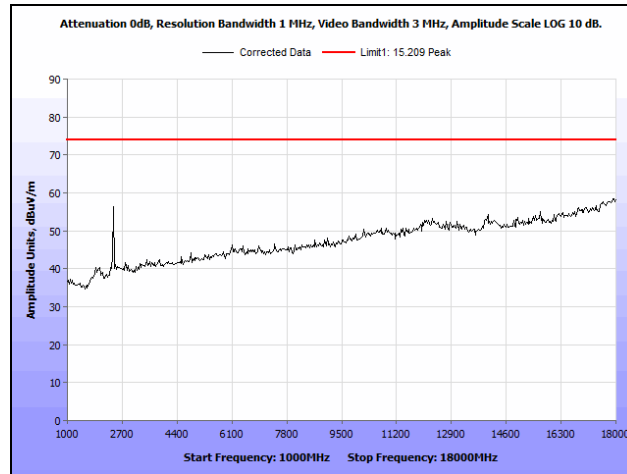

Plot 36. Radiated Spurious Emissions, 802.11n 20 MHz, Low Channel, 2412 MHz, 1 GHz – 18 GHz, Peak

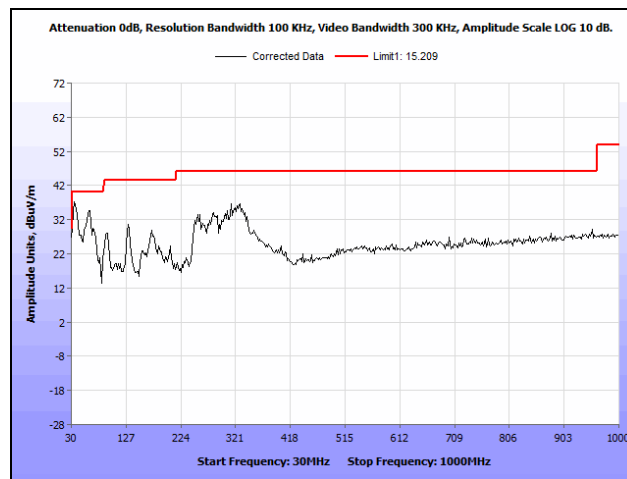

Plot 37. Radiated Spurious Emissions, 802.11n 20 MHz, Mid Channel, 2442 MHz, 30 MHz – 1 GHz

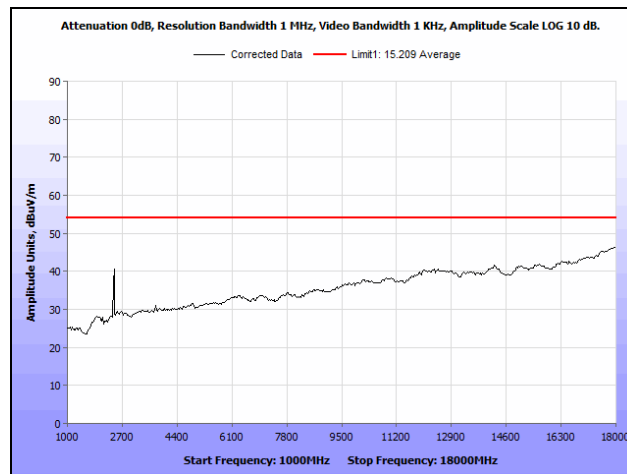

Plot 38. Radiated Spurious Emissions, 802.11n 20 MHz, Mid Channel, 2442 MHz, 1 GHz – 18 GHz, Average

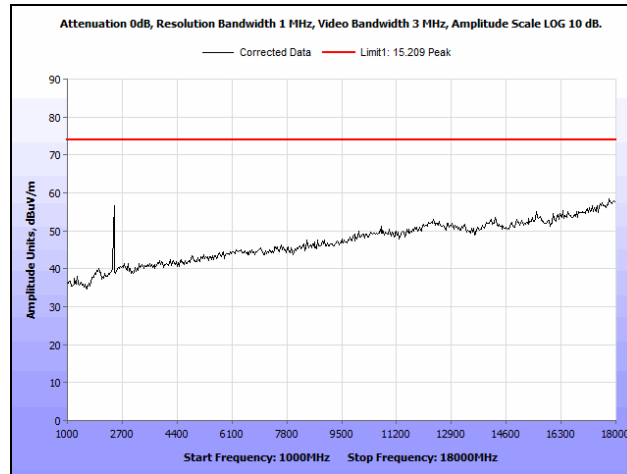

Plot 39. Radiated Spurious Emissions, 802.11n 20 MHz, Mid Channel, 2442 MHz, 1 GHz – 18 GHz, Peak

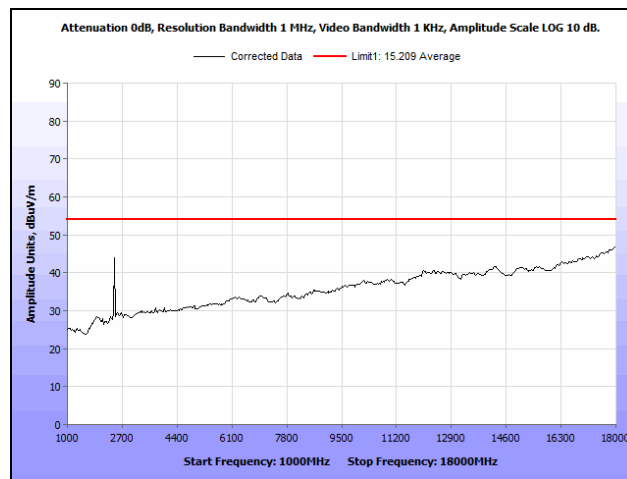

Plot 40. Radiated Spurious Emissions, 802.11n 20 MHz, High Channel, 2462 MHz, 1 GHz – 18 GHz, Average

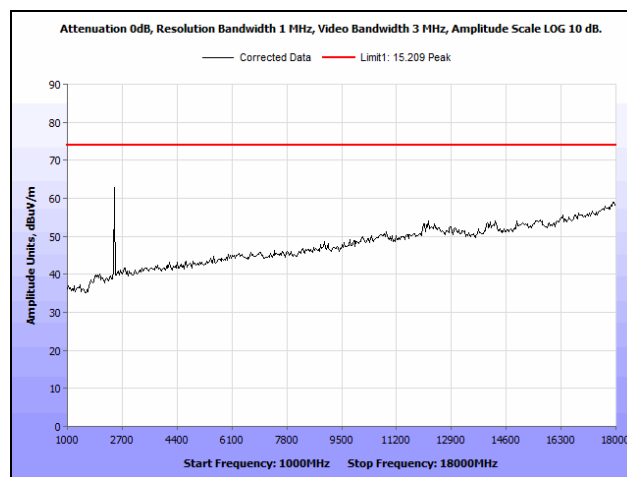

Plot 41. Radiated Spurious Emissions, 802.11n 20 MHz, High Channel, 2462 MHz, 1 GHz – 18 GHz, Peak

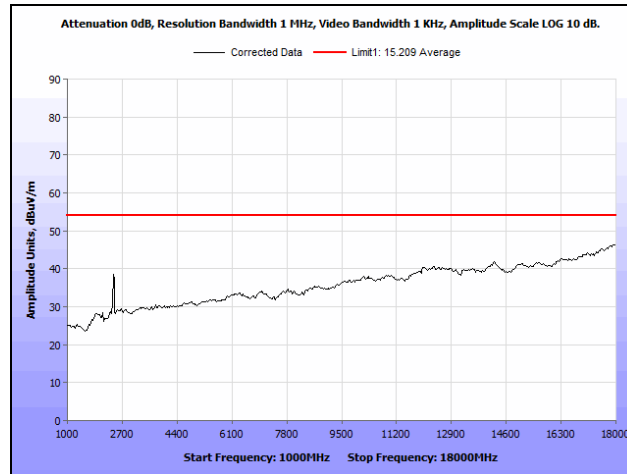

Plot 42. Radiated Spurious Emissions, 802.11n 40 MHz, Low Channel, 2422 MHz, 1 GHz – 18 GHz, Average

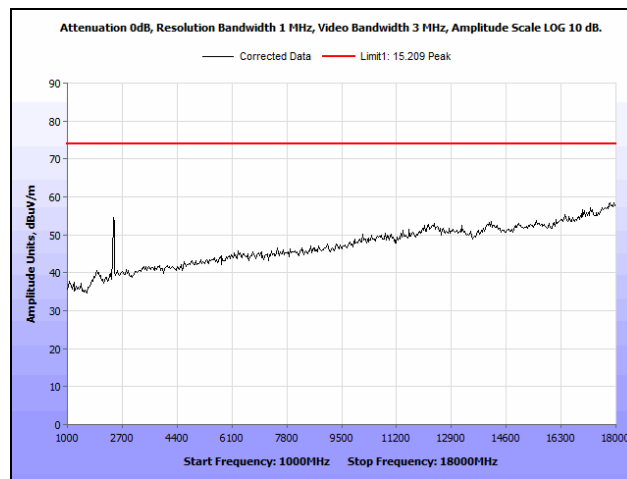

Plot 43. Radiated Spurious Emissions, 802.11n 40 MHz, Low Channel, 2422 MHz, 1 GHz – 18 GHz, Peak

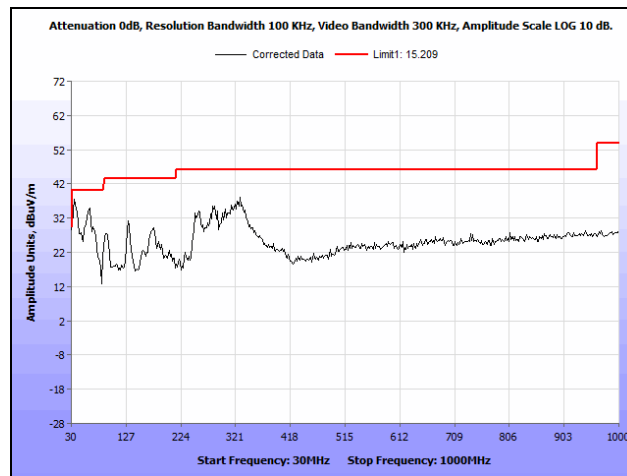

Plot 44. Radiated Spurious Emissions, 802.11n 40 MHz, Mid Channel, 2442 MHz, 30 MHz – 1 GHz

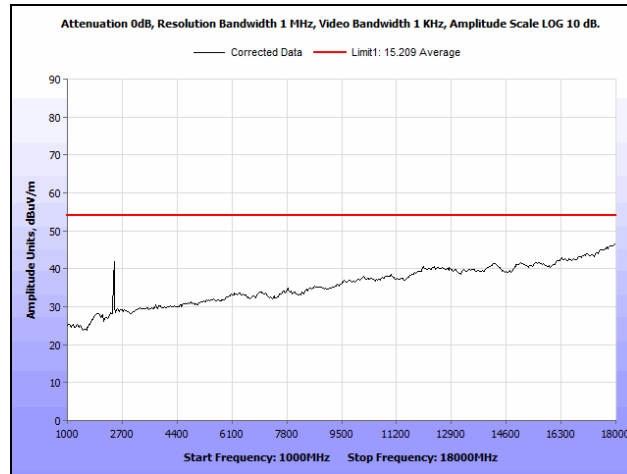

Plot 45. Radiated Spurious Emissions, 802.11n 40 MHz, Mid Channel, 2442 MHz, 1 GHz – 18 GHz, Average

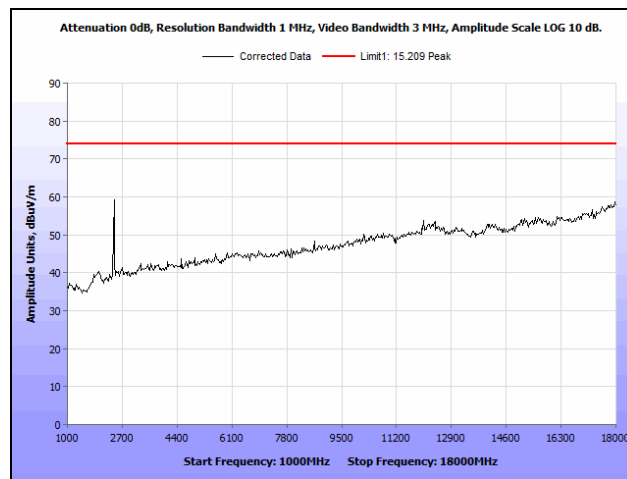

Plot 46. Radiated Spurious Emissions, 802.11n 40 MHz, Mid Channel, 2442 MHz, 1 GHz – 18 GHz, Peak

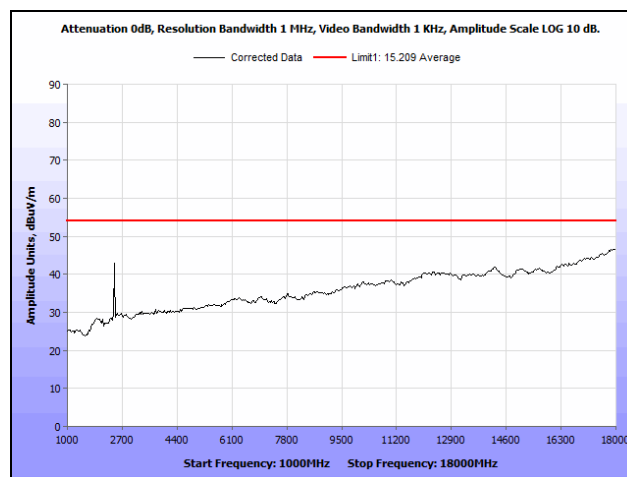

Plot 47. Radiated Spurious Emissions, 802.11n 40 MHz, High Channel, 2452 MHz, 1 GHz – 18 GHz, Average

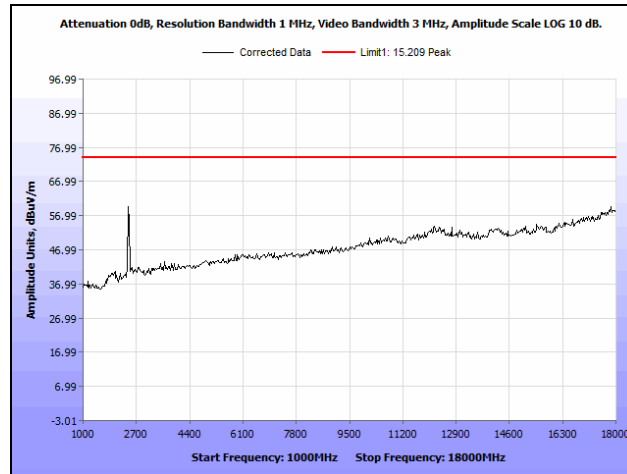

Plot 48. Radiated Spurious Emissions, 802.11n 40 MHz, High Channel, 2452 MHz, 1 GHz – 18 GHz, Peak

Radiated Band Edge

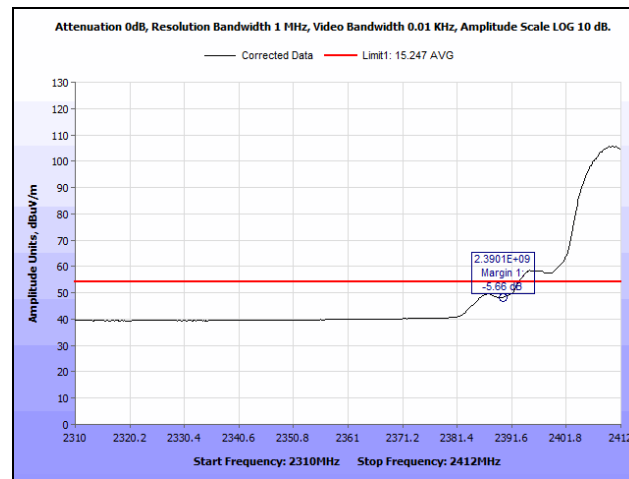

Plot 49. Radiated Band Edge, 802.11b 20 MHz, Low Channel, 2412 MHz @ 2390 MHz, Average

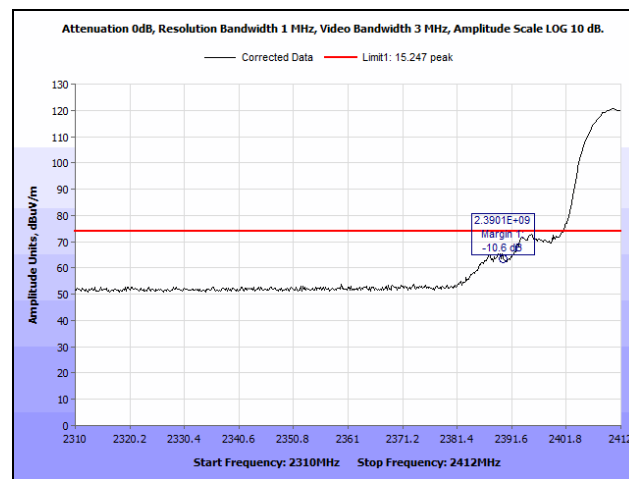

Plot 50. Radiated Band Edge, 802.11b 20 MHz, Low Channel, 2412 MHz @ 2390 MHz, Peak

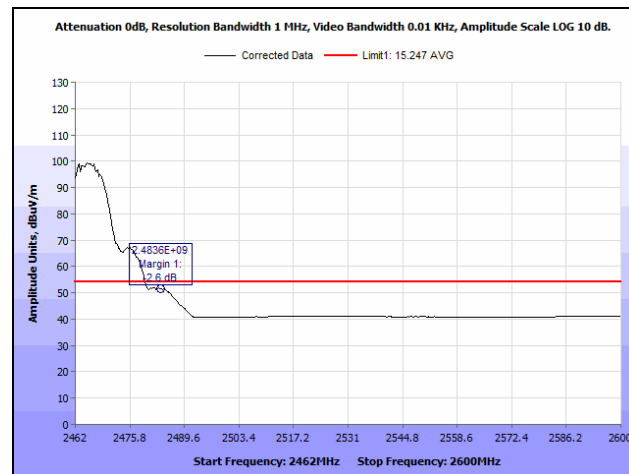

Plot 51. Radiated Band Edge, 802.11b 20 MHz, High Channel, 2462 MHz @ 2483.5 MHz, Average

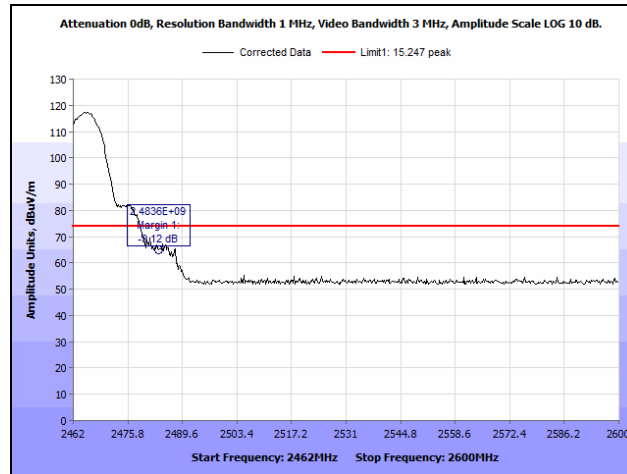

Plot 52. Radiated Band Edge, 802.11b 20 MHz, High Channel, 2462 MHz @ 2483.5 MHz, Peak

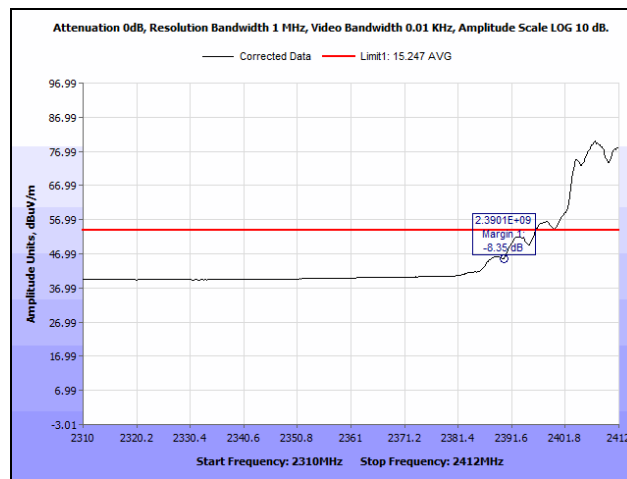

Plot 53. Radiated Band Edge, 802.11g 20 MHz, Low Channel, 2412 MHz @ 2390 MHz, Average

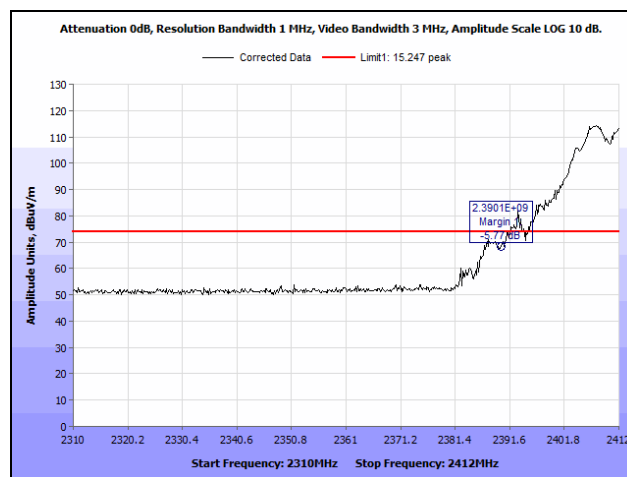

Plot 54. Radiated Band Edge, 802.11g 20 MHz, Low Channel, 2412 MHz @ 2390 MHz, Peak

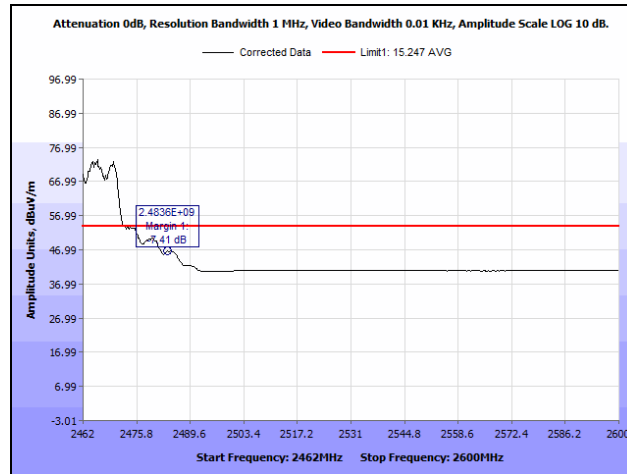

Plot 55. Radiated Band Edge, 802.11g 20 MHz, High Channel, 2462 MHz @ 2483.5 MHz, Average

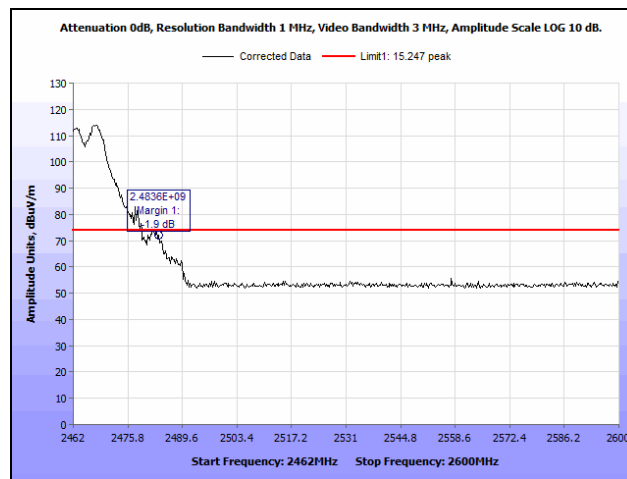

Plot 56. Radiated Band Edge, 802.11g 20 MHz, High Channel, 2462 MHz @ 2483.5 MHz, Peak

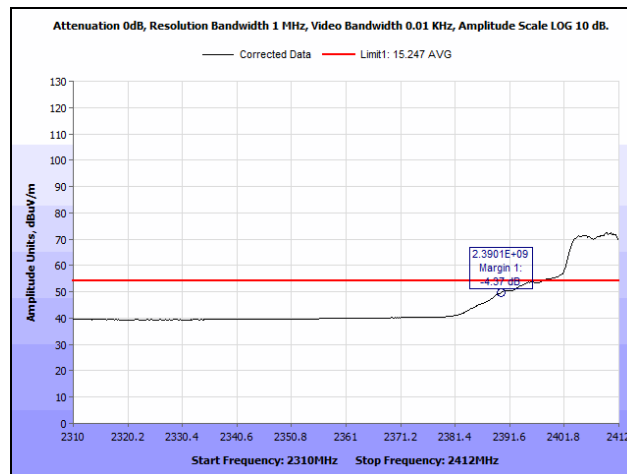

Plot 57. Radiated Band Edge, 802.11n 20 MHz, Low Channel, 2412 MHz @ 2390 MHz, Average

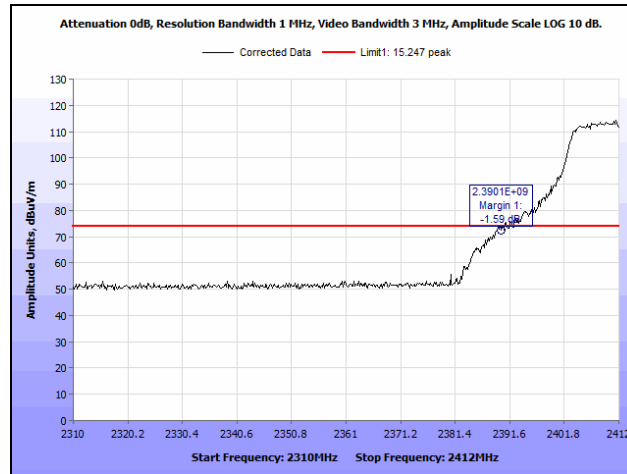

Plot 58. Radiated Band Edge, 802.11n 20 MHz, Low Channel, 2412 MHz @ 2390 MHz, Peak

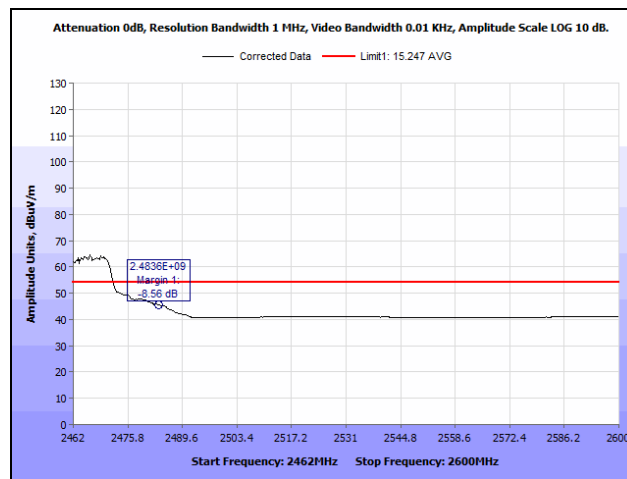

Plot 59. Radiated Band Edge, 802.11n 20 MHz, High Channel, 2462 MHz @ 2483.5 MHz, Average

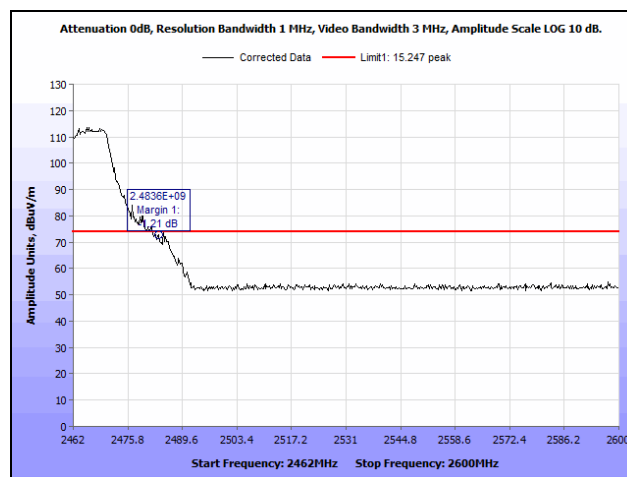

Plot 60. Radiated Band Edge, 802.11n 20 MHz, High Channel, 2462 MHz @ 2483.5 MHz, Peak

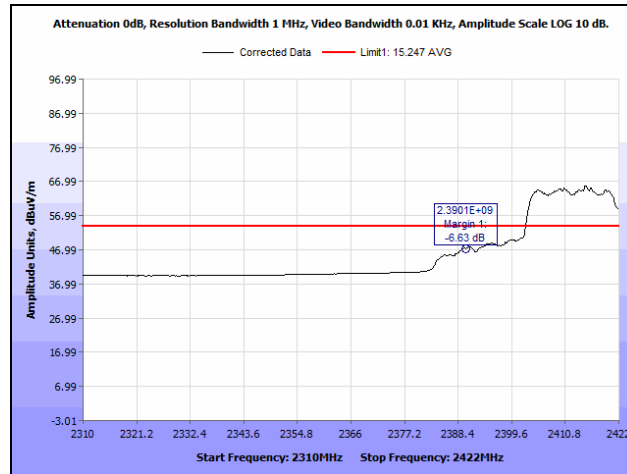

Plot 61. Radiated Band Edge, 802.11n 40 MHz, Low Channel, 2422 MHz @ 2390 MHz, Average

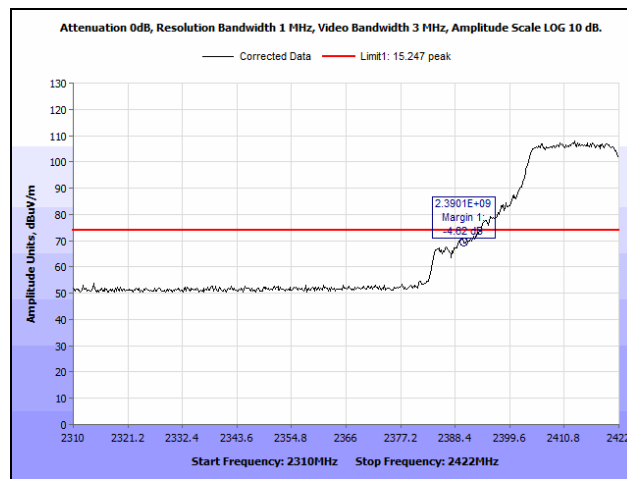

Plot 62. Radiated Band Edge, 802.11n 40 MHz, Low Channel, 2422 MHz @ 2390 MHz, Peak

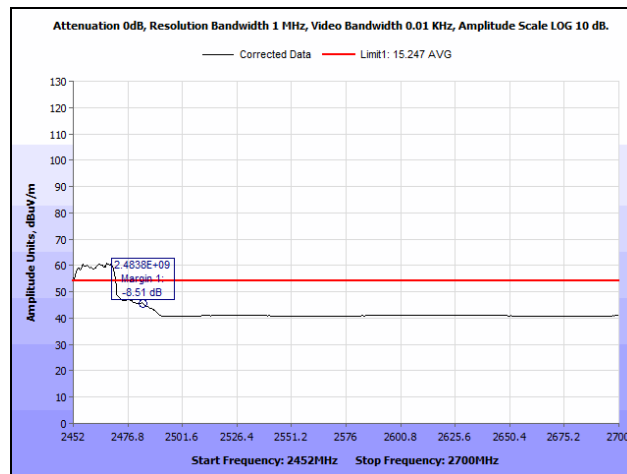

Plot 63. Radiated Band Edge, 802.11n 40 MHz, High Channel, 2452 MHz @ 2483.5 MHz, Average

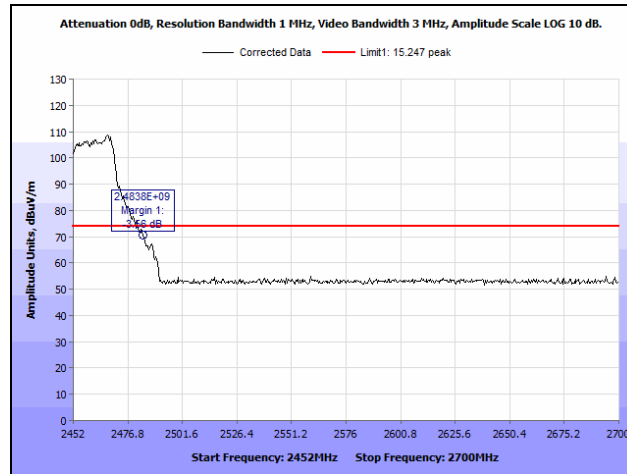

Plot 64. Radiated Band Edge, 802.11n 40 MHz, High Channel, 2452 MHz @ 2483.5 MHz, Peak

Electromagnetic Compatibility Criteria for Intentional Radiators

§ 15.247(d) RF Conducted Spurious Emissions Requirements and Band Edge

Test Requirement: **15.247(d)** In any 100 kHz bandwidth outside the frequency band in which the spread spectrum or digitally modulated intentional radiator is operating, the radio frequency power that is produced by the intentional radiator shall be at least 20 dB below that in the 100 kHz bandwidth within the band that contains the highest level of the desired power, based on either an RF conducted or a radiated measurement, provided the transmitter demonstrates compliance with the peak conducted power limits. If the transmitter complies with the conducted power limits based on the use of RMS averaging over a time interval, as permitted under paragraph (b)(3) of this section, the attenuation required under this paragraph shall be 30 dB instead of 20 dB.

Test Procedure: For intentional radiators with a digital device portion which operates below 10 GHz, the spectrum was investigated as per §15.33(a)(1) and §15.33(a)(4); i.e., the lowest RF signal generated or used in the device up to the 10th harmonic of the highest fundamental frequency or to 40 GHz, whichever is lower.

See following pages for detailed test results with RF Conducted Spurious Emissions.

Test Results: The EUT was compliant with the Conducted Spurious Emission limits of §15.247(d). All emissions are 30 dB below the fundamental.

Test Engineer(s): Benjamin Taylor

Test Date(s): 05/05/15

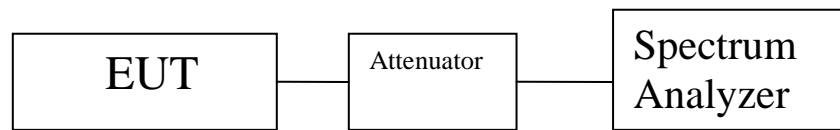
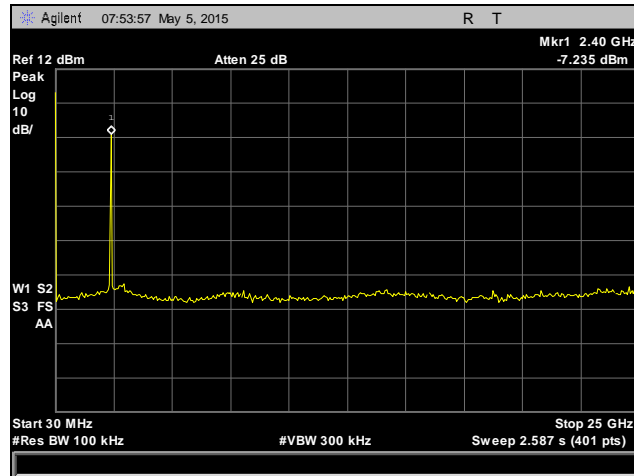
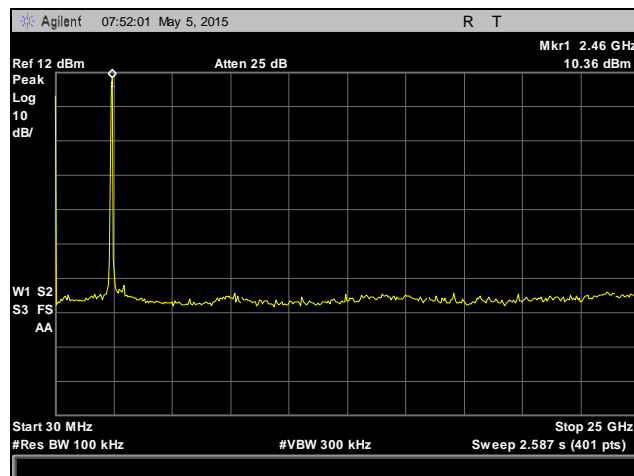

Figure 4. Block Diagram, Conducted Spurious Emissions Test Setup

Conducted Spurious Emissions Test Results



Plot 65. Conducted Spurious Emissions, 802.11b 20 MHz, 2412 MHz, 30 MHz – 25 GHz, Port 1



Plot 66. Conducted Spurious Emissions, 802.11b 20 MHz, 2442 MHz, 30 MHz – 25 GHz, Port 1

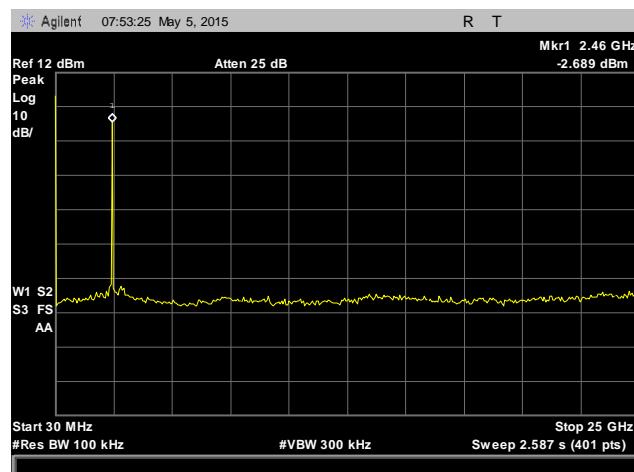

Plot 67. Conducted Spurious Emissions, 802.11b 20 MHz, 2462 MHz, 30 MHz – 25 GHz, Port 1

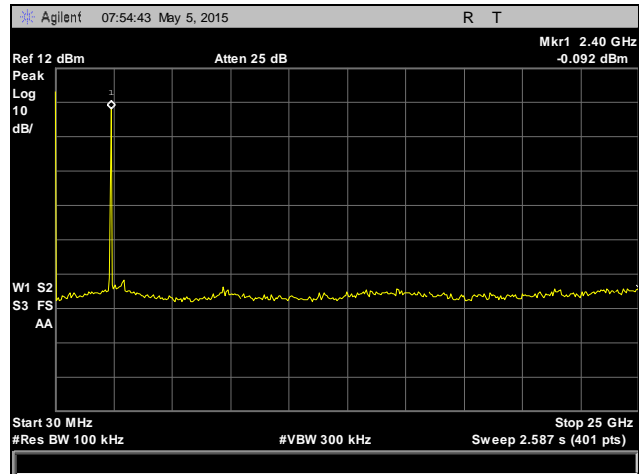

Plot 68. Conducted Spurious Emissions, 802.11g 20 MHz, 2412 MHz, 30 MHz – 25 GHz, Port 1

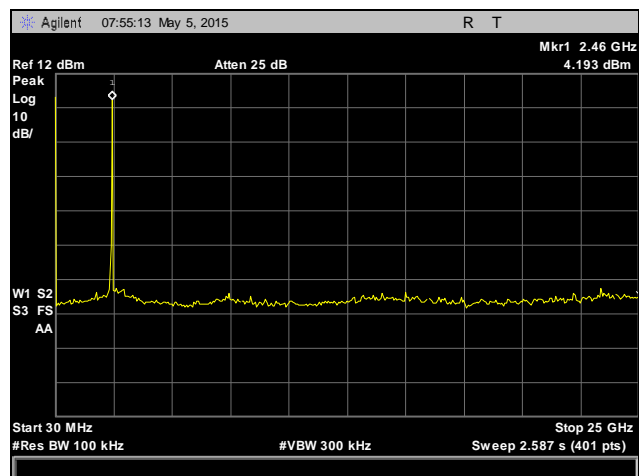

Plot 69. Conducted Spurious Emissions, 802.11g 20 MHz, 2442 MHz, 30 MHz – 25 GHz, Port 1

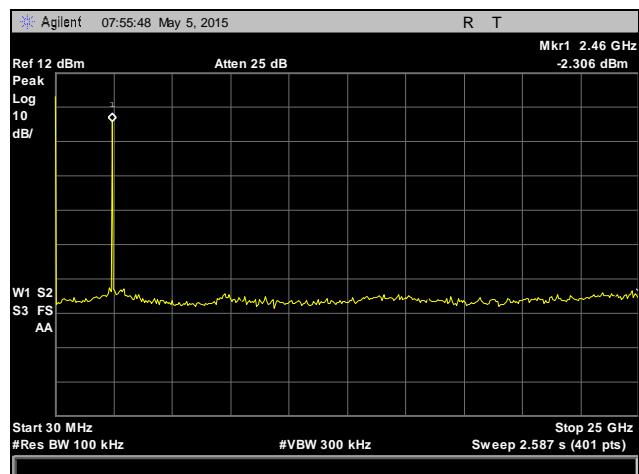

Plot 70. Conducted Spurious Emissions, 802.11g 20 MHz, 2462 MHz, 30 MHz – 25 GHz, Port 1

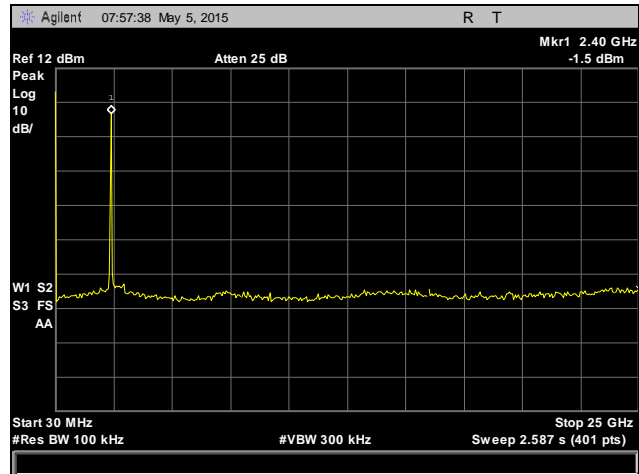

Plot 71. Conducted Spurious Emissions, 802.11n 20 MHz, 2412 MHz, 30 MHz – 25 GHz, Port 1

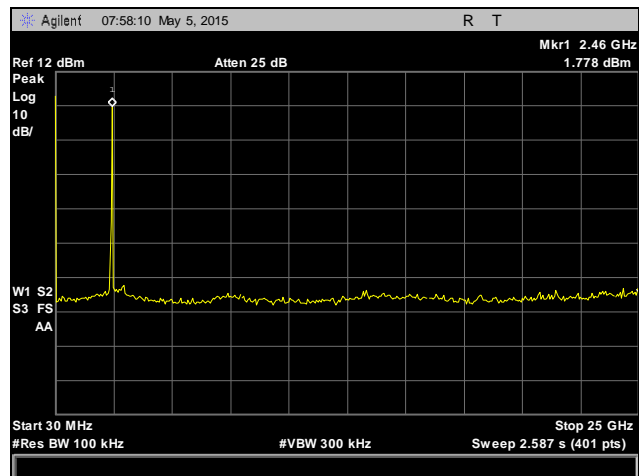

Plot 72. Conducted Spurious Emissions, 802.11n 20 MHz, 2442 MHz, 30 MHz – 25 GHz, Port 1

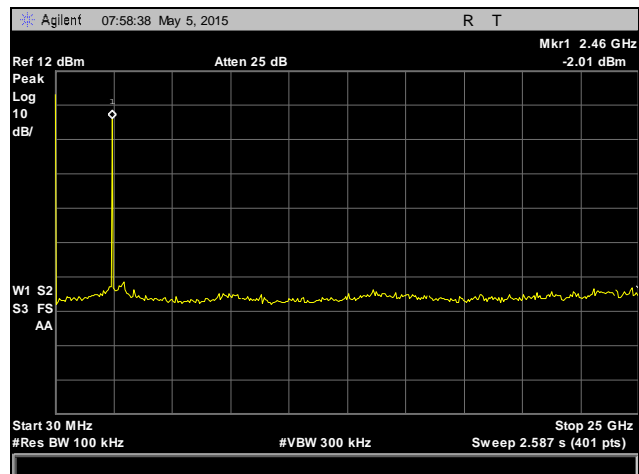

Plot 73. Conducted Spurious Emissions, 802.11n 20 MHz, 2462 MHz, 30 MHz – 25 GHz, Port 1

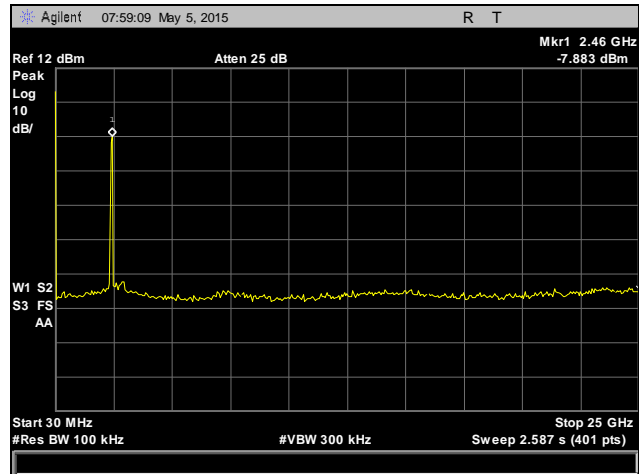

Plot 74. Conducted Spurious Emissions, 802.11n 40 MHz, 2422 MHz, 30 MHz – 25 GHz, Port 1

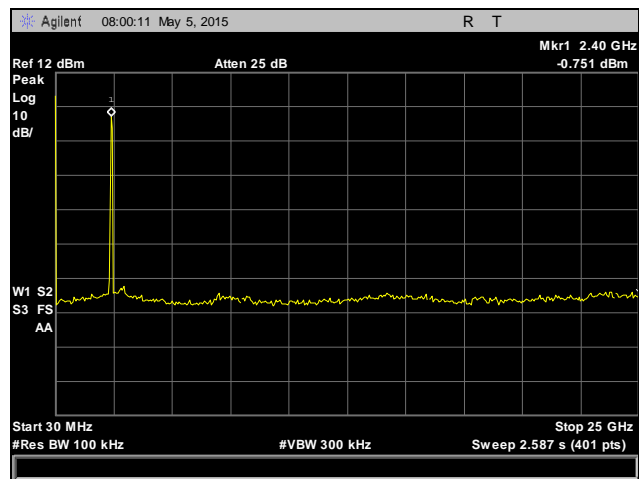

Plot 75. Conducted Spurious Emissions, 802.11n 40 MHz, 2437 MHz, 30 MHz – 25 GHz, Port 1

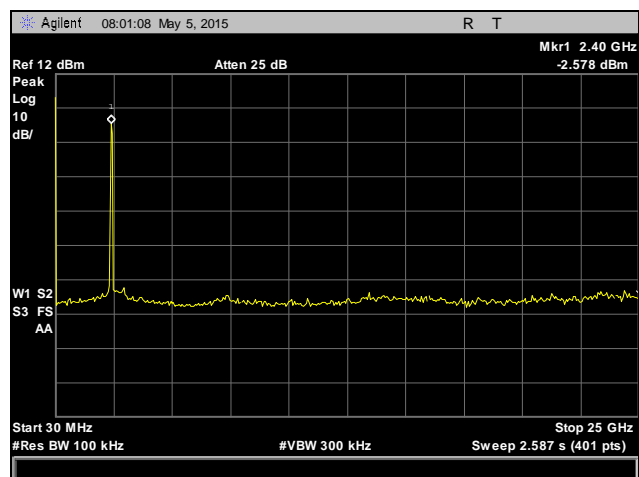

Plot 76. Conducted Spurious Emissions, 802.11n 40 MHz, 2452 MHz, 30 MHz – 25 GHz, Port 1

Conducted Spurious Emissions Test Results

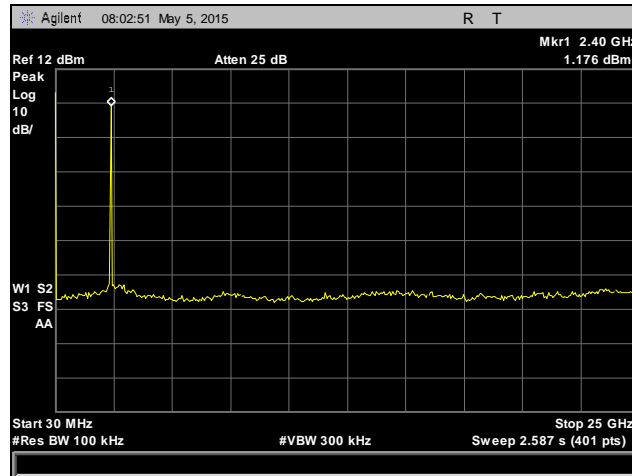

Plot 77. Conducted Spurious Emissions, 802.11b 20 MHz, 2412 MHz, 30 MHz – 25 GHz, Port 2

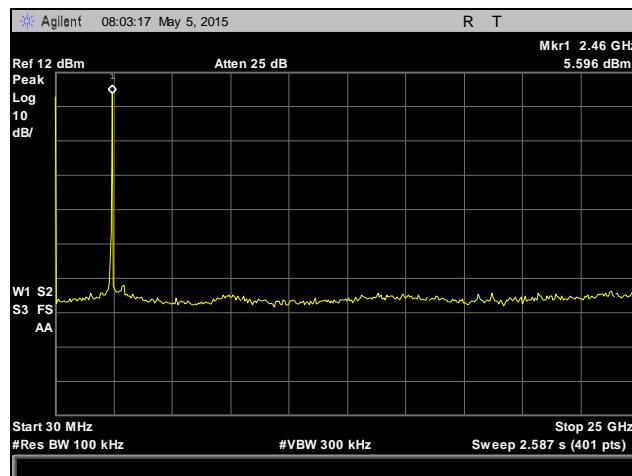

Plot 78. Conducted Spurious Emissions, 802.11b 20 MHz, 2442 MHz, 30 MHz – 25 GHz, Port 2

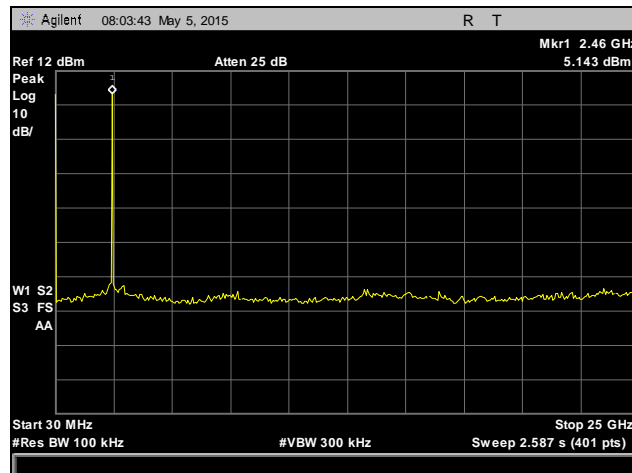

Plot 79. Conducted Spurious Emissions, 802.11b 20 MHz, 2462 MHz, 30 MHz – 25 GHz, Port 2

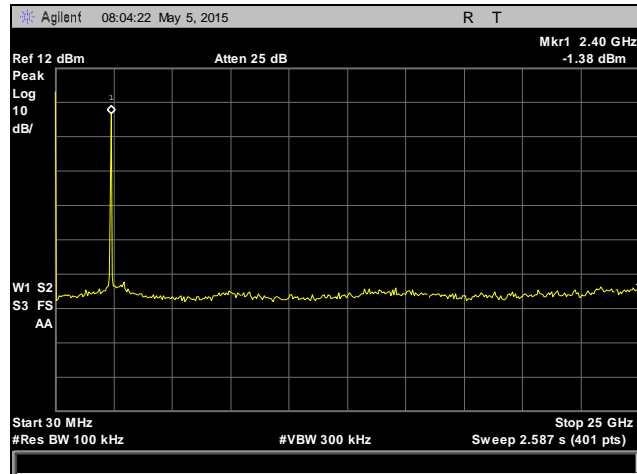

Plot 80. Conducted Spurious Emissions, 802.11g 20 MHz, 2412 MHz, 30 MHz – 25 GHz, Port 2

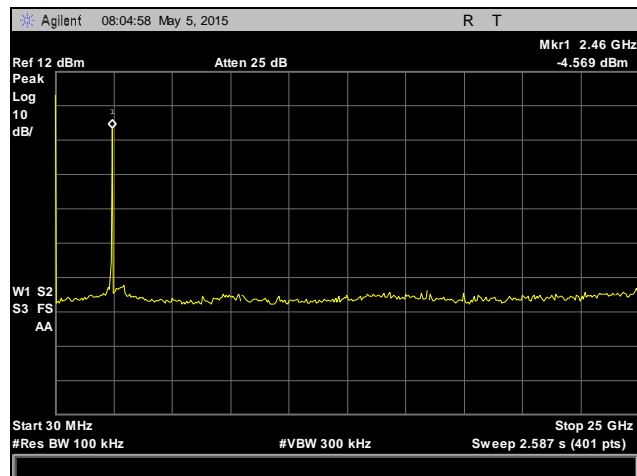

Plot 81. Conducted Spurious Emissions, 802.11g 20 MHz, 2442 MHz, 30 MHz – 25 GHz, Port 2

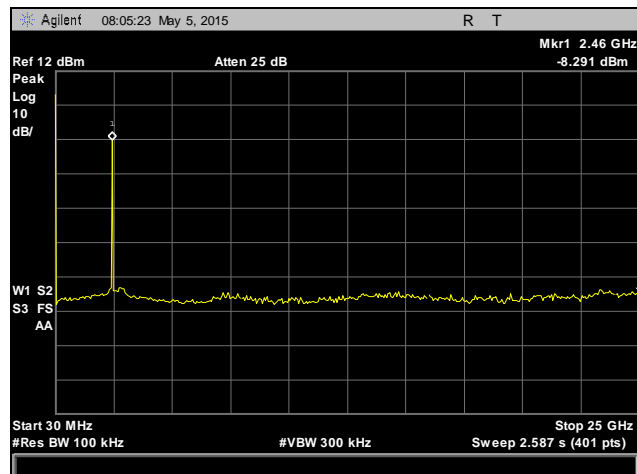

Plot 82. Conducted Spurious Emissions, 802.11g 20 MHz, 2462 MHz, 30 MHz – 25 GHz, Port 2

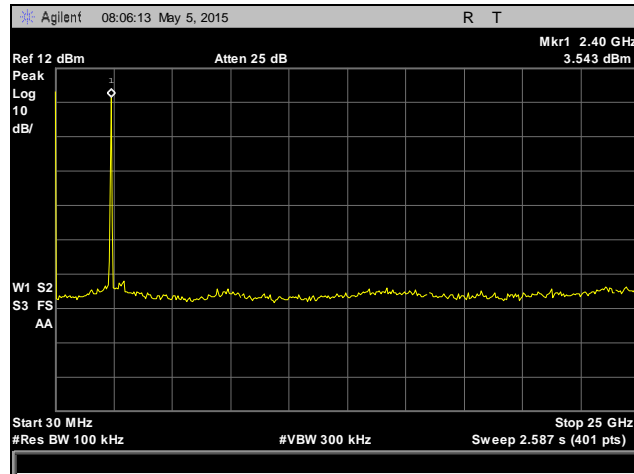

Plot 83. Conducted Spurious Emissions, 802.11n 20 MHz, 2412 MHz, 30 MHz – 25 GHz, Port 2

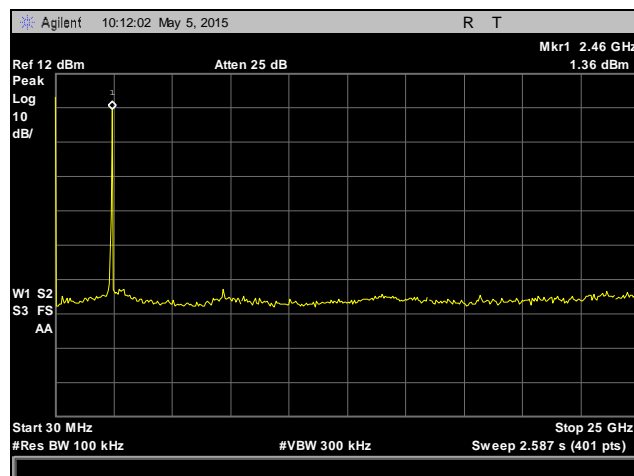

Plot 84. Conducted Spurious Emissions, 802.11n 20 MHz, 2442 MHz, 30 MHz – 25 GHz, Port 2

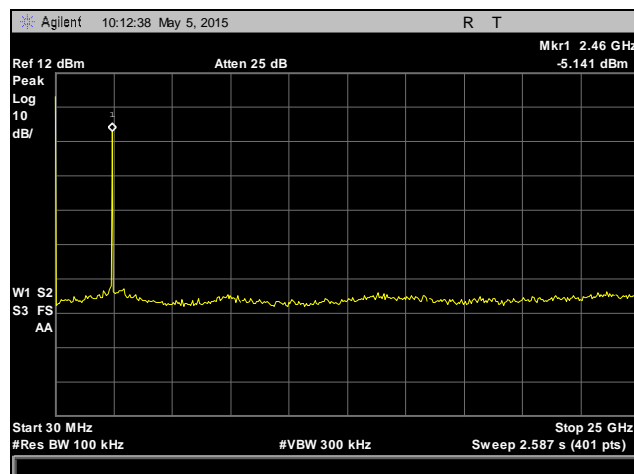

Plot 85. Conducted Spurious Emissions, 802.11n 20 MHz, 2462 MHz, 30 MHz – 25 GHz, Port 2

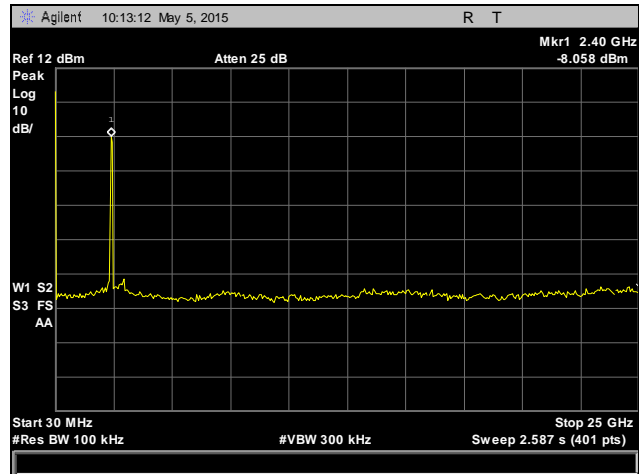

Plot 86. Conducted Spurious Emissions, 802.11n 40 MHz, 2422 MHz, 30 MHz – 25 GHz, Port 2

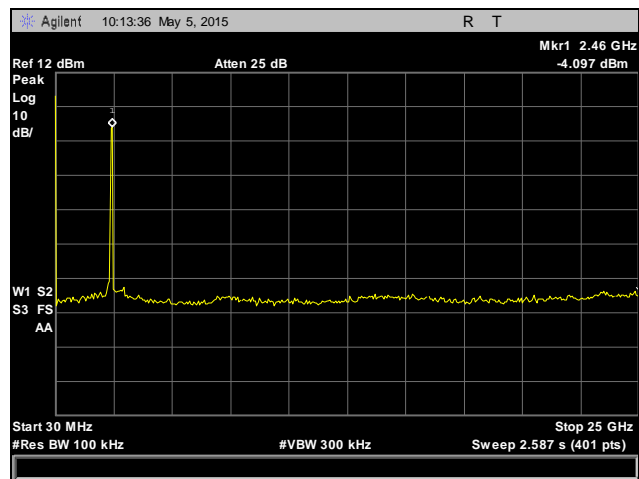

Plot 87. Conducted Spurious Emissions, 802.11n 40 MHz, 2437 MHz, 30 MHz – 25 GHz, Port 2

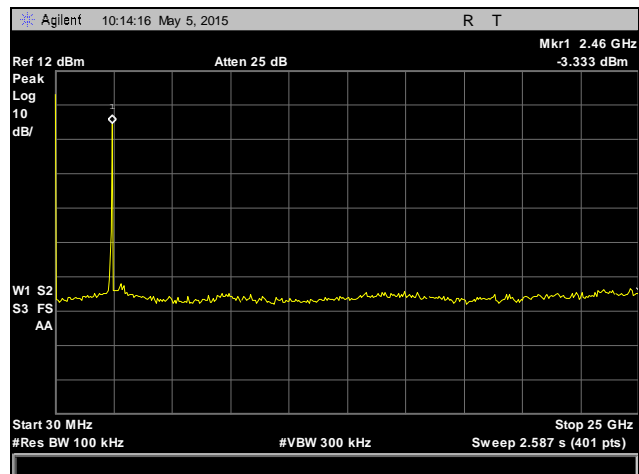

Plot 88. Conducted Spurious Emissions, 802.11n 40 MHz, 2452 MHz, 30 MHz – 25 GHz, Port 2

Conducted Band Edge

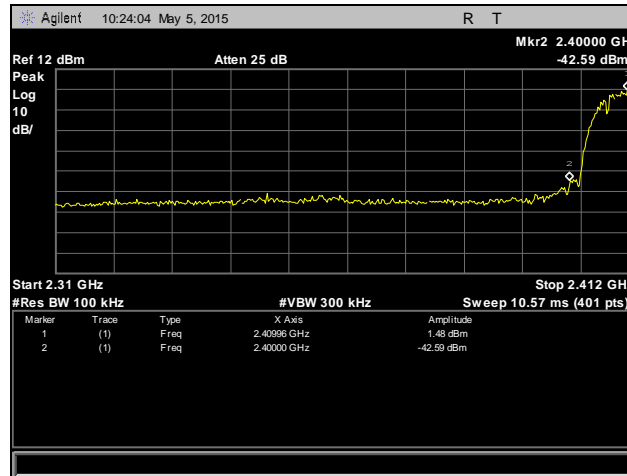

Plot 89. Conducted Band Edge, 802.11b 20 MHz, Low Channel, Port 1

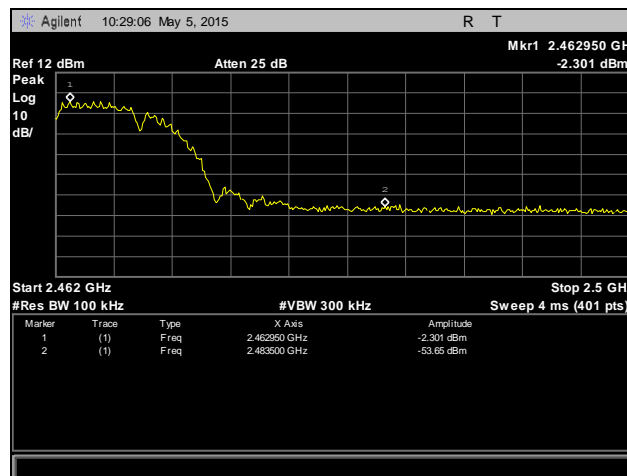

Plot 90. Conducted Band Edge, 802.11b 20 MHz, High Channel, Port 1

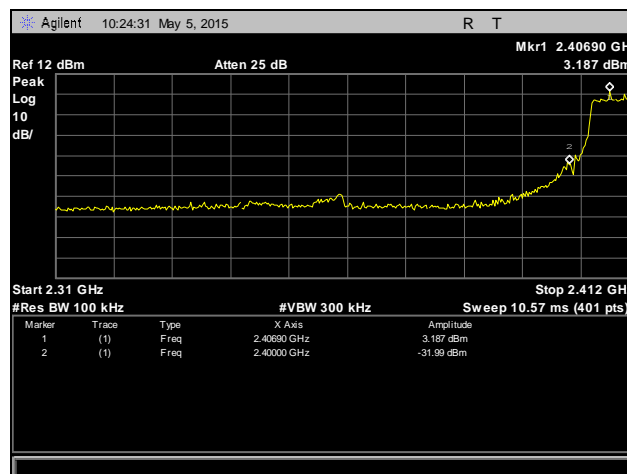

Plot 91. Conducted Band Edge, 802.11g 20 MHz, Low Channel, Port 1

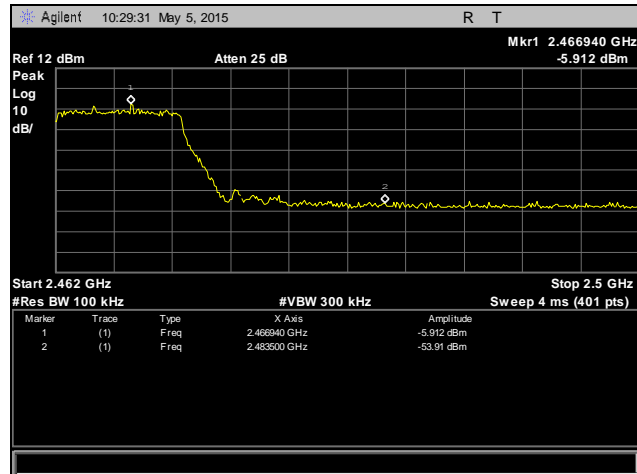

Plot 92. Conducted Band Edge, 802.11g 20 MHz, High Channel, Port 1



Plot 93. Conducted Band Edge, 802.11n 20 MHz, Low Channel, Port 1

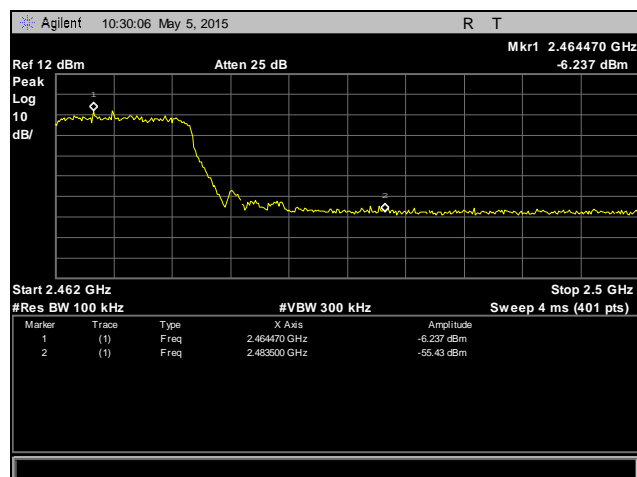

Plot 94. Conducted Band Edge, 802.11n 20 MHz, High Channel, Port 1

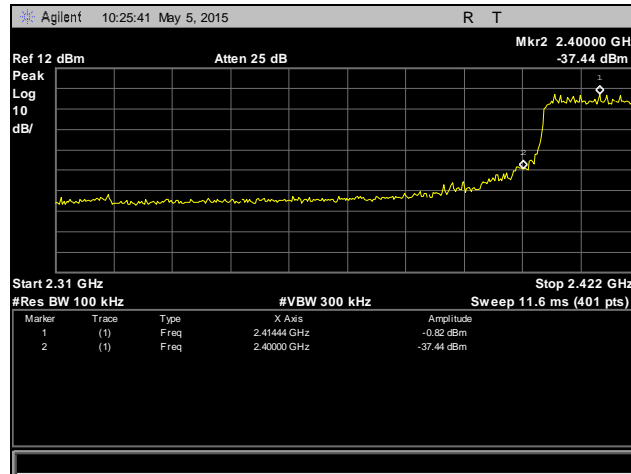

Plot 95. Conducted Band Edge, 802.11n 40 MHz, Low Channel, Port 1

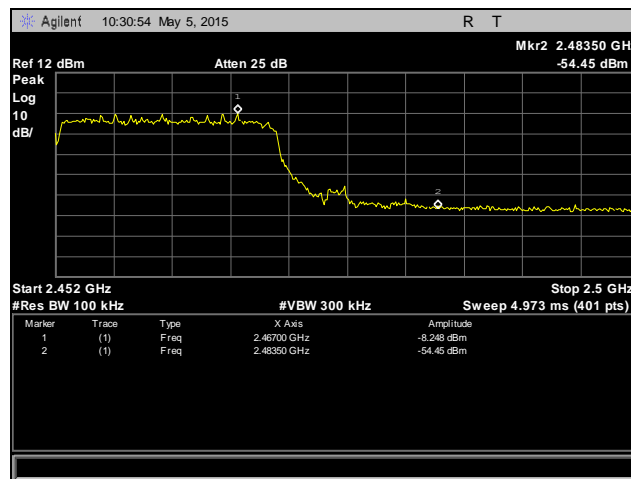

Plot 96. Conducted Band Edge, 802.11n 40 MHz, High Channel, Port 1

Conducted Band Edge

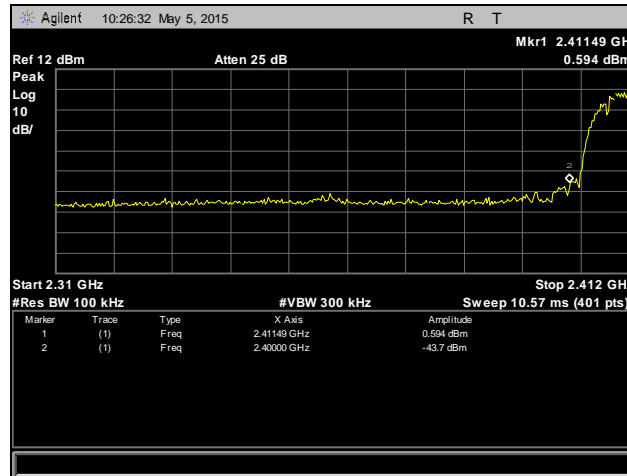

Plot 97. Conducted Band Edge, 802.11b 20 MHz, Low Channel, Port 2

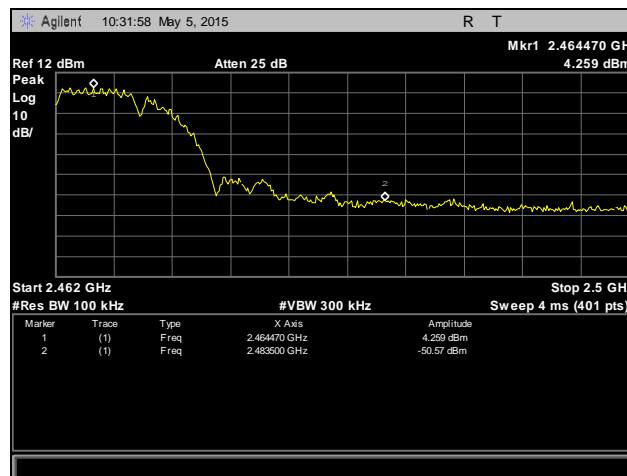

Plot 98. Conducted Band Edge, 802.11b 20 MHz, High Channel, Port 2

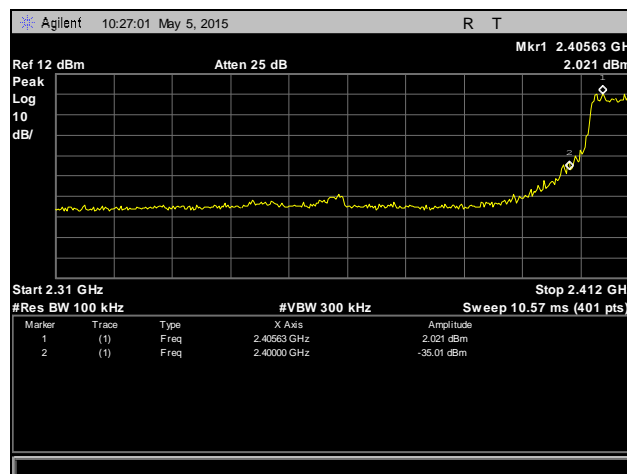

Plot 99. Conducted Band Edge, 802.11g 20 MHz, Low Channel, Port 2

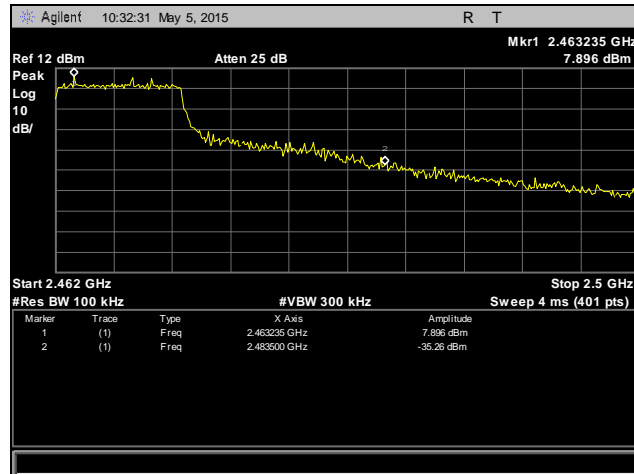

Plot 100. Conducted Band Edge, 802.11g 20 MHz, High Channel, Port 2

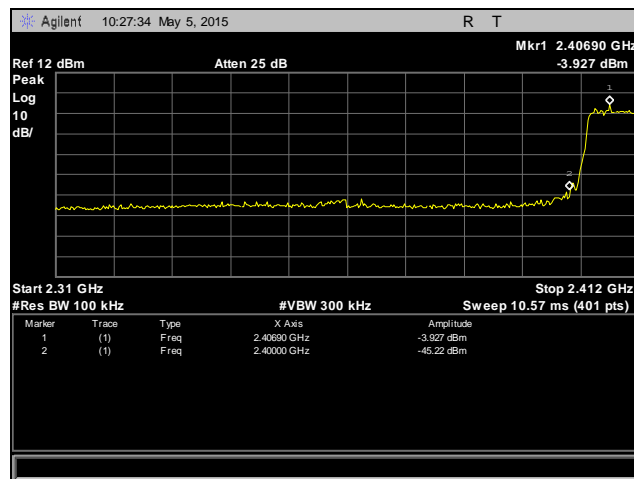

Plot 101. Conducted Band Edge, 802.11n 20 MHz, Low Channel, Port 2

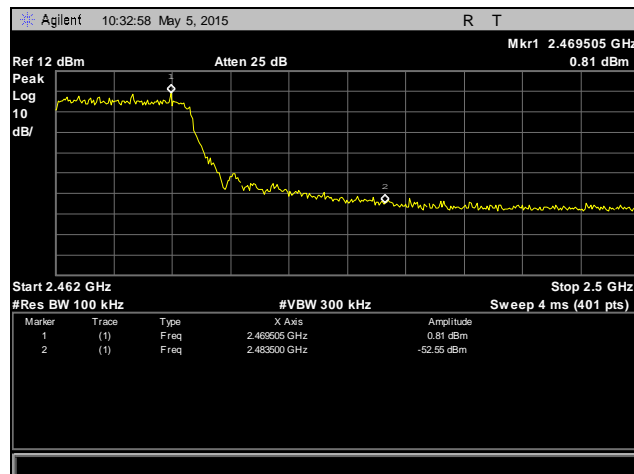

Plot 102. Conducted Band Edge, 802.11n 20 MHz, High Channel, Port 2

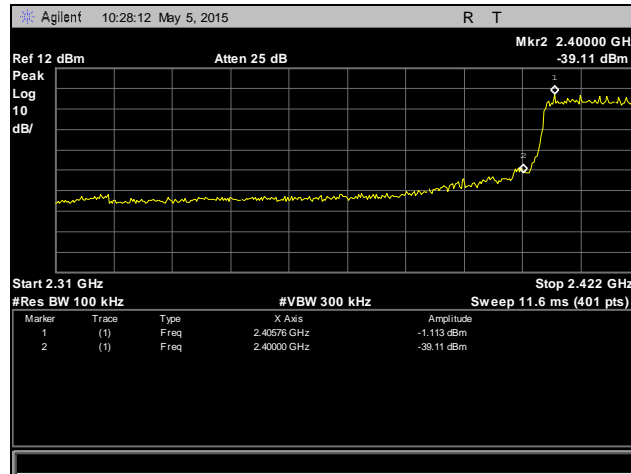

Plot 103. Conducted Band Edge, 802.11n 40 MHz, Low Channel, Port 2

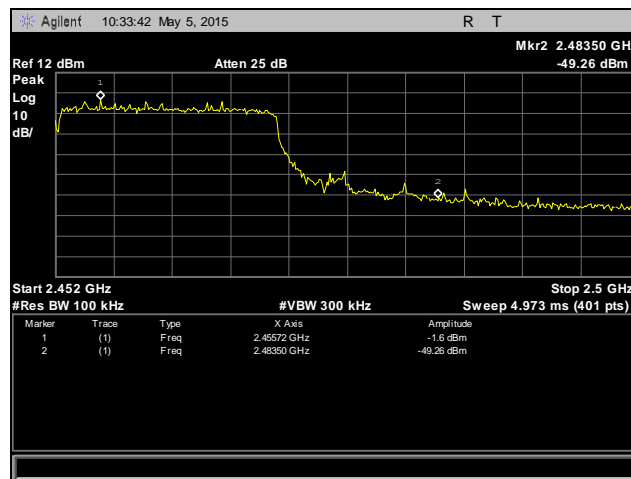

Plot 104. Conducted Band Edge, 802.11n 40 MHz, High Channel, Port 2

Electromagnetic Compatibility Criteria for Intentional Radiators

§ 15.247(e) Peak Power Spectral Density

Test Requirements: §15.247(e): For digitally modulated systems, the peak power spectral density conducted from the intentional radiator to the antenna shall not be greater than 8dBm in any 3 kHz band during any time interval of continuous transmission.

Test Procedure: The transmitter was connected directly to a Spectrum Analyzer through an attenuator. The power level was set to the maximum level based on the output power settings of 15.247(b). A RBW of 3 kHz and VBW of 10 kHz were used to determine the peak emissions within the band. The Peak Marker function of the analyzer was used to determine the highest peak spectral density in a 3 kHz band. Measurements were carried out at the low, mid and high channels.

Test Results: The EUT was compliant with the peak power spectral density limits of § 15.247 (e).

The peak power spectral density was determined from plots on the following page(s).

Test Engineer(s): Benjamin Taylor

Test Date(s): 05/05/15

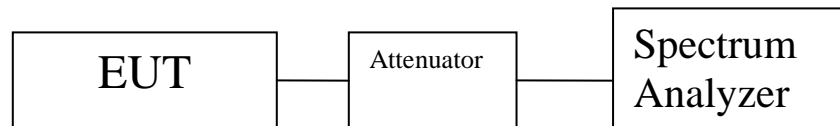

Figure 5. Block Diagram, Peak Power Spectral Density Test Setup

Power Spectral Density					
	Carrier Channel	Frequency (MHz)	Measured PPSD (dBm)	Limit (dBm)	Margin (dB)
802.11b	Low	2412.00	-4.09	8.00	-12.09
	Mid	2442.00	-2.73	8.00	-10.73
	High	2462.00	-3.03	8.00	-11.03
802.11g	Low	2412.00	-12.23	8.00	-20.23
	Mid	2442.00	-3.90	8.00	-11.90
	High	2462.00	-11.29	8.00	-19.29
802.11n 20 MHz Port 1	Low	2412.00	-11.68	8.00	-19.68
	Mid	2442.00	-4.60	8.00	-12.60
	High	2462.00	-12.63	8.00	-20.63
802.11n 20 MHz Port 2	Low	2412.00	-11.29	8.00	-19.29
	Mid	2442.00	-5.07	8.00	-15.07
	High	2462.00	-11.89	8.00	-19.89
802.11n 20 MHz Summed	Low	2422.00	-8.47	8.00	-16.47
	Mid	2442.00	-1.81	8.00	-9.81
	High	2452.00	-9.23	8.00	-17.23
802.11n 40 MHz Port 1	Low	2422.00	-16.06	8.00	-24.06
	Mid	2442.00	-7.83	8.00	-15.83
	High	2452.00	-16.00	8.00	-24.00
802.11n 40 MHz Port 2	Low	2422.00	-13.61	8.00	-21.61
	Mid	2442.00	-7.86	8.00	-15.86
	High	2452.00	-15.92	8.00	-23.92
802.11n 40 MHz Summed	Low	2422.00	-11.65	8.00	-19.66
	Mid	2442.00	-4.84	8.00	-12.85
	High	2452.00	-12.95	8.00	-20.96

Table 16. Peak Power Spectral Density, Test Results

Electromagnetic Compatibility Criteria for Intentional Radiators

§ 15.247(i) Maximum Permissible Exposure

RF Exposure Requirements: §1.1307(b)(1) and §1.1307(b)(2): Systems operating under the provisions of this section shall be operated in a manner that ensures that the public is not exposed to radio frequency energy levels in excess of the Commission's guidelines.

RF Radiation Exposure Limit: §1.1310: As specified in this section, the Maximum Permissible Exposure (MPE) Limit shall be used to evaluate the environmental impact of human exposure to radiofrequency (RF) radiation as specified in Sec. 1.1307(b), except in the case of portable devices which shall be evaluated according to the provisions of Sec. 2.1093 of this chapter.

MPE Limit Calculation: EUT's operating frequencies @ 2412-2462 MHz; **Limit for Uncontrolled exposure: 1 mW/cm² or 10 W/m²**

Equation from page 18 of OET 65, Edition 97-01

$$S = PG / 4\pi R^2 \quad \text{or} \quad R = \sqrt{PG / 4\pi S}$$

where, S = Power Density

P = Power Input to antenna = 27.25 dBm = 531 mW

G = Antenna Gain 3.2 dBi (2.089 inear)

R = Minimum Distance between User and Antenna (20cm)

$$S = (531 * 2.089) / (4 * 3.14 * 400) = 0.221 \text{ mW/cm}^2$$

Since $S < 1 \text{ mW/cm}^2$, the minimum distance (R) is 20cm

IV. Test Equipment

Test Equipment

Calibrated test equipment utilized during testing was maintained in a current state of calibration per the requirements of ISO/IEC 17025:2005.

MET Asset #	Equipment	Manufacturer	Model	Last Cal Date	Cal Due Date
1T4771	PSA SPECTRUM ANALYZER	AGILENT TECHNOLOGIES	E4446A	11/25/2014	5/25/2016
1T4409	EMI RECEIVER	ROHDE & SCHWARZ	ESIB7	7/18/2014	7/18/2016
1T4751	ANTENNA - BILOG	SUNOL SCIENCES	JB6	7/20/2014	1/20/2016
1T4483	ANTENNA; HORN	ETS-LINDGREN	3117	2/28/2014	8/28/2015
1T4300A	SEMI-ANECHOIC CHAMBER # 1 (FCC)	EMC TEST SYSTEMS	NONE	7/24/2012	7/24/2015

Table 17. Test Equipment List

V. Certification & User's Manual Information

Certification & User's Manual Information

A. Certification Information

The following is extracted from Title 47 of the Code of Federal Regulations, Part 2, Subpart I — Marketing of Radio frequency devices:

§ 2.801 Radio-frequency device defined.

As used in this part, a radio-frequency device is any device which in its operation is capable of Emitting radio-frequency energy by radiation, conduction, or other means. Radio- frequency devices include, but are not limited to:

- (a) The various types of radio communication transmitting devices described throughout this chapter.
- (b) *The incidental, unintentional and intentional radiators defined in Part 15 of this chapter.*
- (c) The industrial, scientific, and medical equipment described in Part 18 of this chapter.
- (d) Any part or component thereof which in use emits radio-frequency energy by radiation, conduction, or other means.

§ 2.803 Marketing of radio frequency devices prior to equipment authorization.

- (a) Except as provided elsewhere in this chapter, no person shall sell or lease, or offer for sale or lease (including advertising for sale or lease), or import, ship or distribute for the purpose of selling or leasing or offering for sale or lease, any radio frequency device unless:
 - (1) In the case of a device subject to certification, such device has been authorized by the Commission in accordance with the rules in this chapter and is properly identified and labeled as required by §2.925 and other relevant sections in this chapter; or
 - (2) In the case of a device that is not required to have a grant of equipment authorization issued by the Commission, but which must comply with the specified technical standards prior to use, such device also complies with all applicable administrative (including verification of the equipment or authorization under a Declaration of Conformity, where required), technical, labeling and identification requirements specified in this chapter.
- (d) Notwithstanding the provisions of paragraph (a) of this section, the offer for sale solely to business, commercial, industrial, scientific or medical users (but not an offer for sale to other parties or to end users located in a residential environment) of a radio frequency device that is in the conceptual, developmental, design or pre-production stage is permitted prior to equipment authorization or, for devices not subject to the equipment authorization requirements, prior to a determination of compliance with the applicable technical requirements *provided* that the prospective buyer is advised in writing at the time of the offer for sale that the equipment is subject to the FCC rules and that the equipment will comply with the appropriate rules before delivery to the buyer or to centers of distribution.

- (e)(1) Notwithstanding the provisions of paragraph (a) of this section, prior to equipment authorization or determination of compliance with the applicable technical requirements any radio frequency device may be operated, but not marketed, for the following purposes and under the following conditions:
- (i) *Compliance testing*;
 - (ii) Demonstrations at a trade show provided the notice contained in paragraph (c) of this section is displayed in a conspicuous location on, or immediately adjacent to, the device;
 - (iii) Demonstrations at an exhibition conducted at a business, commercial, industrial, scientific or medical location, but excluding locations in a residential environment, provided the notice contained in paragraphs (c) or (d) of this section, as appropriate, is displayed in a conspicuous location on, or immediately adjacent to, the device;
 - (iv) Evaluation of product performance and determination of customer acceptability, provided such operation takes place at the manufacturer's facilities during developmental, design or pre-production states; or
 - (v) Evaluation of product performance and determination of customer acceptability where customer acceptability of a radio frequency device cannot be determined at the manufacturer's facilities because of size or unique capability of the device, provided the device is operated at a business, commercial, industrial, scientific or medical user's site, but not at a residential site, during the development, design or pre-production stages.
- (e)(2) For the purpose of paragraphs (e)(1)(iv) and (e)(1)(v) of this section, the term *manufacturer's facilities* includes the facilities of the party responsible for compliance with the regulations and the manufacturer's premises, as well as the facilities of other entities working under the authorization of the responsible party in connection with the development and manufacture, but not the marketing, of the equipment.
- (f) For radio frequency devices subject to verification and sold solely to business, commercial, industrial, scientific and medical users (excluding products sold to other parties or for operation in a residential environment), parties responsible for verification of the devices shall have the option of ensuring compliance with the applicable technical specifications of this chapter at each end user's location after installation, provided that the purchase or lease agreement includes a proviso that such a determination of compliance be made and is the responsibility of the party responsible for verification of the equipment.

Certification & User's Manual Information

The following is extracted from Title 47 of the Code of Federal Regulations, Part 2, Subpart J — Equipment Authorization Procedures:

§ 2.901 Basis and Purpose

- (a) In order to carry out its responsibilities under the Communications Act and the various treaties and international regulations, and in order to promote efficient use of the radio spectrum, the Commission has developed technical standards for radio frequency equipment and parts or components thereof. The technical standards applicable to individual types of equipment are found in that part of the rules governing the service wherein the equipment is to be operated.¹ *In addition to the technical standards provided, the rules governing the service may require that such equipment be verified by the manufacturer or importer, be authorized under a Declaration of Conformity, or receive an equipment authorization from the Commission by one of the following procedures: certification or registration.*
- (b) The following sections describe the verification procedure, the procedure for a Declaration of Conformity, and the procedures to be followed in obtaining certification from the Commission and the conditions attendant to such a grant.

§ 2.907 Certification.

- (a) Certification is an equipment authorization issued by the Commission, based on representation and test data submitted by the applicant.
- (b) Certification attaches to all units subsequently marketed by the grantee which are identical (see Section 2.908) to the sample tested except for permissive changes or other variations authorized by the Commission pursuant to Section 2.1043.

¹ In this case, the equipment is subject to the rules of Part 15. More specifically, the equipment falls under Subpart B (of Part 15), which deals with unintentional radiators.

Certification & User's Manual Information

§ 2.948 Description of measurement facilities.

- (a) Each party making measurements of equipment that is subject to an equipment authorization under Part 15 or Part 18 of this chapter, regardless of whether the measurements are filed with the Commission or kept on file by the party responsible for compliance of equipment marketed within the U.S. or its possessions, shall compile a description of the measurement facilities employed.
- (1) If the measured equipment is subject to the verification procedure, the description of the measurement facilities shall be retained by the party responsible for verification of the equipment.
- (i) *If the equipment is verified through measurements performed by an independent laboratory, it is acceptable for the party responsible for verification of the equipment to rely upon the description of the measurement facilities retained by or placed on file with the Commission by that laboratory. In this situation, the party responsible for the verification of the equipment is not required to retain a duplicate copy of the description of the measurement facilities.*
- (ii) If the equipment is verified based on measurements performed at the installation site of the equipment, no specific site calibration data is required. It is acceptable to retain the description of the measurement facilities at the site at which the measurements were performed.
- (2) If the equipment is to be authorized by the Commission under the certification procedure, the description of the measurement facilities shall be filed with the Commission's Laboratory in Columbia, Maryland. The data describing the measurement facilities need only be filed once but must be updated as changes are made to the measurement facilities or as otherwise described in this section. At least every three years, the organization responsible for filing the data with the Commission shall certify that the data on file is current.

Certification & User's Manual Information

1. Label and User's Manual Information

The following is extracted from Title 47 of the Code of Federal Regulations, Part 15, Subpart A — General:

§ 15.19 Labeling requirements.

(a) *In addition to the requirements in Part 2 of this chapter, a device subject to certification or verification shall be labeled as follows:*

- (1) Receivers associated with the operation of a licensed radio service, e.g., FM broadcast under Part 73 of this chapter, land mobile operation under Part 90, etc., shall bear the following statement in a conspicuous location on the device:

This device complies with Part 15 of the FCC Rules. Operation is subject to the condition that this device does not cause harmful interference.

- (2) A stand-alone cable input selector switch, shall bear the following statement in a conspicuous location on the device:

This device is verified to comply with Part 15 of the FCC Rules for use with cable television service.

- (3) All other devices shall bear the following statement in a conspicuous location on the device:

This device complies with Part 15 of the FCC Rules. Operation is subject to the following two conditions: (1) This device may not cause harmful interference, and (2) this device must accept any interference received, including interference that may cause undesired operation.

- (4) Where a device is constructed in two or more sections connected by wires and marketed together, the statement specified under paragraph (a) of this section is required to be affixed only to the main control unit.

- (5) When the device is so small or for such use that it is not practicable to place the statement specified under paragraph (a) of this section on it, the information required by this paragraph shall be placed in a prominent location in the instruction manual or pamphlet supplied to the user or, alternatively, shall be placed on the container in which the device is marketed. However, the FCC identifier or the unique identifier, as appropriate, must be displayed on the device.

§ 15.21 Information to user.

The user's manual or instruction manual for an intentional or unintentional radiator shall caution the user that changes or modifications not expressly approved by the party responsible for compliance could void the user's authority to operate the equipment.

Verification & User's Manual Information

The following is extracted from Title 47 of the Code of Federal Regulations, Part 15, Subpart B — Unintentional Radiators:

§ 15.105 Information to the user.

- (a) For a Class A digital device or peripheral, the instructions furnished the user shall include the following or similar statement, placed in a prominent location in the text of the manual:

Note: This equipment has been tested and found to comply with the limits for a Class A digital device, pursuant to Part 15 of the FCC Rules. These limits are designed to provide reasonable protection against harmful interference when the equipment is operated in a commercial environment. This equipment generates, uses, and can radiate radio frequency energy and, if not installed and used in accordance with the instruction manual, may cause harmful interference to radio communications. Operation of this equipment in a residential area is likely to cause harmful interference in which case the user will be required to correct the interference at own expense.

- (b) For a Class B digital device or peripheral, the instructions furnished the user shall include the following or similar statement, placed in a prominent location in the text of the manual:

Note: This equipment has been tested and found to comply with the limits for a Class B digital device, pursuant to Part 15 of the FCC Rules. These limits are designed to provide reasonable protection against harmful interference when the equipment is operated in a residential environment. This equipment generates, uses, and can radiate radio frequency energy and, if not installed and used in accordance with the instruction manual, may cause harmful interference to radio communications. However, there is no guarantee that interference will not occur in a particular installation. If this equipment does cause harmful interference to radio or television reception, which can be determined by turning the equipment off and on, the user is encouraged to try to correct the interference by one or more of the following measures:

- Reorient or relocate the receiving antenna.
- Increase the separation between the equipment and receiver.
- Connect the equipment into an outlet on a circuit different from that to which the receiver is connected.
- Consult the dealer or an experienced radio/TV technician for help.

End of Report