



Test report No.: 2380785R-SAUSV01S-A

## SAR Test Report (Class II Permissive Change)

Product Name	Communication Module
Trademark	muRata
Model and /or type reference	LBEE5XV1YM
Applicant's name / address	Laerdal Medical AS Tanke Svilandsgate 30 P.O. Box 377, Stavanger, 4002 Norway
Manufacturer's name	Murata Manufacturing Co., Ltd.
FCC ID	QHQLB1YM
Applicable Standard	IEEE 1528-2013 KDB 447498 D01 v06 KDB 865664 D01 v01r04
Test Result	Max. SAR Measurement (1g) 2.4 GHz: <b>1.077</b> W/kg 5 GHz: <b>1.004</b> W/kg
Verdict Summary	IN COMPLIANCE
Documented By (Senior Project Specialist / Joanne Lin)	<i>Joanne Lin</i>
Tested By (Senior Engineer / Luke Cheng)	<i>Luke Cheng</i>
Approved By (Assistant Manager / San Lin)	<i>San Lin</i>
Date of Receipt	2023/08/25
Date of Issue	2023/10/27
Report Version	V1.0

**INDEX**

	<b>Page</b>
<b>1. General Information .....</b>	<b>5</b>
1.1 EUT Description .....	5
1.2 Antenna List .....	6
1.3 SAR Test Exclusion Calculation .....	7
1.4 Test Environment.....	9
1.5 Measurement procedures.....	10
<b>2. SAR Measurement System .....</b>	<b>11</b>
2.1 DASY System Description .....	11
2.2 Area Scans.....	12
2.3 DASY E-Field Probe.....	13
2.4 DATA Acquisition Electronics (DAE) and Measurement Server .....	14
2.5 Robot.....	15
2.6 Device Holder .....	15
2.7 Phantom .....	16
<b>3. Tissue Simulating Liquid .....</b>	<b>17</b>
3.1 The composition of the tissue simulating liquid .....	17
3.2 Tissue Calibration Result.....	17
3.3 Tissue Dielectric Parameters for Phantoms .....	18
<b>4. Measurement Procedure.....</b>	<b>19</b>
4.1 SAR System Check.....	19
4.2 SAR Measurement Procedure.....	20
<b>5. RF Exposure Limits.....</b>	<b>21</b>
<b>6. Test Equipment List .....</b>	<b>22</b>
<b>7. Measurement Uncertainty.....</b>	<b>25</b>
<b>8. Conducted Power Measurement (Including tolerance allowed for production unit).....</b>	<b>27</b>
<b>9. Test Results .....</b>	<b>30</b>
9.1 Test Results Summary .....	30
9.2 Simultaneous Transmission.....	32
<b>10. SAR measurement variability .....</b>	<b>33</b>
Appendix A. System Check Data	
Appendix B. Highest measurement Data	
Appendix C. Test Setup Photographs	
Appendix D. Probe Calibration Data	
Appendix E. Dipole & Source Calibration	
Appendix F. Product Photos-Please refer to the file: 2380785R-Product Photos	

---

## Competences and Guarantees

---

DEKRA is a testing laboratory competent to carry out the tests described in this report.

In order to assure the traceability to other national and international laboratories, DEKRA has a calibration and maintenance program for its measurement equipment.

DEKRA guarantees the reliability of the data presented in this report, which is the result of the measurements and the tests performed to the item under test on the date and under the conditions stated in the report and it is based on the knowledge and technical facilities available at DEKRA at the time of performance of the test.

DEKRA is liable to the client for the maintenance of the confidentiality of all information related to the item under test and the results of the test.

The results presented in this Test Report apply only to the particular item under test established in this document.

**IMPORTANT:** No parts of this report may be reproduced or quoted out of context, in any form or by any means, except in full, without the previous written permission of DEKRA.

---

## General conditions

---

1. The test results relate only to the samples tested.
2. The test results shown in the test report are traceable to the national/international standard through the calibration report of the equipment and evaluated measurement uncertainty herein.
3. This report must not be used to claim product endorsement by TAF or any agency of the government.
4. The test report shall not be reproduced without the written approval of DEKRA Testing and Certification Co., Ltd.
5. Measurement uncertainties evaluated for each testing system and associated connections are given here to provide the system information for reference. Compliance determinations do not take into account measurement uncertainties for each testing system, but are based on the results of the compliance measurement.

## Revision History

---

Report No.	Version	Description	Issued Date
2380785R-SAUSV01S-A	V1.0	Initial issue of report.	2023/10/27

## 1. General Information

### 1.1 EUT Description

Product Name	Communication Module
Trademark	muRata
Model and /or type reference	LBEE5XV1YM
FCC ID	QHQ-LB1YM
Frequency Range	WLAN 2.4GHz: 2412-2462MHz WLAN 5GHz: 5180-5240MHz, 5260-5320MHz, 5500-5720MHz, 5745-5825MHz BT: 2402-2480MHz
Type of Modulation	802.11b: DSSS 802.11a/g/n/ac: OFDM GFSK(1Mbps) / $\pi$ /4DQPSK(2Mbps) / 8DPSK(3Mbps)
Antenna Type	Dipole
Device Category	Portable
RF Exposure Environment	Uncontrolled

Summary of test result - Reported 1g SAR (W/kg)			
Test configuration	DTS	NII	DSS(BT)
Standalone	1.077	1.004	0.003
Simultaneous	1.080	1.007	1.080

Note:

Host information		
Brand	Product Name	Model No.
Laerdal Medical AS	SimPad PLUS 2	204-00150

## 1.2 Antenna List

No.	Manufacturer	Part No.	Antenna Type	Peak Gain
1	SANAV	GEPH-056 (Main)	Dipole	3.04 dBi for 2400 MHz -2.62 dBi for 5150~5250 MHz -2.62 dBi for 5250~5350 MHz -2.21 dBi for 5470~5725 MHz -1.93 dBi for 5725~5850 MHz
		GEPH-062-1 (Aux)	Dipole	-1.99 dBi for 2400 MHz -1.33 dBi for 5150~5250 MHz -1.33 dBi for 5250~5350 MHz -5.36 dBi for 5470~5725 MHz -3.36 dBi for 5725~5850 MHz

Note: The above EUT information by host manufacturer.

### 1.3 SAR Test Exclusion Calculation

According to KDB Publication 447498 D01, section 4.3.1, per the calculations of item 1 (Power(mW)/separation (mm)\*sqrt(f(GHz)≤3.0), SAR is required as shown in the table below where calculated values are greater than 3.0:

#### SAR exclusion calculations for WiFi-SISO and Bluetooth for antenna < 50mm from the user :

Antenna	Tx	Frequency (MHz)	Output Power		Separation distances (mm)						Calculated Threshold Value (≤3.0 SAR is not required)					
			dBm	mW	Back	Right	Left	Top	Bottom	Front	Back	Right	Left	Top	Bottom	Front
Main	WiFi	2462	17.0	50	5	65	23	5	152	5	15.7	>50mm	3.4	15.7	>50mm	15.7
Main	WiFi	5240	12.0	16	5	65	23	5	152	5	7.3	>50mm	1.6	7.3	>50mm	7.3
Main	WiFi	5320	12.5	18	5	65	23	5	152	5	8.2	>50mm	1.8	8.2	>50mm	8.2
Main	WiFi	5700	11.0	13	5	65	23	5	152	5	6.0	>50mm	1.3	6.0	>50mm	6.0
Main	WiFi	5825	8.5	7	5	65	23	5	152	5	3.4	>50mm	0.7	3.4	>50mm	3.4

#### SAR exclusion calculations for WiFi-SISO and Bluetooth for antenna > 50mm from the user :

Antenna	Tx	Frequency (MHz)	Output Power		Separation distances (mm)						Calculated Threshold Value (SAR test exclusion power,mW)					
			dBm	mW	Back	Right	Left	Top	Bottom	Front	Back	Right	Left	Top	Bottom	Front
Main	WiFi	2462	17.0	50	5	65	23	5	152	5	<50mm	245.6	<50mm	<50mm	1115.6	<50mm
Main	WiFi	5240	12.0	16	5	65	23	5	152	5	<50mm	215.5	<50mm	<50mm	1085.5	<50mm
Main	WiFi	5320	12.5	18	5	65	23	5	152	5	<50mm	215.0	<50mm	<50mm	1085.0	<50mm
Main	WiFi	5700	11.0	13	5	65	23	5	152	5	<50mm	212.8	<50mm	<50mm	1082.8	<50mm
Main	WiFi	5825	8.5	7	5	65	23	5	152	5	<50mm	212.2	<50mm	<50mm	1082.2	<50mm

**SAR exclusion calculations for WiFi-SISO and Bluetooth for antenna < 50mm from the user :**

Antenna	Tx	Frequency (MHz)	Output Power		Separation distances (mm)						Calculated Threshold Value ( $\leq 3.0$ SAR is not required)					
			dBm	mW	Back	Right	Left	Top	Bottom	Front	Back	Right	Left	Top	Bottom	Front
Aux	WiFi	2462	17.0	50	5	123	5	44	90	5	15.7	>50mm	15.7	<b>1.8</b>	>50mm	15.7
Aux	WiFi	5240	12.0	16	5	123	5	44	90	5	7.3	>50mm	7.3	<b>0.8</b>	>50mm	7.3
Aux	WiFi	5320	12.5	18	5	123	5	44	90	5	8.2	>50mm	8.2	<b>0.9</b>	>50mm	8.2
Aux	WiFi	5700	11.0	13	5	123	5	44	90	5	6.0	>50mm	6.0	<b>0.7</b>	>50mm	6.0
Aux	WiFi	5825	8.5	7	5	123	5	44	90	5	3.4	>50mm	3.4	<b>0.4</b>	>50mm	3.4
Aux	BT	2480	6.0	4	5	123	5	44	90	5	<b>1.3</b>	>50mm	<b>1.3</b>	<b>0.1</b>	>50mm	<b>1.3</b>

**SAR exclusion calculations for WiFi-SISO and Bluetooth for antenna > 50mm from the user :**

Antenna	Tx	Frequency (MHz)	Output Power		Separation distances (mm)						Calculated Threshold Value (SAR test exclusion power,mW)					
			dBm	mW	Back	Right	Left	Top	Bottom	Front	Back	Right	Left	Top	Bottom	Front
Aux	WiFi	2462	17.0	50	5	123	5	44	90	5	<50mm	825.6	<50mm	<50mm	495.6	<50mm
Aux	WiFi	5240	12.0	16	5	123	5	44	90	5	<50mm	795.5	<50mm	<50mm	465.5	<50mm
Aux	WiFi	5320	12.5	18	5	123	5	44	90	5	<50mm	795.0	<50mm	<50mm	465.0	<50mm
Aux	WiFi	5700	11.0	13	5	123	5	44	90	5	<50mm	792.8	<50mm	<50mm	462.8	<50mm
Aux	WiFi	5825	8.5	7	5	123	5	44	90	5	<50mm	792.2	<50mm	<50mm	462.2	<50mm
Aux	BT	2480	6.0	4	5	123	5	44	90	5	<50mm	825.3	<50mm	<50mm	495.3	<50mm

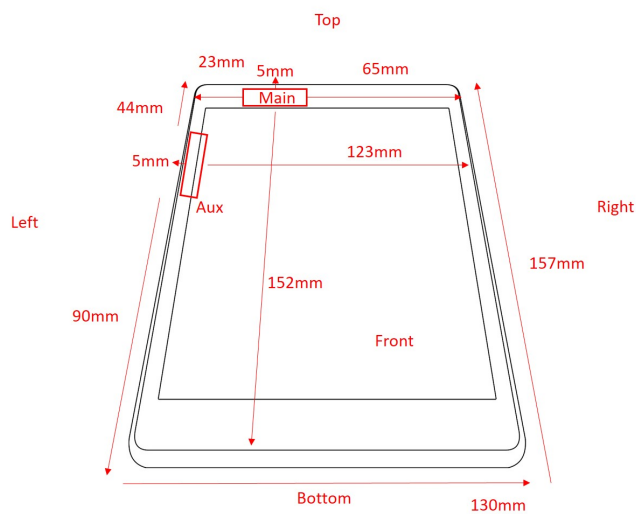



## 1.4 Test Environment

Ambient conditions in the laboratory:

Test Date: 2023/10/14 - 2023/10/18

Items	Required	Actual
Temperature (°C)	18-25	23 ± 2
Humidity (%RH)	30-70	50 ± 20

USA	FCC Registration Number: TW0033
Canada	CAB Identifier Number: TW3023 / Company Number: 26930

Site Description	Accredited by TAF
	Accredited Number: 3023

Test Laboratory	DEKRA Testing and Certification Co., Ltd.
	Linkou Laboratory
Address	No.5-22, Ruishukeng Linkou District, New Taipei City, 24451, Taiwan, R.O.C
Performed Location	No. 26, Huaya 1st Rd., Guishan Dist., Taoyuan City 333411, Taiwan, R.O.C.
Phone Number	+886-3-275-7255
Fax Number	+886-3-327-8031

---

## 1.5 Measurement procedures

IEEE 1528-2013

47CFR § 2.1093

KDB 248227 D01 v02r02

KDB 447498 D01 v06

KDB 616217 D04 v01r02

KDB 865664 D01 v01r04

## 2. SAR Measurement System

### 2.1 DASY System Description

SAR Configurations is shown below:

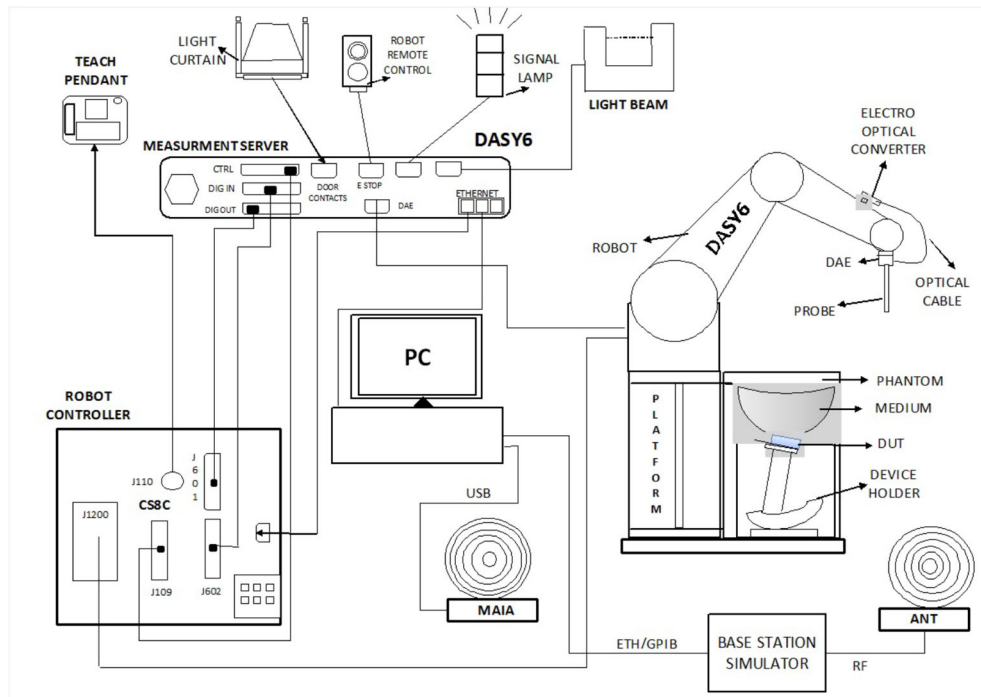

The DASY system for performing compliance tests consists of the following items:

- A standard high precision 6-axis robot with controller, teach pendant and software. An arm extension for accommodating the data acquisition electronics (DAE).
- A data acquisition electronics (DAE) which performs the signal amplification, signal multiplexing, AD-conversion, offset measurements, mechanical surface detection, collision detection, etc. The unit is battery powered with standard or rechargeable batteries. The signal is optically transmitted to the EOC.
- The Electro-optical converter (EOC) performs the conversion from optical to electrical signals for the digital communication to the DAE. To use optical surface detection, a special version of the EOC is required. The EOC signal is transmitted to the measurement server.
- The Light Beam used is for probe alignment. This improves the (absolute) accuracy of the probe positioning.
- A computer running Win7/8/10 and the DASY software.
- Remote control and teach pendant as well as additional circuitry for robot safety such as warning lamps, etc.
- The phantom, the device holder and other accessories according to the targeted measurement.

## 2.2 Area Scans

Area scans are defined prior to the measurement process being executed with a user defined variable spacing between each measurement point (integral) allowing low uncertainty measurements to be conducted. Scans defined for utilize a 10mm<sup>2</sup> step integral, with 1mm interpolation used to locate the peak SAR area used for zoom scan assessments.

When an Area Scan has measured all reachable points, it computes the field maxima found in the scanned area, within a range of the global maximum. The range (in dB) is specified in the standards for compliance testing.

### 2.2.1 Zoom Scan (Cube Scan Averaging)

Zoom Scans are used to assess the peak spatial SAR values within a cubic averaging volume containing 1 g and 10 g of simulated tissue. A density of 1000 kg/m<sup>3</sup> is used to represent the head and body tissue density and not the phantom liquid density, in order to be consistent with the definition of the liquid dielectric properties, i.e. the side length of the 1 g cube is 10mm, with the side length of the 10 g cube 21,5mm.

The zoom scan integer steps can be user defined so as to reduce uncertainty, but normal practice for typical test applications utilize a physical step of 5x5x7 (8mmx8mmx5mm) providing a volume of 32mm in the X & Y axis, and 30mm in the Z axis.

### 2.2.2 SAR measurement drifts

Before an area scan and after the zoom scan, single point SAR measurements are performed at defined locations to estimate the SAR measurement drift due to device output power variations. If a device is known to drift randomly, additional single point drift reference measurements should be performed at regular intervals throughout the area and zoom scan test durations. The SAR drift shall be kept within  $\pm 5\%$ , whether there are substantial drifts or not. The field difference will be calculated in dB units in the DASY software.

### 2.2.3 Uncertainty of Inter-/Extrapolation and Averaging

In order to evaluate the uncertainty of the interpolation, extrapolation and averaged SAR calculation algorithms of the Postprocessor, DASY allows the generation of measurement grids which are artificially predefined by analytically based test functions. Therefore, the grids of area scans and zoom scans can be filled with uncertainty test data, according to the SAR benchmark functions.

### 2.3 DASY E-Field Probe

The SAR measurement is conducted with the dosimetric probe manufactured by SPEAG. The probe is specially designed and calibrated for use in liquid with high permittivity. The dosimetric probe has special calibration in liquid at different frequency.

SPEAG conducts the probe calibration in compliance with international and national standards under ISO 17025.

The calibration data are in Appendix D.

#### Isotropic E-Field Probe Specification

<b>Model</b>	Ex3DV4	
<b>Construction</b>	Symmetrical design with triangular core Built-in shielding against static charges PEEK enclosure material (resistant to organic solvents, e.g., DGBE)	
<b>Frequency</b>	4 MHz – 10 GHz Linearity: $\pm 0.2$ dB (30 MHz to 10 GHz)	
<b>Directivity</b>	$\pm 0.1$ dB in TSL (rotation around probe axis) $\pm 0.3$ dB in TSL (rotation normal to probe axis)	
<b>Dynamic Range</b>	10 $\mu$ W/g to 100 mW/g Linearity: $\pm 0.2$ dB (noise: typically $< 1$ $\mu$ W/g)	
<b>Dimensions</b>	Overall length: 337 mm (Tip: 20 mm) Tip diameter: 2.5 mm (Body: 12 mm) Typical distance from probe tip to dipole centers: 1 mm	
<b>Application</b>	High precision dosimetric measurements in any exposure scenario (e.g., very strong gradient fields). Only probe which enables compliance testing for frequencies up to 6 GHz with precision of better 30%.	

### E-Field mm-Wave Probe Specification

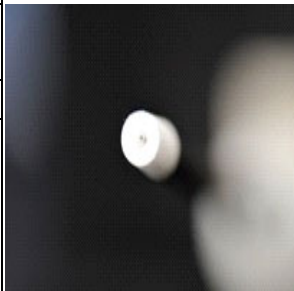
<b>Model</b>	EUmmWVx	
<b>Construction</b>	Two dipoles optimally arranged to obtain pseudo-vector information Minimum three measurements/point, 120° rotated around probe axis Sensors (0.8 mm length) printed on glass substrate protected by high density foam	
<b>Frequency</b>	750 MHz to 110 GHz	
<b>Dynamic Range</b>	< 20 V/m to 10000 V/m with PRE-10 (min < 20 V/m to 2000 V/m)	
<b>Position Precision</b>	< 0.2 mm	
<b>Dimensions</b>	Overall length: 337 mm (tip: 20 mm) Tip diameter: encapsulation 8 mm (internal sensor < 1mm) Distance from probe tip to dipole centers: < 2 mm Sensor displacement to probe's calibration point: < 0.3 mm	
<b>Application</b>	E-field measurements of 5G devices and other mm-wave transmitters operating above 10GHz in < 2 mm distance from device (free-space) Power density, H-field, and far-field analysis using total field reconstruction	

### 2.4 DATA Acquisition Electronics (DAE) and Measurement Server

The data acquisition electronics (DAE) consists of a highly sensitive electrometer-grade preamplifier with auto-zeroing, a channel and gain-switching multiplexer, a fast 16-bit AD-converter and a command decoder and control logic unit.

Transmission to the measurement server is accomplished through an optical downlink for data and status information as well as an optical uplink for commands and the clock.

The input impedance of the DAE4 is 200M Ohm; the inputs are symmetrical and floating. Common mode rejection is above 80dB.

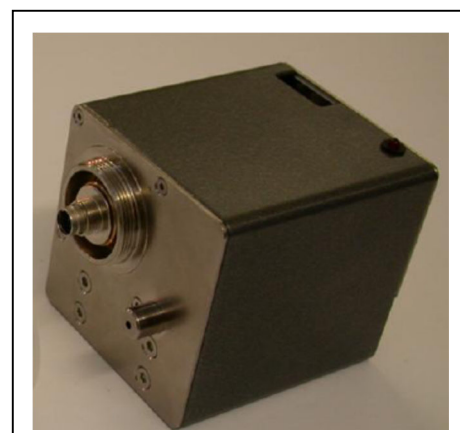

## 2.5 Robot

The DASY system uses the high precision robots TX90 XL type out of the newer series from Stäubli SA (France). For the 6-axis controller DASY system, the CS8C robot controller version from Stäubli is used.

The XL robot series have many features that are important for our application:

- High precision (repeatability 0.02 mm)
- High reliability (industrial design)
- Jerk-free straight movements
- Low ELF interference (the closed metallic construction shields against motor control fields)
- 6-axis controller



## 2.6 Device Holder

The DASY device holder is designed to cope with different positions given in the standard. It has two scales for the device rotation (with respect to the body axis) and the device inclination (with respect to the line between the ear reference points). The rotation center for both scales is the ear reference point (EPR).

Thus the device needs no repositioning when changing the angles.

The DASY device holder has been made out of low-loss POM material having the following dielectric parameters: relative permittivity  $\epsilon_r = 3$  and loss tangent  $\delta = 0.02$ . The amount of dielectric material has been reduced in the closest vicinity of the device, since measurements have suggested that the influence of the clamp on the test results could thus be lowered.

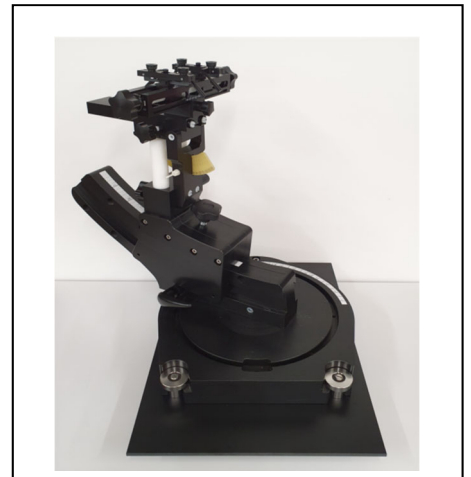

## 2.7 Phantom

### 2.7.1 SAM Twin Phantom

The SAM twin phantom is a fiberglass shell phantom with 2mm shell thickness (except the ear region where shell thickness increases to 6mm).

It has three measurement areas:

- Left head
- Right head
- Flat phantom

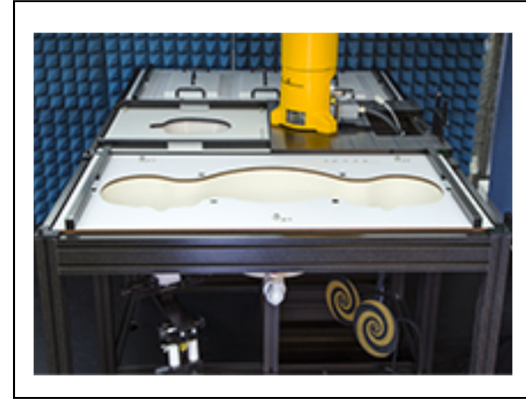

The device holder positions are adjusted to the standard measurement positions in the three sections. A cover is provided to tap the phantom during off-periods to prevent water evaporation and changes in the liquid parameters. On the phantom top, three reference markers are provided to identify the phantom position with respect to the robot.

### 2.7.2 mmWave Phantom

The mmWave Phantom approximates free-space conditions, allowing to evaluate not only the antenna side of the device but also the front (screen) side or any opposite-radiating side of wireless devices operating above 10 GHz without distorting the RF field. It consists of a 40 mm thick Rohacell plate used as a test bed, which has a loss tangent ( $\tan \delta$ )  $\leq 0.05$  and a relative permittivity ( $\epsilon_r$ )  $\leq 1.2$ . High-performance RF absorbers are placed below the foam.





### 3. Tissue Simulating Liquid

#### 3.1 The composition of the tissue simulating liquid

**Description:** Aqueous solution with surfactants and inhibitors

**Declarable, or hazardous components:**

CAS: 107-21-1 EINECS: 203-473-3 Reg.nr.: 01-2119456816-28-0000	<b>Ethenediol</b> STOT RE 2, H373; Acute Tox. 4, H302	< 5.2%
CAS: 68608-26-4 EINECS: 271-781-5 Reg.nr.: 01-2119527859-22-0000	<b>Sodium petroleum sulfonate</b> Eye Irrit. 2, H319	< 2.9%
CAS: 107-41-5 EINECS: 203-489-0 Reg.nr.: 01-2119539582-35-0000	<b>Hexylene Glycol / 2-Methyl-pentane-2,4-diol</b> Skin Irrit. 2, H315; Eye Irrit. 2, H319	< 2.9%
CAS: 68920-66-1 NLP: 500-236-9 Reg.nr.: 01-2119489407-26-0000	<b>Alkoxylated alcohol, &gt; C<sub>16</sub></b> Aquatic Chronic 2, H411; Skin Irrit. 2, H315; Eye Irrit. 2, H319	< 2.0%

#### 3.2 Tissue Calibration Result

The dielectric parameters of the liquids were verified prior to the SAR evaluation using Dielectric Probe Kit and Vector Network Analyzer.

Date	Tissue Type	Frequency (MHz)	Relative Permittivity (er)			Conductivity ( $\sigma$ )			Tissue Temp. (°C)
			Measured	Target	Delta (%)	Measured	Target	Delta (%)	
2023/10/14	Head	2450	39.96	39.20	1.94	1.78	1.80	-1.11	21.6
	Head	2412	40.10	39.28	2.09	1.74	1.77	-1.69	21.6
	Head	2422	40.06	39.26	2.04	1.75	1.78	-1.69	21.6
	Head	2437	40.01	39.26	2.04	1.77	1.78	-0.56	21.6
	Head	2441	39.99	39.22	1.96	1.77	1.79	-1.12	21.6
	Head	2452	39.95	39.22	1.96	1.79	1.79	0.00	21.6
	Head	2462	39.91	39.18	1.86	1.80	1.81	-0.55	21.6
2023/10/18	Head	5250	35.93	35.95	-0.06	4.61	4.71	-2.12	21.8
	Head	5270	35.87	35.93	-0.17	4.64	4.73	-1.90	21.8
	Head	5310	35.76	35.89	-0.36	4.69	4.77	-1.68	21.8
	Head	5600	34.96	35.50	-1.52	5.08	5.07	0.20	21.8
	Head	5530	35.15	35.61	-1.29	4.99	5.00	-0.20	21.8
	Head	5610	34.93	35.49	-1.58	5.10	5.08	0.39	21.8
	Head	5690	34.72	35.41	-1.95	5.20	5.16	0.78	21.8
	Head	5800	34.41	35.30	-2.52	5.34	5.27	1.33	21.8
	Head	5775	34.48	35.33	-2.41	5.31	5.25	1.14	21.8

### 3.3 Tissue Dielectric Parameters for Phantoms

The head tissue dielectric parameters recommended by the IEC/IEEE 62209-1528 have been incorporated in the following table. These head parameters are derived from planar layer models simulating the highest expected SAR for the dielectric properties and tissue thickness variations in a human head. Other head tissue parameters that have not been specified are interpolated according to the head parameters specified in IEC/IEEE 62209-1528.

Target Frequency (MHz)	Head	
	$\epsilon_r$	$\sigma$ (S/m)
450	43.5	0.87
750	41.9	0.89
835	41.5	0.90
900	41.5	0.97
1450	40.5	1.20
1640	40.2	1.31
1750	40.1	1.37
1800 – 2000	40.0	1.40
2450	39.2	1.80
3000	38.5	2.40
5000	36.2	4.45
5200	36.0	4.66
5400	35.8	4.86
5600	35.3	5.27
5800	35.3	5.27
6000	35.1	5.48
6500	34.5	6.07
7000	33.9	6.65
7500	33.3	7.24

## 4. Measurement Procedure

### 4.1 SAR System Check

#### 4.1.1 Dipoles



The SAR dipoles are optimized symmetrical dipole with  $\lambda/4$  balun matched to a Flat phantom section filled with tissue simulating liquids. The center conductor of the feeding line is directly connected to the second arm of the dipole. The antenna is therefore short-circuited for DC signals. They are available for the variety of frequencies between 300MHz and 10 GHz. The provided tripod is used to hold the dipole below the phantom. As the distance between the dipole center and the TSL is critical, a spacer is placed between the dipole and the phantom. The spacing distance is frequency dependent.

#### 4.1.2 SAR System Check Result

1. Comparing to the original SAR value provided by SPEAG, the verification data should be within its specification of 10 %.
2. Below table shows the target SAR and measured SAR after normalized to 1W input power. The table below indicates the system performance check can meet the variation criterion and the plots can be referred to Appendix A of this report.

Date	Frequency (MHz)	Input Power (mW)	Measured 1g SAR (W/kg)	Targeted 1g SAR (W/kg)	Normalized 1g SAR (W/kg)	Delta 1g $\pm 10$ (%)	Measured 10g SAR (W/kg)	Targeted 10g SAR (W/kg)	Normalized 10g SAR (W/kg)	Delta 10g $\pm 10$ (%)	Tissue Temp. ( $^{\circ}$ C)
2023/10/14	2450	250	12.80	52.40	51.2	-2.29	5.94	24.60	23.76	-3.41	21.6
2023/10/18	5250	100	8.09	80.80	80.9	0.12	2.31	23.20	23.1	-0.43	21.8
2023/10/18	5600	100	8.97	84.20	89.7	6.53	2.53	23.80	25.3	6.30	21.8
2023/10/18	5800	100	8.34	81.80	83.4	1.96	2.35	23.00	23.5	2.17	21.8

## 4.2 SAR Measurement Procedure

The Dasy calculates SAR using the following equation,

$$\text{SAR} = \frac{\sigma |E|^2}{\rho}$$

Where :

$\sigma$ : represents the simulated tissue conductivity

$\rho$ : represents the tissue density

E :RMS electric field strength (V/m)

The SAR / APD measurements for the EUT should be performed on the channel that produces the highest rated output power of each transmitting antenna.

Pre-scans are made on the device to establish the location for the transmitting antenna, using a large area scan in either air or tissue simulation fluid.

The EUT is placed against the Universal Phantom where the maximum area scan dimensions are larger than the physical size of the resonating antenna. When the scan size is not large enough to cover the peak SAR / APD distribution, it is modified by either extending the area scan size in both the X and Y directions, or the device is shifted within the predefined area.

The area scan is then run to establish the peak SAR / APD location (interpolated resolution set at 1mm<sup>2</sup>) which is then used to orient the center of the zoom scan. The zoom scan is then executed and the 1g and 10g averages are derived from the zoom scan volume (interpolated resolution set at 1mm<sup>3</sup>).

## 5. RF Exposure Limits

SAR assessments have been made in line with the requirements of IEEE-1528, RSS-102 Issue 5, and comply with ANSI/IEEE C95.1-1992 “Uncontrolled Environments” limits. These limits apply to a location which is deemed as “Uncontrolled Environment” which can be described as a situation where the general public may be exposed to an RF source with no prior knowledge or control over their exposure.

### Limits for General Population/Uncontrolled Exposure (W/kg)

Type Exposure	Uncontrolled Environment Limit
Spatial Peak SAR (1g cube tissue for brain or body)	<b>1.60 W/kg</b>
Spatial Average SAR (whole body)	<b>0.08 W/kg</b>
Spatial Peak SAR (10g for hands, feet, ankles and wrist)	<b>4.00 W/kg</b>
Power density <sup>1</sup>	<b>1 mW/cm<sup>2</sup></b>

Note: 1 mW/cm<sup>2</sup> = 10 W/m<sup>2</sup>

## 6. Test Equipment List

Instrument	Manufacturer	Model No.	Serial No.	Last Calibration	Next Calibration
Reference Dipole 2450MHz	Speag	D2450V2	930	2022/11/21	2025/11/20
Reference Dipole 5GHz	Speag	D5GHzV2	1321	2021/02/05	2024/02/04
Device Holder	Speag	N/A	N/A	N/A	N/A
Data Acquisition Electronic	Speag	DAE4	1425	2022/11/23	2023/11/22
E-Field Probe	Speag	EX3DV4	3979	2022/11/23	2023/11/22
SAR Software	Speag	DASY52	V52.10.4.1535	N/A	N/A
Power Amplifier	Mini-Circuit	ZVE-8G+	447202211	N/A	N/A
Directional Coupler	Agilent	87300C	MY44300353	N/A	N/A <sup>1</sup>
Attenuator	Woken	WATT-218FS-10	N/A	N/A	N/A <sup>1</sup>
Attenuator	Mini-Circuit	BW-S20W2+	N/A	N/A	N/A <sup>1</sup>
Vector Network Analyzer	Agilent	E5071C	MY46108013	2023/03/09	2024/03/08
Signal Generator	Anritsu	MG3694A	041902	2023/09/07	2024/09/06
Power Meter	Anritsu	ML2487A	6K00001447	2022/10/31	2023/10/30
Power Sensor	Anritsu	MA2411B	1339194	2022/10/31	2023/10/30

Note: 1. System Check, the path loss measured by the network analyzer, includes the signal generator, amplifier, cable, attenuator and directional coupler.

Note:

Per KDB 865664 D01 requirements for dipole calibration, the following are recommended FCC procedures for SAR dipole calibration.

1. After a dipole is damaged and properly repaired to meet required specifications.
2. When the measured SAR deviates from the calibrated SAR value by more than 10% due to changes in physical, mechanical, electrical or other relevant dipole conditions.
3. When the most recent return-loss, measured at least annually, deviates by more than 20% from the previous measurement (i.e. 0.2 of the dB value) or not meeting the required -20 dB return-loss specification.

	Frequency	Tissue	Return loss	Limit	Date
Calibration	5250 MHz	Head	-39.2	Within 20%	2021/2/5
Measurement	5250 MHz	Head	-39.38		2022/2/7
Measurement	5250 MHz	Head	-39.31		2023/2/2

	Frequency	Tissue	Return loss	Limit	Date
Calibration	5600 MHz	Head	-27.4	Within 20%	2021/2/5
Measurement	5600 MHz	Head	-26.91		2022/2/7
Measurement	5600 MHz	Head	-26.6		2023/2/2

	Frequency	Tissue	Return loss	Limit	Date
Calibration	5800 MHz	Head	-23.6	Within 20%	2021/2/5
Measurement	5800 MHz	Head	-26.92		2022/2/7
Measurement	5800 MHz	Head	-23.6		2023/2/2

4. When the most recent measurement of the real or imaginary parts of the impedance, measured at least annually, deviates by more than 5 Ω from the previous measurement.

	Frequency	Tissue	Return loss	Limit	Date
Calibration	5250 MHz	Head	50.8	Within 20%	2021/2/5
Measurement	5250 MHz	Head	50.86		2022/2/7
Measurement	5250 MHz	Head	49.95		2023/2/2

	Frequency	Tissue	Return loss	Limit	Date
Calibration	5600 MHz	Head	52.9	Within 20%	2021/2/5
Measurement	5600 MHz	Head	50.99		2022/2/7
Measurement	5600 MHz	Head	50.11		2023/2/2

	Frequency	Tissue	Return loss	Limit	Date
Calibration	5800 MHz	Head	53.0	Within 20%	2021/2/5
Measurement	5800 MHz	Head	51.12		2022/2/7
Measurement	5800 MHz	Head	51.06		2023/2/2



## 7. Measurement Uncertainty

Measurement uncertainty for 300 MHz to 3 GHz							
Error Description	Uncert. value	Prob. Dist.	Div.	(ci) 1g	(ci) 10g	Std. Unc. (1g)	Std. Unc. (10g)
<b>Measurement System Errors</b>							
Probe Calibration	±12.0%	N	2	1	1	±6.0%	±6.0%
Probe Calibration Drift	±1.7%	R	1.732	1	1	±1.0%	±1.0%
Probe Linearity	±4.7%	R	1.732	1	1	±2.7%	±2.7%
Broadband Signal	±2.8%	R	1.732	1	1	±1.6%	±1.6%
Probe Isotropy	±7.6%	R	1.732	1	1	±4.4%	±4.4%
Other Probe+Electronic	±0.8%	N	1	1	1	±0.8%	±0.8%
RF Ambient	±1.8%	N	1	1	1	±1.8%	±1.8%
Probe Positioning	±0.006 mm	N	1	0.14	0.14	±0.1%	±0.1%
Data Processing	±1.2%	N	1	1	1	±1.2%	±1.2%
<b>Phantom and Device Errors</b>							
Conductivity (meas.)	±2.5%	N	1	0.78	0.71	±2.0%	±1.8%
Conductivity (temp.)	±3.3%	R	1.732	0.78	0.71	±1.5%	±1.4%
Phantom Permittivity	±14.0%	R	1.732	0	0	±0.0%	±0.0%
Distance DUT - TSL	±2.0%	N	1	2	2	±4.0%	±4.0%
Device Positioning	±1.0%	N	1	1	1	±1.0%	±1.0%
Device Holder	±3.6%	N	1	1	1	±3.6%	±3.6%
DUT Modulation	±2.4%	R	1.732	1	1	±1.4%	±1.4%
Time-average SAR	±1.7%	R	1.732	1	1	±1.0%	±1.0%
DUT drift	±2.5%	N	1	1	1	±2.5%	±2.5%
Val Antenna Unc.	±0.0%	N	1	1	1	±0.0%	±0.0%
Unc. Input Power	±0.0%	N	1	1	1	±0.0%	±0.0%
<b>Correction to the SAR results</b>							
Deviation to Target	±1.9%	N	1	1	0.84	±1.9%	±1.6%
SAR scaling	±0.0%	R	1.732	1	1	±0.0%	±0.0%
<b>Combined Uncertainty</b>						±11.0%	±10.9%
<b>Expanded Uncertainty</b>						±21.9%	±21.7%

Measurement uncertainty for 3 GHz to 6 GHz							
Error Description	Uncert. value	Prob. Dist.	Div.	(ci) 1g	(ci) 10g	Std. Unc. (1g)	Std. Unc. (10g)
<b>Measurement System Errors</b>							
Probe Calibration	±14.0%	N	2	1	1	±7.0%	±7.0%
Probe Calibration Drift	±1.7%	R	1.732	1	1	±1.0%	±1.0%
Probe Linearity	±4.7%	R	1.732	1	1	±2.7%	±2.7%
Broadband Signal	±2.6%	R	1.732	1	1	±1.5%	±1.5%
Probe Isotropy	±7.6%	R	1.732	1	1	±4.4%	±4.4%
Other Probe+Electronic	±1.2%	N	1	1	1	±1.2%	±1.2%
RF Ambient	±1.8%	N	1	1	1	±1.8%	±1.8%
Probe Positioning	±0.005 mm	N	1	0.29	0.29	±0.2%	±0.2%
Data Processing	±2.3%	N	1	1	1	±2.3%	±2.3%
<b>Phantom and Device Errors</b>							
Conductivity (meas.)	±2.5%	N	1	0.78	0.71	±2.0%	±1.8%
Conductivity (temp.)	±3.4%	R	1.732	0.78	0.71	±1.5%	±1.4%
Phantom Permittivity	±14.0%	R	1.732	0.25	0.25	±2.0%	±2.0%
Distance DUT - TSL	±2.0%	N	1	2	2	±4.0%	±4.0%
Device Positioning	±1.0%	N	1	1	1	±1.0%	±1.0%
Device Holder	±3.6%	N	1	1	1	±3.6%	±3.6%
DUT Modulation	±2.4%	R	1.732	1	1	±1.4%	±1.4%
Time-average SAR	±1.7%	R	1.732	1	1	±1.0%	±1.0%
DUT drift	±2.5%	N	1	1	1	±2.5%	±2.5%
Val Antenna Unc.	±0.0%	N	1	1	1	±0.0%	±0.0%
Unc. Input Power	±0.0%	N	1	1	1	±0.0%	±0.0%
<b>Correction to the SAR results</b>							
Deviation to Target	±1.9%	N	1	1	0.84	±1.9%	±1.6%
SAR scaling	±0.0%	R	1.732	1	1	±0.0%	±0.0%
<b>Combined Uncertainty</b>						±11.9%	±11.8%
<b>Expanded Uncertainty</b>						±23.8%	±23.6%

### 8. Conducted Power Measurement (Including tolerance allowed for production unit)

WLAN 2.4G 2TX SISO									
DSSS/OFDM mode specified maximum output power at an antenna port	Frequency	Mode	BW	SISO-Main(TX1)			SISO-Aux(TX2)		
				CH	AV Power	AV Target	CH	AV Power	AV Target
WLAN 2.4GHz	b	20	1	14.59	15	1	14.87	15	
			6	14.69	15	6	14.03	15	
			11	14.71	15	11	14.16	15	
		g	20	1	11.13	12	1	11.94	12
				3	15.99	17	3	16.27	17
				6	16.31	17	6	16.41	17
				9	16.25	17	9	16.35	17
				11	11.28	12	11	11.32	12
		n (HT)	20	1	11.67	12	1	10.92	12
	3			15.85	17	3	16.1	17	
	6			15.88	17	6	16.22	17	
	9			15.74	17	9	16.26	17	
	11			11.84	12	11	11.27	12	
	ac (VHT)	20	1	11.52	12	1	11.05	12	
			3	15.88	17	3	16.13	17	
			6	15.91	17	6	16.28	17	
			9	15.85	17	9	16.15	17	
			11	11.71	12	11	11.55	12	

WLAN 5G 2TX SISO																			
Frequency	Mode	BW	SISO-Main(TX1)			SISO-Aux(TX2)			Frequency	Mode	BW	SISO-Main(TX1)			SISO-Aux(TX2)				
			CH	AV Power	AV Target	CH	AV Power	AV Target				CH	AV Power	AV Target	CH	AV Power	AV Target		
U-NII-1 (5150~5250MHz)	a	20	36	9.52	10	36	9.35	10	U-NII-2C (5470~5725MHz)	a	20	100	9.51	11	100	9.57	11		
			40	9.42	10	40	9.45	10				112	9.28	11	112	9.35	11		
			44	9.42	10	44	9.52	10				116	9.36	11	116	9.51	11		
			48	9.35	10	48	9.41	10				128	9.53	11	128	9.36	11		
	n (HT)	20	36	9.74	10	36	9.52	10		n (HT)	20	100	9.78	11	100	9.77	11		
			40	9.71	10	40	9.62	10				112	9.51	11	112	9.54	11		
			44	9.65	10	44	9.71	10				116	9.59	11	116	9.68	11		
			48	9.6	10	48	9.59	10				128	9.49	11	128	9.55	11		
	ac(VHT)	80	38	8.64	9	38	8.41	9		ac(VHT)	40	102	8.79	9	102	8.88	9		
			46	11.6	12	46	11.6	12				110	9.41	11	110	9.16	11		
	U-NII-2A (5250~5350MHz)	a	20	52	10.34	12.5	52	10.32		12.5	U-NII-3 (5725~5850MHz)	ac(VHT)	80	138	10.31	11	138	10.44	11
				56	10.33	12.5	56	11.22		12.5				106	6.91	7	106	6.96	7
				60	11.21	12.5	60	11.37		12.5				122	10.58	11	122	10.49	11
				64	11.26	12	64	11.34		12									
		n (HT)	20	52	10.58	12.5	52	10.51		12.5		a	20	149	6.68	8.5	149	7.12	8.5
				56	10.57	12.5	56	10.43		12.5				157	7.32	8.5	157	7.06	8.5
60				10.49	12.5	60	10.61	12.5	165	6.92				8.5	165	7.82	8.5		
64				10.51	12	64	10.55	12	n (HT)	20				149	7.78	8.5	149	7.31	8.5
54		11.68	12.5	54	11.61	12.5	157	7.45				8.5	157	7.25	8.5				
62		8.92	9	62	8.94	9	165	7.07				8.5	165	7.07	8.5				
80		58	6.12	7	58	6.72	7	151				7.67	8.5	151	7.05	8.5			
ac(VHT)		80							ac(VHT)	80		155	8.45	8.5	155	7.69	8.5		

OFDM mode specified maximum output power at an antenna port

BT Only Support Aux						
Bluetooth mode maximum output power	Frequency	Mode	Modulation	SISO-Aux(TX2)		
				CH	AV Power	AV Target
Bluetooth mode maximum output power	BT 2.4GHz	BR	GFSK	0	5.15	6
				39	5.56	6
				78	5.03	6
		EDR	8DPSK	0	2.35	3
				39	2.99	3
				78	2.52	3
		BLE	GFSK	0	4.81	6
				19	4.79	6
				39	4.4	6

## 9. Test Results

### 9.1 Test Results Summary

SAR MEASUREMENT								
Ambient Temperature (°C): 22.7±2					Relative Humidity (%): 51%			
Liquid Temperature (°C): 21.6±2					Depth of Liquid (cm): >15			
Test Position	Dist. (mm)	Frequency		Conducted Power (dBm)		SAR (W/kg)		Plot No.
		Ch.	MHz	Meas.	Tune-Up Limit	Meas-1g	Scaled-1g	
Test Mode: WLAN2.4GHz_802.11g-6M_Ant Main								
Front	5	6	2437	16.31	17	0.412	0.483	
Back	5	6	2437	16.31	17	0.165	0.193	
Left-side	5	6	2437	16.31	17	0.067	0.079	
Top	5	1	2412	11.13	12	0.372	0.455	
Top	5	3	2422	15.99	17	0.789	0.996	
Top	5	6	2437	16.31	17	0.852	0.999	
Top	5	9	2452	16.25	17	0.906	<b>1.077</b>	3
Top	5	11	2462	11.28	12	0.327	0.386	
Test Mode: WLAN2.4GHz_802.11g-6M_Ant Aux								
Front	5	6	2437	16.41	17	0.020	0.023	
Back	5	6	2437	16.41	17	0.027	0.030	
Left-side	5	1	2412	11.94	12	0.032	0.032	
Left-side	5	3	2422	16.27	17	0.090	0.107	
Left-side	5	6	2437	16.41	17	0.066	0.075	
Left-side	5	9	2452	16.35	17	0.077	0.089	
Left-side	5	11	2462	11.32	12	0.021	0.025	
Test Mode: Bluetooth_BT-1M_Ant Aux								
Left-side	5	39	2441	5.56	6	0.00292	0.003	45

Note:

1. When the highest reported SAR for DSSS is adjusted by the ratio of OFDM to DSSS specified maximum output power and the adjusted SAR is  $\leq 1.2$  W/kg, SAR is not required.
2. When the reported SAR of the highest measured maximum output power channel for the exposure configuration is  $\leq 0.8$  W/kg, no further SAR testing is required for 802.11b DSSS in that exposure configuration.

SAR MEASUREMENT								
Ambient Temperature (°C): 22.7±2					Relative Humidity (%): 50%			
Liquid Temperature (°C): 21.8±2					Depth of Liquid (cm): >15			
Test Position	Dist. (mm)	Frequency		Conducted Power (dBm)		SAR (W/kg)		Plot No.
		Ch.	MHz	Meas.	Tune-Up Limit	Meas-1g	Scaled-1g	
Test Mode: WLAN5GHz_802.11n40-HT0_Ant Main								
Front	5	54	5270	11.68	12.5	0.140	0.169	
Back	5	54	5270	11.68	12.5	0.070	0.085	
Left-side	5	54	5270	11.68	12.5	0.053	0.064	
Top	5	54	5270	11.68	12.5	0.831	<b>1.004</b>	8
Top	5	62	5310	8.92	9	0.767	0.781	
Test Mode: WLAN5GHz_802.11n40-HT0_Ant Aux								
Front	5	54	5270	11.61	12.5	0.045	0.055	
Back	5	54	5270	11.61	12.5	0.00929	0.011	
Left-side	5	54	5270	11.61	12.5	0.133	0.163	
Left-side	5	62	5310	8.94	9	0.132	0.134	
Test Mode: WLAN5GHz_802.11ac80-VHT0_Ant Main								
Front	5	138	5690	10.31	11	0.456	0.535	
Back	5	138	5690	10.31	11	0.272	0.319	
Left-side	5	138	5690	10.31	11	0.017	0.020	
Top	5	106	5530	6.91	7	0.632	0.645	
Top	5	122	5610	10.58	11	0.748	0.824	
Top	5	138	5690	10.44	11	0.826	<b>0.940</b>	11
Test Mode: WLAN5GHz_802.11ac80-VHT0_Ant Aux								
Front	5	138	5690	10.44	11	0.015	0.017	
Back	5	138	5690	10.44	11	0.011	0.013	
Left-side	5	106	5530	6.96	7	0.028	0.028	
Left-side	5	122	5610	10.49	11	0.043	0.048	
Left-side	5	138	5690	10.44	11	0.048	0.055	
Test Mode: WLAN5GHz_802.11ac80-VHT0_Ant Main								
Front	5	155	5775	8.45	8.5	0.286	0.289	
Back	5	155	5775	8.45	8.5	0.171	0.173	
Left-side	5	155	5775	8.45	8.5	0.00904	0.009	
Top	5	155	5775	8.45	8.5	0.753	<b>0.762</b>	6
Test Mode: WLAN5GHz_802.11ac80-VHT0_Ant Aux								
Front	5	155	5775	7.69	8.5	0.012	0.015	
Back	5	155	5775	7.69	8.5	0.00947	0.011	
Left-side	5	155	5775	7.69	8.5	0.030	0.036	

Note:

1. When multiple transmission modes have the same specified maximum output power, largest channel bandwidth, lowest order modulation and lowest data rate, the lowest order 802.11 mode is selected
2. When the reported SAR of the highest measured maximum output power channel for the exposure configuration is ≤ 0.8 W/kg, no further SAR testing is required in that exposure configuration.
3. When the reported SAR of the highest measured maximum U-NII-2A for the exposure configuration is ≤ 1.2 W/kg, SAR is not required for U-NII-1 band.

## 9.2 Simultaneous Transmission

Simultaneous Transmission Configurations	
1	WLAN 2.4 GHz ANT Main + WLAN 2.4 GHz ANT Aux + Bluetooth Aux
2	WLAN 5 GHz ANT Main + WLAN 5 GHz ANT Aux + Bluetooth Aux
3	WLAN 2.4 GHz ANT Main + WLAN 2.4 GHz ANT Aux
4	WLAN 5 GHz ANT Main + WLAN 5 GHz ANT Aux

### 9.2.1 Simultaneous transmission test exclusion considerations

Test Position	1	2	3	4	5	1 + 2 + 5	3 + 4 + 5	1 + 2	3 + 4
	WLAN2.4GHz ANT Main (W/kg)	WLAN2.4GHz ANT Aux (W/kg)	WLAN5GHz ANT Main (W/kg)	WLAN5GHz ANT Aux (W/kg)	Bluetooth ANT Aux (W/kg)	$\Sigma$ 1-g SAR	$\Sigma$ 1-g SAR	$\Sigma$ 1-g SAR	$\Sigma$ 1-g SAR
Front at 5 mm	0.483	0.023	0.535	0.055	0.003	0.509	0.593	0.506	0.590
Back at 5 mm	0.193	0.030	0.319	0.013	0.003	0.226	0.335	0.223	0.332
Left-side at 5 mm	0.079	0.107	0.064	0.163	0.003	0.189	0.230	0.186	0.227
Top at 5 mm	1.077	-	1.004	-	0.003	1.080	1.007	1.077	1.004

When the sum of SAR is larger than the limit, The ratio is determined by  $(SAR1 + SAR2)^{1.5/R_i}$ , rounded to two decimal digits, and must be  $\leq 0.04$  for all antenna pairs in the configuration to qualify for 1-g SAR test exclusion. The estimation result as below:



## 10. SAR measurement variability

- 1) Repeated measurement is not required when the original highest measured SAR is  $< 0.80$  W/kg; steps 2) through 4) do not apply.
- 2) When the original highest measured SAR is  $\geq 0.80$  W/kg, repeat that measurement once.
- 3) Perform a second repeated measurement only if the ratio of largest to smallest SAR for the original and first repeated measurements is  $> 1.20$  or when the original or repeated measurement is  $\geq 1.45$  W/kg (~ 10% from the 1-g SAR limit).
- 4) Perform a third repeated measurement only if the original, first or second repeated measurement is  $\geq 1.5$  W/kg and the ratio of largest to smallest SAR for the original, first and second repeated measurements is  $> 1.20$ .

Frequency		SAR 1g (W/kg)						
Channel	MHz	Original	First Repeated		Second Repeated		Third Repeated	
			Value	Ratio	Value	Ratio	Value	Ratio
9	2452	0.906	0.900	1.007	N/A	N/A	N/A	N/A
54	5270	0.831	0.785	1.059	N/A	N/A	N/A	N/A

---

**Appendix**

**Appendix A. System Check Data**

**Appendix B. Highest measurement Data**

**Appendix C. Test Setup Photographs**

**Appendix D. Probe Calibration Data**

**Appendix E. Dipole Calibration Data**

**Appendix F. Product Photos-Please refer to the file: 2380785R-Product Photos**