

**Back Key**  
**Enter Key**  
**JogDial**  
**+/- Key**  
**Reset**

[How to open the set-up screen.]

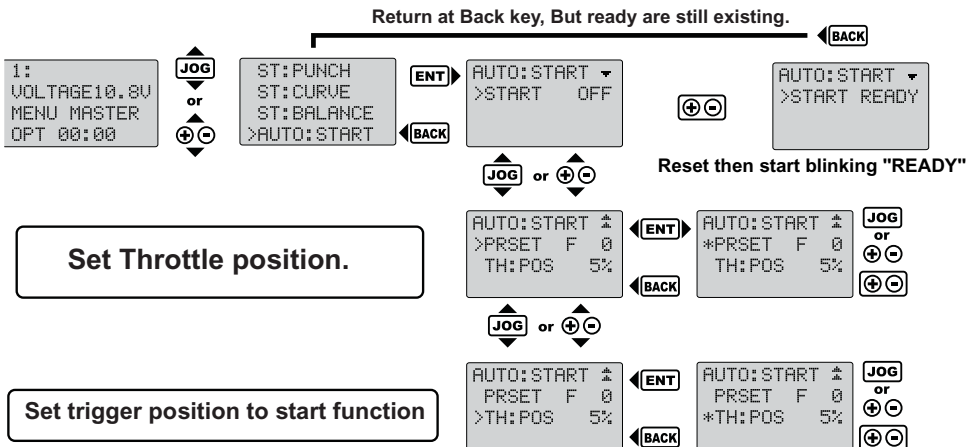

1 Pull the trigger to turn on the TH:POS function



2 When back the trigger display OFF.



- 1 From initial screen. use "Jog dial" key or "+,-" keys. to open Function menu.
- 2 Use "Jog dial" key or "+,-" keys. to choose the "AUTO:START" from Menu list.
- 3 When reset at first screen. AUTO START function will be waiting mode  
Use Jog dial or + , - keys to move at setup screen  
(Can not move to setup screen While blinking the "READY")
- 4 Push enter key to change the cursor. to editable each item.  
Setup value can reset by push reset key.
- 5 Push Enter or Back key to return to Menu list.

- PRESET : Position of throttle when function the AUTO START  
Initial Value F 0 Max F150 Min F 0
- TH:POS : Position to start AUTO START  
Initial Value 5% Max 100% Min 5% or OFF

When came back during on and off light, it is still effective



●Please check the movement before use.

**Back Key**  
**Enter Key**  
**JogDial**  
**+/- Key**  
**Reset**

## Copy the data in Model memory to other Model memory.

Save the current Model memory to other Model memory.  
 Can select setup that match to the condition of track  
 It will better to be copied to other memory before changing setting.

[How to open the set-up screen.]

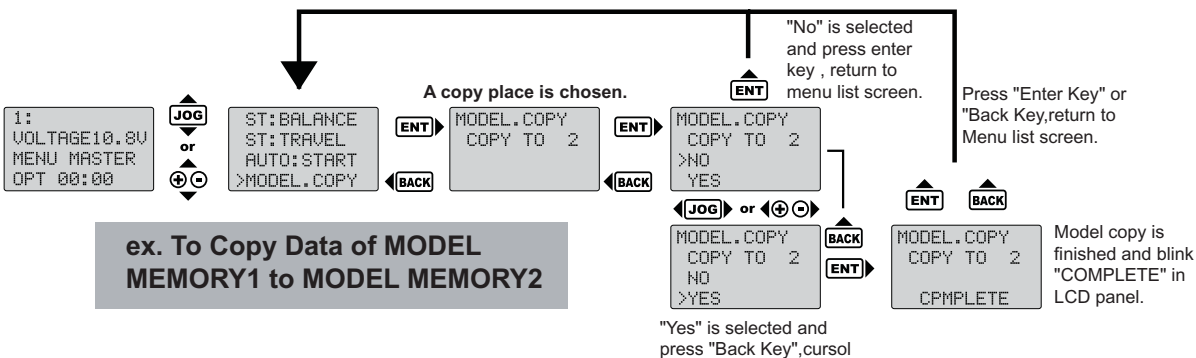

- 1 From initial screen. use "Jog dial" key or "+,-" keys. to open Function menu.
- 2 Use "Jog dial" key or "+,-" keys. to choose the "MODEL.COPY" from Menu list.
- 3 Push "Enter" key. to enter setup menu. use "Jog dial" key or "+,-" keys. to Select Model Memory number.
- 4 Use "Jog dial" key or "+,-" keys. then push "Enter" key  
 When Select YES then push "ENTER" key: Do MODEL COPY then display "COMPLETE"  
 When Select NO then push "ENTER" key: Back to Menu list  
 When Select YES then push "BACK" key: Cursor will mmove to NO  
 When Select NO then push "BACK" key: Beep sound
- 5 Push "ENTER" key or "BACK" key to Return to Menu list, If Model Copy was done and "COMPLETE" displayed at screen

It is useful When used in the following situation.

- Save the Current data and then try the New setup.
- Move the data from Data Pack
- Can swap the other data to the memory
  - \* Can copy the Data. but the setup data can not copy to the unit

Overwritten data aren't restored. Please confirm it before execution well.

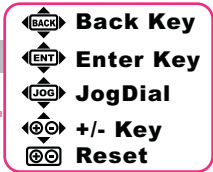

## Put name at Model memory

Put the name for Identified model memory

[How to open the set-up screen.]

- 1 From initial screen. use "Jog dial" key or "+,-" keys. to open Function menu.
- 2 Use "Jog dial" key or "+,-" keys. to choose the "MODEL.NAME" from Menu list.
- 3 Push "Enter" key. to enter setup menu. use "Jog dial" key or "+,-" keys. to adjust the value.
- 4 The letter which can input till 10 characters.  
Push enter after select.

●An usable letter:

& ' ( ) \* + , - . / 0 1 2 3 4 5 6 7 8 9 : ; < = > ?  
 ABCDEFGHIJKLMNOPQRSTUVWXYZabcdefghijklmnopqrstuvwxyz ·  
 ゾァィゥェォャュョァィウエオカキクケコサシスセソタチツテトナニヌネノハヒフヘホ  
 マミムメモヤユヨラリルレロワン ° (Space)

- When enter or edit the name. use Jog dial or +, - key to move the cursor to edit or enter the characters.
- Can use at initial screen and model select that model name.

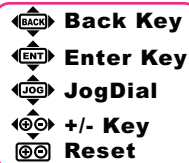

## Format to factory setting the model memory.

Model memory will Back to factory setting.  
Format all data of model memory.

[How to open the set-up screen.]

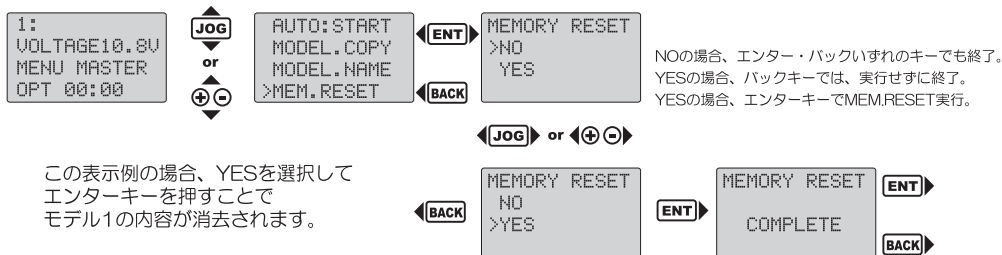

- 1** From initial screen. use "Jog dial" key or "+,-" keys. to open Function menu.
- 2** Use "Jog dial" key or "+,-" keys. to choose the "MEM.REST" from Menu list.
- 3** Push "Enter" key. to enter setup menu. use "Jog dial" key or "+,-" keys. to choose Yes/No.
- 4** Back to menu list When push back key.  
"Yes" is selected and press "Enter Key", delete model memory.

- Only model memory in use is erased.
- Setting of a main menu isn't deleted.

Erased data aren't restored. Please confirm it before execution well.



advice

- Use data pack to save the setup.

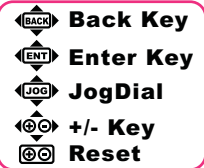

## Update information in a system of the VR that consumed.

[How to open setup screen]

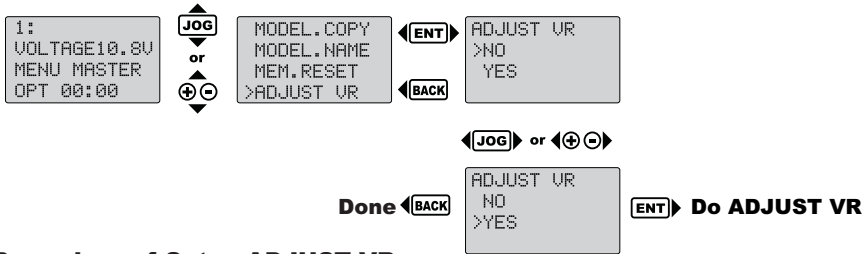

### Procedure of Setup ADJUST VR

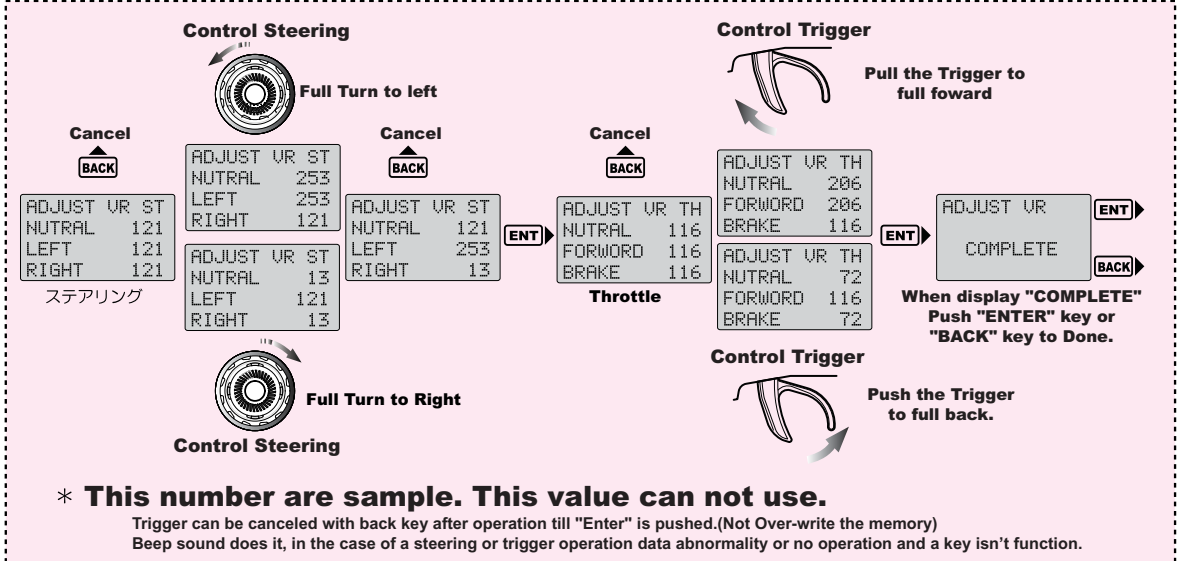

**1** From initial screen. use "Jog dial" key or "+,-" keys. to open Function menu.

**2** Use "Jog dial" key or "+,-" keys. to choose the "ADJUST VR" from Menu list.

**3** Move to yes/no to control "Jog dial" key or "+,-" keys.

Push Back key to return to Menu list.

**4** Select No: Return to Menu list  
Select Yes: Do Adjust VR.

- When push "ENTER". not to touch Steering wheel or throttle trigger during execution of "ADJUST VR".
- This Function for Cancellation of inconvenience of Consumption of the volume.
- It is depend on your Use frequency and An operation method.
- When Even this function can not fix the problems, please send to our service department to repair.



●Cause of trouble When use this function imperfectly.

●Recommend to send to our service department for repair, when you are not familiar with this function.



Select 2 Channel or 3 channel. Also select the switch at back of module

When the switch are in High response mode

2channel : Advanced High Speed Response

3channel : Super High Speed Response

**[How to open the set-up screen.]**

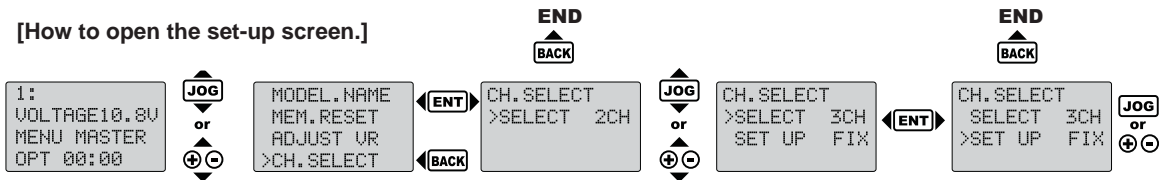

**Push Enter to Move between Item to Item  
Push Back to return to menu.  
Use Jog dial to control CH3 Select Function**

- 1** From initial screen, open the function menu. use "Jog dial" or "+, -" key.
- 2** At menu list, Move the cursor to the CH.SELECT. use "Jog dial" or "+, -" key. then push Enter.
- 3** To control Jog dial to select 2or 3 channel. When select 3 channel. the "setup" will display at lower part of screen. then can select the control function for 3rd channel
- 4** Push Back key to return to menu list.

When setting of 3CH are in "FIX": Signal in itself is fired, but can't control a signal because it was fixed  
When assign to BT or ET. can function as switch movement.  
or can assign reverse switch to change movement directions

● **The movement of channel 3 is adjust max and min of rudder angle (switch-movement)**

● **About Response mode: This unit can select from 3 kind of response mode**

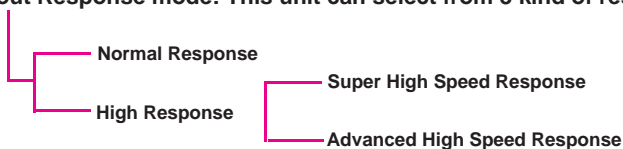

Normal Response

This mode can use all type of servo and receiver.

Super High Speed Response



This mode is adopted in MARS-R. Old receiver and Servo can't be used at this mode. but the response are improved.

Advanced High Speed Response



This mode can show the original speed. Digital servo is required for this mode.



● Please see page 19 about details of response mode.

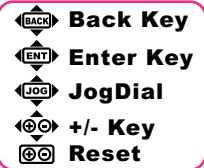

## Set the direction of movement of each channel.

Can Set the direction of movement of each channel.

Use this function when the turing direction of servo is opposite to the wheel/trigger operation.

[How to open the set-up screen.]

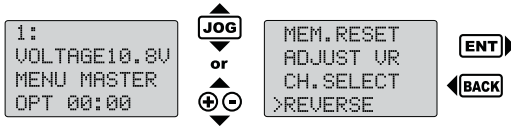

### Can change selected Channel

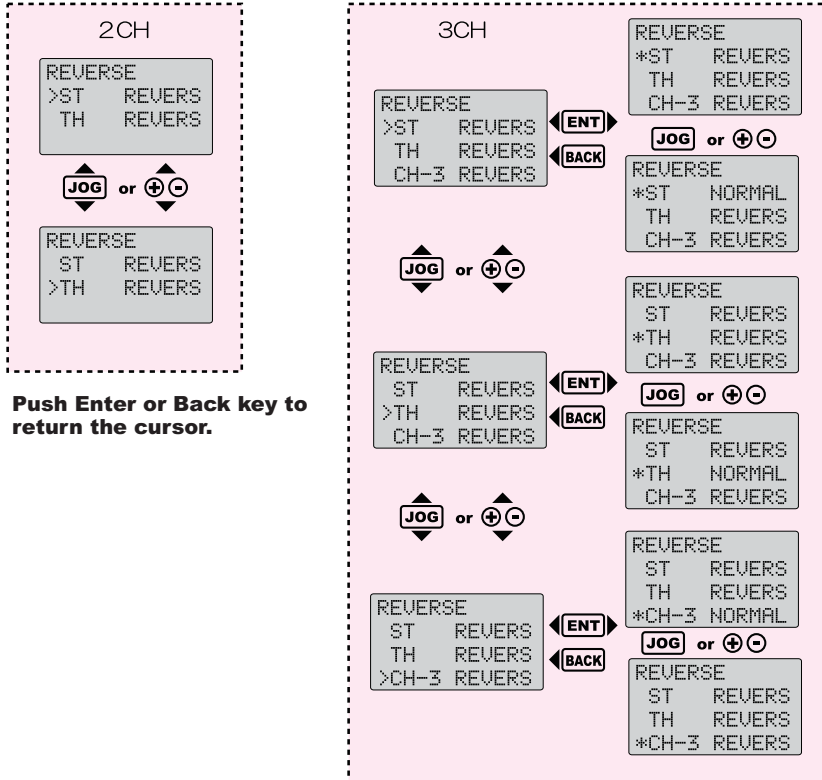

Push Enter or Back key to return the cursor.

- 1 From initial screen. use "Jog dial" key or "+,-" keys. to open Function menu.
- 2 Use "Jog dial" key or "+,-" keys. to choose the "REVERSE" from Menu list.
- 3 Push "Enter" key. to enter setup menu. use "Jog dial" key or "+,-" keys. to adjust the value.  
\* The menu for 3ch will display, when selected the CH.SELECT. (page 57)
- 4 Push back key to back to menu list.

● In an Electric car an ESC will adjust Throttle. When reverse isn't set up, it's not work normally at old ESC.

● A movement direction of steering are depend on each cars. Check the setup after mount to the car.

**Back Key**  
**Enter Key**  
**JogDial**  
**+/- Key**  
**Reset**

## Adjust Movement volume of the one step of Trim.

Total step of Trim are 100, adjust Movement volume of the one step of Trim.

[How to open the set-up screen.]

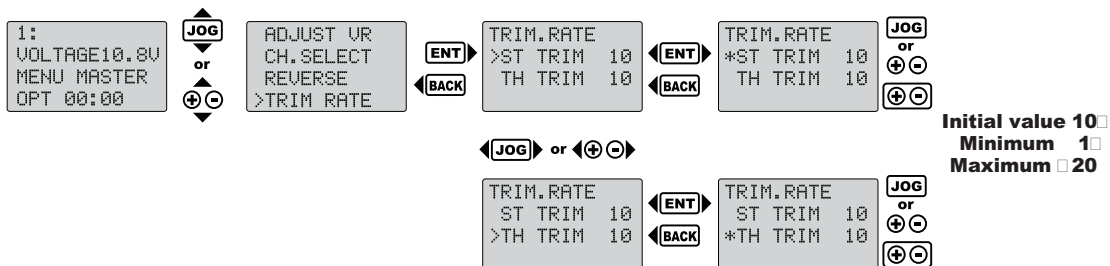

- 1 From initial screen. use "Jog dial" key or "+,-" keys. to open Function menu.
- 2 Use "Jog dial" key or "+,-" keys. to choose the "TRIM.RATE" from Menu list.
- 3 Push "Enter" key. to enter setup menu. use "Jog dial" key or "+,-" keys. to adjust the value.
- 4 Press "EnterKey or "Back Key",change cursol \* to >.And press "Back Key ",retuen to function menu list screen.

- 1 step of trim Be variable. Movement volume comes to have a small the one where a number is small

- The number of total step doesn't change. When change trim rate, The range that can adjust will change.

- Is cause to out of setting the trim when make a change with the situation that was already adjusted

### advice

- Can do close adjustment when make a rate to trim small. but some of servo An enough effect isn't provided
- Please do a review of linkage, Before doing particular setting of trim.



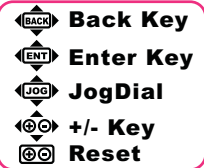

## Assign the function to ET, BT

Can assign to ET or to BT Various functions.

Some of function assign at first. but they can change it to customize.

### [How to open the set-up screen.]

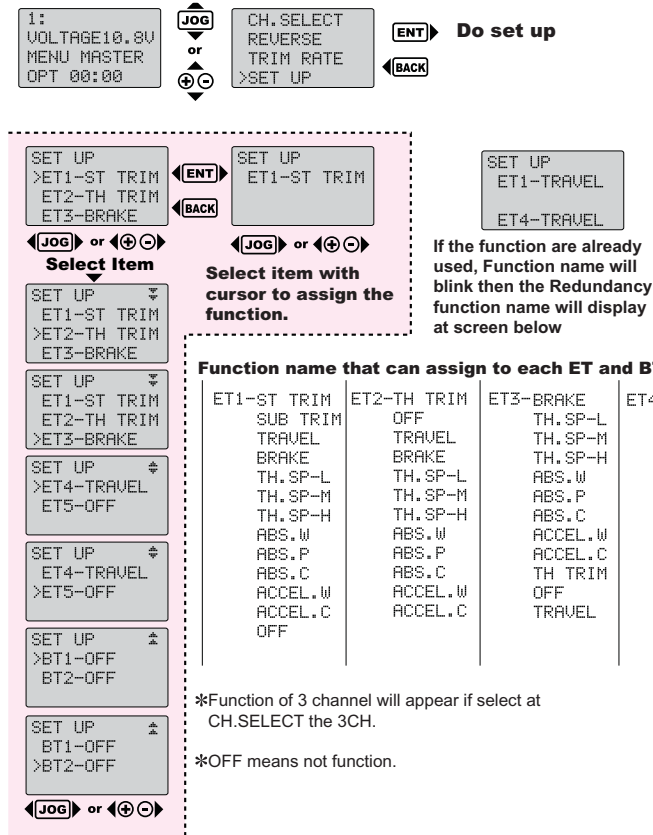

### Indication contents of each function.

OFF:	None
ST TRIM:	Steering Trim
SUB TRIM:	Steering Sub Trim
TRAVEL:	Steering Travel
BRAKE:	Trottle Brake
TH.SP-L:	Throttle Speed (Low Speed)
TH.SP-M:	Throttle Speed (Medium Speed)
TH.SP-H:	Throttle Speed (High speed)
ABS.W:	ABS (Width)
ABS.P:	ABS (Position)
ABS.C:	ABS (Cycle)
ACCEL.W:	Throttle acceleration (Width)
ACCEL.C:	Throttle acceleration (Cycle)
TH TRIM:	Throttle Trim
TH SPEED:	Throttle Speed On/Off
ABS:	ABS On/Off
ACCEL:	Throttle acceleration On/Off
UPTIM:	Up Timer
LAPTIM:	Lap Timer
DOWNTIM:	Down Timer
PRESET:	Preset the Throttle
CH3:	3 channels control

- 1 From initial screen open function menu by Jog dial or +, - keys.
- 2 From menu list select SETUP then push Enter key.
- 3 Select ET or BT to assign the function by Jog dial or +, - keys.
- 4 Use Jog dial or +, - key to set function name. if it is already assign.
- 5 Push back key: cancel the setup and return to Setup menu.  
Push Enter key: accept changes of setup and return to Setup menu.





## Set Down timer

It is a timer subtracted from time set up.

Use When a timing of fuel refueling of an engine car is measured.

### [How to open the set-up screen.]

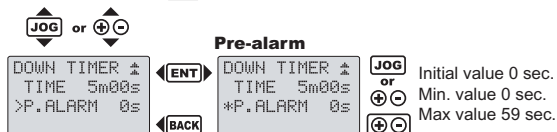
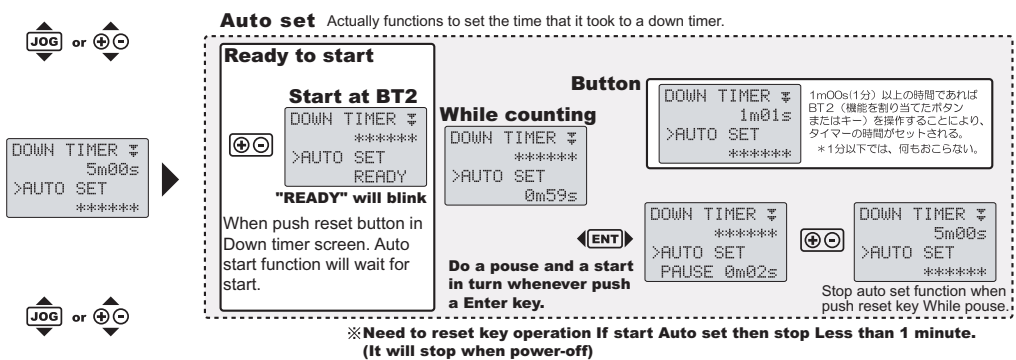
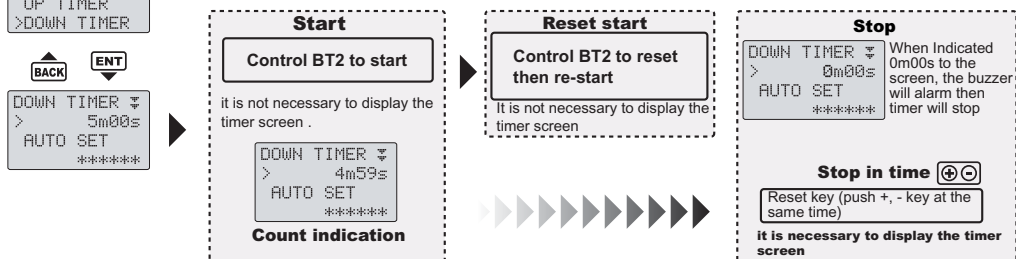
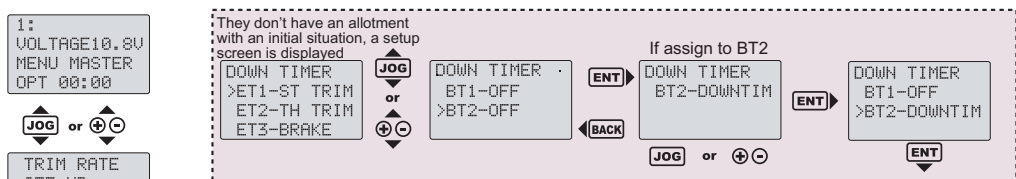

- 1 Open the function menu. use Jog dial or "+, -" keys.
- 2 From menu list, use Jog dial or "+, -" keys, and select the DOWN TIMER.
- 3 If not ET or BT assign it to lap timer, Setup will be displayed.
- 4 Subtracted from time set up on Down Timer.

●Use Auto set, then Run the car till empty the fuel. When set pre alarm, can usable as a refueling timer

●Need to assign any button to use this function.

●Can assign the custom tone at alarm of Down timer function.(see page 29)

**Back Key**  
**Enter Key**  
**JogDial**  
**+/- Key**  
**Reset**

## Can count the every lap by using Lap timer.

Set the Lap timer function and measurement point to record the lap. unestablished any key at an initial situation.

### [How to open the set-up screen.]

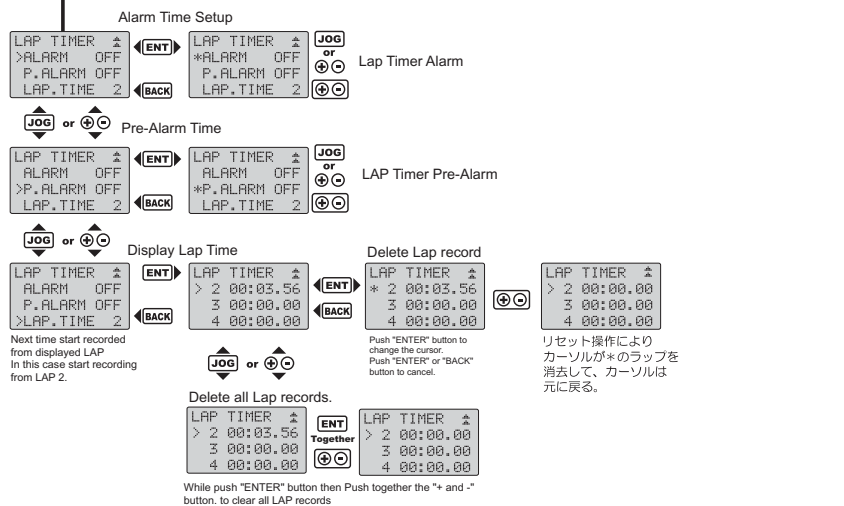
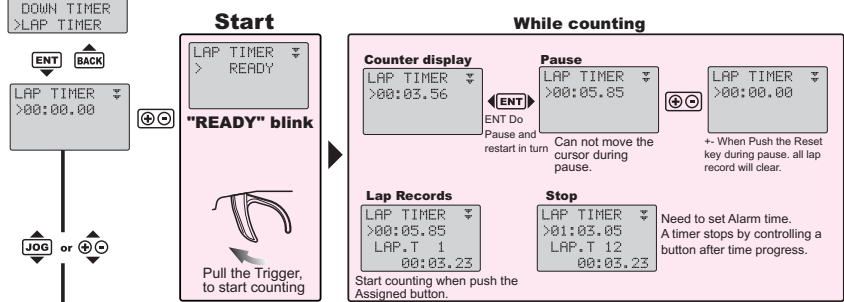
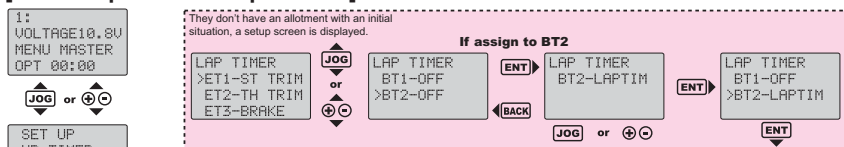

- 1** Open the function menu. use Jog dial or "+, -" keys.
- 2** From menu list, use Jog dial or "+, -" keys, and select the LAP TIMER.
- 3** If not ET and BT assign it to lap timer, Setup will be displayed.
- 4** Can record till 80 laps. after 80 laps over-write to 81st lap the 1st lap.

### advice

- The lap time record at Lap timer will save at same place. but the set up is Independent at each memory.
- Can use custom tone at alarm. (see page 29 and page 30)
- Can use 3 kind of timer at same times. (UP Timer, Down Timer, Lap Timer)

Usage of the transmitter  
 Features  
 Main Menu  
 Function Menu  
 Connecting the receiver  
 Notes on installing  
 Description  
 Index

**Warning!** Be certain to use only KO Propo genuine FM crystal sets (transmitter and receiver). Never use crystals produced by other companies since such crystals may vary in frequency, which could lead to misoperation or out of control.

**Warning!** Be sure to connect all equipment correctly. If connections are loosened by vibration, the model may run out of control.

**Warning!** Do not cut or bundle the aerial wire with other cords. It may result in decreasing the sensitivity of the receiver and may result in the model running out of control.

**Caution!** Be careful not to reverse the polarity of the transmitter and the receiver. Reverse polarity could damage the units.

**Caution!** Be sure to use genuine KO Propo products e.g. transmitter, receiver, ESC and other optional parts.  
\* We cannot assume any responsibility for the use of other companies products with this unit.

**Warning!** Be sure to use grommets and be sure that the servo is not touching any metal plates directly. \* The vibrations may damage the servo and the model may run out of control.

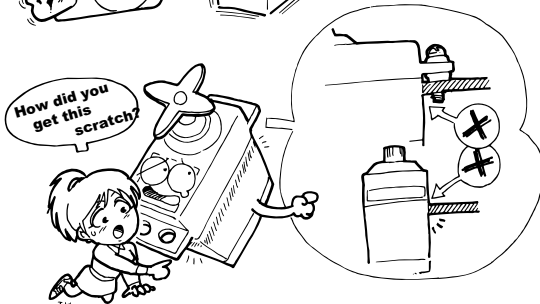
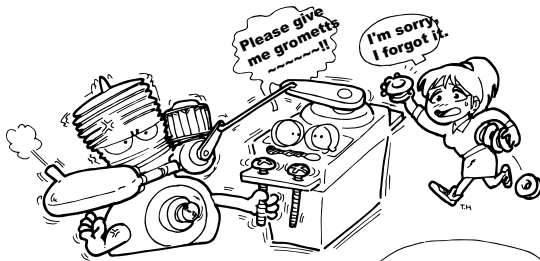

## ● Connecting the receiver

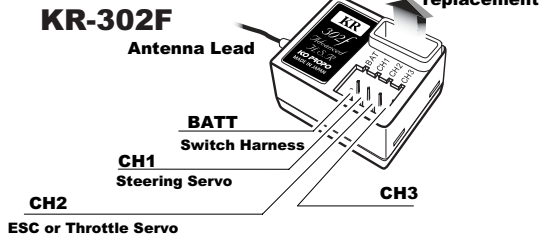

## ● For an electric-powered car (FET servo + FET ESC)

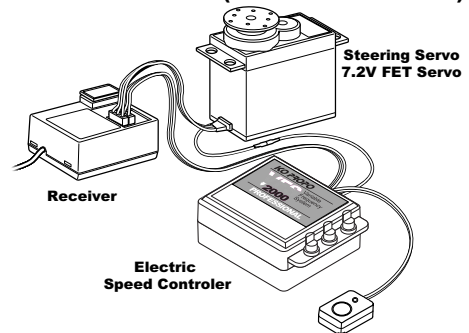

## ● For a gasoline-powered car (6V servos)

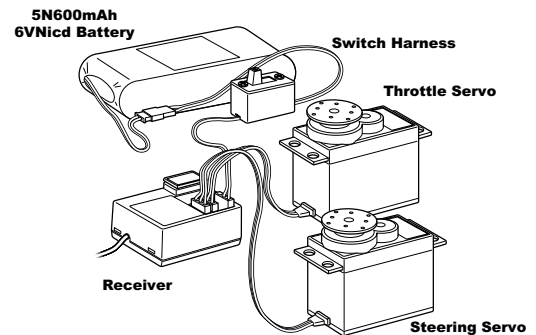

## ● For a gasoline-powered car (7.2V FET Servos)

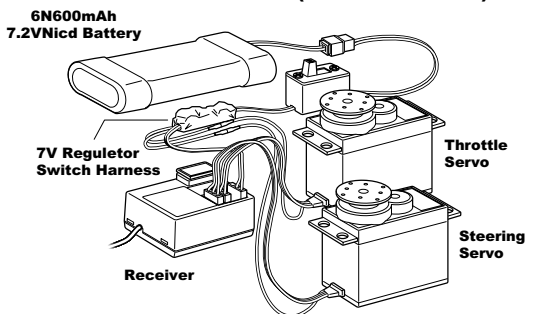

## KR-297FZ

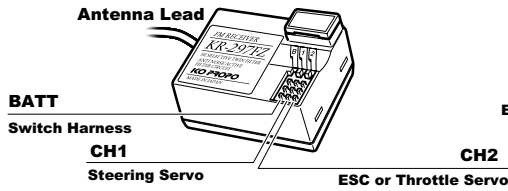

## KR-301F

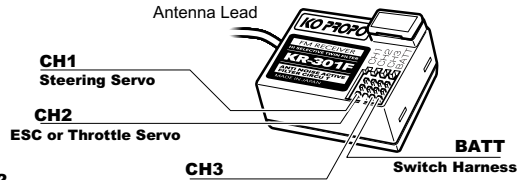

## KR-302F

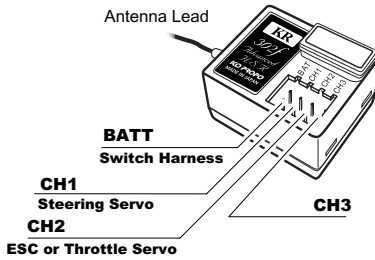

With models of receiver to be used, the order of a row of each channel and a battery channel changes. Please connect a connector after a check of a display. Keep in mind that it does not operate even if it connects Servo and ESC to a battery channel.

### About frequency change

- When the frequency to be used is exchanged in a frequency band.  
The crystal of a transmitter and a receiver is exchanged for the thing of the frequency to be used.
- For changing the frequency band to be used.

Exchange of a frequency band is possible by exchanging RF module of use. An exchangeable frequency band is restricted to the frequency band permitted in each country which uses it.

### ● The Source of Noise and Electromagnetic Induction (Electric-powered car)

Assume that all areas where large currents are flowing are generating noise!

Locate antenna wires and receivers as far away from the motor, ESC, nicad batteries, and silicone wire as possible. Noise is a type of radio wave, and therefore is radiated (travel through the air) in the same fashion. Therefore, locating an antenna near a noise source increases the effect of the noise.

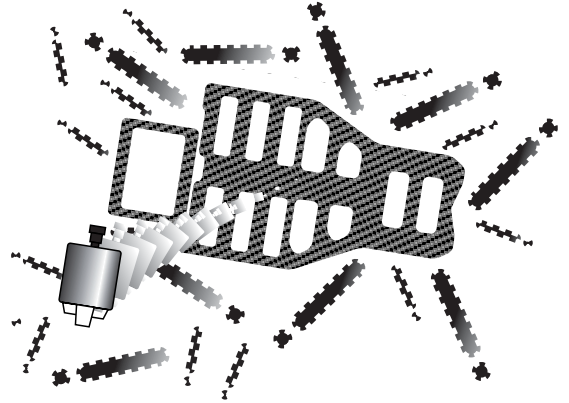
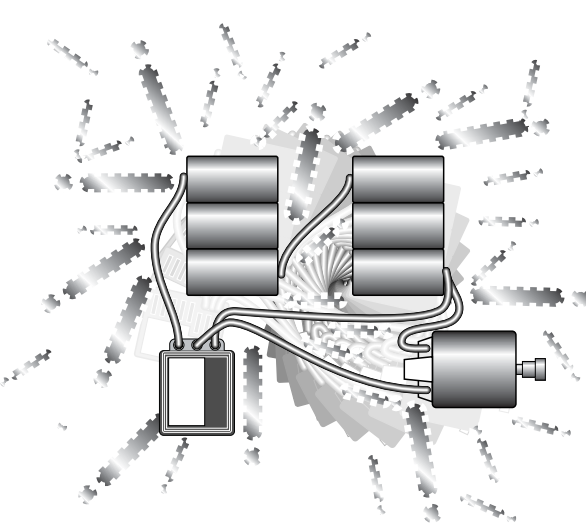

Metals and carbon can also conduct noise. As a result, you should never closely attach the antenna wire to the plate and carbon chassis.

### ● Distance Between the Receiver and Antenna Holder

Install the antenna holder as near to the receiver as possible.

The easier it is for the antenna to pick up noise, the sensitivity of the receiver will decrease.

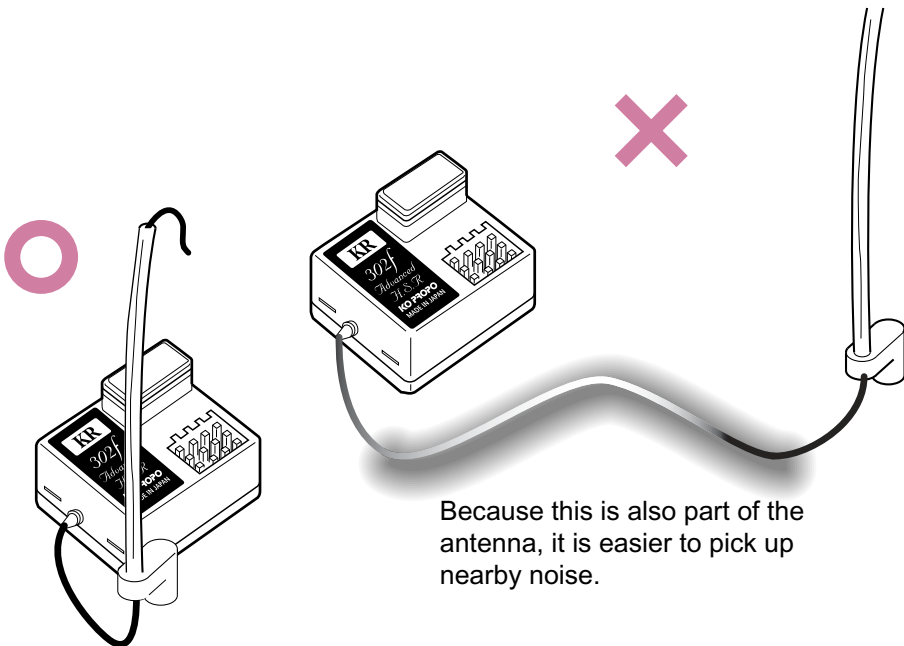

Because this is also part of the antenna, it is easier to pick up nearby noise.



## Notes on Installing the Receiver

## ●Notes on Installing Position (Do not near the receiver item.)

The installation position should be as far as possible from the motor, ESC, nicad batteries, silicone wires or other noise sources. Especially, do not route the silicone wires next to the receiver. (must not be near to the crystal) FET servo blue wire (7.2V wire) and switches can also generate noise, position them as far away as possible from the receiver and the antenna.

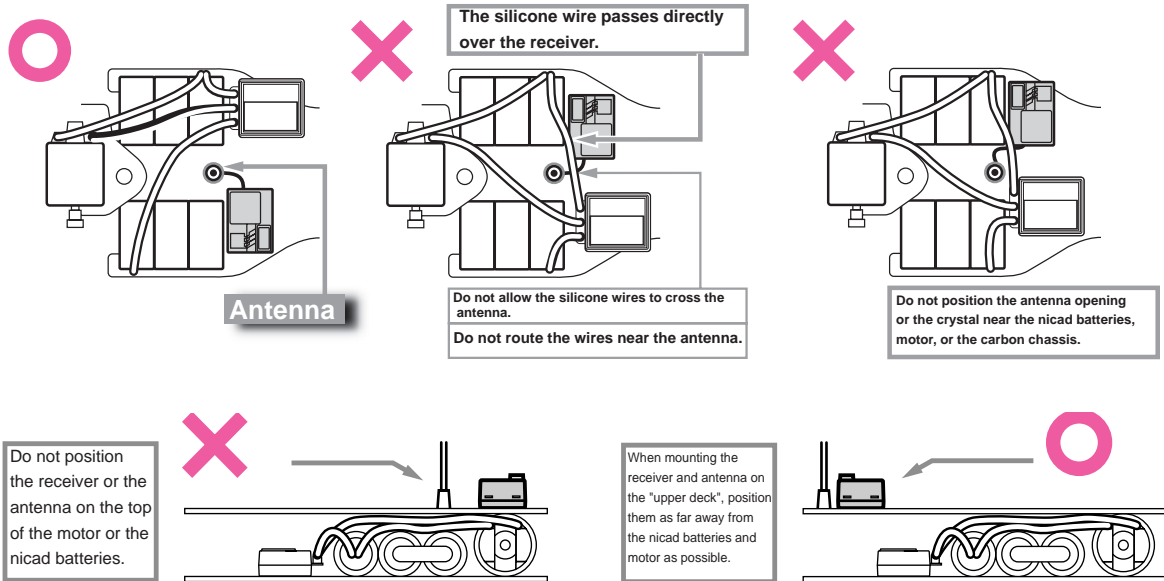

## Mounting the Receiver (Electric-powered car)

●When fixing the receiver in place on the chassis or on the "mechanical plate", use two pieces of double-sided tape, one on top of the other, as that the receiver is cushioned somewhat. Be sure that the crystal is on the high end when installing the receiver

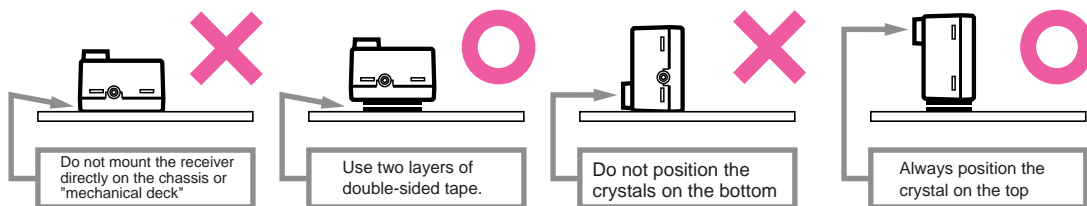



### ● Notes on Installing the Receiver (Gasoline-powered car)

Do not secure the receiver on the chassis or the "mechanical deck". Vibrations will cause the receiver to malfunction and may even cause internal damage to the receiver. Either use the bracket (receiver holder) provided with the kit, or else cushion the receiver with a sponge like material.

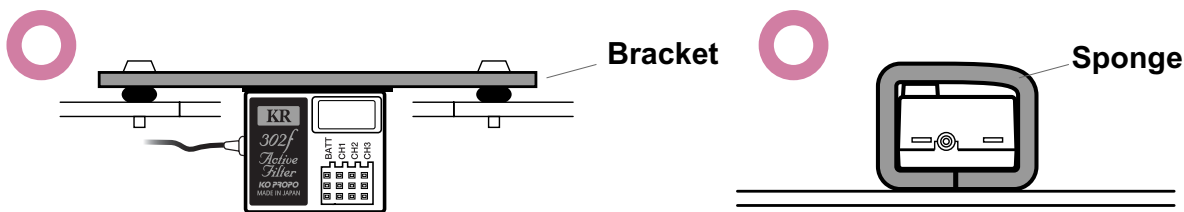

**Warning!**



The exhaust gas of engine carries neither in this place nor the place which becomes high temperature. \* A receiver breaks down and it becomes the cause of a reckless run.

### ● Notes on Antenna Installation

Please follow the instruction as in the illustration below when you mount the antenna holder to the metal or carbon chassis. When using on FRP or carbon hollow antenna on a racing car, etc., do not pass the antenna wire through the pipe, allow it to trail away loosely outside.

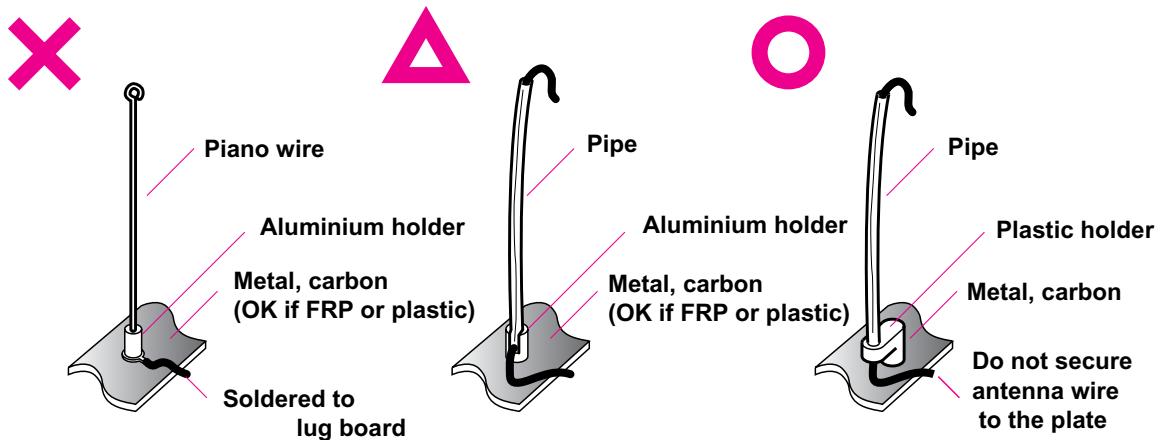



## Main Specifications

### Transmitter KT-303H

<b>Operation method</b>	Wheel+ Triger
<b>Number of channels</b>	3 Channnels
<b>Transmission Frequency</b>	Any Band by changing crystals within the frequency range
<b>Neutral pulse</b>	1.5msec
<b>Memory</b>	EEPROM
<b>Supply Voltage</b>	8x AA size dry cel or 8 cells Nicad
<b>Current consumption</b>	Less than 250mA

### RF Module RF-501F for KT-303H

<b>Transmission Frequency range</b>	Any frequency range by switchung RF modules
<b>Modulation method</b>	FM-PPM

### Receiver KR-302F

<b>Reception method</b>	FM-PPM
<b>Number of channels</b>	3 Channels
<b>Reception frequency</b>	Any Band by changing crystals within the frequency range
<b>IF frequency</b>	455KHz
<b>Supply voltage</b>	3.5 6.5V
<b>Dimintions</b>	29.3 × 24.4 × 16.4mm
<b>Weigh</b>	12.0 (excluding crystal)

**KO PROPO**

LATEST LEADING RADIO CONTROL TECHNOLOGY

DRAFT

Terminology used in radio control mode usage. Please refer to the Index for the terminology or wording of this transmitter.

<b>Analog Servo</b>	The general term of a model of machines of the Servo which used a thing of an analog method for control IC of Servo
<b>Alarm</b>	A signal to be famous as a buzzer of a transmitter. When it is used for a meaning of warning.
<b>Amplifier</b>	ESC
<b>ESC</b>	Abbreviation of an electric speed controller. It is a speed controller of a motor to use by electric car. An amplifier is said.
<b>EEPROM</b>	A kind of memory. Contents written in aren't erased even if switched off. It is used for data pack in EEPROM others of memory in the main body
<b>Internet</b>	The network where the communication network where plural personal computers were connected to was connected to on a large scale more. Information dispatch by a homepage and an E-mail are depended on in the world, and communication can be done.
<b>WEB Site</b>	Home Page
<b>AM</b>	An electric wave to send from a transmitter A signal form of an electric wave. There is FM as another method. AM is an abbreviated designation in English of an amplitude modulation method. When that is used, It is had to match a signal form of transmission and reception machine.
<b>LCD</b>	A cable address to mean liquid crystal indication device. It is used to display letters.
<b>AC Charger</b>	A charge container to connect to 100V outlet. There are many situations to cut more than several hours in charge.
<b>FM</b>	A signal form of an electric wave to send from a transmitter. FM is an abbreviated designation in English of a frequency modulation method
<b>FET</b>	An electric field effect transistor. Loss resistance is small, and, in comparison with a normal transistor, a consumption electric current of oneself is small, too.
<b>FET Servo</b>	FET was used for a motor drive element instead of a conventional transistor, and it is being of high class Servo.
<b>ET</b>	An Abbreviation of electric trim. Besides, a button is abbreviated to BT.
<b>Fast Charger</b>	The Charger which charges a nickel-cadmium battery and a nickel metal hydride battery by a short time.
<b>Carburetor</b>	Fuel mixture device, turn number of engines are controlled.
<b>Crystal</b>	A component to set frequency of transmission and receiver, It is made from crystal.
<b>Clutch</b>	An output axis of an engine and the intermittent continuation device which there is between gearing devices.
<b>High frequency ESC (an amplifier)</b>	ESC of the method how frequency to drive a motor is high. Most are these systems, but the thing which isn't a high frequency system exists in past things.
<b>High frequency (RF) module</b>	An electric wave is made, and a circuit device to fire can be put on and off. When a frequency band to use (27MHz .40MHz) is changed, it is had to swap it.
<b>Connector</b>	Electric point of contact unit of putting on and off type.
<b>Rubber Grommet</b>	The rubber component which protects Servo from vibration, an edge of a Servo case can be possessed.
<b>Servo</b>	The device which converts a management signal of a transmitter into turn machine exercise. A Servo motor.
<b>Cycle</b>	It is space and period of repetition of a certain movement.
<b>CPU</b>	IC of a core of a computer used in various uses by digital operation processing. A microcomputer. It can be called MPU.
<b>Frequency band</b>	It is called the place that each frequency gathers, and shine, 27MHz zone (mega Hz), 40MHz zone.
<b>Receiver (RX)</b>	The device which an electric wave of a transmitter is received, and send a control signal forth in Servo and ESC.
<b>Jog dial</b>	A knob for data modification of a turn system not to have a stopper. If that is controlled every one click, by 1 point can do data modification, but is usable usefully when numerical value wants to be made a change in at a stretch
<b>Speed controller</b>	ESC
<b>Swing</b>	Campaign against coming and going between a certain set two points.
<b>Spline</b>	Exact location of the servo horn in to the neutral position.
<b>Center Trim</b>	Even if the trim is adjusted, overall turning angle point will not be changed.

<b>Servo Saver Horn</b>	The shock absorbing device that is installed or in place of servo horn.
<b>Transmitter (TX)</b>	Hand set that transmitter signal.
<b>Turning Angle (Travel)</b>	Turning angle of the servo horn.
<b>Channel (CH)</b>	Number of Servo which can be controlled with a transmitter one by one. Or it is a number of that individual signal
<b>Data Pack</b>	It is the module which had memory for enlargement built-in. Usable model memory can be increased.
<b>Digital Servo</b>	The general term of a model of machines of the Servo which used a thing of a digital system for control IC of Servo.
<b>Delay</b>	Act slowly.
<b>DC Charger</b>	The Charger which uses direct current for power supplies such as 12V battery or 12V stabilization power supply.
<b>Duty</b>	It is the ratio of two movement.
<b>Travel</b>	It is a rudder angle, movement volume.
<b>Trigger</b>	Control mechanism of a transmitter. A piece pulled with a finger to control the speed or brakes.
<b>Trim</b>	The device which adjusts a neutral position of each channel signal.
<b>7.2V Servo</b>	The Servo that a motor becomes the other power supply. By a KO PROPO original system, it is expected that a power supply is taken out of a power supply for power (7.2V) in the case of an electric car
<b>NiCad (Ni-cd)</b>	It is different from a dry cell, The battery which it is charged repeatedly, and can be used. There are NiMH or lithium ion as the battery which it is charged, and can be used repeatedly elsewhere
<b>Neutral</b>	The situation that separated a hand from a stick of a transmitter or a position of Servo Horne at that time.
<b>27Mhz</b>	It is for one of the frequency band that it can use by radio control, ground, water model, and there are 12 belts.
<b>Noise</b>	An electric noise. For a kind of electric wave, it makes it jumps into a receiver and malfunction.
<b>Band plate</b>	It is frequency and is selected with crystal glass. It can make a change by crystal glass exchange in the same frequency band.
<b>Band</b>	It is frequency and is selected with crystal glass. It can make a change by crystal glass exchange in the same frequency band
<b>Backlight</b>	Because themselves don't emit light LCD (a liquid crystal display), visibility isn't good by the time if it is dark. It is the lamp which is installed in the backside of liquid crystal to solve this (the emission of light source)
<b>Dead Band</b>	The field where Servo doesn't react to even if it controls foil and trigger.
<b>VR</b>	It means the volume that detects the position of the stick.
<b>Fail safe adaptor</b>	When it receives an interference electric wave, it is the device which it fixes Servo Horne at the position that a computer set up beforehand, and prevent reckless driving.
<b>Push rod</b>	The stick thing which is used for linkage.
<b>Preset</b>	Will set up a position in advance
<b>PC interface</b>	It is an adapter it converts a signal into, and to be connected to do setting of a transmitter with a PC.
<b>Discharger</b>	The circuit device which makes you discharge a residual quantity of a charge type battery of NiCad forcibly.
<b>Wheel</b>	Mechanism of the transmitter which it turns it from side to side, and control a steering.
<b>Pumping Effect</b>	Intermittent breaking action.
<b>Home Page</b>	It says the place where it mentioned a certain information in on Internet. It can look by software on a personal computer called a Web browser.
<b>Machine plate</b>	The board which installs receiver Servo on a chassis of a car.
<b>Mega Hz (MHz)</b>	1000Hz =1 KHz (a kilohertz) 1000KHz =1MHz.
<b>Memory</b>	In a personal computer, it is used for a meaning called the preservation place in which information is stored temporarily. Although the information on the memory in this case will be lost if a power supply is shut off, the memory used for a transmitter etc. is called non-volatilized memory, and even if it shuts off a power supply, it holds information.
<b>40Mhz</b>	One of the frequency band that it can use by radio control. Eight bands for ground model. There are five bands for sky model.
<b>Linkage</b>	Servo and connection mechanism to connect each mechanism to of a model.
<b>Reset</b>	Return setting contents of setting numerical value to an initial situation
<b>Regulator</b>	The circuit which stabilizes the input voltage to the necessary voltage.
<b>Response</b>	It is time before machinery of the receiver side reacting since it controls a transmitter.
<b>Width</b>	The thing of width which operates by ABS or Throttle Acceleration.



Usage of the transmitter



Features



Main Menu



Function Menu



Connecting the receiver



Notes on Installing



Description

Index





Usage of the transmitter

Features

Main Menu

Function Menu

Connecting the receiver

Notes on installing

Description

Index





**EX-10 HELIOS**  
PROFESSIONAL CONTROLLER

**KO PROPO**<sup>®</sup>  
DIGITAL PROPORTIONAL SYSTEM