

KO PROPO
DIGITAL PROPORTIONAL SYSTEM



EX-1

INSTRUCTION MANUAL

Table of Contents

※ Click the page number to jump to that page.

Title	Page	Title	Page
■ Table of Contents	2	3CH/4CH Menu (3/4ch Menu)	33
■ For Safe Operation	3	Control Menu (Control Menu)	33
■ Getting Started	5	▶Control Mode (Control Mode)	33
●Transmitter Assembly	5	▶2WAY (2WAY)	33
●Transmitter Dismantling	5	▶3WAY (3WAY)	34
■ Names of Parts	6	▶5WAY (5WAY)	34
●ET Keys (1-5) and BT Button (1)	7	▶ANALOG (ANALOG)	35
●Steering Wheel Adjustment	7	▶4WS Mixing (4WSMix)	36
●Throttle Trigger Adjustment	7	▶▶4WS Mixing Mode (4WSMix MODE)	36
●Throttle Trigger Position Adjustment	7	▶▶4WS Mixing Left (4WSMix LEFT)	36
●ICS Port	7	▶▶4WS Mixing Center (4WSMix CENTER)	36
●Headphone Jack	7	▶▶4WS Mixing Right (4WSMix RIGHT)	37
●Colored Grip and Pad Replacement	8	▶▶4WS Mixing Travel (4WSMix TRAVEL)	37
●Unit Connector	8	▶▶4WS Mixing Reverse (4WSMix REVERCE)	37
●Charger Jack	8	▶▶4WS Mixing Key (4WSMix KEY)	37
●Power Switch	8	▶Amp Mixing (AMP Mix)	38
■ Preparations	9	▶▶Amp Mixing Mode (AMPMix MODE)	38
●Battery Installation	9	▶▶Amp Mixing Throttle Hold (AMPMix HOLD)	39
●Battery Level Warning	9	▶▶Amp Mixing High Point (AMPMix HIPOINT)	39
●Operation Alarm	9	▶▶Amp Mixing Brake (AMPMix BRAKE)	39
●Battery Pack (Under Development)	9	▶▶Amp Mixing Reverse (AMPMix REVERSE)	40
●Countermeasures Against Noise	10	▶▶Amp Mixing Trim (AMPMix TRIM)	40
●Receiver Installation	11	▶▶Amp Mixing ET Mode Setting (AMPMix ET MODE SET)	40
●Pairing	11	▶▶Amp Mixing Key (AMPMix KEY)	40
■ Procedures Prior to Operation	12	▶Throttle Mixing (T-Mix)	41
●Trim and Sub Trim Operation	13	▶▶Throttle Mixing Brake (T-Mix BRAKE)	41
■ Display and Control Method	14	▶▶Throttle Mixing Center (T-Mix CENTER)	41
●Basic Operations to Change Settings	14	▶▶Throttle Mixing High Point (T-Mix HIPOINT)	42
●Startup Screen and Initial Screen	15	▶▶Throttle Mixing Reverse (T-Mix REVERCE)	42
■ Function Reference	16	▶▶Throttle Mixing Curve (T-Mix CURVE)	42
●Main Menu	16	▶▶Throttle Mixing Delay (T-Mix DELAY)	42
Model Menu (Model)	16	▶▶Throttle Mixing Steering (T-Mix STEER)	43
▶Model Select (MDL-Select)	17	▶▶Throttle Mixing On/Off (T-Mix ON/OFF)	43
▶Model Name (MDL-Name)	17	▶▶Throttle Mixing Key (T-Mix KEY)	43
▶Model Copy (MDL-Copy)	18	Quick Setup (QuickSetup)	44
▶Model Reset (MDL-Reset)	18	Timer Menu (Timer Menu)	45
Steering Menu (Steering)	19	▶Stopwatch (StopWatch)	45
▶Steering Trim (ST-Trim)	19	▶Countdown Timer (DownTimer)	46
▶Steering Travel (ST-Travel)	19	▶Lap History (LapHistory)	46
▶Steering Balance (ST-Balance)	20	Function Menu (Function Menu)	47
▶Steering Sub Trim (ST-SubTrim)	20	▶Monitor (Monitor)	47
▶Steering Trim Rate (TrimRate)	20	▶LED Color (LEDcolor)	47
▶Steering Turn Speed (TurnSpeed)	21	▶LCD Backlight (BackLight)	47
▶Steering Return Speed (RetnSpeed)	21	▶LCD Contrast (Contrast)	48
▶Steering Punch (ST-Punch)	22	▶Sound Volume (SoundVol)	48
▶Steering Curve (ST-Curve)	22	▶Buzzer (Buzzer)	48
▶Steering Reverse (ST-Reverse)	23	▶Key Repeat (KeyRepeat)	48
▶Travel Override (Travel Override)	23	System Menu (System Menu)	49
Throttle Menu (Throttle)	24	▶Response (Response)	49
▶Throttle Trim (TH-Trim)	24	▶Setup (Setup)	50
▶Throttle High Point (TH-Point)	24	▶Direct Switch (DirectBT)	50
▶Throttle Brake (TH-Brake)	25	▶Adjust VR (ST) (SteeringAjustVR)	50
▶Throttle Sub Trim (TH-SubTrim)	25	▶Adjust VR (TH) (ThrottleAjustVR)	51
▶Throttle Trim Rate (TH-TrimRate)	25	▶Operation Timer (OP-Timer)	51
▶Throttle Turn Speed (TH-TurnSpeed)	26	▶2.4G Band (2.4GBand)	51
▶Throttle Return Speed (TH-ReturnSpeed)	27	▶Power Management (POWER MANAGEMENT)	52
▶Throttle Punch (TH-Punch)	28	▶All Reset (AllReset)	52
▶Throttle Curve (TH-Curve)	28	▶ICS (ICS)	52
▶Throttle Reverse (TH-Reverce)	29	▶Approval	52
▶Throttle Drag Brake (TH-DragBrake)	29	●Warning Display	53
▶Brake Override (Brake Override)	29	▶FCC statement	53
▶Throttle ABS (TH-ABS)	30	Battery Level Warning	53
▶Throttle Acceleration (TH-Accel)	31	■ Glossary	54
▶Throttle Auto-Start (TH-AutoStart)	32	■ Specifications	57
▶Idle Up (IdleUp)	32		

■ For Safe Operation

Due to the nature of radio controlled models, improper handling may lead to dangerous situations. Therefore please read the following information carefully in order to ensure safe operation. Please also understand that KO Propo is not responsible for any injuries or damage which result from noncompliance of these cautions and notices.

 **Warning!** Improper handling/usage may lead to a high probability of material damage as well as a possibility of serious personal injury or even death.

 **Notice!** Improper handling/usage may lead to personal injury or material damage.

● When Installing Components

 **Warning!**
Prohibited matters

- Make sure metal parts on the model (car chassis/ship hull) do not come into contact with each other.
 - ※ Contact between metal parts may result in noise, which could cause the receiver to malfunction and lead to an uncontrollable model.
- Do not cut or bundle the antenna cable.
 - ※ This may lower the receiver's sensitivity and lead to an uncontrollable model.
- Ensure correct polarity when installing transmitter and receiver batteries.
 - ※ Incorrect polarity may damage the product.
- Within Japan, this product is limited to usage with models which operate on the ground or in the water.
 - ※ Do not use for other non-designated purposes.
- Ensure that all connectors (receiver, servo, switch, etc.) are connected securely.
 - ※ If connections become loose due to vibrations, it may lead to an uncontrollable model.
- Securely attach receiver with thick double-sided tape and ensure that it does not make contact with other parts.
 - ※ Strong shocks or contact with other parts due to vibrations may lead to an uncontrollable model.
- Check servo operation to ensure the pushrod is not subject to excessive loads.
 - ※ Excessive loads may damage the servo or increase battery power consumption.
- Make sure to use the rubber grommet when attaching the servo and that the servo does not contact the R/C equipment tray.
 - ※ If vibrations affect the servo, it may lead to damage or an uncontrollable model.
- Use in conjunction with genuine official KO Propo products.
 - ※ KO Propo is not responsible for any damages or injuries which result from use of this product in combination with other manufacturer's products.

 **Warning!**
Enforcement matters

● Notes for Usage

 **Warning!**
Prohibited matters

- Do not use when there is thunder.
 - ※ It is possible for lightning to strike the antenna.
- Do not use in the rain or in areas where water has accumulated.
 - ※ If water enters the product it may lead to an uncontrollable model.
- Do not use in the following locations:
 1. Near R/C circuits (within 3km)
 2. Near crowds, on streets, or near actual vehicles or ships.
 3. Near high-voltage power lines or communication facilities.
 - ※ If signal interference, etc. causes an uncontrollable model, a serious accident may result.
- Do not use when your concentration levels are compromised by tiredness, alcohol, medication, etc.
 - ※ Mistakes in judgment may result in serious accidents.
- Do not allow glow engine fuel or engine exhaust to contact the product.
 - ※ These may attack the plastic and damage the product.
- Check to ensure that the selected model memory matches the model to be controlled.
 - ※ Using an incorrect memory may lead to an uncontrollable model.
- Make sure to stop the engine (disconnect motor cables) before changing transmitter settings.

 **Warning!**
Enforcement matters

⚠ Caution!
Prohibited matters

● Do not touch engine, motor, ESC, etc. immediately after use as they may be hot.
※ Doing so may lead to burns.

● When switching on, always turn on the transmitter first, followed by the receiver. Follow the reverse order when switching off.
※ If the wrong order is followed, it may lead to an uncontrollable model.

⚠ Caution!
Enforcement matters

● Dismantling or modifying the RF Module (internalized in the case of the EX-1) is prohibited and is punishable by law.

※ Doing so may lead to accidents such as short circuits and KO Propo Customer Service Department may not accept dismantled/modified products for repair.

● Do not use this product in aircraft, hospitals, or near fire alarms or medical equipment.
※ This may lead to malfunctions and result in serious accidents. Also, by law you must cease operation if the product affects other wireless or electrical devices.

● 2.4GHz transmitters must be registered with the Japan Radio Control Safety Association.

※ The transmitter which you have purchases is already registered. Products which do not have proof of registration are illegal.

● Notes After Usage

⚠ Warning!
Enforcement matters

● In the case of an R/C car, make sure to remove the battery pack after driving.

※ If the car is switched on accidentally, it may lead to a fire or an uncontrollable model.

● Keep transmitters, batteries, and models away from small children.

※ Chemical agents and the items themselves may cause personal injury.

● Remove batteries from transmitter if it will not be used for a considerable time.

※ If batteries are left in the transmitter, battery leakage may result in damage.

● Do not store transmitter/receiver in the following conditions:

1. Extremely hot (over 40°C) or cold (below 10°C) temperatures.

2. Locations in direct sunlight.

3. Locations with high humidity.

4. Locations subject to vibrations.

5. Locations with lots of dust.

※ These conditions may cause the case to deform and damage the product.

⚠ Caution!
Enforcement matters

● Transmitter Battery Handling and Charging (separately available option)

⚠ Danger!
Enforcement matters

● Never short-circuit the battery connector.

※ This may lead to a fire or explosion.

● Do not dispose batteries in fires.

※ This is very dangerous and may lead to an explosion.

⚠ Danger!
Enforcement matters

● Do not subject the battery to strong shocks.

※ This may damage the battery and cause leakage or a short circuit.

● Do not dismantle or modify the battery.

※ This may cause dangerous leakage of battery fluids.

● Keep away from water. Do not charge a wet battery.

※ This may cause overheating and damage.

● Do not charge alkaline batteries.

※ Alkaline and other single-use batteries cannot be recharged. Doing so may lead to fire and damage.

Getting Started

<Legend>

P : Point

! : Notice

Transmitter Assembly

Insert the Grip Unit into the Master Unit, then attach the Steering Unit.

! Remove the connector cover before attaching.

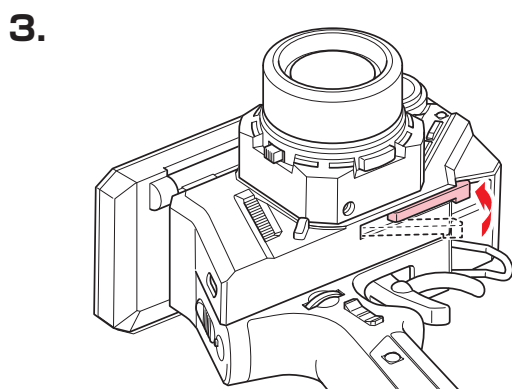
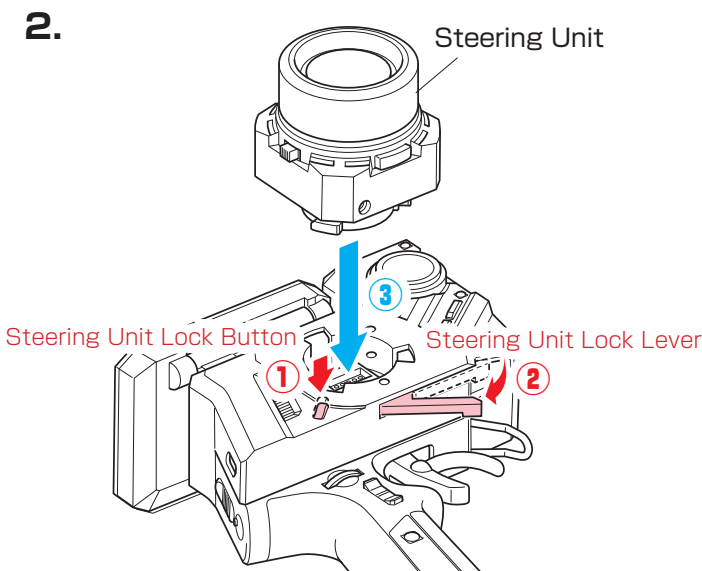
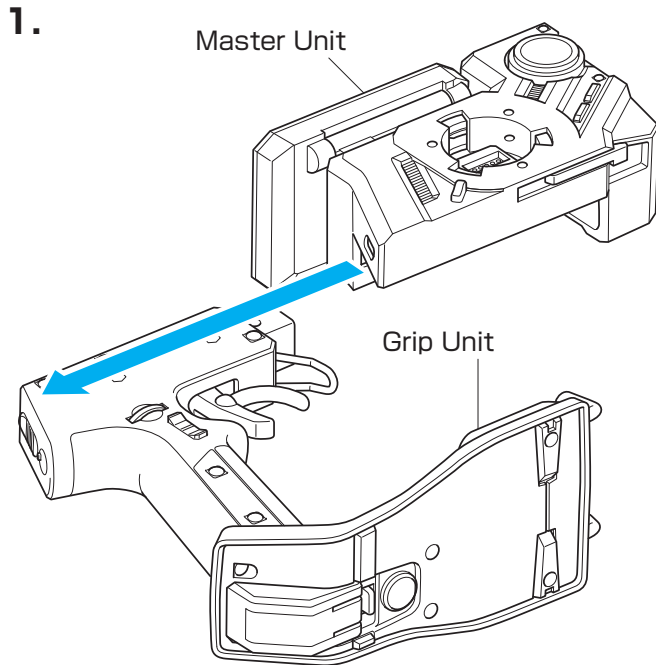

Transmitter Dismantling

Detach the Steering Unit, then detach the Master Unit.

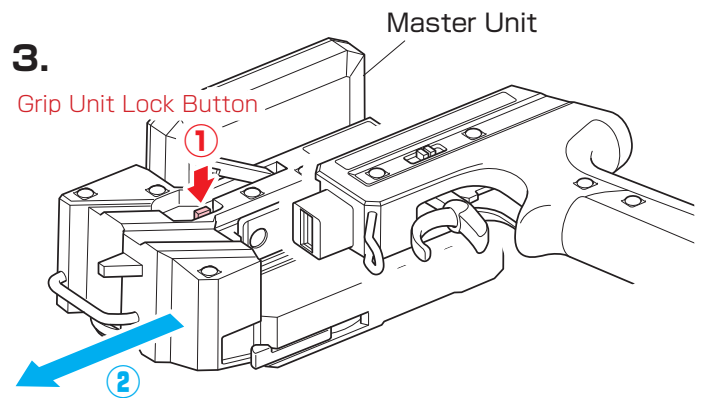
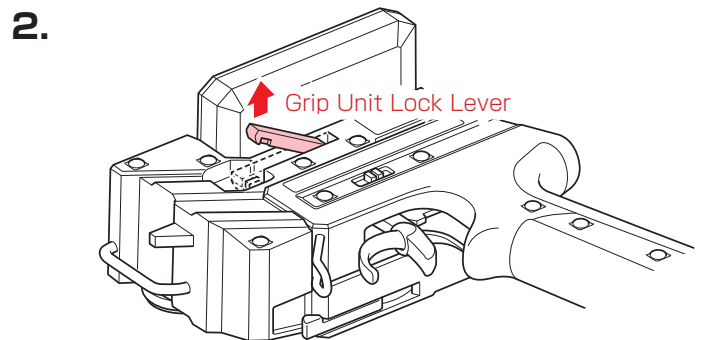
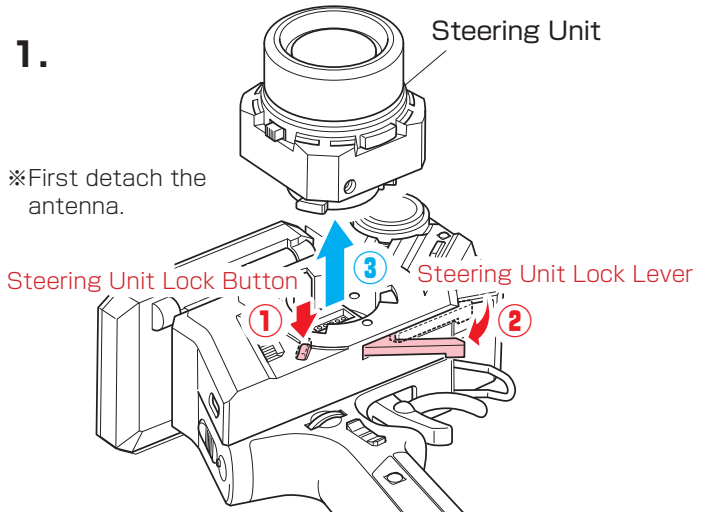

! If storing the transmitter in dismantled form, please remember to attach the connector covers.

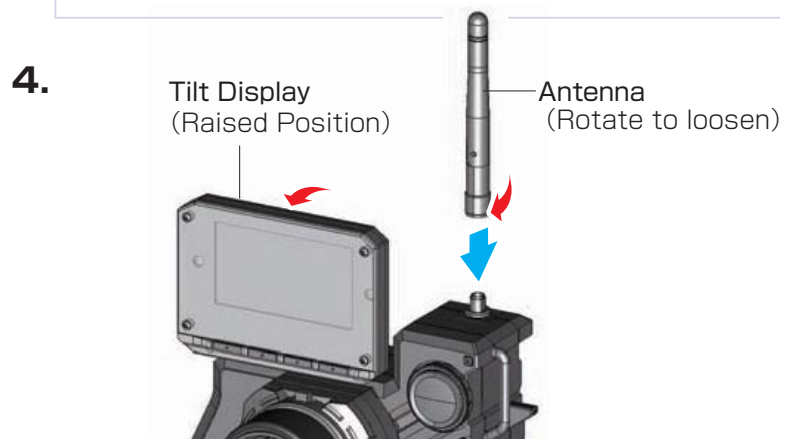

Names of Parts

《Side View》

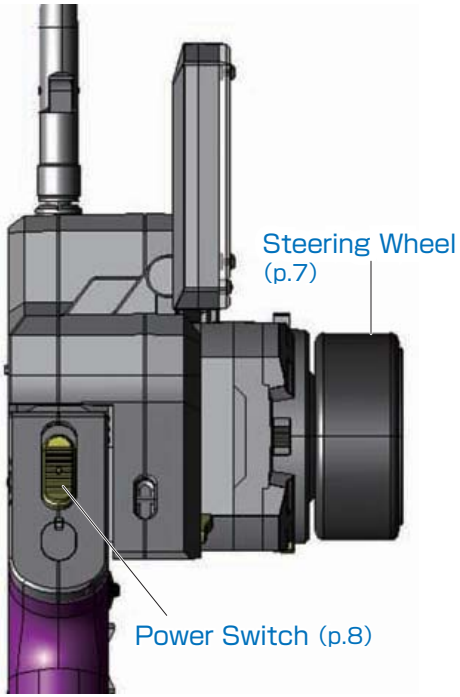

《Front View》

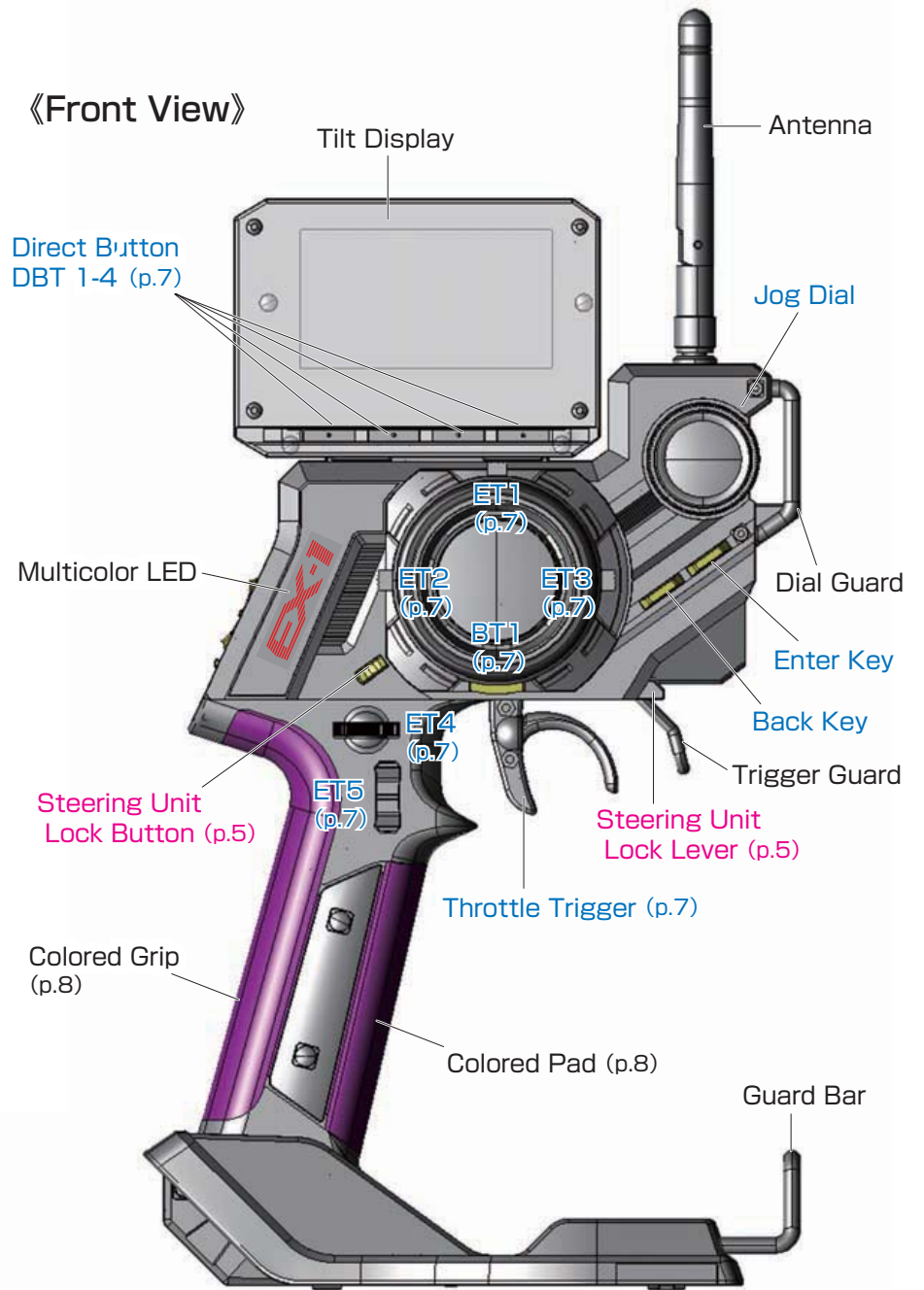

《Rear View》

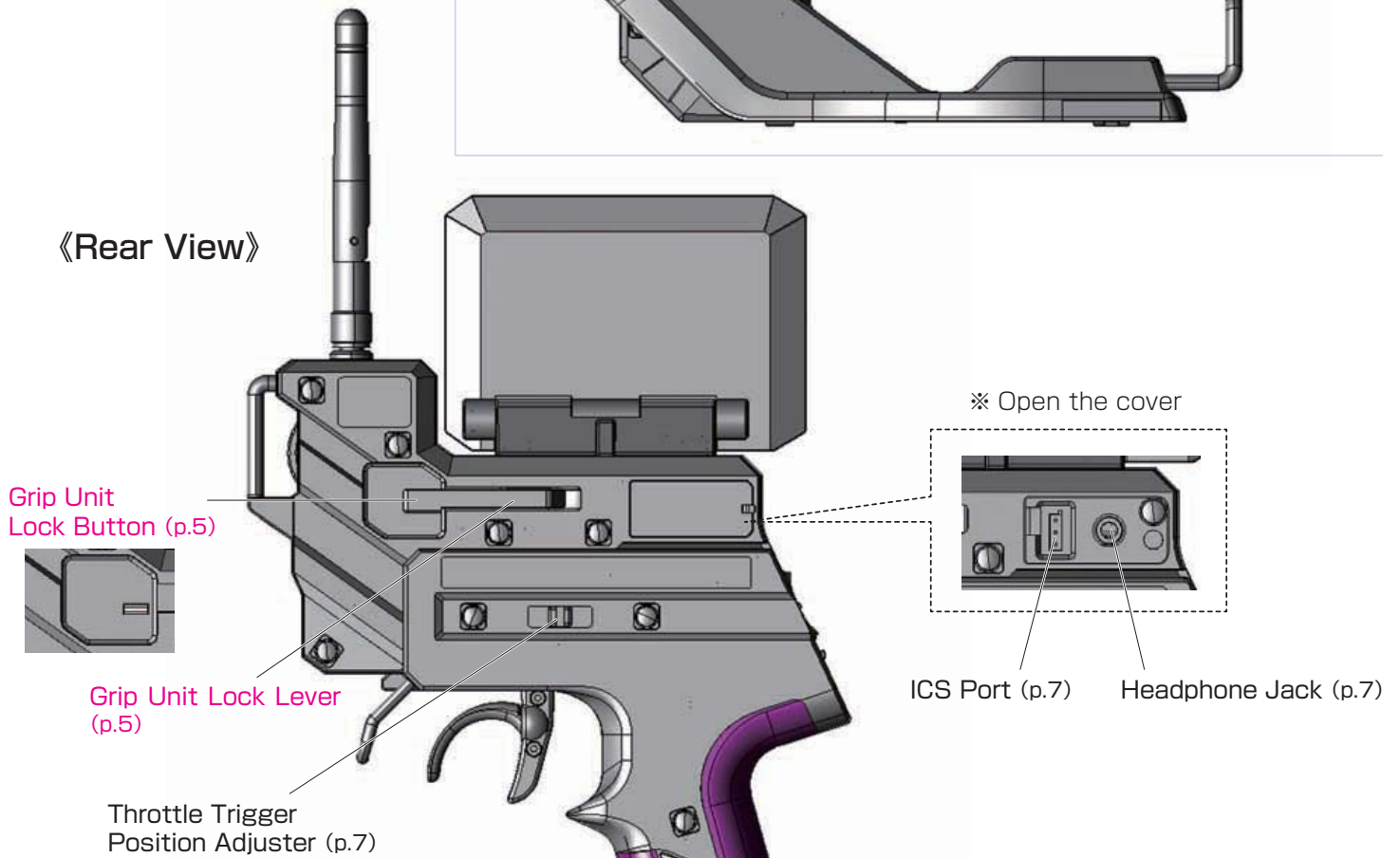

● ET Keys (1-5) and BT Button (1)

Functions may be assigned to the keys/button.

! The possible functions which each key/button may be assigned to are different.

● Steering Wheel Adjustment

Adjust the tension of the steering wheel spring.

《How to Adjust》

Insert a 1.5mm hex wrench referring to the image below. Rotate clockwise to increase tension and counterclockwise to decrease it.

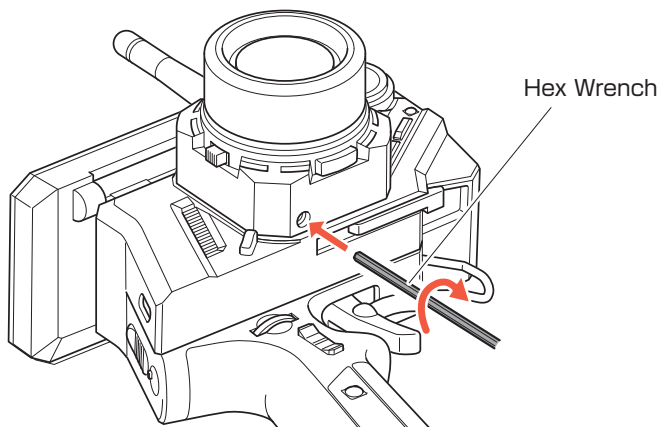

! Excessive counterclockwise rotation will result in the wheel being unable to return to neutral position. In this case, rotate clockwise until the wheel returns to neutral.

● Throttle Trigger Adjustment

Adjust the position and angle of the brake trigger to your preferences.

《How to Adjust》

- ① Loosen the hex screws on the throttle trigger with a 1.5mm hex wrench.
- ② Freely adjust the brake trigger position.
- ③ Tighten the hex screws to secure.

【Throttle Trigger】

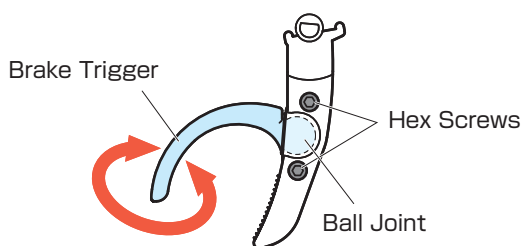

! The trigger may be loosened due to temperature, strong shocks, or prolonged use. In this case, cementing the trigger in position is recommended. If looseness persists, contact KO Propo Customer Service Department.

● Throttle Trigger Position Adjustment

The position of the throttle trigger may be adjusted to match the user's hands.

《How to Adjust》

- ① Loosen two screws on the rear side of the transmitter.
- ② Slide the Throttle Trigger Position Adjuster as desired.
- ③ Tighten the loosened screws to secure.

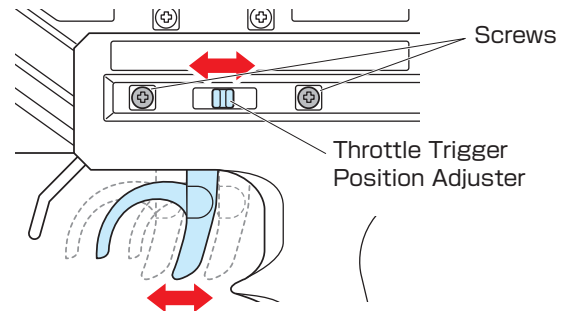

● ICS Port

This port is used for the ICS USB Adapter HS (sold separately), which enables the transmitter to connect to a PC. Special software, which can be downloaded from KO Propo's website, enables the setting and modification of the transmitter's model memory from a PC. It also enables numerous model memory settings to be saved onto a PC. Refer to KO Propo's website for details on how to use this feature. (<http://www.kopropo.co.jp/sys/>)

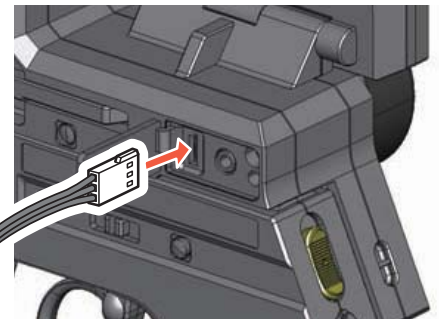

● Headphone Jack

Attach audio plugs from commercially available headphones, etc. (sold separately) to the transmitter. This feature helps users hear the transmitter's operation sounds while in a noisy pit area.

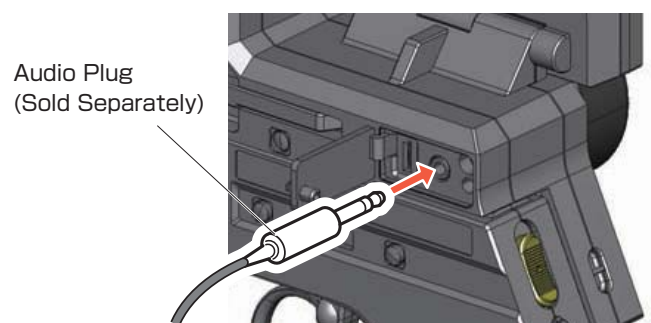

! Even when headphones are plugged in, sounds will still be emitted by the transmitter itself. The headphone jack is monaural.

● Colored Grip and Pad Replacement

Users can choose to install grips and pads of other colors (sold separately).

《How to Replace》

Remove the two screws on each side of the grip to detach the grip plates, then attach the colored grip and pad.

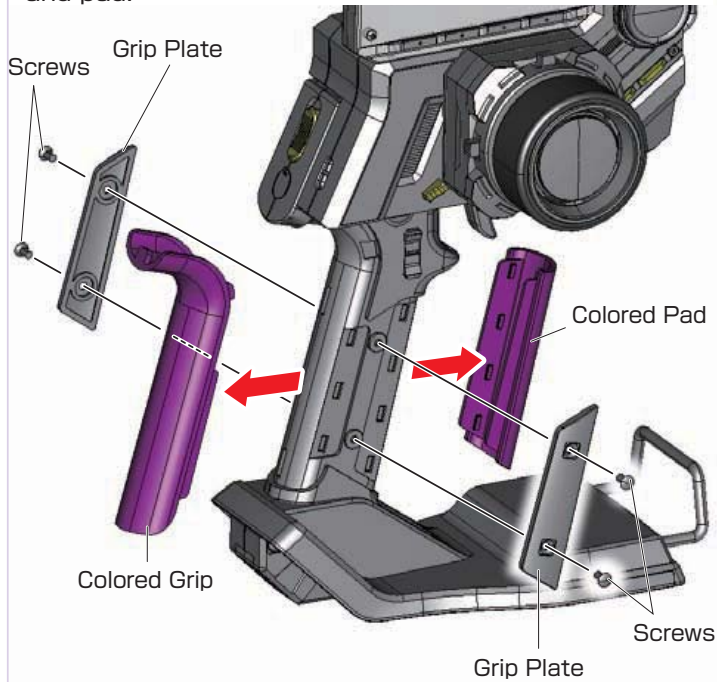

- ⚠ Make sure the battery box or battery pack is removed before replacing the colored grip and pad.
- ⚠ The tabs on the colored grip and pad are to be inserted into holes. Note the direction.
- ⚠ Note direction of the of the colored grip and pad.

● Unit Connector

This product may be dismantled and therefore each unit features their respective connectors. Dirty or damaged connectors may result in malfunctions, so please handle them carefully.

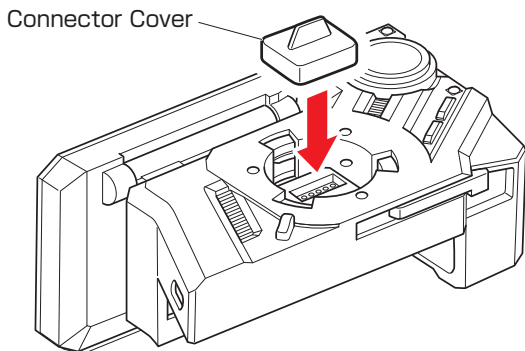

- ⚠ Do not touch the unit connectors with your fingers. If connectors become corroded due to grime, they may become inoperable. If storing the transmitter in dismantled form, please remember to attach the connector covers. After prolonged use, a black residue may build up on the connectors. Use cotton swabs dipped in cleaning alcohol to remove. KO Propo's Customer Service Department also handles transmitter maintenance.

● Power Switch

This product features a safety lock. The Master Unit and Grip Unit cannot be detached when the Power Switch is in the ON position. Turn off the transmitter before dismantling.

Power Switch

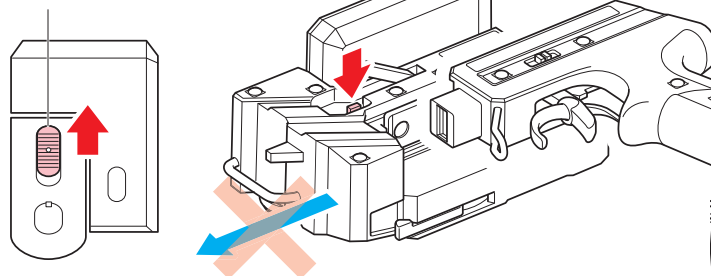

■ Preparations

● Battery Installation

1. Press the tab on the bottom of the transmitter to open battery box cover.

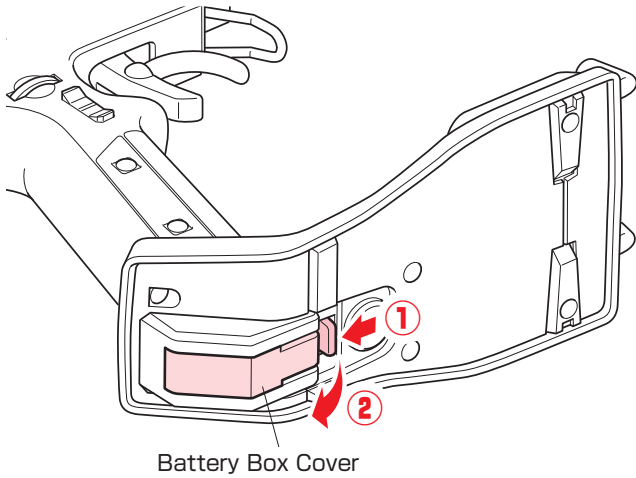

2. Remove the lock to pull out battery box.

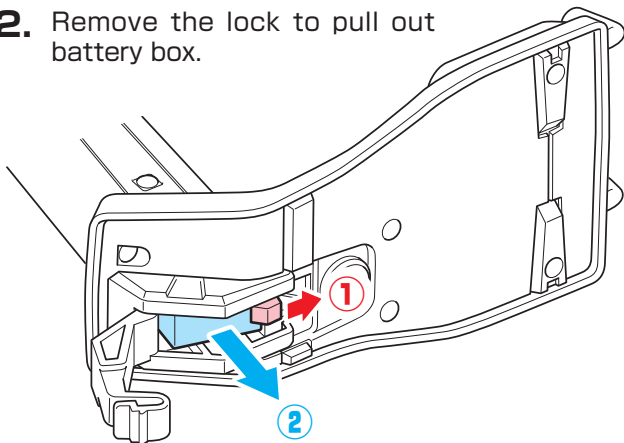

3. Install four R03/AAA/UM4 alkaline batteries while noting their polarity, then replace battery box.

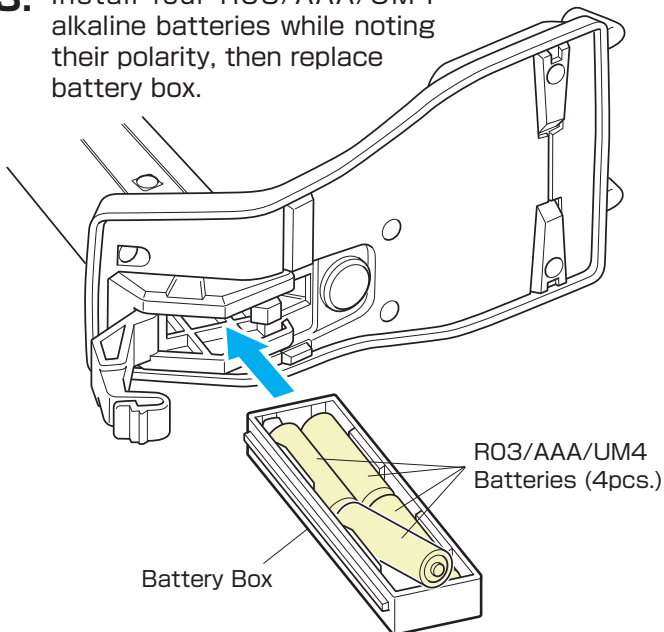

- ⚠ Use batteries which have adequate remaining capacity. Weak batteries mean lower transmitting power and may result in malfunctions.
- ⚠ Do not install Ni-Cd or Ni-MH batteries in the battery box. (These may cause the battery connectors to corrode.)

● Battery Level Warning

The power source used may be set in Power Management. A warning will be displayed and an alarm will sound when low battery voltage is detected. When you see this warning, stop your model in a safe area and install new transmitter batteries.

《Warning Display on Startup》

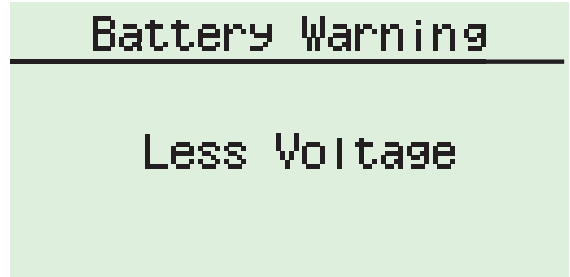

《Warning Display During Use》

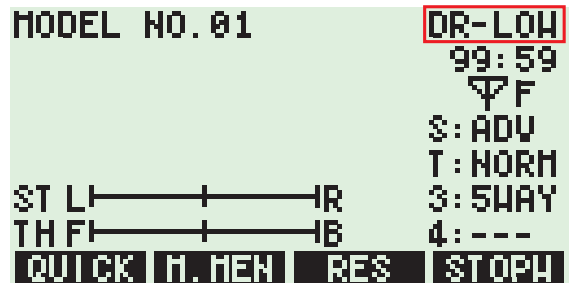

- ⚠ Operation of the transmitter's jog dial, buttons, or levers will temporarily disable the low-voltage warning display. The warning will be displayed again after a certain amount of time has passed.

● Operation Alarm

An alarm will sound after 3 minutes of transmitter idleness. Operating the steering wheel, ET Keys, BT Button, Direct Buttons, etc. will disable the alarm.

● Countermeasures Against Noise

Keep antenna cable away from all sources of noise!

Noise is generated in any area where a large amount of electric current is flowing. Position the receiver and antenna cable as far away from the motor, battery, ESC, and their associated cables as possible. (Metal or carbon fiber chassis components will also conduct electricity and generate noise.)

Since R/C models are controlled via radio signals, taking appropriate measures against noise generated by on-board equipment is of utmost importance. Take adequate measures against noise so that your machine can fully realize your driving potential.

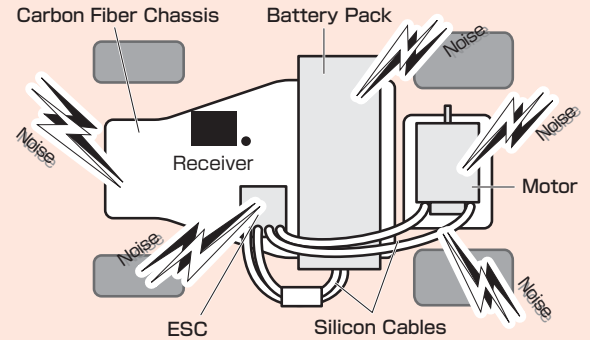

● Receiver Installation on a Carbon Fiber Chassis

When installing the receiver to the chassis or R/C equipment deck/tray, use two or more pieces of thick double-sided tape to raise the receiver off the chassis surface. By increasing the separation between the receiver and the noise-generating carbon-fiber chassis components, the effects of noise can be decreased.

※Install the receiver so that its LEDs are visible.

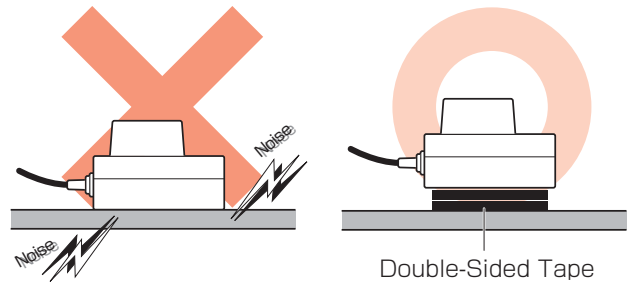

● Antenna Installation

Raise the antenna cable vertically from as high a position as possible. Insert the antenna cable into the antenna pipe so that the tip of the antenna aligns with the end of the pipe. Make the length of cable which runs between the receiver and the pipe as short as possible and position the antenna holder as close to the receiver as possible. Position the antenna cable away from sources of noise such as the chassis and R/C equipment deck/tray. Use an antenna pipe and antenna mount that are made from plastic, since metal parts will conduct noise.

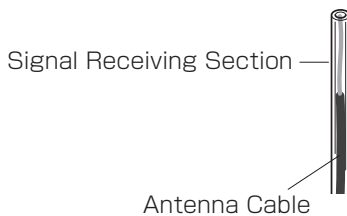

※Do not bend or cut the antenna cable. (This may break the antenna wire and deteriorate its performance.)

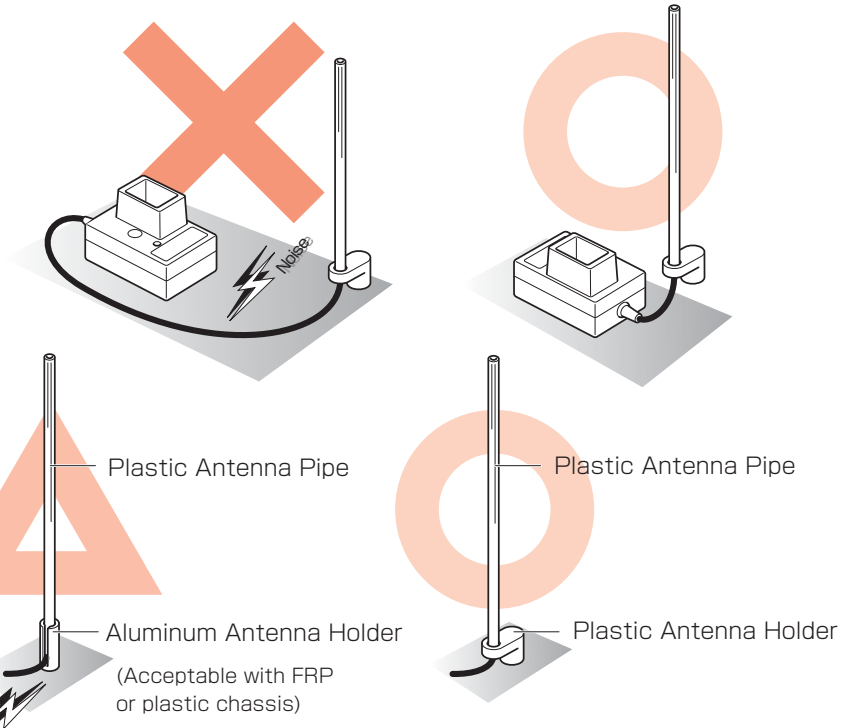

● Installing Onto a Glow Engine Car

Engine vibrations may damage the receiver. Make sure to attach a grommet (receiver holder) to reduce the effects of such vibrations. Do not attach the receiver directly to the chassis or R/C equipment deck/tray with double-sided tape. Also position the receiver so that it does not contact the heat and exhaust of the engine and muffler.

※Install the receiver so that its LEDs are visible.

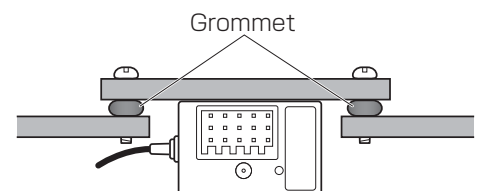

● Receiver Installation

1. Install the receiver, servo, and ESC (in the case of an electric car) onto your machine and connect them. Install the receiver while taking noise into consideration (p.10) .

※ Carefully read the instructions included with the servo and ESC before installing and using them.

2. Install batteries into the transmitter's battery box (p.9) .
In the case of an electric car, install battery pack.
In the case of a glow engine car, install battery for receiver.

3. For 2.4GHz systems, conduct pairing of the transmitter and receiver (see right column).

※ In order for the receiver to operate, it must store the transmitter's unique ID in its memory in a process called "pairing." Even if a single transmitter is used to control multiple receivers, each receiver must go through the pairing process with the transmitter before being used for the first time.

4. Adjust steering (p.19) and throttle/braking (p.24) .

5. Set the Fail-Safe Function.

● For an Electric Car

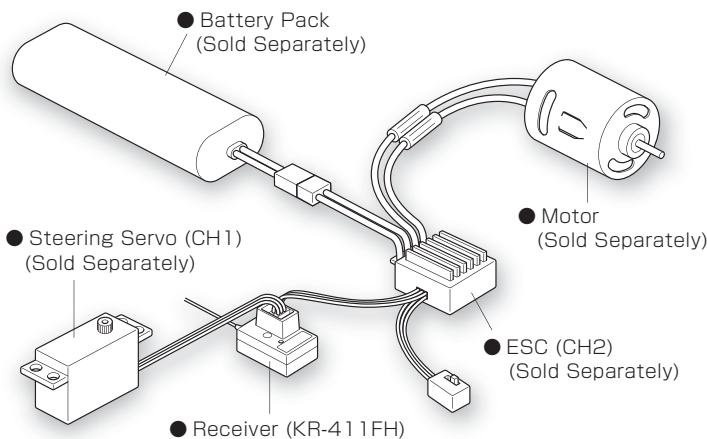

● For a Glow Engine Car

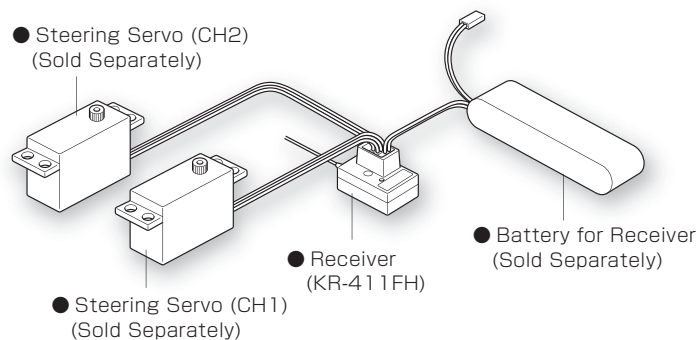

⚠ This transmitter is only compatible with digital servos. Correct operation is not possible when used with analog servos.

⚠ For items which are not included in this product, please refer to the KO Propo website for a list of compatible products. (<http://www.kopropo.co.jp>)

● Pairing

1. Preparing the Transmitter

- ① Switch on the transmitter.
- ② Press the ENTER key at the startup screen. (Main Menu display)
- ③ Use the jog dial to move the cursor to [System], then press the ENTER key.
- ④ Move the cursor to [2.4Gband] on the System Menu screen, then press the ENTER key.
- ⑤ Move the cursor to (START) on the 2.4Gband screen, then press the ENTER key.
- ⑥ Images of the transmitter and receiver will display and the arrow flow can be checked. (In this state, the transmitter is transmitting the pairing signal.)

2. Preparing the Receiver

- ① Connect the receiver power source while pressing the setup button.
- ② Check that the receiver's LED has lit up, then release the setup button.
- ③ Check that the receiver's LED lights up again (indicating pairing completion)

※ When pairing is complete, pressing the ENTER key on the transmitter will return the screen to the previous [2.4Gband] menu.

※ Switch off the receiver, then switch it back on again for normal operations.

※ The preparations below are to be carried out following the pairing procedure.

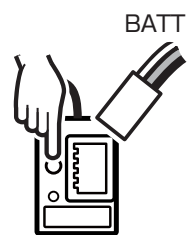

3. Preparations for Operation

- ① Switch off the receiver.
- ② Press the ENTER key on the transmitter, then press the BACK key twice to return to the initial screen.
- ③ Switch on the receiver and check that the receiver LED is lit. If the LED flashes, the receiver is not getting the transmitter signal and the pairing procedure should be repeated.

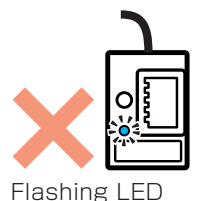

P See p.51 regarding the 2.4Gband menu.

⚠ During this process, your car may become uncontrollable if the ESC has not been adjusted. As a precaution, set your car so that its wheels do not touch the ground.

⚠ Pairing procedures may not go smoothly if there are wireless LAN, microwave ovens, or other users conducting pairing procedures nearby. In this case, move some distance away or wait a while before attempting the pairing procedure again.

■ Procedures Prior to Operation

1. Switching On

After ensuring that it is safe to do so, switch on the transmitter followed by the receiver.

This product uses the FHSS transmission system, which switches between frequencies in the 2.4GHz range at a high speed. FRANCE Mode needs to be selected if this product is to be used in France, while other countries should use GENERAL Mode.

(If the mode is switched between GENERAL and FRANCE, pairing procedure must be done with the receiver again.)

2. Model Confirmation

Confirm the model which will be used.

3. Checking Movements

With the model's wheels lifted off the ground, operate transmitter to check for proper movement. While driving, use steering and throttle trims to make fine adjustments. Drive in a figure 8 pattern to check steering balance.

P Use the [Quick Setup] function to easily arrange the initial settings.

P See 《Trim and Sub Trim Operation》 on the following page.

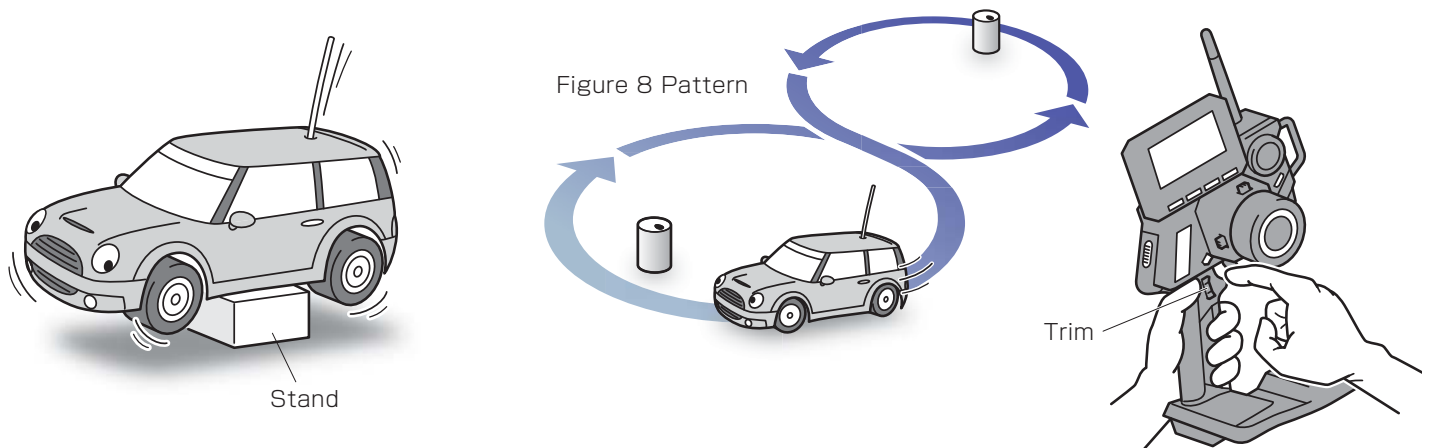

4. Switching Off

After a driving session, switch off the receiver, followed by the transmitter. Remove the battery pack from the model.

! After switching off, wait at least 5 seconds before switching on again to ensure proper operation.

! An alarm will sound if the controls are idle for **minutes. Operate the transmitter to stop the alarm.

● Trim and Sub Trim Operation

The sub trim is a convenient feature but it could also complicate the setting process if used incorrectly. Use the sub trim in the correct manner while also referring to the sub trim operation instructions on p.20 and p.25.

《Purpose of the Sub Trim》

When a servo is to be mounted onto a model, it is usually connected to the receiver temporarily to enable the transmitter to check its neutral position before it is installed. However, upon running the model it is often the case that it does not run in a straight line and the steering servo's neutral position has to be readjusted. This adjustment function is known as the "trim," but trim adjustment is not only done at the beginning, but it also must be done during model operation to account for factors such as tire wear and chassis warp. However, using the normal trim to make these intermediary adjustments could cause other problems. In the case of the steering trim, it could lead to different turning radii for the left and right wheels. For throttle trims on glow engine cars, the point of maximum braking, the full open position of the carburetor, etc. would be shifted. For this reason, the normal trims are designated as "center trims" that only adjust the neutral position, while a new function called sub trim is used in conjunction to enable the most optimal settings.

《Purpose of the Trim》

The effect of the sub trim is illustrated in the image on the right. Adjusting the sub trim also moves the left/right angle range. In contrast, the center trim moves the neutral position without changing the angle range position. However, trying to compensate the neutral position while making large sub trim adjustments may throw off the model's left/right balance.

《Actual Setting Sequence》

- ① When installing R/C equipment, the servo's neutral position is set first, then final adjustments would be made with the sub trim after installation. However, if the sub trim setting value is high, adjust the neutral position again.
- ② Test run to confirm neutral position. Adjustments during this time should also be made with the sub trim. After neutral position is fixed, adjust steering balance (p.20) so that the left and right wheels have the same turning radius and use steering travel (p.19) to adjust overall steering angle.
- ③ During the course of practice or racing, use the center trim to correct slight changes to the neutral position. If the setting value becomes high, correct in conjunction with the sub trim so that the center trim value is zero.

P Use the sub trim to adjust settings prior to driving instead of the center trim.

P Install R/C equipment when the sub trim setting value becomes low.

P If the neutral position becomes slightly off during driving, use center trim to correct.

● Trim (Center Trim)

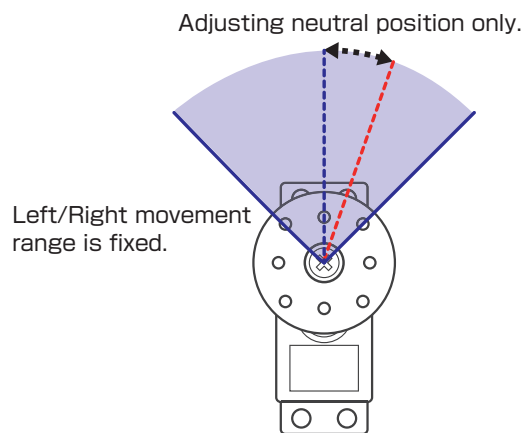

P Initially, steering trim and throttle trim are assigned to ET1 and ET2 respectively.

● Sub Trim

Left/Right angle range and neutral position can be both be adjusted.

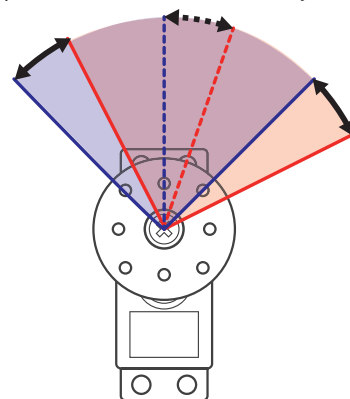

P The sub trim is accessed via the function menu, but the steering trim can be assigned to one of the ET keys in SETUP.

Display and Control Method

Basic Operations to Change Settings

 Control of setting adjustments is done via the Jog Dial, ENTER key, and BACK key.



Jog Dial : Used to move cursor between menu choices and change setting values.
 Clockwise Rotation : Raising value (for L/R cases: raising toward R); Proceed to next item
 Counterclockwise Rotation : Lowering value (for L/R cases: raising toward L); Return to previous item





ENTER Key : Selecting item to be modified; Confirming change

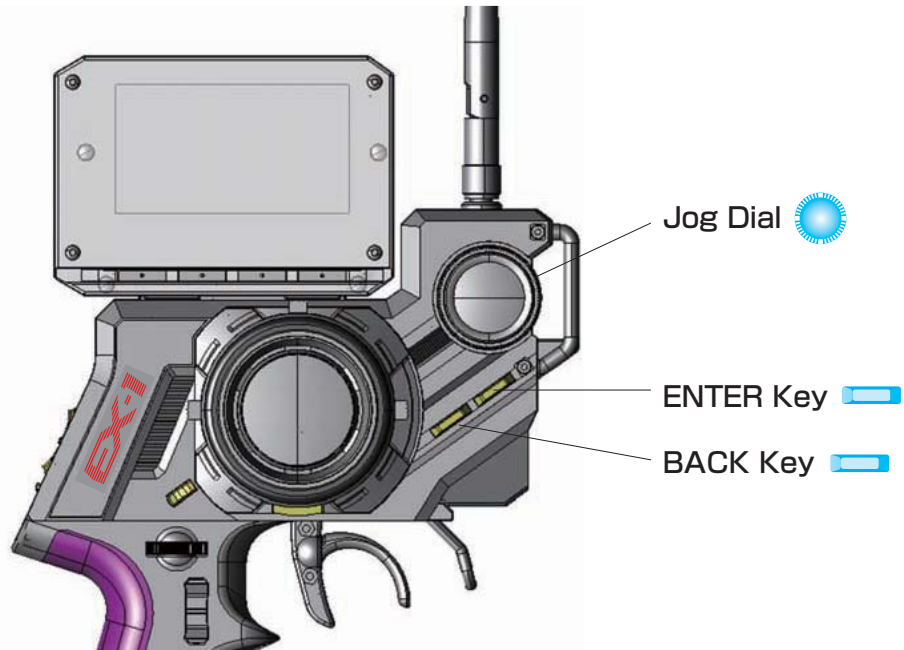

BACK Key : Returning to previous screen; Canceling change





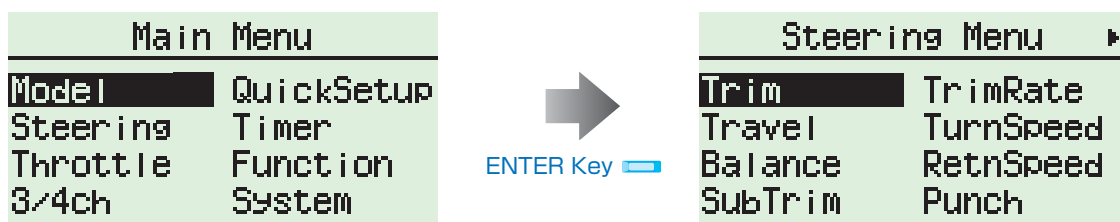

[Basic Operation 1: Selecting from a Menu] This explanation uses [Steering] as an example.

- ① Use Jog Dial  to move cursor over [Steering].
- ② Press ENTER key  to change to the Steering Menu screen.



[Basic Operation 2: Changing a Setting Value] This explanation uses [TURN 1] on the Steering Speed screen as an example.

- ① Use Jog Dial  to move cursor over the 100% value next to [TURN 1].
- ② Press ENTER key  to select it for modification.
- ③ Once selected, the cursor will blink. Now use the Jog Dial  to change the value.
- ④ After changing the value, press ENTER key  again to confirm the change.
 If you wish to cancel the change, press the BACK key at this time instead of the ENTER key .

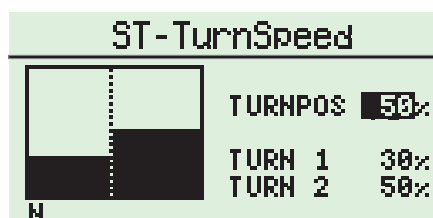

● Startup Screen and Initial Screen

When the transmitter is switched on, the startup screen will display, followed by the initial screen.

※ Pressing the ENTER key during the startup screen will allow you to proceed to the initial screen.

[Startup Screen]



① Version Information:

Displays the version of the program that is installed in the Master Unit's CPU.

This product's performance may be upgraded via paid or free upgrades. Check the KO Propo website for information regarding such upgrades. (<http://www.kopropro.co.jp>)

[Initial Screen]

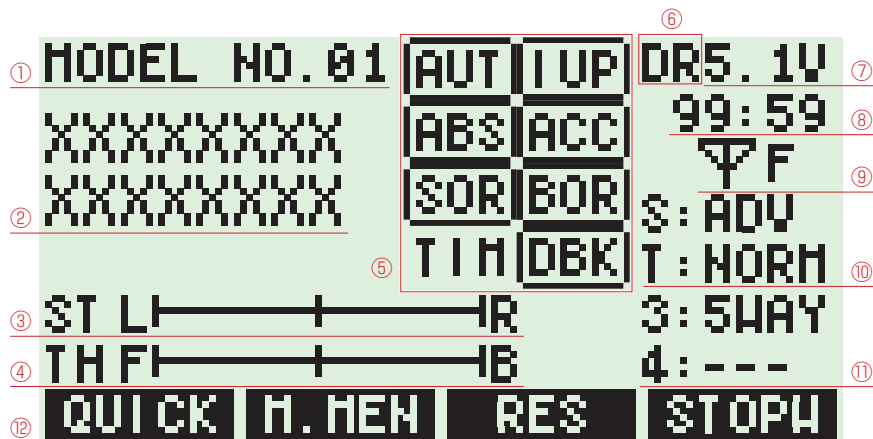

- ① **Model Number** : Displays the currently selected model number. (p.17)
- ② **Model Name** : Displays the name of the currently selected model number. (p.17)
- ③ **Steering Trim Monitor** : Displays the position of the steering trim. (p.19)
- ④ **Throttle Trim Monitor** : Displays the position of the throttle trim. (p.24)
- ⑤ **Function Monitor** : Functions that are in active will be lit up.

AUT : Throttle Auto Start	IUP : Idle Up
ABS : Throttle ABS	ACC : Throttle Acceleration
SOR : Steering Travel Override	BOR : Brake Override
TIM : Timer Activated (including Throttle Start Ready)	DBK : Drag Brake
- ⑥ **Power Source Type** : Displays the type of battery being used. (p.52)

LP : Li-Po	DR : R03/AAA/UM4 Alkaline Batteries
LF : Li-Fe	NI : Ni-MH

(Notice) If you switch battery types, make sure to also change the [Battery Management] setting.
- ⑦ **Voltage** : Displays the current power source voltage.
- ⑧ **Operation Time** : Displays how long the transmitter has been used. (p.51)
- ⑨ **2.4G Band** : Displays the 2.4G Band Mode. (p.51) G : GENERAL F : FRANCE
- ⑩ **Response Mode** : Displays the Steering (S) and Throttle (T) Response (p.49)

ADV : Advanced High Speed	HSPD : Super High Speed	NORM : Normal Speed
---------------------------	-------------------------	---------------------
- ⑪ **Control Mode** : Displays 3CH (3) and 4CH (4) control mode. (p.33)

※ On the 4CH response output will be displayed.

-- : OFF	ANLG : ANALOG
2WAY : 2WAY	4WS : 4WS Mixing
3WAY : 3WAY	AMP : Amp Mixing
5WAY : 5WAY	TH-M : Throttle Mixing
- ⑫ **Direct Button** : Displays the functions assigned to each of the 4 buttons. (p.50)

Press the ENTER key to proceed to [Main Menu].



● Main Menu

This is an index which displays the 8 different function menus. To switch between function menus, use the direct keys or do so via the main menu. (If you wish to use the direct keys, they must first be assigned.)



Model Menu (Model) (p.16)

Operations such as selecting or copying a model.



Steering Menu (Steering) (p.19)

Modify settings related to steering.



Throttle Menu (Throttle) (p.24)

Modify settings related to the throttle.



3CH/4CH Menu (3/4ch) (p.33)

Modify settings related to 3CH and 4CH



Quick Setup Menu (QuickSetup) (p.44)

Modify settings required for initial setup.



Timer Menu (Timer) (p.45)

Operating timer-related functions.



Function Menu (Function) (p.47)

Modify settings such as the monitor and buzzer.



System Menu (System) (p.49)

Modify system-related functions such as key assignment and pairing.

Main Menu	
Model	QuickSetup
Steering	Timer
Throttle	Function
3/4ch	System

Model Menu (Model)



Save various settings as model memories. Up to 40 model memories can be named and stored.

《Functions》

▶ Model Select

Switch between different model memories.

▶ Model Name

Names the model memories.

▶ Model Copy

Copies model memories.

▶ Model Reset

Resets model memories.

Model Menu
MDL - Select
MDL - Name
MDL - Copy
MDL - Reset

▶ Model Select (MDL-Select)

Switch between different model memories.

[Example]

If you have multiple cars, it is convenient to have a separate model memory for each one. Even in the case of only one car, you could save specific settings for different courses as different model memories as well.

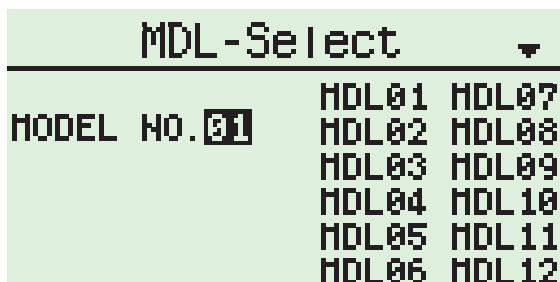

Select the model to be used. (Basic Operation p.14)

[Setting Range] MODEL : 01 - 40

- P** All of the various settings are registered under a model memory.
- P** The settings which will be switched by Model Select are...
 - 1) Steering Setting
 - 2) Throttle Setting
 - 3) 3CH Setting
 - 4) 4CH Setting
 - 5) Steering and Throttle Response
 - 6) Setup Functions (ET1-ET5, BT1 function assignments)
 - 7) LED Color
 - 8) Model Name
 - 9) Stopwatch Settings
 - 10) Countdown Timer Settings

! Switching model memory while driving may cause setting mismatches and lead to an uncontrollable model. Please place the car on a stand or switch it off before switching model memories.

▶ Model Name (MDL-Name)

This function is used to name the model memory that is currently in use. Distinguish each model memory with different names, which may also be edited. The set model name will be displayed on the initial screen and model select screen.

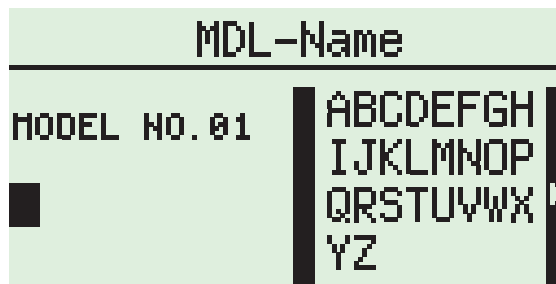

Choose one character at a time from the right side. (Basic Operation p.14)

[Setting Range] Maximum 16 characters.

《Selectable Characters》

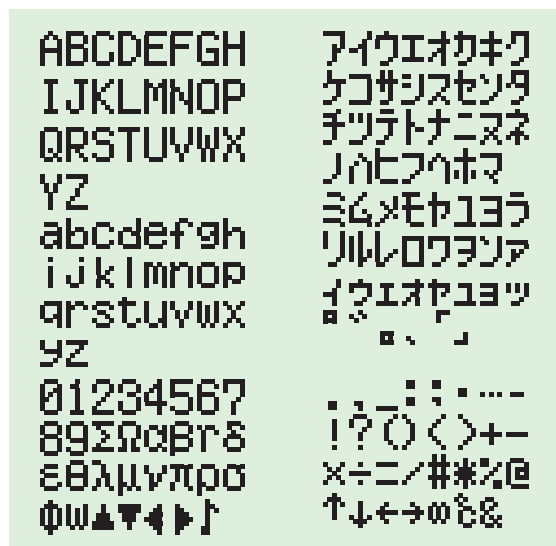

P To delete a character, overwrite the character to be deleted by using the blank space at the end of each page of characters.

▶ Model Copy (MDL-Copy)

Copies the current model memory to a different model memory.

[Example]

When changing settings on the same car to match driving conditions, it is convenient to copy the original memory before modifying it. This function also allows you to try out new settings while keeping your original one.

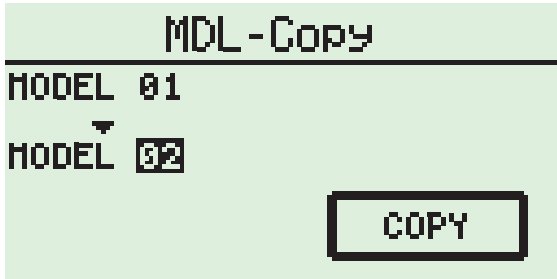

 Select the model memory to copy to, then hold the ENTER key to copy. (Basic Operation p.14)

[Setting Range] MODEL : 01 - 40

P When selecting the model memory to copy to, that model memory's name will be displayed.

P The settings which will be switched by Model Select are...

- 1) Steering Setting
- 2) Throttle Setting
- 3) 3CH Setting
- 4) 4CH Setting
- 5) Steering and Throttle Response
- 6) Setup Functions (ET1-ET5, BT1 function assignments)
- 7) LED Color
- 8) Model Name
- 9) Stopwatch Settings
- 10) Countdown Timer Settings

! The contents of the model memory that is being copied to will be overwritten. Overwritten data cannot be recovered, so be careful to avoid undesired memory overwrites.

▶ Model Reset (MDL-Reset)

Return the current model memory to default setting values.

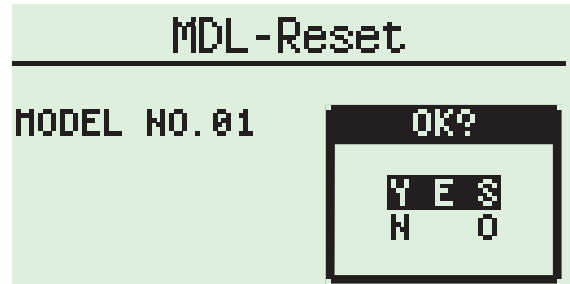

 Select [YES] (hold ENTER key) to reset. Select [NO] to cancel and return to the menu. (Basic Operation p.14)

P After reset is finished, [COMPLETE] will flash on the screen before returning to the menu.

P The settings which will be switched by Model Select are...

- 1) Steering Setting
- 2) Throttle Setting
- 3) 3CH Setting
- 4) 4CH Setting
- 5) Steering and Throttle Response
- 6) Setup Functions (ET1-ET5, BT1 function assignments)
- 7) LED Color
- 8) Model Name
- 9) Stopwatch Settings
- 10) Countdown Timer Settings

! Deleted data cannot be recovered. Be careful to avoid undesired resets.

Steering Menu (Steering)



Settings related to steering control.

《Functions》

▶ Steering Trim

Modify the neutral position of the steering angle.

▶ Steering Travel

Modify the overall amount of steering movement.

▶ Steering Balance

Modify the left/right steering angles.

▶ Steering Sub Trim

Modify the overall steering angle range.

▶ Steering Trim Rate

Modify the amount of movement which corresponds to one click of the Trim button.

▶ Steering Turn Speed

Modify the speed of the steering's turn movement.

▶ Steering Return Speed

Modify the speed of the steering's return movement.

▶ Steering Punch

Modify how much the steering initially turns from neutral position.

▶ Steering Curve

Modify the movement speed ratio which corresponds to steering angle.

▶ Steering Reverse

Modify the steering direction.

▶ Travel Override

Setting or switching the steering angle.

Steering Menu ▶	
Trim	TrimRate
Travel	TurnSpeed
Balance	RetnSpeed
SubTrim	Punch
Steering Menu ◀	
Curve	
Reverse	
Travel OR	

▶ Steering Trim (ST-Trim)

Adjusts the neutral/center position of the steering angle range.

※ Also refer to Trim and Sub Trim Operation. (p.13)

(N : Neutral L : Left R : Right)

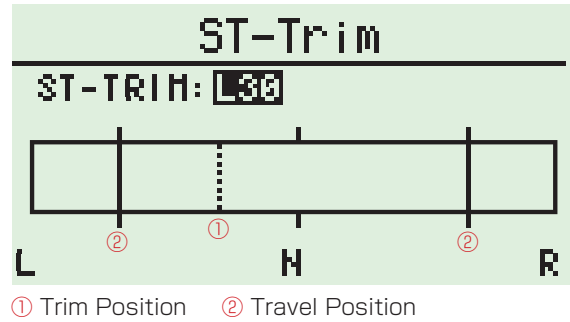

[Setting Range] L 50 - 0 - R 50 (Default : 0)

P Setting adjustments prior to driving should be carried out with the sub trim, not the trim.

P The setting range cannot exceed what is set by [Steering Travel] or [Steering Balance].

▶ Steering Travel (ST-Travel)

Adjust the overall amount of steering servo movement when the steering wheel is at full lock.

(N : Neutral L : Left R : Right)

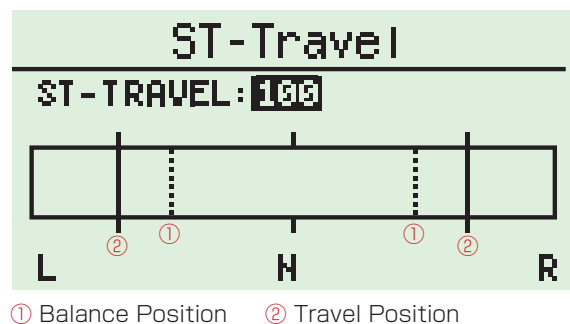

[Setting Range] 0 - 150 (Default : 100)

P Since the Balance setting value is a ratio of the Travel setting value, if the latter is modified the actual movement value and the displayed graphic will also change.(the Travel value will not change).

! Steering will not operate if the Travel value is set to 0.

► Steering Balance (ST-Balance)

Adjust the left/right steering angles independently. This enables the turning radii to match up during cornering.

(N : Neutral L : Left R : Right)

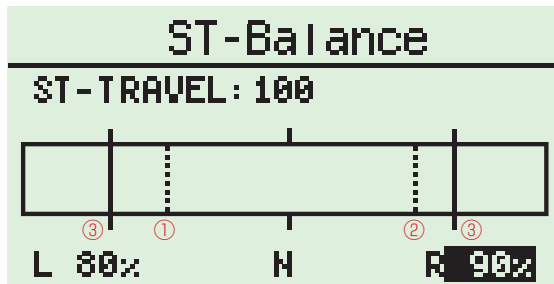

- ① Balance L Position ② Balance R Position
③ Travel Position

[Setting Range] (Default : 70%)

L : 30 - 100%
R : 30 - 100%

P The set percentage is a ratio of the value set by the Steering Travel.

P Steering balance can be adjusted by using the steering wheel and ET key!

If an ET key that is assigned to steering trim is pressed while the steering is turned over halfway in either direction, the balance of the direction of the turn can be adjusted.

※ However, this cannot be done while on the Function Menu or System Menu screens.

P If the trim is set to a large value, a large left/right value discrepancy may result. If adjusting steering balance for the first time, follow the procedures below.

- ① Set trim value to 0.
- ② Adjust sub trim so that the car drives in a straight line when steering is in neutral position.
- ③ Use steering travel to match the overall steering angle range.
- ④ Use steering balance to match the left/right turning radii.
- ⑤ If the car does not drive straight at this point, use trim to correct.

► Steering Sub Trim (ST-SubTrim)

Adjust the position of the overall steering angle range. Use this to match the neutral position when installing the steering servo.

※ Also refer to Trim and Sub Trim Operation. (p.13)

[Example]

The servo horn position can be adjusted by the linkages, etc. when the servo is installed onto the model, but in case this does not set the neutral position, this function can be used to set it from the transmitter.

(N : Neutral L : Left R : Right)

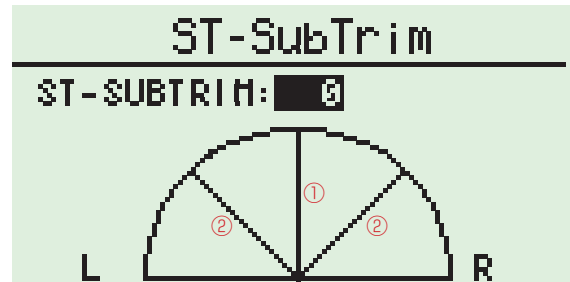

- ① Sub Trim Position (Dotted Line : Neutral Position)
② Steering Angle Image

[Setting Range] L 80 - 0 - R 80 (Default : 0)

P If the sub trim value becomes large, adjust the servo horn position or linkages so that the value becomes closer to 0. If the sub trim value is too large, dead zones could result and the servo may not operate at the extremities of its movement range.

► Steering Trim Rate (TrimRate)

Adjusts the amount of movement associated with one click of the trim button. This setting screen is common with the throttle.



[Setting Range]

STEERING : 1 - 10 intervals (Default : 5)

THROTTLE : see Throttle Trim Rate

P Although the amount of movement of one interval can be adjusted, the lower the number the smaller the amount of movement.

P The overall number of intervals does not change, so a change in trim rate will result in a change in the range in which the trim can be used to make corrections.

P If the trim rate is changed when the trim is already set, the trim may be thrown off. ※ If the trim setting is 0 then this does not apply.)

P Lower trim rates enable fine adjustments, but the effects may not be apparent depending on the servo used. If there is a lot of slop in the linkage or servo saver, fine trim adjustments could cause the user to constantly worry about the trim settings. In that case, please reexamine the linkages, etc.

▶ Steering Turn Speed (TurnSpeed)

This function limits the maximum speed of the steering servo by adjusting the steering turn direction [TURN] setting. The steering angle between neutral and full lock is split into two zones and each may be adjusted independently (2WAY).

(N : Neutral)

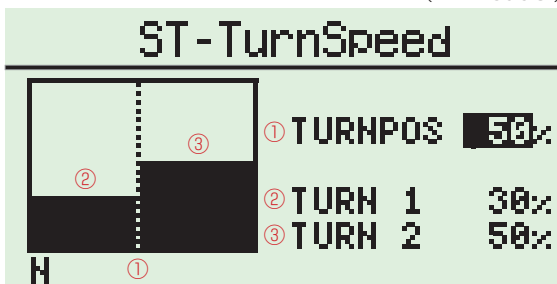

【Setting Range】

- ① TURNPOS : 1 - 100% (Default : 50%)
This sets the point at which the two speed zones are split.
- ② TURN 1 : 1 - 100% (Default : 100%)
This sets the speed from when the steering has begun to turn.
- ③ TURN 2 : 1 - 100% (Default : 100%)
This sets the speed from after the split to the second zone.

P You can set the speed to be slow during initial turning, then subsequently faster.

P If your car flips on high-grip surfaces, lower the [TURN 1] value to make cornering easier.

P 《Changing to 1WAY》
Changing [TURNPOS] to 100 will deactivate [TURN 2] and [TURN 1] will be used to set the speed.



P Take into account such factors as the servo used, car, driving surface, etc. when adjusting all settings. Conduct test drives to find the best setting values.

P Effective speed values are dependent on the speed characteristics of your selected servo.

▶ Steering Return Speed (RetnSpeed)

This function limits the maximum speed of the steering servo by adjusting the steering return direction [RETURN] setting. The steering angle between neutral and full lock is split into two zones and each could be adjusted independently (2WAY).

(N : Neutral)



【Setting Range】

- ① RETNPOS : 1 - 100% (Default : 50%)
This sets the point at which the two speed zones are split.
- ② RETN 2 : 1 - 100% (Default : 100%)
This sets the speed before the split position point.
- ③ RETN 1 : 1 - 100% (Default : 100%)
This sets the speed from after the split to the second zone.

P 《Changing to 1WAY》
Changing [RETNPOS] to 100 will deactivate [RETN 2] and [RETN 1] will be used to set the speed.



P Take into account such factors as the servo used, car, driving surface, etc. when adjusting all settings. Conduct test drives to find the best setting values.

P Effective speed values are dependent on the speed characteristics of your selected servo.

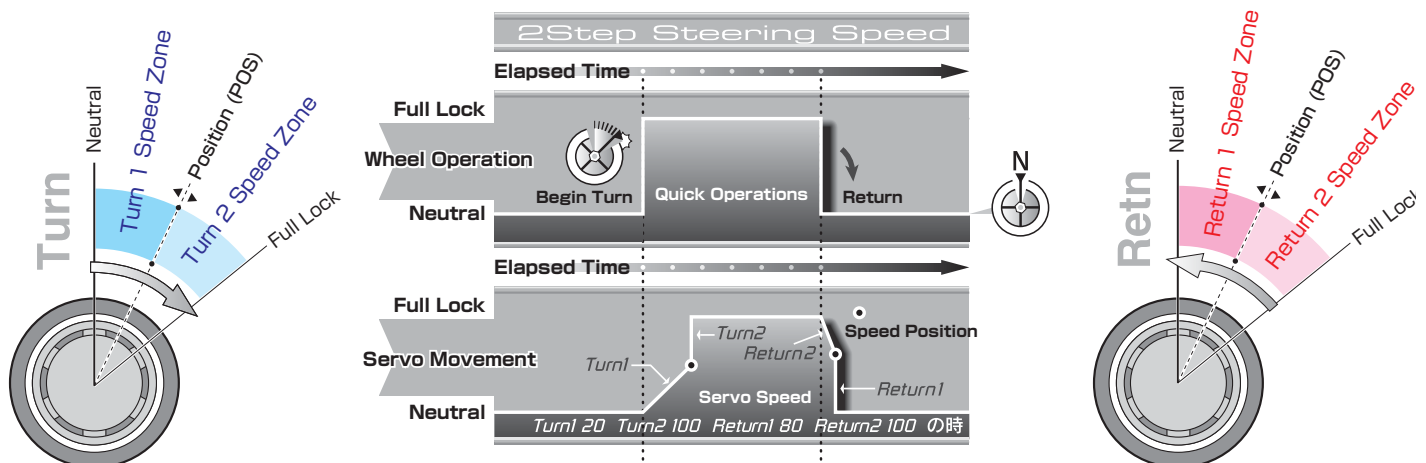

Different values will affect the graph's appearance

► Steering Punch (ST-Punch)

This function quickens the steering's initial response and can be used to instill a strong turning movement when the steering initially moves from neutral.

(N : Neutral L : Left R : Right)

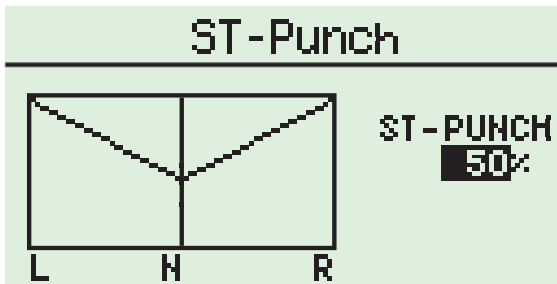

[Setting Range] OFF, 1 - 50% (Default : OFF)

- P** The larger the value, the stronger the amount of turning movement.
- P** This could be effective if steering linkages have a lot of slop, but please note that it does not improve straight-line performance.
- P** When using this in conjunction with other functions such as [Steering Speed], adjust one at a time to confirm their effects to produce an effective overall setting.

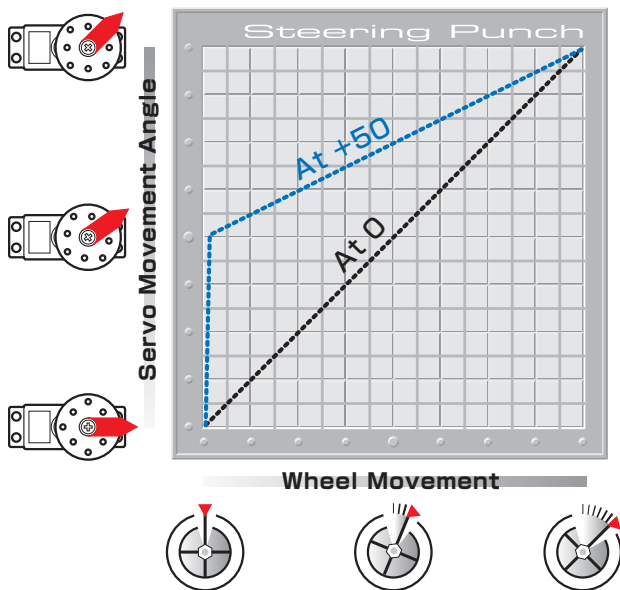

► Steering Curve (ST-Curve)

This function adjusts the ratio of the steering angle to servo movement speed (Curve Characteristics). Choose between (+) Quick Curve and (-) Mild Curve.

(N : Neutral L : Left R : Right)

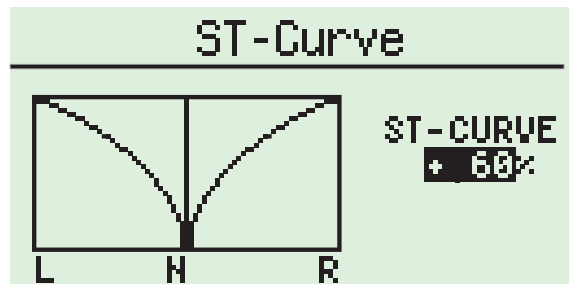

[Setting Range] -100 - OFF - 100% (Default : OFF)

- P** As the graph shows, servo movement speed can be changed according to wheel movement angle. Positive values (+1 to +100) equal high initial response followed by mild response. Negative values (-1 to -100) equal a mild initial response followed by high response.
- P** When using this in conjunction with other functions such as [Steering Speed], adjust one at a time to confirm their effects to produce an effective overall setting.
- P** To adjust only the steering's initial response, use the [Steering Punch] function.

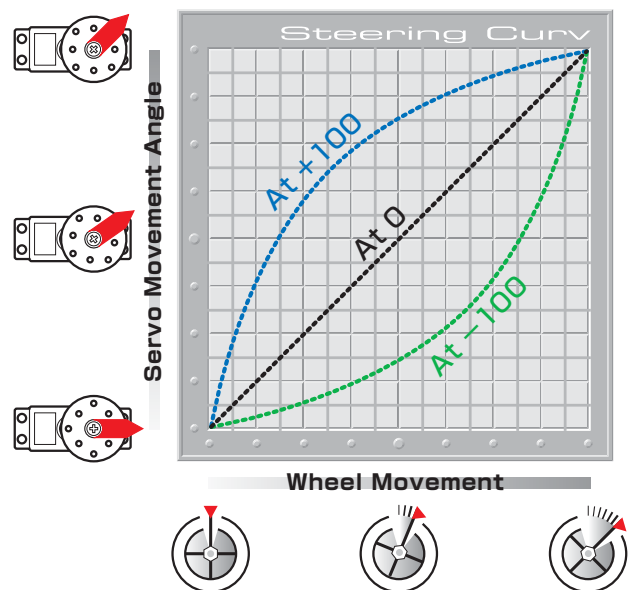

▶ Steering Reverse (ST-Reverse)

This function reverses the steering direction. This setting screen is common with the throttle.

[Example]

Use this function when, after installing the servo, movements are the opposite of transmitter inputs (turning the steering wheel right results in wheels turning left, etc.).

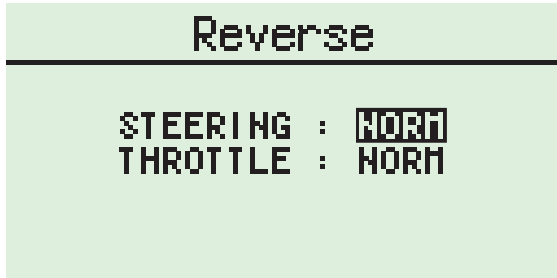

[Setting Range] (Default : NOR)

STEERING : REV (Reverse) , NOR (Normal)

THROTTLE : see [Throttle Reverse]

 Steering direction varies from car to car and should be checked when the R/C equipment has been installed.

▶ Travel Override (Travel Override)

Adjust the steering angle according to the driving conditions to make the car easier to control.

[Example]

Convenient for changing the steering angle on straights to give the car better straight-line stability.

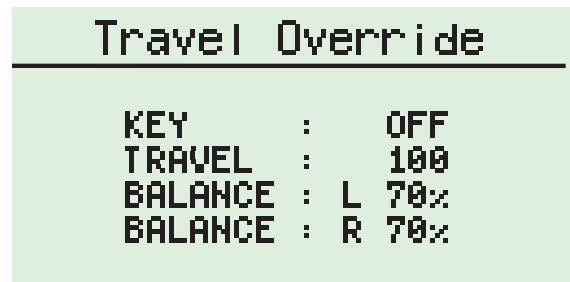

[Setting Range]

KEY : OFF, ET1 - 5, BT1 (Default : OFF)

Assigns a key to be used to switch between the steering travel/balance settings and the travel override.

TRAVEL : 0 - 150 (Default : 100)

Sets the travel override's travel setting.

BALANCE L : 40 - 100% (Default : 70%)

BALANCE R : 40 - 100% (Default : 70%)

Sets the balance of the travel override. R and L refer to the balance when turning right and left respectively.

※ For detailed explanations of travel and balance, refer to [Steering Travel] and [Steering Balance]

[SOR] Display on the Function Monitor!

Operating the key that is assigned by [KEY] will result in [SOR] being displayed on the initial screen's function monitor. If that key is pressed while at the initial screen, [SOR] will disappear from the function monitor.

 The setting value percentage is a ratio of the travel value set during [Steering Travel].

Steering balance can be adjusted by using the steering wheel and ET key!

When travel override is ON, if an ET key that is assigned to steering trim is pressed while the steering is turned over halfway in either direction the balance of the direction of the turn can be adjusted.

※ However, this cannot be done while on the Function Menu or System Menu screens.

Throttle Menu (Throttle)



Settings related to throttle control.

《Functions》

▶ Throttle Trim

Modify the neutral position of the throttle.

▶ Throttle High Point

Modify the maximum amount of throttle movement (towards forward acceleration).

▶ Throttle Brake

Modify the maximum amount of throttle brake movement.

▶ Throttle Sub Trim

Modify the overall throttle movement range.

▶ Throttle Trim Rate

Modify the amount of movement which corresponds to one click of the throttle trim button.

▶ Throttle Turn Speed

Modify the speed of the throttle's movement (towards forward acceleration).

▶ Throttle Return Speed

Modify the speed of the throttle's return movement.

▶ Throttle Punch

Modify how much the throttle initially accelerates from neutral position.

▶ Throttle Curve

Modify the movement speed ratio which corresponds to how much throttle is applied.

▶ Throttle Reverse

Modify the throttle direction.

▶ Throttle Drag Brake

Modify the amount of neutral braking.

▶ Brake Override

Modify of switch the maximum amount of braking.

▶ 又 Throttle ABS

Modify the amount of brake pumping.

▶ Throttle Acceleration

Modify the amount of acceleration burst of the throttle.

▶ Throttle Auto-Start

Set the amount of throttle automatically at startup.

▶ Idle Up

Modify the neutral position of the throttle trigger.

Throttle Menu ▶	
Trim	TrimRate
HiPoint	TurnSpeed
Brake	RetnSpeed
SubTrim	Punch
Throttle Menu ◀	
Curve	ABS
Reverse	Accel
DragB	AutoStart
Brake OR	IdleUp

▶ Throttle Trim (TH-Trim)

Adjusts the neutral/center position of the throttle range.

※ Also refer to Trim and Sub Trim Operation. (p.13)

(N : Neutral F : Forward B : Brake)

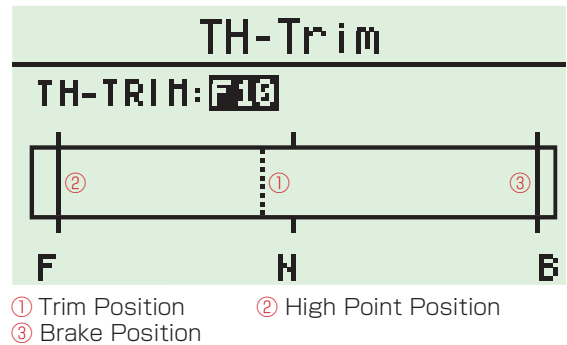

[Setting Range] F 50 - 0 - B 50 (Default : 0)

P Setting adjustments prior to driving should be carried out with the sub trim, not the trim.

P The setting range cannot exceed what is set by [Throttle High Point] or [Throttle Brake].

▶ Throttle High Point (TH-Point)

Adjust the maximum amount of throttle forward acceleration movement.

《Example》

This makes it particularly easy to adjust a glow engine car's high carburetor setting. For electric cars, this is used to set the point of the ESC's highest speed.

(N : Neutral F : Forward B : Brake)

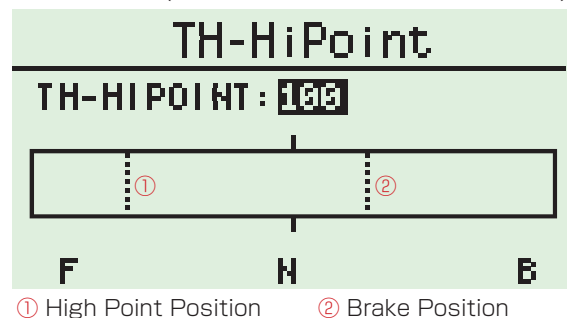

[Setting Range] 0 - 150 (Default : 100)

P On glow engine cars, an overly high setting value will increase load on the servo and lead to it being damaged. Check carefully while adjusting.

P On electric cars, a setting value that is too small may cause problems with the ESC settings. Make adjustments starting from the default setting (100).

P If the throttle high point is set low and the trim is set to a high value toward acceleration, the resulting throttle movement may be extraordinarily small.

! Throttle will not operate if the High Point value is set to 0.

▶ Throttle Brake (TH-Brake)

Adjust the maximum amount of brake movement.

(N : Neutral F : Forward B : Brake)

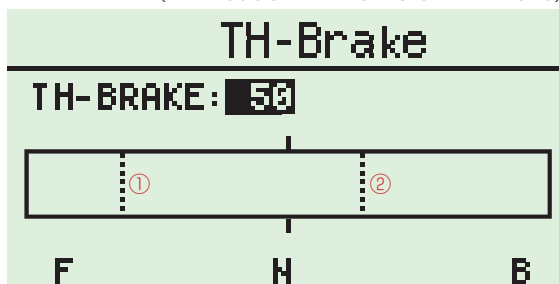

① High Point ② Brake Position

[Setting Range] 0 - 150 (Default : 100)

P On glow engine cars, an overly high setting value will increase load on the servo and lead to it being damaged. Check carefully while adjusting.

P On electric cars, a setting value that is too small may cause problems with the ESC settings. Make adjustments starting from the default setting (100).

! Brake will not operate if the value is set to 0.

▶ Throttle Sub Trim (TH-SubTrim)

Adjust the position of the overall throttle movement range. Use this function when the neutral position cannot be centered with only linkage adjustment.

※ Also refer to Trim and Sub Trim Operation. (p.13)

[Example]

The servo horn position can be adjusted by the linkages, etc. when the servo is installed onto the model, but in case the neutral position cannot be centered, this function can be used to set it from the transmitter.

(N : Neutral F : Forward B : Brake)

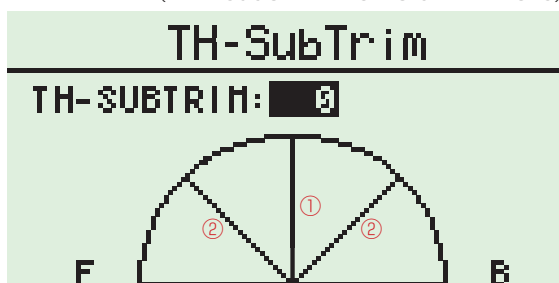

① Sub Trim Position (Dotted Line : Neutral Position)
② Steering Angle Image

[Setting Range] F 80 - 0 - B 80 (Default : 0)

P If the sub trim value becomes large, adjust the servo horn position or linkages so that the value becomes closer to 0. If the sub trim value is too large, dead zones could result and the servo may not operate at the extremities of its movement range.

▶ Throttle Trim Rate (TH-TrimRate)

Adjusts the amount of movement associated with one click of the throttle trim button. This setting screen is common with the steering.



[Setting Range]

STEERING : see [Steering Trim Rate]

THROTTLE : 1 - 10 intervals (Default : 5)

P The overall number of intervals does not change, so a change in trim rate will result in a change in the range in which the trim can be used to make corrections.

P If the trim rate is changed when the trim is already set, the trim may be thrown off. ※ If the trim setting is 0 then this does not apply.)

P Lower trim rates enable fine adjustments, but the effects may not be apparent depending on the servo used. If there is a lot of slop in the linkage or servo saver, fine trim adjustments could cause the user to constantly worry about the trim settings. In that case, please reexamine the linkages, etc.

P Although the amount of movement of one interval can be adjusted, the lower the number the smaller the amount of movement.

▶ Throttle Turn Speed (TH-TurnSpeed)

This function delays the conversion of the throttle control signal to make the car easier to control. The speed of the forward acceleration direction [TURN] is split into three zones and each may be adjusted independently (3WAY).

※The [RETURN] direction is adjusted with [Throttle Return Speed].

[Example]

If the car spins or otherwise does not drive straight when the throttle is applied suddenly, limiting the throttle speed can be effective.

(N : Neutral F : Full Acceleration L : Low Speed Zone
M : Mid Speed Zone H : High Speed Zone)

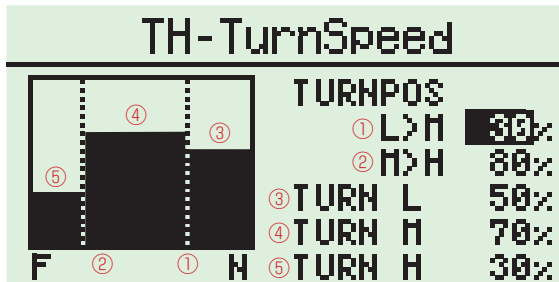

[Setting Range]

- ① TURNPOS L > M : 1 - 100% (Default : 30%)

This sets the point between the low and mid-speed acceleration zones.

- ② TURNPOS M > H : 1 - 100% (Default : 80%)

This sets the point between the mid and high speed acceleration zones.

- ③ TURN L : 1 - 100% (Default : 100%)

This sets the speed during the low speed acceleration zone.

- ④ TURN M : 1 - 100% (Default : 100%)

This sets the speed during the mid speed acceleration zone.

- ⑤ TURN H : 1 - 100% (Default : 100%)

This sets the speed during the high speed acceleration zone.

- P** This product enables you to set throttle speed to either POSITION or SPEED. (Depending on the POSITION setting, SPEED's modifiable settings may change.)

- P** [TURNPOS L > M] is always the smaller or equal value to [TURNPOS M > H]. Even if you try to set it otherwise, the values will automatically correct themselves.

- P** Turn Speed may be set to be divided into two zones (2WAY) or have no divisions at all (1WAY).

《Changing to 2WAY》

Changing the two [TURNPOS] to the same value will deactivate [TURN M]. [TURN L] and [TURN H] will be used to set the speed.

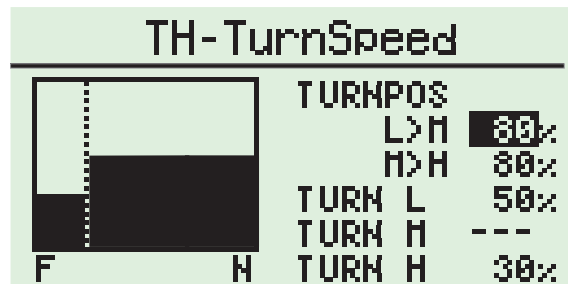

《Changing to 1WAY》

Changing the two [TURNPOS] to 100 will deactivate [TURN M] and [TURN H]. [TURN L] will be used to set the speed.

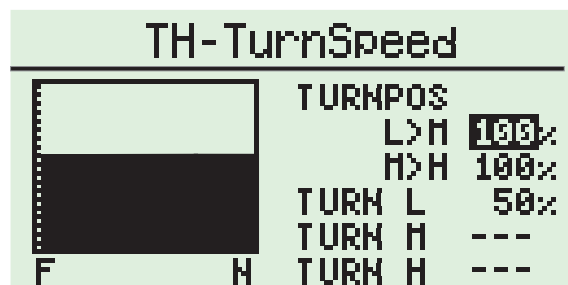

- P** This is effective for both glow engine cars as well as electric cars with ESCs.

- !** Throttle Turn Speed only affects the throttle's forward acceleration. It does not affect the brake.

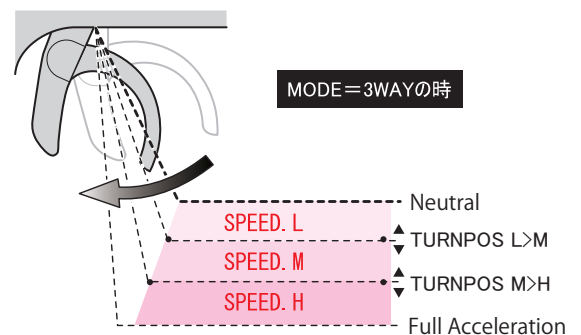
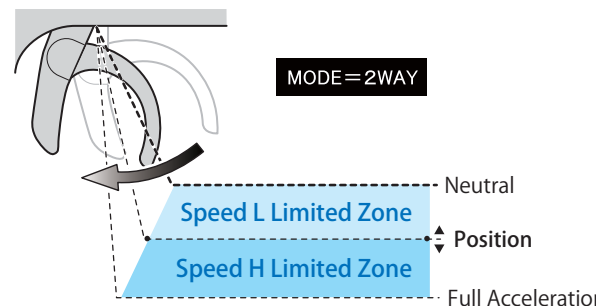

▶ Throttle Return Speed (TH-ReturnSpeed)

This function delays the conversion of the throttle control signal to make the car easier to control. The speed of the deceleration direction [RETURN] is split into three zones and each may be adjusted independently (3WAY).

※The [TURN] direction is adjusted with [Throttle Turn Speed].

[Example]

If the car spins or locks up the brakes when the throttle is released suddenly, limiting the throttle speed can be effective.

(N : Neutral F : Full Acceleration L : Low Speed Zone
M : Mid Speed Zone H : High Speed Zone)

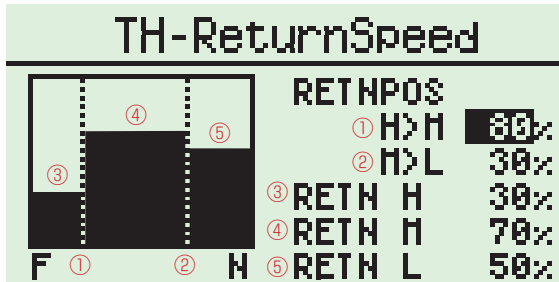

[Setting Range]

- ① RETNPOS H > M : 1 - 100% (Default : 80%)
This sets the point between the low and mid-speed deceleration zones.
- ② RETNPOS M > L : 1 - 100% (Default : 30%)
This sets the point between the mid and high speed deceleration zones.
- ③ RETN L : 1 - 100% (Default : 100%)
This sets the speed during the low speed deceleration zone.
- ④ RETN M : 1 - 100% (Default : 100%)
This sets the speed during the mid speed deceleration zone.
- ⑤ RETN H : 1 - 100% (Default : 100%)
This sets the speed during the high speed deceleration zone.

P This product enables you to set throttle speed to either POSITION or SPEED. (Depending on the POSITION setting, SPEED's modifiable settings may change.)

P [RETNPOS L > M] is always the smaller or equal value to [RETNPOS M > H]. Even if you try to set it otherwise, the values will automatically correct themselves.

P Return Speed may be set to be divided into two zones (2WAY) or have no divisions at all (1WAY).

《Changing to 2WAY》

Changing the two [RETNPOS] to the same value will deactivate [RETN M]. [RETN H] and [RETN L] will be used to set the speed.

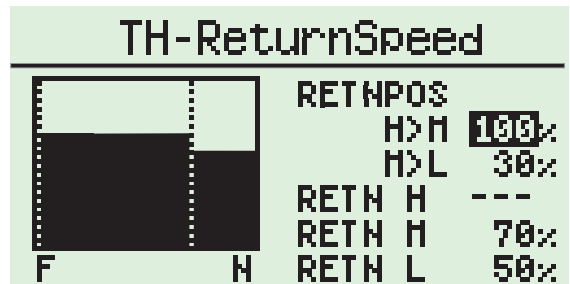

《Changing to 1WAY》

Changing the two [RETNPOS] to 100 will deactivate [RETN M] and [RETN H]. [RETN L] will be used to set the speed.

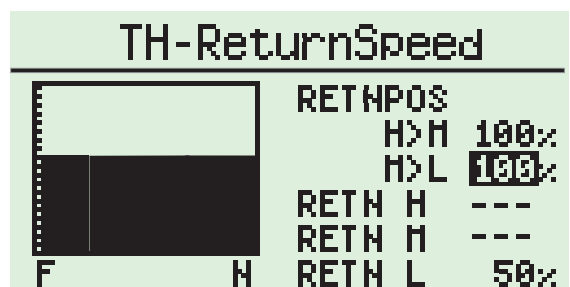

P This is effective for both glow engine cars as well as electric cars with ESCs.

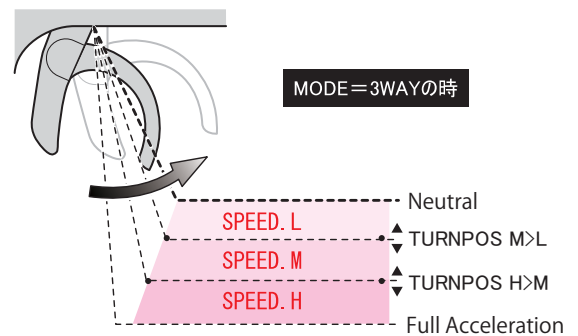
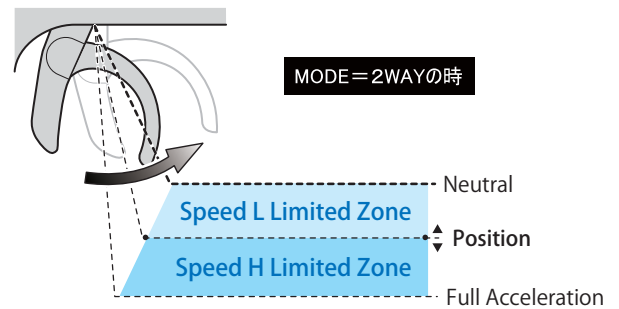

▶ Throttle Punch (TH-Punch)

This function quickens the throttle's initial response and can be used to instill a sense of power when the throttle initially moves from neutral.

(N : Neutral F : Forward B : Brake)

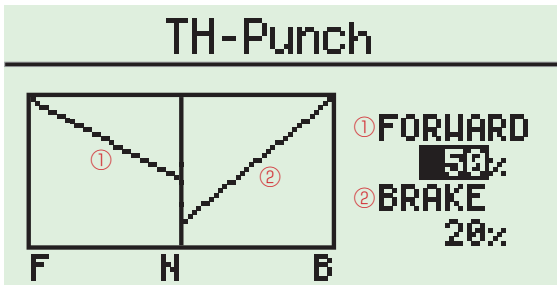

[Setting Range] (Default : OFF)

- ① FORWARD : OFF, 1 - 50%
- ② BRAKE : OFF, 1 - 50%

! The larger the value, the larger the amount of throttle movement. However, depending on other settings, the throttle operation may become jagged.

! If using this in conjunction with other functions such as [Throttle ABS], confirm the operation before using.

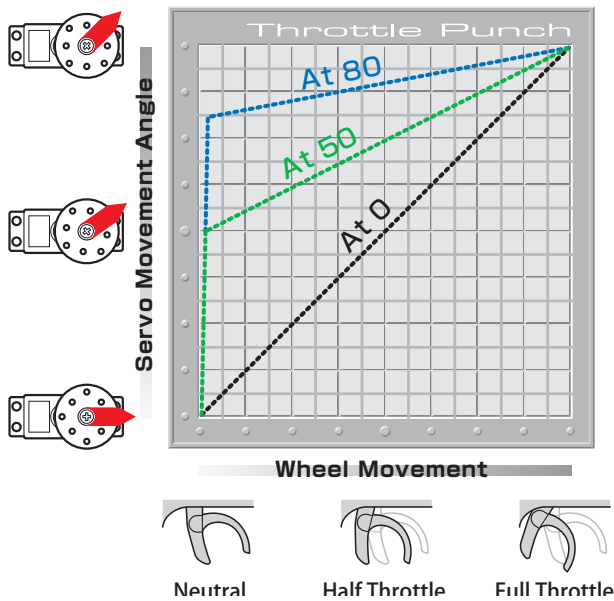

▶ Throttle Curve (TH-Curve)

This function sets the signal conversion rate to a curve to enable quicker or milder response. Likewise, braking can also be set to a braking curve.

(N : Neutral F : Forward B : Brake)

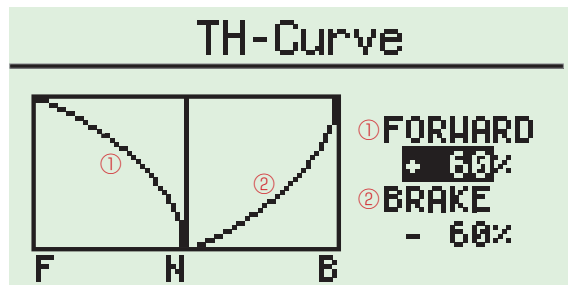

[Setting Range] (Default : OFF)

- ① FORWARD : -100 - OFF - 100%
- ② BRAKE : -100 - OFF - 100%

P [When [Throttle Punch] is activated, the characteristics of the throttle curve value is also added to the Throttle Punch value.

P Positive values (+1 to +100) equal high initial response followed by mild response. Negative values (-1 to -100) equal a mild initial response followed by high response.

P When using this in conjunction with other functions, adjust one at a time to confirm their effects to produce an effective overall setting.

P This function adjusts only the curve. Use the [Throttle Punch] function if you wish to adjust the initial response.

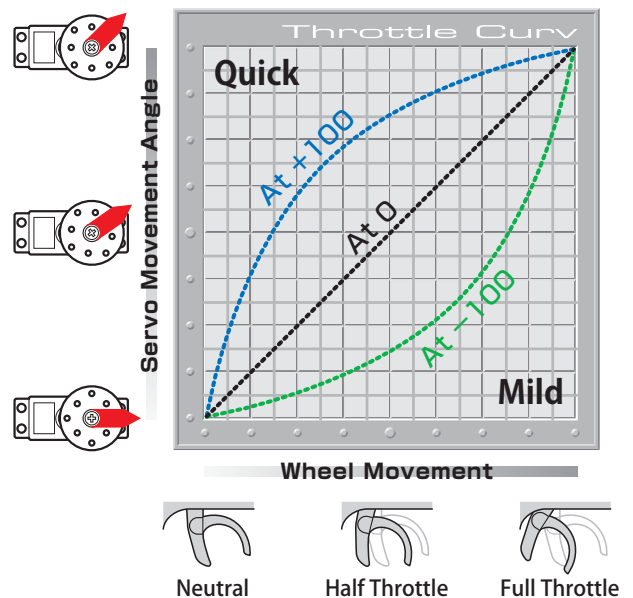

▶ Throttle Reverse (TH-Reverce)

This function reverses the throttle direction. This setting screen is common with the steering.

[Example]

Use this function when, after installing the servo, movements are the opposite of transmitter inputs (pulling the trigger to accelerate forward results in reverse movement).

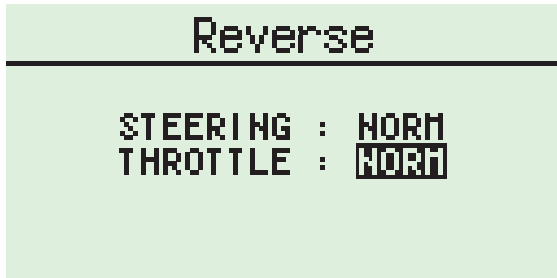

[Setting Range] (Default : NOR)

STEERING : see [Steering Reverse]

THROTTLE : REV (Reverse) , NOR (Normal)

P For electric cars, the throttle is set by the ESC so there is no need to set this function. However, some older ESCs will not function properly unless reverse is also set.

▶ Throttle Drag Brake (TH-DragBrake)

This function enables a light brake application at the moment when the throttle position changes from acceleration to deceleration.

[Example]

Normally, the throttle would return to neutral when it is released from acceleration. However, depending on the type of vehicle or race, a light application of brake at this moment may make driving easier.

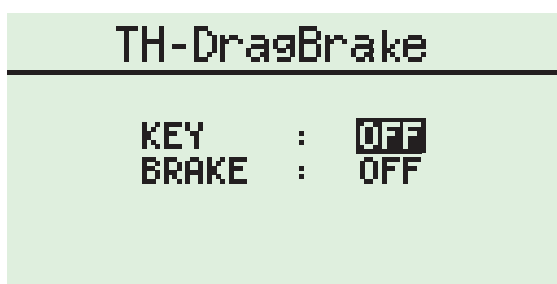

[Setting Range] (Default : OFF)

KEY : OFF, ET1 - 5, BT1

Assigns a key to be used to activate/deactivate the drag brake.

BRAKE : OFF, 0.5 - 50.0 {increments of 0.5}

Sets the amount of neutral brake.

P If [BRAKE] is set to any value other than OFF, drag brake will be activated. Drag brake can also be activated/deactivated via the key assigned by [KEY].

P [DBK] Display on the Function Monitor!

If [BRAKE] is not set to OFF, [DBK] will be displayed on the initial screen's function monitor. If the key assigned to drag brake is pressed while at the initial screen, [DBK] will disappear from the function monitor.

▶ Brake Override (Brake Override)

Arrange another maximum brake setting, which can be activated/deactivated by the ET lever or BT button.

[Example]

If a change in driving conditions is foreseen, the throttle brake setting can be changed during driving.

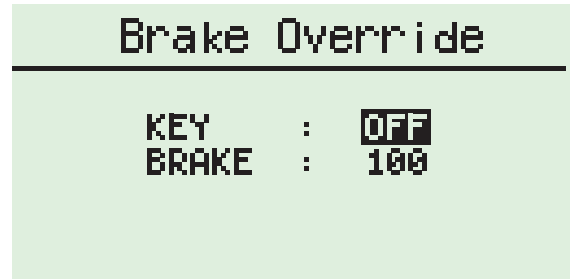

[Setting Range]

KEY : OFF, ET1 - 5, BT1 (Default : OFF)

Assigns a key to be used to activate/deactivate the brake override.

※If brake override is deactivated, the throttle brake setting will be activated.

BRAKE : 0 - 100% (Default : 100%)

Sets the brake override's brake setting.

※For detailed explanations of the brake function, refer to [Throttle Brake].

P Like Travel Override, this function is used to change the brake setting. If a change in driving conditions is foreseen, the throttle brake setting can be changed during driving.

P [BOR] Display on the Function Monitor!

If the key assigned to brake override is pressed, [BOR] will be displayed on the initial screen's function monitor. If this key is pressed while at the initial screen, [BOR] will disappear from the function monitor.

▶ Throttle ABS (TH-ABS)

To prevent tires from locking up during sudden braking, brake pumping will be applied.

[Example]

This function is effective when your car's wheels lock up under braking and disturbs the car's balance. It will help enable smooth cornering performance.

(n : Neutral B.MAX : Maximum Brake)

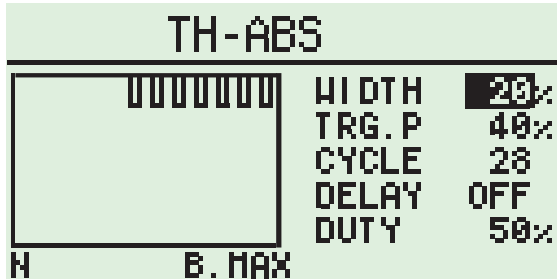

[Setting Range]

WIDTH : OFF, 1 - 100% (Default : OFF)

Sets the amount of brake pumping.

TRG.P : 5 - 100% (Default : 60%)

Sets the function's starting position.

CYCLE : 1 - 30 (Default : 28)

Sets the speed of the brake pumping.

DELAY : OFF, 1 - 100 (Default : OFF)

Sets the delay time before the function's operation.

DUTY : 10 - 90% (Default : 50%)

Sets the duration of the brake pumping.

KEY : OFF, ET1 - 5, BT1 (Default : OFF)

Assigns a key to be used to activate/deactivate the ABS.

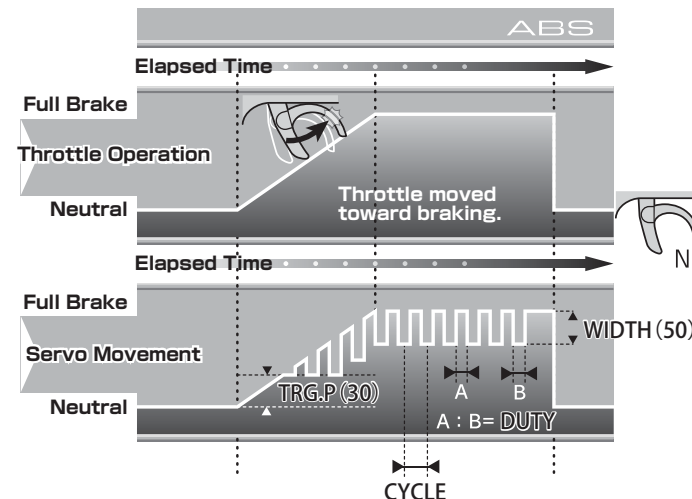

《Regarding WIDTH and TRG.P》

- P** Setting [WIDTH] to 0 will deactivate ABS.
- P** The amount of ABS applied by the servo is determined by the amount of throttle trigger movement as well as the [WIDTH] and [TRG.P] setting values. Using the throttle trigger position as a base and with [WIDTH] set at 100, the servo will return to the point set by [TRG.P]. If the [WIDTH] value is too small, the servo will not be able to return to the point set by [TRG.P].
- P** The smaller the [TRG.P] value, the more brake pumping the servo will apply.

《Regarding CYCLE》

- P** If [CYCLE] is set at a large value, the servo's operation frequency will increase.
- P** Setting a high value will increase the servo's power consumption and may also simultaneously shorten the lifespan of the servo.

《Regarding DELAY》

- P** During the time that is set by this function, the brakes will be applied strongly rather than the ABS.

《Regarding DUTY》

- P** [DUTY] is used to set the ABS brake application to release ratio to one of 9 steps.
DUTY Ratio = (A) Time that brake is applied : (B) Time that brake is released

《Regarding KEY》

- P** **Activate ABS While Driving!**
 If [WIDTH] is not set to OFF, pressing the assigned key during driving will activate/deactivate ABS.
- P** For electric cars, it may be easier to understand if the throttle channel is connected temporarily to the servo to check ABS operation instead of to the ESC.
- P** Actual ABS effectiveness may differ according to the servo used. Optimum settings will differ due to different torque and speed values.
- P** **[ABS] Display on the Function Monitor!**
 If [WIDTH] is not set to OFF, [ABS] will be displayed on the initial screen's function monitor. If the key assigned to ABS is pressed while at the initial screen, [ABS] will disappear from the function monitor.

▶ Throttle Acceleration (TH-Accel)

Just like professional drivers who are capable of precise throttle inputs, this function enables fine throttle adjustments to allow quicker cornering.

[Example]

By setting the throttle to feather automatically, the car could be made to grip and corner faster on low-grip surfaces.

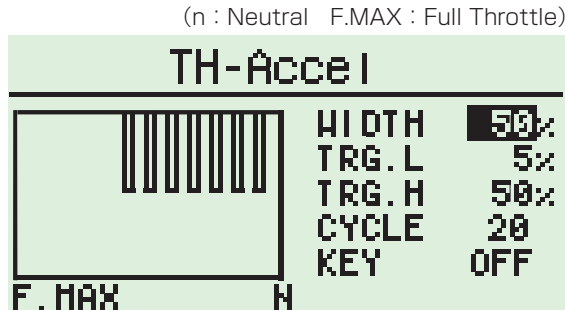

[Setting Range]

WIDTH : OFF, 1 - 100% (Default : OFF)

Sets the amount of throttle feathering.

TRG.L : 1 - 100% (Default : 5%)

Sets the function's starting position.

TRG.H : 1 - 100% (Default : 50%)

Sets the function's completion position.

CYCLE : 1 - 30 (Default : 28)

Sets the speed of the throttle feathering.

KEY : OFF, ET1 - 5, BT1 (Default : OFF)

Assigns a key to be used to activate/deactivate the Acceleration Function.

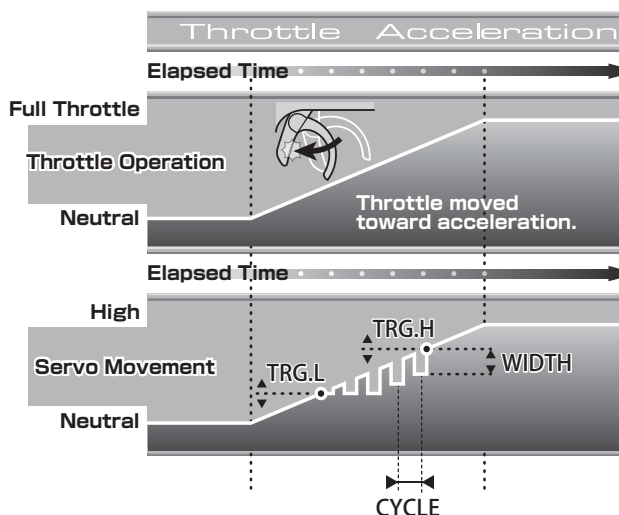

《Regarding WIDTH》

P Setting [WIDTH] to 0 will deactivate ABS.

《Regarding TRG.L and TRG.H》

P Throttle feathering will occur when the throttle trigger is moved to the positions set by [TRG.L] and [TRG.H].

P The function settings have the following relationship: [TRG.L ≤ TRG.H]. Thus the [TRG.L] value will always correct itself to be less than the [TRG.H] value.

《Regarding CYCLE》

P If [CYCLE] is set at a large value, the servo's operation frequency will increase.

P Setting a high value will increase the servo's power consumption and may also simultaneously shorten the lifespan of the servo.

《Regarding KEY》

P **Activate ACC While Driving!**

If [WIDTH] is not set to OFF, pressing the assigned key during driving will activate/deactivate ACC.

P **[ACC] Display on the Function Monitor!**

If [WIDTH] is not set to OFF, [ACC] will be displayed on the initial screen's function monitor. If the key assigned to ACC is pressed while at the initial screen, [ACC] will disappear from the function monitor.

! Take into account such factors as the servo used, car, driving surface, etc. when adjusting all settings. Conduct test drives to find the best setting values.

! Setting a large [CYCLE] or [WIDTH] value may increase the servo's power consumption and also shorten its lifespan.

▶ Throttle Auto-Start (TH-AutoStart)

This function sets the throttle output to a fixed level at startup, regardless of how much the throttle trigger is pulled.

[Example] Launching from the starting line.

TH-AutoStart	
KEY :	OFF
TRG.P :	5%
FORWARD :	OFF

[Setting Range]

KEY : OFF, ET1 - 5, BT1 (Default : OFF)

Assigns a key to be used to activate/deactivate the Auto-Start Function.

TRG.P : 5 - 100% (Default : 5%)

Sets the trigger position at which the function operates.

FORWARD : OFF - 100% (Default : OFF)

Sets the function's throttle position.

- P** The function will not operate until the throttle trigger reaches the set position.
- P** When the throttle is released, the function is deactivated and the throttle returns to normal operation.
- P** If the key assigned to Auto-Start is pressed, [AUT] will be displayed on the initial screen's function monitor. If this key is pressed while at the initial screen, [AUT] will disappear from the function monitor.
- !** Normally, full throttle is set for launching from the starting line. However, tire and surface conditions may mean full throttle will not be effective. Conduct tests and make adjustments

▶ Idle Up (IdleUp)

Used to offset the throttle's neutral position.

[Example]

Raising the idling has the effect of improving a glow engine car's launch performance. It is also useful for canceling the neutral brake of a motor with strong cogging and preventing engine stalls when glow engine cars enter the pit for refueling.

TH-IdleUp	
KEY :	OFF
BUTTON :	PUSH
C.TRIM :	OFF

[Setting Range]

KEY : OFF, ET1 - 5, BT1 (Default : OFF)

Assigns a key to be used to activate/deactivate the Idle Up Function.

BUTTON : TGLE, PUSH (Default : TGLE)

Sets the method of activation.

TGLE : If a key is assigned to Idle Up, press once to activate (2 beeps) and press again to deactivate (1 beep).

PUSH : It is only activated controls are operated and is deactivated when controls are released.

C.TRIM : OFF, 1 - 100 (Default : OFF)

Sets the amount of throttle neutral offset.

- P** Throttle can be operated even when Idle Up is activated. The high point and brake point do not change during this time.
- P** If the key assigned to Idle Up is pressed, [IUP] will be displayed on the initial screen's function monitor. If this key is pressed while at the initial screen, [IUP] will disappear from the function monitor.
- !** Please note that if the transmitter is switched on while Idle Up is activated, a malfunction could occur.
- !** Please note that a [C.TRIM] setting of 100 means full throttle.

3CH/4CH Menu (3/4ch Menu)

3Settings related to 3CH and 4CH operations.
(In order to operate 3CH and 4CH, the response function's OUTPUT setting must be changed from 2CH to 4CH.)

《Functions》

▶ 3CH Control Menu

Adjusts settings related to 3CH.

▶ 4CH control Menu

Adjusts settings related to 4CH.



P The functions which may be set are the same for both 3CH and 4CH. Set them to match the desired purpose.

Control Menu (Control Menu)

Various settings related to the use of channels 3 and 4 may be adjusted. You can select from 2WAY, 3WAY, 5WAY, ANALOG, 4WS MIX, AMP MIX, and T-MIX operations, which can be set in control mode according to the desired purpose.

《Functions》

▶ Control Mode

Set the usage choice for channels 3 and 4.
(select from 2/3/5WAY, ANALOG, 4WS/AMP/TH Mixing)

▶ 2WAY

Modify the 2-interval output settings.

▶ 3WAY

Modify the 3-interval output settings.

▶ 5WAY

Modify the 5-interval output settings.

▶ ANALOG

Modifies settings for analog (continuous) output.
(For example steering and throttle.)

▶ 4WS Mixing

Modify settings related to 4-wheel steering.

▶ AMP Mixing

Modify settings related to 4-wheel drive.

▶ T-Mixing

Modify independent settings for brake operation.

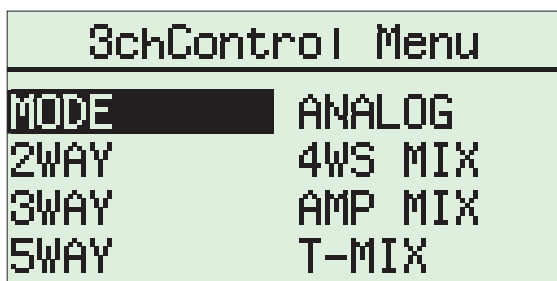

▶ Control Mode (Control Mode)

Set the usage choice for channels 3 and 4.

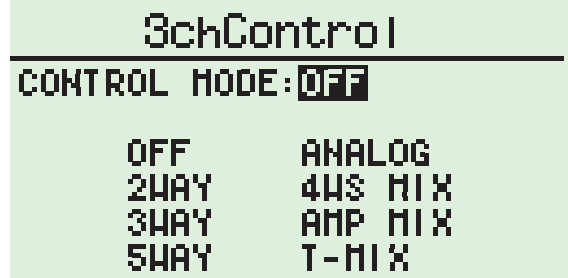

[Setting Range] (Default : OFF)

2WAY (Modify the 2-interval output settings.) ,

3WAY (Modify the 3-interval output settings.) ,

5WAY (Modify the 5-interval output settings.) ,

ANALOG (Modifies settings for continuous output.) ,

※ For example steering and throttle.

4WS-MIX (Modify settings related to 4-wheel steering.) ,

AMP-MIX (Modify settings related to 4-wheel drive.) ,

T-MIX (Modify independent settings for brake operation.)

▶ 2WAY (2WAY)

Modify the 2-interval output settings.

《Example》

May be used to activate/deactivate an engine starter unit or a semi-trailer's support legs.

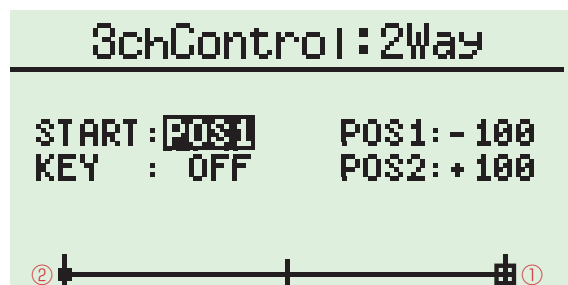

① START position (white square)

② Position aside from START (black square)

《Setting Range》

START : POS 1, POS 2 (Default : POS 1)

Sets the starting position.

KEY : OFF, ET1 - 5, BT1 (Default : OFF)

Assigns a key to use for switching positions.

POS 1 : -100 - 100% (Default : -100%)

Sets Position 1's output position.

POS 2 : -100 - 100% (Default : 100%)

Sets Position 2's output position.

▶ 3WAY (3WAY)

Modify the 3-interval output settings.

[Example]

May be used for gear changing operations or when you wish to set a 3-interval control scheme for the servo.



- ① START position (white square)
- ② Position aside from START (black square)

[Setting Range]

START : POS 1, POS 2, POS 3 (Default : POS 1)

Sets the starting position.

KEY : OFF, ET1 - 5, BT1 (Default : OFF)

Assigns a key to use for switching positions.

POS 1 : -100 - 100% (Default : -100%)

Sets Position 1's output position.

POS 2 : -100 - 100% (Default : 0%)

Sets Position 2's output position.

POS 3 : -100 - 100% (Default : 100%)

Sets Position 3's output position.

▶ 5WAY (5WAY)

Modify the 5-interval output settings.

[Example]

May be used for gear changing operations or when you wish to set a 5-interval control scheme for the servo.

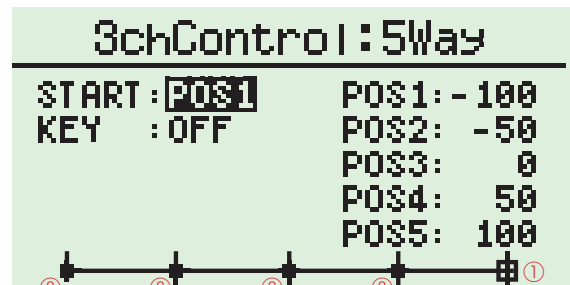

- ① START position (white square)
- ② Position aside from START (black square)

[Setting Range]

START : POS 1, POS 2, POS 3, POS 4, POS 5
(Default : POS 1)

Sets the starting position.

KEY : OFF, ET1 - 5, BT1 (Default : OFF)

Assigns a key to use for switching positions.

POS 1 : -100 - 100% (Default : -100%)

Sets Position 1's output position.

POS 2 : -100 - 100% (Default : -50%)

Sets Position 2's output position.

POS 3 : -100 - 100% (Default : 0%)

Sets Position 3's output position.

POS 4 : -100 - 100% (Default : 50%)

Sets Position 4's output position.

POS 5 : -100 - 100% (Default : 100%)

Sets Position 5's output position.

▶ ANALOG (ANALOG)

These settings are to enable continuous output for channels 3 or 4.

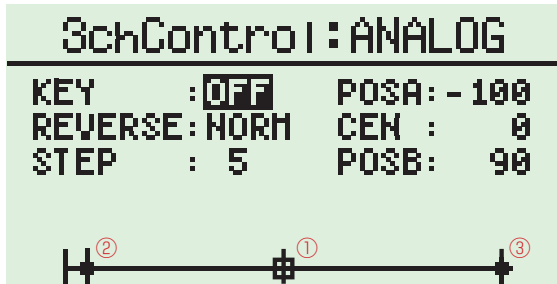

- ① CCEN Position (white square)
- ② LLOW Position (black square)
- ③ HHIGH Position (black square)

[Setting Range]

KEY : OFF, ET1 - 5, BT1 (Default : OFF)

Assigns a key to use for switching positions.

REVERSE : NOR (Normal) , REV (Reverse) (Default : NOR)

Sets operation direction.

STEP : 1 - 25 (Default : 5)

Sets the amount of change for the operation.

LOW (Low Position) : -100 - 0 (Default : -100)

Sets the lowest value for the operation range.

CEN (Center Position) : LOW - HIGH (Default : 0)

Sets the neutral position for the operation range.

HIGH (High Position) : 0 - 100 (Default : 100)

Sets the highest value for the operation range.

[How to Use Analog Settings]

Low Position Side :

Between LOW and CEN are 100 steps within which the intervals can be adjusted.

High Position Side :

Between CEN and HIGH are 100 steps within which the intervals can be adjusted.

Example) When STEP value is 2

When LOW side is set to 5 intervals.

When HIGH side is set to 4 intervals.

Movement Range
Interval Position

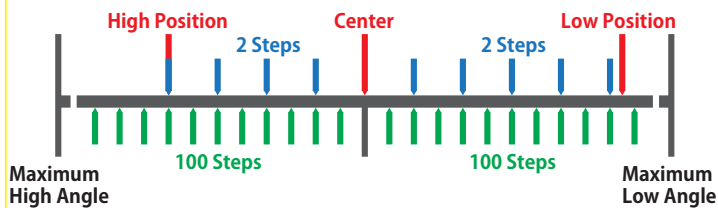

P Center position is the starting position.

P Low/High positions cannot be exceeded. Operations which try to do so will stop just before the Low/High positions.

▶ 4WS Mixing (4WSMix)

This function is related to an R/C car's 4-wheel steering feature. If 3CH or 4CH is assigned to control the rear axle, it will operate in conjunction with 1CH (steering). The direction of the rear axle steering may also be changed.

《Functions》

▶ 4WS Mixing Mode

Choose from four types of 4-wheel steering controls.

▶ 4WS Mixing Left

Modify the rear axle servo movement range when steering is turned to the left.

▶ 4WS Mixing Center

Modify the rear axle servo's neutral position when steering is at neutral.

▶ 4WS Mixing Right

Modify the rear axle servo movement range when steering is turned to the right.

▶ 4WS Steering Travel

Modify the movement range of the rear axle servo.

▶ 4WS Mixing Reverse

Modify the rear axle servo direction.

▶ 4WS Mixing Key

Assigns ET keys to be used for 4WS Mixing.

SchControl : 4WSMix	
Mode	Travel
Left	Reverse
Center	Key
Right	

▶▶ 4WS Mixing Left (4WSMix LEFT)

Adjusts the rear axle servo movement range when steering is turned to the left. Equivalent to (Balance L) in the [Steering Balance] function.

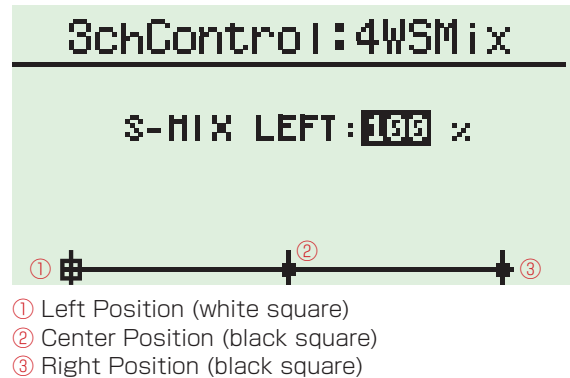

[Setting Range] 0 - 100% (Default : 70%)

- P** If the rear axle servo's direction has been reversed, use [4WS Mixing Reverse] to adjust.
- P** This setting percentage is a ratio against the movement angle setting in the [4WS Mixing Travel] function.
- P** If the 4WS Mixing trim is set to a large value, a large left/right value discrepancy may result. If adjusting 4WS Mixing Left for the first time, follow the procedures below.
 - ① Set 4WS Mixing trim value to 0.
 - ② Adjust 4WS Mixing trim so that the car drives in a straight line when steering is in neutral position.
 - ③ Use 4WS Mixing Travel to match the overall steering angle range.
 - ④ Use 4WS Mixing Left and 4WS Mixing Right to match the left/right turning radii.

▶▶ 4WS Mixing Mode (4WSMix MODE)

Choose from four types of 4-wheel steering controls.

SchControl : 4WSMix			
\$-MIX MODE SELECT			
NORMAL	↘	F STEER	↘
REVERSE	↙	R STEER	↙

[Setting Range] (Default : NORMAL)

NORMAL (front and rear axles turn in the same direction) ,
REVERSE (front and rear axles turn in opposite directions) ,
F STEER (steer front axle only) ,
R STEER (steer rear axle only)

- P** ET lever may be used for activation if is assigned to 4WS Mixing Mode.

▶▶ 4WS Mixing Center (4WSMix CENTER)

Adjust the rear axle servo's neutral position. Equivalent to the [Steering Sub Trim] function.

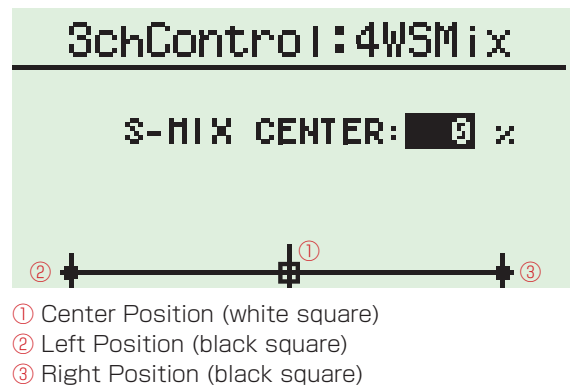

[Setting Range] -50 - 50% (Default : 0%)

- P** The setting range cannot exceed what is set by [4WS Mixing Travel] or [4WS Mixing Left] and [4WS Mixing Right].

▶▶4WS Mixing Right (4WSMix RIGHT)

Adjusts the rear axle servo movement range when steering is turned to the right.
Equivalent to (Balance R) in the [Steering Balance] function.

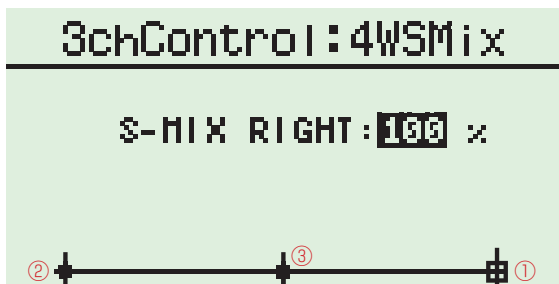

- ① Right Position (white square)
- ② Left Position (black square)
- ③ Center Position (black square)

[Setting Range] 0 - 100% (Default : 70%)

- P** If the rear axle servo's direction has been reversed, use [4WS Mixing Reverse] to adjust.
- P** This setting percentage is a ratio against the movement angle setting in the [4WS Mixing Travel] function.
- P** If the 4WS Mixing trim is set to a large value, a large left/right value discrepancy may result. If adjusting 4WS Mixing Right for the first time, follow the procedures below.
 - ① Set 4WS Mixing trim value to 0.
 - ② Adjust 4WS Mixing trim so that the car drives in a straight line when steering is in neutral position.
 - ③ Use 4WS Mixing Travel to match the overall steering angle range.
 - ④ Use 4WS Mixing Left and 4WS Mixing Right to match the left/right turning radii.

▶▶4WS Mixing Travel (4WSMix TRAVEL)

Adjusts the overall amount of movement of the rear axle servo when the steering is at full lock.

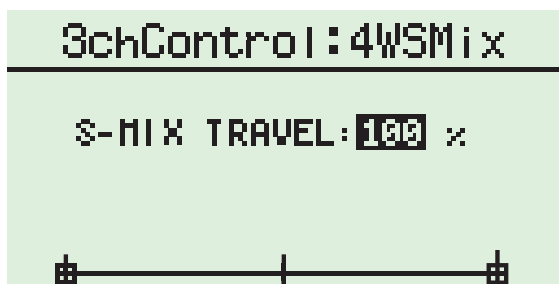

[Setting Range] 0 - 150% (Default : 100%)

- !** Steering will not operate if the 4WS Mixing Travel value is set to 0.

▶▶4WS Mixing Reverse (4WSMix REVERCE)

This function reverses the rear axle's movement direction.

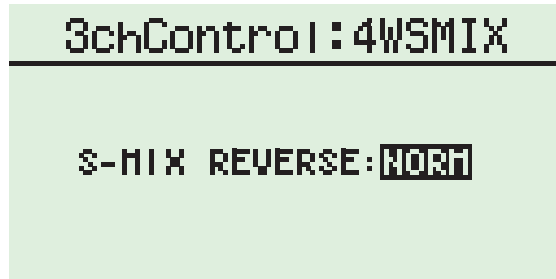

[Setting Range]

NOR (Normal) , REV (Reverse) (Default : NOR)

- !** Steering direction varies from car to car and should be checked when the R/C equipment has been installed.

▶▶4WS Mixing Key (4WSMix KEY)

Assigns ET keys to be used for 4WS Mixing.

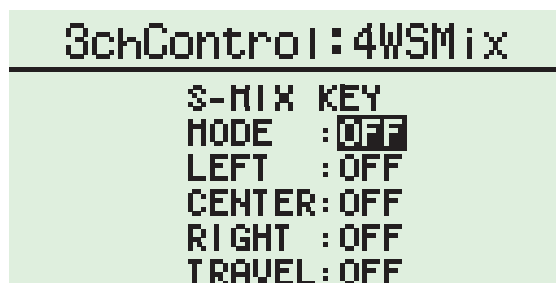

[Setting Range] (Default : OFF)

MODE (4WSMix MODE) : OFF, ET1 - 5
LEFT (4WSMix LEFT) : OFF, ET1 - 5
CENTER (4WSMix CENTER) : OFF, ET1 - 5
RIGHT (4WSMix RIGHT) : OFF, ET1 - 5
TRAVEL (4WSMix TRAVEL) : OFF, ET1 - 5

- P** ET keys may also be assigned via the [Setup] function in the System Menu.
- P** Convenient for when you need to adjust 4WS Mixing settings.

▶ Amp Mixing (AMP Mix)

Used when the front and rear wheels are controlled by separate ESCs and motors.

If 3CH or 4CH is set to the front-wheel drive function, it will operate in conjunction with 2CH's throttle operations.

《Functions》

▶ Amp Mixing Mode

Choose from five 4-wheel drive modes.

▶ Amp Mixing Throttle Hold

Set either the front or rear wheels to be driven at a certain speed.

※ For (F HOLD) and (R HOLD).

▶ Amp Mixing High Point

Modify the maximum amount of throttle to be applied to the front wheels.

▶ Amp Mixing Brake

Modify the maximum amount of reverse (brake) to be applied to the front wheels.

※ For (NORMAL).

▶ Amp Mixing Reverse

Modify the movement direction of the front wheels.

▶ Amp Mixing Trim

Modify the neutral position of the front wheels.

▶ Amp Mixing ET Mode Setting

Enables 4 wheel drive [Mode] to be changed via ET lever.

▶ Amp Mixing Key

Assigns an ET lever to be used for Amp Mixing.

SchControl : AMPMix

Mode	Revers
TH Hold	Trim
HiPoint	ETMode Set
Brake	Key

▶▶ Amp Mixing Mode (AMPMix MODE)

Choose from five 4-wheel drive modes.

SchControl : AMPMix

MODE SELECT

NORMAL	F HOLD
BURN	R HOLD
DIG	

《Setting Range》 (Default : OFF)

NORMAL (drives both front and rear wheels) ,

BURN (drives rear wheels only) ,

DIG (drives front wheels only) ,

F HOLD (drives front wheels at a set speed) ,

R HOLD (drives rear wheels at a set speed)

P ET lever may be used for activation if is assigned to Amp Mixing Mode.

▶▶ Amp Mixing Throttle Hold (AMPMix HOLD)

This function adjusts the set speed used for (F HOLD) and (R HOLD) selected in Amp Mixing Mode.

[F HOLD] adjusts the front wheel drive while [R HOLD] adjusts the rear wheel drive.

※This setting is activated when F HOLD or R HOLD mode is selected.

[Example] May be used for rock crawlers, etc.

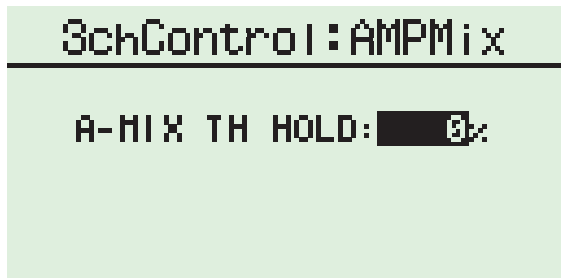

[Setting Range] -150 - 150% (Default : 0%)

! On glow engine cars, an overly high setting value or mistaking the +/- value will increase load on the servo and lead to it being damaged. Check carefully while adjusting.

! On electric cars, a setting value that is too small may cause problems with the ESC settings. Make adjustments starting from the default setting (100).

▶▶ Amp Mixing High Point (AMPMix HIPOINT)

Adjusts the maximum amount of throttle to be applied to the front wheels.

Equivalent to the [Throttle High Point] function.

※This setting is activated when NORMAL, DIG, or R HOLD mode is selected.

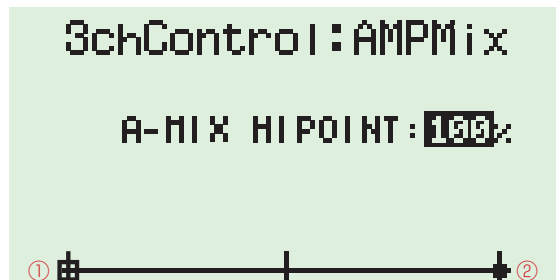

① High Point Position (white square)

② Brake Position (black square)

[Setting Range] 0 - 150% (Default : 100%)

P This makes it easy to adjust the amount of maximum throttle, particularly on a glow engine car.

P If the amp mixing high point is set low and the amp mixing trim is set to a high value toward acceleration, the resulting throttle movement may be extraordinarily small.

! On glow engine cars, an overly high setting value will increase load on the servo and lead to it being damaged. Check carefully while adjusting.

! On electric cars, a setting value that is too small may cause problems with the ESC settings. Make adjustments starting from the default setting (100).

! Brake will not operate if the value is set to 0.

▶▶ Amp Mixing Brake (AMPMix BRAKE)

Modify the maximum amount of reverse (brake) to be applied to the front wheels.

Equivalent to [Throttle Brake] function.

※This setting is activated when NORMAL, DIG, or R HOLD mode is selected.

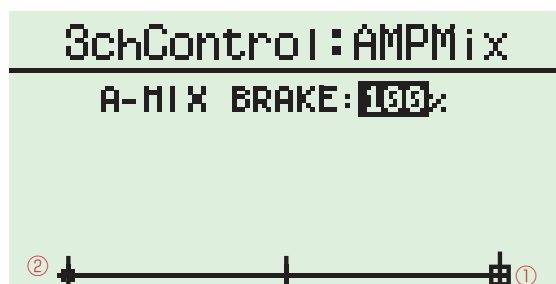

① Brake Position (white square)

② High Point Position (black square)

[Setting Range] 0 - 150% (Default : 100%)

! On glow engine cars, an overly high setting value will increase load on the servo and lead to it being damaged. Check carefully while adjusting.

! On electric cars, a setting value that is too small may cause problems with the ESC settings. Make adjustments starting from the default setting (100).

! Brake will not operate if the value is set to 0.

▶▶Amp Mixing Reverse (AMPMix REVERSE)

Changes the movement direction of the front wheels.

```
3chControl : AMPMix
```

```
A-MIX REVERSE : NOR
```

[Setting Range]

NOR (Normal) , REV (Reverse) (Default : NOR)

P For electric cars, the throttle is set by the ESC so there is no need to set this function. However, some older ESCs will not function properly unless reverse is also set.

▶▶Amp Mixing Trim (AMPMix TRIM)

Adjusts the neutral position of the front wheels.

```
3chControl : AMPMix
```

```
A-MIX TRIM : 0
```

[Setting Range] -50 - 50% (Default : 0%)

P The setting position cannot exceed what is set by [High Point] or [Brake].

▶▶Amp Mixing ET Mode Setting (AMPMix ET MODE SET)

Assigns ET or BT keys to activate the various front wheel drive modes.

```
3chControl : AMPMix
```

```
A-MIX ETMODE SET  
NORMAL : ON  
BURN : ON  
DIG : ON  
F HOLD : ON  
R HOLD : ON
```

[Setting Range] (Default : OFF)

NORMAL : ON, OFF

BURN : ON, OFF

DIG : ON, OFF

F HOLD : ON, OFF

R HOLD : ON, OFF

P Assigning these keys may be convenient for rock crawlers or when you need to adjust Amp Mixing settings.

▶▶Amp Mixing Key (AMPMix KEY)

Assigns ET or BT keys to be used for Amp Mixing.

```
3chControl : AMPMix
```

```
A-MIX KEY  
MODE : OFF  
TH HOLD : OFF
```

[Setting Range] (Default : OFF)

MODE (AMPMix MODE) : OFF, ET1 - 5, BT1

TH HOLD (AMPMix Throttle Hold) : OFF, ET1 - 5, BT1

P Convenient for when you need to adjust Amp Mixing settings. It is also convenient if you are using [MODE] or [TH HOLD] functions.

▶ Throttle Mixing (T-Mix)

Mainly used for 1/5 scale R/C cars where the left/right front wheels' braking operation is controlled by an independent servo.

If 3CH is assigned to front right wheel brake and 4CH is assigned to front left wheel brake, they will operate in conjunction with 2CH (throttle) and 1CH (steering).

[Example] Simplifies adjustment of the independent brake channel (servo) on 1/5 scale R/C cars.

《Functions》

▶ Throttle Mixing Brake

Modify the maximum amount of front brake servo movement.

▶ Throttle Mixing Center

Modify the front brake servo's neutral position.

▶ Throttle Mixing High Point

Modify the maximum amount of throttle to be applied to the front brake servo.

※ To avoid operating only the brakes, set value to 0.

▶ Throttle Mixing Reverse

Modify the front wheel brake servo's movement direction.

▶ Throttle Mixing Curve

Modify the front wheel brake servo's movement speed ratio.

▶ Throttle Mixing Delay

Delays the operation of the front wheel servo brake.

▶ Throttle Mixing Steering

Modify the amount of brake applied by the front wheel brake servo in relation to steering input.

▶ Throttle Mixing On/Off

Enables Throttle Mixing to be activated via ET keys.

▶ Throttle Mixing Key

Assigns ET keys to be used for Throttle Mixing.

SchControl:T-Mix ▶	
Brake	Curve
Center	Delay
HiPoint	Steer
Reverse	On/Off

▶▶ Throttle Mixing Brake (T-Mix BRAKE)

Adjusts the maximum amount of front brake servo movement.

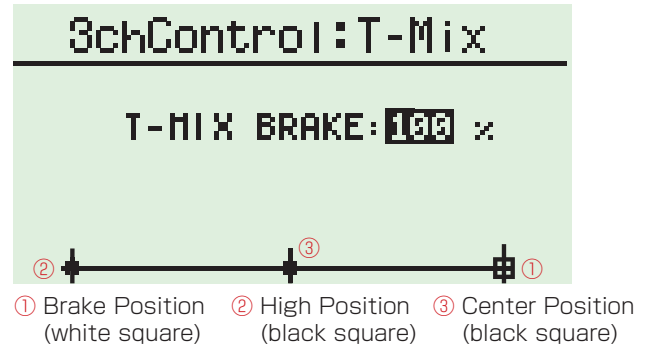

[Setting Range] 0 - 150% (Default : 100%)

P Please begin with the same value set for front right brake (3CH) and the front left brake (4CH). If the car's becomes unbalanced during full braking, then there is a discrepancy between the left and right which should be corrected.

P An overly high setting value will increase load on the servo and lead to it being damaged. Check carefully while adjusting.

! Forward movement will be inoperable if the value is set to 0.

▶▶ Throttle Mixing Center (T-Mix CENTER)

Modify the front brake servo's neutral position.



[Setting Range] -80 - 80% (Default : 0%)

P The points at which the front right brake (3CH) and front left brake (4CH) begin to operate is vital. If these are not adjusted, the car will become unbalanced under braking.

P The setting position cannot exceed what is set by [High Point] or [Brake].

▶▶Throttle Mixing High Point (T-Mix HIPOINT)

Adjust the maximum amount of throttle to be applied to the front brake servo.
If 3CH and 4CH are assigned to the brake servo, the value will be set to 0.



① High Position (white square) ② Center Position (black square) ③ Brake Position (black square)

[Setting Range] 0 - 150% (Default : 100%)

- P** An overly high setting value will increase load on the servo and lead to it being damaged. Check carefully while adjusting.
- P** The amount of movement may become very small if the throttle high point is set to a low value and if the throttle mixing center is set to a high value toward forward acceleration.
- !** Forward movement will be inoperable if the value is set to 0.

▶▶Throttle Mixing Reverse (T-Mix REVERSE)

This function reverses the front brake servo's movement direction. It is useful for when servo output movement does not match inputs after the servo has been installed.

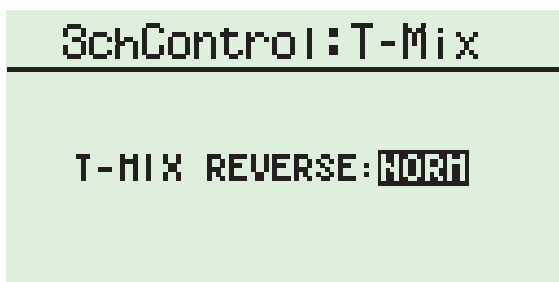

[Setting Range]

NOR (Normal) , REV (Reverse) (Default : NOR)

- !** An incorrect brake servo movement direction will increase load on the servo and lead to it being damaged. Check carefully while adjusting.

▶▶Throttle Mixing Curve (T-Mix CURVE)

This function sets the signal conversion rate to a curve to enable quicker or milder response.

(N : Neutral F : Forward B : Brake)

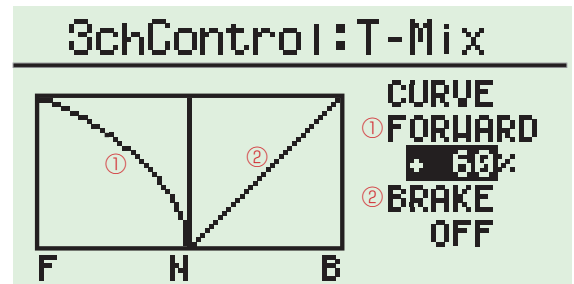

[Setting Range] (Default : 0%)

- ① FORWARD : -100 - 100%
- ② BRAKE : -100 - 100%

- P** Positive values (+1 to +100) equal high initial response followed by mild response. Negative values (-1 to -100) equal a mild initial response followed by high response.

▶▶Throttle Mixing Delay (T-Mix DELAY)

Delays the operation of the front wheel servo brake.



[Setting Range] OFF, 1 - 100% (Default : OFF)

- P** This delay comes into effect when the signal first begins to enter the brake range and is deactivated thereafter.
- P** If the front brakes operate quickly, the car may spin or lose its balance. In this case applying throttle mixing delay can be effective.

▶▶Throttle Mixing Steering (T-Mix STEER)

Full braking can be weakened or made even stronger in accordance with steering input.

[Example]

When a 1/5 scale R/C car is driven for a long duration, loss of front tire grip would lead to understeer. Throttle Mixing Steering can be used to apply stronger braking in this case. Use this function in conjunction with Throttle Mixing On/Off.



[Setting Range] -100 - 100% (Default : 0)

P The same effect can be obtained regardless of which direction the steering is turned in.

! Use of Throttle Mixing Steering may increase load on the servo and cause increased wear or damage. Check the servo while adjusting.

▶▶Throttle Mixing On/Off (T-Mix ON/OFF)

Enables Throttle Mixing to be activated/deactivated.

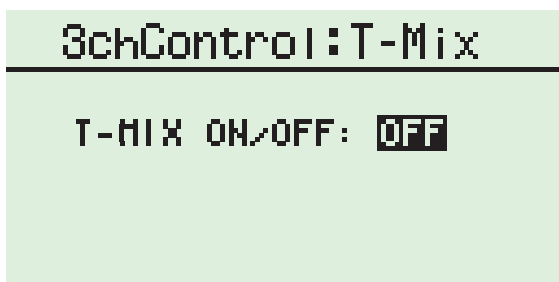

[Setting Range] ON, OFF (Default : OFF)

P Convenient for when you wish to activate/deactivate front wheel braking according to the corner.

P Useful for driving at the circuit as well as checking settings.

▶▶Throttle Mixing Key (T-Mix KEY)

Assigns ET keys to be used for Throttle Mixing.

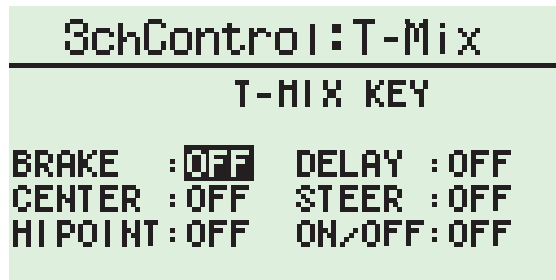

[Setting Range] (Default : OFF)

BRAKE (T-Mix BRAKE) : OFF, ET1 - 5

CENTER (T-Mix CENTER) : OFF, ET1 - 5

HIPOINT (T-Mix HIPOINT) : OFF, ET1 - 5

DELAY (T-Mix DELAY) : OFF, ET1 - 5

STEER (T-Mix STEER) : OFF, ET1 - 5

ON/OFF (T-Mix ON/OFF) : OFF, ET1 - 5

P These keys may also be assigned with [SETUP].

P Convenient for when you need to adjust Throttle Mixing settings. It is also convenient if you are using [DELAY], [STEER], or [ON/OFF] functions.

! These keys must be set for both front right brake (3CH) and front left brake (4CH).

Quick Setup (QuickSetup)



By following the menu in order, this function enables creation of a basic initial setup.

[Example]

Useful for setting up a car for the first time. It is recommended for users to use quick setup first, then make fine adjustments to match the driving conditions.

《Functions》

- ① **ST REVERCE** (p.23)
Modify the steering direction.
(※ Not required for ESCs.)
- ② **ST SUBTRIM** (p.20)
Modify the steering's neutral position.
- ③ **ST TRIM** (p.19)
Modify the center point of the steering angle range.
- ④ **ST TRAVEL** (p.19)
Modify the maximum amount of steering movement.
- ⑤ **ST BALANCE** (p.20)
Modify the left/right turning radii.
- ⑥ **TH SUBTRIM** (p.25)
Modify the throttle's neutral position.
(※ Not required for ESCs.)
- ⑦ **TH TRIM** (p.24)
Modify the center point of the throttle movement range.
- ⑧ **TH HIPOINT** (p.24)
Modify the maximum amount of throttle forward movement.
(※ Not required for ESCs.)
- ⑨ **TH BRAKE** (p.25)
Modify the maximum amount of throttle brake movement.
(※ Not required for ESCs.)

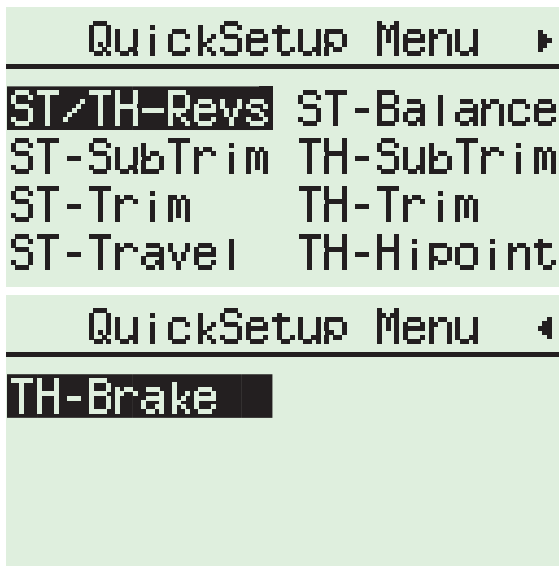

- P** This menu is a shortcut to the various setting functions and the explanations for those functions are the same. Refer to the section for each function for their respective detailed explanations.

Timer Menu (Timer Menu)



Operating Timer-related functions.

《Functions》

▶ Stopwatch

This may be used to keep track of elapsed time. It also has a lap navigation function.

▶ Countdown Timer

A timer which counts down the time.

▶ Lap History

Displays the lap times recorded by the stopwatch.



▶ Stopwatch (StopWatch)

Lap times may be recorded by setting a recording point, then pressing a button when the car passes through that point.

It also features a lap navigation function.

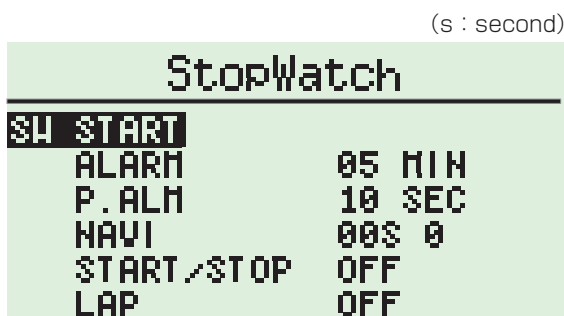

After inputting the various settings, select [SW START] (hold the ENTER key) to enable the stopwatch function. (Basic Operation p.14)

【Setting Range】 *MIN (minute) SEC (second)

SW START

Prepares the stopwatch for activation via the START key or throttle movement.

ALARM : 1 MIN - 99 MIN (Default : 5 MIN)

Alarm will sound after the set amount of time has elapsed.

*Convenient for setting the anticipated race completion time.

P.AL M : 0 - 30 SEC (Default : 0 SEC)

Sets a warning buzzer to sound at a set time prior to the alarm.

*Convenient for setting a warning for when a race is about to end.

NAVI : 0 - 59.9 SEC (Default : 0 SEC)

Adjusts the lap navigation settings.

*Convenient for setting a target lap.

START/STOP : OFF, ET1 - 5, BT1 (Default : OFF)

Assigns a key to activate/deactivate the stopwatch. (Required)

LAP : OFF, ET1~5, BT1 (Default : OFF)

Assigns a lap key.

【How to Use the Various Alarms】

Alarm Setting
Warning Buzzer Setting
Navigation Setting

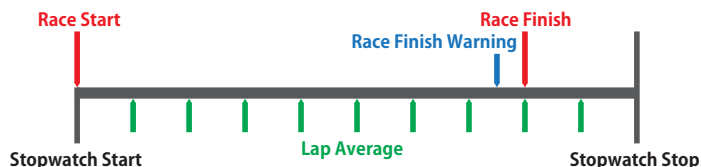

【How to Start Stopwatch】

① Set the stopwatch settings.

*Settings aside from switching [START/STOP] to OFF are required.

② Move the cursor to [SW START] and press the ENTER key. SW START will switch to READY for a brief moment before returning to the initial screen.

③ Start the stopwatch via throttle operation or pressing the [START/STOP] key.

*Other settings may be adjusted during the time between the initial screen is displayed and starting the stopwatch.

④ Timer starts when stopwatch is started.

*Until the stopwatch is stopped it is not possible to switch to another display screen. However, if ET or BT keys are assigned, they can still be operated.

(m : minute s : second)

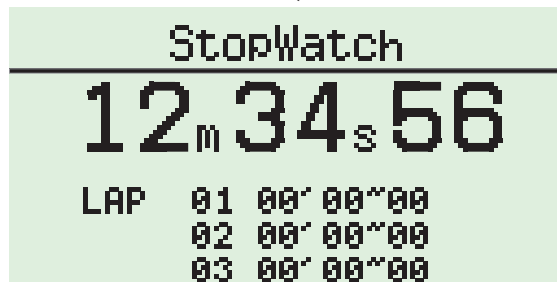

⚠ Assigning a [START/STOP] Key is Required!

A [START/STOP] key is required in order to use the stopwatch function. If operation does not start when SW START is pressed, check whether the [START/STOP] key has been assigned. Go to the initial screen and check if [TIM] is displayed.

【How to Stop Stopwatch】

① Pressing the key assigned to [SW START] will stop the stopwatch. If lap key is pressed while stopwatch is in use, the lap history record may be viewed.

P Up to 100 lap times may be stored. Laps will continue being recorded consecutively until being reset.

P The [NAVI] alarm will sound when the set time is exceeded. This is convenient for knowing the target time while driving.

P If the stopwatch is stopped by pressing the stop key, pressing it again will restart the timer.

P [Lap History] may be used to check the recorded laps.

P If a [START/STOP] key is assigned, [TIM] will display on the initial screen. If it is not assigned, [TIM] will not appear.

▶ Countdown Timer (DownTimer)

A timer which counts down from a set time.

【Example】

Useful to tracking the refueling timing for a glow engine car.

(m : minutes s : seconds)



【Setting Range】

※ MIN[minutes] SEC[seconds]

ALARM : 1 MIN - 99 MIN 59 SEC (Default : 5 MIN)

The time from which the countdown timer will start.

P.AL.M : 0 - 59 SEC (Default : 0 SEC)

Sets a warning buzzer to sound at a set time before countdown timer ends.

START/STOP : OFF, ET1 - 5, BT1 (Default : OFF)

Assigns a key to activate/deactivate the countdown timer.

【How to Use the Various Alarms】

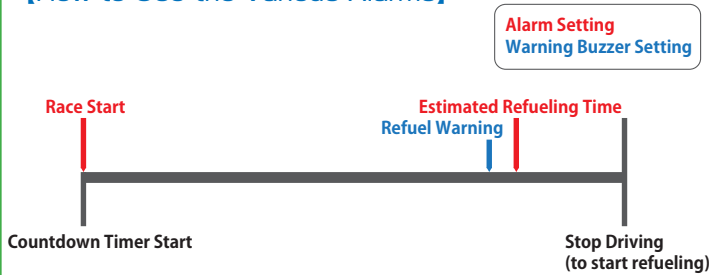

P A warning buzzer may be set to sound prior to the alarm sounding.

P If a [START/STOP] key is assigned, [TIM] will display on the initial screen. If it is not assigned, [TIM] will not appear.

! Assigning a [START/STOP] Key is Required!

A [START/STOP] key is required in order to use the countdown timer function. Go to the initial screen and check if [TIM] is displayed.

▶ Lap History (LapHistory)

Displays the lap times recorded by the stopwatch.

(TTL : Total Time)

LapHistory	
001	00' 26"57 ⁺
002	00' 20"51
003	01' 10"05
004	00' 40"20
005	02' 10"77
006	00' 50"22 _.

Use the jog dial to scroll. ([Basic Operation p.14](#))

P Up to 6 lap times can be displayed at one time. Scrolling to the end will display the total time.

! Only the last recorded lap times may be checked and previously recorded results will not be saved. (Even if the transmitter is switched off, the last recorded times will remain in the memory.)

Function Menu (Function Menu)

Menu related to various function settings.

《Functions》

▶ Monitor

Display the operations of each channel as a graphical representation.

▶ LED Color

Select the color of the transmitter's logo LED backlight.

▶ LCD Backlight

Set the backlight mode of the LCD. (ON, OFF, Automatic)

▶ LCD Contrast

Adjust the contrast of the LCD.

▶ Sound Volume

Adjust the volume of the transmitter buzzer.

▶ Buzzer

Set the transmitter buzzer type.

▶ Key Repeat

Set the operation speed of the ET/BT keys.

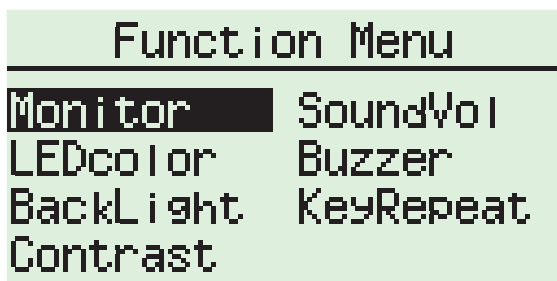

▶ LED Color (LEDcolor)

Select the color of the backlight for the EX-1 logo on the Master Unit. Choose to set it at one of seven colors, or disable it altogether.



 Select the desired choice. (Basic Operation p.14)

[Setting Range] (Default : OFF)

RED, GREEN, BLUE, YELLOW, PURPLE, LIGHTBLUE, WHITE, OFF

P The LED color may be set for each model.

! Disable the LED if you wish to conserve battery power.

▶ LCD Backlight (BackLight)

Set the backlight mode of the LCD.

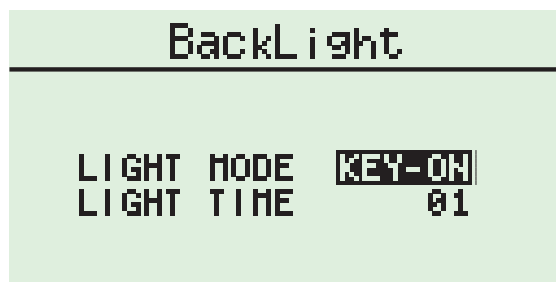

[Setting Range]

LIGHT MODE : KEY-ON, ON, OFF (Default : OFF)

Sets the light activation mode.

LIGHT TIME : 1- 60 (Default : 3)

Sets the time between a key operation (other than steering or throttle) and the LCD turning off when [LIGHT MODE] is set to [KEY-ON].

! When the backlight is set to [KEY-ON], it will only be activated by ET/BT key operation, not by steering or trigger operation.

▶ Monitor (Monitor)

Displays the operations of 1CH to 4CH graphically. This may be used to confirm the position or speed of the various settings.

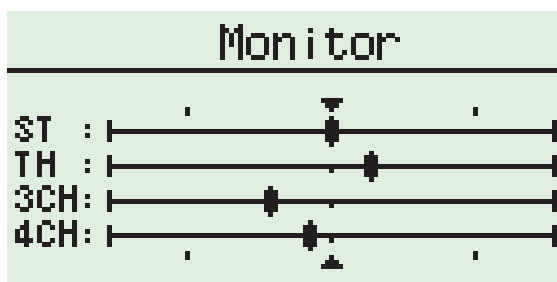

! This function is just a reference to quickly confirm the various signals. Final confirmation should be done via actual servo and ESC operation.

▶ LCD Contrast (Contrast)

Adjusts the contrast of the LCD.

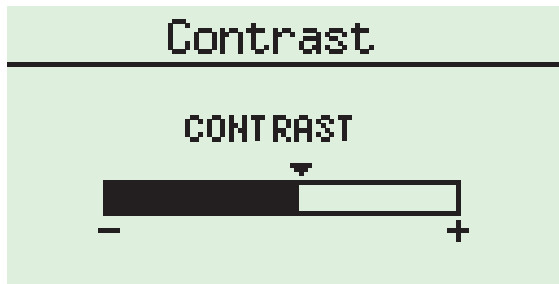

 Adjust the slide bar. (Basic Operation p.14)

[Setting Range] 5 intervals (Default : 3)

P LCD contrast will characteristically be darker when warm and lighter when cold. Make corresponding contrast adjustments if this is a concern for you.

▶ Buzzer (Buzzer)

Sets the transmitter buzzer type.

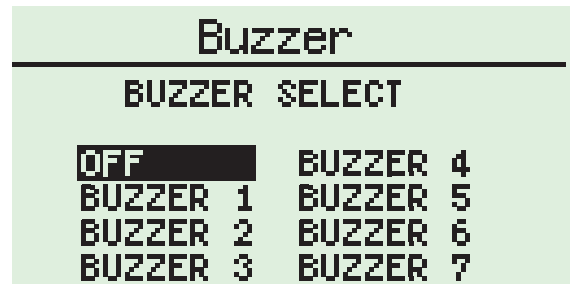

 Select the desired choice. (Basic Operation p.14)

[Setting Range] OFF, 7 types (Default : 1)

▶ Sound Volume (SoundVol)

Adjusts the sound level of the transmitter buzzer.



 Adjust the slide bar. (Basic Operation p.14)

[Setting Range] 3 intervals (Default : 2)

▶ Key Repeat (KeyRepeat)

Adjusts the delay between operations if the ET/BT key is pressed repeatedly.



 Adjust the slide bar. (Basic Operation p.14)

[Setting Range] 6 intervals (Default : 3)

- 0 : Key Repeat Disabled
- 1 : 1 second (decreases to 0.5 seconds after 5 presses)
- 2 : 0.8 seconds (decreases to 0.4 seconds after 5 presses)
- 3 : 0.6 seconds (decreases to 0.3 seconds after 5 presses)
- 4 : 0.3 seconds (decreases to 0.1 seconds after 5 presses)
- 5 : 0.1 seconds

P Sliding the bar towards + will shorten the delay time.

System Menu (System Menu)



Menu related to various system settings.

《Functions》

▶ Response

Select a response mode according to the equipment installed or driving conditions.

▶ Setup

Assign a key (ET1 – ET5, BT1) to a function.

▶ Direct Switch

Assign a direction button (DBT1 – DBT4) to a function.

▶ Adjust VR (ST)

Adjust the potentiometer of the steering.

▶ Adjust VR (TH)

Adjust the potentiometer of the throttle.

▶ Operation Timer

Display the transmitter operation time.

▶ 2.4G Band

Use to conduct pairing or select FRANCE mode.

▶ Power Management

Select the type of battery used.

▶ All Reset

Reset the transmitter to default factory settings.

▶ ICS

Connect transmitter with ICS.

▶ Approval

Displays overseas product approvals.

※ Not related to settings.

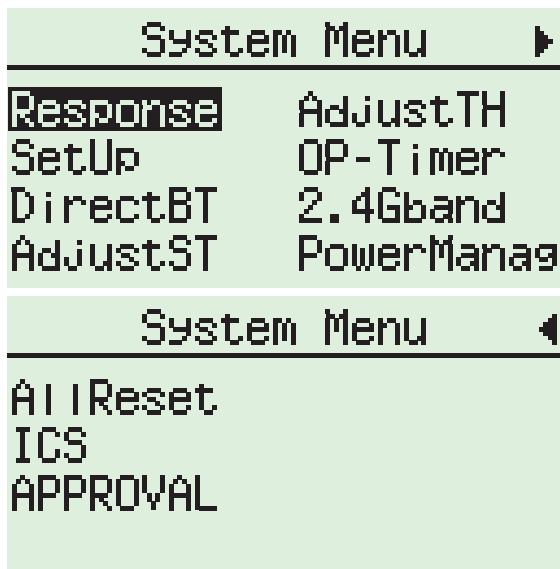

▶ Response (Response)

Select the response mode to match your servo, ESC, etc. It may also be used to adjust cornering response, etc.

※Please refer to the KO Propo website for a list of compatible products. (<http://www.kopropropo.co.jp>)

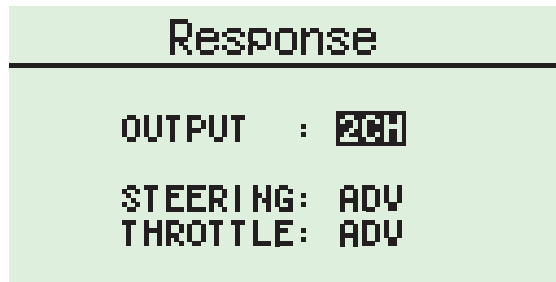

【Setting Range】

OUTPUT : 2CH, 4CH (Default : 2CH)

Sets the output channel.

STEERING : ADV, HSPD, NORM (Default : ADV)

Sets the steering response.

THROTTLE : ADV, HSPD, NORM (Default : ADV)

Sets the throttle response.

► Setup (Setup)

Assign a key (ET1- ET5, BT1) to a function.

Setup	
ET1: S:TRIM	OFF
ET2: T:TRIM	S:TRIM
ET3: T: BRAKE	S:TRAVEL
ET4: S:TRAVEL	S: BALANCE
ET5: OFF	S: SUBTRIM
BT1: OFF	S: TRVLOR

[Setting Range] ○ : Assignment Possible

ET1 ~ 5	ET1 ~ 3	ET4	ET5	BT1
OFF (No Assignment)	○	○	○	○
S:TRIM (Steering Trim)	○	○	○	-
S:TRAVEL (Steering Travel)	○	○	○	-
S:TRVLOR (Travel Override)	○	○	○	-
T:TRIM (Throttle Trim)	○	○	○	-
T:HIPOINT (Throttle High Point)	○	○	○	-
T:BRAKE (Throttle Brake)	○	○	○	-
T:DRAGB (Throttle Drag Brake)	○	○	○	○
T:BRAKEOR (Throttle Override)	○	○	○	○
T:ABS (Throttle ABS)	○	○	○	○
T:ACCEL (Throttle Acceleration)	○	○	○	○
T:AUTOST (Throttle Auto-Start)	○	○	○	○
T:IDLEUP (Throttle Idle Up)	○	-	○	○
STOPWATCH (Stopwatch)	○	○	○	○
LAPTIME (Lap Time)	○	○	○	○
DOWNTIME (Countdown Timer)	○	○	○	○
3:POS (3CH/Control)	○	○	○	-
3:SMODE (3CH/4WS Mixing Mode)	○	○	○	-
3:SMCENT (3CH/4WS Mixing Center)	○	○	○	-
3:SMTRVL (3CH/4WS Mixing Travel)	○	○	○	-
3:AMMODE (3CH/Amp Mixing Mode)	○	-	○	○
3:AMTH (3CH/Amp Mixing Throttle Hold)	○	○	○	-
3:TM BRAKE (3CH/Throttle Mixing Brake)	○	○	○	-
3:TMCENT (3CH/Throttle Mixing Center)	○	○	○	-
3:TMHIPO (3CH/Throttle Mixing High Point)	○	○	○	-
3:TMDELAY (3CH/Throttle Mixing Delay)	○	○	○	-
3:TMSTEER (3CH/Throttle Mixing Steering)	○	○	○	-
3:TMON (3CH/Throttle Mixing ON/OFF)	○	○	○	-
4:POS (4CH/Control)	○	○	○	-
4:SMODE (4CH/4WS Mixing Mode)	○	○	○	-
4:SMCENT (4CH/4WS Mixing Center)	○	○	○	-
4:SMTRVL (4CH/4WS Mixing Travel)	○	○	○	-
4:AMMODE (4CH/Amp Mixing Mode)	○	-	○	-
4:AMTH (4CH/Amp Mixing Throttle Hold)	○	○	○	-
4:TM BRAKE (4CH/Throttle Mixing Brake)	○	○	○	-
4:TMCENT (4CH/Throttle Mixing Center)	○	○	○	-
4:TMHIPO (4CH/Throttle Mixing High Point)	○	○	○	-
4:TMDELAY (4CH/Throttle Mixing Delay)	○	○	○	-
4:TMSTEER (4CH/Throttle Mixing Steering)	○	○	○	-
4:TMON (4CH/Throttle Mixing ON/OFF)	○	○	○	-

Default

ET1 (S:TRIM) ET2 (T:TRIM) ET3 (T: BREAK)
ET4 (S:TRAVEL) ET5 (OFF) BT1 (OFF)

► Direct Switch (DirectBT)

Assign a direction button (DBT1-DBT4) to a function to serve as a shortcut button. The default assignments may be customized.

DirectBT	
DBT1: MONIT	OFF
DBT2: TIM.H	MAIN MANU
DBT3: FUN.H	MODEL.H
DBT4: SYS.H	STEERING.H
	THROTTLE.H
	QUICK.SET

[Setting Range] OFF (No Assignment)
MAIN MENU (Main Menu)
MODEL.M (Model Menu)
STEERING.M (Steering Menu)
THROTTLE.M (Throttle Menu)
QUICK.SET (Quick Setup)
3CH.C (3CH Control Menu)
4CH.C (4CH Control Menu)
TIMER.M (Timer Menu)
FUNCTION.M (Function Menu)
SYSTEM.M (System Menu)
MONITOR (Monitor)
STOPWATCH (Stopwatch)
DOWNTIMER (Countdown Timer)
LAP.HIS (Lap History)

► Adjust VR (ST) (SteeringAdjustVR)

Adjust the steering steering resistance to offset wear during use.

AdjustST	
ST-LEFT	3861
ST-NUT	2213
ST-RIGHT	523

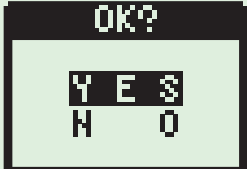

 Numbers will change as the steering is turned slowly to full left and right lock. Release the wheel, then select YES (press and hold ENTER) to adjust or NO to cancel and return to the menu. ([Basic Operation p.14](#))

 Do not operate steering wheel while pressing ENTER, as this may change the data values and affect subsequent operations. If this function is not adjusted properly, improper operation may result.

 VR Adjust timing may vary depending on usage. If problems persist even after using VR Adjust, contact KO Propo Customer Service Department to arrange repairs. (We recommend that you contact KO Propo Customer Service Department if you are not sure what the problem is.)

▶ Adjust VR (TH) (ThrottleAdjustVR)

Adjust the throttle resistance to offset wear during use.

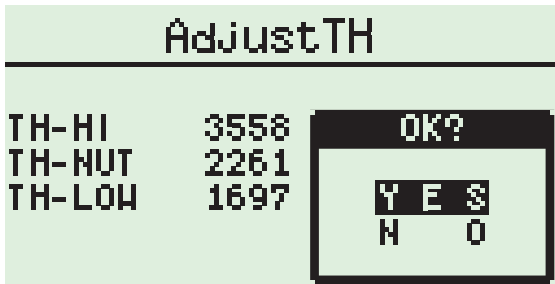

 Numbers will change as the throttle trigger is moved slowly to full forward and reverse positions. Release the trigger, then select YES (press and hold ENTER) to adjust or NO to cancel and return to the menu. (Basic Operation p.14)

 Do not operate throttle trigger while pressing ENTER, as this may change the data values and affect subsequent operations. If this function is not adjusted properly, improper operation may result.

 VR Adjust timing may vary depending on usage. If problems persist even after using VR Adjust, contact KO Propo Customer Service Department to arrange repairs. (We recommend that you contact KO Propo Customer Service Department if you are not sure what the problem is.)

▶ Operation Timer (OP-Timer)

Display the transmitter operation time.

[Example]

Use to check the battery replacement time or time until maintenance is required.



[Display Explanation]

USER TIMER DISPLAY

Timer which shows how long the transmitter has been in use by the user.

ELAPSED TIMER DISPLAY

Timer which shows total time the transmitter has been in use since shipment from the factory.

 Clear the User Timer by pressing and holding the ENTER key. (Basic Operation p.14)

 ALL RESET can also be used to clear User Timer.

 ELAPSED TIMER cannot be cleared. However, there may be instances such as damage or repairs which require it to be cleared.

▶ 2.4G Band (2.4GBand)

Use to conduct pairing or select FRANCE mode.

This product uses the FHSS transmission system, which switches between frequencies in the 2.4GHz range at a high speed. In order to increase usability with other transmitters, FRANCE Mode and GENERAL Mode are available. Select according to driving conditions.

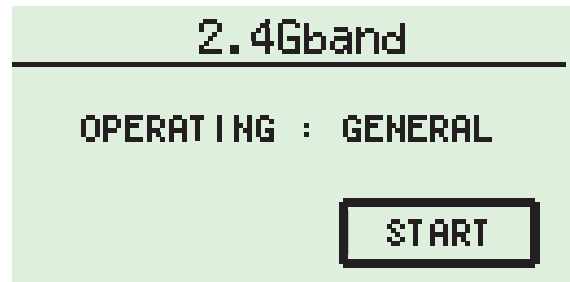

 Select the mode, then select [START] (press and hold ENTER key) to confirm or begin pairing process. (Basic Operation p.14)

See p.11 for pairing procedure details.

[Setting Range] (Default : GENERAL)

GENERAL (Normal Mode) , FRANCE (France Mode)

Pairing is Required!

If the mode is changed, please conduct pairing procedures with the ESC you are using again.

⟨Pairing Status⟩



Press ENTER key after pairing has completed to return to the menu.

► Power Management (POWER MANAGEMENT)

Select the type of battery used.

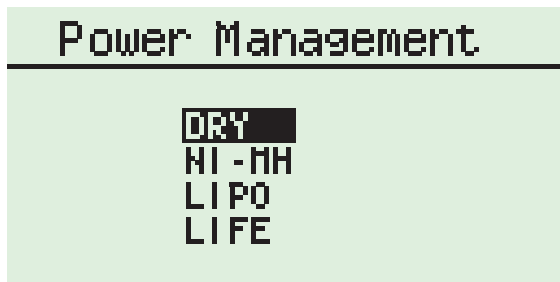

Select the appropriate choice. (Basic Operation p.14)

[Setting Range]

DRY (Alkaline Batteries) , NI-MH (Ni-MH Battery) ,
LIPO (Li-Po Battery) , LIFE (Li-Fe Battery)

P According to the selected power source type, a low voltage warning will be displayed. Transmitter signals will not be cut at this time, but problems with control may be experienced. Stop operation immediately and replace batteries.

! **Change Power Management After Switching Battery Type!**
If the battery used does not match the Power Management setting, the battery may be over-discharged and damaged. This may also result in fire, so make sure you pay special attention.

► All Reset (AllReset)

Delete all model data, function settings, system settings, etc. and reset the transmitter to default factory settings.

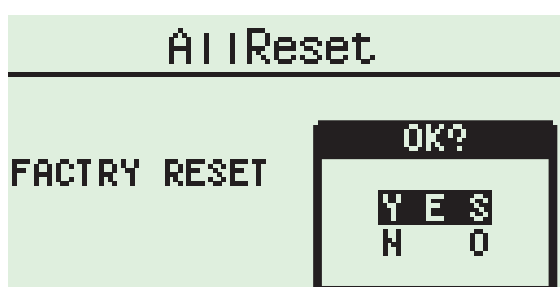

Select [YES] (press and hold ENTER key) to reset and [NO] to cancel and return to the menu. (Basic Operation p.14)

[How to Display the Setting Screen]

- ① From the System Menu, use the jog dial to select [AllReset].
- ② Select [AllReset] by pressing the ENTER key to display the AllReset screen.
- ③ Use the jog dial to select [YES].
- ④ To reset, press and hold ENTER key. To cancel, press BACK key or select [NO].

! Once reset, the previous data cannot be recovered, so be careful to avoid undesired resets.

► ICS (ICS)

Connect transmitter to a PC with ICS.

[Example]

Use when you wish to adjust the transmitter's data with a PC.

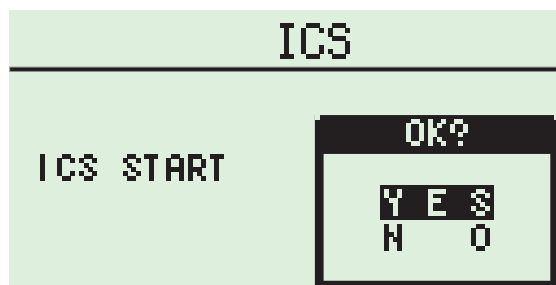

Select [YES] (press and hold ENTER key) to connect ICS. (Basic Operation p.14)

[How to Connect ICS]

Prior to procedure, connect ICS USB Adapter HS (sold separately) to the transmitter's ICS port.
*See p.7 regarding ICS port.

① ICS connection confirmation message will be displayed. Move the cursor to select [YES].

② Press and hold ENTER key.

*If ICS connection status becomes (EXIT >> POWER OFF), you cannot return to the System Menu screen.

③ The PC environment will be readied to allow transfers (data reading/writing).



[How to Disconnect ICS]

① Since you cannot return to the System Menu, confirm that all transfers are complete and then switch off the transmitter.

P If the maximum number of model data entries is reached (40 models), ICS is convenient to enable storage of model data on a PC or switching of model data.

! Check the instructions included with connection equipment for information regarding PC or ICS environment settings.

► Approval

Displays overseas product approvals.



● Warning Display

Battery Level Warning

During startup, this warning will be displayed if the battery voltage is below the required level. Normal operation will not be able to continue.

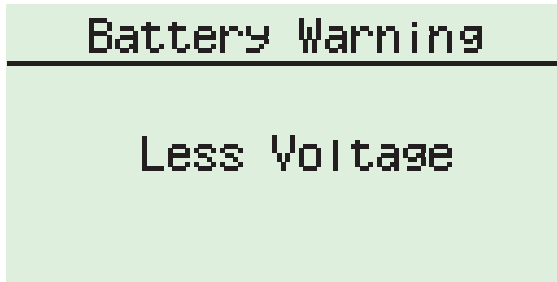

During driving, this warning will be displayed if the battery voltage is below the required level. You may still operate the model, but it is recommended to replace the battery immediately.



● FCC statement

This device complies with part 15 of the FCC Rules. Operation is subject to the following two conditions: (1) This device may not cause harmful interference, and (2) this device must accept any interference received, including interference that may cause undesired operation.

Modifications not expressly approved by this company could void the user's authority to operate the equipment.

interference by one or more of the following measures:

- Reorient or relocate the receiving antenna.
- Increase the separation between the equipment and receiver.
- Connect the equipment into an outlet on a circuit different from that to which the receiver is connected.
- Consult the dealer or an experienced radio/TV technician for help.

- list of external antennas (antenna type, max gain, necessary cable length, connector type, ...)

- statement of professional installation

- notification that the amplifier can be used only in a system which it has obtained authorization

The internal / external antennas used for this mobile transmitter must provide a separation distance of at least 20 cm from all persons and must not be co-located or operating in conjunction with any other antenna or transmitter.

This device and its antenna must not be co-located or operating in conjunction with any other antenna or transmitter.

■ Glossary

This section explains terms which appear in this instruction manual as well as terms which are common in the radio control hobby.

2.4GHz	A radio frequency range which is higher than previous ones such as 27MHz and 40MHz. However, this also means it is also more direct and signal transmission may be difficult if there are interfering objects between the transmitter and receiver.
4WS	A feature which changes the steering angle of all four wheels according to the driving condition to enable greater stability.
7.2V Servo	A servo which uses a separate power source for its motor. In the case of electric R/C cars, KO Propo's unique system sees the servo draw power from the 7.2V battery used for running the car.
27MHz	One of the radio frequency ranges used for the R/C hobby. 12 bands exist for both ground-based and airborne R/C models.
40MHz	One of the radio frequency ranges used for the R/C hobby. 8 bands and 5 bands are assigned for use with ground-based and airborne R/C models respectively.
AC Charger	A battery charger which plugs into the standard 100V wall socket (in Japan). It often requires charging times of several hours or more.
Alarm	A buzzer sound emitted by the transmitter. It may be used as a warning notification, etc.
Amp	See ESC.
Analog Servo	A type of servo which uses analog-type integrated circuits (IC).
Backlight	Since LCDs do not generate their own light and are difficult to see in dark places, this light is placed beneath it to illuminate the display.
Band	Another word for radio frequency. This can be set with frequency crystals and different crystals can dictate the frequencies used in a certain frequency range.
Band ID Tag	An item which indicates to others the frequency that a particular user is using.
Brake Pumping	The repeated action of applying and releasing the brakes.
Carburetor	A device which mixes air and fuel in an engine and governs engine RPM.
Center Trim	A trim which only adjusts the position of neutral without disturbing the overall range of travel.
Channel	Refers to the number of servos, etc. which can be controlled by a transmitter or their individual signal numbers.
Clutch	A device which is used to engage/disengage an engine's drive shaft with the transmission.
Connector	An electric circuit contact unit which can be connected/disconnected.
CPU	The core of a computer which performs digital calculations for various uses. Also sometimes called an MPU.
Crystal	A device which sets the frequency used by a transmitter. 27MHz and 40MHz systems require crystals for changing frequencies while DSSS and FHSS 2.4GHz systems do not.
Cursor	A marker on the display which indicates the position in the text which can be controlled at that time.
Cycle	A process which returns to the beginning and repeats itself.
Databank	A module containing additional memory which may be used to increase the amount of model memory.
DC Charger	A battery charger which uses a 12V battery or other stable 12V power source.
DDS	Acronym for Direct Digital System. Previous transmitters transmitted an analog signal, but transmitters such as Eurus and EX-1, which use DDS, transmit a digital signal to enable lag-free, direct control.
Dead Zone	An area in which transmitter wheel or trigger movement does not result in servo operation. It could be caused by worn out components and may be resolved using VRADJ.
Delay	When an operation is slow, or has been slowed.

Digital Servo	A type of servo which uses digital-type integrated circuits (IC).
Discharger	A device which forcibly discharges remaining electricity from batteries such as Ni-Cd.
DSSS	Acronym for Direct Sequence Spread Spectrum. It is a type of spread spectrum transmission system which uses the 2.4GHz band.
Duty Cycle	A ratio between two operations.
EEPROM	A type of memory in which stored data is not deleted when the power is turned off. This product features this type of memory.
ESC	An acronym for Electronic Speed Controller, which controls the speed of the motor on an electric-powered R/C car.
ET	An acronym for Electric Trim. Button Trim is similarly shortened as BT.
Fail-Safe Adapter	A device which sets the servo horn to a predetermined position to prevent the car from going out of control when signal interference is experienced.
FET Servo	A high-end servo in which the motor features field-effect transistors as opposed to bipolar transistors.
FHSS	Acronym for Frequency-Hopping Spread Spectrum. Like DSSS, it is a type of spread spectrum transmission system.
Frequency Range	A range of radio wave frequencies such as 27MHz, 40MHz, 2.4GHz, etc.
High Frequency ESC	An ESC which utilizes a high frequency to control the motor. Nearly all current ESCs are high frequency types, but older ESCs which are not also exist. There are ESCs to match either brushed or brushless motors.
ICS (Interactive Communication System)	This system is unique to KO Propo and enables two-way communication with a PC. By using the Interface Kit (sold separately), the transmitter's internal memory data may be edited on a PC.
Internet	A global communications network which connects smaller networks made up of multiple PCs. This network enables the release of information via websites around the world, communication via E-mail, etc.
Jog Dial	A type of rotating dial which has no stops. Each click of the dial equates to a one point adjustment to the data to be modified and it is convenient for making large adjustments at one time.
LCD	Acronym for Liquid Crystal Display. The screen is used to display letters, numbers, etc.
LED	Acronym for Light Emitting Diode. It is a type of semi-conductor which uses electricity to generate light.
Linkage	A component which connects the servo to another part of the car chassis.
Lithium-Ferrite (Li-Fe) Battery	A type of battery which is quick to charge and is good for repeated recharges. They are also less susceptible to natural discharging and are easy to manage, making them safer compared to other types of lithium batteries.
Lithium-Polymer (Li-Po) Battery	A type of lithium battery which is lightweight and available in various sizes. They are equipped with balance connectors since there is a risk of fire/explosion if they are overcharged.
Megahertz (MHz)	A unit of frequency. 1000 Hertz (Hz) = 1 Kilohertz (kHz), 1000 kHz = 1 MHz.
Memory	A term which refers to a location where information is temporarily stored (on a PC for example). Transmitters feature non-volatile memory where the stored information is not erased when power is turned off (refer to EEPROM).
Mixing	A feature which combines the signals for multiple operations or effects into a more efficient output signal.
Monitor	A function which checks the operation of each channel.
Neutral	The position of the transmitter controls when they are not operated, or the position of the servo horn at that time.
Neutral Brake	A feature where braking is applied when the throttle is returned from forward acceleration to neutral position. Also called "drag brake."
Ni-Cd	A type of battery which can be recharged for repeated use. Other types of rechargeable batteries include Ni-MH and Li-ion.

Ni-MH	Compared to Ni-Cd batteries, Ni-MH batteries have a larger capacity. They are more environmentally-friendly since it does not contain Cadmium, but they are also more susceptible to damage from overdischarging.
Noise	Electrical interference. Since it is a type of frequency, it could cause the receiver to operate in error.
Override	When a high-priority (1CH / 2CH) function setting is switched to a low-priority one.
Pairing	The act of writing a 2.4GHz transmitter's ID into a receiver so that the receiver only chooses to receive that transmitter's signals. This must be done once before a transmitter is used.
PC Interface	An adapter used to connect a transmitter to a PC to enable the adjustment of the former's settings on the latter.
Preset	The act of specifying a setting position in advance.
Propo	Japanese language abbreviation of "proportional." Refers to an R/C transmitter or the transmitter/receiver combination.
Pushrod	A rod-shaped linkage.
Quick Recharger	A charger which could recharge Ni-Cd, Ni-MH, etc. batteries in a short amount of time.
R/C Equipment Tray	A tray/deck on an R/C car chassis on which the receiver servo, etc. are installed.
Receiver (RX)	A device which receives radio signals from the transmitter and passes them on to the servo and ESC. Use of the same type of signal as the transmitter is required.
Regulator	A circuit which stabilizes the input voltage to the level of the required voltage.
Reset	Returning the settings to the original preset condition.
Response	The time between a transmitter input and a receiver reaction.
RF Module	A component which generates and transmits radio frequencies. They exist in 27MHz, 40MHz, 2.4GHz (DSSS), and 2.4GHz (FHSS) types, with some transmitters allowing modules to be interchanged.
Rubber Grommet	A rubber component attached to the servo case ears which protects the servo from vibrations.
Servo	A device which translates the transmitter's radio signals into mechanical rotational movement.
Servo Saver Horn	A horn which features an internal shock absorber. This is included in the kit.
Spec List	A list which describes the makeup, performance, etc. of a piece of R/C equipment.
Spline	Another word for "universal." Due to the offset integrated into the output shaft's groove and the horn's hole, this will precisely match their positions when spun.
Sub Trim	Adjusts the overall steering angle range. ※Refer to Trim and Sub Trim Usage
Swing	A repeated action between two set points.
Torque	A measure of the force at work in the rotating shafts of motors, servos, etc.
Transmitter (TX)	A device which sends out radio waves to a receiver linked to servos, ESCs, etc. to control an R/C model.
Travel	The angle/amount of servo horn movement.
Trigger	A mechanism on a transmitter which looks like a gun trigger, the operation of which controls the throttle.
Trim	A mechanism which adjusts the neutral position of each channel.
VR	Acronym for Variable Resistor. An electrical component which senses the position of the steering, throttle, etc.
Website	Places on the internet on which information is disseminated. They are accessed via PC software called web browsers. Some websites are also known as homepages.
Wheel	A mechanism on a transmitter which is rotated left and right to control steering.
Width	The range within which the ABS or throttle operates.

■ Specifications

- **Transmitter: KT-411H**
 - Control Type: Wheel & Trigger
 - Number of Channels: 4
 - Power Source: R03/AAA/UM4 battery x4
 - Current: Below 140mAh
 - Dimensions: 230 x 135 x 100mm (not including protrusions)
 - Weight: 590g (not including batteries)

- **High Frequency Module: Internal KTSS-703**
 - Modulation Type: FHSS
 - Transmission Frequency Range: 2.4GHz

- Receiver: KR-411FH
- Receiver Modulation Type: FHSS
- **Number of Channels: 4**
 - Receiver Frequency Range: 2.4GHz
 - Operating Voltage: 4.8V - 7.4V
 - Neutral Balance: 1.5 mSec
 - Dimensions: 28 x 18.3 x 18.5mm
 - Weight: 7.5g

EX-1

KO PROPO
DIGITAL PROPORTIONAL SYSTEM