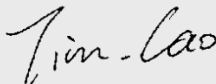
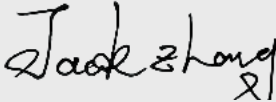

Test report No:
2270411R-RF-US-P06V01

FCC TEST REPORT

Product Name	Arella 400
TradeMark	N/A
Model and /or type reference	JY-1305ATXG
FCC ID	QH67115952LV3
Applicant's name / address	Bell Sports Inc. 555 SCOTTS VALLEY DRIVE,SCOTTS VALLEY,CA 95066.
Test method requested, standard	FCC CFR Title 47 Part 15 Subpart C Section 15.247 ANSI C63.10: 2013 KDB558074 D01v05r02
Verdict Summary	IN COMPLIANCE
Documented By (name / position & signature)	Tim Cao/ Project Engineer 
Approved by (name / position & signature)	Jack Zhang/ Manager 
Date of issue	2022-08-28
Report Version	V1.1
Report template No	Template_FCC Part 15C-RF-V1.0

INDEX

page

INDEX	2
COMPETENCES AND GUARANTEES	4
GENERAL CONDITIONS.....	4
ENVIRONMENTAL CONDITIONS	4
POSSIBLE TEST CASE VERDICTS	5
ABBREVIATIONS.....	5
DOCUMENT HISTORY	6
REMARKS AND COMMENTS	6
USED EQUIPMENT.....	7
UNCERTAINTY	9
1 GENERAL INFORMATION	10
1.1 General Description of the Item(s).....	10
1.2 Antenna Information.....	11
1.3 Channel List.....	12
2 DESCRIPTION OF TEST SETUP	13
2.1 Operating mode(s) used for tests	13
2.2 Support / Auxiliary equipment / unit / Test software for the EUT	13
2.3 Test Configuration / Block diagram used for tests	14
2.4 Testing process.....	15
3 VERDICT SUMMARY SECTION.....	16
3.1 Standards	16
3.2 Deviation(s) from the Standard(s) / Test Specification(s).....	16
3.3 Overview of results.....	17
3.4 Test Facility.....	18
4 TEST RESULTS	19
4.1 AC Power Line Conducted Emission	18
4.2 Emissions in restricted frequency bands.....	22
4.3 Emissions in non-restricted frequency band.....	34
4.4 Radiated Emission Band Edge	37
4.5 DTS Bandwidth	48
4.6 Fundamental emission output power	50
4.7 Power Density Antenna Requirement	53
4.8 Antenna Requirement	55

5	TEST SETUP PHOTO AND EUT PHOTO	56
---	--------------------------------------	----

COMPETENCES AND GUARANTEES

DEKRA is a testing laboratory competent to carry out the tests described in this report.

In order to assure the traceability to other national and international laboratories, DEKRA has a calibration and maintenance program for its measurement equipment.

DEKRA guarantees the reliability of the data presented in this report, which is the result of the measurements and the tests performed to the item under test on the date and under the conditions stated in the report and it is based on the knowledge and technical facilities available at DEKRA at the time of performance of the test.

DEKRA is liable to the client for the maintenance of the confidentiality of all information related to the item under test and the results of the test.

The results presented in this Test Report apply only to the particular item under test established in this document.

IMPORTANT: No parts of this report may be reproduced or quoted out of context, in any form or by any means, except in full, without the previous written permission of DEKRA.

GENERAL CONDITIONS

Test Location	No. 99, Hongye Road, Suzhou Industrial PEUT: Handheld Thermal Binoculars Suzhou, 215006, P.R. China
Date(receive sample)	Jul. 15, 2022
Date (start test)	Jul. 16, 2022
Date (finish test)	Jul. 25, 2022

1. This report is only referred to the item that has undergone the test.
2. This report does not constitute or imply on its own an approval of the product by the Certification Bodies or Competent Authorities.
3. This document is only valid if complete; no partial reproduction can be made without previous written permission of DEKRA.
4. This test report cannot be used partially or in full for publicity and/or promotional purposes without previous written permission of DEKRA.

ENVIRONMENTAL CONDITIONS

The climatic conditions during the tests are within the limits specified by the manufacturer for the operation of the EUT and the test equipment. The climatic conditions during the tests were within the following limits:

Ambient temperature	15 °C – 35 °C
Relative Humidity air	30% - 60%

If explicitly required in the basic standard or applied product / product family standard the climatic values are recorded and documented separately in this test report.

POSSIBLE TEST CASE VERDICTS

Test case does not apply to test object	N/A
Test object does meet requirement	P (Pass) / PASS
Test object does not meet requirement	F (Fail) / FAIL
Not measured	N/M

ABBREVIATIONS

For the purposes of the present document, the following abbreviations apply:

EUT	: Equipment Under Test
QP	: Quasi-Peak
CAV	: CISPR Average
AV	: Average
CDN	: Coupling Decoupling Network
SAC	: Semi-Anechoic Chamber
OATS	: Open Area Test Site
BW	: Bandwidth
AM	: Amplitude Modulation
PM	: Pulse Modulation
HCP	: Horizontal Coupling Plane
VCP	: Vertical Coupling Plane
U_N	: Nominal voltage
Tx	: Transmitter
Rx	: Receiver
N/A	: Not Applicable
N/M	: Not Measured

DOCUMENT HISTORY

Report No.	Version	Description	Issued Date
2270411R-RF-US-P06V01	V1.0	Initial issue of report.	2022-08-18
2270411R-RF-US-P06V01	V1.1	Modify the error section in the report, V1.0 is outdated.	2022-08-28

REMARKS AND COMMENTS

1. The equipment under test (EUT) does meet the essential requirements of the stated standard(s)/test(s).
2. These test results on a sample of the device are for the purpose of demonstrating Compliance with Part 15 Subpart C Paragraph 15.247, RSS-Gen Issue 5, RSS-247 Issue 2.
3. The measurement result is considered in conformance with the requirement if it is within the prescribed limit, It is not necessary to account the uncertainty associated with the measurement result.
4. The test results presented in this report relate only to the object tested.
5. The test report shall not be reproduced without the written approval of DEKRA Testing and Certification (Suzhou) Co., Ltd.
6. This report will not be used for social proof function in China Market.
7. DEKRA declines any responsibility with the following test data provided by customer that may affect the validity of result:
 - Chapter 1.1 General Description of the Item(s);
 - Chapter 1.2 Antenna Information;
 - Chapter 1.3 Data Rate;
 - Chapter 1.4 Channel List.

USED EQUIPMENT

AC Power Line Conducted Emission / TR1

Instrument	Manufacturer	Model No.	Serial No.	Cal. Date	Next Cal. Date
EMI Test Receiver	R&S	ESCI	100906	2022.04.27	2023.04.26
Two-Line V-Network	R&S	ENV216	101044	2022.03.19	2023.03.18
50ohm Termination	SHX	TF2	7081402	2021.09.04	2022.09.03
50ohm Termination	SHX	TF2	7081403	2021.09.04	2022.09.03
50ohm Coaxial Switch	Anritsu	MP59B	6200464462	N/A	N/A
Temperature/Humidity Meter	RTS	RTS-8S	TR1-TH	2022.07.06	2023.07.05
Dekra test software	Dekra	-	-	-	-

Emissions in non-restricted frequency bands/ Occupied Bandwidth/ Fundamental emission output power Power Spectral Density / TR8

Instrument	Manufacturer	Model No.	Serial No.	Cal. Date	Next Cal. Date
Spectrum Analyzer	Agilent	N9010A	MY48030494	2021.12.15	2022.12.14
EXA Spectrum Analyzer	Keysight	N9010A	MY55370495	2022.03.19	2023.03.18
MXA Signal Analyzer	Keysight	N9020A	MY56060147	2021.07.11	2022.07.10
4TX MIMO Power Sensor	Keysight	X8750A	MY59400102	2022.03.30	2023.03.29
Temperature/Humidity Meter	RTS	RTS-8S	RF08	2022.07.08	2023.07.07

Radiated Emission(30MHz-1GHz) / AC3

Instrument	Manufacturer	Model No.	Serial No.	Cal. Date	Next Cal. Date
EMI Test Receiver	R&S	ESCI	100176	2021.08.15	2022.08.14
Loop Antenna	R&S	HFH2-Z2	100548	2021.12.13	2022.12.12
Bilog Antenna	Teseq GmbH	CBL6112D	27613	2021.08.23	2022.08.22
Coaxial Cable	Huber+Suhner	RG 214	AC3-C	2022.03.30	2023.03.29
Temperature/Humidity Meter	RTS	RTS-8S	AC3-TH	2021.11.23	2022.11.22
Dekra test software	Dekra	-	-	-	-

Radiated Emission / AC5(1GHz-40GHz)

Instrument	Manufacturer	Model No.	Serial No.	Cal. Date	Next Cal. Date
EXA Spectrum Analyzer	Keysight	N9010A	MY55370495	2022.03.19	2023.03.18
Amplifier	Keleto	LNPA	SK20190225	2021.09.26	2022.09.25
Pre-Amplifier	EMCI	EMC184045SE	980263	2022.05.21	2023.05.20
DRG Horn Antenna	ETS-Lindgren	3117	167055	2021.08.06	2022.08.05
Broad-Band Horn Antenna	Schwarzbeck	BBHA9170	294	2022.04.18	2023.04.17
Coaxial Cable	Huber+Suhner	SUCOFLEX 106	AC5-C2	2022.03.30	2023.03.29
Coaxial Cable	ROSENBERGER	LA1-C011-2000/3000	AC5-40G	2022.03.19	2023.03.18

UNCERTAINTY

Uncertainties have been calculated according to the DEKRA internal document. The reported expanded uncertainties are based on a standard uncertainty multiplied by a coverage factor of $k=2$, providing a level of confidence of approximately 95%.

Test item	Uncertainty
AC Power Line Conducted Emission	9kHz~150kHz: 2.80dB 150kHz~30MHz: 2.40dB
Peak Power Output	± 1.27 dB
Radiated Emission(30MHz~1GHz)	Horizontal: 30MHz~200MHz: 3.50 dB 300MHz~1GHz: 3.60 dB Vertical: 30MHz~200MHz: 3.60 dB 300MHz~1GHz: 3.50 dB
Radiated Emission(1GHz~26.5GHz)	Horizontal: 1GHz~18GHz: 5.00 dB Vertical: 1GHz~18GHz: 4.80 dB
RF antenna conducted test	± 1.27 dB
Radiated Emission Band Edge	± 3.9 dB
DTS Bandwidth	± 150 Hz
Occupied Bandwidth	± 1 kHz
Power Density	± 1.27 dB

1 GENERAL INFORMATION

1.1 General Description of the Item(s)

Product Name.....:	Arella 400
Model No.....:	JY-1305ATXG
FCC ID	QH67115952LV3
Hardware Version	V1.0
Software Version	V1.0
Manufacturer.....:	Jiashan Shengguang Electronics Co., LTD.
Manufacturer address.....:	No.1919 Jiashan Dadao, Jiashan, Zhejiang, China 314113

Operating frequency range(s).....:	2400~2483.5MHz
Type of modulation	ACK
Number of channel	3
Operating Temperature Range	0°C~40°C

Rated power supply	Voltage and Frequency	
	<input type="checkbox"/>	AC: 220 - 240 V, 50/60 Hz
	<input type="checkbox"/>	AC: 100 - 240 V, 50/60 Hz
	<input type="checkbox"/>	DC: 3 Vdc
	<input checked="" type="checkbox"/>	Battery: 3.0 V
	<input type="checkbox"/>	Adapter: 5 V

1.2 Antenna Information

Antenna model / type number.....:	N/A		
Antenna serial number.....:	N/A		
Antenna Delivery	<input checked="" type="checkbox"/>	1TX + 1RX	
	<input type="checkbox"/>	2TX + 2RX	
	<input type="checkbox"/>	Others:.....	
Antenna technology	<input checked="" type="checkbox"/>	SISO	
	<input type="checkbox"/>	MIMO	<input type="checkbox"/> Basic
			<input type="checkbox"/> CDD
			<input type="checkbox"/> Sectorized
			<input type="checkbox"/> Beam-forming
Antenna Type	<input type="checkbox"/>	External	<input type="checkbox"/> Dipole
			<input type="checkbox"/> Sectorized
	<input checked="" type="checkbox"/>	Internal	<input type="checkbox"/> PIFA
			<input checked="" type="checkbox"/> PCB
			<input type="checkbox"/> Ceramic Chip
			<input type="checkbox"/> Metal Antenna
Antenna Gain.....:	0 dBi		

1.3 Channel List

Working Frequency of Each Channel							
Channel	Frequency	Channel	Frequency	Channel	Frequency	Channel	Frequency
001	2402 MHz	002	2440 MHz	003	2478 MHz	-	-
-	-	-	-	-	-	-	-
-	-	-	-	-	-	-	-

Note: The General Description of the Item(s), antenna information, Data Rate and Channel List in clause 1 are provided and confirmed by the client.

2 DESCRIPTION OF TEST SETUP

2.1 Operating mode(s) used for tests

During the tests the following operating mode(s) has(have) been used.

	Mode 1: Transmit by ACK
--	-------------------------

2.2 Support / Auxiliary equipment / unit / Test software for the EUT

The EUT has been tested with the following auxiliary equipment / unit / software:

Auxiliary equipment	Type / Version	Manufacturer	Supplied by
Notebook	Think pad x220	Lenovo	Adapter
Software	Type / Version	Manufacturer	Supplied by
IPOP	4.1	N/A	N/A

2.3 Test Configuration / Block diagram used for tests

The following test setup / configuration / block diagram has been used during the tests:

Test setup Diagram- Radiated Test

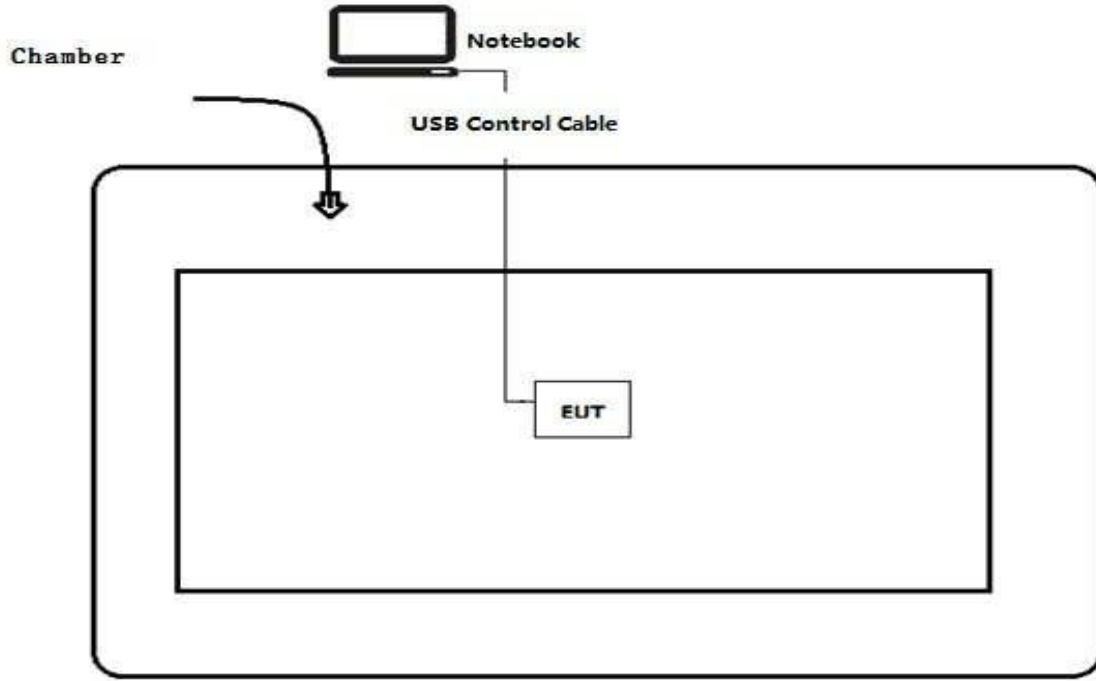

Test setup Diagram- Conducted test

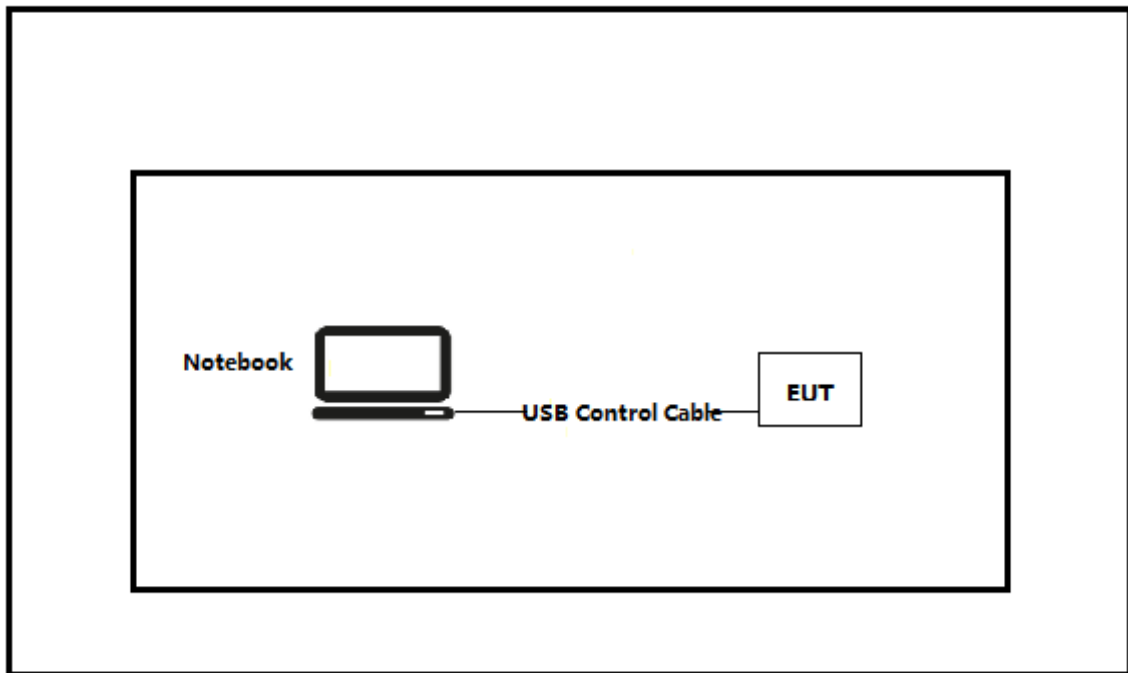

2.4 Testing process

1	Setup the EUT as shown in Section 2.3.
2	Execute the [IPOP] on the notebook.
3	Configure the test mode, the test channel, and the data rate.
4	Verify that the EUT works properly.

3 VERDICT SUMMARY SECTION

This chapter presents an overview of standards and results. Refer to the next chapters for details of measured test results and applied test levels.

3.1 Standards

Standard	Year	Description
FCC CFR Title 47 Part 15 Subpart C Section 15.247	2021	Operation within the bands 902–928 MHz, 2400–2483.5 MHz, and 5725–5850 MHz.
ANSI C63.10	2013	American National Standard of Procedures for Compliance Testing of Unlicensed Wireless Devices
KDB 558074 D01V05r02	2019	Guidance for performing compliance measurements on Digital Transmission System (DTS) operating under section 15.247

3.2 Deviation(s) from the Standard(s) / Test Specification(s)

The following deviation(s) was / were made from the published requirements of the listed standards: N/A.

(Please define the deviations from the standard(s) if applicable)

3.3 Overview of results

Requirement – Test case	Basic standard(s)	Verdict	ReMark
AC Power Line Conducted Emission	FCC 15.207	PASS	---
Emissions in restricted frequency bands	FCC 15.247(d), 15.209	PASS	---
Emissions in non-restricted frequency bands	FCC 15.247(d)	PASS	---
Radiated Emission Band Edge	FCC 15.247(d), 15.209	PASS	---
Fundamental emission output power	FCC 15.247(b)(3)	PASS	---
DTS Bandwidth	FCC 15.247(a)(2)	PASS	---
Power Spectral Density	FCC 15.247(e)	PASS	---
Antenna Requirement	FCC 15.203	PASS	---

3.4 Test Facility

USA : FCC Designation Number: CN1199

4 TEST RESULTS

4.1 AC Power Line Conducted Emission VERDICT: PASS

4.1.1 Limit

Standard	FCC Part 15 Subpart C Paragraph 15.207		
Frequency range [MHz]	Limit: QP [dB(μV) ¹⁾		Limit: AV [dB(μV) ¹⁾
0,15 - 0,50	66	- 56 ²⁾	56 - 46 ²⁾
0,50 - 5,0	56		46
5,0 - 30	60		50

¹⁾ At the transition frequency, the lower limit applies.

²⁾ The limit decreases linearly with the logarithm of the frequency.

NOTE 1: The exclusion band for transmitters shall be considered for transmitters operating at frequencies below 30 MHz.

NOTE 2: Where the AC output port is directly connected (or via a circuit breaker) to the AC power input port of the EUT the AC power output port need not to be tested.

4.1.2 Test Setup

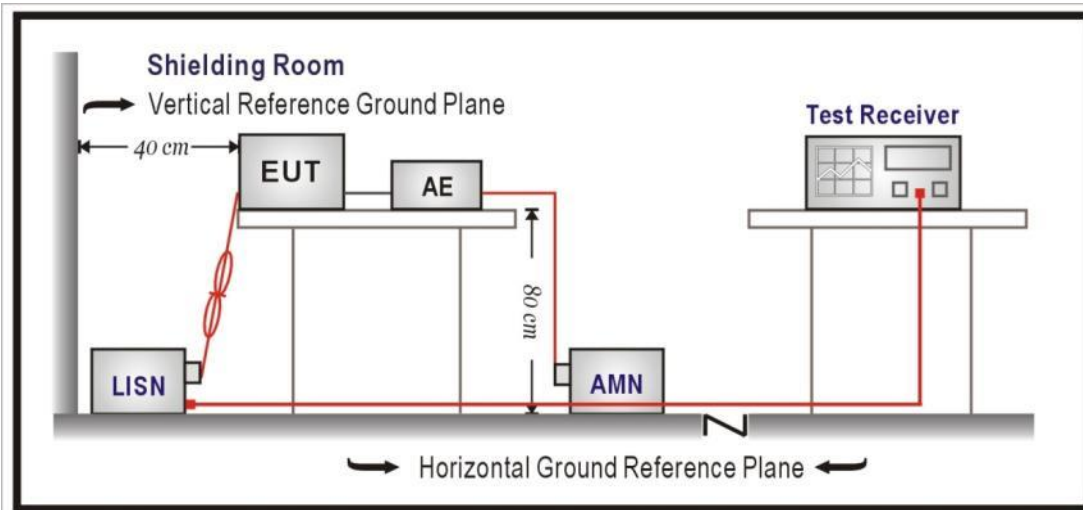

4.1.3 Test Procedure

	References Rule	Chapter	Item
<input checked="" type="checkbox"/>	ANSI C63.10-2013	6.2	Standard test method for ac power-line conducted emissions from unlicensed wireless devices

4.1.4 Test Data

Profile: 2270411R	Page No.: 79
Engineer: Pengchengyang	
Site: TR1	Time: 2022/07/19
Limit: FCC_Part15.107_CE_AC Power_ClassB	Margin: 0
Probe: ENV216_101190(0.009-30MHz)	Polarity: Neutral
EUT: Bicycle Light	Power: DC 3V
Note: Mode: N-Neutral	

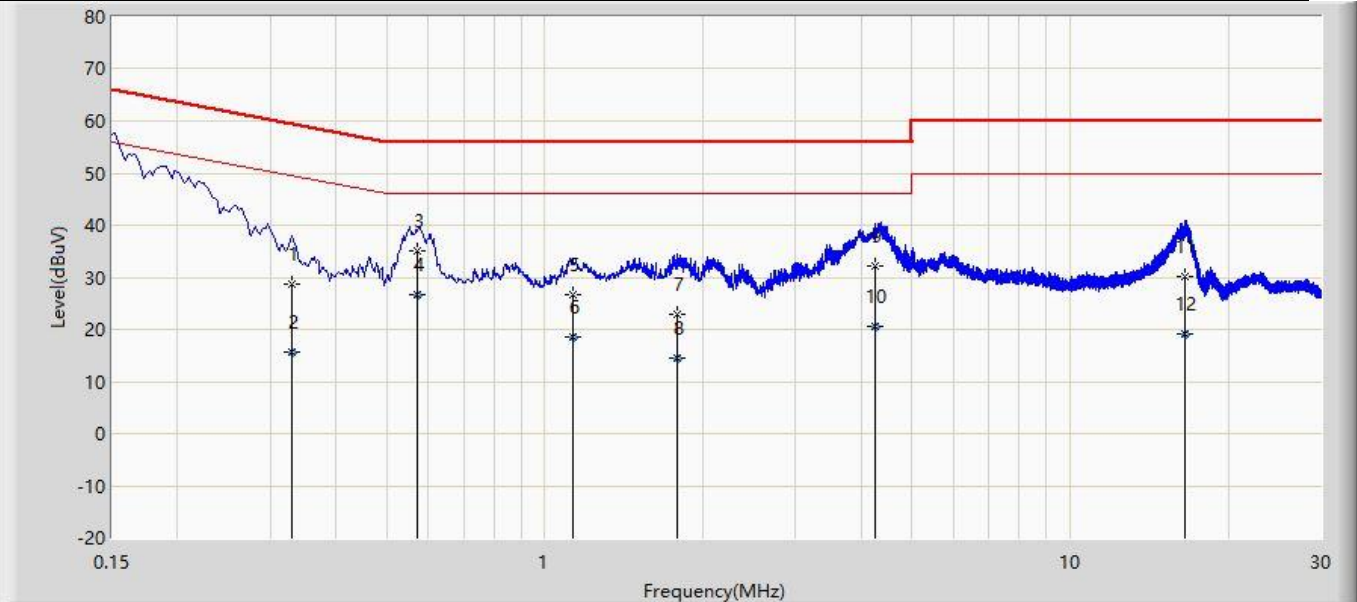

No	Mark	Frequency (MHz)	Measure Level (dBuV)	Reading Level (dBuV)	Over Limit (dB)	Limit (dBuV)	Factor (dB)	Type
1		0.330	28.551	18.952	-30.900	59.451	9.599	QP
2		0.330	15.581	5.982	-33.870	49.451	9.599	AV
3		0.570	35.038	25.405	-20.962	56.000	9.633	QP
4	*	0.570	26.703	17.070	-19.297	46.000	9.633	AV
5		1.127	26.572	16.921	-29.428	56.000	9.651	QP
6		1.127	18.688	9.037	-27.312	46.000	9.651	AV
7		1.788	22.843	13.167	-33.157	56.000	9.676	QP
8		1.788	14.482	4.806	-31.518	46.000	9.676	AV
9		4.250	32.174	22.403	-23.826	56.000	9.771	QP
10		4.250	20.653	10.881	-25.347	46.000	9.771	AV
11		16.584	30.222	20.035	-29.778	60.000	10.188	QP
12		16.584	19.126	8.939	-30.874	50.000	10.188	AV

Profile: 2270411R	Page No.: 80
Engineer: Pengchengyang	
Site: TR1	Time: 2022/07/19
Limit: FCC_Part15.107_CE_AC Power_ClassB	Margin: 0
Probe: ENV216_101190(0.009-30MHz)	Polarity: Line
EUT: Bicycle Light	Power: DC 3V
Note: Mode: N-Line	

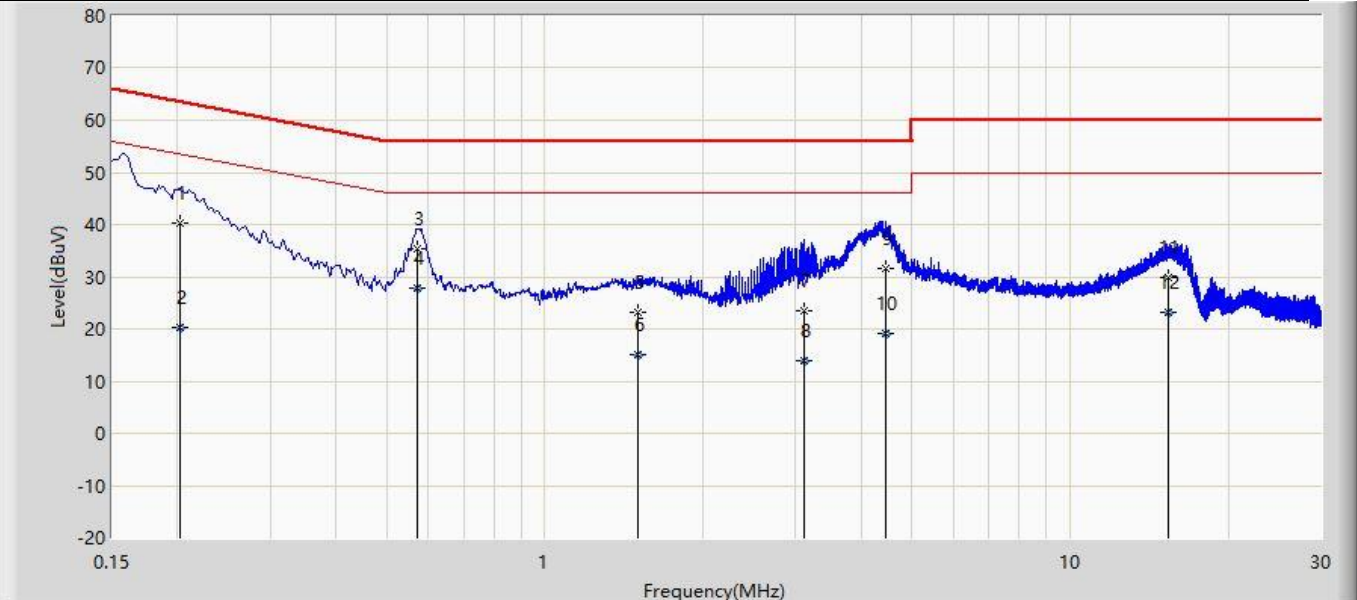

No	Mark	Frequency (MHz)	Measure Level (dBuV)	Reading Level (dBuV)	Over Limit (dB)	Limit (dBuV)	Factor (dB)	Type
1		0.202	40.280	30.693	-23.258	63.538	9.586	QP
2		0.202	20.235	10.649	-33.303	53.538	9.586	AV
3		0.573	35.366	25.730	-20.634	56.000	9.637	QP
4	*	0.573	27.771	18.135	-18.229	46.000	9.637	AV
5		1.507	23.198	13.537	-32.802	56.000	9.661	QP
6		1.507	14.952	5.291	-31.048	46.000	9.661	AV
7		3.115	23.425	13.694	-32.575	56.000	9.731	QP
8		3.115	14.049	4.318	-31.951	46.000	9.731	AV
9		4.461	31.538	21.744	-24.462	56.000	9.793	QP
10		4.461	19.210	9.417	-26.790	46.000	9.793	AV
11		15.326	29.728	19.593	-30.272	60.000	10.135	QP
12		15.326	23.105	12.970	-26.895	50.000	10.135	AV

Note:

1. " * ", means this data is the worst emission level.

2. Measurement Level = Reading Level + Factor(Probe+Cable-Amp). Test Photograph.

4.2 Emissions in restricted frequency bands	VERDICT: PASS
--	----------------------

4.2.1 Limit

Standard	FCC Part 15 Subpart C Paragraph 15.205; 15.209
-----------------	--

Restricted Bands of operation for FCC

Frequency (MHz)	Frequency (MHz)	Frequency (MHz)	Frequency (GHz)
0.090 – 0.110	16.42 – 16.423	399.9 – 410	4.5 – 5.15
0.495 – 0.505	16.69475 – 16.69525	608 – 614	5.35 – 5.46
2.1735 – 2.1905	16.80425 – 16.80475	960 – 1240	7.25 – 7.75
4.125 – 4.128	25.5 – 25.67	1300 – 1427	8.025 – 8.5
4.17725 – 4.17775	37.5 – 38.25	1435 – 1626.5	9.0 – 9.2
4.20725 – 4.20775	73 – 74.6	1645.5 – 1646.5	9.3 – 9.5
6.215 – 6.218	74.8 – 75.2	1660 – 1710	10.6 – 12.7
6.26775 – 6.26825	108 – 121.94	1718.8 – 1722.2	13.25 – 13.4
6.31175 – 6.31225	123 – 138	2200 – 2300	14.47 – 14.5
8.291 – 8.294	149.9 – 150.05	2310 – 2390	15.35 – 16.2
8.362 – 8.366	156.52475 – 156.52525	2483.5 – 2500	17.7 – 21.4
8.37625 – 8.38675	156.7 – 156.9	2690 – 2900	22.01 – 23.12
8.81425 – 8.81475	162.0125 – 167.17	3260 – 3267	23.6 – 24.0
12.29 – 12.293	167.72 – 173.2	3332 – 3339	31.2 – 31.8
12.51975 – 12.52025	240 – 285	3345.8 – 3358	36.43 – 36.5
12.57675 – 12.57725	322 – 335.4	3600 – 4400	Above 38.6
13.36 – 13.41	--	--	--

Restricted Band Emissions Limit

Frequency (MHz)	Field strength (µV/m)	Field strength (dBµV/m)	Measurement distance (m)
0.009 - 0.49	2400/F(kHz)	48.5 – 13.8	300 ^(Note 1)
0.49 - 1.705	24000/F(kHz)	33.8 - 23	30 ^(Note 1)
1.705 - 30	30	29.5	30 ^(Note 1)
30 - 88	100	40	3 ^(Note 2)
88 - 216	150	43.5	3 ^(Note 2)
216 - 960	200	46	3 ^(Note 2)
Above 960	500	54	3 ^(Note 2)

Note 1: At frequencies below 30 MHz, measurements may be performed at a distance closer than that specified in the regulations; however, an attempt should be made to avoid making measurements in the near field. Pending the development of an appropriate measurement procedure for measurements performed below 30 MHz, when performing measurements at a closer distance than specified, the results shall be extrapolated to the specified distance by either making measurements at a minimum of two distances on at least one radial to determine the proper extrapolation factor or by using the square of an inverse linear distance extrapolation factor (40 dB/decade).

Note 2: At frequencies at or above 30 MHz, measurements may be performed at a distance other than what is specified provided: measurements are not made in the near field except where it can be shown that near field measurements are appropriate due to the characteristics of the device; and it can be demonstrated that the signal levels needed to be measured at the distance employed can be detected by the measurement equipment. Measurements shall not be performed at a distance greater than 30 meters unless it can be further demonstrated that measurements at a distance of 30 meters or less are impractical. When performing measurements at a distance other than that specified, the results shall be extrapolated to the specified distance using an extrapolation factor of 20 dB/decade (inverse linear-distance for field strength measurements; inverse-linear-distance-squared for power density measurements).

4.2.2 Test Setup

Below 30MHz Test Setup:

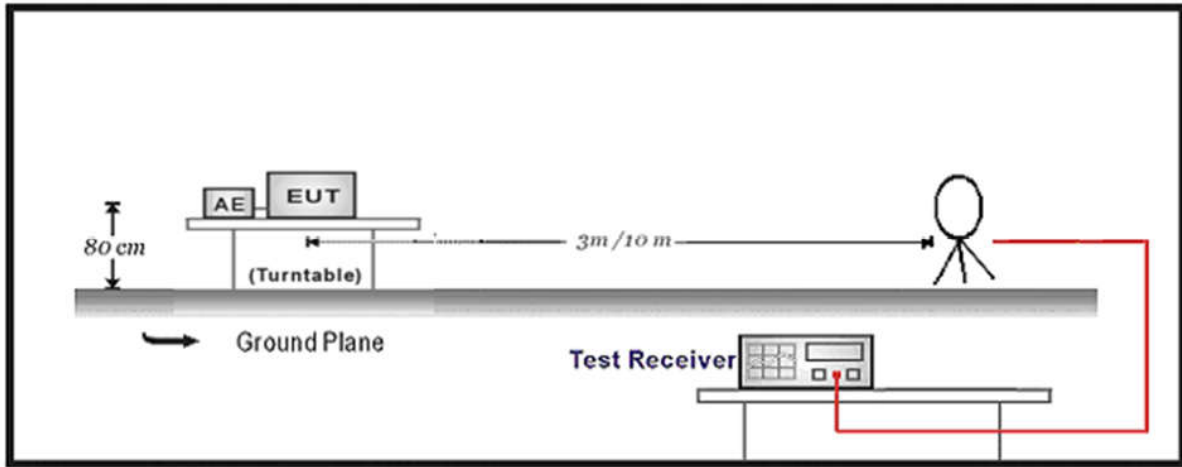

30MHz-1GHz Test Setup:

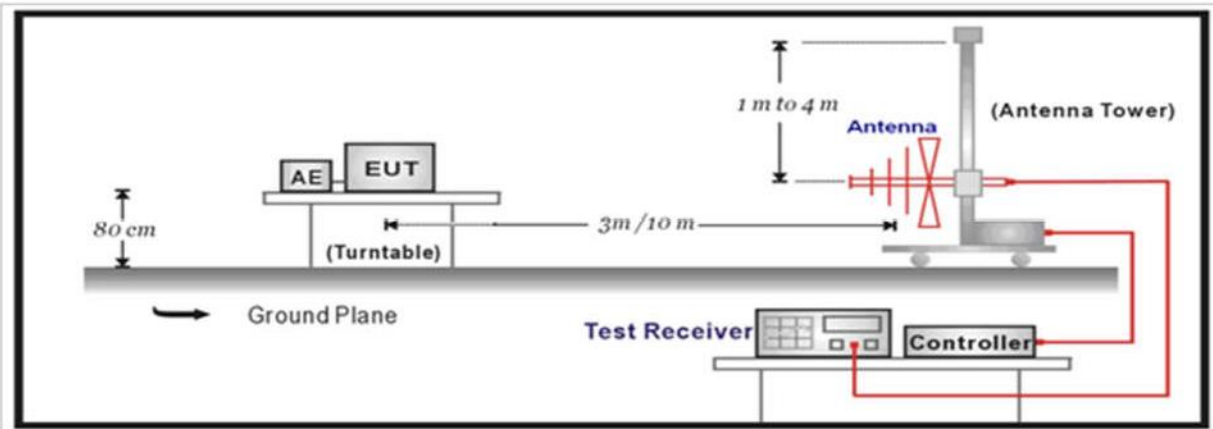

Above 1GHz Test Setup:

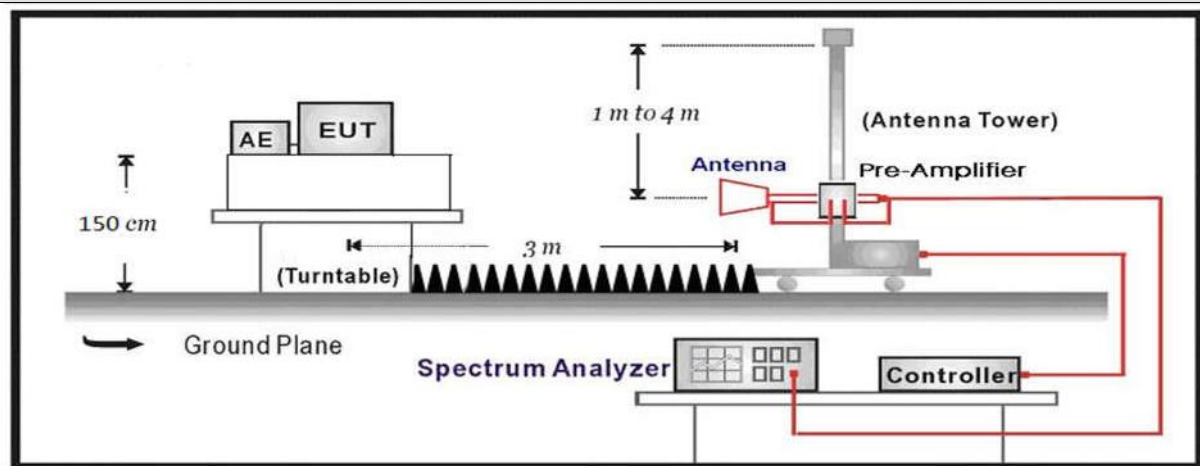

4.2.3 Test Procedure			
	References Rule	Chapter	Description
<input checked="" type="checkbox"/>	ANSI C63.10	11.12	Emissions in restricted frequency bands
	<input checked="" type="checkbox"/> ANSI C63.10	11.12.1	Radiated emission measurements
	<input checked="" type="checkbox"/> ANSI C63.10	6.3	Radiated spurious emission test
	<input checked="" type="checkbox"/> ANSI C63.10	6.4	Radiated emissions from unlicensed wireless devices below 30 MHz
	<input checked="" type="checkbox"/> ANSI C63.10	6.5	Radiated emissions from unlicensed wireless devices in the frequency range of 30 MHz to 1000 MHz
	<input checked="" type="checkbox"/> ANSI C63.10	6.6	Radiated emissions from unlicensed wireless devices above 1 GHz
	<input type="checkbox"/> ANSI C63.10	11.12.2	Antenna-port conducted measurements
	<input type="checkbox"/> ANSI C63.10	11.12.2.3	Quasi-peak measurement procedure
	<input type="checkbox"/> ANSI C63.10	11.12.2.4	Peak power measurement procedure
	<input type="checkbox"/> ANSI C63.10	11.12.2.5	Average power measurement procedures
	<input type="checkbox"/> ANSI C63.10	11.12.2.5.1	Trace averaging with continuous EUT transmission at full power
	<input type="checkbox"/> ANSI C63.10	11.12.2.5.2	Trace averaging across ON and OFF times of the EUT transmissions followed by duty cycle correction
	<input type="checkbox"/> ANSI C63.10	11.12.2.5.3	Reduced VBW averaging across ON and OFF times of the EUT transmissions with max hold

4.2.4 Test Data

Profile: 2270411R	Page No.: 7
Engineer: Pengchengyang	
Site: AC5	Time: 2022/07/18
Limit: FCC_Part15.209_RE(3m)	Margin: 0
Probe: Horn_3117_00167055(1-18GHz)	Polarity: Horizontal
EUT: Bicycle Light	Power: DC 3V
Note: Mode 1:Transmit at 2402MHz	

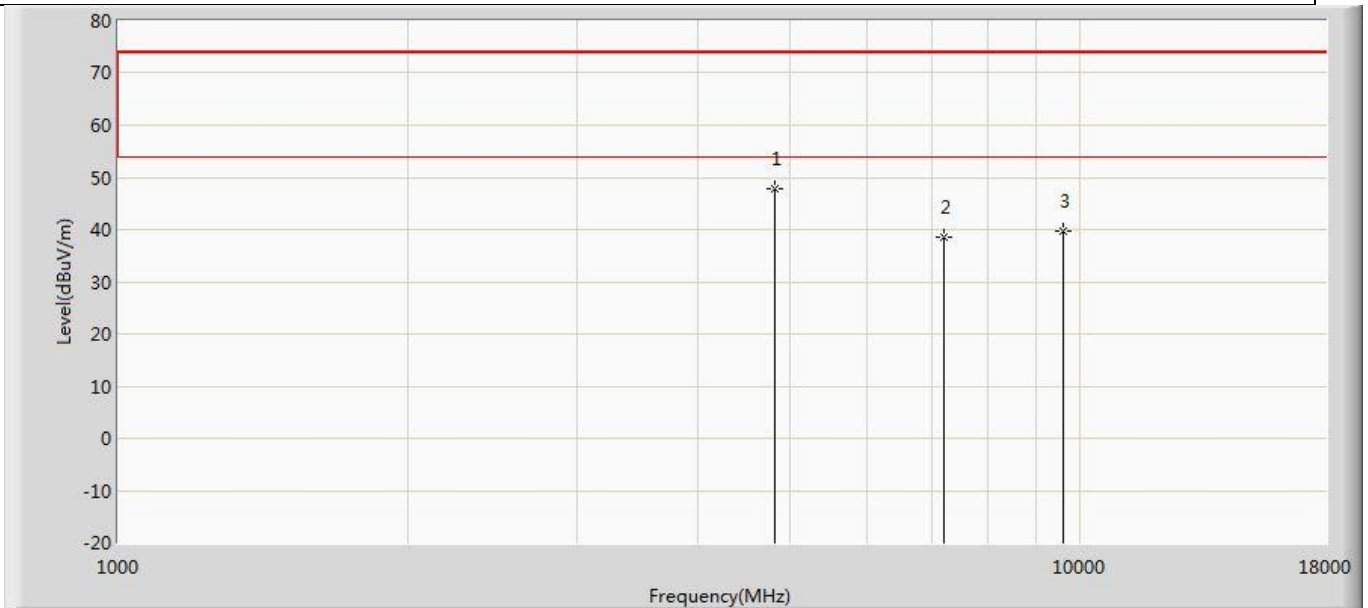

No	Mark	Frequency (MHz)	Measure Level (dBuV/m)	Reading Level (dBuV)	Over Limit (dB)	Limit (dBuV/m)	Factor (dB)	Type
1	*	4808.000	47.733	60.123	-26.267	74.000	-12.390	PK
2		7206.000	38.526	46.323	-35.474	74.000	-7.796	PK
3		9608.000	39.851	46.110	-34.149	74.000	-6.258	PK

Profile: 2270411R	Page No.: 8
Engineer: Pengchengyang	
Site: AC5	Time: 2022/07/18
Limit: FCC Part15.209 RE(3m)	Margin: 0
Probe: Horn_3117_00167055(1-18GHz)	Polarity: Vertical
EUT: Bicycle Light	Power: DC 3V
Note: Mode 1:Transmit at 2402MHz	

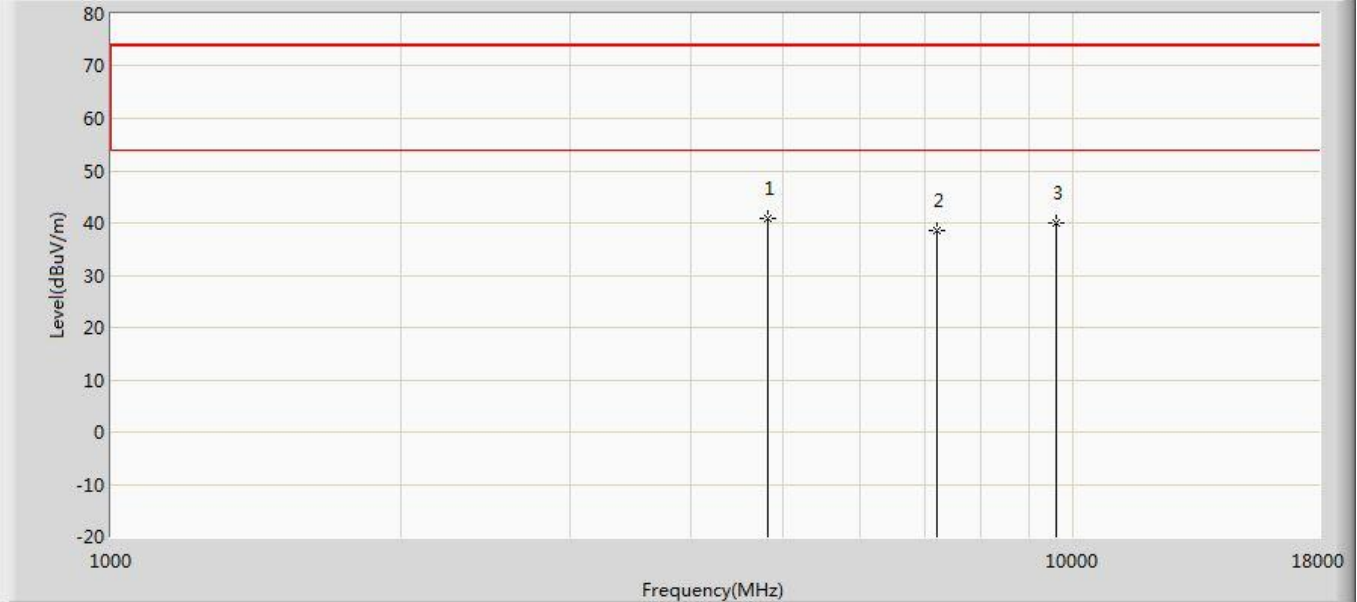

No	Mark	Frequency (MHz)	Measure Level (dBuV/m)	Reading Level (dBuV)	Over Limit (dB)	Limit (dBuV/m)	Factor (dB)	Type
1	*	4808.000	40.906	53.296	-33.094	74.000	-12.390	PK
2		7206.000	38.464	46.261	-35.536	74.000	-7.796	PK
3		9608.000	39.945	46.204	-34.055	74.000	-6.258	PK

Profile: 2270411R	Page No.: 9
Engineer: Pengchengyang	
Site: AC5	Time: 2022/07/18
Limit: FCC Part15.209 RE(3m)	Margin: 0
Probe: Horn_3117_00167055(1-18GHz)	Polarity: Horizontal
EUT: Bicycle Light	Power: DC 3V
Note: Mode 1:Transmit at 2440MHz	

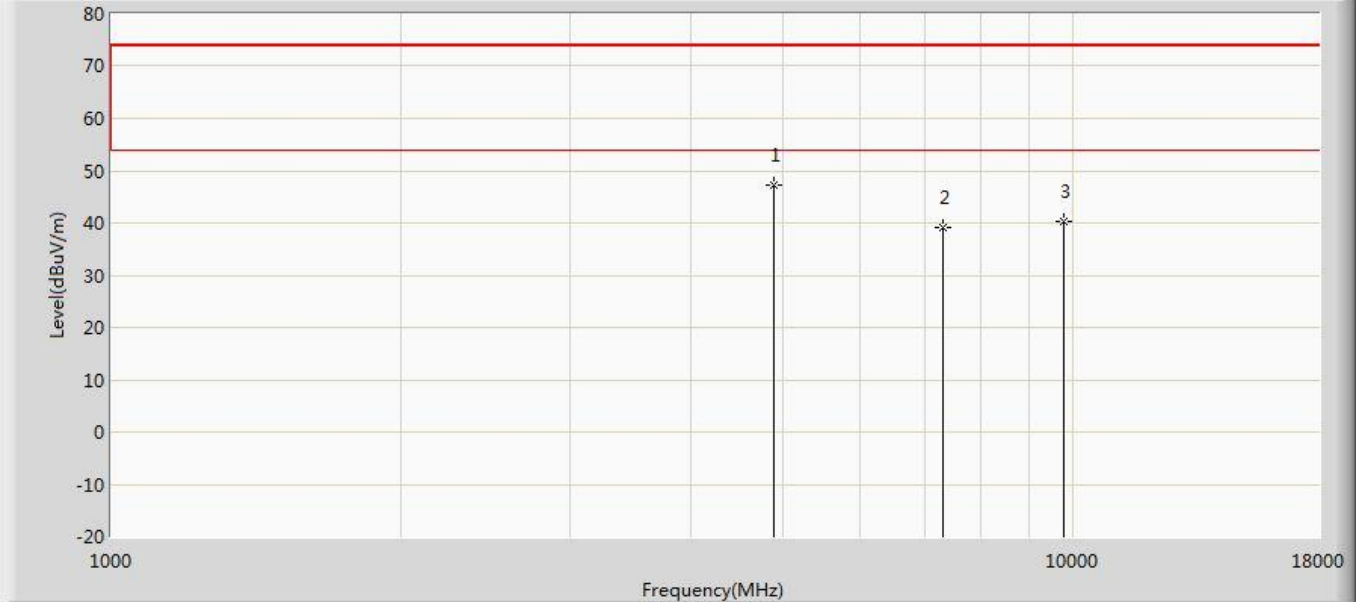

No	Mark	Frequency (MHz)	Measure Level (dBuV/m)	Reading Level (dBuV)	Over Limit (dB)	Limit (dBuV/m)	Factor (dB)	Type
1	*	4876.000	47.390	59.558	-26.610	74.000	-12.168	PK
2		7320.000	39.093	46.856	-34.907	74.000	-7.763	PK
3		9760.000	40.230	46.316	-33.770	74.000	-6.086	PK

Profile: 2270411R	Page No.: 10
Engineer: Pengchengyang	
Site: AC5	Time: 2022/07/18
Limit: FCC Part15.209 RE(3m)	Margin: 0
Probe: Horn_3117_00167055(1-18GHz)	Polarity: Vertical
EUT: Bicycle Light	Power: DC 3V
Note: Mode 1:Transmit at 2440MHz	

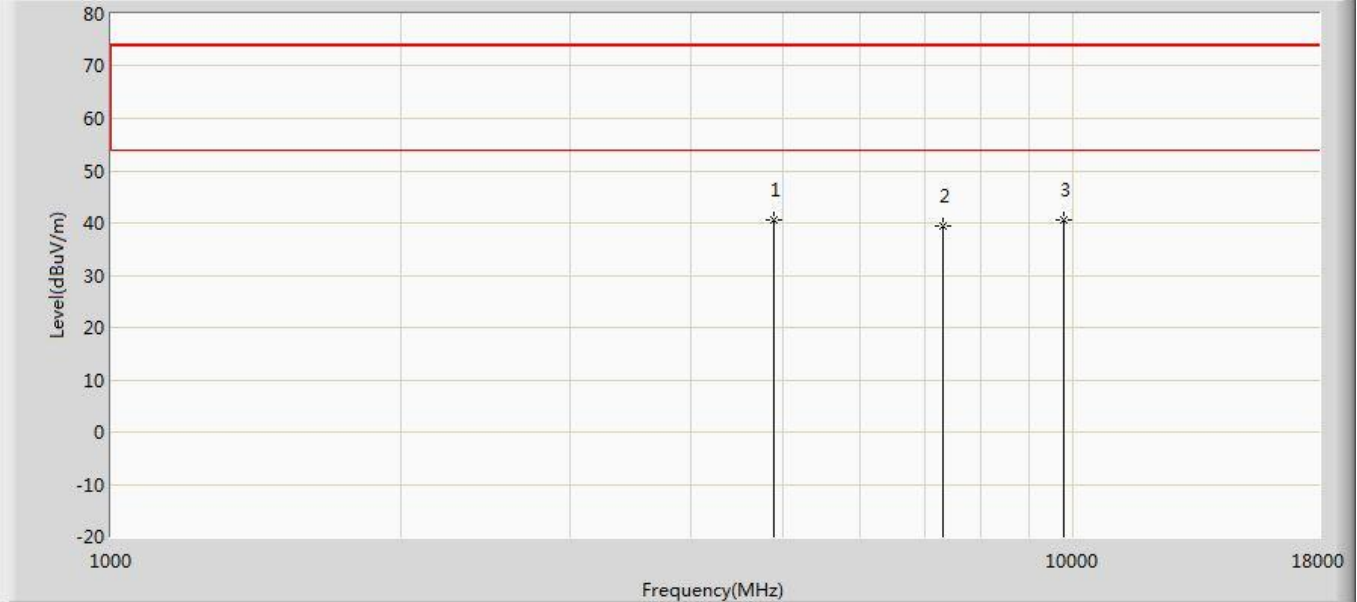

No	Mark	Frequency (MHz)	Measure Level (dBuV/m)	Reading Level (dBuV)	Over Limit (dB)	Limit (dBuV/m)	Factor (dB)	Type
1	*	4876.000	40.614	52.782	-33.386	74.000	-12.168	PK
2		7320.000	39.487	47.250	-34.513	74.000	-7.763	PK
3		9760.000	40.546	46.632	-33.454	74.000	-6.086	PK

Profile: 2270411R	Page No.: 11
Engineer: Pengchengyang	
Site: AC5	Time: 2022/07/18
Limit: FCC Part15.209 RE(3m)	Margin: 0
Probe: Horn_3117_00167055(1-18GHz)	Polarity: Horizontal
EUT: Bicycle Light	Power: DC 3V
Note: Mode 1:Transmit at 2478MHz	

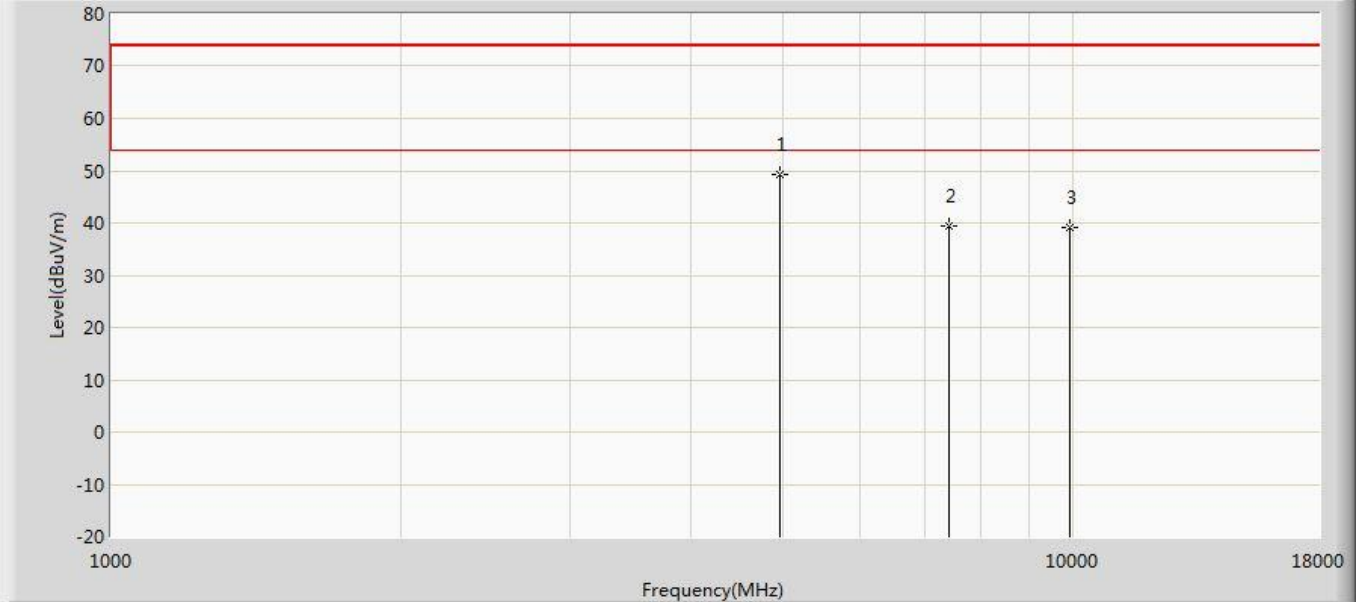

No	Mark	Frequency (MHz)	Measure Level (dBuV/m)	Reading Level (dBuV)	Over Limit (dB)	Limit (dBuV/m)	Factor (dB)	Type
1	*	4952.500	49.231	61.804	-24.769	74.000	-12.572	PK
2		7434.000	39.481	47.366	-34.519	74.000	-7.884	PK
3		9912.000	39.204	45.798	-34.796	74.000	-6.594	PK

Profile: 2270411R	Page No.: 12
Engineer: Pengchengyang	
Site: AC5	Time: 2022/07/18
Limit: FCC_Part15.209_RE(3m)	Margin: 0
Probe: Horn_3117_00167055(1-18GHz)	Polarity: Vertical
EUT: Bicycle Light	Power: DC 3V
Note: Mode 1:Transmit at 2478MHz	

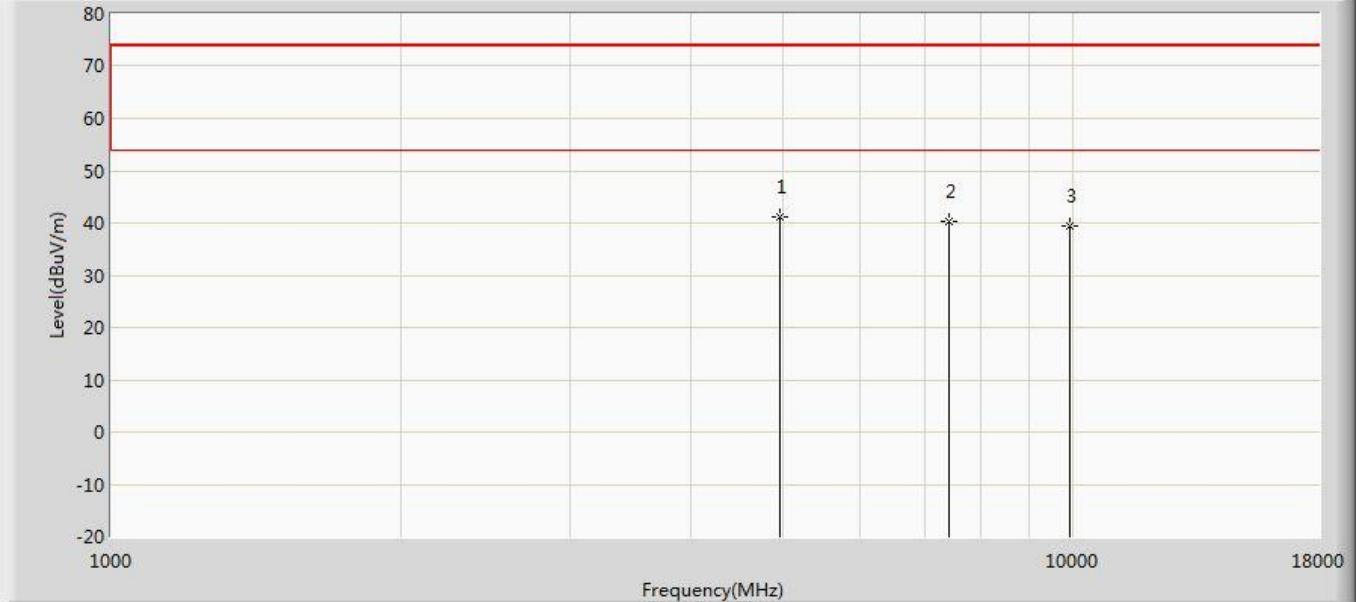

No	Mark	Frequency (MHz)	Measure Level (dBuV/m)	Reading Level (dBuV)	Over Limit (dB)	Limit (dBuV/m)	Factor (dB)	Type
1	*	4952.500	41.243	53.816	-32.757	74.000	-12.572	PK
2		7434.000	40.149	48.034	-33.851	74.000	-7.884	PK
3		9912.000	39.444	46.038	-34.556	74.000	-6.594	PK

The worst case of Radiated Emission below 1GHz:

Profile: 2270411R	Page No.: 85
Engineer: Pengchengyang	
Site: AC2	Time: 2022/07/18
Limit: FCC_Part15.109_RE(3m)_ClassB	Margin: 0
Probe: AC2_3M(30-1000M)	Polarity: Horizontal
EUT: Bicycle Light	Power: DC 3V
Note: Mode 1	

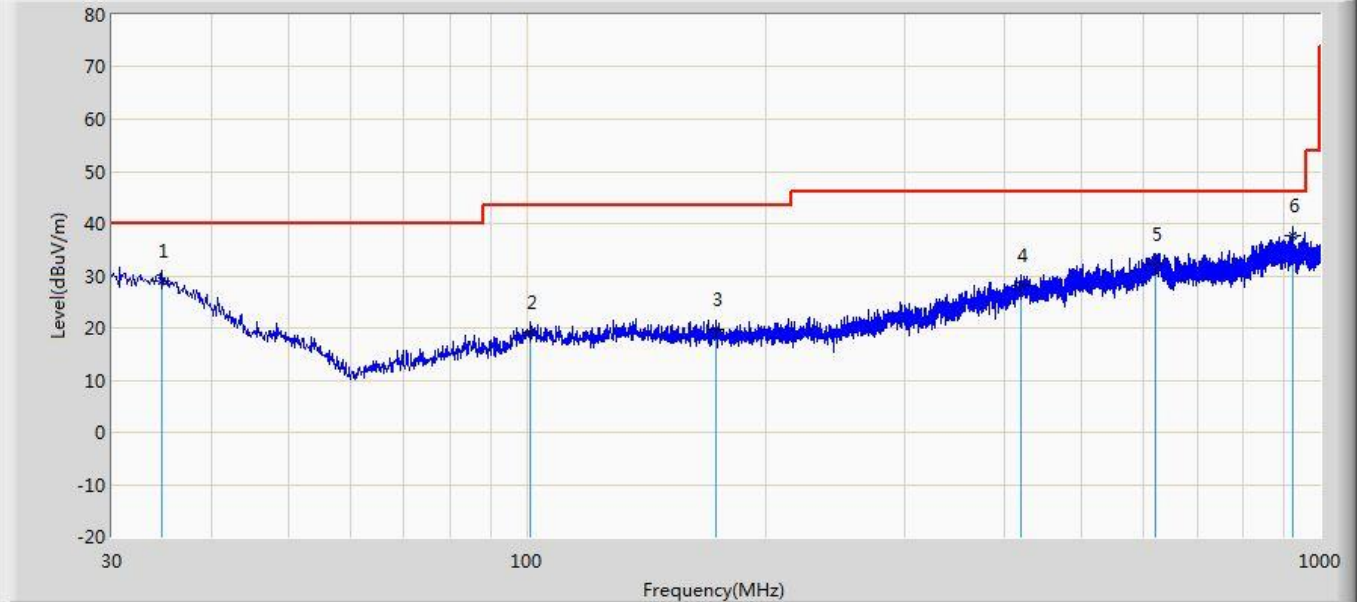

No	Mark	Frequency (MHz)	Measure Level (dBuV/m)	Reading Level (dBuV)	Over Limit (dB)	Limit (dBuV/m)	Factor (dB)	Type
1		34.729	28.870	1.823	-11.130	40.000	27.047	QP
2		101.052	19.168	2.051	-24.332	43.500	17.117	QP
3		173.318	19.587	2.433	-23.913	43.500	17.154	QP
4		420.425	28.169	1.029	-17.831	46.000	27.140	QP
5		620.245	32.187	1.408	-13.813	46.000	30.779	QP
6	*	925.552	37.537	4.945	-8.463	46.000	32.592	QP

Profile: 2270411R	Page No.: 86
Engineer: Pengchengyang	
Site: AC2	Time: 2022/07/18
Limit: FCC_Part15.109_RE(3m)_ClassB	Margin: 0
Probe: AC2_3M(30-1000M)	Polarity: Vertical
EUT: Bicycle Light	Power: DC 3V
Note: Mode 1:	

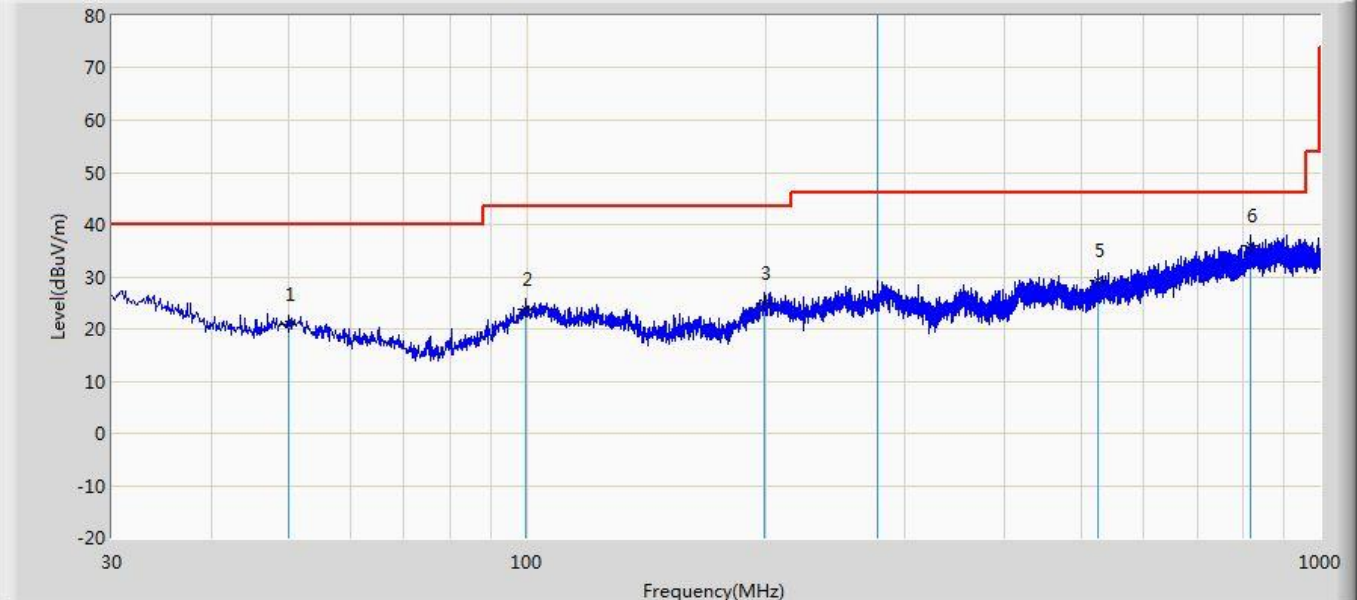

No	Mark	Frequency (MHz)	Measure Level (dBuV/m)	Reading Level (dBuV)	Over Limit (dB)	Limit (dBuV/m)	Factor (dB)	Type
1		50.006	20.736	1.294	-19.264	40.000	19.442	QP
2		99.840	23.905	2.037	-19.595	43.500	21.868	QP
3		199.023	24.973	1.738	-18.527	43.500	23.235	QP
4	*	276.622	127.258	102.912	81.258	46.000	24.346	QP
5		525.912	29.265	2.411	-16.735	46.000	26.854	QP
6		818.004	35.946	3.007	-10.054	46.000	32.939	QP

Note:

- " * ", means this data is the worst emission level.
- Measurement Level = Reading Level + Factor(Probe+Cable-Amp).
- The test frequency range, 9kHz~30MHz and Above 18GHz worst case are at least 6dB below the limits, therefore no data appear in the report.
- This limit applies for using average detector, if the test result of peak is lower than average limit, then average measurement needn't be performed.

4.3 Emissions in non-restricted frequency band	VERDICT: PASS
---	----------------------

4.3.1 Limit	
Standard	FCC Part 15 Subpart C Paragraph 15.247(d)
RF Output power (Detection methods)	Limit(dB)
RF Output power(Average detector)	30dBc(Note1)
RF Output power(PK detector)	20dBc(Note2)
<p>Note 1: If maximum conducted (average) output power was used to demonstrate compliance as described in 9.2, then the peak power in any 100 kHz bandwidth outside of the authorized frequency band shall be attenuated by at least 30 dB relative to the maximum in-band peak PSD level in 100 kHz (i.e., 30 dBc).</p> <p>Note 2: If the maximum peak conducted output power procedure was used, then the peak output power measured in any 100 kHz bandwidth outside of the authorized frequency band shall be attenuated by at least 20 dB relative to the maximum in-band peak PSD level in 100 kHz (i.e., 20 dBc).</p>	

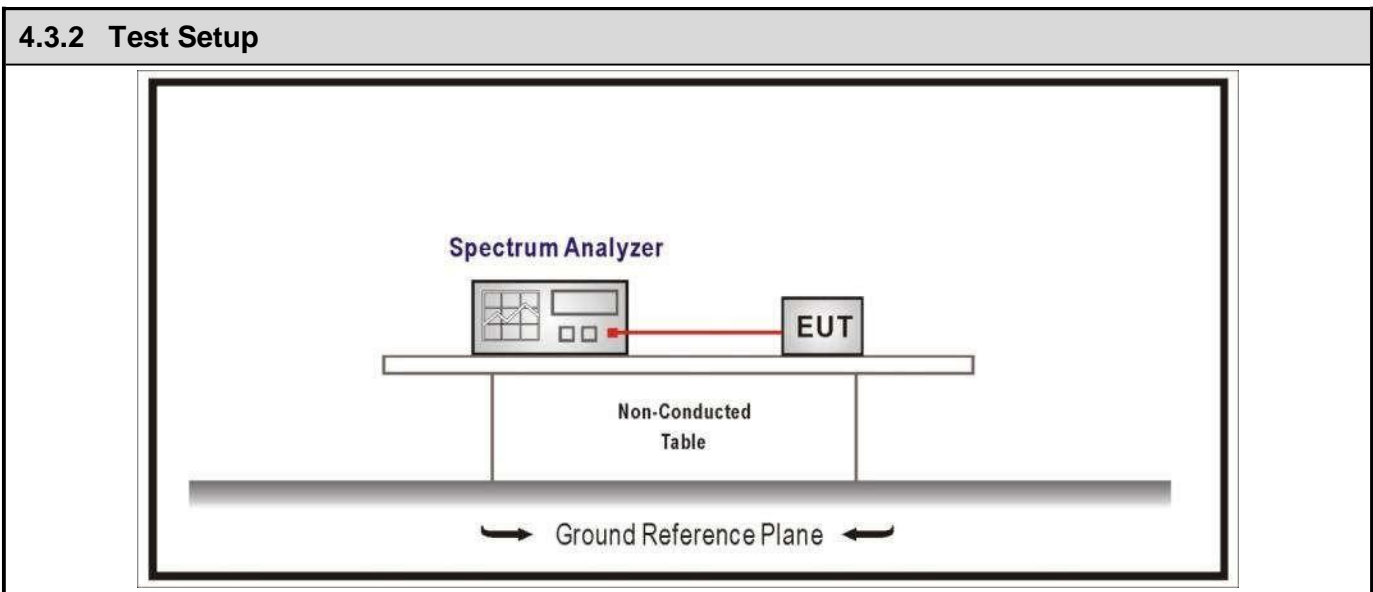

4.3.3 Test Procedure			
References Rule		Chapter	Description
<input checked="" type="checkbox"/>	ANSI C63.10	11.11	Emissions in non-restricted frequency bands
	<input checked="" type="checkbox"/>	ANSI C63.10	11.11.1 General
	<input checked="" type="checkbox"/>	ANSI C63.10	11.11.2 Reference level measurement
	<input checked="" type="checkbox"/>	ANSI C63.10	11.11.3 Emission level measurement

4.3.4 Test Data

Mode 1 2402MHz



Mode 1 2402MHz

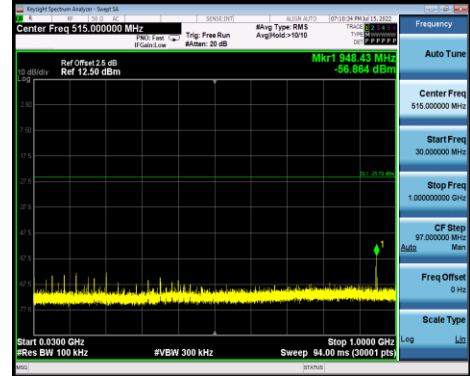

Mode 1 2402MHz

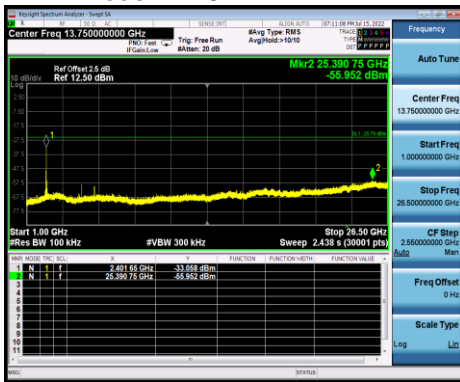

Mode 1 2440MHz



Mode 1 2440MHz

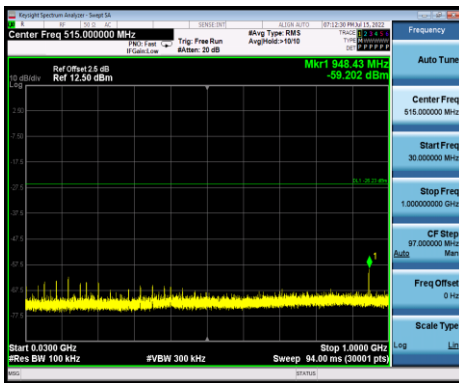

Mode 1 2440MHz



Mode 1 2478MHz



Mode 1 2478MHz

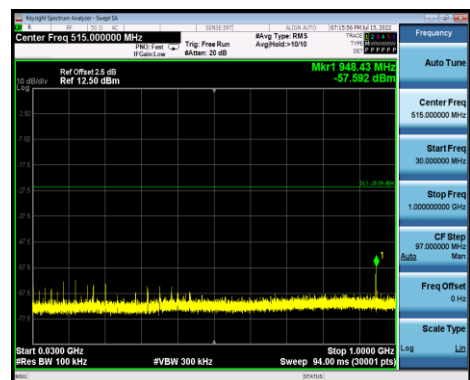

Mode 1 2478MHz

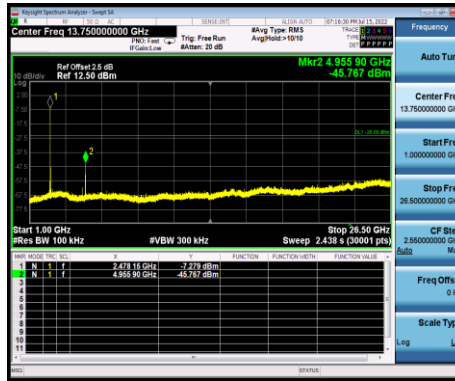

4.4 Radiated Emission Band Edge **VERDICT: PASS**

4.4.1 Limit				
Standard		FCC Part 15 Subpart C Paragraph 15.247(d) , 15.205, 15.209		
Frequency bands (MHz)	Detector	Limit (dB μ V/m)	RBW (MHz)	Distance (m)
2310-2390 2483.5-2500	PK	74	1	3
	AV	54	1	3

Note: The field strength of emissions appearing within these frequency bands shall not exceed the limits.

4.4.2 Test Setup

Above 1GHz Test Setup:

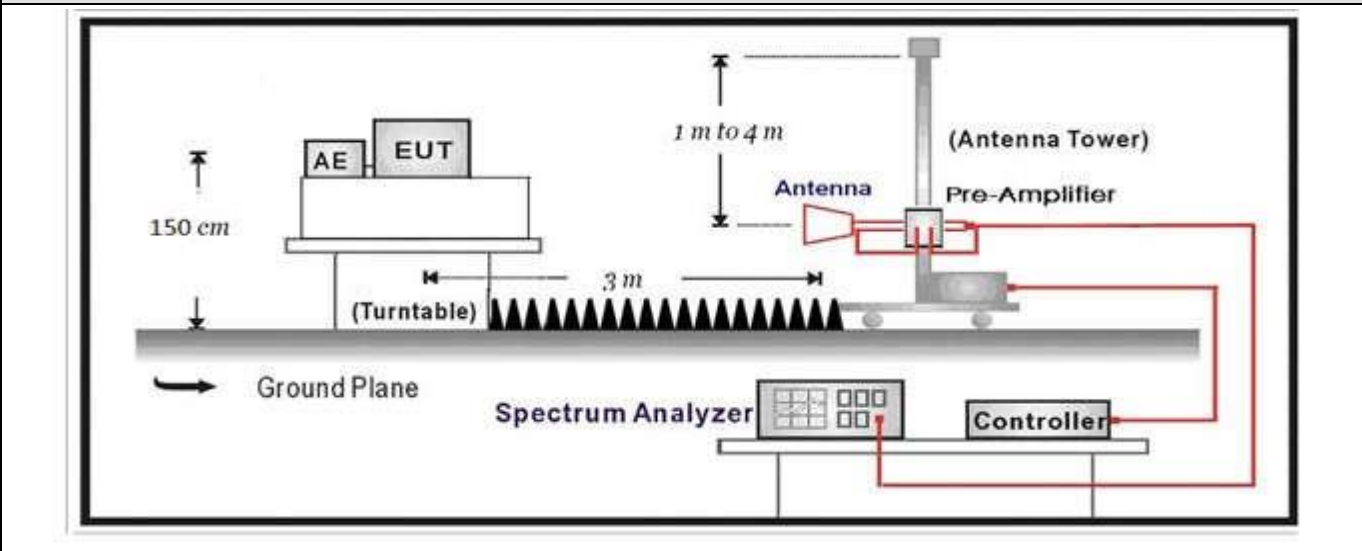

4.4.3 Test Procedure			
	References Rule	Chapter	Description
<input checked="" type="checkbox"/>	ANSI C63.10	6.10	Band-edge testing
	<input checked="" type="checkbox"/> ANSI C63.10	6.10.5	Restricted-band band-edge measurements
	<input type="checkbox"/> ANSI C63.10	6.10.6	Marker-delta method
<input checked="" type="checkbox"/>	ANSI C63.10	11.12	Emissions in restricted frequency bands
	<input checked="" type="checkbox"/> ANSI C63.10	11.12.1	Radiated emission measurements
	<input checked="" type="checkbox"/> ANSI C63.10	6.3	Radiated spurious emission test
<input type="checkbox"/>	ANSI C63.10	6.4	Radiated emissions from unlicensed wireless devices below 30 MHz
<input type="checkbox"/>	ANSI C63.10	6.5	Radiated emissions from unlicensed wireless devices in the frequency range of 30 MHz to 1000 MHz
<input checked="" type="checkbox"/>	ANSI C63.10	6.6	Radiated emissions from unlicensed wireless devices above 1 GHz
	<input type="checkbox"/> ANSI C63.10	11.12.2	Antenna-port conducted measurements
	<input type="checkbox"/> ANSI C63.10	11.12.2.3	Quasi-peak measurement procedure
	<input type="checkbox"/> ANSI C63.10	11.12.2.4	Peak power measurement procedure
	<input type="checkbox"/> ANSI C63.10	11.12.2.5	Average power measurement procedures
	<input type="checkbox"/> ANSI C63.10	11.12.2.5.1	Trace averaging with continuous EUT transmission at full power
	<input type="checkbox"/> ANSI C63.10	11.12.2.5.2	Trace averaging across ON and OFF times of the EUT transmissions followed by duty cycle correction
	<input type="checkbox"/> ANSI C63.10	11.12.2.5.3	Reduced VBW averaging across ON and OFF times of the EUT transmissions with max hold

4.4.4 Test Data

Test Mode	Tx On (ms)	VBW (kHz)	Tx On + Tx Off (ms)	Duty Cycle (%)
1	-	-	-	100

Note 1: T means the minimum transmission duration over which the transmitter is on and is transmitting at its maximum power control level for the tested mode of operation.

Note 2: According to KDB 558074, when test for Radiated Emission Band Edge and Radiated Emission, for average detector set: $VBW \geq 1/T$ will be used.

Mode 1: 2440MHz

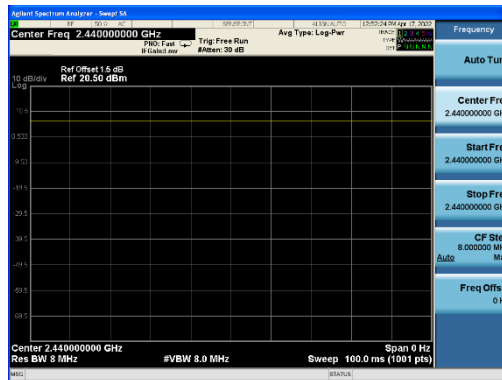

Bandedge test data:

Profile: 2270411R	Page No.: 1
Engineer: Pengchengyang	
Site: AC5	Time: 2022/07/21
Limit: FCC_Part15.209_RE(3m)	Margin: 0
Probe: Horn_3117_00167055(1-18GHz)	Polarity: Horizontal
EUT: Bicycle Light	Power: DC 3V
Note: Mode 1:Transmit at 2402MHz	

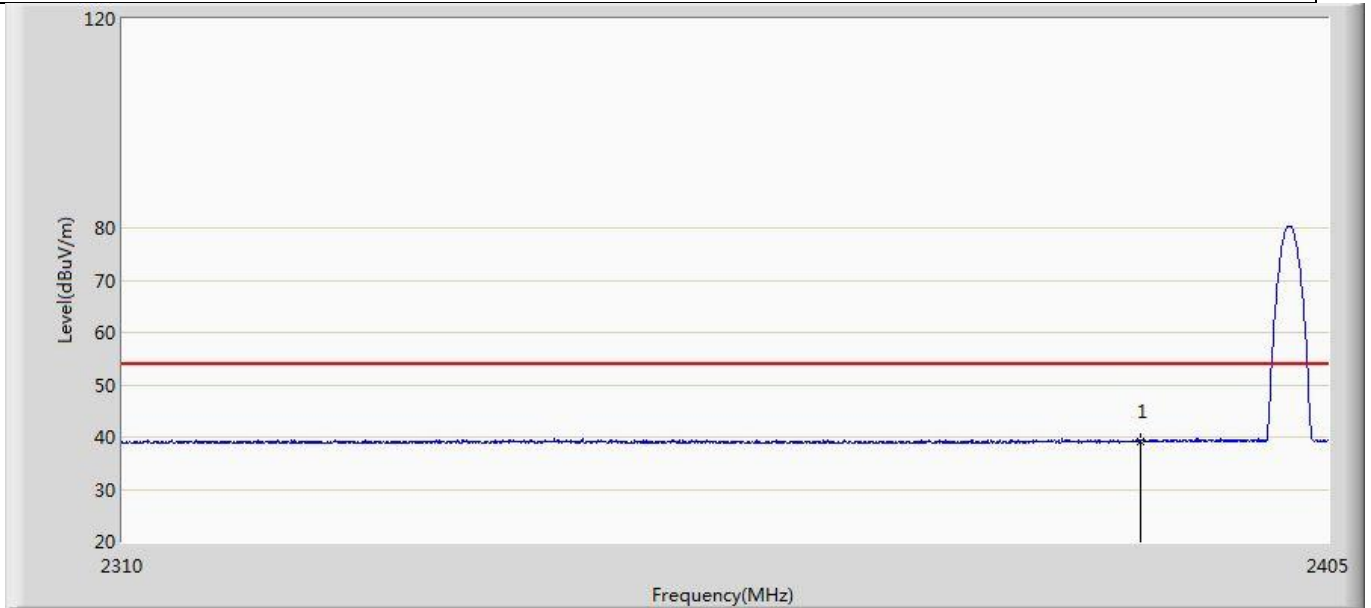

No	Mark	Frequency (MHz)	Measure Level (dBuV/m)	Reading Level (dBuV)	Over Limit (dB)	Limit (dBuV/m)	Factor (dB)	Type
1	*	2390.000	39.252	3.154	-14.748	54.000	36.098	AV

Profile: 2270411R		Page No.: 2	
Engineer: Pengchengyang			
Site: AC5		Time: 2022/07/21	
Limit: FCC Part15.209 RE(3m)		Margin: 0	
Probe: Horn_3117_00167055(1-18GHz)		Polarity: Horizontal	
EUT: Bicycle Light		Power: DC 3V	
Note: Mode 1:Transmit at 2402MHz			

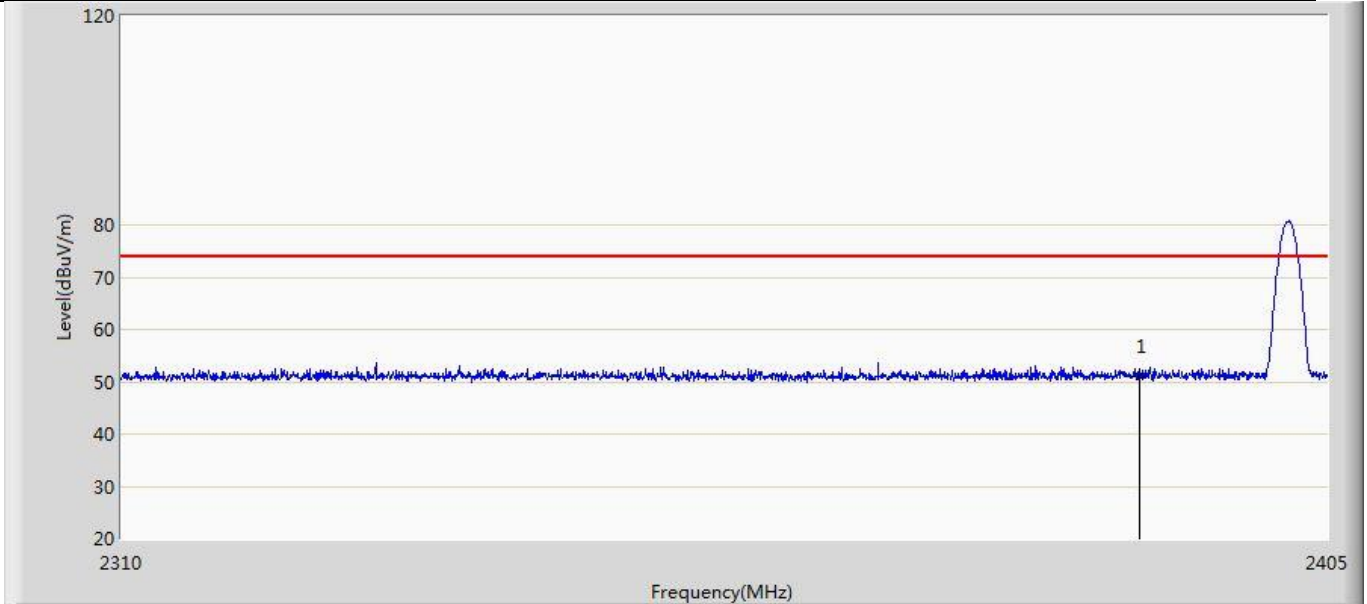

No	Mark	Frequency (MHz)	Measure Level (dBuV/m)	Reading Level (dBuV)	Over Limit (dB)	Limit (dBuV/m)	Factor (dB)	Type
1	*	2390.000	50.947	14.849	-23.053	74.000	36.098	PK

Profile: 2270411R		Page No.: 3	
Engineer: Pengchengyang			
Site: AC5		Time: 2022/07/21	
Limit: FCC Part15.209 RE(3m)		Margin: 0	
Probe: Horn_3117_00167055(1-18GHz)		Polarity: Vertical	
EUT: Bicycle Light		Power: DC 3V	
Note: Mode 1:Transmit at 2402MHz			

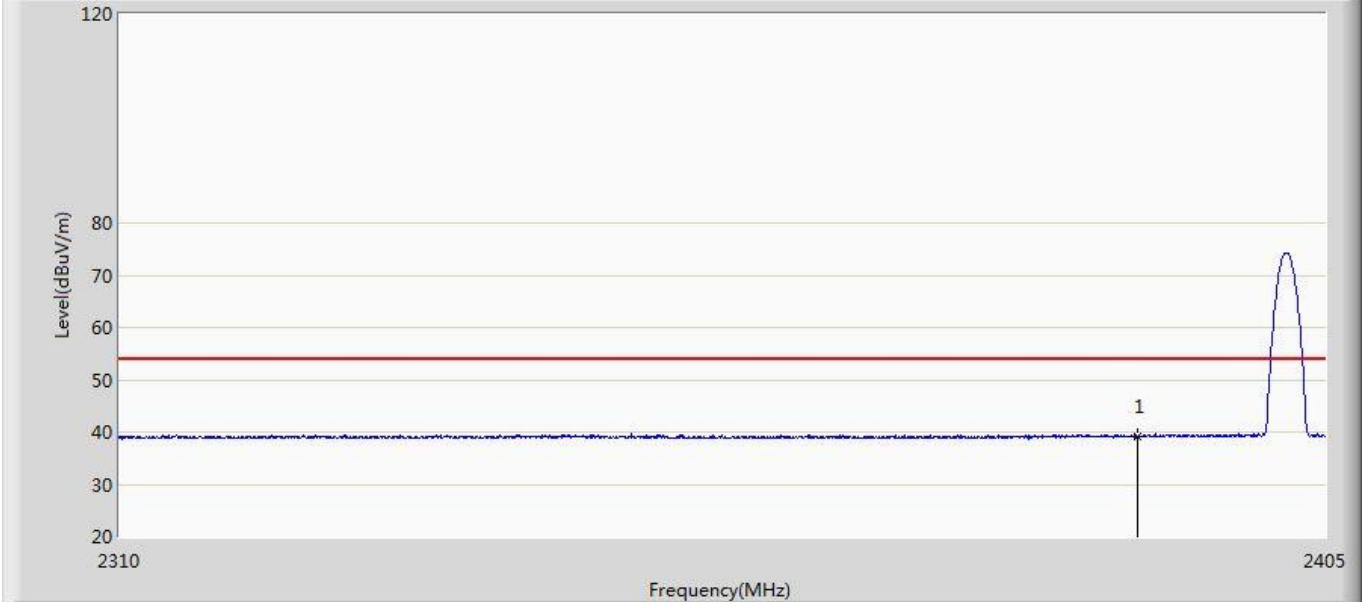

No	Mark	Frequency (MHz)	Measure Level (dBuV/m)	Reading Level (dBuV)	Over Limit (dB)	Limit (dBuV/m)	Factor (dB)	Type
1	*	2390.000	39.189	3.091	-14.811	54.000	36.098	AV

Profile: 2270411R	Page No.: 4
Engineer: Pengchengyang	
Site: AC5	Time: 2022/07/21
Limit: FCC Part15.209 RE(3m)	Margin: 0
Probe: Horn_3117_00167055(1-18GHz)	Polarity: Vertical
EUT: Bicycle Light	Power: DC 3V
Note: Mode 1:Transmit at 2402MHz	

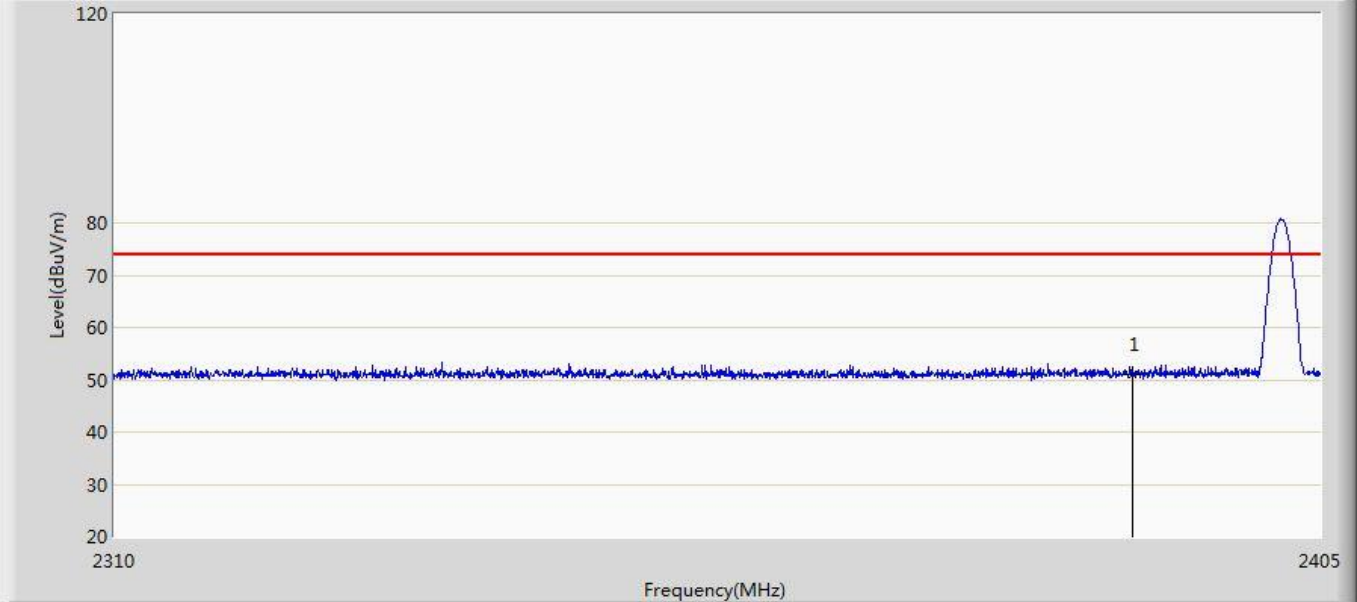

No	Mark	Frequency (MHz)	Measure Level (dBuV/m)	Reading Level (dBuV)	Over Limit (dB)	Limit (dBuV/m)	Factor (dB)	Type
1	*	2390.000	51.078	14.980	-22.922	74.000	36.098	PK

Profile: 2270411R		Page No.: 5	
Engineer: Pengchengyang			
Site: AC5		Time: 2022/07/21	
Limit: FCC Part15.209 RE(3m)		Margin: 0	
Probe: Horn_3117_00167055(1-18GHz)		Polarity: Horizontal	
EUT: Bicycle Light		Power: DC 3V	
Note: Mode 1:Transmit at 2478MHz			

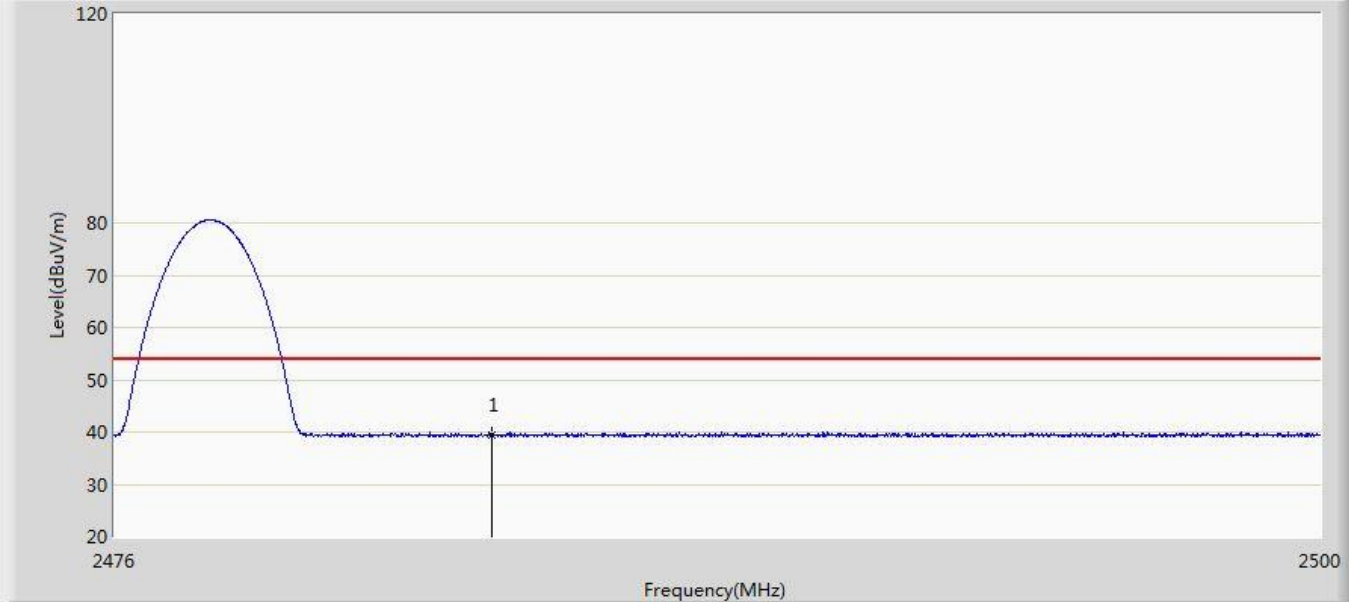

No	Mark	Frequency (MHz)	Measure Level (dBuV/m)	Reading Level (dBuV)	Over Limit (dB)	Limit (dBuV/m)	Factor (dB)	Type
1	*	2483.500	39.313	3.092	-14.687	54.000	36.220	AV

Profile: 2270411R		Page No.: 6	
Engineer: Pengchengyang			
Site: AC5		Time: 2022/07/21	
Limit: FCC Part15.209 RE(3m)		Margin: 0	
Probe: Horn_3117_00167055(1-18GHz)		Polarity: Horizontal	
EUT: Bicycle Light		Power: DC 3V	
Note: Mode 1:Transmit at 2478MHz			

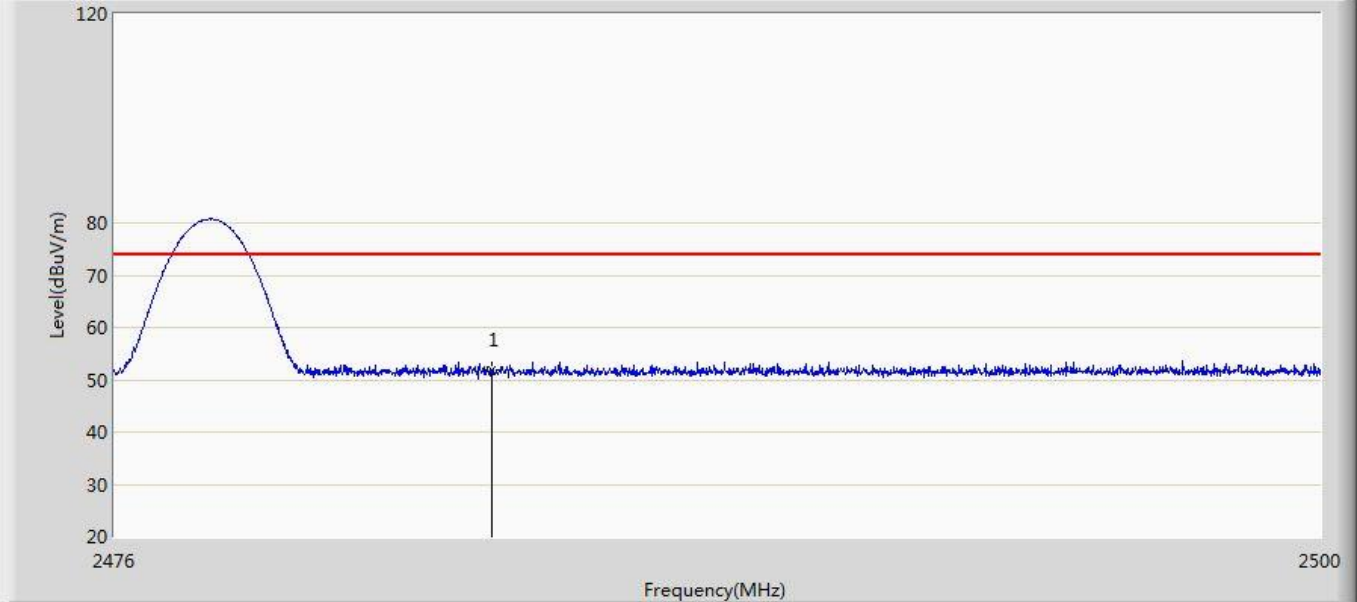

No	Mark	Frequency (MHz)	Measure Level (dBuV/m)	Reading Level (dBuV)	Over Limit (dB)	Limit (dBuV/m)	Factor (dB)	Type
1	*	2483.500	51.939	15.718	-22.061	74.000	36.220	PK

Profile: 2270411R		Page No.: 7	
Engineer: Pengchengyang			
Site: AC5		Time: 2022/07/21	
Limit: FCC Part15.209 RE(3m)		Margin: 0	
Probe: Horn_3117_00167055(1-18GHz)		Polarity: Vertical	
EUT: Bicycle Light		Power: DC 3V	
Note: Mode 1:Transmit at 2478MHz			

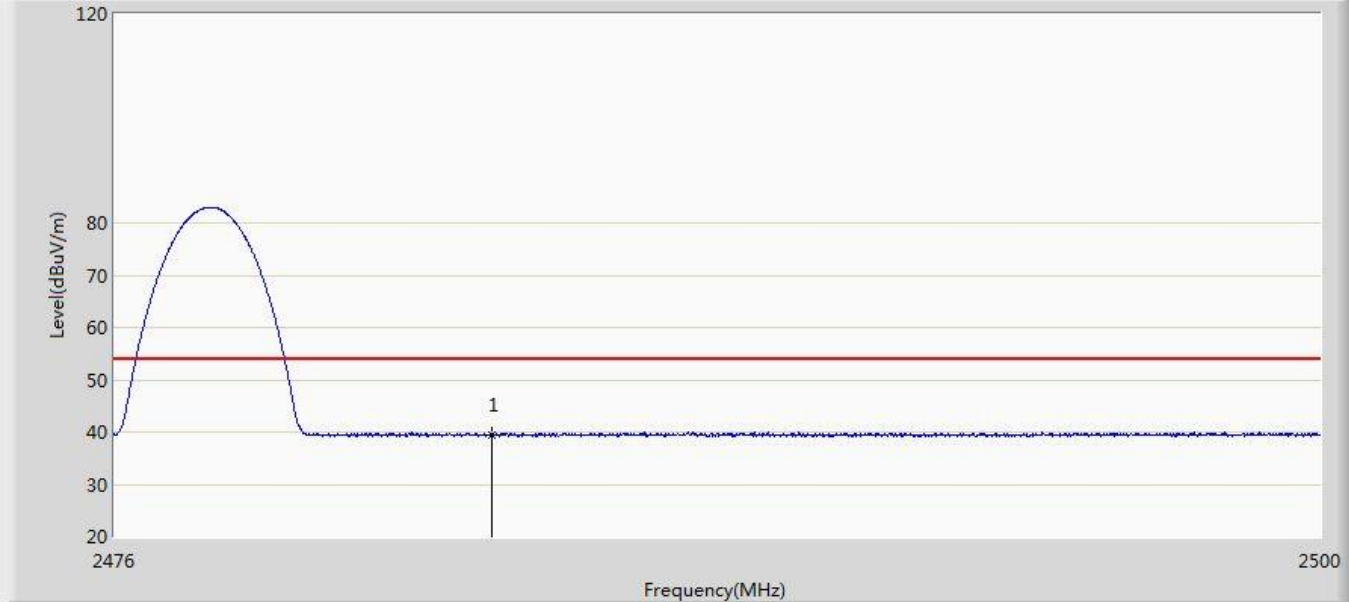

No	Mark	Frequency (MHz)	Measure Level (dBuV/m)	Reading Level (dBuV)	Over Limit (dB)	Limit (dBuV/m)	Factor (dB)	Type
1	*	2483.500	39.477	3.256	-14.523	54.000	36.220	AV

Profile: 2270411R	Page No.: 8
Engineer: Pengchengyang	
Site: AC5	Time: 2022/07/21
Limit: FCC Part15.209 RE(3m)	Margin: 0
Probe: Horn_3117_00167055(1-18GHz)	Polarity: Vertical
EUT: Bicycle Light	Power: DC 3V
Note: Mode 1:Transmit at 2478MHz	

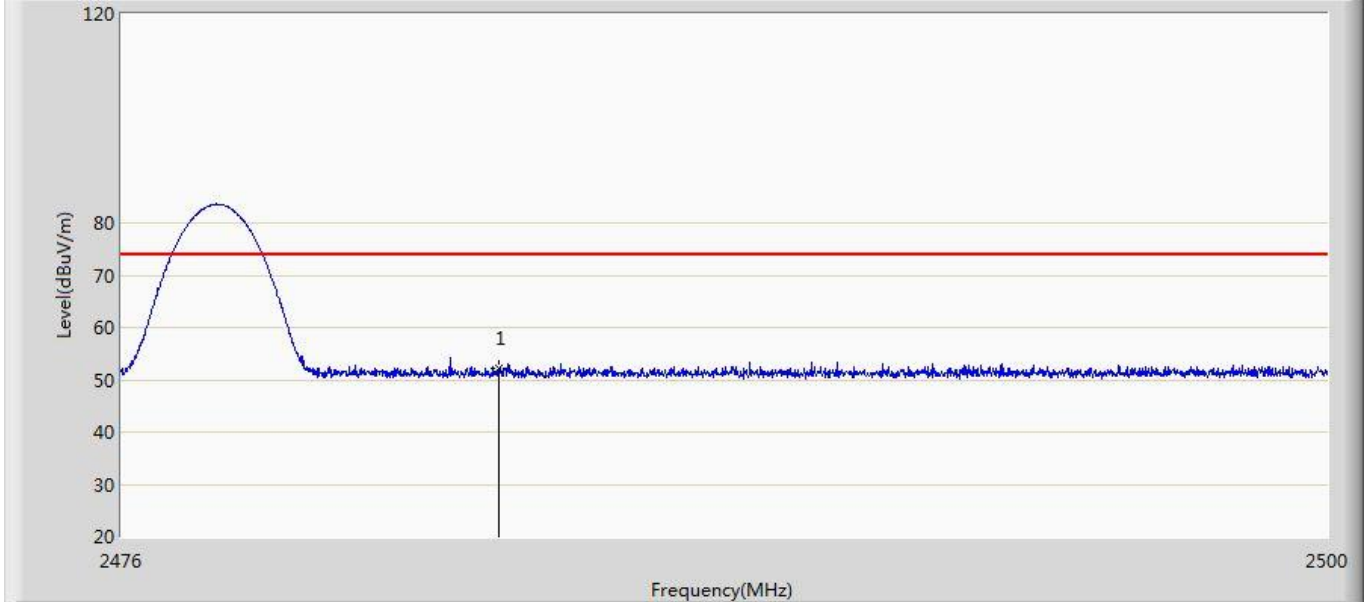

No	Mark	Frequency (MHz)	Measure Level (dBuV/m)	Reading Level (dBuV)	Over Limit (dB)	Limit (dBuV/m)	Factor (dB)	Type
1	*	2483.500	52.104	15.883	-21.896	74.000	36.220	PK

Note:

1. " * ", means this data is the worst emission level.
2. Measurement Level = Reading Level + Factor(Probe+Cable-Amp).

4.5 DTS Bandwidth	VERDICT: PASS
--------------------------	----------------------

4.5.1 Limit	
Standard	FCC Part 15 Subpart C Paragraph 15.247 (a)(2)
Systems using digital modulation techniques operate in the 2400-2483.5 MHz. The minimum 6 dB bandwidth shall be at least 500 kHz	
Standard	ANSI C63.10 Paragraph 6.7
The occupied bandwidth or the “99% emission bandwidth” is defined as the frequency range between two points, one above and the other below the carrier frequency, within which 99% of the total transmitted power of the fundamental transmitted emission is contained. The occupied bandwidth shall be reported for all equipment in addition to the specified bandwidth required in the applicable RSSs. The occupied bandwidth should be within the required frequency range.	

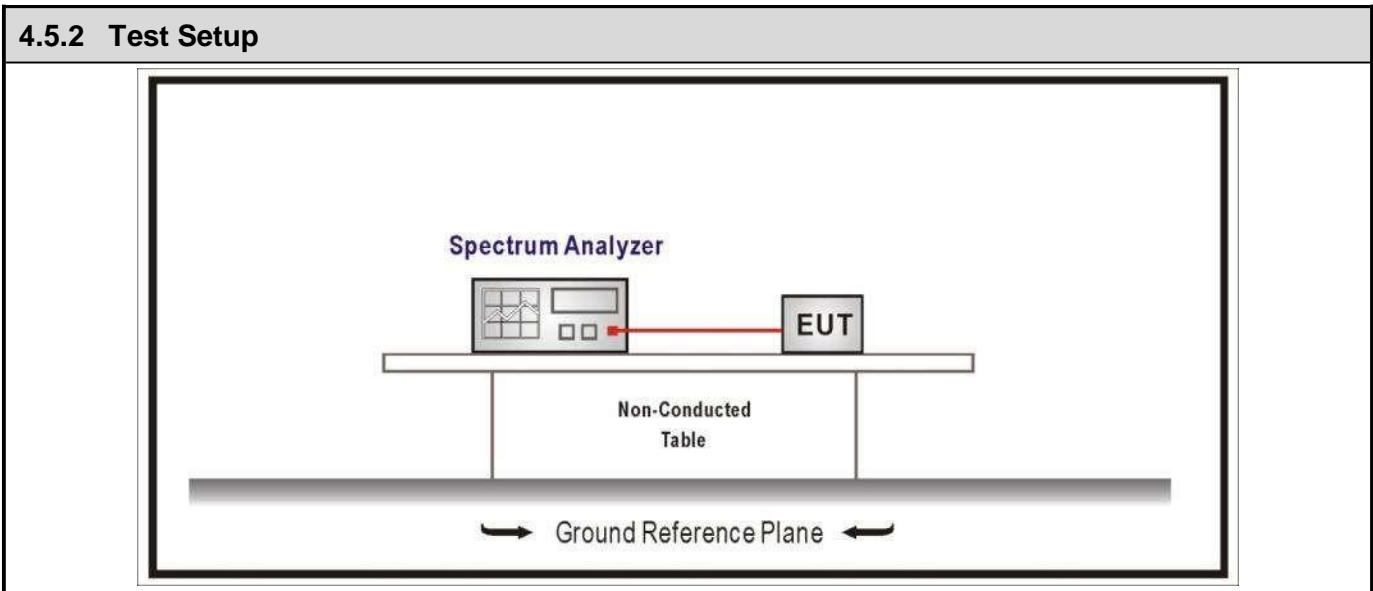

4.5.3 Test Procedure			
	Reference Rule	Chapter	Description
<input checked="" type="checkbox"/>	ANSI C63.10	11.8	DTS bandwidth
<input type="checkbox"/>	ANSI C63.10	11.8.1	Option 1
<input checked="" type="checkbox"/>	ANSI C63.10	11.8.2	Option 2
<input checked="" type="checkbox"/>	ANSI C63.10	6.9	Occupied bandwidth
<input type="checkbox"/>	ANSI C63.10	6.9.2	relative measurement procedure
<input checked="" type="checkbox"/>	ANSI C63.10	6.9.3	power bandwidth (99%) measurement procedure

4.5.4 Test Data

Mode	Test Freq. (MHz)	99% Occupied Bandwidth (MHz)	6dB Occupied Bandwidth (MHz)	Limit (kHz)	Result
1	2402	1.077	0.628	≥500	Pass
	2440	1.088	0.636	≥500	Pass
	2478	1.086	0.576	≥500	Pass

Note: The worst case of Occupied Bandwidth as below:

6dB Occupied Bandwidth
Mode 1 2440MHz



99% Occupied Bandwidth
Mode 1 2440MHz



4.6 Fundamental emission output power	VERDICT: PASS
--	----------------------

4.6.1 Limit		
Standard	FCC Part 15 Subpart C Paragraph 15.247 (b)(3)	
<input checked="" type="checkbox"/> GTX < 6dBi	Pout≤30dBm	
<input type="checkbox"/> GTX > 6dBi		
<input type="checkbox"/> Non-Fix point-point	Pout≤30-(GTX -6)	
<input type="checkbox"/> Fix point-point	Pout≤30-[(GTX-6)]/3	
<input type="checkbox"/> Point-to-multipoint	Pout≤30-(GTX-6)	
<input type="checkbox"/> Overlap Beams	Pout≤30-[(GTX-6)]/3	
<input type="checkbox"/> Aggregate power transmitted simultaneously on all beams	Pout≤30-[(GTX-6)]/3	
<input type="checkbox"/> single directional beam	Pout≤30-[(GTX-6)]/3+8dB	

Note 1 : GTX directional gain of transmitting antennas.
 Note 2 : Pout is maximum peak conducted output power .

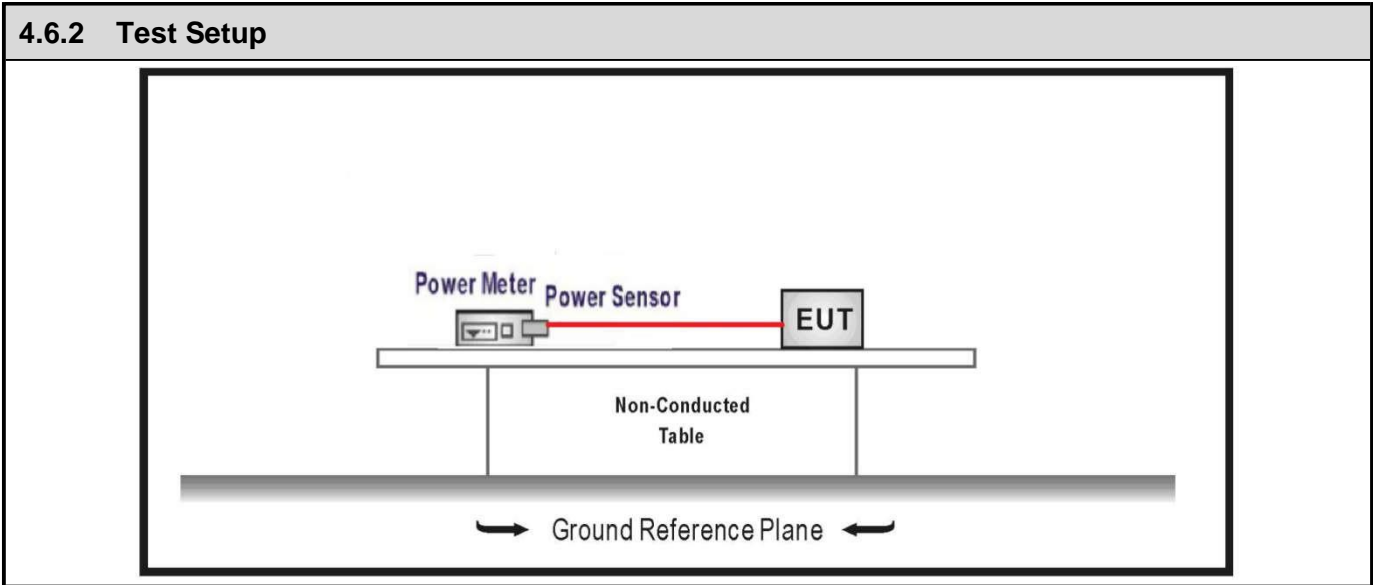

4.6.3 Test Procedure						
	References Rule		Chapter	Description		
<input checked="" type="checkbox"/>	ANSI C63.10		11.9	Fundamental emission output power		
	<input checked="" type="checkbox"/>	ANSI C63.10	11.9.1	Maximum peak conducted output power		
	<input type="checkbox"/>	<input type="checkbox"/>	ANSI C63.10	11.9.1.1	RBW \geq DTS bandwidth	
		<input type="checkbox"/>	ANSI C63.10	11.9.1.2	Integrated band power method	
		<input checked="" type="checkbox"/>	ANSI C63.10	11.9.1.3	PKPM1 Peak power meter method	
	<input type="checkbox"/>	ANSI C63.10		11.9.2	Maximum conducted (average) output power	
	<input type="checkbox"/>	<input type="checkbox"/>	ANSI C63.10	11.9.2.2	Measurement using a spectrum analyzer (SA)	
		<input type="checkbox"/>	<input type="checkbox"/>	ANSI C63.10	11.9.2.2.2	Method AVGSA-1(Duty cycle \geq 98%)
			<input type="checkbox"/>	ANSI C63.10	11.9.2.2.3	Method AVGSA-1A(Duty cycle \geq 98%)
			<input type="checkbox"/>	ANSI C63.10	11.9.2.2.4	Method AVGSA-2(Duty cycle \leq 98%)
			<input type="checkbox"/>	ANSI C63.10	11.9.2.2.5	Method AVGSA-2A(Duty cycle \leq 98%)
			<input type="checkbox"/>	ANSI C63.10	11.9.2.2.4	Method AVGSA-3
			<input type="checkbox"/>	ANSI C63.10	11.9.2.2.5	Method AVGSA-3A
		<input type="checkbox"/>	ANSI C63.10	11.9.2.3	Measurement using a power meter (PM)	
		<input type="checkbox"/>	<input type="checkbox"/>	ANSI C63.10	11.9.2.3.1	Method AVGPM
	<input type="checkbox"/>		ANSI C63.10	11.9.2.3.2	Method AVGPM-G	

4.6.4 Test Data

Mode	Test Frequency (MHz)	Conducted Power (dBm)	EIRP (dBm)	Conducted Power Limit (dBm)	EIRP Limit (dBm)	Result
Mode 1	2402	-5.37	-5.37	≤30	≤36	Pass
	2440	-5.47	-5.47	≤30	≤36	Pass
	2478	-5.63	-5.63	≤30	≤36	Pass

4.7 Power Density	VERDICT: PASS
--------------------------	----------------------

4.7.1 Limit:

Standard	FCC Part 15 Subpart C Paragraph 15.247 (e)
Power Spectral Density ≤ 8dBm/3kHz	

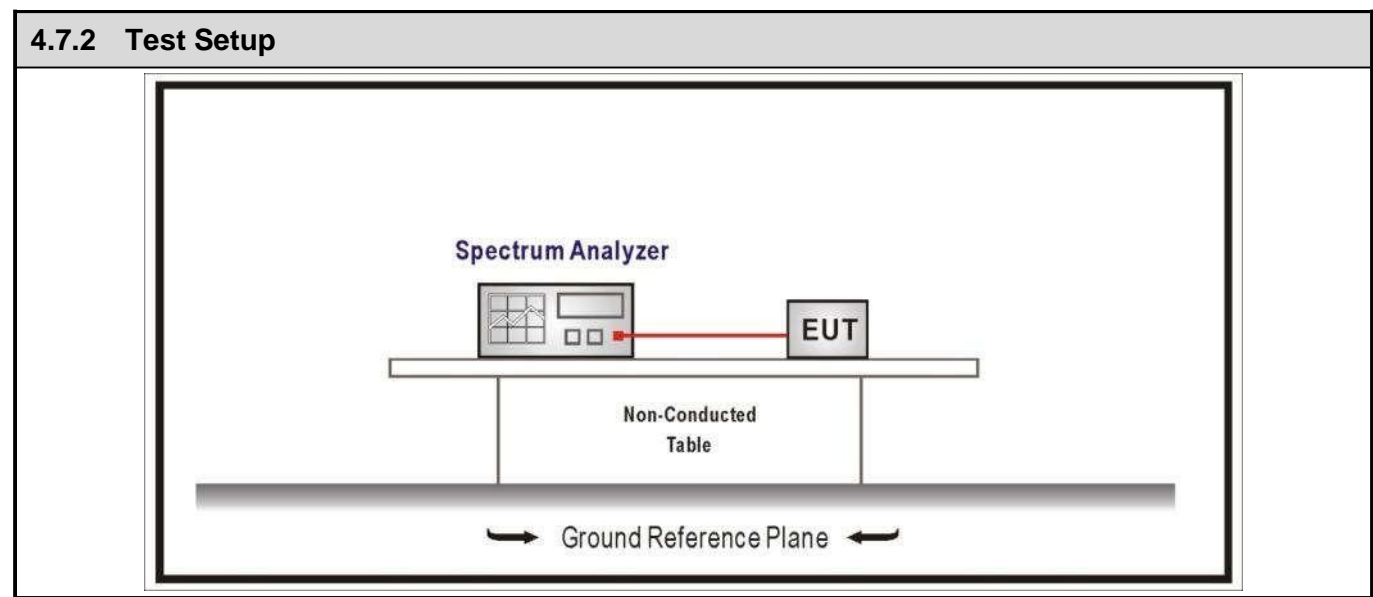

4.7.3 Test Procedure

	References Rule	Chapter	Description
<input checked="" type="checkbox"/>	ANSI C63.10	11.10	Maximum power spectral density level in the fundamental emission
<input checked="" type="checkbox"/>	ANSI C63.10	11.10.2	Method PKPSD (peak PSD)
<input type="checkbox"/>	ANSI C63.10	11.10.3	Method AVGPSD-1(Duty cycle ≥ 98%)
<input type="checkbox"/>	ANSI C63.10	11.10.4	Method AVGPSD-1A(Duty cycle ≥ 98%)
<input type="checkbox"/>	ANSI C63.10	11.10.5	Method AVGPSD-2(Duty cycle < 98%)
<input type="checkbox"/>	ANSI C63.10	11.10.6	Method AVGPSD-2A(Duty cycle < 98%)
<input type="checkbox"/>	ANSI C63.10	11.10.7	Method AVGPSD-3
<input type="checkbox"/>	ANSI C63.10	11.10.8	Method AVGPSD-3A

4.7.4 Test Data				
Mode	Test Frequency (MHz)	Measurement PSD (dBm/3kHz)	Limit (dBm/3kHz)	Result
1	2402	-20	≤8	Pass
	2440	-19.77	≤8	Pass
	2478	-20.61	≤8	Pass

Note: The worst case of PSD as below:

Mode 1 2440MHz



4.8 Antenna Requirement	VERDICT: PASS
--------------------------------	----------------------

4.8.1 Limit:	
Standard	FCC Part 15 Subpart C Paragraph 15.203
<p>An intentional radiator shall be designed to ensure that no antenna other than that furnished by the responsible party shall be used with the device. The use of a permanently attached antenna or of an antenna that uses a unique coupling to the intentional radiator shall be considered sufficient to comply with the provisions of this section. The manufacturer may design the unit so that a broken antenna can be replaced by the user, but the use of a standard antenna jack or electrical connector is prohibited. This requirement does not apply to carrier current devices or to devices operated under the provisions of §15.211, §15.213, §15.217, §15.219, or §15.221. Further, this requirement does not apply to intentional radiators that must be professionally installed, such as perimeter protection systems and some field disturbance sensors, or to other intentional radiators which, in accordance with §15.31(d), must be measured at the installation site. However, the installer shall be responsible for ensuring that the proper antenna is employed so that the limits in this part are not exceeded.</p>	

4.8.2 Antenna Connector Construction:	
<input checked="" type="checkbox"/>	The use of a permanently attached antenna
<input type="checkbox"/>	The antenna use of a unique coupling to the intentional radiator
<input type="checkbox"/>	The use of a nonstandard antenna jack or electrical connector
Please refer to the attached document "Internal Photograph" to show the antenna connector.	

5 TEST SETUP PHOTO AND EUT PHOTO

ReMark: The test setup photo and EUT Photo please see appendix.

_____ The End _____