



CMA Testing and Certification Laboratories

廠商會檢定中心

TEST REPORT

Report No. : AR0017683(3) Date : 16 Apr 2013

Application No. : LR007502(3)

Client : Kid Galaxy Inc
150 Dow Street,
Unit 425B Manchester, nh03101

Sample Description : One(1) item of submitted sample stated to be :

Sample Description	Model number
Killer Whale	10168
Morphibians—shark / Gator / Rover / exploer / Frog / Stingray / Cobra / Viper	10125 / 10126 / 10162 / 10163 / 10112 / 10151 / 10118 / 10192

Sample registration no. : RR009272-001
Radio Frequency : 27.145MHz Transmitter
Rating : 2 x 1.5V AAA size batteries
No. of submitted sample : Two (2) piece (s)

Date Received : 19 Mar 2013

Test Period : 22 Mar 2013 to 10 Apr 2013

Test Requested : FCC Part 15 Certification.

Test Method : 47 CFR Part 15 (10-1-10 Edition)
ANSI C63.4 – 2009

Test Result : See attached sheet(s) from page 2 to 26.

Conclusion : The submitted sample was found to comply with requirement of FCC Part 15 Subpart C.

Remark : All nine models are the same in circuitry and components; and therefore model 10168 was chosen to be the representative of the test sample. The difference between the tested model and the declared model(s) is/are the model number, color and sample description.

For and on behalf of
CMA Industrial Development Foundation Limited

Authorized Signature : _____

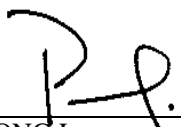
Mr. WONG Lap-pong, Andrew
Assistant Manager
Electrical Division

Page 1 of 26

FCC ID: QEA-E097-27T



**CMA Testing
and Certification
Laboratories**
廠商會檢定中心 **TEST REPORT**

Report No. : AR0017683(3)

Date : 16 Apr 2013

Table of Contents

1	General Information.....	3
1.1	General Description	3
1.2	Location of the test site	4
1.3	List of measuring equipment.....	5
1.4	Measurement Uncertainty.....	5
2	Description of the radiated emission test	6
2.1	Test Procedure	6
2.2	Test Result	6
2.3	Radiated Emission Measurement Data	7
3	Description of the Line-conducted Test.....	8
3.1	Test Procedure	8
3.2	Test Result	8
3.3	Graph and Table of Conducted Emission Measurement Data	8
4	Photograph	9
4.1	Photographs of the Test Setup for Radiated Emission and Conducted Emission	9
4.2	Photographs of the External and Internal Configurations of the EUT	9
5	Supplementary document.....	10
5.1	Bandwidth.....	10
5.2	Duty cycle	10
5.3	Transmission time.....	11
6	Appendices.....	12



CMA Testing and Certification Laboratories

廠商會檢定中心

TEST REPORT

Report No. : AR0017683(3)

Date : 16 Apr 2013

1 General Information

1.1 General Description

The equipment under test (EUT) is a transmitter for Morphibians RC car. It operates at 27.145MHz and the oscillation of radio control is generated by a crystal. The EUT is powered by 2 x 1.5V AAA size batteries. There are four buttons on the EUT. When the buttons are pressed, it will transmit radio control signal to receiver.

The antenna is permanently attached in EUT and the radio output power is unable to adjust.

The brief circuit description is listed as follows:

- S1, S2 and its associated circuit act as power circuit.
- R2, R3, R4, R5, R6, R7, D1, C3, C4 and its associated circuit act as encoding circuit
- R8, R9, Q3, C7, C6, X1, C5, L1, R10 and its associated circuit act as 27.145MHz high frequency oscillatory circuit
- R11, C8, C11, Q4, R12, L2, C10, C12, L3, C13, L4 and its associated circuit act as modulator and amplifier circuit



CMA Testing and Certification Laboratories

廠商會檢定中心

TEST REPORT

Report No. : AR0017683(3)

Date : 16 Apr 2013

1.2 Location of the test site

FCC Registered Test Site Number: 552221

Radiated emissions measurements are investigated and taken pursuant to the procedures of ANSI C63.4 – 2009. A Semi-Anechoic Chamber Testing Site is set up for investigation and located at:

Ground Floor, Yan Hing Centre,
9 – 13 Wong Chuk Yeung Street,
Fo Tan, Shatin,
New Territories,
Hong Kong.

Conducted emissions measurements are investigated and also taken pursuant to the procedures of ANSI C63.4 – 2009. A shielded room is located at :

Ground Floor, Yan Hing Centre,
9 – 13 Wong Chuk Yeung Street,
Fo Tan, Shatin,
New Territories,
Hong Kong.



CMA Testing and Certification Laboratories

廠商會檢定中心

TEST REPORT

Report No. : AR0017683(3)

Date : 16 Apr 2013

1.3 List of measuring equipment

Equipment	Manufacturer	Model No.	Serial No.	Calibration Due Date
EMI Test Receiver	R&S	ESCI	100152	28 May 2013
Broadband Antenna	Schaffner	CBL6112B	2718	16 Jan 2014
Loop Antenna	EMCO	6502	00056620	15 Sep 2013
Coaxial Cable	Schaffner	RG 213/U	N/A	28 May 2013
Coaxial Cable	Schaffner	RG 214/U	N/A	28 May 2013

1.4 Measurement Uncertainty

The reported uncertainty is based on a standard uncertainty multiplied by a coverage factor $k=2$, providing a level of confidence of approximately 95%.

Radiated emissions

Frequency	Uncertainty (U_{lab})
30MHz ~ 200MHz (Horizontal)	4.83dB
30MHz ~ 200MHz (Vertical)	4.84dB
200MHz ~1000MHz (Horizontal)	4.66dB
200MHz ~1000MHz (Vertical)	4.65dB

Conducted emissions

Frequency	Uncertainty (U_{lab})
150kHz~30MHz	3.02dB



CMA Testing and Certification Laboratories

廠商會檢定中心

TEST REPORT

Report No. : AR0017683(3)

Date : 16 Apr 2013

2 Description of the radiated emission test

2.1 Test Procedure

Radiated emissions measurements are investigated and taken pursuant to the procedures of ANSI C63.4 – 2009.

The equipment under test (EUT) was placed on a non-conductive turntable with dimensions of 1.5m x 1m and 0.8m high above the ground. 3m from the EUT, a broadband antenna mounting on the mast received the signal strength. The turntable was rotated to maximize the emission level. The antenna was then moving along the mast from 1m up to 4m until no more higher value was found. Both horizontal and vertical polarization of the antenna were placed and investigated.

For below 30MHz, a loop antenna with its vertical plane is placed 3m from the EUT and rotated about its vertical axis for maximum response at each azimuth about the EUT. And the centre of the loop shall be 1 m above the ground.

The device was rotated through three orthogonal axes to determine which attitude and configuration produce the highest emission during measurement for Radiated Emission measurement.

2.2 Test Result

Peak Detector data was measured unless otherwise stated.

“#” means emissions appearing within the restricted bands shall follow the requirement of section 15.205.

The frequencies from fundamental up to the tenth harmonics were investigated, and emissions more 20dB below limit were not reported. Thus, those highest emissions were presented in next page (section 2.3).

It was found that the EUT meet the FCC requirement.



CMA Testing and Certification Laboratories

廠商會檢定中心

TEST REPORT

Report No. : AR0017683(3)

Date : 16 Apr 2013

2.3 Radiated Emission Measurement Data

Radiated emission

pursuant to

the requirement of FCC Part 15 subpart C

Environmental conditions:

Parameter	Recorded value	
Ambient temperature:	23	° C
Relative humidity:	75	%

Detector: Peak (Fundamental frequency), Quasi-peak (outside operation band)

RBW: 120kHz

VBW: 300kHz

Frequency (MHz)	Polarity (H/V)	Reading at 3m (dBµV)	Antenna Factor and Cable Loss (dB/m)	Average Factor (dB)	Field Strength at 3m (dBµV/m)	Limit at 3m (dBµV/m)	Margin (dB)
27.146	V	68.8	9.9	- 5.4	73.3	80.0	- 6.7
54.297	V	15.7	10.2	-	25.9	40.0	- 14.1
81.445	V	9.5	8.6	-	18.1	40.0	- 21.9
# 108.516	V	10.2	12.4	-	22.6	43.5	- 20.9
# 135.775	V	9.2	14.7	-	23.9	43.5	- 19.6
# 162.829	V	8.9	12.0	-	20.9	43.5	- 22.6
190.016	V	9.8	11.2	-	21.0	43.5	- 22.5
217.064	V	10.1	11.9	-	22.0	46.0	- 24.0
244.278	V	12.0	11.9	-	23.9	46.0	- 22.1
271.514	V	9.3	15.0	-	24.3	46.0	- 21.7



CMA Testing and Certification Laboratories

廠商會檢定中心

TEST REPORT

Report No. : AR0017683(3)

Date : 16 Apr 2013

3 Description of the Line-conducted Test

3.1 Test Procedure

Conducted emissions measurements are investigated and also taken pursuant to the procedures of ANSI C63.4 – 2009. The EUT was setup as described in the procedures, and both lines were measured.

3.2 Test Result

No measurement is required as the EUT is a battery-operated product.

3.3 Graph and Table of Conducted Emission Measurement Data

Not Applicable



CMA Testing and Certification Laboratories

廠商會檢定中心

TEST REPORT

Report No. : AR0017683(3)

Date : 16 Apr 2013

4 Photograph

4.1 Photographs of the Test Setup for Radiated Emission and Conducted Emission

For electronic filing, the photos are saved with filename TSup1.jpg to TSup2.jpg.

4.2 Photographs of the External and Internal Configurations of the EUT

For electronic filing, the photos are saved with filename ExPho1.jpg to ExPho2.jpg and InPho1.jpg to InPho2.jpg.



CMA Testing and Certification Laboratories

廠商會檢定中心

TEST REPORT

Report No. : AR0017683(3)

Date : 16 Apr 2013

5 Supplementary document

The following document were submitted by applicant, and for electronic filing, the document are saved with the following filenames:

Document	Filename
ID Label/Location	LabelSmp.jpg
Block Diagram	BlkDia.pdf
Schematic Diagram	Schem.pdf
Users Manual	UserMan.pdf
Operational Description	OpDes.pdf

5.1 Bandwidth

The plot on saved in TestRpt2.pdf shows the fundamental emission is confined in the specified band. It also shows that the band edge met the 15.209 requirement at 26.9599 and 27.2801 MHz.

Emission at 26.96MHz = 21.95 dBuV/m

Emission at 27.28MHz = 22.24 dBuV/m

5.2 Duty cycle

The duty cycle is simply the on-time divided by the period:

The duration of one cycle = 51.014ms

Duration of pulse 1 = 1.5942ms

Duration of pulse 2 = 521.7us

Number of pulse 1 = 4

Number of pulse 2 = 40

Effective period of the cycle = (4 x 1.5942ms) + (40 x 521.7us)
= 27.245ms

Duty Cycle = 27.245 / 51.014
= 0.534

Therefore, the average factor is found by $20 \log_{10} 0.534 = - 5.4\text{dB}$



CMA Testing and Certification Laboratories

廠商會檢定中心

TEST REPORT

Report No. : AR0017683(3)

Date : 16 Apr 2013

5.3 Transmission time

Not Applicable



CMA Testing and Certification Laboratories

廠商會檢定中心

TEST REPORT

Report No. : AR0017683(3)

Date : 16 Apr 2013

6 Appendices

A1.	Photos of the set-up of Radiated Emissions	1	page
A2.	Photos of External Configurations	1	page
A3.	Photos of Internal Configurations	1	page
A4.	ID Label/Location	1	page
A5.	Bandwidth Plot	1	page
A6.	Average Factor	2	pages
A7.	Block Diagram	1	page
A8.	Schematics Diagram	1	page
A9.	User Manual	4	pages
A10.	Operation Description	1	page



CMA Testing and Certification Laboratories

廠商會檢定中心

TEST REPORT

Report No. : AR0017683(3)

Date : 16 Apr 2013

A1. Photos of the set-up of Radiated Emissions

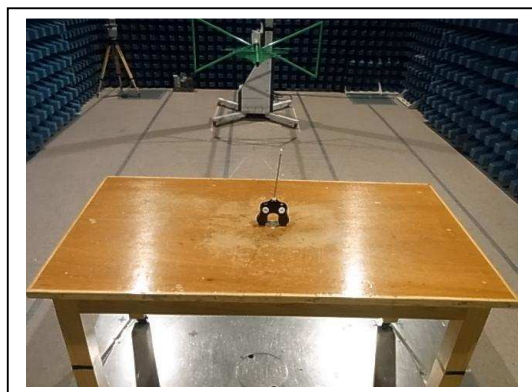

(Front view)

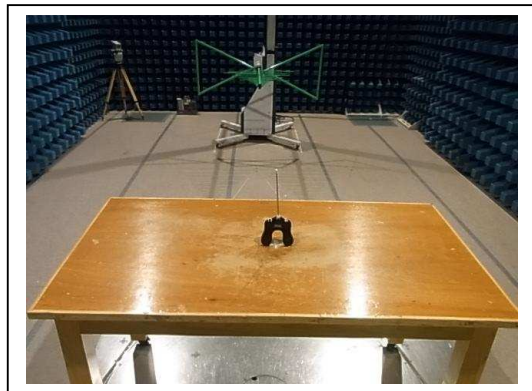

(Back view)

Tested by: 
Mr. LEUNG Shu-kan, Ken

Reviewed by: 
Mr. WONG Lap-pong, Andrew

FCC ID: QEA-E097-27T

Page 13 of 26



CMA Testing and Certification Laboratories

廠商會檢定中心

TEST REPORT

Report No. : AR0017683(3)

Date : 16 Apr 2013

A2. Photos of External Configurations



External Configuration 1



External Configuration 2

Tested by:

Mr. LEUNG Shu-kan, Ken

Reviewed by:

Mr. WONG Lap-pong, Andrew

FCC ID: QEA-E097-27T

Page 14 of 26



CMA Testing and Certification Laboratories

廠商會檢定中心

TEST REPORT

Report No. : AR0017683(3)

Date : 16 Apr 2013

A3. Photos of Internal Configurations

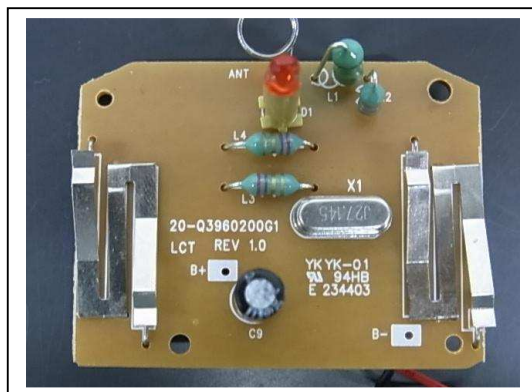

Internal Configuration 1

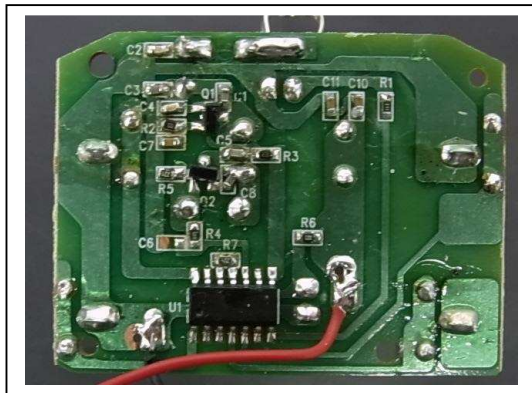

Internal Configuration 2

Tested by: 
Mr. LEUNG Shu-kan, Ken

Reviewed by: 
Mr. WONG Lap-pong, Andrew

FCC ID: QEA-E097-27T

Page 15 of 26



CMA Testing and Certification Laboratories

廠商會檢定中心

TEST REPORT

Report No. : AR0017683(3)

Date : 16 Apr 2013

A4. ID Label / Location



ID Label 1



ID Label 2

Tested by:

Mr. LEUNG Shu-kan, Ken

Reviewed by:

Mr. WONG Lap-pong, Andrew

FCC ID: QEA-E097-27T

Page 16 of 26



CMA Testing and Certification Laboratories

廠商會檢定中心

TEST REPORT

Report No. : AR0017683(3)

Date : 16 Apr 2013

A5. Bandwidth Plot

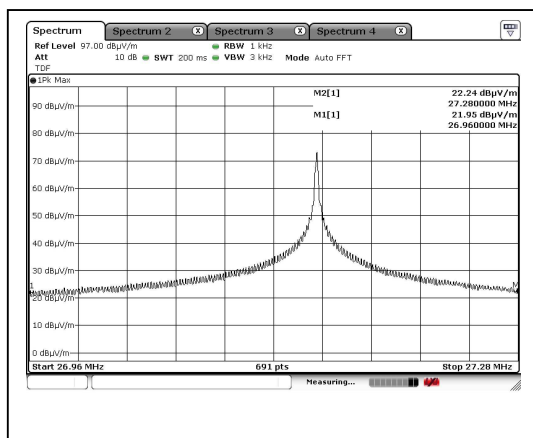

Bandwidth 1

Tested by:

Mr. LEUNG Shu-kan, Ken

Reviewed by:

Mr. WONG Lap-pong, Andrew



CMA Testing and Certification Laboratories

廠商會檢定中心

TEST REPORT

Report No. : AR0017683(3)

Date : 16 Apr 2013

A6. Duty Cycle

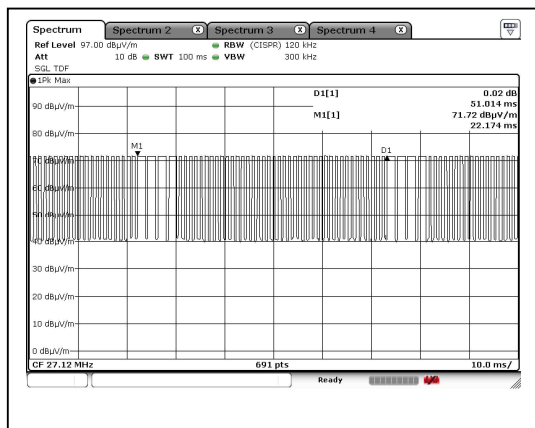

Duty Cycle 1

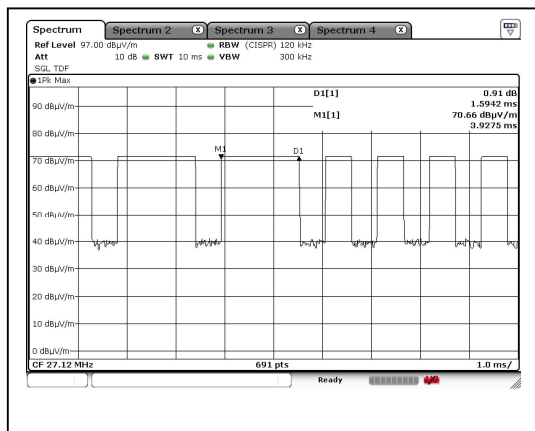

Duty Cycle 2

Tested by: *Ken*
Mr. LEUNG Shu-kan, Ken

Reviewed by: *P.R.*
Mr. WONG Lap-pong, Andrew



CMA Testing and Certification Laboratories

廠商會檢定中心

TEST REPORT

Report No. : AR0017683(3)

Date : 16 Apr 2013

A6. Duty Cycle

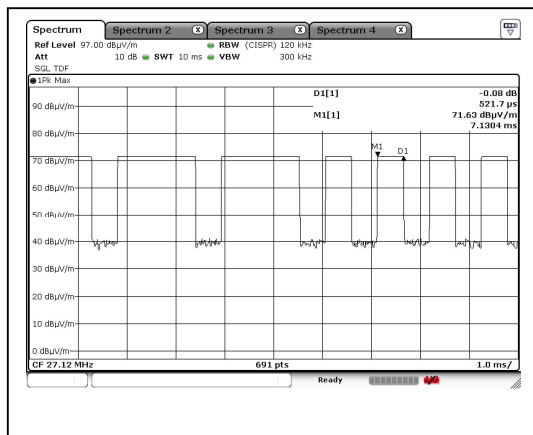

Duty Cycle 3

Tested by:

Mr. LEUNG Shu-kan, Ken

Reviewed by:

Mr. WONG Lap-pong, Andrew

FCC ID: QEA-E097-27T

Page 19 of 26



CMA Testing and Certification Laboratories

廠商會檢定中心

TEST REPORT

Report No. : AR0017683(3)

Date : 16 Apr 2013

A7. Block Diagram

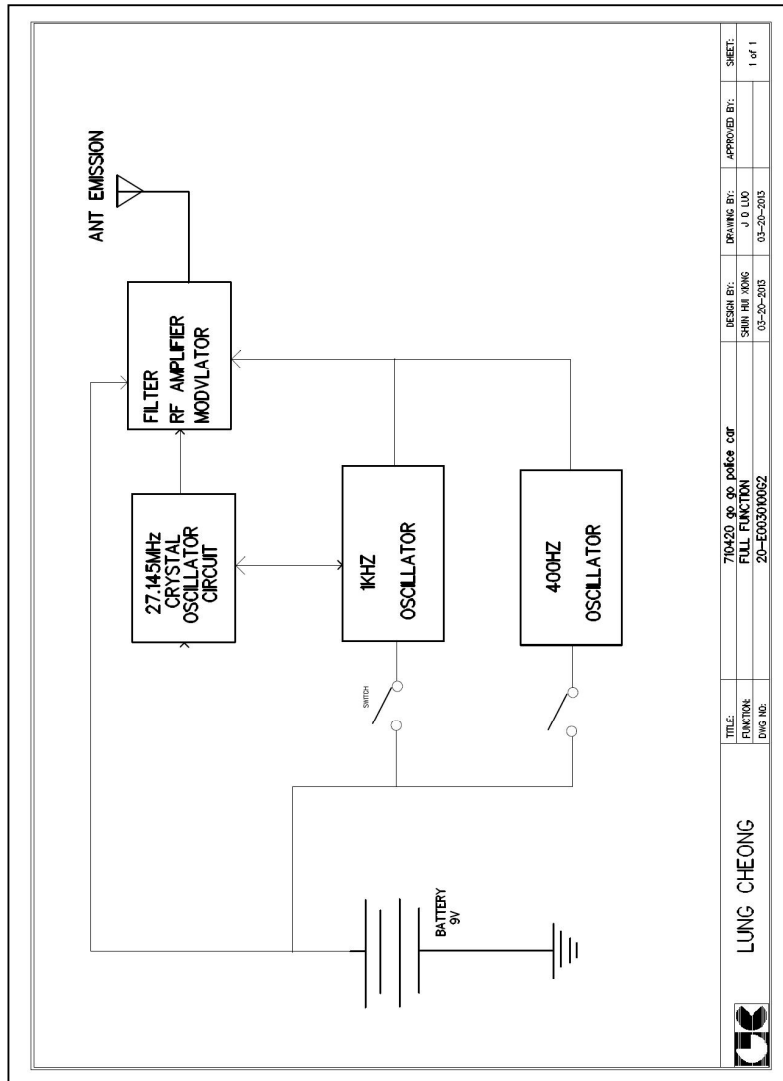

Tested by: *Ken*
Mr. LEUNG Shu-kan, Ken

Reviewed by: *P.R.*
Mr. WONG Lap-pong, Andrew



CMA Testing and Certification Laboratories

廠商會檢定中心

TEST REPORT

Report No. : AR0017683(3)

Date : 16 Apr 2013

A8. Schematics Diagram

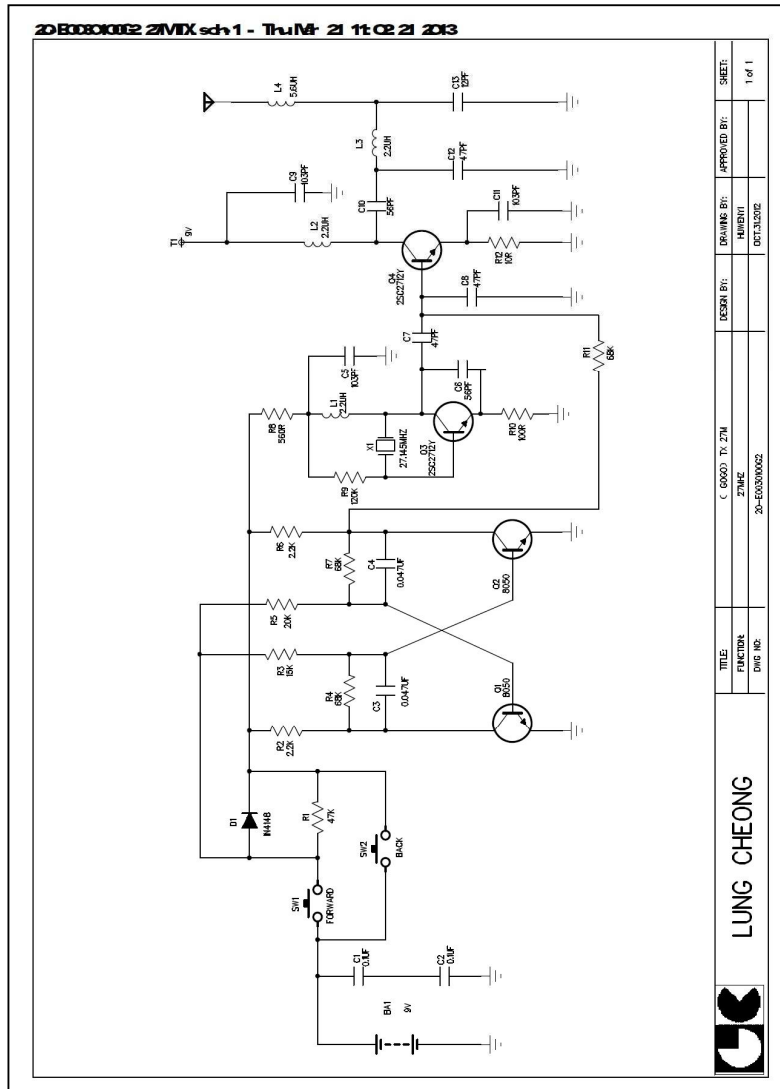

Tested by: *Ken*
Mr. LEUNG Shu-kan, Ken

Reviewed by: *Andrew*
Mr. WONG Lap-pong, Andrew



CMA Testing and Certification Laboratories

廠商會檢定中心

TEST REPORT

Report No. : AR0017683(3)

Date : 16 Apr 2013

A9. User Manual



User Manual

INTRODUCTION

Morphibians are unique 4x4 amphibious vehicles with full function radio control. This rugged vehicle can traverse the terrain and drive to water instantly. With the full function RC handset you can control all the action from a distance away!

OPERATION TIPS AND HELPFUL HINTS

- Avoid playing in salt water; this may cause rust to form.
- If your vehicle starts to lose power, it may experience loss of functions and performance. If this happens, simply replace the batteries in vehicle and handset.
- Your Morphibian RC operates via radio waves. It is possible that the vehicle may not perform properly due to interference from devices such as cordless phones, hair dryer, radio, walkie talkie or other radio control toys.
- Morphibian vehicles are designed to take on water. To improve on-water performance, after playing with the RC in water, it is advised to drain the water out of the hull. Drainage holes are located at the bottom of the vehicle.
- After playing in water, wipe your Morphibian dry with a clean, dry towel.
- Do not operate during electrical storms.
- Only play in fresh water with little to no current.
- Do not operate in water during heavy winds.
- Avoid wetting the antenna on the vehicle.
- Avoid reducing the length of the antenna on the vehicle.

FCC NOTICE

1. This equipment has been tested and found to comply with the limits for a Class B digital device, pursuant to Part 15 of the FCC rules. These limits are designed to provide reasonable protection against harmful interference in a residential installation.

This equipment generates, uses and can radiate radio frequency energy and, if not installed and used in the accordance with the instructions, may cause harmful interference to radio communications; however, there is no guarantee that interference will not occur in a particular installation.

If this equipment does cause harmful interference to radio or television reception, which can be determined by turning the equipment on and off, the user is encouraged to try to correct the interference by one or more of the following measures:

- Reorient or relocate the receiving antenna.
- Increase the separation between the equipment and receiver.
- Connect the equipment to a power outlet on a circuit different from that to which the receiver is connected.
- Consult the dealer or an experienced radio/television technician for help.

2. Caution: Changes or modifications not expressly approved by the party responsible for compliance could void the user's authority to operate the equipment.

This device complies with part 15 of the FCC Rules. Operation is subject to the following two conditions:

(1) This device may not cause harmful interference, and (2) this device must accept any interference received, including interference that may cause undesired operation.

Frequency Channel: 27.145 MHz Field Strength: 66.44 dBµV/m @ 3m
 Frequency Channel: 49.260 MHz Field Strength: 72.76 dBµV/m @ 3m

This device complies with RSS-310 of Industry Canada. Operation is subject to the condition that this device does not cause harmful interference.

Operation is subject to the following two conditions: (1) this device may not cause interference, and (2) this device must accept any interference, including interference that may cause undesired operation of the device.

NOTE: Changes or modifications not expressly approved by the manufacturer could void user's authority to operate this device.

The radio circuitry in your vehicle and remote controller is sensitive. Radio interference can affect the control of your vehicle. You may have to choose another location to operate your vehicle.

Toll Free Hot Line: 800-816-1135

www.kidgalaxy.com
 Kid Galaxy, Inc. 150 Dow St., Ste. 425B, Manchester, NH 03101 U.S.A.
 Product Manufactured in China



Copyright ©2004 Kid Galaxy, Inc.
 Morphibian Series

WARNING:
 CHOKING HAZARD
 Not for children under 3 years.

Tested by: 
Mr. LEUNG Shu-kan, Ken

Reviewed by: 
Mr. WONG Lap-pong, Andrew



CMA Testing and Certification Laboratories

廠商會檢定中心 **TEST REPORT**

Report No. : AR0017683(3)

Date : 16 Apr 2013

A9. User Manual

SAFETY PRECAUTIONS

- Please read instructions thoroughly before operating this vehicle.
- Adult supervision is recommended. Keep out of reach of children 3 and younger.
- Children should be aware of dangers associated with playing near water before operating near or around water.
- Always select a safe place to play. Never drive your vehicle on populated streets.
- Keep fingers, hair and loose clothing away from tires, wheel hubs and motors while vehicle is switched on.
- Do not use chemicals on the **Morphian** or transmitter, they can deform or damage the product.
- Do not mix different brands of batteries.
- Do not mix new and used batteries.
- Do not mix alkaline, standard (Carbon-Zinc) or rechargeable (Ni-Cd) batteries.
- Batteries must be inserted with the correct polarities as shown in the battery compartments.
- Exhausted batteries should be removed from the vehicle and disposed of properly. Do not dispose in fire as batteries may leak or explode.
- Batteries should be replaced by an adult.
- Please keep these instructions for future reference.

KID GALAXY INC. LIMITED WARRANTY

Kid Galaxy's products are covered under a limited 60 day warranty against manufacture defects. If a product is deemed defective and falls within the 60 day period, Kid Galaxy will repair or replace it at no charge. We require a copy of the original sales receipt to validate the purchase. Product must be purchased within US or Canada to be eligible. Please email us at: customerservice@kidgalaxy.com or call us

INSTALLATION OF BATTERIES

BATTERY REQUIREMENTS:
 - Handset: 2 x AAAA SIZE alkaline (1.5v) batteries.
 - Vehicle: 3 x AA SIZE alkaline (1.5v) batteries.

Vehicle:

1. Unscrew the roof with Phillips screwdriver to expose the battery box.
2. Unscrew the battery door and insert 3-AAA batteries with polarities shown inside battery compartment.
3. Replace the battery cover and screw shut.
4. Replace roof and screw shut.
5. Turn switch ON to start your **Morphian**.

Handset:

1. Unscrew the battery cover on underside of controller with Phillips screwdriver.
2. Insert 2-AAAA batteries with polarities shown in battery compartment.
3. Replace the battery cover and screw shut.

INSTALLATION OF ANTENNA-TUBE

Insert tube into antenna-tube holder.



HOW TO PLAY!

FORWARD:
press both keys forward

REVERSE:
pull both keys back

TURN LEFT:
push right key only to turn left

TURN RIGHT:
push left key only to turn right

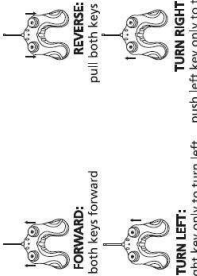

Tested by: 
 Mr. LEUNG Shu-kan, Ken

Reviewed by: 
 Mr. WONG Lap-pong, Andrew

FCC ID: QEA-E097-27T

Page 23 of 26



CMA Testing and Certification Laboratories

廠商會檢定中心

TEST REPORT

Report No. : AR0017683(3)

Date : 16 Apr 2013

A9. User Manual



Manuel d'Utilisation

INTRODUCTION

Les Morphibians sont d'unique véhicules amphibies à 4 roues motrices avec contrôle radio complet. Ce véhicule robuste peut averser le terrain et l'eau instantanément. Avec toutes les fonctions de la manette radio, vous pouvez contrôler toute l'action de loin!

TRUCS ET ASTUCES

- Évitez de jeter dans l'eau salée, ceci pourrait causer la corrosion de rouille.
- Si votre véhicule compense à perte de la puissance, il peut démontrer un manque de fonction et une perte de performance. Si cela se produit, changez simplement les piles du véhicule et de la manette.
- Votre Morphibian RIC fonctionne par ondes radio. Il est possible que le véhicule ne fonctionne pas correctement à cause des interférences avec des appareils tels que les téléphones sans fil, séchoir à cheveux, radio, émetteurs-récepteurs portatifs ou autres jouets télécommandés.
- Les véhicules Morphibian sont conçus pour fonctionner sur l'eau. Ils ne sont pas conçus pour fonctionner sur terre. Évitez d'épouser l'eau de la coque après avoir joué avec le produit sur l'eau. Des trous d'évacuation sont situés sous le véhicule.
- Après avoir joué dans l'eau, essayez bien votre Morphibian avec une serviette propre et sèche.
- N'utilisez pas durant des orages électriques.
- N'utilisez qu'en eau douce avec très peu de courant.
- N'utilisez pas dans l'eau lorsqu'il y a des vents violents.
- Évitez de mouiller l'antenne du véhicule.
- Évitez de raccourcir l'antenne du véhicule.

NOTICE FCC

1. Cet équipement a été examiné et s'est avéré conforme avec les limites pour un dispositif numérique de classe B, conformément à la partie 15 des règles de la FCC. Ces limites sont conçues pour assurer une protection raisonnable contre l'interférence dans une installation résidentielle.

Cet équipement produit, utilise et peut émettre de l'énergie de radiofréquence et, si non installé et utilisé selon les instructions, peut causer de l'interférence nocive aux communications. Cependant, ceci ne garantit pas que l'interférence ne se produira pas dans une installation particulière.

Si cet équipement cause de l'interférence nocive à la radio ou la réception des émissions télévisées, qui peut être déterminée en allumant ou éteignant l'équipement, l'utilisateur est encouragé à essayer de corriger l'interférence par une ou plusieurs des précautions suivantes:

- Reorienter ou déplacer l'antenne de réception.
- Augmenter la distance entre l'équipement et le récepteur.
- Brancher l'équipement dans une sortie sur un circuit différent de celui auquel le récepteur est branché.
- Consulter le revendeur ou un technicien expérimenté de radio/TV pour de l'aide.

2. LE MANUFACTURIER N'EST PAS RESPONSABLE POUR TOUTE INTERFERENCE RADIO OU TV CAUSÉE PAR DES MODIFICATIONS NON-AUTORISÉES DE CET ÉQUIPEMENT. DE TELLES MODIFICATIONS POURRAIENT ANNULER L'AUTORISATION D'UTILISER L'ÉQUIPEMENT.

Carrier frequency: 27.145MHz, field strength: 66.44 dBµV/m at 3m,
Carrier frequency: 40.980MHz, field strength: 77.75 dBµV/m at 3m.
Cet appareil conforme au cahier des charges CNR-310 (RSS-310) d'Industrie Canada. Son utilisation est soumise à la condition qu'il ne génère pas d'interférences nuisibles.

Le fonctionnement est soumis aux deux conditions suivantes:
(1) Cet appareil ne doit pas provoquer des interférences nocives et
(2) Cet appareil doit accepter toutes les interférences reçues, y compris les interférences qui peuvent provoquer un fonctionnement indésirable.

NOTE - Des changements ou des modifications non expressément approuvés par le fabricant peuvent annuler l'autorisation de l'utilisateur à utiliser ce produit.
La circulation de votre véhicule et manette est délicate. Les interférences radio peuvent affecter le contrôle de votre véhicule. Vous devez peut-être à choisir un autre endroit pour le bon fonctionnement de votre véhicule.

SUPPORT SANS FRAIS : 800-816-1135
www.kidgalaxy.com



Copyright ©2004 Kid Galaxy, Inc.
Morphibian Series

AVERTISSEMENT :
DANGER DE SUFFOCATION - Petites Pièces
Non jouables pour les enfants
de moins de 3 ans.

Tested by: 
Mr. LEUNG Shu-kan, Ken

Reviewed by: 
Mr. WONG Lap-pong, Andrew



CMA Testing and Certification Laboratories

廠商會檢定中心

TEST REPORT

Report No. : AR0017683(3)

Date : 16 Apr 2013

A9. User Manual

MESURES DE PRECAUTION

- Veuillez lire les instructions au complet avant d'utiliser ce véhicule.
- La supervision d'un adulte est recommandée. Gardez hors de la portée des enfants de 3 ans et moins.
- Les enfants devraient être au courant des dangers de jouer près de l'eau avant l'utilisation près ou autour de l'eau.
- Toujours choisir un endroit sécuritaire pour jouer. Ne conduisez jamais votre véhicule sur des rues passantes.
- Gardez les doigts, cheveux et vêtements loin des pneus, arbres de pneu et du moteur lorsque le véhicule est en position « on »
- N'utilisez aucun produit chimique sur le Morphibian ou le transmetteur, cela pourrait déformer ou endommager le produit.
- Ne pas mélanger différentes marques de piles.
- Ne mélangez pas des vieilles et des nouvelles piles.
- Ne mélangez pas des piles alcalines, standard (Carbone-Zinc) ou rechargeables (Ni-Cad).
- Les piles doivent être insérées avec les polarités dans le bon sens, tel qu'indiqué dans le compartiment à piles.
- Les piles faibles doivent être enlevées du véhicule et disposées correctement. Ne disposez pas les piles dans le feu parce qu'elles pourraient avoir une fuite ou exploser.
- Les piles devraient être remplacées par un adulte.
- Veuillez conserver ces instructions pour référence future.

INSTALLATION DES PILES

PILES REQUISES :

- Manette : 2 piles AAA alcalines (1.5v)
- Véhicule : 3 piles AA alcalines (1.5v)

Véhicule :

1. Dévissez le toit avec un tournevis Philips pour pénétrer le compartiment à piles.
2. Retirez les piles existantes et placez les nouvelles piles avec les polarités montrées dans le compartiment à piles.
3. Remplacez le couvercle des piles et revissez le toit.
4. Remplacez le toit et revissez.
5. Mettez l'interrupteur à « ON » pour allumer votre Morphibian.

Manette :

1. Dévissez le panneau à piles sous la manette avec un tournevis Philips.
2. Installez 2 piles AAA avec les polarités comme indiqué à l'intérieur du compartiment à piles.
3. Remplacez le couvercle des piles et revissez le toit.

INSTALLATION DU TUBE-ANTENNE

Insérez le tube dans le support tube-antenne.

COMMENT JOUER !

AVANCER :

appuyez sur les deux touches vers l'avant

RECULER :

tirez sur les deux touches

TOURNER À GAUCHE :

appuyez seulement sur la touche de droite pour tourner à gauche

TOURNER À DROITE :

appuyez seulement sur la touche de gauche pour tourner à droite

A10. Operation Description

Tested by:

Mr. LEUNG Shu-kan, Ken

Reviewed by:

Mr. WONG Lap-pong, Andrew

FCC ID: QEA-E097-27T

Page 25 of 26



CMA Testing and Certification Laboratories

廠商會檢定中心

TEST REPORT

Report No. : AR0017683(3)

Date : 16 Apr 2013

Kid Galaxy RC-TOY GO GO CAR TX OPERATION PRINCIPLE

The **Kid Galaxy** RC toy go go car TX operates basing on the controlling signals encode by 2 channel circuit:After modulation, the hight frequency oscillatory signals were emitted to control the progress,retreat functions for the RX. The modulation type is AM.

Circuits' composition:

Power circuit;encoding circuit;high frequency oscillatory circuit;modulator and amplifier circuit.

1. Power circuit:

S1,S2

2. encoding circuit:

R2, R3, R4, R5, R6, R7, D1, C3, C4

3. 27.145MHz high frequency oscillatory circuit decoder circuit:

R8, R9, Q3, C7 · C6, X1, C5, L1, R10

4. modulator and amplifier circuit:

R11, C8, C11, Q4, R12, L2, C10, C12, L3, C13, L4 · ANT

**** End of Report ****

Tested by:

Mr. LEUNG Shu-kan, Ken

Reviewed by:

Mr. WONG Lap-pong, Andrew

Page 26 of 26

FCC ID: QEA-E097-27T